



# **ATMworks 950L Adapter Installation Guide**

Part No. EK-DGLSL-IN, Rev A02





---

Digital Equipment Corporation makes no representations that the use of its products in the manner described in this document will not infringe on existing or future patent rights, nor do the descriptions contained in this document imply the granting of licenses to make, use, or sell equipment or software in accordance with the description.

Restricted Rights: Use, duplication, or disclosure by the U.S. Government is subject to restrictions as set forth in subparagraph (c)(1)(ii) of DRARS252.227-7013, or in FAR 52.227.19 or in FAR 52.227-Alt.III, as applicable.

© Digital Equipment Corporation 1996. All rights reserved.

The following are trademarks of Digital Equipment Corporation: DEC, Digital, ATMworks, and DIGITAL logo.

## Federal Communications Commission (FCC) Statements

### Category 5 UTP Adapters:

This equipment has been tested and found to comply with the limits for a Class A digital device, pursuant to Part 15 of the FCC Rules. These limits are designed to provide reasonable protection against harmful interference when the equipment is operated in a commercial environment. This equipment generates, uses and can radiate radio frequency energy and, if not installed and used in accordance with the instruction manual, may cause harmful interference to radio communications. Operation of this equipment in a residential area is likely to cause harmful interference in which case the user will be required to correct the interference at the user's own expense.

**Note:** *Any changes or modifications to the equipment not expressly approved by Digital Equipment Corporation could void the user's authority to operate this equipment.*

### Multi-mode Fiber Adapters:

This equipment has been tested and found to comply with the limits for a Class B digital device, pursuant to Part 15 of the FCC Rules. These limits are designed to provide reasonable protection against harmful interference in a residential installation. This equipment generates, uses and can radiate radio frequency energy and, if not installed and used in accordance with the instruction, may cause harmful interference to radio communications. However, there is no guarantee that interference will not occur in a particular installation. If this equipment does cause harmful interference to radio or television reception, which can be determined by turning the equipment off and on, the user is encouraged to try to correct the interference by one or more of the following measures:

- Reorient or relocate the receiving antenna.
- Increase the separation between the equipment and the receiver.
- Connect the equipment into an outlet on a circuit different from that to which the receiver is connected.
- Consult the dealer or an experienced radio/TV technician for help.

## CE European Community (EC) Declaration of Conformity

Digital Equipment Corporation adapters conform to the protection requirements of Council Directive 89/336/EEC on the approximation of the laws of the Member States relating to electromagnetic compatibility. Conformity is declared by the application of the following EMC Standards:

**EN 55022**, First Edition, Limits and Methods of Measurement of Radio Interference Characteristics of Information Technology Equipment, April 1994;

**EN 50082-1**, Electromagnetic Compatibility — Generic immunity standard — Part 1: Residential, commercial, and light industry, January 1992.

---

## Introduction

- About This Guide, 11
  - Terminology, 11
  - Related Documents, 12
- Hardware Overview, 14
  - ATMworks 950L Features, 15
    - ATMworks 950L Multimode Fiber (MMF), 15
    - ATMworks 950L Category 5 (CAT5), 16
    - ATMworks 950L LED, 16
  - Unpacking and Inspection, 16
- Software Overview, 18

---

## ATMworks 950L Installation

- Installation Preparation, 19
  - System Shutdown, 19
- ATMworks 950L Installation Procedure, 21
- System Power-Up, 24
- Attaching Cables to the ATMworks 950L, 25
- ATMworks 950L Specifications, 27

---

## Software Installation in Solaris

- Solaris System Requirements, 29
- Installation from 8mm Tape, 30
  - Transferring the Package from the Media, 30
- Software Installation Procedure, 32
- Moving the ATMworks 950L to a New Slot, 36

Removing the ATMworks 950L Software, 37

---

## **Software Installation in SunOS**

SunOS System Requirements, 39  
Installation from 8mm Tape, 40  
Software Installation Procedure, 42  
Removing the ATMworks 950L Software, 47

---

## **Hardware Diagnostics**

ATMworks 950LTest Procedure, 49

---

## **System Configuration**

Configuration Overview, 55  
ATM Concepts, 57  
    How IP Addresses are Defined, 57  
    About Subnetting, 58  
    Data Transmission Rates, 59  
        Traffic Shaping at Work, 59  
        The Traffic Shaping Scheme, 60  
        Requested and Acceptable Transmit Rates, 61  
General Configuration Procedures, 62  
    Global Configuration, 62  
    ILMI Configuration, 63  
    Signalling Configuration, 67  
    User-Network Interface (UNI) 3.0/3.1 Configuration, 70  
    DCM Access Configuration, 71  
LAN Emulation Configuration, 73  
    The LAN Emulation Client (LEC), 73  
    Basic LANE Configuration, 74  
    Custom LAN Emulation Configuration, 79  
        Specifying Custom LEC Parameters, 80

- Specifying a Custom LECS Address, 82
- Removing an LEC, 85
- Removing a Custom LECS Address, 86
- Removing LES Addresses, 87
- Classical IP (CIP) Configuration, 89
  - Assigning IP Addresses and Subnet Masks, 90
  - ATM ARP Server Configuration, 95
  - PVC Configuration, 99
    - Choosing VPI/VCI Numbers, 100
    - PVC Configuration Procedure, 101

---

## **Troubleshooting**

- Commonly Asked Questions, 107

---

## **Hacker's Guide to deconfig**

- Overview, 111
  - Support Files, 111
  - LAN Emulation (LANE) Files, 114
  - Classical IP (CIP) Files, 115

---

## **Configuring an ATM-only Network**

- Overview, 117
  - Running LANE vs. CIP, 117
  - Disabling the Ethernet Interface, 118
  - Differences between Solaris and SunOS, 118
  - NIS Support, 118
  - NFS Support, 119
  - SunOS Peculiarities, 119



## **Figures**

- Figure 1-1**      Multimode Fiber ATMworks 950L, 14
- Figure 2-1**      Dust Protecting Cap, 25
- Figure 2-2**      RJ45 Pinout for Category 5 ATMworks 950L, 26
- Figure 5-1**      decdiag Command Line “help” Listing, 51
- Figure 6-1**      Relationship of IP Address to Subnet Mask, 58
- Figure 6-2**      Defining a Subnet using Subnet Mask, 59
- Figure 6-3**      Signalling Configuration Checklist, 67
- Figure 6-4**      LAN Emulation Configuration Checklist, 75
- Figure 6-5**      Classical IP Configuration Checklist, 89
- Figure 6-6**      SVC Address Resolution from ARP Server, 95
- Figure 6-7**      Configuring Permanent Virtual Connections, 101
- Figure A-1**      Example of atm\_hosts file before editing, 112
- Figure A-2**      Example of atm\_hosts file using “+1+” notation, 113
- Figure B-1**      ATM-Only System Configuration, 117





## ***Tables***

- Table 2-1**      ATMworks 950L MMF Technical Specifications, 27
- Table 2-2**      ATMworks 950L CAT5 Technical Specifications, 28
- Table 6-1**      ATM Configuration: ATM Forum vs. IETF implementation, 55



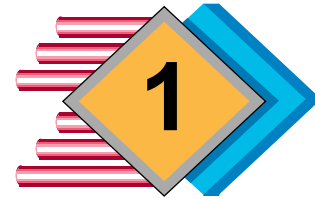

## *Introduction*

---

### **About This Guide**

This manual provides instructions on installing the hardware, software drivers, diagnostics, and management software for Digital Equipment Corporation's ATMworks 950L on UNIX platforms. This manual covers **Aruba 3.2** software installation on Solaris 2.3, 2.4, and 2.5 and SunOS 4.1.3\_U3/4.1.4 operating systems.

---

### **Terminology**

The brief list below is intended to provide a quick reference to some of the terms used in this manual.

<b>nodename</b>	As used in this document, refers to the symbolic name for a workstation. Often referred to in other documentation as the "hostname" of the workstation.
<b>hostname</b>	Used to describe the IP address of the ATMworks 950L interface(s) installed in a workstation.
<b>LANE</b>	LAN Emulation
<b>LEC</b>	LAN Emulation Client
<b>LECS</b>	LAN Emulation Configuration Server
<b>LES</b>	LAN Emulation Server
<b>PVC</b>	Permanent Virtual Connection
<b>SVC</b>	Switched Virtual Connection
<b>VCC</b>	Virtual Channel Connection
<b>VCI</b>	Virtual Channel Identifier
<b>VPI</b>	Virtual Path Identifier

## Related Documents

---

For more information on ATM and related subjects, refer to the following documents:

---

Title	Reference
<i>ATM Forum User-Network Interface Specification, Version 3.0</i>	ISBN 0-13-225863-3
Solaris 2.3 System Configuration and Installation Guide	Chapter 13 - Adding and Removing Packages
Solaris 2.3 System Administrator AnswerBook	Topic: Adding Packages on a Server or Standalone System
<i>TCP/IP Network Administration</i> ; O'Reilly & Associates, Inc.; March 1993	ISBN 0-937175-82-X
<i>Classical IP and ARP over ATM</i> ; M. Laubach; January 1994	RFC 1577
<i>Multiprotocol Encapsulation over ATM Adaptation Layer 5</i> ; J. Heinanen; July 1993	RFC 1483
<i>ATM Signalling Support for IP over ATM</i>	RFC 1755
<i>LAN Emulation Over ATM Specification, v1.0</i> ; ATM Forum	

---

The following manual pages contain material applicable to the **Aruba 3.2** software:

---

<b>Name</b>	<b>Subject</b>
<i>atmhost</i>	ATM Host Name Database
<i>dcm</i>	Digital Configuration Manager
<i>decaccd</i>	Digital Equipment Corporation ATM Call Control Daemon
<i>decatm</i>	Digital Equipment Corporation ATM Driver
<i>decatminit</i>	Digital Equipment Corporation ATM Driver Initializer
<i>deccip</i>	Digital Equipment Corporation Classic IP ATM Driver
<i>deccipd</i>	Digital Equipment Corporation ATM Driver Classic IP Daemon
<i>deconfig</i>	Digital Equipment Corporation System Configuration Utility
<i>decdiag</i>	Digital Equipment Corporation Diagnostic Interface to ATMworks 950L
<i>declc</i>	Digital Equipment Corporation LAN Emulation ATM Driver
<i>decnic</i>	Digital Equipment Corporation ATM NIC Driver
<i>decnmd</i>	Digital Equipment Corporation ATM Network Monitoring Daemon

---

---

## Hardware Overview

Digital Equipment Corporation's ATMworks 950Ls is a network interface card that provides ATM network connectivity for your workstation or server.

One of this product's most important functions is to perform the segmentation and reassembly of data for transmission on the ATM network. The ATMworks 950L segments outgoing data into cells and transmits them to an ATM switch for forwarding to their destination. The same ATMworks 950L reassembles received cells into a Protocol Data Unit (PDU) that can be processed by a protocol stack. (See Figure 1-1 below.)

**Figure 1-1** Multimode Fiber ATMworks 950L

The multi-mode fiber (MMF) version of the ATMworks 950L provides a high performance architecture using a custom Application Specific Integrated Circuit (ASIC) chip known as the "Midway" ASIC. This ASIC chip implements the ATM Adaptation Layer 5 (AAL5) protocol to map Protocol Data Units (PDUs) into the information fields of ATM cells and vice versa.

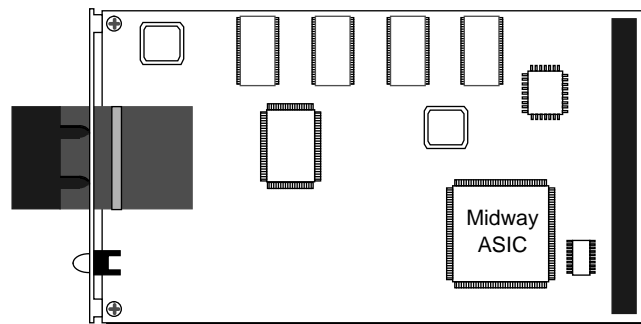

Each node in which an ATMworks 950L is installed will be an endpoint in your ATM network. This network is a switched environment that requires the manual or automatic setup of connections between the ATM endpoints.

In order for one endpoint to communicate with another endpoint, a virtual channel must be defined between them. The creation of virtual channels can be done manually, by defining Permanent Virtual Connections (PVCs), or dynamically, using Switched Virtual Connections (SVCs).

## **ATMworks 950L Features**

---

The ATMworks 950L is a single-slot card that provides a high performance architecture using a custom Application Specific Integrated Circuit (ASIC) chip. This chip implements the ATM Adaptation Layer (AAL) 5 protocol to map PDUs into the information field of ATM cells and vice versa. The ATMworks 950L supports the following features:

- ❖ High performance 155.52 Mbps ATM connectivity
- ❖ AAL5 and raw ATM traffic support
- ❖ Integrated segmentation and reassembly (SAR)
- ❖ High performance convergence sublayer support
- ❖ Extensive variable bit rate (VBR) capabilities
- ❖ SONET/SDH (STS-3c/STM-1) physical layer support
- ❖ Fiber optics and unshielded twisted pair support
- ❖ Operation and Maintenance (OAM) cell support

At the core of the ATMworks 950L hardware is a custom-designed segmentation and reassembly (SAR) ASIC. This ASIC enhances performance by providing a hardware solution for the more complex functions of the ATM protocol. Functions such as the SAR and the common part convergence sublayer (CPCS) of AAL5 are implemented in the ASIC.

Each virtual connection (VC) can be configured as an AAL5 connection or can be configured to transmit and receive raw data traffic. Raw data traffic consists of user-defined cell formats, as opposed to those formatted by the ASIC to conform to the AAL5 layer.

The ASIC also includes a high performance Direct Memory Access (DMA) engine and slave copy capabilities. By designing a DMA engine specific to the ATM environment, Digital Equipment Corporation is providing the network with maximum throughput by avoiding some of the limitations of the I/O architecture (i.e., the host bus).

### **ATMworks 950L Multimode Fiber (MMF)**

The multimode fiber version of the ATMworks 950L provides up to 155 Mbps bandwidth over multimode fiber optical

cable for up to 2 kilometers. The physical interface uses STS-3c/ STM-1 framing at 155.52 Mbps in accordance with Synchronous Optical Network (SONET) and Synchronous Digital Hierarchy (SDH) standards. The ATMworks 950L is equipped with an SC-style optical fiber connector with options for a transition cable to other connectors, such as the ST-style connector.

### **ATMworks 950L Category 5 (CAT5)**

The Category 5 version of the ATMworks 950L provides a physical interface for unshielded twisted pair (UTP) Category 5 cabling as defined by the “ATM 155 Mbps Category 5 UTP v.1.0” specification. The speed of the interface is based upon SONET/SDH at a rate of 155.52 Mbps. The interface is implemented using an RJ45 connector and has a cable distance of up to 100 meters.

### **ATMworks 950L LED**

The port on each ATMworks 950L is equipped with an LED that indicates proper cable connection. This LED, marked with a “#”, is helpful when connecting cabling because it indicates when the cables have been hooked up correctly.

The LED is lit when a valid SONET/SDH format signal is being received; it remains unlit if connected to a non-SONET/SDH format signal.

 **Note:** *The LED will be lit when the ATMworks 950L is in diagnostic loopback mode regardless of what is connected to it.*

## **Unpacking and Inspection**

---

Each ATMworks 950L should arrive in good condition. Before unpacking the card and accessories, check for any obvious damage to the packaging and notify your carrier immediately upon receipt.

The following items are included with each ATMworks 950L:

- ❖ ATMworks 950L Installation Guide (this manual)
- ❖ Media containing driver and management software and accompanying installation documentation



❖ Anti-static wrist strap



### **Inspecting the ATMworks 950L**

- 1** Attach the provided wrist strap as shown in the figure on the wrist strap envelope.
- 2** Remove the ATMworks 950L card from the antistatic bag and check for any damage.
- 3** If there are any visible signs of damage, return the card to the antistatic bag and repackage it in the original shipping container.
- 4** If any item is missing or damaged, immediately contact customer support at the times and numbers listed at the front of this manual.

---

## Software Overview

The computer system in which you are installing the ATMworks 950L and software will be an endpoint in your ATM network. This network is a point-to-point, switched environment that requires the setting up of connections between the ATM endpoints.

In order for one endpoint to communicate with another endpoint, a virtual channel must be defined between them. The creation of virtual channels can be done manually, by defining Permanent Virtual Connections (PVCs), or dynamically, using Switched Virtual Connections (SVCs).

Digital Equipment Corporation's ATMworks 950L ships with a full complement of software that includes the following packages:

- ❖ Driver software that resides on the host system where the ATMworks 950L is installed. The driver provides the connection between the ATMworks 950L and the user's application software.
- ❖ Configuration management software that provides a command-line interface for managing the ATM network configuration.
- ❖ Diagnostic software designed to provide detailed diagnostic information in a command-line format.
- ❖ Software that supports Classical IP (CIP) over ATM per IETF RFC 1577 and 1755.
- ❖ User-Network Interface (UNI) 3.0 and 3.1 signalling software to provide the connection protocols needed for implementing SVCs.
- ❖ Software supporting Interim LAN Management Interface (ILMI) functions per UNI 3.0 and 3.1.
- ❖ LAN Emulation per the *LAN Emulation Over ATM* specification, v1.0, published by the ATM Forum.

Each ATMworks 950L has a unique IEEE 802.2 48-bit media access control (MAC) address that can be used in the 48-bit ESI field of the ATM address.



## ATMworks 950L Installation

---

### Installation Preparation

This chapter describes the procedures for installing a Digital Equipment Corporation ATMworks 950L in the following types of Sun Workstations:

- ❖ SPARCstation IPC/IPX
- ❖ LX or SPARCclassic
- ❖ SPARCstation 1, 1+ and 2
- ❖ SPARCstation 5
- ❖ SPARCstation 10
- ❖ SPARCstation 20
- ❖ Sun compatible systems
- ❖ SPARCserver1000 and 2000
- ❖ UltraSPARC I



**CAUTION:** *To avoid possible damage to components of the ATMworks 950L card or your system, always use the anti-static grounding wrist strap when handling the card.*

---

### System Shutdown

If the Sun system in which the ATMworks 950L is to be installed is currently up, you must shut down and power off the system. This process, as well as the installation procedure, requires *root* access to the system.

Use the UNIX **shutdown** or **init** command to shut down your system. If you are installing the ATMworks 950L in a server, be sure to notify the users of the system of the impending shutdown.

Digital Equipment Corporation recommends that you halt your system using the following procedure.



### To shut down the Sun system

- 1 Save any work and quit all applications. If you are using OpenWindows or Motif, it is advisable to exit the windowing system environment.
- 2 Log in as the *root* user and issue the Solaris **init** or the SunOS **shutdown** command, as shown below:

```
su
Password: (input root password)
# cd /
# /usr/sbin/init -i0 (or shutdown -h for SunOS)

<The system will sync the filesystems and shutdown>
ok
```

- 3 When the system is shut down, power off the system components in the following order:
  - a Turn off all external drives and peripherals, including printers and modems;
  - b Turn off the system unit, but leave it plugged into the outlet in the wall;
  - c Turn off the monitor.

Once the power to the system is off, the next step is to open the workstation's system unit or the server chassis and install the ATMworks 950L card. The following section contains the procedure for installation of this card in your Sun system.

---

## ATMworks 950L Installation Procedure

This section provides a general procedure for installing the ATMworks 950L in the SBus slot of a Sun Workstation. Before performing this procedure, you should have already prepared your system as described in “System Shutdown” on page 19.

For detailed procedures that describe the installation of new hardware in Sun Workstations and servers, refer to the *Desktop Sparc Hardware Owner’s Guide* produced by Sun Microsystems, Inc.



**WARNING:** Before opening the system unit on any Sun system, make sure that the power switch is in the Standby (⏻) or Off (0) position. The green LED on the front panel should not be lit, and the fan should not be running.



**CAUTION:** Do not disconnect the power cord from the system unit’s power receptacle when installing internal components. The power cord should be left plugged into a grounded outlet to provide a grounding path.

The basic steps for installing the ATMworks 950L card in any type of workstation include:

- 1 Opening the system unit;
- 2 Inserting the card in an SBus slot;
- 3 Reassembling the system unit;
- 4 Powering up the system.

For steps 1, 3, and 4, please refer to the appropriate hardware documentation for your system. The following procedure describes step 2, the installation of the ATMworks 950L card in the open system unit.



**To install the ATMworks 950L card in your workstation or server**

- 1 Detach all cables except for the power cord from the back of the system unit. **Make sure that the power to the system unit is off.**
- 2 Position the system unit on a table with the rear panel facing you.

- 3 Open the system unit of the workstation or server by following the procedures in the system's hardware manual.
- 4 Attach the grounding strap provided with the ATMworks 950L to your wrist.
- 5 Remove the dummy backplate from the desired opening on the back panel of the system unit. Refer to the system's documentation for the detailed procedure for this removal.
- 6 Remove the ATMworks 950L card from the antistatic container and hold the card by the edges.



**CAUTION:** *If the card has a protective cover over the fiber optic connectors, you must remove it before attempting to install or remove the card from the system. The card could break if the cover is left in place during installation or removal.*

- 7 Your system may require that you remove the bracket on the end of the card prior to installing it in the system unit. Refer to the specific system documentation for details on the installation of SBus-slot cards in your system.

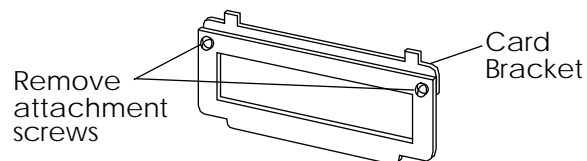

- 8 Insert the card at a downward angle into the opening in the back panel, with the network connectors protruding through the opening.



**Note:** *The ATMworks 950L card will not function in a "slave-only" slot. Refer to the hardware documentation for your system to determine which slots are slave-only.*

- 9 Press the card against the back panel, then gently press the other end of the card into the connector on the main board.



**Note:** *Do **not** force the card into the connector; if it does not snap securely into place, lift it up and realign it before pressing it into the connector again.*

- 10 Reassemble the system unit following the procedures documented in the workstation or server's hardware manual.**

---

## System Power-Up

After you have successfully installed the ATMworks 950L and reassembled the workstation's system unit, reconnect the cables for any peripheral devices. Turn the power on starting with any external drive units. Next, turn on the monitor and then the system unit.

 **Note:** *If the host system does not boot, power off the machine, re-seat the ATMworks 950L card, and reboot again. If the system still does not boot, power it off, remove the card, and reboot the system. If the system comes up without the card installed, the card may be defective, in which case you should contact a Digital Authorized VAR or distributor, or Digital Customer Service.*

The software provided with the ATMworks 950L includes a Diagnostic Management utility, **decdiag**, that allows you to verify the product's functionality. Even if the host system boots, Digital Equipment Corporation still recommends that you use this diagnostic software to verify that the ATMworks 950L's initialization code and hardware are operating properly.



---

## Attaching Cables to the ATMworks 950L

On the multimode fiber version of the ATMworks 950L, take care to protect optical connectors against dust and physical contact with all other objects. **Never** touch the ends of the cables.



All disconnected optical connectors must be covered with dust protecting caps. Do not remove these caps until immediately before mounting the ATMworks 950L in the chassis. (See Figure 2-1 below.)

**Figure 2-1** Dust Protecting Cap

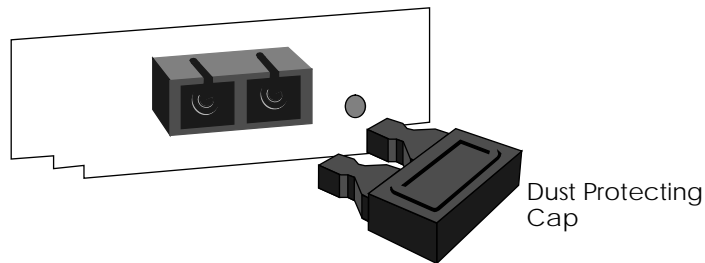
When no optical cable is connected to the ATMworks 950L, the protective cap supplied with the card should be plugged in to protect the optical transceiver.



When connecting optical cables between the ATMworks 950L and the switch, care must be taken so that the transmitter cable of the switch is connected to the receiver connector on the card. Likewise, the switch's receiver cable must be connected to the transmitter connector on the card. The LED on the ATMworks 950L is lit when the card is properly connected.

When using simplex (single) SC connectors, ensure that the transmitter connector from the switch is attached to the connector marked , and the receiver connector from the switch is attached to the connector marked .

When using a duplex SC connector assembly, the connector can only be plugged in the correct way.

 **Note:** Be careful not to twist or bend the optical cable to the point where it may break the glass fiber inside the cable.

Figure 2-2 provides relevant information about the RJ45 jack and connector.

Table 2-1 and Table 2-2 contain the technical specifications for the two ATMworks 950L versions discussed in this manual.

**Figure 2-2** RJ45 Pinout for Category 5 ATMworks 950L

The pinout of the jack on the category 5 version of the ATMworks 950L is different than a standard Ethernet RJ45 pinout. Ethernet loopback connectors will not operate correctly on this card.

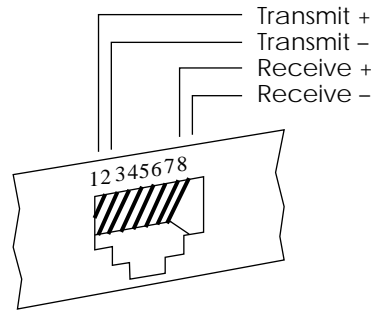

RJ45 Jack on UTP Category 5 ATMworks 950L

RJ45 Connector

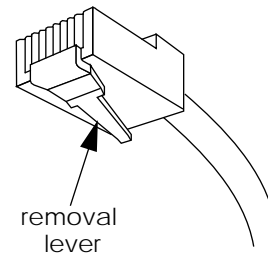

Unshielded twisted pair cables can connect to the category 5 version of the ATMworks 950L with an RJ45 connector. Once the connector is plugged into a board that is installed in a chassis, the removal lever on the connector may be hard to reach. Do not try to pull the connector out of the port without pushing up on the removal lever.

# ATMworks 950L Specifications

**Table 2-1** ATMworks 950L MMF Technical Specifications

	Size	Single slot card
<b>SBus Interface</b>	SBus Frequency	16 to 25 MHz
	Bus master	32-bit bus master capability, up to 64 byte burst size
<b>Optical Interface</b>	Connector	SC style optical interface
	Multi-Mode Fiber	
	Core diameter	62.5 $\mu\text{m}$
	Cladding diameter	125 $\mu\text{m}$
	Min. modal bandwidth	500 MHz*km
	Operating distance	0 to 2 km
	Line code	NRZ
	Line rate	155.52 Mbit per second
	Rate tolerance	$\pm 100$ ppm
<b>Transmitter</b>	Transmitter type	LED
	Wavelength	1260 to 1360 nm
	Max Spectral width	200 nm
	Mean Launched power	-20 to -14 dBm
	Max extinction ratio	10 dB
	Maximum rise time	3 ns
<b>Recvr</b>	Min sensitivity	-30 dBm
	Max overload	-14 dBm
	Path power penalty	1 dB
	Power	Max 1.5 amps @ +5V $\pm$ 5% Max 0.2 amps @ +12V
	Temperature	Operating: 0 to 70° C Non-operating, storage: -40 to 100° C
	Humidity	5% to 95% noncondensing

**Table 2-2** ATMworks 950L CAT5 Technical Specifications

<b>SBus Interface</b>	Size	Single slot card
	SBus Frequency	16 to 25 MHz
	Bus master	32 bit bus master capability, up to 64 byte burst size
<b>Electrical Interface</b>	Connector	RJ45, eight-contact, shielded Category 5 jack
	Unshielded Twisted Pair (UTP)	Category 5 (4 twisted pairs) unused pairs are common mode terminated
	Operating distance	0 m to 100 m
	Line code	NRZ
	Line rate	155.52 Mbit per second
	Rate tolerance	±100 ppm
	<b>Transmitter</b>	Transmitter type
Differential Signal Level		940 mv to 1060 mv
Rise/Fall time		1.5 ns to 3.5 ns
Receiver	Transformer-coupled differential line receiver with adaptive equalization	
Power	Max 1.5 amps @ +5V ± 5% Max 0.2 amps @ +12V	
Temperature	Operating: 0 to 70° C Non-operating, storage: -40 to 100° C	
Humidity	5% to 95% noncondensing	



## Software Installation in Solaris

---

### Solaris System Requirements

This chapter describes the installation of the software for the ATMworks 950L in a Sun UNIX system running the Solaris 2.3, 2.4, or 2.5 operating system.

To successfully install the software in a Solaris operating system, you will need the following system configuration.

- SPARCstation, SPARCserver, UltraSPARC, or compatible with Solaris 2.3, 2.4, or 2.5 (type **uname -rs** to see the OS version you have).
- Solaris **2.3** patch number: 101318; Solaris **2.4** patch numbers: 101945, 101959, 102007, 102044, 102070, 102216, 102218, 102319, 102680, 102711, and 102922. Solaris **2.5**:103093-02, 103226-03, 103247-02,103246-03 or greater for any one of above
- Note whether or not your system is a SuperSPARC or an UltraSPARC.
- The ATMworks 950L *already installed in the system*.
- At least 4.2 Mbytes available in the software installation directory */usr*.
- The pathname */usr/sbin* in your path.

If you received the software on CD, refer to the CD package for initial installation instructions, then skip to “Software Installation Procedure” on page 32. To install from an 8mm tape, refer to the following section, “Installation from 8mm Tape”.



**CAUTION:** *If the installation fails for any reason, you MUST remove the software before attempting to install the package again.*

---

## Installation from 8mm Tape

The ATMworks 950L software provided for Solaris is stored in an Application Package format and is installed using the Solaris Application Package Utility (**pkgadd**). It may help to review the Sun documentation on **pkgadd** before attempting the installation of this software.

The **pkgadd** utility automatically creates the directory structure (*/usr/dec*) in which the software files are loaded. It also checks to see if there is sufficient disk space available to load the software.

---

## Transferring the Package from the Media

You can either install the package directly from the tape or transfer the package to disk prior to installation. By loading the package into an NFS-mounted file system, it can be installed on several remote systems without the necessity of moving the media to each system's local drive.

To execute the **pkgadd** command, you must log in as the *root* user and ensure that */usr/sbin* is in your path. The syntax of this command is as follows:

```
pkgadd -d device [pkg_id] [-s spooldir]
```

where:

*device* is the path name of the tape device (for example, */dev/rmt/0*).

*pkg\_id* optionally identifies a specific package to be loaded. If you omit this argument, all of the packages on the tape will be listed in a menu.

*spooldir* optionally specifies the name of a directory, if you wish to first transfer the package to disk.



**Note:** You may also use the Solaris **swmtool** for Open Look to install the package. Refer to the **swmtool** manual page for complete instructions on the utility.



**CAUTION:** If you are loading a software upgrade, or if you need to reload the ATMworks 950L software, you will need to remove the existing software first. Refer to "Removing the ATMworks 950L Software" on page 37 for details.



## To load the software package from 8mm tape

- 1 Log in as *root* on the installation system.

```
stingray% su root
Password: <input root password>
stingray#
```

- 2 Load the tape into an 8mm tape drive. The tape device name should be **/dev/rmt/num**.
- 3 To install directly from tape, enter the **pkgadd** command, as shown in the following example:

```
stingray# pkgadd -d /dev/rmt/0
```

- 4 To transfer the package to disk and then install it, enter the **pkgadd** command, as shown in the following example (*spooldir* in this example is specified as **/usr/tmp**):

```
stingray# pkgadd -d /dev/rmt/0 -s /usr/tmp
```

After loading the software onto disk, you can install the package on each system in which an ATMworks 950L is installed by issuing the command `pkgadd -d spooldir`.

- 5 To complete the installation, follow the procedure in the next section.

---

## Software Installation Procedure

The following procedure steps you through the installation and configuration of the ATMworks 950L software in Solaris 2.3, 2.4, or 2.5 for a single card. Execute this procedure after you have loaded the software from CD or from 8mm tape.



### Installation of the software on Solaris

1 After the software has been loaded from the media, the following information is displayed:

```
The following packages are available:
1 DEC-Aruba   Digital Aruba ATM Software
              for Solaris (sparc) 3.2.0
```

2 The next prompt asks which packages you want to install. Press *<Enter>* to accept the default selection.

```
Select package(s) you wish to process (or 'all' to
process all packages). (default: all) [?,??,q]: <Enter>

Processing package instance <DEC-Aruba> from </dev/rmt/0>

<Software version and copyright information is displayed>
```



**CAUTION:** Before continuing with the installation, ensure that all mandatory Solaris OS patches have been installed. Refer to “Solaris System Requirements” on page 29.

3 You are then prompted for the installation directory to be used. The directory */usr* is the base directory; press *<Enter>* to accept the default subdirectory, *dec*, or specify a different subdirectory.



Using `</usr>` as the package base directory.

```
+-----+
| Before starting the installation, ensure that your system |
| is updated with all mandatory patches. See the Release  |
| Notes for more information.                             |
+-----+
```

Do you want to continue? default: y [y,n,?,q] **<Enter>**

Under `/usr`, where should DEC-Aruba software be installed?  
default: dec [?,q] **<Enter>**

**4** The next prompts ask whether or not to install the manual pages, and if so, where.

```
Should the manual pages for this package be
installed? default:y [y,n,?,q] y
```

```
Where should manual pages be installed? default:
/usr/man [?,q] <Enter>
```

**5** The next prompt asks if you want to install the ATMworks 950L drivers. If you answer “n” to this prompt, no drivers are loaded, but the **dcm** utility will be loaded.

If you answer “n”, skip to step 7.



**CAUTION:** Do not install the drivers if the ATMworks 950L is not already installed in the workstation.

```
+-----+
| You can load the adapter drivers AND the configuration  |
| management utility OR just the configuration management |
| utility. Answer "y" for both the drivers and the configuration |
| management utility or "n" for the configuration management |
| utility only.                                           |
+-----+
```

Should drivers included in this package be installed?  
default: y [y,n,?,q] **y**

**6** The next prompt allows you to install the SuperSPARC driver if you have a SuperSPARC or UltraSPARC system (the same driver is applicable either way). Performance

may be degraded if only the standard drivers are loaded on the system.

Note that this prompt has no default; you *must* specify whether or not to load the driver.

```
For better performance on SPARCstation 10 and 20
(and clones), SPARCserver 1000, and SPARCcenter
2000 only, you should install the SuperSPARC driver.
```

```
Install the SuperSPARC version of the driver? [y,n,?,q] y
```

**7** The next prompt explains that the installation executes scripts that require super-user permissions. Answer the “continue” question with “**y**”.

```
## Processing package information.
## Processing system information.
## Verifying disk space requirements.
## Checking for conflicts with packages already installed.
## Checking for setuid/setgid programs.
```

```
This package contains scripts which will be executed with super-user
permission during the process of installing this package.
```

```
Do you want to continue with the installation of this package [y,n,?] y
```

Several files are listed as they are loaded.

**8** After the files are successfully loaded, you are reminded to edit your *path* environment variable (usually set in your *.login*, *.profile*, or *.cshrc* file) to include the */usr/dec/bin* directory. For example, from within the C-shell, add the following line:

```
set path = ($path /usr/dec/bin)
```

Also, if the directory in which the manual pages were installed is other than */usr/man*, add that directory to your MANPATH variable.

```
+-----+
| Post-installation Instructions |
+-----+
```

If you have just installed an adapter, you should reboot to single-user mode and run the hardware diagnostics.

After running diagnostics, you must run the "enconfig" program located in /usr/dec/bin to configure the ATM network interfaces and supporting functions such as SVCs and signalling.

Please consult the documentation for diagnostics and configuration procedures.

Be sure to add /usr/dec/bin to your path.

```
+-----+
```

Installation of <DEC-Aruba> was successful.

### 9 The last prompt allows you to exit the **pkgadd** utility by entering "q".

The following packages are available:

```
1 DEC-Aruba Digital Equipment Corporation DEC-Aruba
   ATM Software for Solaris (sparc) 3.2.0
```

Select package(s) you wish to process (or 'all' to process all packages). (default: all) [?,??,q]: **q**

\*\*\* IMPORTANT NOTICE \*\*\*

This machine must now be rebooted in order to ensure sane operation. Execute  
shutdown -y -i6 -g0  
and wait for the "Console Login:" prompt.

 **Note:** Though the **pkgadd** script indicates that you must reboot the system to multi-user mode, do **not** reboot until after performing the diagnostic procedures detailed in Chapter 5, "Hardware Diagnostics."

---

## Moving the ATMworks 950L to a New Slot

If you need to move the ATMworks 950L to a different SBus slot after installing the software, you will need to take special steps. This will only be necessary if the ATMworks 950L's driver software has been installed and the system has been rebooted. Even after the card is removed from a slot, the Sun system will "remember" which slot the card was in originally.

You can tell the system the new slot position by running the script `/usr/dec/bin/en_reset_instance` and then rebooting the system. This script will clean up the `/etc/path_to_inst` file and allow the system to recognize the ATMworks 950L card in a different slot.

---

## Removing the ATMworks 950L Software

After you have installed the ATMworks 950L software, you may find a need to remove it from the system. The **pkgrm** command removes all files in a particular software package.



### To remove software from a Solaris system

- 1 Log on as *root* on the installation system.

```
% su root
Password: <input root password>
#
```

- 2 Issue the **pkgrm** command to remove the desired software packages. You are prompted to select the package(s) to be removed.

```
# pkgrm DEC-Aruba

The following package is currently installed:
 1 DEC-Aruba Digital Equipment Corporation Aruba
   ATM Software for Solaris (sparc) 3.2.0

Do you want to remove this package [y,n,?,q] y

## Removing installed package instance <DEC-Aruba>
```

- 3 Next, you are prompted that the removal program executes scripts that require super-user permissions. Answer the “continue” question with “y”.

```
This package contains scripts which will be executed with super-user
permission during the process of removal of this package.
```

```
Do you want to continue with the removal this package
[y,n,?, q] y
## Verifying package dependencies.
## Processing package information.
```

- 4** The next prompt asks if you want to save the PVC configuration file and ATM hosts file to the directory */usr/tmp*.

```
## Executing preremove script.

The package removal process will remove both the pvc connection
configuration file (/etc/opt/DEC-Aruba/cfg/perch) and the
atm hosts file (/etc/opt/DEC-Aruba/cfg/atm_hosts).

To preserve these files they can be copied to the /usr/tmp
directory.

Do you want to copy them to another location before proceeding?
default: n [y,n,?,q] y

<Information is displayed about the files being copied and the package being
removed>
```

When this process is complete, the ATMworks 950L software will have been removed from the system. However, the drivers will not be removed from the kernel until the system is rebooted.

```
*** IMPORTANT NOTICE ***
This machine must now be rebooted in order to
ensure sane operation. Execute
    shutdown -y -i6 -g0
and wait for the "Console Login:" prompt.

# /usr/sbin/shutdown -y -i6 -g0
<system reboots>
Console Login:
```

- 5** After removing the package, you may want to delete the */etc/system.b4atm* file. This file is created by the package installation as a backup of the */etc/system* file before it is modified. If necessary, this file can be used in restoring the system to its original configuration before the ATMworks 950L software was installed. Therefore, this file is not automatically removed when the package is removed.



## Software Installation in SunOS

---

### SunOS System Requirements

This chapter describes the installation of the software for the Digital Equipment Corporation ATMworks 950L in a Sun UNIX system running the SunOS 4.1.3\_U1 or 4.1.4 operating system.

To successfully install the software in a SunOS operating system, you will need the following system configuration.

- SPARCstation, SPARCserver, or compatible with SunOS 4.1.3\_U1 or 4.1.4 (type **uname -a** to see the OS version you have).
- For **SunOS 4.1.3\_U1**, the following patch numbers: 101587, 101621, 101784, 101833, 101071-07, 101508 (sun4m), 101509 (sun4m).
- Note whether or not your system is a SuperSPARC.
- The ATMworks 950L *already installed in the system*.
- At least 4.2 Mbytes available in the software installation directory */usr*.

If you received the software on CD, refer to the CD package for initial installation instructions, then skip to “Software Installation Procedure” on page 42. To install from an 8mm tape, refer to the following section, “Installation from 8mm Tape”.



**CAUTION:** *If the installation fails for any reason, you MUST remove the software before attempting to install the package again.*

---

## Installation from 8mm Tape

The SunOS software package is delivered on 8mm tape as a *tar* file. Before performing the software installation, you need to load the software onto disk and “un-tar” the software package file.

When specifying which directory to load the software into, there are three possible scenarios to consider:

- ❖ If you specify */usr/tmp*, the software package will remain in that directory after rebooting the system.
- ❖ If you specify */tmp*, the software package will be deleted upon reboot.
- ❖ You may want to load the software into an NFS-mounted file system and install the package multiple times on remotely mounted workstations that have ATMworks 950Ls installed.

The software load directory is requested in step 3 of the following procedure.



### To load the software package from 8mm tape

- 1 Log in as *root* on the installation system.

```
stingray% su root
Password: <input root password>
stingray#
```

- 2 Load the tape into an 8mm tape drive. The tape device name should be */dev/nrstnum*.
- 3 Change to a temporary directory where you can load the software package, such as */usr/tmp*.

```
stingray# cd /usr/tmp
stingray#
```



- 4 Use the **tar** command to load the file *DEC-Aruba.tar* from tape into the current working directory.

```
stingray# tar -xvf /dev/nrst0
stingray#
```

- 5 Change to the *DEC-Aruba/install* directory, which contains the installation script.

```
stingray# cd DEC-Aruba/install
stingray#
```

- 6 Issue the **install\_pkg** command to begin the installation.

```
stingray# install_pkg
```

- 7 To complete the installation, follow the procedure in the next section.

---

## Software Installation Procedure

The following procedure steps you through the installation and configuration of the ATMworks 950L software in SunOS 4.1.3\_U1 or 4.1.4 for a single card. Execute this procedure after you have loaded the software from CD or from 8mm tape.



### Installation of the software on SunOS

- 1 After the software has been loaded from the media, a notice is displayed reminding you that all mandatory SunOS patches must be loaded. Refer to “SunOS System Requirements” on page 39.
- 2 The next prompt asks if you wish to continue. If you answer “n”, the script will exit without installing the software.

```
Do you want to continue? (y/n) [y]: y
```

- 3 You are then prompted for the installation directory to be used. Press *<Enter>* to accept the default directory, */usr/dec*, or specify a different directory by entering the full path name.:

```
Where should DEC-Aruba be installed? (default: /usr/dec): <Enter>  
Checking for pre-existing software.
```

If the script finds an Aruba package already installed, the following prompt is displayed:

```
There appears to be a pre-existing version of this software.  
Do you want to overwrite it? (default: y) [y,n]:
```

If you answer this prompt with “y”, installation continues, and the existing software will be overwritten. If you enter “n”, the script will exit.

- 4 The next prompt asks whether or not to install the manual pages, and if so, where.

```
Should the manual pages for this package be installed?
(default: y) [y,n]: <Enter>

Where should the manual pages be installed? (default: /usr/man): <Enter>
```

- 5 The next prompt asks if you want to install the ATMworks 950L drivers. If you answer “n” to this prompt, no drivers are loaded, but the **dcm** utility will be loaded. If you answer “n”, skip to step 8.



**CAUTION:** Do not install the drivers if the ATMworks 950L is not already installed in the workstation.

```
+-----+
| You can load the adapter drivers AND the DCM
| configuration management utility OR just the DCM
| utility. Answer "y" for both drivers and DCM or "n"
| for DCM only.
+-----+

Should drivers included in this package be installed? (default: y) [y,n]
```

- 6 The next prompt tells you to install the SuperSPARC driver if you have a SuperSPARC system. Performance may be degraded if only the standard drivers are loaded on the system.

Note that this prompt has no default: you *must* specify whether to load the driver.

```
For better performance on SPARCstation 10 and 20 (and clones),
SPARCserver 1000, and SPARCcenter 2000 only, you should install
the SuperSPARC driver.
Do you want to install the SuperSPARC driver? [y,n]: y
```

- 7** The next prompt asks if you are now ready to install the software. If you answer “**n**”, then the script will exit.

```
Ready to install DEC-Aruba 3.2.0 in /usr/dec? (default: y) [y,n]: <Enter>
```

Several messages are displayed indicating the software that is being loaded.

- 8** A message is displayed notifying you that this software is designed with *loadable device drivers*. The “Generic” kernel used on most SunOS systems provides only three loadable device entry points. The script will create four more entry points if you answer the next prompt with “**y**”. You **MUST** answer this prompt with “**y**” the **FIRST** time the software is installed. If you ever re-install the software, this prompt allows you to keep from adding more entry points by entering “**n**” at this prompt.

```
The “Generic” kernel provides three loadable device entry
points and this software requires four. You must create
additional device entry points to support this software.
```

```
Answer “y” to the next prompt to add four more entry points.
This modifies /sys/sun/conf.c and rebuilds the kernel.
NOTE: This MUST be done the first time this software
      is installed.
```

```
Answer “n” if you are reinstalling the software and you do not
want to add more entry points.
```

```
Do you want to add additional entry points now? (default: y) [y,n]: <Enter>
```

- 9** The next prompt asks for the name of the kernel configuration file. Either enter a file name or press <Enter>

to accept the default name. If you do not remember the file name, it is usually listed when you reboot your system.

```
The /sys/sun/conf.c has to be modified to allow additional
loadable device drivers. This process should take a minute or so.
```

```
What is the name of the current kernel configuration file?
(default: GENERIC): <Enter>
```

```
Modifying stream buffer size in param.c...
```

```
Making new kernel...
```

- 10 The next prompt asks for the name and location of your kernel. Press <Enter> to accept the default response, */vmunix*. If it is different, enter the *full path name* of the kernel.

```
What is the name and location of your kernel? (default: /vmunix) : <Enter>
```

- 11 The current kernel will be saved into another file as specified in the next prompt. You can enter the *full path name* of this file, or press <Enter> to accept the default file name, */vmunix.old*.

```
Where do you want to back up the current kernel?
(default: /vmunix.old) : <Enter>
cp /vmunix /vmunix.old
cp vmunix /vmunix
```

That completes the installation. Messages are displayed reminding you to update your path and to run **deccconfig**, as described in Chapter 6.

```
+-----+
| Post-installation Instructions |
+-----+
```

If you have just installed an adapter, you should reboot to single-user mode and run the hardware diagnostics.

After running diagnostics, you must run the "enconfig" program located in /usr/dec/bin to configure the ATM network interfaces and supporting functions such as SVCs and signalling.

Please consult the documentation for diagnostics and configuration procedures.

Be sure to add /usr/dec/bin to your path.

```
+-----+
```

```
Installation of DEC-Aruba complete.
Wed Apr 10 15:19:13 CDT 1996
stingray#
```

- 12 After the files are successfully loaded, you are reminded to edit your *path* environment variable (usually set in your *.login*, *.profile*, or *.cshrc* file) to include the */usr/dec/bin* directory. For example, from within the C-shell, add the following line:

```
set path = ($path /usr/dec/bin)
```

Also, if the directory in which the manual pages were installed is other than */usr/man*, add that directory to your MANPATH variable.

---

## Removing the ATMworks 950L Software

After you have installed the ATMworks 950L software, you may find a need to remove it from the system. The **uninstall\_pkg** script has been provided to let you easily remove all files in the software package. This script is stored in the installation (*install*) directory.



### To remove the software from a SunOS system

- 1 Log on as *root* on the installation system, and type **cd /** to ensure that you are not in the *install* directory.

```
% su root
Password: <input root password>
# cd /
```

- 2 Issue the **uninstall\_pkg** command to remove the software package. You will be prompted to confirm the removal.

```
# /usr/dec/install/uninstall_pkg
Beginning uninstall of DEC-Aruba 3.2.0
Ready to uninstall DEC-Aruba 3.2.0 from /etc/DEC-Aruba? (y/n) [y]: y
```

- 3 The next prompt informs you that the PVC configuration file and the ATM hosts file will be removed unless you save them to another directory.

To save these files, answer this prompt with “y”. This produces a prompt for you to enter the directory in which to store the files, or to press **<Enter>** to accept the default directory (*/usr/tmp*).

```
The uninstall process will remove both the pvc connection
configuration file (/etc/DEC-Aruba/cfg/stingray) and the
atm hosts file (/etc/DEC-Aruba/cfg/atm_hosts).

Do you want to copy them to another location before proceeding? (y/n) [n]: y
Directory name in which to save files? [/usr/tmp]: <Enter>

<Messages are displayed listing the files being removed>
```

When this process is complete, the ATMworks 950L software will have been removed from the system. However, the drivers will not be removed from the kernel until the system is rebooted.

```
Reboot your system now.  
#
```





## Hardware Diagnostics

### ATMworks 950L Test Procedure

The diagnostic software that comes with the ATMworks 950L provides simple diagnostic tests to verify that the product's hardware and drivers are installed and functioning properly.

The **decdiag** diagnostics utility for UNIX provides a command-line interface that can be used to test certain functions of the ATMworks 950L. The main restriction on running this utility is that *no ATM PVCs or SVCs may exist* while the test commands are in use. This is because the **decdiag** utility needs to have control of the ATMworks 950L during the tests.

The following procedure uses three diagnostic commands to perform an initial test on the ATMworks 950L. For a full description of this utility, refer to the manual page for **decdiag** that was included with the product.



To initially test ATMworks 950L functionality:

- 1 Log on as *root* to the workstation that contains the ATMworks 950L.
- 2 To delete all connections prior to running **decdiag**, you have to reboot the system in single-user mode.

```
# halt  
>boot -s  
#
```

- 3 Change to the software installation directory (the default is */usr/dec/bin*).

4 Issue the **decdiag** command. If you have more than one ATMworks 950L installed, **decdiag** will prompt you for the product number; alternately, you can issue the command

**decdiag -c cardnum**

where *cardnum* is **0** for the first ATMworks 950L card installed, **1** for the next, and so forth.

Information about each card installed in the system is displayed, and you are prompted for the number of the controller to test.

```
# decdiag
ATM Diagnostic Information - Host : stingray           Instance : 0
-----
Factory ESI Address      - 00:20:ea:00:05:6e
Hardware Interface Name  - DEC ATMworks950L MMF
Hardware Interface Desc  - 155 Mbps SONET/SDH Multi-Mode Fibre (512 KB)
Hardware Serial Number   - 1390
Hardware Board Id       - 00000042
Hardware Slot Number     - 0
Driver Name              - decnic0
Driver Description       - Digital ATM NIC Driver
Driver Revision Number   - 3.34
Diagnostics Rev Number   - 3.7
Fcode Revision Number    - 1.6

ATM Diagnostic Information - Host : stingray           Instance : 1
-----
Factory ESI Address      - 00:20:ea:00:05:a9
Hardware Interface Name  - DEC ATMworks 950L MMF
Hardware Interface Desc  - 155 Mbps SONET/SDH Multi-Mode Fibre (512 KB)
Hardware Serial Number   - 1449
Hardware Board Id       - 00000042
Hardware Slot Number     - 1
Driver Name              - decnic1
Driver Description       - Digital ATM NIC Driver
Driver Revision Number   - 3.34
Diagnostics Rev Number   - 3.7
Fcode Revision Number    - 1.2

Enter controller no. = 0
```

If another **decdiag** session is being executed on the same card, or if the controller does not exist, the following message will be displayed:

```
# decdiag -c 0
SYSTEM ERROR : Device busy
```

5 If desired, list the **decdiag** command set using the **help** command, as shown in Figure 5-1.

Figure 5-1 **decdiag** Command Line “help” Listing

```
decdiag:stingray:0# help
Digital Equipment Corporation diagnostic interface to ATM adapter Program.

General commands supported :

info          - Displays network interface controller general information.
fcode_fetch  - Fetches FCODE info and save it to a file.
fcode_update - Load FCODE information from file.
dump         - Dump the contents of MIDWAY regs, PHY regs and SAR
              memory to a file.
modify       - Modify the contents of SAR memory.
display      - Display the contents of SAR memory, MIDWAY regs or PHY regs.
line_loop    - Set the phy in high speed line loopback.
loglevel     - Set the diagnostics log level.
loop        - Loop on specified list of diagnostic commands.
quit        - Quit diagnostic program.

Specific diagnostic commands supported:

selftest     - Execute Self Test diagnostic tests.
hbi_slave   - Execute Host Bus Interface Slave diagnostic tests.
hbi_dma     - Execute Host Bus Interface DMA diagnostic tests.
hbi_int     - Execute Host Bus Interface Interrupt diagnostic tests.
eeprom      - Execute EEPROM diagnostic test.
midway     - Execute MIDWAY diagnostic tests.
sar_mem     - Execute basic SAR Memory diagnostic tests.
sar_mem_e  - Execute extended SAR Memory diagnostic tests.
phy        - Execute PHY diagnostic test.
atm_internal - Execute ATM Internal Loopback tests.
atm_external - Execute ATM External Loopback tests, (loopback cable
              required).

For help on a specific command,type "help" followed by command name.
decdiag:stingray:0#
```

**6** When you select a controller number (as described in step 4), the following information is displayed for that controller.

```
ATM Diagnostic Information - Host : stingray           Instance : 0
-----
Factory ESI Address      - 00:20:ea:00:05:6e
Hardware Interface Name  - DEC-ATMworks950L MMF
Hardware Interface Desc  - 155 Mbps SONET/SDH Multi-Mode Fibre (512 KB)
Hardware Serial Number   - 1390
Hardware Board Id        - 00000042
Hardware Slot Number     - 0
Driver Name              - decnic0
Driver Description       - Digital ATM NIC Driver
Driver Revision Number   - 3.34
Diagnostics Rev Number   - 3.7
Fcode Revision Number    - 1.6

decdiag:stingray:0#
```

**7** Execute the ATMworks 950L self-test by issuing the **selftest** command, which automatically executes each of the tests shown under “Specific diagnostic commands supported” in Figure 5-1 except for *hbi\_int*, *sar\_mem\_e*, and *atm\_external*.

```
decdiag:stingray:0# selftest
Wed Apr 10 15:50:44 1996
Self Tests: function 0 all self tests.
PASSED
decdiag:stingray:0#
```

**8** Execute the SAR extended memory test by issuing the **sar\_mem\_e** command.

```
decdiag:stingray:0# sar_mem_e
Wed Apr 10 15:51:09 1996
Extended Segmentation and Reassembly Tests: function 0 all
extended sar memory tests.
PASSED
decdiag:stingray:0#
```

- 9 If you have an external loopback cable, you can use the **atm\_external** command to test the external ATM connection to the ATMworks 950L.
  - a Attach the loopback cable to the ATMworks 950L ports connecting the transmit port to the receive port.
  - b Issue the **atm\_external** command.

```
decdiag:stingray:0# atm_external
Wed Apr 10 15:52:15 1996
ATM External Tests: function 0 all external atm tests.
PASSED
decdiag:stingray:0#
```

- 10 If any of the diagnostic tests fail, contact a Digital Authorized VAR or distributor, or Digital Customer Service.
- 11 If the ATMworks 950L passed all of the above tests, remove the loopback cable (if necessary) and connect the ATMworks 950L ports to your ATM switch.
- 12 Type **q** or **quit** to exit the diagnostic utility, then enter **init 6** (on a Solaris machine) or *<Control-d>* (on a SunOS machine) to reboot.

```
# init 6
<system reboots>
```





## System Configuration

### Configuration Overview

After installing an ATMworks 950L and the accompanying software in a workstation, you have to configure the ATMworks 950L and its host system to communicate on the ATM network.

Your ATM network can be configured to use Classical IP over ATM (CIP) and/or LAN Emulation (LANE) protocols. The basic difference is that CIP is defined by the Internet Engineering Task Force (IETF), while LANE is defined by the ATM Forum. Table 6-1 provides relevant details.

**Table 6-1** ATM Configuration: ATM Forum vs. IETF implementation

ATM Forum - LANE		IETF - CIP	
User-Network Interface Specification 3.1	LANE Specification 1.0	RFC 1577: "Classical IP over ATM"	RFC 1755: "Signalling Support for IP over ATM"
<b>(Digital Product) Features:</b>		<b>Features:</b>	
• Supports protocols that use broadcast services (NFS, NIS, DNS)		↔	• Supports TCP/IP; no broadcast or multicast services
• Uses ILMI, Signalling		↔	• Uses ILMI, Signalling
• SVCs only		↔	• Allows both SVC and PVC configuration
• MTU size (default 1513) is negotiated by LANE Services		↔	• MTU Size (default 9180) is negotiated by individual SVCs
• Uses a LAN Emulation Server		↔	• Uses an ATM ARP Server (which can be the ATMworks 950L's host system)



**Note:** *Signalling, SVCs, and LAN Emulation are only supported on the first ATMworks 950L card installed in a workstation. Subsequent cards must be configured as PVC-only.*

Unlike other ATM products on the market, you can configure LAN Emulation and CIP to run simultaneously. Also, you can use the ATMworks 950L's host system as a router between a network that is running LANE and one that is running CIP.

The next sections provide brief descriptions of various networking and ATM concepts, with the goal being to provide you with information needed to configure your ATM network. Following the conceptual overview are procedures for configuring your system.

### General Procedures

#### **If SVCs will be implemented:**

- Configure ILMI
- Configure Signalling

#### **Optional for any configuration:**

- Configure UNI implementation (default is UNI 3.0)
- Configure DCM Security

### LANE Configuration

- Configure LAN Emulation Client(s) - up to 16
  - Assign distinct IP address for each LEC interface
  - Update */etc/netmasks* with Subnet Masks
  - Optionally configure LEC parameters
- Configure LAN Emulation Configuration Server
- If no LECS, specify LAN Emulation Server address(es)

### Classical IP Configuration

- Assign IP address for CIP interface
- Update */etc/netmasks* with Subnet Mask
- If implementing SVCs, configure ATM ARP Server
- If desired, configure PVCs



---

## ATM Concepts

This section discusses some basic concepts about ATM, and networking in general, that will help in configuring the ATMworks 950L. This section covers:

- ❖ Defining Internet protocol (IP) addresses
- ❖ Creating subnets
- ❖ Data transmission rates and traffic shaping

---

## How IP Addresses are Defined

The IETF's RFC 1020 describes Internet addresses. Also known as IP addresses, these are 32-bit quantities divided into five classes (Class A through F). The classes differ in the number of bits allocated to the "network" portion and the "host" portion of the address.

If you are configuring a new IP network, you must apply to the Internet Authority Board (IAB) for IP addresses. The IAB ensures that each site with Internet access has a unique set of IP addresses that it can assign to its network nodes. You will need to determine what class of addresses your site will require (depending on the number of nodes you expect on the network). You may be assigned a block of addresses or a single Class A or Class B address that you can "subnet" using a subnet mask (described in the next section).

Multiple ATMworks 950L cards at your site can be on the same subnetwork. However, multiple cards installed in a single workstation must be on separate networks (they cannot be on the same subnetwork). Furthermore, each ATMworks 950L may be configured with multiple interfaces (for instance, one for Classical IP and several for LAN Emulation). You need to assign an IP address for each interface on each ATMworks 950L.

IP addresses for end-stations (nodes on the network) are usually entered into the */etc/hosts* file by a *root* user. However, you can specify the IP addresses for the ATMworks 950L interfaces when you run the **deconfig** utility, which will update the */etc/hosts* file.

## About Subnetting

*Subnetting* is a scheme for imposing a simple hierarchy on hosts that are connected through a single physical network. RFC 950, "Internet Standard Subnetting Procedure", provides the official description of subnetting.

For each IP address that is added to the */etc/hosts* file, a *subnet mask* must be defined. A subnet mask identifies the subnet field of a network address by putting all ones in the network and subnet portions of the address.

The network portion of the IP address tells a device whether the destination for a packet is on its same network. Once the correct network for the packet is found, the host portion is used to determine the packet's destination (or source).

Each non-zero bit in the subnet mask indicates that the corresponding bit of the IP address is part of the network designator. Each bit set to zero indicates that the corresponding bit of the IP address designates a network node.

In the example shown in Figure 6-1, the subnet mask is shown in dotted-decimal notation. The first three octets are set to "255" (all ones). When this subnet mask is applied to an IP address, it indicates that the first three octets of the IP address identify the network. Likewise, the final octet of the subnet mask is zero, indicating that the last octet of the IP address identifies nodes on the network.

A different type of example is shown in Figure 6-2.

**Figure 6-1** Relationship of IP Address to Subnet Mask

This subnet mask will provide addresses for up to 256 nodes on the 194.86.24 network. To have more networks and fewer nodes on each network, you can set some of the bits in the last octet of the subnet mask to 1. The bits set to 1 would designate networks.

	Network			Node
<b>Subnet Mask:</b>	255	.255	.255	.0
<b>IP Address:</b>	194	.86	.24	.10

**Figure 6-2** Defining a Subnet using Subnet Mask

Here, only the last four bits of the last octet are used to number the nodes on the network. Using just the last four bits only allows 16 nodes per network. However, the first four bits of the octet allow the designation of 16 more subnetworks than were available before.

	Network				Node
<b>Subnet Mask:</b>	255	.255	.255	.240	
<b>Binary:</b>	1111 1111	1111 1111	1111 1111	1111 0000	

## Data Transmission Rates

The **Aruba 3.2** software allows the setting of data transmission rates for CIP Switched Virtual Connections (SVCs) and Permanent Virtual Connections (PVCs), and for LAN Emulation Clients (LECs), as part of your implementation of LAN Emulation. For each connection, you can specify a maximum peak data transmission rate, referred to as a Peak Cell Rate (PCR).

When you are configuring signalled connections (SVCs) via **deconfig**, you specify the PCR as a percentage of line rate. The PCR is applied to the interface that handles the SVCs – one interface for CIP and up to 16 LEC interfaces in LANE. When configuring PVCs, you must specify an explicit rate for each connection, expressed in megabits per second (Mbps) if you are using **deconfig** (the **dcm** utility allows it to be expressed in cells per second also).

### Traffic Shaping at Work

The most important reason to specify rates is to avoid cell loss caused by switch congestion. Some switches may even enforce a certain rate on the different virtual channel connections; this is usually referred to as “policing” or Usage Parameter Control (UPC).

If UPC is in effect in a switch, and traffic over a VCC exceeds the configured rate, the switch may drop cells from that VCC. This will cause errors at the receiving end-station and degraded performance.



### **TIP**

A PVC's transmit rate should be configured to be less than or equal to the rate of the connection through the switch. The transmit rate should also be less than or equal to the receive rate configured at the receiving endpoint.

If UPC is not in effect, the switch will only drop cells in case of congestion. For example, congestion will occur if two end-stations are sending data to another end-station and the sum of the rates on the two VCCs exceeds the line rate of the link to the receiving end-station.

When you are creating PVCs, you should set the rates of each connection such that all connections can be active simultaneously without congestion. The ATMworks 950L supports this by allowing you to assign a rate to each active PVC.

However, you may wish to take advantage of the fact that connections are idle some of the time. You can “overbook” the bandwidth of the link by assigning rates that add up to greater than the maximum available bandwidth. The benefit is that the active connections get the best available bandwidth. However, you run the risk of congestion and subsequent cell loss. The ATMworks 950L supports overbooking through the use of the “best effort” option on each connection.

## **The Traffic Shaping Scheme**

To provide flexibility in configuring your connections, the software allows you specify the transmission rates in several ways:

- ❖ You can specify a single value to be used as both the receive and transmit rates for a connection. This may be necessary for certain devices that require a particular bandwidth (such as bridges and routers);
- ❖ You can specify “**max**” for one or both rates. This allows the software to choose the maximum remaining available bandwidth when the connection is established;
- ❖ For transmit rates only, you can specify “requested” and “acceptable” rates;
- ❖ You can specify “best effort” to prevent the software from looking at the available bandwidth. That is, you will be given the requested rate, regardless of how much bandwidth is left.

## Requested and Acceptable Transmit Rates

When a connection is created, the device driver calculates and assigns a rate based on cell boundaries. Therefore, your *requested* transmit rate for a connection may or may not be on one of these cell boundaries. By default, the driver will “round down” to the next closest boundary (or to the next cell boundary within the available bandwidth). For example, if you request a transmit rate of 10,000 cps, the driver may assign a rate of 9766 (depending on the ATMworks 950L version).

For most applications, rounding down for the transmit rate will be sufficient, particularly if this makes the transmit rate less than the receive rate on the other end of the connection. However, you can control whether the driver rounds up or down by specifying an *acceptable* rate.

The acceptable rate is used with the requested rate to specify that, if the requested rate is not available, this is the minimum (or maximum) rate that is acceptable. If the acceptable rate is greater than the requested rate, the software will round up when allocating bandwidth for a connection. If the acceptable rate is less than the requested rate, the software will round down.

For example, if you specify a requested rate of 100 Mbps and an acceptable rate of 50 Mbps, the rate selected will be between 50 and 100 Mbps, but it will be as close to 100 Mbps as possible.

You may get an “out of range” error message (on the console or when using the **dcm create** command), if you choose a requested rate and an acceptable rate that both fall within two cell boundaries. It is best to try and specify acceptable rates that are at least 1400 cps above or below the requested rates.

Also, you should not try to set the requested and acceptable rates to the same value (since there is no reason to do so). This will also cause an out of range message, unless you happen to select a rate that is exactly on a cell boundary.

---

## General Configuration Procedures

Whether you will be implementing LANE or CIP (or both), if you will be using signalled connections (SVCs), you must configure the Interim LAN Management Interface (ILMI) and signalling.

Also, you need to find out which User-Network Interface (UNI) specification your switch is implementing (either 3.0 or 3.1). The **deconfig** utility allows you to set the UNI implementation to match your switch.

Lastly, you can configure the **dcm** configuration monitoring utility to not allow network changes from a remote workstation.

Regardless of how much configuration you perform, you must ensure that the given interface's hostname is recognized by the system. This requires a separate procedure that involves changing *global* version of files whose *local* versions are the only ones affected by the specific configuration procedures described above. Even though this procedure is generally performed at the end of the configuration process, it is described before the other procedures.

The sections that follow describe these configuration procedures.

---

## Global Configuration

If you are running a **SunOS** operating system, you must update the "hosts", "services", and "netmask" maps on your directory service Master Server so that all hosts using the service will be updated with the new interface name.

If you are running a **Solaris** operating system, you must perform the following steps:

- a Update the "hosts", "services", and "netmask" maps on your directory service Master Server so that all hosts using the service will be updated with the new interface name.
- b On the local workstation, edit the file `/etc/nsswitch.conf` and list "files" before "nis" on the "hosts", "services", and "netmasks" entries. ■

**Example:** File /etc/nsswitch.conf

```
#
# /etc/nsswitch.nis:
#
# An example file that could be copied over to /etc/nsswitch.conf; it
# uses NIS (YP) in conjunction with files.
#
# "hosts:" and "services:" in this file are used only if the /etc/netconfig
# file contains "switch.so" as a nametoaddr library for "inet" transports.

# the following two lines obviate the "+" entry in /etc/passwd and /etc/group.
passwd:    files nis
group:     files nis

# consult /etc "files" only if nis is down.
hosts:     files nis dns [NOTFOUND=return] ← Changed
networks:  files nis [NOTFOUND=return] ←
protocols: nis [NOTFOUND=return] files
rpc:       nis [NOTFOUND=return] files
ethers:    nis [NOTFOUND=return] files
netmasks: files nis [NOTFOUND=return] ←
bootparams: nis [NOTFOUND=return] files
publickey: nis [NOTFOUND=return] files

netgroup:  nis

automount: files nis
aliases:   files nis

# for efficient getservbyname() avoid nis
services:  files nis
sendmailvars: files
```

## ILMI Configuration

The ATMworks 950L software implements ILMI, which in turn uses the Simple Network Management Protocol (SNMP) to allow communication between end-stations and switches.

In this release of the software, the main purpose of ILMI is "address registration." In order for a switch to communicate with an end-station, it needs to know the ATM address of the ATMworks 950L in the end-station. Likewise, the end-station must also know the network prefix associated with the switch port before it can set its ATM address.

ILMI provides the capability for the switch and end-station to trade information about the switch's network prefix and the end-station's ATM addresses using SNMP *set* requests. The

end-station creates its ATM address from a “network prefix” provided by the switch plus the end-station’s own unique end-station identifier (ESI).

You can use the **deconfig** utility to configure ILMI support to be enabled or disabled upon system restart. You can also use the **dcm** utility later to stop and restart ILMI or to configure parameters used by the function. However, if you change the enabled/disabled state of ILMI using **dcm**, the new state will only be in effect until the system is rebooted. Then, whatever has been configured via **deconfig** (ILMI enabled or disabled) will take effect.



### To enable/disable ILMI on reboot

- 1 Log on as the *root* user to the host system that contains the ATMworks 950L software.
- 2 Issue the **deconfig** command. Choose option “2” from the menu to configure ILMI.

```
stingray# /usr/dec/bin/deconfig

+-----+
| This script steps you through the process of configuring |
| your ATM adapter(s). For each adapter you may choose   |
| to configure specific services depending on the needs of |
| your network. Please refer to the documentation provided |
| for detailed information on the configuration options.    |
+-----+

Please choose one of the following:

0 -- Done with configuration
1 -- Show current configuration
2 -- Configure ILMI Address Registration
3 -- Configure signalling support
4 -- Configure Classical IP network interface, PVCs, and ATM ARP Server
5 -- Configure LANE Client(s), LANE network interface, and LECS
6 -- Configure DCM
Which do you want to do? (default:1) [0-6]: 2
```

Note that the text that begins with “This script...” and ends with “...the configuration options” is referred to as the *description box* within later appearances of this menu.



- 3 The ILMI configuration menu is displayed; you can enable or disable ILMI support from here. Select “1” to enable ILMI.

```
Please choose one of the following:

0 -- Return to main menu
1 -- Enable ILMI support
2 -- Disable ILMI support

Which do you want to do? (default:1) [0-2]: 1
```

A message is displayed indicating that ILMI will be enabled upon system restart.

- 4 You can also disable ILMI from the ILMI configuration menu by selecting “2”.

```
ILMI support has been enabled and will be
available following the next system restart.

Please choose one of the following:

0 -- Return to main menu
1 -- Enable ILMI support
2 -- Disable ILMI support

Which do you want to do? (default:1) [0-2]: 2
```

- 5 If you disable ILMI address registration, but you still want signalling to be in effect, you will have to supply an ATM address for the ATMworks 950L.



**CAUTION:** *If signalling is currently active when ILMI is disabled, it will cause signalling to be restarted. In this event, all existing SVCs will be disconnected, and the signalling and ILMI PVCs will be recreated.*

```
If you are not going to run ILMI Address Registration you will
need to assign an ATM Address to the adapter manually.

Do you want to assign an ATM Address now? (default: y) [y,n]: y
```



The network prefix of the ATM address, which comes from the switch, can be cut and pasted from a shell window into the **deconfig** script.

6 If you answer “y”, a diagram is presented that shows the makeup of the network prefix of the ATM address. You will be prompted for a 26-character network prefix.

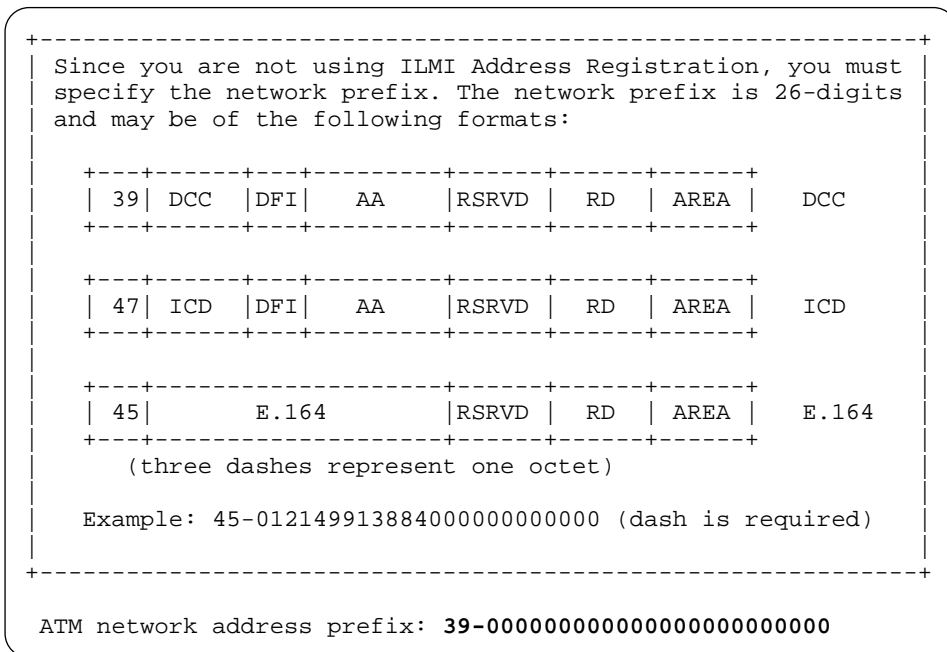

 **Note:** A dash is required after the first two digits of the network prefix.

7 You are prompted to confirm that the prefix you entered is correct. If you enter “n” at the prompt, the address configuration menu is presented again.

```

Is 39-000000000000000000000000 the correct network prefix?
(default:y) [y,n]: y

```

8 The next prompt asks if you want to change the factory-default ESI for the ATMworks 950L. This option is used mainly in test environments and is not necessary for

normal user systems. To keep the default ESI, press <Enter> or answer “n”.

```
Do you want to override the factory ESI? (default:n) [y,n]: n
```

If you answer “y” to modify the ESI, you are prompted to input the 12-character string with no delimiters.

```
End Station Identifier: 123456789012
```

- 9 When you complete the configuration, messages are displayed indicating whether ILMI is enable or disabled. If ILMI is disabled, a message indicates whether or not the ATM address has been configured. The signalling configuration menu is redisplayed. Enter “0” to return to the main menu. ■

## Signalling Configuration

The ATMworks 950L’s signalling software allows it to communicate with a switch to dynamically create SVCs and to perform LAN Emulation and/or CIP functions, if they are enabled.

Using the **deconfig** utility, you can configure the system so that signalling is enabled or disabled whenever the system is rebooted.

### Figure 6-3 Signalling Configuration Checklist

Fill in the following information to be used as you step through the signalling configuration:

What UNI implementation is running on your switch? UNI 3.0 \_\_\_\_ UNI 3.1 \_\_\_\_

If you are not enabling signalling, enter the ATM address for the ATMworks 950L:

\_\_\_\_\_



### To configure signalling

- 1 Log on as the *root* user to the host system that contains the ATMworks 950L software.
- 2 Issue the **deconfig** command, and select menu item “3” from the main menu.

```
stingray# /usr/dec/bin/deconfig
<description box is displayed here>

Please choose one of the following:

  0 -- Done with configuration
  1 -- Show current configuration
  2 -- Configure ILMI Address Registration
  3 -- Configure signalling support
  4 -- Configure Classical IP network interface, PVCs, and ATM ARP Server
  5 -- Configure LANE Client(s), LANE network interface, and LECS
  6 -- Configure DCM

Which do you want to do? (default: 1) [0-6]: 3
```

- 3 The signalling configuration menu is displayed. Select “1” to enable signalling, or “2” to disable it.

If you choose to enable signalling, skip to step 8.

```
Please choose one of the following:

  0 -- Return to main menu
  1 -- Enable signalling support
  2 -- Disable signalling support
  3 -- Set UNI Version 3.0
  4 -- Set UNI Version 3.1

Which do you want to do? (default:1) [0-4]: 1

Signalling support has been enabled and will be available
after the next system restart.
```

- 4 If you choose to disable signalling, you will have to set the ATM address of the ATMworks 950L manually. Answer

**“y”** at the next prompt to configure the address. If you answer **“n”** at this prompt, skip to step 8.

```
Which do you want to do? (default:1) [0-4]: 2
```

```
Signalling support has been disabled and will NOT be available following the next system restart.
```

```
If you are not going to run ILMI Address Registration you will need to assign an ATM Address to the adapter manually.
```

```
Do you want to assign an ATM Address now? (default: y) [y,n]: y
```

**5** If you answered **“y”**, a diagram is presented that shows the makeup of the network prefix of the ATM address. You are prompted for a 26-character network prefix.

```
+-----+
| Since you are not using ILMI Address Registration, you must specify the network prefix. The network prefix is 26-digits and may be of the following formats:
```

```
+-----+
| 39| DCC |DFI|  AA  |RSRVD| RD | AREA | DCC
+-----+
```

```
+-----+
| 47| ICD |DFI|  AA  |RSRVD| RD | AREA | ICD
+-----+
```

```
+-----+
| 45|          E.164          |RSRVD| RD | AREA | E.164
+-----+
```

```
(three dashes represent one octet)
```

```
Example: 45-012149913884000000000000 (dash is required)
```

```
ATM network address prefix: 39-000000000000000000000000
```

 **Note:** A dash is required after the first two digits of the network prefix.

- 6 You are prompted to confirm that the prefix you entered is correct. If you enter “n” at the prompt, the address configuration menu is presented again.

```
Is 39-00000000000000000000000000000000 the correct network prefix?  
(default: y) [y,n]: y
```

- 7 The next prompt asks if you want to change the factory-default ESI for the ATMworks 950L. This option is used mainly in test environments and is not necessary for normal user systems. To keep the default ESI, press <Enter> or answer “n”.

```
Do you want to override the factory ESI? (default: n) [y,n]: y
```

If you answer “y” to modify the ESI, you will be prompted to input the 12-character string with no delimiters.

```
End Station Identifier: 123456789012
```

- 8 When you complete the configuration, messages are displayed indicating whether signalling is enabled or disabled, and whether ILMI is enabled or disabled.
- If ILMI is disabled, a message indicates whether or not the ATM address has been configured. The signalling configuration menu is redisplayed. Enter “0” to return to the main menu.
- 9 Finally, you may need to set the User-Network Interface (UNI) implementation for the ATMworks 950L, as described in the following section. ■

## User-Network Interface (UNI) 3.0/3.1 Configuration

---

In order for ILMI and signalling to operate correctly, the ATMworks 950L must implement the same User-Network Interface (UNI) specification as the switch or end-station with which it is communicating. There are currently two different UNI Specifications being implemented within various ATM products on the market today: UNI 3.0 and UNI 3.1. Check

the documentation for your switch to determine which version of UNI the switch is implementing.

If an ATMworks 950L is connected to a switch that is running a different UNI, when the end-station is rebooted, ILMI will not be able to perform ATM address registration. If any of ILMI, signalling, and the UNI are incorrectly configured, you will not see an ATM address when you execute the **show address** command within **dcm**.

The following procedure allows you to configure signalling as well as set the UNI version for your ATMworks 950L.



### To set the UNI implementation

- 1 Issue the **deconfig** command. Select “**3**” from the main menu to display the signalling configuration menu.
- 2 Select “**3**” for UNI 3.0, or “**4**” for UNI 3.1.

```
Please choose one of the following:

0 -- Return to main menu
1 -- Enable signalling support
2 -- Disable signalling support
3 -- Set UNI Version 3.0
4 -- Set UNI Version 3.1

Which do you want to do? (default:1) [0-4]: 3

UNI Version has been set to 3.0 and will be available
following the next system restart.
```

A message will be displayed indicating that the specified version of UNI will be available upon system restart. ■

## DCM Access Configuration

The configuration management daemon process can be started from the command line with the “**-s**” option. This causes the daemon to have “security” enabled. This means that a user logged on as *root* who is executing **dcm** will not be allowed root or superuser privileges on remote systems.

To the administrator, this means that any users who will be running **dcm** on remote systems must have their user IDs

specified in the system's `/etc/passwd` file. Any users who are not specified will not be able to execute **dcm** remotely.

By default, your system is configured with the security feature off. You can enable or disable this security feature using **deconfig**.



### To enable or disable DCM security

- 1 Log on as the *root* user to the host system that contains the ATMworks 950L software.
- 2 Issue the **deconfig** command, and select option “6” to configure DCM security.

```
stingray# /usr/dec/bin/deconfig
<description box is displayed here>

Please choose one of the following:

  0 -- Done with configuration
  1 -- Show current configuration
  2 -- Configure ILMI Address Registration
  3 -- Configure signalling support
  4 -- Configure Classical IP network interface, PVCs, and ATM ARP Server
  5 -- Configure LANE Client(s), LANE network interface, and LECS
  6 -- Configure DCM

Which do you want to do? (default:1) [0-6]: 6
```

- 3 To enable security, select “1” from the security menu. To disable security, select “2”.

```
Please choose one of the following:

  0 -- Return to main menu
  1 -- Enable management security option
  2 -- Disable management security option

Which do you want to do? (default: 1) [0-2]: 1
Modifying /etc/inetd.conf...
```

A message is displayed indicating that security has been enabled or disabled, effective upon restart. ■



---

## LAN Emulation Configuration

The ATMworks 950L can be connected to an ATM network that is implementing LAN Emulation (LANE). LAN Emulation enables Ethernet or Token Ring traffic to run over ATM media without modification of existing applications.

Unlike CIP, LANE operates at the media access control (MAC) layer. LANE protocols are used instead of MAC layer protocols to provide a service interface for the network layer protocols. Data sent across the ATM network is encapsulated into the appropriate LAN MAC packet format. Thus, the LANE protocols allow an ATM network to operate like an Ethernet or Token Ring LAN, only faster.

An emulated LAN consists of the following components:

- ❖ A set of LAN Emulation Clients (LECs), implemented within the ATMworks 950L
- ❖ One LANE Service, which consists of:
  - one LE Configuration Server (LECS)
  - one LE Server (LES)
  - a Broadcast Unknown Server (BUS)

### The LAN Emulation Client (LEC)



Some switches hard-code the ELAN name and *force* you to configure an ELAN name for each LEC. Check the switch manufacturer's documentation to see if they require ELAN names.

---

An LEC is a part of an ATM end-station that provides a standard LAN service interface to any higher layer entity. The LEC also performs data forwarding, address resolution, and other functions within a single emulated LAN (ELAN).

The ATMworks 950L allows the configuration of up to 16 LECs, each on a different subnetwork. Each LEC subnet can only reside on one ELAN at a time.

On the client side, the administrator assigns a unique ATM address to each LEC. On the server side, LANE Services uses the LECs ATM address, or other available information, in assigning it membership in an ELAN. Optionally, on the client side, an ELAN name can be assigned to an LEC indicating which ELAN it should join. However, this can be overridden by LANE Services, depending on how it is configured.

One or more emulated LANs can run on the same ATM network, though they must remain independent of each other.

The LAN Emulation function uses ILMI and Q2931 signalling to connect to the LE Configuration Server and to provide MAC addresses to the LECS. Therefore, signalling and ILMI must be enabled for Digital Equipment Corporation's LAN Emulation to work.

This is a very brief description of LAN Emulation. For complete details on the processes used by the LAN Emulation function, please refer to the *LAN Emulation Over ATM Specification, Version 1.0*.

## Basic LANE Configuration

---

The simplest way to configure your ATMworks 950L to use LAN Emulation is:

- 1 Decide how many LECs you will need (1-16);
- 2 Add each LEC and enter a hostname and an IP address for the LECs LANE interface (the LANE interface must be on a separate network from any other interface on the ATMworks 950L).

This is the minimum information that must be configured. The **deconfig** utility will set up the following defaults:

- Signalling is enabled
- LANE is enabled
- The well-known address is used for the LECS
- Each LEC's parameters default as follows:
  - Peak cell rate is set to 100% of line rate
  - Inactivity timeout: none
  - Factory ESI is used for the MAC address
  - ELAN name is undefined

The following procedure steps you through basic LAN emulation configuration. After LANE configuration is complete, you can always go back and change the configuration using the "Modify" options on the LANE menu.

**Figure 6-4 LAN Emulation Configuration Checklist**

Fill in the following information to be used as you step through the LANE configuration:

LANE Menu Item # 6: LAN Emulation Configuration Server (LECS) configuration

LECS ASCII name to associate with ATM address: \_\_\_\_\_

LECS ATM Address: \_\_\_\_\_

LANE Menu Item # 3: LAN Emulation Client (LEC) configuration (optional inputs are shaded)

LEC #	Hostname	IP Address	PCR	Inactivity Timeout	ELAN name	MAC Address
1						
2						
3						
4						
5						
6						
7						
8						
9						
10						
11						
12						
13						
14						
15						
16						

LANE Menu Item # 8: LAN Emulation Server (LES) configuration (OPTIONAL)

LEC #	LES ATM Address



## Basic LAN Emulation configuration

- 1 Log on as the *root* user to the host system that contains the ATMworks 950L software.
- 2 Issue the **deconfig** command. Select item “5” from the main menu.

```
stingray# /usr/dec/bin/deconfig
<description box is displayed here>

Please choose one of the following:

0 -- Done with configuration
1 -- Show current configuration
2 -- Configure ILMi Address Registration
3 -- Configure signalling support
4 -- Configure Classical IP network interface, PVCs, and ATM ARP Server
5 -- Configure LANE Client(s), LANE network interface, and LECS
6 -- Configure DCM

Which do you want to do? (default:1) [0-6]: 5
```

- 3 The LAN Emulation menu is displayed. Choose option “3” to configure an LEC.

```
Please choose one of the following:

0 -- Return to main menu
1 -- Enable LAN Emulation support
2 -- Disable LAN Emulation support
3 -- Add LAN Emulation Client (LEC)
4 -- Modify LAN Emulation Client (LEC)
5 -- Remove LAN Emulation Client (LEC)
6 -- Modify LAN Emulation Configuration Server (LECS) address
7 -- Remove LAN Emulation Configuration Server (LECS) address
8 -- Modify LAN Emulation Server (LES) address for an LEC
9 -- Remove LAN Emulation Server (LES) address for an LEC

Which do you want to do? (default:1) [0-9]: 3
```

- 4 A message is displayed stating that you will need to enter a unique hostname and IP address for the LEC. To continue with the configuration, enter “y”; enter “n” to go back to the LANE menu.

 **Note:** The LAN Emulation interface must be on a separate subnet from any other network IP interfaces in the end-station.

```
+-----+
| You have chosen to create a LAN Emulation Client which means
| you must choose a unique hostname and IP address for each LANE
| network interface. All IP interface addresses must be on a
| separate subnet from each other. Be sure to specify a separate
| subnet for each IP address.
+-----+
```

```
Do you want to continue? (default:y) [y,n]: y
```

**5** A message is displayed indicating that LAN Emulation has been enabled. A prompt asks for the LEC number, which is any whole number between 1 and 16. Press *<Enter>* to accept the default, which is the first available number.

```
LAN Emulation support has been enabled and will be
available following the next system restart.
```

```
Number of this LEC? (default:1) [1-16]: <Enter>
```

**6** The next prompt asks for a unique hostname for the interface. A hostname is suggested based on the nodename of the host system plus the LEC number. Press *<Enter>* to accept the suggested hostname, or enter another name.

```
Name for this LANE ATM interface "enle101"?
(default: stingray_lane101): <Enter>
```

**7** The next prompt asks for the IP address of the LEC interface. If a default address is displayed, it means the hostname entered was found in the */etc/hosts* file and this

LEC has probably already been configured. Press <Enter> to accept the default IP address, or enter a new address.

```
IP address for ATM interface "enle101"? (default: 6.1.0.46): 192.94.73.2
```

**8** The next five prompts ask for optional parameter information. These parameters are described in the next section, "Custom LAN Emulation Configuration". Press <Enter> in response to each question to accept the default.

```
Do you want to set the Peak Cell Rate for data connections?
(default: n) [y,n] <Enter>

Do you want to set a default inactivity timeout for data
connections? (default: n) [y,n] <Enter>

Do you want to override the factory ESI for the MAC address?
(default: n) [y,n] <Enter>

Do you want to specify an ELAN name for this LEC?
(default: n) [y,n] <Enter>

Do you want to bypass the LECS by specifying an LES for this
LEC? (default: n) [y,n]: <Enter>
```

**9** The information you have entered is displayed, and you are asked to verify that it is correct.

```
+-----+
| ATM Interface Name and IP Address Information |
+-----+

ATM Adapter Number:          1

LANE Interface Name:         gourami_lane101
LANE Interface IP Address:   6.1.0.46

LEC Peak Cell Rate Percentage: Full Line Rate
LEC Inactivity Timeout:     Default
LEC MAC Address:            Factory ESI
LEC ELAN Name:              None specified
Associated LES Name:        None specified
Associated LES ATM Address:  None specified
```

**10** If the hostname or IP address is already in the `/etc/hosts` file, a message is displayed.

- To modify the existing LEC configuration, answer “**y**”. Messages will be displayed indicating the files that are updated as a result.
- If you answer “**n**”, the next prompt asks if you wish to reenter the information.

If you answer “**y**” (you want to reenter the information), all of the configuration prompts are displayed again. If you enter “**n**”, the LANE configuration menu is displayed again and the information is discarded.

```
stingray_lane101 is already in the hosts file with IP address 6.1.0.46
Is this information correct? (default: y) [y,n] n
Re-enter ATM Interface information? (default: y) [y,n]: y
```

**11** When the configuration of the LEC interface is complete, the LANE menu is presented.

To configure more LECs, perform steps 3 through 10 again. Otherwise, exit the script by selecting “**q**”. ■

## Custom LAN Emulation Configuration

---

The previous procedure describes the minimum configuration, of one or more LECs, that must be performed to get LANE up and running. There are more custom features that can be configured for LAN emulation. You can also:

- ❖ Specify parameters for each LEC, include:
  - PCR (as a percentage of line rate)
  - Inactivity timeout
  - MAC address other than the End Station Identifier
  - Name of ELAN to join
  - Hostname and address of the LES to which the LEC should connect directly, bypassing the LECS
- ❖ Specify an LECS address other than the well-known address

## Specifying Custom LEC Parameters

You can configure each LEC individually with specific parameters. The following parameters can be set:

<b>Peak Cell Rate</b>	Specifies the PCR to be imposed on all of the connections to the LEC. This value is an integer from 1-100 percent of line rate.
<b>Inactivity timeout</b>	Specifies the amount of time (1-6000 seconds) that the connection can remain idle before the Data Direct connections between two given LECs are shut down.
<b>MAC address</b>	Specifies a 12-character hexadecimal MAC address to use instead of the ESI. The MAC address must be unique on the network, since an LEC can be transferred to a different ELAN through the LANE server.
<b>ELAN name</b>	Specifies a name for the Emulated LAN that you want the LEC to join. Note that setting this name does <b>not</b> guarantee that the LEC will be allowed to join the ELAN: the LES must be configured to allow the LEC to join. This name consists of up to 32 printable ASCII characters.
<b>LES name and address</b>	Specifies the hostname and 40-character hex ATM address for an LES that the LEC will connect to directly, bypassing the LECS.

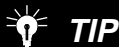

### TIP

You can also configure or modify an LES address for a particular LEC by selecting menu item **8** from the LANE menu.

To configure these parameters for a new LEC, follow the procedure “Basic LAN Emulation configuration” on page 76. Fill in the desired parameters as indicated by the prompts shown in step 8 of that procedure.

To configure these parameters for an existing LEC, use the “Modify” option from the LANE menu to modify the LEC parameters, as described in the following procedure.





### To modify an LEC configuration

- 1 Log on as the *root* user to the host system that contains the ATMworks 950L software.
- 2 Issue the **deconfig** command; select menu item “5”.
- 3 The LAN Emulation menu is displayed. Choose option “4” to modify an LEC.

Please choose one of the following:

```
0 -- Return to main menu
1 -- Enable LAN Emulation support
2 -- Disable LAN Emulation support
3 -- Add LAN Emulation Client (LEC)
4 -- Modify LAN Emulation Client (LEC)
5 -- Remove LAN Emulation Client (LEC)
6 -- Modify LAN Emulation Configuration Server (LECS) address
7 -- Remove LAN Emulation Configuration Server (LECS) address
8 -- Modify LAN Emulation Server (LES) address for an LEC
9 -- Remove LAN Emulation Server (LES) address for an LEC
```

Which do you want to do? (default: 1) [0-9]: 4

- 4 A message is displayed for confirmation that you chosen to modify an LEC. Enter “y” to continue, or “n” to go back to the LANE menu.
- 5 All currently configured LECs are listed. Enter the number of the LEC you wish to modify.

Currently configured LEC interfaces:

```
Lec: 1 IP Address: stingray_lane101 (6.1.0.46)
Lec: 2 IP Address: stingray_le102 (6.2.0.46)
Lec: 3 IP Address: stingray_le103 (6.3.0.46)
Lec: 4 IP Address: stingray_le104 (6.4.0.46)
Lec: 5 IP Address: stingray_lane105 (6.5.0.46)
```

LEC number to modify? (default: 1) [1-16]: 2

**6** The next screen lists the current configuration of all of the parameters for the LEC that you selected. Select the one you wish to change.

```

+-----+
| ATM Interface Name |
+-----+

ATM Adapter Number:      1
ATM LANE Client Number:  2

ATM LANE Interface Name: enle102
ATM LANE Node Name:      gourami_le102
ATM LANE IP Address:     6.2.0.46

Select parameter to modify:

0. Done modifying parameters
1. LEC Peak Cell Rate Percentage: Full Line Rate
2. LEC Inactivity Timeout:      None specified
3. LEC MAC Address:              Factory ESI
4. LEC ELAN Name:                elan3_1
5. Associated LES Name:          None specified, using LECS
   Associated LES ATM Address:   None specified, using LECS

Which value do you want to modify? (default:0) [0-5]: 3

```

**7** Loop through the configuration screen until you have modified all parameters as desired. Then, enter “0” to return to the LANE menu. ■

### Specifying a Custom LECS Address

Most switches that provide LANE services will be using the “well-known” ATM address for the LECS. This address is:

47-0079:0000:0000:0000:0000:0000-00a0:3e00:0001-00

Alternately, you can specify a particular hostname and a 40-character ATM address for the LECS that you want to connect to, by executing the following procedure.



#### To set the LECS address

- 1 Log on as the *root* user to the host system that contains the ATMworks 950L software.

**2 Issue the `deconfig` command, and select item “5” from the main menu.**

```
stingray# /usr/dec/bin/deconfig
<description box is displayed here>

Please choose one of the following:

  0 -- Done with configuration
  1 -- Show current configuration
  2 -- Configure ILMI Address Registration
  3 -- Configure signalling support
  4 -- Configure Classical IP network interface, PVCs, and ATM ARP Server
  5 -- Configure LANE Client(s), LANE network interface, and LECS
  6 -- Configure DCM

Which do you want to do? (default:1) [0-6]: 5
```

**3 The LANE menu is displayed. Choose option “6” to configure the LECS address.**

```
Please choose one of the following:

  0 -- Return to main menu
  1 -- Enable LAN Emulation support
  2 -- Disable LAN Emulation support
  3 -- Add LAN Emulation Client (LEC)
  4 -- Modify LAN Emulation Client (LEC)
  5 -- Remove LAN Emulation Client (LEC)
  6 -- Modify LAN Emulation Configuration Server (LECS) address
  7 -- Remove LAN Emulation Configuration Server (LECS) address
  8 -- Modify LAN Emulation Server (LES) address for an LEC
  9 -- Remove LAN Emulation Server (LES) address for an LEC

Which do you want to do? (default:1) [0-9]: 6
```

- 4** A message is displayed explaining that you only need to configure one LECS per system. Enter “y” to continue, or “n” to go back to the LANE menu.

```
+-----+
| If you have added an LAN Emulation Client, you will need to |
| provide information about the address of the LAN Emulation |
| Configuration Server (LECS).                               |
| This configuration is only done once for each system and   |
| applies to all LAN Emulation Clients on this adapter.     |
| If the address of the LECS is not specified, then the    |
| well-known ATM address of the LECS will be used by default. |
+-----+
```

Do you want to continue? (default: y) [y,n]: **y**

- 5** The next prompt asks for the hostname of the LECS. Press <Enter> to accept the default name, or enter another name.

```
+-----+
| LAN Emulation Client (LEC) Configuration /                 |
| LAN Emulation Configuration Server (LECS) Address         |
+-----+
```

Enter ATM hostname for LECS. (default:lecs): **<Enter>**

- 6** The next prompt asks if you want to use the well-known address. Enter “n”.

```
Use the well-known ATM address for the LECS?
(default: y) [y,n]: n
```

- 7** At the next prompt, enter the 40-character LECS ATM address. A dash is required after the first two characters of the address. When you are asked whether the address

you entered is correct, answer “y” to accept the input, or “n” to go through the configuration again.

```
Enter LECS ATM address : 47-0079000000000000000000000000a03e00000100

+-----+
| LECS/LECS Configuration Information |
+-----+

LECS ATM hostname : lecs
LECS ATM address : 47-0079000000000000000000000000a03e00000100

Is this information correct? (default: y) [y,n]: y
```

8 After you accept the information, messages indicate the files that are updated, and the LANE menu is displayed again. ■

## Removing an LEC

You can use **deconfig** to remove an LEC from the system. This process will eliminate all traces of that LEC from all configuration files.



### To remove an LEC

- 1 Log on as the *root* user to the host system that contains the ATMworks 950L software.
- 2 Issue the **deconfig** command. Select menu item “5” to display the LANE menu.

```
Please choose one of the following:

0 -- Return to main menu
1 -- Enable LAN Emulation support
2 -- Disable LAN Emulation support
3 -- Add LAN Emulation Client (LEC)
4 -- Modify LAN Emulation Client (LEC)
5 -- Remove LAN Emulation Client (LEC)
6 -- Modify LAN Emulation Configuration Server (LECS) address
7 -- Remove LAN Emulation Configuration Server (LECS) address
8 -- Modify LAN Emulation Server (LES) address for an LEC
9 -- Remove LAN Emulation Server (LES) address for an LEC

Which do you want to do? (default:1) [0-9]: 5
```

- 3** Select item “5” from the LANE menu to remove an LEC. A list of all of the currently configure LECs is presented. Enter the number of the LEC you wish to remove.

```
Currently configured LEC interfaces:
Lec: 1 IP Address: stingray_lane101 (6.1.0.46)
Lec: 2 IP Address: stingray_le102 (6.2.0.46)
Lec: 3 IP Address: stingray_le103 (6.3.0.46)
Lec: 4 IP Address: stingray_le104 (6.4.0.46)
Lec: 5 IP Address: stingray_lane105 (6.5.0.46)

LEC number to remove? (default:1) [1-16]: 5
```

- 4** A screen is displayed showing the current configuration of that LEC. You are prompted to confirm the removal. To remove the LEC, enter “y”; enter “n” to return to the LANE menu.

```
+-----+
| ATM Interface Name                               |
+-----+

ATM Adapter Number:          1
ATM LANE Client Number:     5

ATM LANE Interface Name:    enle105
ATM LANE Node Name:         gourami_lane105

Remove this interface? (default:y) [y,n]: y
```

- 5** If you entered “y”, messages are displayed showing the files from which the information has been removed and that the specified LEC will not be available as of the next system restart. Then, the LANE menu is displayed again, allowing you to select another LEC to be removed, if desired. ■

---

## Removing a Custom LECS Address

You can also remove an LECS address, but only if a custom address has been defined. If you do remove the LECS address, the well-known address is used instead.

The well-known LECS address can not be removed. You can bypass the LECS for one or more LECs by specifying an LES address for the LEC(s). Refer to the procedure “To

modify an LEC configuration” on page 81 for details on specifying LES addresses.



### To remove a custom LECS

- 1 Log on as the *root* user to the host system that contains the ATMworks 950L software.
- 2 Issue the **deconfig** command, and select item “5” from the main menu to display the LANE menu.
- 3 Select menu item “7” to remove the LECS address. When you are asked whether to continue, enter “y”.
- 4 If no custom address has ever been defined, the following message is displayed:

```
No LECS has been configured for this adapter.
```

If an LECS has been defined, the LECS address is displayed, and a prompt asks you to confirm that the information is correct.

```
+-----+
| LEC/LECS Configuration Information |
+-----+

LECS ATM hostname : lecs
LECS ATM address  : 47-0079000000000000000000000000a03e00000100

Is this information correct? (default: y) [y,n]: y
/usr/opt/DEC-Aruba/cfg/serverlecs.enlel
LECS information has been removed.
```

- 5 If you answer “y”, a message is displayed indicating that the given LECS address has been removed, and the main LANE menu is again displayed. ■

## Removing LES Addresses

One or more LECs on the ATMworks 950L may have been configured to bypass the LECS and connect directly to an LES. You can remove the LES configuration for an LEC, which will result in the LEC pointing back to the LECS that has been configured for the ATMworks 950L.

The **deconfig** utility provides two ways to remove an LES address: by modifying the LEC to which it is assigned, as described in the procedure “To modify an LEC configuration” on page 81, or by removing the LES address directly, as described below.



### To remove an LES assignment for an LEC

- 1 Log on as the *root* user to the host system that contains the ATMworks 950L software.
- 2 Issue the **deconfig** command; select menu item “5” to display the LANE menu.
- 3 Select menu item “9” to remove an LES address. When you are asked whether to continue, enter “y”.
  - a If no LES address has ever been assigned to any LEC, no LES addresses are listed. When you are prompted for an LEC number, press <Enter>. The following message will be displayed:  

```
No LES has been configured for this LEC.
```
  - b If one or more LES addresses have been defined, they are displayed, and a prompt asks you to which one to remove.

```
Currently configured LEC LES addresses:  
Lec: 1   LES: les 47-00790000000000000000000000000000a03e00000100  
Lec: 2   LES: les2 47-00790000000000000000000000000000a03e00001100  
  
LEC number to remove LES link? (default: 1) [1-16]: 1
```

When you enter an LEC number, the current configuration of the LEC is displayed and you are prompted to confirm the removal. Enter “y” to remove the LES address, or “n” to return to the main LANE menu. ■



## Classical IP (CIP) Configuration

This section describes procedures for configuring Classical IP. If you will be using signalling/SVCs, you will need to:

- ❖ Define an IP address for the ATMworks 950L's IP interface; and
- ❖ Set up an ATM ARP server that will map ATM addresses to IP addresses.

You may also want to create PVCs if, for example, you are installing a second adapter in a workstation. This section describes how to use **deconfig** to set up PVCs that will be recreated each time the workstation is rebooted.

**Figure 6-5** Classical IP Configuration Checklist

Fill in the following information to be used as you step through the CIP configuration:

### CIP Menu Item # 1: Enabling CIP support

First adapter installed: ATM hostname: \_\_\_\_\_ IP address: \_\_\_\_\_

### CIP Menu Item # 3: PVC Configuration

For each installed adapter that has PVCs, enter VC# and destination's hostname or IP address

Adapter No.____	VC #	Hostname or IP Addr	Adapter No.____	VC #	Hostname or IP Addr	Adapter No.____	VC #	Hostname or IP Addr

### CIP Menu Item # 4: ATM ARP Server/SVC Configuration

ATM ARP server ASCII name to associate with ATM address: \_\_\_\_\_

ATM ARP server ATM address: \_\_\_\_\_

PCR for SVCs (1-100% of line rate): \_\_\_\_\_

## Assigning IP Addresses and Subnet Masks

For each ATMworks 950L installed, you must add IP addresses and subnet masks for the ATMworks 950L's network interfaces to the `/etc/hosts` file. Also, if you plan on creating subnets on your ATM network(s), you must add the subnet mask to the `/etc/netmasks` file by manually editing the file.

You can update the `/etc/hosts` file using the **deconfig** utility. The subnet mask information and addresses are requested when you enable Classical IP (CIP) through the utility. To disable the CIP interface using **deconfig**, refer to the procedure "To disable CIP support on an ATMworks 950L" on page 94.



### To configure IP addresses for ATMworks 950L interfaces

- 1 Log on as the `root` user to the host system that contains the ATMworks 950L software.
- 2 Issue the **deconfig** command. The main menu is displayed..

```
stingray# /usr/dec/bin/deconfig
<description box is displayed here>

Please choose one of the following:

  0 -- Done with configuration
  1 -- Show current configuration
  2 -- Configure ILMI Address Registration
  3 -- Configure signalling support
  4 -- Configure Classical IP network interface, PVCs, and ATM ARP Server
  5 -- Configure LANE Client(s), LANE network interface, and LECS
  6 -- Configure DCM

Which do you want to do? (default:1) [0-6]: 4
```

**3 Choose option “1” from the menu to display the current CIP configuration.**

```
+-----+
|
| Current Configuration
| -----
|
| Classical IP
|   Interfaces : stingray_atml (3.0.0.37)
|   PVC Configuration File : No Connections Exist
| LAN Emulation : Disabled
|   Interfaces :
|   LECS :
|   LES :
| SVC Support (1755): Disabled
|   ARP Server :
| Signalling : Enabled
| ILMI : Disabled
| DCM : Security Authentication Disabled
|
+-----+

Please choose one of the following:

0 -- Done with configuration
1 -- Show current configuration
2 -- Configure ILMI Address Registration
3 -- Configure signalling support
4 -- Configure Classical IP network interface, PVCs, and ATM ARP Server
5 -- Configure LANE Client(s), LANE network interface, and LECS
6 -- Configure DCM

Which do you want to do? (default:1) [0-6]: 4
```

**4 Choose option “4” from the menu to configure CIP.**

**5** To configure the CIP interface's IP address, you need to enable CIP. Select "1" from the CIP configuration menu.

```
Please choose one of the following:
```

- 0 -- Return to main menu
- 1 -- Enable CIP support for an adapter
- 2 -- Disable CIP support for an adapter
- 3 -- Configure CIP PVC connections
- 4 -- Configure ATM ARP Server and enable SVC support (RFC 1755)
- 5 -- Remove ATM ARP Server and disable SVC support (RFC 1755)

```
Which do you want to do? (default 1) [0-5]: 1
```

**6** The next prompt asks if you wish to continue with CIP configuration. If you answer "n", the main menu is redisplayed.

```
+-----+
| You have chosen to run Classical IP which means you must |
| choose a unique hostname and IP address for the CIP network |
| interface. All IP interface addresses must be on a separate |
| subnet. Be sure to specify a separate subnet for this address. |
+-----+
```

```
Do you want to continue? (default: y) [y,n]: <Enter>
```

**7** Enter the instance number of the ATMworks 950L to be configured.

```
Number for this instance of adapter? (default:1) [1-16]: 1
```

**8** Next, enter the hostname that you want to assign to this interface. A suggested hostname is displayed, based on the nodename and the instance number of the ATMworks 950L. To accept the default name, press <Enter>.

```
Hostname for this CIP ATM interface "enci1"?
(default:stingray_atm1): <Enter>
```

9 Next, you are prompted to enter the IP address for the CIP interface.

```
IP address for ATM interface "encipl" (default: 3.0.0.37):
```

 **Note:** If the hostname you entered is found in the */etc/hosts* file, its IP address will be shown as the default in the prompt.

10 The information you have entered is displayed, and you are asked to confirm your inputs. If you answer “y” (indicating that the information is correct), your inputs are written to the appropriate files.

 **Note:** A message is displayed if the hostname or IP address is already in the */etc/hosts* file. If you answer “y” to the prompt discussed above, the information you have entered will replace the existing information in the file.

```
+-----+
| ATM Interface Name and IP Address Information |
+-----+

ATM Adapter Number:          1

ATM CIP Interface Name:      stingray_atml
ATM CIP Interface IP Address: 198.93.23.2

stingray_atml is already in the hosts file with IP address 198.93.23.2
Is this information correct? (default: y) [y,n]: y
```

If you answer “n”, the next prompt asks if you wish to re-enter the information.

If you answer “y” at that prompt, because you want to re-enter the information, the CIP configuration prompts are displayed again. If you enter “n”, the CIP configuration menu is displayed again and no information is written to the files.

11 After you verify that the information you entered is correct, the files are updated, and the CIP configuration menu is displayed again. ■



## To disable CIP support on an ATMworks 950L

**1** If you ever need to disable CIP, enter “**2**” at the CIP Configuration menu prompt.

```
Please choose one of the following:
```

```
0 -- Return to main menu
1 -- Enable CIP support for an adapter
2 -- Disable CIP support for an adapter
3 -- Configure CIP PVC connections
4 -- Configure ATM ARP Server and enable SVC support (RFC 1755)
5 -- Remove ATM ARP Server and disable SVC support (RFC 1755)
```

```
Which do you want to do? (default 1) [0-5]: 2
```

**2** At the next prompt, enter the instance number of the ATMworks 950L in your system.

```
Number for this instance of adapter? (default:1) [1-16]: 1
```

```
+-----+
| ATM Interface Name                               |
+-----+
```

```
ATM Adapter Number:      1
ATM CIP Interface Name:  encipl
ATM CIP Node Name:       stingray_atml
```

Information is displayed about the ATMworks 950L interface you are modifying.

**3** After confirming that this is the correct CIP interface to be removed, answer “**y**” to the prompt. To cancel removal of CIP support for this interface, enter “**n**”.

```
Remove this interface? (default: y) [y,n]: y
Removing stingray_atml from /etc/hosts...
```

```
CIP support has been disabled and will NOT be
available following the next system restart.
```

**4** At the CIP Configuration menu prompt, enter “**0**” to return to the main menu. ■

## ATM ARP Server Configuration

The ATMworks 950L supports the RFC 1577/1755 implementation of SVCs. This means that whenever data is transferred by the end-user (via FTP or *ping*, for example), SVCs are automatically created. This is done using the signalling functions. Therefore, even if you configure SVC support, the signalling and ILMI functions need to be configured and enabled in order for the system to automatically create SVCs.

With SVCs configured, the user can issue a command to an ATM IP address (or hostname), and the SVC to that end-station will be automatically created for the duration of the data transfer. In order to create an SVC when given a hostname or IP address, the system uses an ATM Address Resolution Protocol (ARP) server.

The ATM ARP server keeps a table that maps the IP addresses to the ATM addresses of the ATMworks 950L interfaces. The communication process is shown in Figure 6-6.

- 1 When the end-station gets a request to send data to an IP address, it checks for a file under `/usr/dec/cfg` called `server1577.encip#`, where # is the ATMworks 950L instance number. This file contains the ATM hostname of the ARP server.

**Figure 6-6** SVC Address Resolution from ARP Server

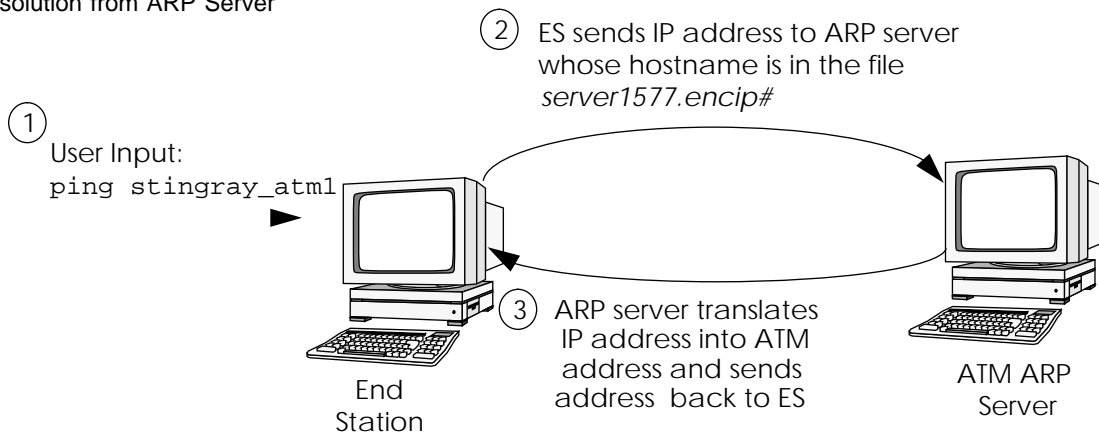

- 2 The end-station sends a request to the ARP server to translate the IP address.
- 3 The ARP server looks up the IP address in its ARP table and returns the 40-character hexadecimal ATM address of the destination end-station.

Only one ATM ARP server can be defined on your ATM network. Your existing LAN may already have an ARP server, but you still have to specify a separate ATM ARP server that will be used specifically for ATM.

To configure the ATM ARP server, you must enter the following information:

#### **ATM ARP server's hostname and ATM address**

The host you specify must already have an ATMworks 950L installed. This host can be the local host on which you are performing this procedure.

#### **Peak Cell Rate** (optional)

This specifies the PCR to be imposed on all switched virtual connections. The value is an integer from 1-100 percent of line rate.

#### **Inactivity timeout** (optional)

This specifies the amount of time (1-6000 seconds) for which all SVCs can remain idle before being released. This interval should be set high so that connections to the ATM ARP server are not dropped inadvertently.



#### **To configure the ARP server**

- 1 Log on as the *root* user to the host system that contains the ATMworks 950L software.



**2** Issue the **deconfig** command, and select menu option **“4”**.

```
stingray# /usr/dec/bin/deconfig
<description box is displayed here>

Please choose one of the following:

0 -- Done with configuration
1 -- Show current configuration
2 -- Configure ILMI Address Registration
3 -- Configure signalling support
4 -- Configure Classical IP network interface, PVCs, and ATM ARP Server
5 -- Configure LANE Client(s), LANE network interface, and LECS
6 -- Configure DCM

Which do you want to do? (default:1 [0-6] 4
```

**3** Choose option **“4”** at the CIP Configuration menu.

A message is displayed saying you are configuring SVC for the ATM ARP server, which involves choosing a hostname and ATM address for the ARP server. Enter **“y”** to continue, or **“n”** to return to the main menu.

**4** If you choose to continue, you are prompted for the ATM ARP server’s hostname.

```
Enter ATM ARP Server hostname: gourami_00
```

**5** Next, you need to enter the ATM address of the ATMworks 950L in the ARP server. If there is already an ATM ARP server configured on your network, you can get its address by running **dcm** on the ARP server host system:

- a** Open a remote shell to the ATM ARP server system and run **dcm**.



If you are running a windowing system, the ATM ARP server's ATM address can be copied and pasted from the **dcm** display into the **deconfig** script.

- b** Issue the **show address** command. The host system's ATM address is the ATM ARP server's address.

```
Enter ATM ARP Server ATM address:
39-0000-00-000000-0000-0000-0000-00:20:ea:00:05:67-00
```

- 6** The next prompt asks if you want to set the peak cell rate for all SVCs. To continue, enter **"y"**; enter **"n"** to return to the CIP configuration menu.

- 7** If you opted to continue at step 6, you need to enter a peak cell rate as a percentage of line rate, expressed as an integer between 1 and 100.

```
Do you want to set the Peak Cell Rate for data connections?
(default: n) [y,n]: y

Enter the PCR as a percentage of line rate.
(default: 100) [1-100]: 50
```

- 8** The next prompt asks if you want to set the inactivity timeout to be applied to all SVCs. To continue, enter **"y"**. Or, enter **"n"** to return to the CIP configuration menu.



**CAUTION:** *If you are running **deconfig** on the ARP server, you must enter **"n"** at this prompt. The effects of setting a timeout interval under these conditions are unpredictable.*

- 9** If you opted to continue, the next prompt asks for a timeout interval from 1-6000 seconds.

Press **<Enter>** to accept the default value, or enter a new interval.

```
Do you want to set a default inactivity timeout for data
connections? (default:n) [y,n]: y

Enter the Inactivity Timeout in seconds.
(default: 1200) [1-6000]: 3000
```

**10** When you have finished with the configuration, the information you entered is displayed, and you are prompted to verify it.

If you wish to re-enter any information, enter “n” and return to the appropriate step of this procedure.

```
+-----+
| ATM ARP Server Hostname and ATM Address |
+-----+

ATM Adapter Number:          1

ATM ARP Server Hostname:     gourami_00
ATM ARP Server ATM Address:
39-0000-00-000000-0000-0000-0000-0020ea0015c5-00

CIP Peak Cell Rate Percentage: 50
CIP Inactivity Timeout:      3000

Is this information correct? (default: y) [y,n]: y
```

If you answer “y”, messages are displayed showing which data is being written to the configuration files. ■

---

## PVC Configuration

There are two possible reasons for setting up PVCs:

- ❖ If you choose not to enable signalling, you will need to manually create PVCs between each pair of ATM endpoints;
- ❖ If you are installing a second ATMworks 950L in the workstation, signalling, SVCs, and LAN Emulation are only supported on the first ATMworks 950L installed - therefore, you can only use PVCs on subsequent ATMworks 950Ls.

Within most ATM networks, each ATMworks 950L will be connected to an ATM switch that has specific PVCs already configured. However, it is possible to connect an ATMworks 950L directly to another ATMworks 950L in a different workstation for use in testing the connection. If you are connecting the ATMworks 950L to a switch, and the switch is not already configured, you should set up the desired PVCs in the switch before you attempt to configure

the ATMworks 950L. Refer to the switch's documentation for PVC creation procedures.

When you use **deconfig** to set up PVCs, you will be prompted for specific information that will be used to set up one or more PVCs. This information is stored in a PVC Configuration file. This file is originally created by the **deconfig** script. The file, which consists of a set of **dcm create** commands, is named after your workstation's nodename.

When you reboot the workstation, the ATMworks 950L's management software uses the PVC Configuration file to automatically create the permanent virtual connections *from that host only*. If there are commands in the file to create connections from remote hosts, they will be ignored.

It is recommended that you create one central PVC Configuration file that contains all PVCs that you want automatically created upon reboot for all of the hosts on your ATM network. Then you can distribute that file to all of the nodes. You can run **deconfig** at any time to add more PVCs to the PVC Configuration file.

The following sections describe several parameters that you can configure for each PVC, including:

- ❖ Port number, if more than one ATMworks 950L is installed
- ❖ VPI/VCI number
- ❖ IP address or hostname of the ATMworks 950L to which you are connecting
- ❖ Transmit and receive rates
- ❖ Encapsulation method

### Choosing VPI/VCI Numbers

When configuring PVCs, you will need to define Virtual Path Identifier/Virtual Channel Identifier (VPI/VCI) pairs for each connection. A dedicated data transfer connection between two ATM endpoints is referred to as a Virtual Channel Connection (VCC). Figure 6-7 shows an example ATM network that includes VPIs and VCIs.

**Figure 6-7** Configuring Permanent Virtual Connections

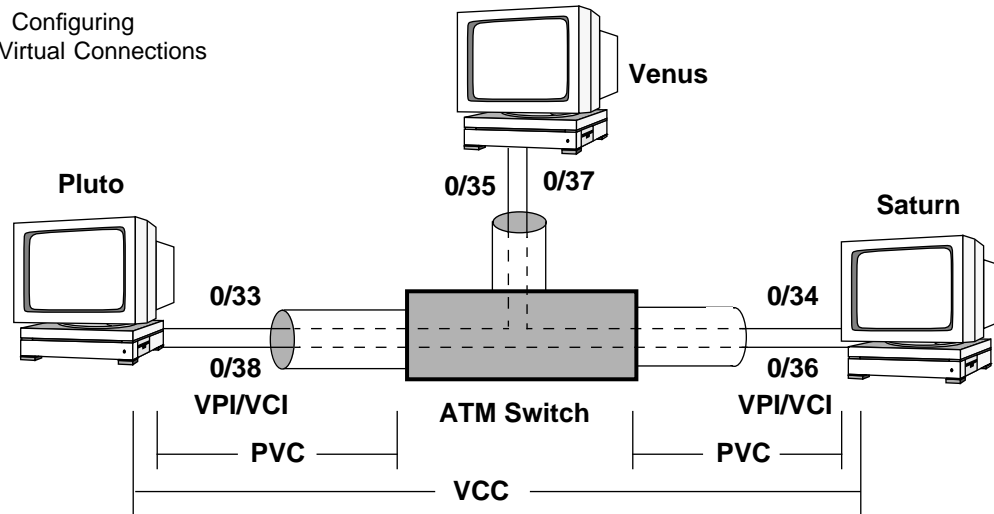

A VCC is made up of PVCs that connect each device in the VCC; the connection between an ATMworks 950L and a switch would constitute a PVC. Each PVC is identified by a VPI/VCI pair. Note that the VPI/VCI pairs for different PVCs that make up a channel connection do not have to be the same.

Currently, the VPI that the ATMworks 950L uses is fixed at 0. Therefore, only a VCI number has to be defined for each PVC that originates or terminates at one of the end-stations containing one of these ATMworks 950Ls. This VCI must be between 32 and 1023 inclusive (the values in the range 0-31 are reserved for use by the ATM protocols).

### PVC Configuration Procedure

After you have enabled CIP and specified an IP address for the CIP interface, you can use the **deconfig** utility to configure PVCs that will be recreated each time the system is rebooted. The configuration information that you enter via **deconfig** is saved in a PVC Configuration file. This file will be read whenever the system is rebooted, and will be used in the process of recreating the PVCs specified in the file.



### To configure PVCs

- 1 Log on as the *root* user to the host system that contains the ATMworks 950L software.
- 2 Issue the **deconfig** command, which displays the script's main menu.

```
stingray# /usr/dec/bin/deconfig
```

- 3 Select “4” from the menu to configure CIP.

```
Please choose one of the following:
```

- 0 -- Done with configuration
- 1 -- Show current configuration
- 2 -- Configure ILMI Address Registration
- 3 -- Configure signalling support
- 4 -- Configure Classical IP network interface, PVCs, and ATM ARP Server
- 5 -- Configure LANE Client(s), LANE network interface, and LECS
- 6 -- Configure DCM

```
Which do you want to do? (default:1) [0-6]: 4
```

- 4 To configure PVCs, select “3” from the CIP configuration menu.

```
Please choose one of the following:
```

- 0 -- Return to main menu
- 1 -- Enable CIP support for an adapter
- 2 -- Disable CIP support for an adapter
- 3 -- Configure CIP PVC connections
- 4 -- Configure ATM ARP Server and enable SVC support (RFC 1755)
- 5 -- Remove ATM ARP Server and disable SVC support (RFC 1755)

```
Which do you want to do? (default 1) [0-5]: 3
```

The next messages introduce the PVC configuration section. You can perform PVC configuration from this script, or you can use the **dcm** utility later. You are

prompted whether or not you wish to add PVCs to the PVC configuration file now.

```
+-----+
| If you have installed Classical IP on at least one
| ATM adapter, you may provide information about PVC
| connections which are automatically created by the system
| at boot time.
|
| PVC Configuration
|
| The PVC configuration file is read by the host system
| when it boots to automatically create the permanent
| virtual connections defined in it. The file can be edited
| by hand at a later time, or you can add connection
| definitions now.
+-----+
Do you want to continue? (default: y) [y,n]: y
```

**5** To create a PVC, you need to enter the hostname or IP address of the ATMworks 950L in the *other* end-station to which you are connecting.

```
+-----+
| PVC Connection Configuration
+-----+
The connection configuration file for this system is:
/etc/opt/DEC-Aruba/cfg/stingray
Hostname or ip address to which to create a connection: sword_atm1
```

**6** Next, you are prompted for the port number (instance number) of the ATMworks 950L. Press *<Enter>* to accept the default value, or enter a new port number.

```
Port number to use from 1 to 16?
(default:1) [1-16]: <Enter>
```

**7** Specify a VCI number for the connection. Remember that VCI 0-31 are reserved.

```
VCI to use from 32 to 1023? (default:32) [32-1023]: 32
```

**8** The next display provides some information about selecting the transmit rate for the connection.

From within this script, you can only specify “**max**” or an absolute rate. To specify requested and/or acceptable rates for this connection, you must edit the file after the script is complete.

If you want to specify an absolute rate, answer the prompt with “**n**”. You will be prompted for the rate.

```
The transmit rate is specified in units of megabits per second.
Instead of a numeric value, "max" can be specified to request
the entire available bandwidth. Note that the transmit rate
should match the receive rate for the host at the other end of
the connection.
```

```
Do you want to use the max available bandwidth for this connection?
(default: y) [y,n]: y
Transmit rate in Mbps? (default:1) [1-149]:
```

The next prompt will ask if you want the system to try for the “best effort” on the transmit rate.

```
Use best effort on transmit? (default: y) [y,n]: y
```

**9** Next, you must specify the receive rate for the connection. For receive, you can only specify an absolute rate (in megabits per second) or “**max**”. You are also asked whether or not to use best effort.

```
The receive rate is specified in units of megabits per second.
Instead of a numeric value, "max" can be specified to request
the entire available bandwidth. Note that the receive rate
should match the receive rate for the host at the other end of
the connection.
```

```
Do you want to use the max available bandwidth for this connection?
(default: y) [y,n]: y
```

```
Use best effort on receive? (default:y) [y,n]: y
```



- 10** When the connection configuration is complete, the information you have entered is displayed, and you are asked if you want to add this information to the PVC configuration file. If you wish to repeat steps 5-9, enter “**n**”. If you enter “**y**,” you will be prompted to configure another ATMworks 950L.

```
+-----+
| Configuration File Setup: Connection Information |
+-----+

Connect to:      sword_atml
VCI:             32
Port:           1
Transmit rate:   max best_effort
Receive rate:    max best_effort

Add this entry to the PVC config file? (default: y) [y,n]: y
Updating pvc configuration file...
Add another entry? (default: y) [y,n]: n
```

- 11** If you answer “**n**” to the last prompt, the main script menu is displayed. You can exit the script or refer to the procedures for configuring the other ATM functions listed.
-





## Troubleshooting

---

### Commonly Asked Questions

This chapter presents answers to some commonly asked questions about the ATMworks 950L hardware and software installation.

**Q:** **The system would not reboot after I installed the ATMworks 950L and turned it on.**

**A:** Reopen the system unit and check to see that the ATMworks 950L card is properly seated before trying to reboot the system again.

**Q:** **On Solaris, I tried to run the software installation procedure and it failed with the following messages:**

```
drvconfig: System call 'modctl_modconfig' failed: No
such device or address
Warning: Driver (ennmd) configuration failed.
System could not install the driver.
pkgadd: ERROR: class action script did not complete
successfully

Installation of <DEC-Aruba> failed.
```

**A:** You must install the ATMworks 950L hardware in the workstation *before* you install the ATMworks 950L driver software. Use the software removal procedure for your type of operating system, install the ATMworks 950L card, and attempt to install the software again.

**Q:** **I installed and configured the ATMworks 950L, and tried to reboot the workstation and it hung. It appears the Ethernet**

**port in the workstation quit working. I can't ping it and my NFS mounts no longer work.**

**A:** This indicates a problem with the way the netmask is set for the IP addresses you have assigned to the ATMworks 950L. Remove the card from the workstation and reboot it. If it comes up, it is probably the netmask setting. Be sure that the IP address you assigned to the ATMworks 950L is on a **completely different network** than the host network.

**Q:** **I have moved the ATMworks 950L card to another slot in the machine and now the instance numbers are out of sync. How do I reset them?**

**A:** In the Solaris OS, you can reset the slot positions by executing the script `/usr/dec/bin/en_reset_instance` and then rebooting the system. This script will clean up the `/etc/path_to_inst` file and allow the system to recognize the ATMworks 950L card in a different slot.

**Q:** **I tried to run dcm, and got the following response:**

```
walleye# /usr/dec/bin/dcm
dcm System Error : Connection refused
dcm:???:1>
```

**I also got a message on the system console saying:**

```
inetd[160]: decnmd/tcp: unknown service
```

**A:** This indicates that the yellow pages-type name service (NIS, NIS+, etc.) has not been updated properly. Check your Sun documentation for information on updating the `/etc/services` and `/etc/inetd.conf` files.



**When I installed the software in SunOS 4.1.3\_U1 or 4.1.4, I answered “no” to add more cdev entry points. When the system booted, I got this message:**

```
tiger login: Nov 20 12:25:07 tiger
decatminit.rc: decatminit:failed to open
/dev/decle:1 for plink to /dev/decatm:1
```

**I don't understand why decle is having problems when only deccip is configured.**



In SunOS, there are only three table entries provided for loadable device drivers. The ATMworks 950L drivers for **Aruba 3.2** require four table entries, and the last driver to be loaded is **decle**. When the installation was performed, the user said not to add more entry points. When the system was rebooted, the **decle** driver had no entry point allocated and the *plink* process failed to link the driver into the kernel.

This could also occur if the wrong kernel is booted. The full path name of the kernel must be entered during the installation, or the new kernel will be placed in the current working directory.

To correct this problem, re-install the package and add more device entry points. Then reboot the system.



**We installed the ATMworks 950L card and connected it to a switch. On reboot, we got the following messages:**

```
warning: decnico: I/O/38 Best effort
RX PCR 365566> 353208 ( link rate )
TX PCR 365566> 353208 ( link rate )
```



These messages are caused by other NICs asking for a PCR that is greater than the maximum PCR for an OC3 link. Check with the NIC manufacturer for the details on how to correct this problem.

Technically, this connection should not have been allowed. However, rather than risk network downtime, it was decided that a console warning would be printed to alert the user to

the problem. This problem/observation will happen on any machine and is not OS/machine related.

**Q:** **When I installed the ATMworks 950L card on a Sun 1000 server, I got the following message:**

```
/kernel/drv/decnic symbol_cg92_used multiply defined
```

**A:** This message is caused by the differences between Solaris 2.3 and 2.4. The Solaris 2.3 OS did not include SuperSPARC support, and Sun's SC-1000s only run Solaris 2.4. The `symbol_cg92_used` symbol was modified for operation in 2.3. This modification is not required under Solaris 2.4 and causes a warning to be printed. This will not cause any problem with the operation of the ATMworks 950L or its software in Solaris 2.3, 2.4, or 2.5.

# Hacker's Guide to *deconfig*

---

### Overview

This appendix provides a list of all of the files that are edited when you run **deconfig**. A user can also edit these files by hand without going through **deconfig**.

---

### Support Files

The following files are updated for any implementation of the software:

#### **/etc/hosts**

Maps IP addresses to IP hostnames for all hosts on the system.

#### **/usr/dec/cfg/atm\_hosts**

Maps hostnames to ATM addresses for all known ATM hosts on the system. This file can be modified manually to create a “generic” file that can be used on many of your ATM hosts. The network prefix in the ATM addresses can be changed to “+1+”. This allows the software to substitute the “+1+” with the current network prefix of the switch. Therefore, the same *atm\_hosts* file can be used on systems connected to different switches. See Appendix B, “Configuring an ATM-only Network,” for details.

An example of an *atm\_hosts* file that has two hosts configured with 16 LECs each is shown in Figure A-1. The shaded areas outline the network prefixes of the addresses that can be replaced with “+1+”. Figure A-1 shows the file after the network prefixes have been modified.

 **Note:** The “+1+” feature will not work correctly on Solaris 2.3 or 2.4 systems unless permissions are changed on the target of the symbolic link `/dev/decatm`. As the “root” user, issue the command:

```
chmod -R 666 /dev/decatm
```

**Figure A-1** Example of *atm\_hosts* file before editing

```
stingray_00      nsap 39-0000-00-000000-0000-0000-0000-00:20:ea:00:05:67-00
stingray_01      nsap 39-0000-00-000000-0000-0000-0000-00:20:ea:00:05:67-01
stingray_02      nsap 39-0000-00-000000-0000-0000-0000-00:20:ea:00:05:67-02
stingray_03      nsap 39-0000-00-000000-0000-0000-0000-00:20:ea:00:05:67-03
stingray_04      nsap 39-0000-00-000000-0000-0000-0000-00:20:ea:00:05:67-04
stingray_05      nsap 39-0000-00-000000-0000-0000-0000-00:20:ea:00:05:67-05
stingray_06      nsap 39-0000-00-000000-0000-0000-0000-00:20:ea:00:05:67-06
stingray_07      nsap 39-0000-00-000000-0000-0000-0000-00:20:ea:00:05:67-07
stingray_08      nsap 39-0000-00-000000-0000-0000-0000-00:20:ea:00:05:67-08
stingray_09      nsap 39-0000-00-000000-0000-0000-0000-00:20:ea:00:05:67-09
stingray_0a      nsap 39-0000-00-000000-0000-0000-0000-00:20:ea:00:05:67-0a
stingray_0b      nsap 39-0000-00-000000-0000-0000-0000-00:20:ea:00:05:67-0b
stingray_0c      nsap 39-0000-00-000000-0000-0000-0000-00:20:ea:00:05:67-0c
stingray_0d      nsap 39-0000-00-000000-0000-0000-0000-00:20:ea:00:05:67-0d
stingray_0e      nsap 39-0000-00-000000-0000-0000-0000-00:20:ea:00:05:67-0e
stingray_0f      nsap 39-0000-00-000000-0000-0000-0000-00:20:ea:00:05:67-0f
stingray_10      nsap 39-0000-00-000000-0000-0000-0000-00:20:ea:00:05:67-10

fried_00         nsap 39-0000-00-000000-0000-0000-0000-00:20:ea:00:05:6a-00
fried_01         nsap 39-0000-00-000000-0000-0000-0000-00:20:ea:00:05:6a-01
fried_02         nsap 39-0000-00-000000-0000-0000-0000-00:20:ea:00:05:6a-02
fried_03         nsap 39-0000-00-000000-0000-0000-0000-00:20:ea:00:05:6a-03
fried_04         nsap 39-0000-00-000000-0000-0000-0000-00:20:ea:00:05:6a-04
fried_05         nsap 39-0000-00-000000-0000-0000-0000-00:20:ea:00:05:6a-05
fried_06         nsap 39-0000-00-000000-0000-0000-0000-00:20:ea:00:05:6a-06
fried_07         nsap 39-0000-00-000000-0000-0000-0000-00:20:ea:00:05:6a-07
fried_08         nsap 39-0000-00-000000-0000-0000-0000-00:20:ea:00:05:6a-08
fried_09         nsap 39-0000-00-000000-0000-0000-0000-00:20:ea:00:05:6a-09
fried_0a         nsap 39-0000-00-000000-0000-0000-0000-00:20:ea:00:05:6a-0a
fried_0b         nsap 39-0000-00-000000-0000-0000-0000-00:20:ea:00:05:6a-0b
fried_0c         nsap 39-0000-00-000000-0000-0000-0000-00:20:ea:00:05:6a-0c
fried_0d         nsap 39-0000-00-000000-0000-0000-0000-00:20:ea:00:05:6a-0d
fried_0e         nsap 39-0000-00-000000-0000-0000-0000-00:20:ea:00:05:6a-0e
fried_0f         nsap 39-0000-00-000000-0000-0000-0000-00:20:ea:00:05:6a-0f
fried_10         nsap 39-0000-00-000000-0000-0000-0000-00:20:ea:00:05:6a-10
```

**+1+**



**Figure A-2** Example of *atm\_hosts* file using "+1+" notation

```
stringray_00      nsap +1+:20:ea:00:05:67-00
stringray_01      nsap +1+:20:ea:00:05:67-01
stringray_02      nsap +1+:20:ea:00:05:67-02
stringray_03      nsap +1+:20:ea:00:05:67-03
stringray_04      nsap +1+:20:ea:00:05:67-04
stringray_05      nsap +1+:20:ea:00:05:67-05
stringray_06      nsap +1+:20:ea:00:05:67-06
stringray_07      nsap +1+:20:ea:00:05:67-07
stringray_08      nsap +1+:20:ea:00:05:67-08
stringray_09      nsap +1+:20:ea:00:05:67-09
stringray_0a      nsap +1+:20:ea:00:05:67-0a
stringray_0b      nsap +1+:20:ea:00:05:67-0b
stringray_0c      nsap +1+:20:ea:00:05:67-0c
stringray_0d      nsap +1+:20:ea:00:05:67-0d
stringray_0e      nsap +1+:20:ea:00:05:67-0e
stringray_0f      nsap +1+:20:ea:00:05:67-0f
stringray_10      nsap +1+:20:ea:00:05:67-10

fried_00          nsap +1+:20:ea:00:05:6a-00
fried_01          nsap +1+:20:ea:00:05:6a-01
fried_02          nsap +1+:20:ea:00:05:6a-02
fried_03          nsap +1+:20:ea:00:05:6a-03
fried_04          nsap +1+:20:ea:00:05:6a-04
fried_05          nsap +1+:20:ea:00:05:6a-05
fried_06          nsap +1+:20:ea:00:05:6a-06
fried_07          nsap +1+:20:ea:00:05:6a-07
fried_08          nsap +1+:20:ea:00:05:6a-08
fried_09          nsap +1+:20:ea:00:05:6a-09
fried_0a          nsap +1+:20:ea:00:05:6a-0a
fried_0b          nsap +1+:20:ea:00:05:6a-0b
fried_0c          nsap +1+:20:ea:00:05:6a-0c
fried_0d          nsap +1+:20:ea:00:05:6a-0d
fried_0e          nsap +1+:20:ea:00:05:6a-0e
fried_0f          nsap +1+:20:ea:00:05:6a-0f
fried_10          nsap +1+:20:ea:00:05:6a-10
```

## LAN Emulation (LANE) Files

---

The base path for all LANE files is the installation directory (the default path is */usr/dec/cfg*). If the file name is followed by **<n>**, there may be multiple copies of the file in the configuration directory. The number of the file is the number of the associated LEC (for example, 101, 102, and so forth).

### **hostname.decle<n>**

Specifies the IP hostname of the LEC's LANE interface.

### **serverlecs.decle1**

Specifies the ATM hostname of the LECS. Only one file with this name will exist because LANE is only supported on the first ATMworks 950L installed.

### **serverles.decle<n>**

Specifies the ATM hostname of each LES that has been configured for LEC **<n>**.

### **pcr.decle<n>**

Specifies the Peak Cell Rate for LEC **<n>**. This is an integer from 1-100 that specifies a percentage of line rate.

### **vcctimeout.decle<n>**

Specifies the inactivity timeout for LEC **<n>**. Valid range is from 1-6000 seconds.

### **macaddr.decle<n>**

Specifies a 12-digit hexadecimal MAC address that has been configured for LEC **<n>**.

### **elaname.decle<n>**

Specifies an emulated LAN name for LEC **<n>**. The name consists of up to 32 printable ASCII characters.

## Classical IP (CIP) Files

---

These files are also in the installation directory (default: */usr/dec/cfg*). The number of the file **<n>** is the instance number of the associated ATMworks 950L (1-16).

### **hostname.deccip<n>**

Specifies the IP hostname of the ATMworks 950L's CIP interface.

### **server1577.deccip1**

Specifies the ATM hostname of the ATM ARP server.

### **pcr.deccip1**

Specifies the Peak Cell Rate for all CIP SVCs. This is an integer from 1-100 that specifies a percentage of line rate.

### **vcctimeout.deccip1**

Specifies the inactivity timeout for all CIP SVCs. Valid range is from 1-6000 seconds.



# Configuring an ATM-only Network

---

## Overview

If you want to configure an end-station and the network to allow ATM-only network interfaces, thus disabling the Ethernet interface, there are some configuration issues. The following sections describe particular configurations.

Note that the information that follows was gathered running on a system that had the configuration shown in Figure B-1.

**Figure B-1** ATM-Only System Configuration

The information provided in this appendix was gathered running on a system that had this configuration.

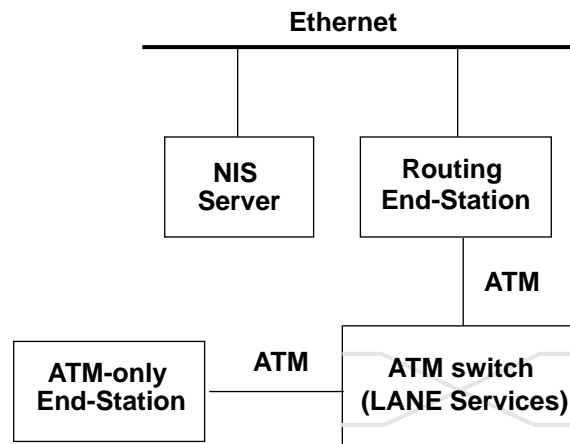

---

## Running LANE vs. CIP

Since CIP does not support broadcast, this can be a problem in an ATM-only environment that uses a service that relies on broadcast. In the normal mode, NIS relies on broadcast to locate an NIS server. Currently, ATM-only has not been tested with CIP.

LAN emulation, by contrast, takes more time to configure the interface at startup, which leads to a slower boot.

---

## Disabling the Ethernet Interface

You need to remove the file */etc/hostname.le0* to disable the Ethernet interface.

Also, the file */etc/defaultrouter* should be removed on the routing end-station.

On the ATM-only end-station, the */etc/defaultrouter* file should be present and should specify the ATM IP address of the routing end-station.

---

## Differences between Solaris and SunOS

In SunOS, the hostname for the end-station is set by the contents of the */etc/hostname.xx0* file (usually */etc/hostname.le0*).

If this file does not exist, the *rc* scripts then attempt to perform a reverse-ARP broadcast to find a hostname. This process will continue until a response is found. The system will not boot properly if no response is found.

In Solaris, the hostname is set by the contents of the file */etc/nodename*. With the proper modifications to the */etc/rc.boot* file for SunOS, a similar approach can be taken.

Create the file */etc/nodename* and place the hostname for the end-station within this file. Modify the **rc.boot** script to set the hostname from this file if the */etc/hostname.xx0* file does not exist and the end-station is not unconfigured.

---

## NIS Support

NIS normally requires an NIS server on the same subnet, since it relies on broadcast to find a server. If no NIS server can be located on the ATM-only network, then NIS can be configured to go directly to a specific NIS server host.

### **For Solaris:**

- 1 Use the command **ypinit -c** to configure the NIS client.
- 2 You will be prompted for a list of IP hostnames to use as possible NIS servers. Each NIS server that you specify must have an entry in the *etc/hosts* file.

**For SunOS:**

- 1 Modify the */etc/rc.local* file to run **ypbind** using the **ypsetme** switch.
- 2 Place the following command immediately after the **ypbind** command within the file:

```
ypset <NIS server>
```

replacing “*NIS server*” with the IP address for the desired NIS server.

- 3 Also, you should place the IP address in the */etc/hosts* file. If, after doing this, you cannot get the end-station to bind to an NIS server off the ATM subnet, then you will have to set up the routing host as an NIS slave server.

---

**NFS Support**

NFS support should be automatic. On SunOS, sometimes the automounter fails to start following a reboot. If this happens, just start the automounter by hand.

---

**SunOS Peculiarities**

On occasion, there will be a problem with SunOS locking up and failing, with the following message displayed:

```
rpc.lockd: Cannot contact status monitor!
```

This appears to be a problem induced when the hostname does not match any network interface names. For a fix, define the hostname of the machine as an alias to the ATM interface name within the */etc/hosts* file and the NIS maps.





---

## A

**AAL** – ATM Adaptation Layer: one of the three layers that make up the OSI model for ATM.

**AAL1** – Supports connection-oriented services that require constant bit rates.

**AAL2** – Supports connection-oriented services that do not require constant bit rates.

**AAL3/4** – Intended for both connection-oriented and connectionless variable bit rate services.

**AAL5** – Supports connection-oriented variable bit rates.

**ABR** – Available Bit Rate

**AFI** – Authority and Format Identifier: identifies the authority allocating the ATM address. Specified in the first octet of the ATM address.

**AIS** – Alarm Indication Signal (UNI Fault Management)

**AII** – Active Input Interface (Used in UNI PMD specs for Copper/Fiber)

**AMS** – Audiovisual Multimedia Service

**AOI** – Active Output Interface (Used in UNI PMD specs for Copper/Fiber)

**Area** – Part of a standard ATM Address that identifies a unique area within a Routing Domain.

**ARP** – Address Resolution Protocol

**ASN.1** – Abstract Syntax Notation One

**Asynchronous** – Signals that are sourced from independent clocks. These signals generally have no relation to each other and so have different frequencies and phase relationships. Compare to “plesiochronous” signals.

**ATE** – ATM Terminating Equipment (SONET)

**ATM** – Asynchronous Transfer Mode: a cell-relay based networking protocol.

**ATM Address** – A 20-byte address that uniquely identifies an ATM endpoint. Three formats are specified in UNI 3.0: DCC, ICD, and E.164.

---

## B

**BCD** – Binary Coded Decimal

**BECCN** – Backward Explicit Congestion Notification

**BER** – Basic Encoding Rules (ASN.1) or Bit Error Rate (link quality specification/testing)

**BIP** – Bit Interleaved Parity (e.g., SONET BIP-8 for path error monitoring)

**BIPV** – Bit Interleaved Parity Violation

**B-HLI** – Broadband High Layer Information

**B-ICI** – Broadband Intercarrier Interface

**B-ISDN** – Broadband Integrated Services Digital Network

**B-ISSI** – Broadband Inter-Switching System Interface

**B-LLI** – Broadband Low Layer Information

**BOM** – Beginning of Message

**BSS** – Broadband Switching System

**BUS** – Broadcast Unknown Server

---

## C

**CAC** – Connection Admission Control  
**CBR** – Constant Bit Rate  
**CDV** – Cell Delay Variation  
**CEI** – Connection Endpoint Identifier (UNI 3.0)  
**CES** – Circuit Emulation Service  
**CIP** – Classical IP: describes the typical LAN-based network paradigm where wires and local LAN segments connect IP end-stations and routers.  
**CIR** – Committed Information Rate  
**CLP** – Cell Loss Priority  
**CMISE** – Common Management Information Service Element  
**CNM** – Customer Network Management  
**CPCS** – Common Part Convergence Sublayer  
**CPE** – Customer Premise Equipment  
**CPI** – Common Part Indicator  
**CRF(VC)** – Virtual Channel Connection Related Function (related to UPC/UNI 3.0)  
**CRF(VP)** – Virtual Path Connection Related Function (related to UPC/UNI 3.0)  
**CRS** – Cell Relay Service  
**CS** – Convergence Sublayer (as in CS\_PDU)

---

## D – F

**DCC** – Data Country Code: a type of ATM Address format whose AFI is 39. The DCC is a two-octet field after the first octet in a DCC ATM address. The DCC is expressed in BCD and identifies the country in which an address is registered per ISO 3166.  
**DSX** – Digital Signal Cross-Connect  
**DXI** – Data Exchange Interface  
**E.164** – a type of ATM Address format whose AFI is 45. The E.164 field takes up eight octets

of an E.164 ATM address and is expressed in BCD and hex. This field specifies ISDN numbers, which include telephone numbers.

**EFCI** – Explicit Forward Congestion Indication  
**EOM** – End of Message  
**ESI** – End Station Identifier: a 6-octet field in the ATM Network Address that uniquely identifies an ATM endpoint within an Area in a Routing Domain.  
**FEA** – Functional Entity Action (UNI 3.0, C.3.2.3)  
**FEBE** – Far End Block Error (SONET)  
**FECN** – Forward Explicit Congestion Notification

---

## G – I

**GCRA** – Generic Cell Rate Algorithm  
**GFC** – Generic Flow Control  
**HEC** – Header Error Control  
**ICD** – International Code Designator: a type of ATM Address format whose AFI is 47. The ICD is a two-octet field following the AFI field in a DCC ATM address. This field, expressed in BCD, identifies an international organization registered by the British Standards Institute.  
**IETF** – Internet Engineering Task Force  
**ILMI** – Interim LAN Management Interface: currently implemented using SNMP.  
**IPX** – Internetwork Packet Exchange  
**Isochronous** – Signals which are dependent on some uniform timing or carry their own timing information embedded as part of the signal.

---

## L

**LAN** – Local Area Network  
**LCD** – Loss of Cell Delineation (also seen as OCD).

**LCT** – Last Compliance Time (used in GCRA definition)

**Leaky bucket** – A method of data traffic flow regulation using a buffer (bucket) and a regulator to present the data to the network at a specific rate.

**LEC** – LAN Emulation Client

**LES** – LAN Emulation Server

**LECS** – LAN Emulation Configuration Server

**LIS** – Logical IP Subnetwork: used to refer to an ATM network environment implemented using Classical IP and ARP.

**LLC Encapsulation** – Logical Link Control Encapsulation: a method of adding headers to AAL5 CPCS-PDUs to allow several protocols to be carried over the same VC. The header allows the receiver to identify the protocol of the routed or bridged PDU.

**LOF** – Loss of Frame (UNI Fault Management)

**LOP** – Loss of Pointer (UNI Fault Management)

**LOS** – Loss of Signal (UNI Fault Management)

**LTE** – Line Terminating Equipment (SONET)

---

## M – N

**MAC** – Media Access Control

**MBS** – Maximum Burst Size

**MID** – Message Identifier

**MTU** – Maximum Transmission Unit: maximum allowable size of a PDU on an ATM network. The MTU size for IP stations operating over ATM is 9180 octets. With an LLC/SNAP header (8 octets), the default ATM AAL5 PDU size is 9188 octets.

**NBMA**– Non-Broadcast Multiple Access

**NEXT**– Near End Crosstalk (adverse phenomenon associated with high frequencies over twisted-pair wiring, measured in decibels)

**NIU** – Network Interface Unit

**NLPID** – Network Layer Protocol Identifier

**NMS**– Network Management Station

**NNI** – Network Node Interface

**NSAPA** – Network Service Access Point Address: OSI address format used as the model for the ATM Address defined in UNI 3.0.

---

## O – R

**OAM** – Operations and Management

**OCD** – Out-of-Cell Delineation (UNI 3.0 Section 2.1.2.2.2)

**ODI** – Open Data-link Interface (Novell)

**PCR** – Peak Cell Rate (UNI 3.0)

**PDU** – Protocol Data Unit: the common term for the frames sent in frame-relay networking protocols.

**PLCP** – Physical Layer Convergence Procedure/Protocol

**PL-OU** – Physical Layer Overhead Unit (UNI physical layer frame definition)

**PMD** – Physical Media Dependent

**PMP** – Point to MultiPoint (UNI 3.0)

**POH** – Path Overhead (SONET)

**POI** – Path Overhead Indicator

**PTE** – Path Terminating Equipment (SONET)

**PTI** – Payload Type Identifier

**PVC** – Permanent Virtual Connection

**QoS** – Quality of Service

**RDI** – Remote Defect Indicator (UNI Fault Management)

**RIP** – Routing Information Protocol

---

## S

**SAAL** – Signalling ATM Adaptation Layer  
**SAR** – Segmentation and Reassembly (as in SAR\_PDU)  
**SCR** – Sustainable Cell Rate (UNI 3.0)  
**SDH** – Synchronous Digital Hierarchy  
**SDU** – Service Data Unit (as in AAL\_SDU)  
**SEAL** – Simple and Efficient Adaptation Layer  
**SECB** – Severely Errored Cell Block  
**Selector** – The last octet of the ATM Address (currently undefined in the UNI 3.0 specification).  
**SIR** – Sustained Information Rate  
**SMDS** – Switched Multi-Megabit Data Service  
**SNAP** – SubNetwork Attachment Point (see IEEE 802.1a)  
**SNMP** – Simple Network Management Protocol  
**SONET** – Synchronous Optical Network  
**SSCF** – Service Specific Coordination Function  
**SSCS** – Service Specific Convergence Sublayer  
**SSCOP** – Service Specific Connection Oriented Protocol  
**STE** – Section Terminating Equipment (SONET)  
**SVC** – Switched Virtual Connection  
**Synchronous** – Signals that are sourced from the same timing reference. These may have the same frequency.

---

## T

**TAT** – Theoretical Arrival Time (used in GCRA definition)  
**TAXI** – Transparent asynchronous

transmitter/receiver interface

**TC** – Transmission Convergence

**Traffic shaping** – forcing data traffic to conform to a certain specified behavior. Usually this is a worst case or worst case plus average rate.

**TUC** – Total User Cell count

**TUCD** – Total User Cell Difference

**UME** – UNI Management Entity (used in ILMI definition)

**UNI** – User-Network Interface

**UPC** – Usage Parameter Control

---

## V

**VBR** – Variable Bit Rate

**VC** – Virtual Channel

**VCC** – Virtual Channel Connection

**VCI** – Virtual Channel Identifier

**VCL** – Virtual Channel Link (UNI 3.0)

**VINCE** – Vendor Independent Network Control Entity

**VP** – Virtual Path

**VPC** – Virtual Path Connection

**VPI** – Virtual Path Identifier

**VPCI** – Virtual Path Connection Identifier

**VPL** – Virtual Path Link (UNI 3.0)

**VPT** – Virtual Path Terminator (UNI 3.0)

---

## W

**well-known address** – ATM address that is commonly used for a LAN Emulation Configuration Server (LECS):

47-0079:0000:0000:0000:0000-00a  
0:3e00:0001-00

---

## A

acceptable rate  
  detailed description, 61  
  valid range, 61

address registration, 63

addresses  
  defining IP for ATM, 57  
  netmask, 58

ASIC chip  
  functionality, 14, 15

ATM Adaptation Layer 5 (AAL5)  
  implementation, 14

ATM address  
  ATM ARP server, 89, 96  
  copying from a shell window, 66  
  copying from DCM display, 98  
  in ILMI address registration, 63  
  LAN Emulation Configuration Server, 82  
  LAN Emulation Server, 82  
  specifying when ILMI is disabled, 65  
  well-known, 82

ATM ARP server  
  ATM address, 89, 96  
  configuration, 95, 96

ATM Forum vs. IETF, 55

ATM works 950L  
  cabling, 25

atm\_hosts file, 111  
  +1+ notation, 111

ATM-only network, 117

ATMworks 950L  
  connectors, 25  
  description, 14  
  hardware installation procedure, 21  
  inspection procedure, 17  
  LED, 16  
  moving to new slot, 36  
  picture of, 14  
  pinout, 26

  software description, 18  
  software package removal, 37, 47  
  specifications, 27, 28  
  supported features, 15  
  unpacking information, 16

ATMworks 950L CAT5  
  description, 16  
  frequency, 28  
  operating distance, 28  
  operating temperature, 28  
  power requirements, 28

ATMworks 950L MMF  
  description, 15  
  fiber specifications, 27  
  frequency, 27  
  mean launched power, 27  
  operating distance, 27  
  operating temperature, 27  
  power requirements, 27  
  sensitivity, 27

---

## B

best effort  
  configuring for a connection, 104  
  definition, 60  
  use in overbooking, 60

---

## C

cables  
  optical, 25

Cautions  
  inactivity timeout and ARP server, 98  
  installing drivers with no ATMworks  
  950L installed, 33, 43  
  leaving power cord connected, 21  
  mandatory Solaris OS patches, 32  
  remove software before reinstalling, 29,  
  39  
  remove software before upgrading, 30

- removing protective cover, 22
- signalling restarts when ILMI disabled, 65
- use of anti-static grounding strap, 19

Classical IP (CIP)

- configuration files, 115
- disabling support, 94
- enabling support, 90

commands, decdiag

- atm\_external, 53
- help, 51
- sar\_mem\_e, 52
- selftest, 52

commands, UNIX

- /etc/opt/dec/bin/dec\_reset\_instance, 36, 108
- decdiag, 50
- init, 20
- install\_pkg, 41
- pkgadd, 30
- shutdown, 20
- uninstall\_pkg, 47

configuration

- ATM address, 66, 69
- ATM ARP Server, 95
- Classical IP (CIP), 89
- DCM security feature, 71
- global issues, 62
- ILMI, 63
- LAN Emulation, 76, 81
- signalling, 67
- subnet mask, 58
- UNI implementation, 70

---

## D

- data transmission rates
  - acceptable, 61
  - description, 59
  - requested, 61
- DCM security, 71
- deconfig command
  - description box on menu, 64
  - files updated, 111
- decdiag command, 50
- diagnostics
  - LED status on ATMworks 950L, 16
  - testing ATMworks 950L functionality, 49
- dust protecting caps, 25

---

## E

- elaname.decle file, 114
- Emulated LAN (ELAN) name
  - configuring, 80
- error messages
  - out of range, 61

---

## F

files used by deconfig

- /etc/hosts, 111
- /usr/dec/cfg/atm\_hosts, 111
- /usr/dec/cfg/elaname.decle, 114
- /usr/dec/cfg/hostname.deccip, 115
- /usr/dec/cfg/hostname.decle, 114
- /usr/dec/cfg/macaddr.decle, 114
- /usr/dec/cfg/pcr.deccip1, 115
- /usr/dec/cfg/pcr.decle, 114
- /usr/dec/cfg/server1577.deccip1, 115
- /usr/dec/cfg/serverlecs.decle1, 114
- /usr/dec/cfg/serverles.decle, 114
- /usr/dec/cfg/vcctimeout.deccip1, 115
- /usr/dec/cfg/vcctimeout.decle, 114

frequency

- ATMworks 950L CAT5, 28
- ATMworks 950L MMF, 27

---

## H

- hardware overview, 15
- hostname
  - definition, 11
- hostname.deccip file, 115
- hostname.decle file, 114
- hosts file, 57, 111

---

## I

- inactivity timeout
  - definition, 80, 96
- install\_pkg command, 41
- installation
  - ATMworks 950L hardware, 21

- directory - Solaris, 32
- directory - SunOS, 42
- memory requirements, 29, 39
- restoring original configuration, 38
- system shutdown procedure, 20
- workstations supported, 19

Interim LAN Management Interface (ILMI), 62

- configuration, 64
- enabling/disabling, 64

Internet Protocol (IP)  
defining addresses, 57

---

## L

LAN Emulation (LANE)  
configuration files, 114  
defined, 73

LAN Emulation Client (LEC)  
defined, 73  
modifying configuration, 81  
removing, 85

LAN Emulation Configuration Server (LECS)  
ATM address, 82  
removing, 87  
setting address, 82

LAN Emulation Server (LES)  
ATM address, 82  
configuring name and address, 80  
removing address, 88

loopback cable  
use in ATMworks 950L testing, 53

---

## M

macaddr.decle file, 114

manual pages  
installing, 33, 43  
list of, 13

max rate  
configuring for a connection, 104  
definition, 60

Media Access Control (MAC) layer, 73  
configuring address, 80

---

## N

network prefix  
setting, 66, 69

nodename  
definition, 11

---

## O

operating distance  
ATMworks 950L CAT5, 28  
ATMworks 950L MMF, 27

operating temperature  
ATMworks 950L CAT5, 28  
ATMworks 950L MMF, 27

optical cables  
connecting to ATMworks 950L, 25  
protecting, 25

overbooking, 60

---

## P

patch numbers  
Solaris, 29  
SunOS, 39

pcr.deccip1 file, 115

pcr.decle file, 114

Peak Cell Rate (PCR)  
configuring, 80, 96  
definition, 59

Permanent Virtual Connection (PVC)  
choosing data rates, 60  
configuring, 60, 102

physical layer, 16

pinout diagram, 26

pkgadd command, 30

pkgrm command, 37  
leftover files, 38

platforms supported, 19

policing, traffic, 59

power requirements  
ATMworks 950L CAT5, 28  
ATMworks 950L MMF, 27

procedures  
8mm tape load, 31, 40  
ATM ARP server configuration, 96  
ATMworks 950L inspection, 17

- ATMworks 950L installation, 21
- ATMworks 950L software removal, 37, 47
- CIP address configuration, 90
- CIP support disabling, 94
- custom LECS removal, 87
- DCM security enable/disable, 72
- ILMI enable/disable, 64
- initial test of ATMworks 950L functionality, 49
- LAN Emulation configuration, 76
- LEC configuration modification, 81
- LEC removal, 85
- LECS address configuration, 82
- LES address removal, 88
- PVC configuration, 102
- signalling configuration, 68
- Solaris software installation, 32
- SunOS software installation, 42
- system power-up, 24
- system shutdown, 20
- UNI implementation, 71

PVC Configuration file, 100, 101

---

## R

- rate control, 60
- receive rate
  - specifying, 104
- related documents, 12
- requested rate
  - detailed description, 61
  - valid range, 61
- restoring system to original configuration, 38
- RJ45
  - connector, 26
  - jack, 26

---

## S

- SC connectors
  - duplex, 25
  - simplex, 25
- SDH
  - defined, 16
- server1577.deccip1 file, 115
- serverlecs.decle1 file, 114

- serverles.decle file, 114
- software installation
  - Solaris, 29
  - SunOS, 39
- software overview, 18
- SONET
  - defined, 16
- SPARCstations supported, 19
- specifications
  - ATMworks 950L CAT5, 28
  - ATMworks 950L MMF, 27
- STS physical transport, 16
- subnet mask
  - definition, 58
  - examples, 58, 59
- subnetting
  - definition, 58
- Switched Virtual Connection (SVC)
  - configuring, 59
- system power-up procedure, 24
- system shutdown procedure, 20

---

## T

- terminology, 11
- traffic shaping, 59, 60
- transmit rate
  - acceptable, 61
  - out of range message, 61
  - requested, 61
  - specifying, 104
- troubleshooting
  - connection refused message, 108
  - console warning message, 109
  - driver software install failed, 107
  - Ethernet disappeared after install, 108
  - moved ATMworks 950L to new slot, 108
  - plink failed on LAN emulation driver, 109
  - symbol\_cg92\_used message, 110
  - system doesn't boot after ATMworks 950L installation, 24, 107
  - unknown service message, 108

---

## U



UNI 3.0 vs. 3.1, 70  
uninstall\_pkg command, 47  
Usage Parameter Control (UPC), 59

---

## V

vcctimeout.deccip1 file, 115  
vcctimeout.decle file, 114  
Virtual Channel Connection (VCC)  
  definition, 100  
Virtual Channel Identifier (VCI)  
  valid range, 101  
Virtual Path Identifier (VPI), 101

---

## W

Warnings  
  opening system unit, 21  
well-known ATM address, 82  
workstation types supported, 19

