



DEChub 900 MultiSwitch Power Distribution Assembly Upgrade Kit January 1996

Upgrade Kit

Quick Start Overview

This section provides an overview of the upgrade procedure for the DEChub 900 MultiSwitch™. You perform the following steps:

1. Note the options and DMHUB settings for HUBwatch, if applicable.
2. Power down the hub to save current settings. (This includes removing the power cord and the rackmount brackets, if applicable.)
3. Remove the options, if applicable, from the hub noting their exact positions (slots) for future reference.
4. Place the hub face down on a table or other flat surface, and remove the cover.
5. Remove the modules -- secretariat, matrix, and power distribution assembly, according to the instructions in this document.
6. Install the upgrade kit (EK-DH2MS-RE) and the boards.
7. Reinstall the hub on a wall or in a rack.
8. Replace the options in their exact positions (slots) from which they were removed. (This ensures that all previous settings are restored.)
9. Apply power to the hub by reinstalling the power cord.
10. Check the options and DMHUB settings using HUBwatch, if applicable.

DEChub 900 MultiSwitch Power Distribution Assembly Upgrade Kit

The following sections of this document explain how to upgrade the DEChub 900 MultiSwitch with proper power distribution assembly, option number, 70-30820-01.

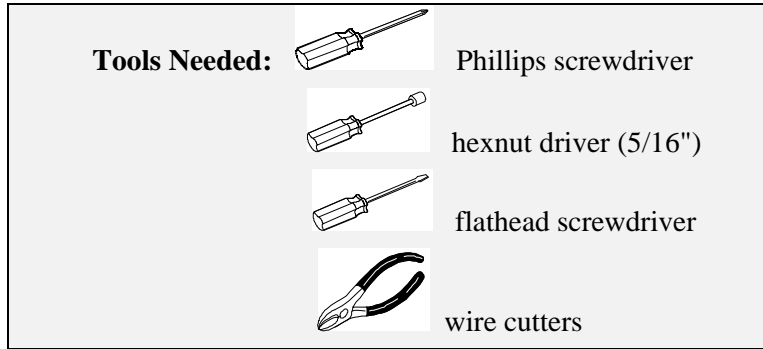

Note

An ESD wrist strap is recommended for this procedure.

Contents of Upgrade Kit

Before you begin the installation, check the contents of the upgrade kit. The following items are included as part of your upgrade kit.

Quantity	Item Number	Item Description
1	70-30820-01	Power distribution assembly
2	90-09771-05	Cable clamp U-clips
1	90-07031-01	Cable tie wrap

Installation of Upgrade Kit

To install your upgrade kit, proceed as follows:

Step	Action
1	Power down the DEChub 900 MultiSwitch chassis (1) to retain the settings.
2	After you remove the options and the power cord, place the chassis (1) face down on a flat surface.
3	If the chassis has rackmount brackets, remove them.
4	Remove the twelve screws attached to the back cover, then remove it (2).

Figure 1 Removing the Cover

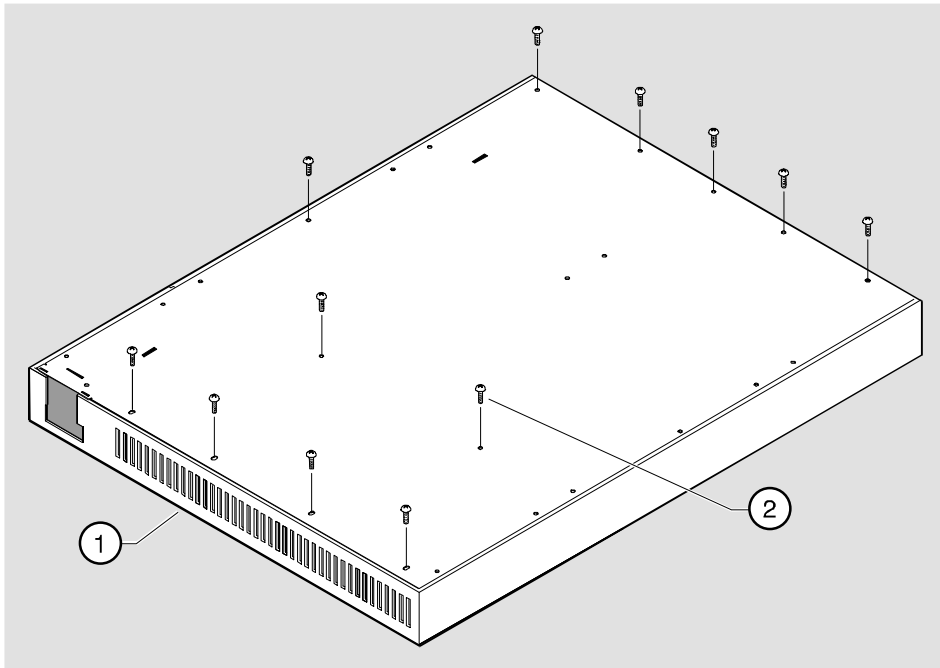

NPG-0304-95F

DEChub 900 MultiSwitch Power Distribution Assembly Upgrade Kit

Step	Action
5	Remove the cable (3) (17-03618-01) attached to the power distribution assembly (4) and to the secretariat module (5) (54-22347-01) by pushing the tabs outward.
6	Remove the cable connector (6) attached to the power distribution assembly (4) by pushing the tab and pulling the mating connector upward.
7	Remove the cable connector (7) attached to the secretariat module (5) by pushing the tab and pulling the mating connector upward.
8	Cut the cable tie wrap (8), and set the cable aside.
9	Remove the three hexnuts (9) attached to the power distribution assembly (4).

Figure 2 Removing Cables, Connectors, and Hexnuts

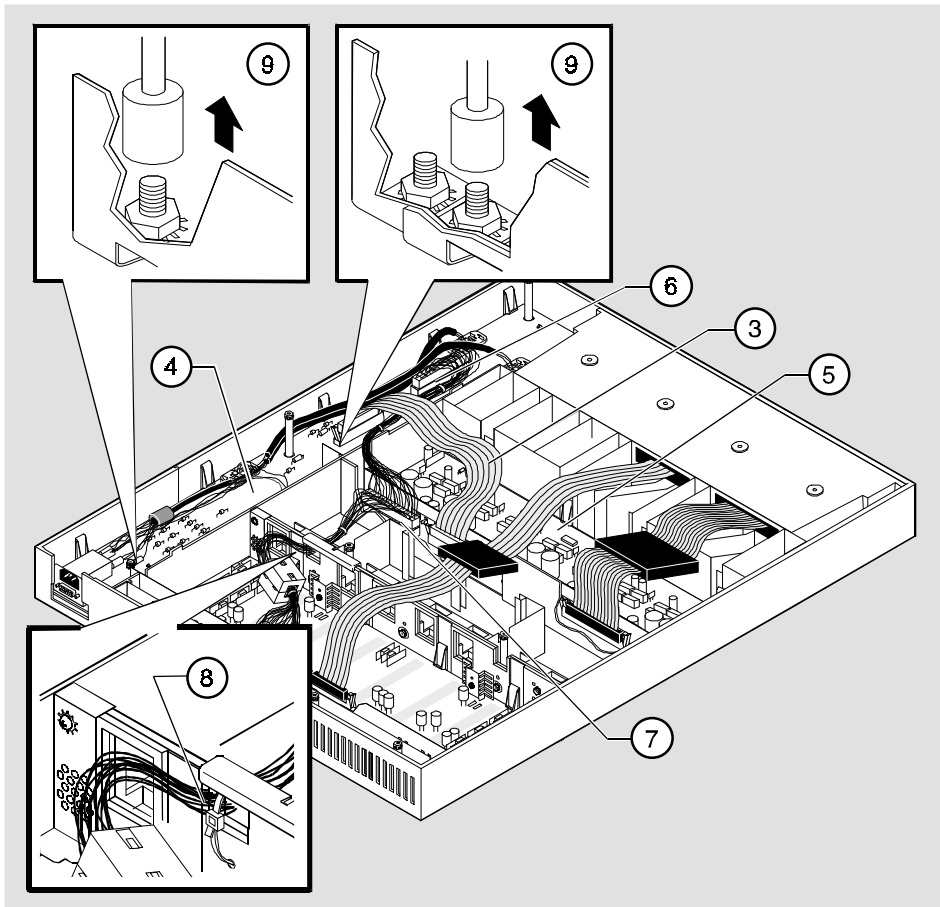

NPG-0361-95F

DEChub 900 MultiSwitch Power Distribution Assembly Upgrade Kit

Step	Action
10	Remove the cable connector (10) (17-03736-02) attached to the matrix module (11) (54-21469-01) by pushing both side tabs outward.

Figure 3 Removing the Cable from the Matrix Module

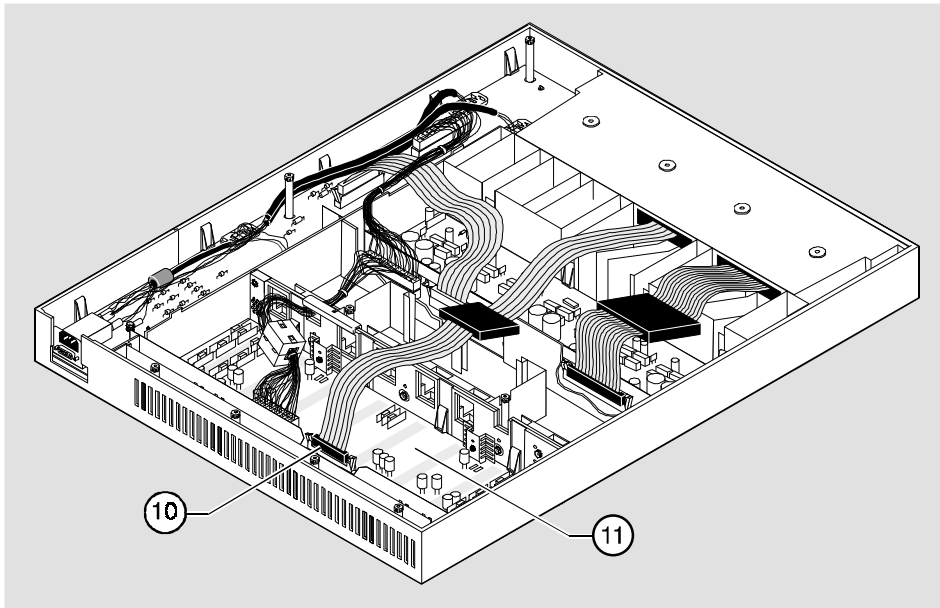

NPG-0362-95F

DEChub 900 MultiSwitch Power Distribution Assembly Upgrade Kit

Step	Action
11	Remove the cable connector (12) (17-02295-03) on the secretariat module (13) by pushing both side tabs outward.
12	Remove the secretariat module (13) by pushing on the tabs (14) with a flathead screwdriver (15) while simultaneously pulling the bus bar (16) upward. (You could also push on the connectors on the face (front) of the hub to remove the secretariat module.) Set the secretariat module aside.
13	Remove the matrix module (17) by pushing on the tabs (18) with a flathead screwdriver (19) while simultaneously pulling the bus bar (20) upward. (You could also push on the connectors on the face (front) of the hub to remove the matrix module.) Set the matrix module aside.

Figure 4 Removing the Secretariat and Matrix Modules

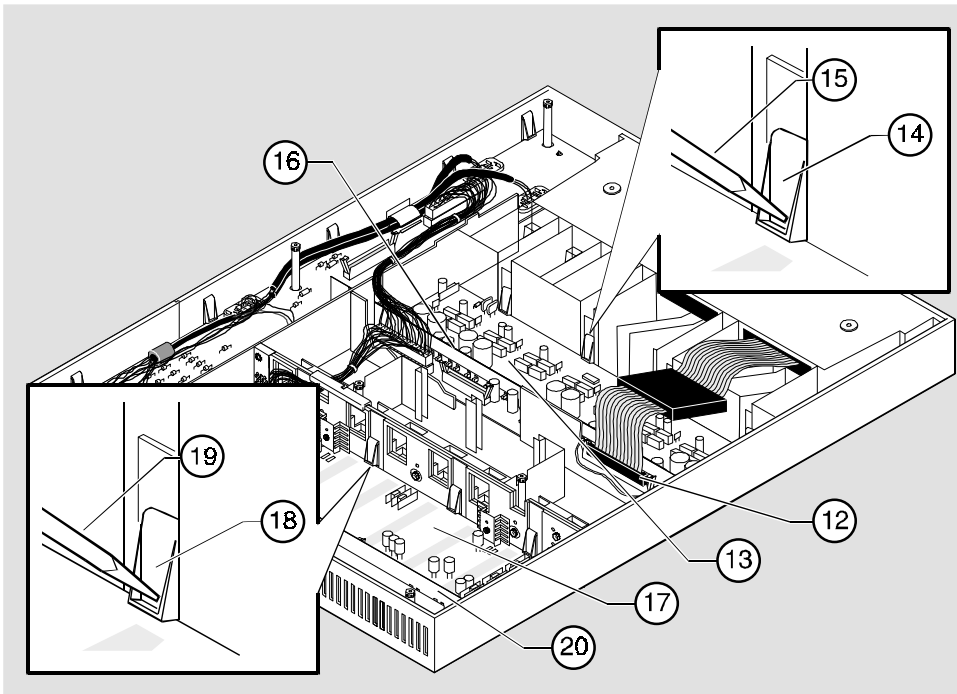

NPG-0363-95F

DEChub 900 MultiSwitch Power Distribution Assembly Upgrade Kit

Step	Action
14	Remove the cable-holder clamp U-clips (21) by using a flathead screwdriver (22).
15	Remove the power distribution assembly (23). Push on the connectors (24) on the face of the hub, while using a flathead screwdriver (25) to push on the tabs (26). Set the power distribution assembly aside.

Figure 5 Removing the Power Distribution Assembly

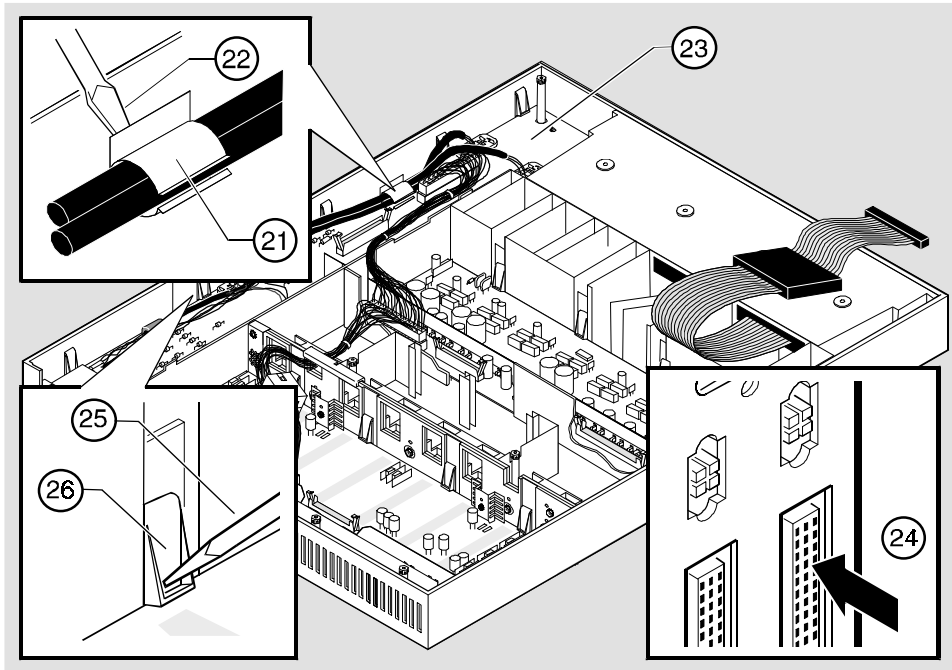

NPG-0364-95F

DEChub 900 MultiSwitch Power Distribution Assembly Upgrade Kit

Step	Action
16	Insert the replacement power distribution assembly into the hub by pushing down on the power distribution assembly (27) until it is secured by all tabs (28) .
17	Place the new cable-holder clamp U-clips (29) on both sides of the ribs by pressing against the outer side of the hub and the inner wall.
18	Place the two black cables (30) between the boss (31) and the side of the hub (32) and through the cable-holder clamp U-clips (29).

Figure 6 Reinstalling the Power Distribution Assembly into the Hub

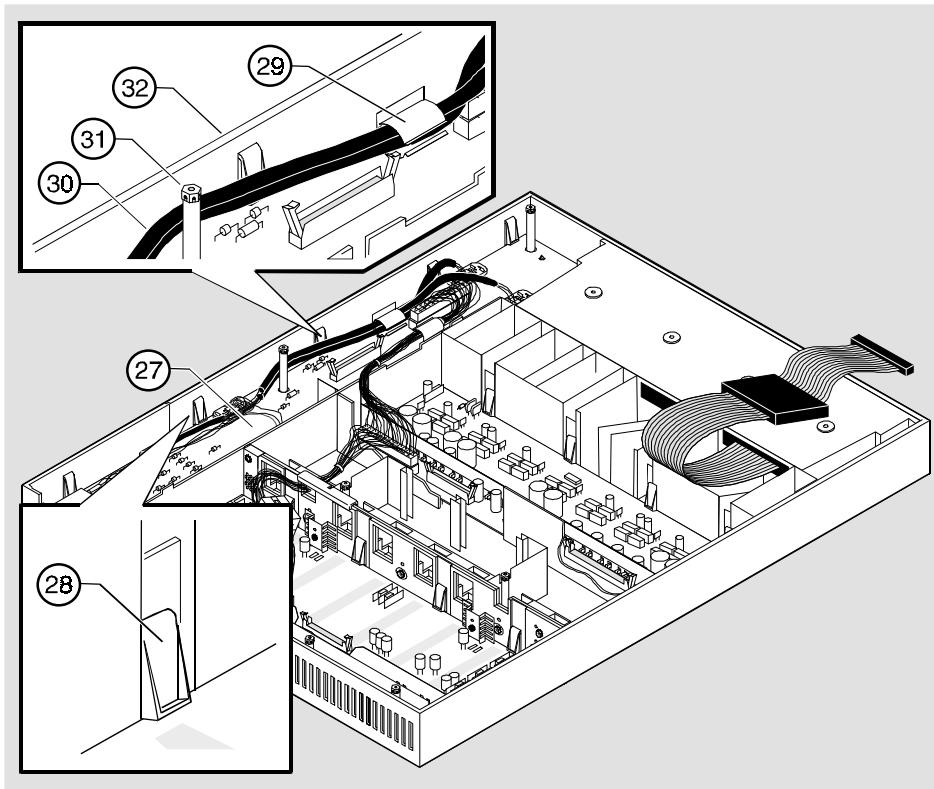

NPG-0365-95F

DEChub 900 MultiSwitch Power Distribution Assembly Upgrade Kit

Step	Action
19	Insert the matrix module (33) back into the hub and push down on the matrix module while slightly holding up the hub. Ensure that all tabs are secured.
20	Insert the secretariat module (34) back into the hub and push down on the secretariat module to ensure that it is secure.
21	Replace the three hexnuts (35) into the power distribution assembly (36) using a hexnut driver.

Figure 7 Reinstalling the Matrix and Secretariat Modules into the Hub

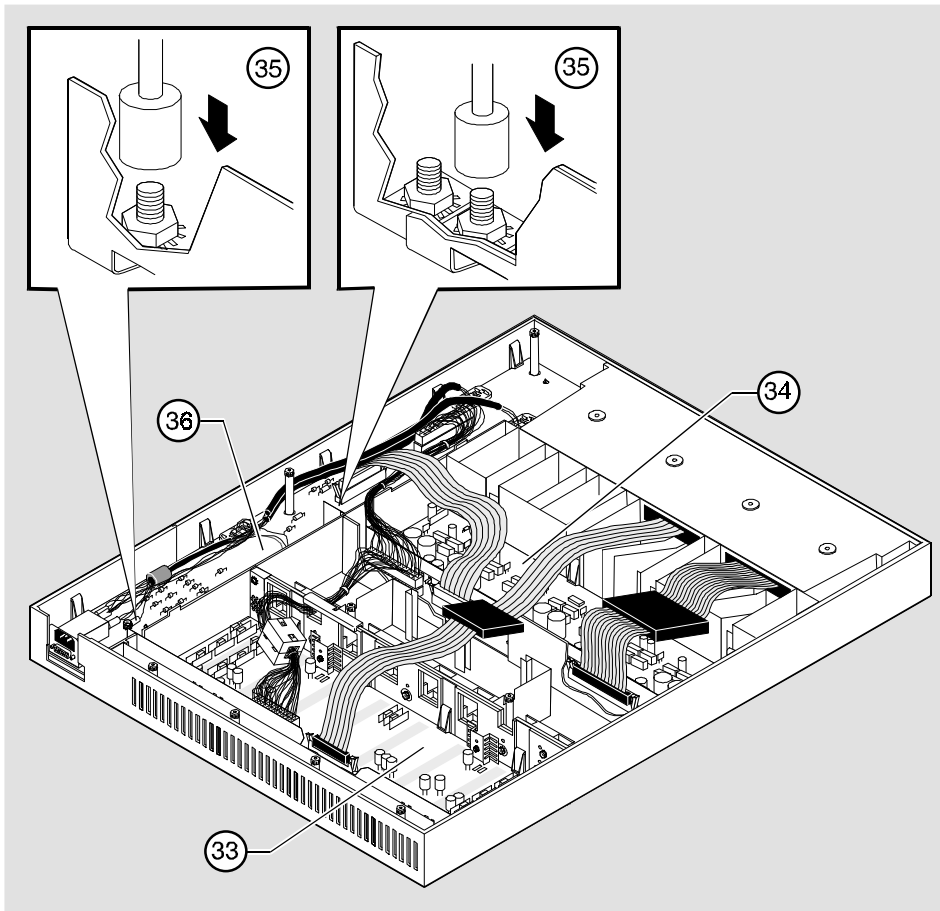

NPG-0366-85F

DEChub 900 MultiSwitch Power Distribution Assembly Upgrade Kit

Step	Action
22	<p>Reattach all cables that were removed during the procedure as follows:</p> <ol style="list-style-type: none">Attach the two connectors (37) on cable (38) (17-03619-01) to the power distribution assembly (39) and to the secretariat module (40).Insert the cable tie-wrap (41) through the hole and fasten the cable tie wrap around the cable.Put cable (38) (17-03619-01) through the cable-holder clamp U-clips (42) and through the opening on the vertical rib (43).Place cable (44) (17-03618-01) over the notch (45) on the vertical rib on the hub in the secretariat module (40).Place cable (46) (17-03736-02) in the opening (47) in the center of the hub.Attach cable (48) (17-02295-03) to the secretariat module (40).

Figure 8 Reinstalling Cables and Connectors

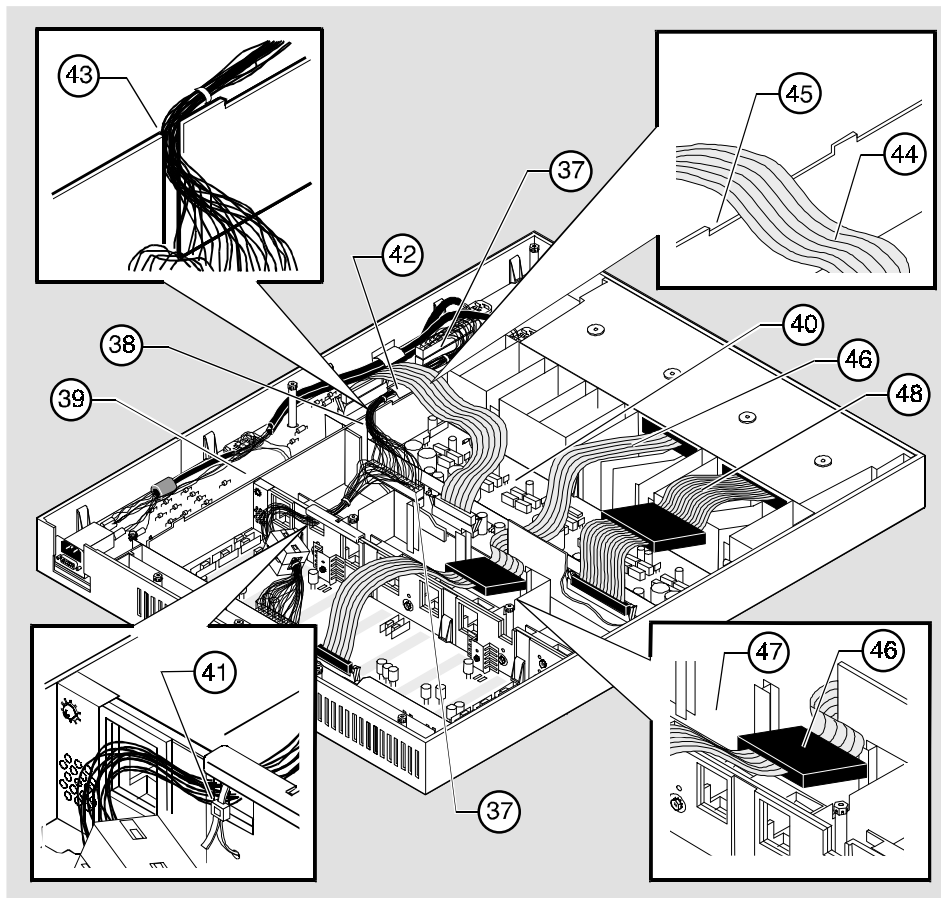

NPG-0367-95F

DEChub 900 MultiSwitch Power Distribution Assembly Upgrade Kit

Step	Action
23	Refer to the DEChub 900 MultiSwitch Upgrade Kit (EK-DH2MS-UP) for the following instructions: a. Installing the stiffeners and a clamp. b. Replacing the back cover.

DEChub 900 MultiSwitch Power Distribution Assembly Upgrade Kit

©Digital Equipment Corporation 1996. All rights reserved. Printed in U.S.A.
DEChub, HUBwatch, MultiSwitch, and the DIGITAL logo are trademarks of Digital Equipment Corporation..