

Print Colour and
staple here.

Electric

GOLDEN EGGS Colour

Visual Configurations

Rev: 05-Apr-2001

Main index for the next 92 pages:

New --> - Compaq OpenSAN

- AlphaServer family DS10L..ES40..GS320
- AlphaServer DS10L Unix, OpenVMS and Linux
- AlphaServer DS10 Unix, OpenVMS and Linux
- AlphaServer DS20E Unix, OpenVMS, and Linux
- AlphaServer ES40 Unix, OpenVMS, and Linux

Upd --> - AlphaServer GS80 Unix, OpenVMS

- AlphaServer GS160 Unix, OpenVMS
- AlphaServer GS320 Unix, OpenVMS

- StorageWorks EMA12000
- StorageWorks EMA16000

New --> - StorageWorks Tape Libraries

- GE-KEY, GE-Software, GE in Internet

New/Updated since
14-Feb-2001

More GE-pages are at:
www.compaq.com/golden-eggs

For details, call:
Matti.Patari@compaq.com

Painted with GOLDEN EGGS Software,
Rev: 05-Apr-2001

COMPAQ	05-Apr-2001	GEG00D2
	Matti.Patari@Compaq.com	

GOLDEN EGGS in eBusiness since 1988 13 years.

Electric

Electric GOLDEN EGGS, Colour
GOLDEN EGGS Visuals, Helsinki

Compaq OpenSAN

Ethernet

SCSI terms:
 LVD Low Voltage Differential
 HVD High Voltage Differential
 VHDCI Very High Density Cable Interconnect
 68HD 68 pin High Density

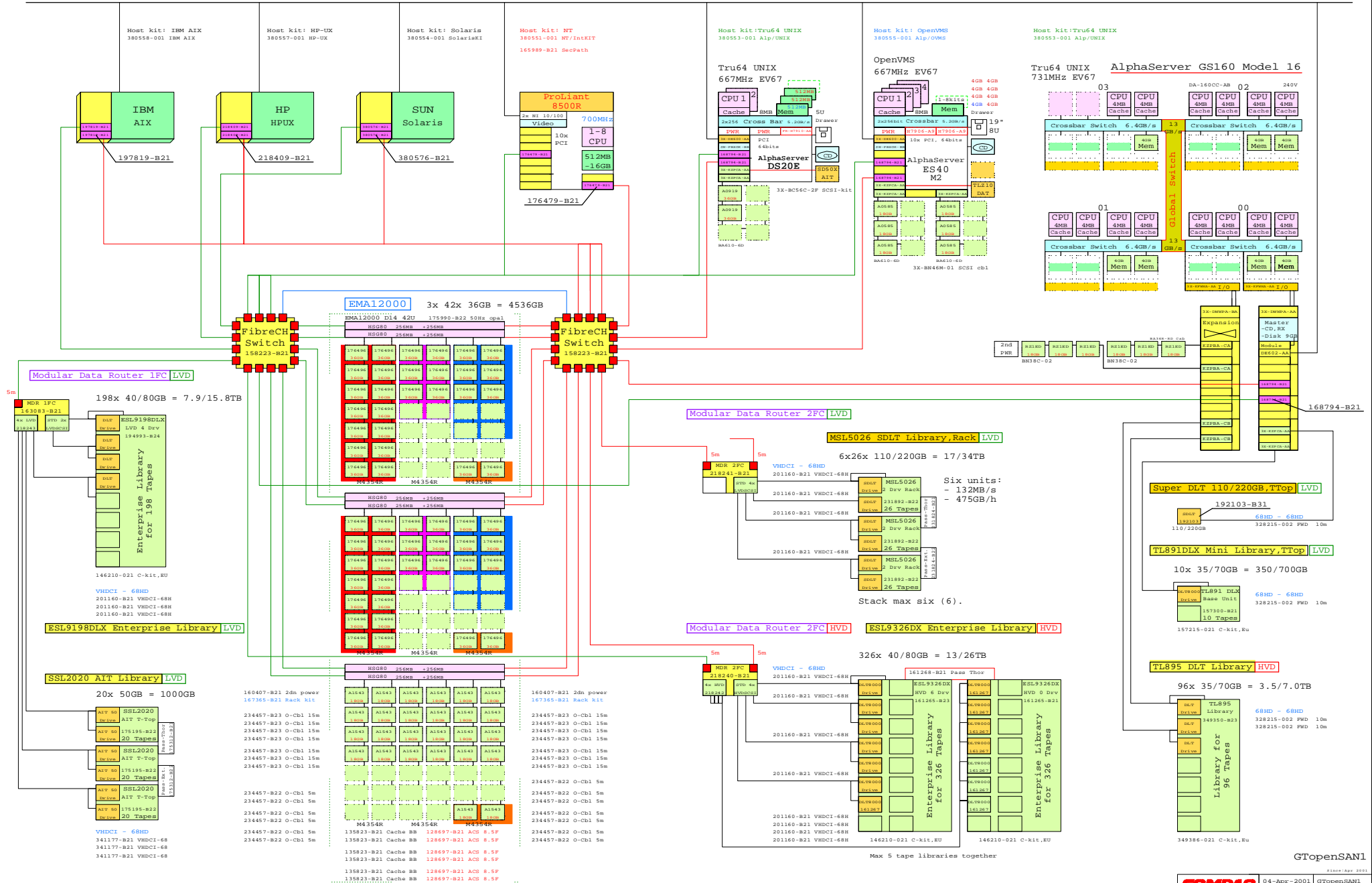

OpensAN

SCSI terms:
 LVD Low Voltage Differential
 HVD High Voltage Differential
 VHDCI Very High Density Cable Interconnect
 68HD 68 Pin High Density

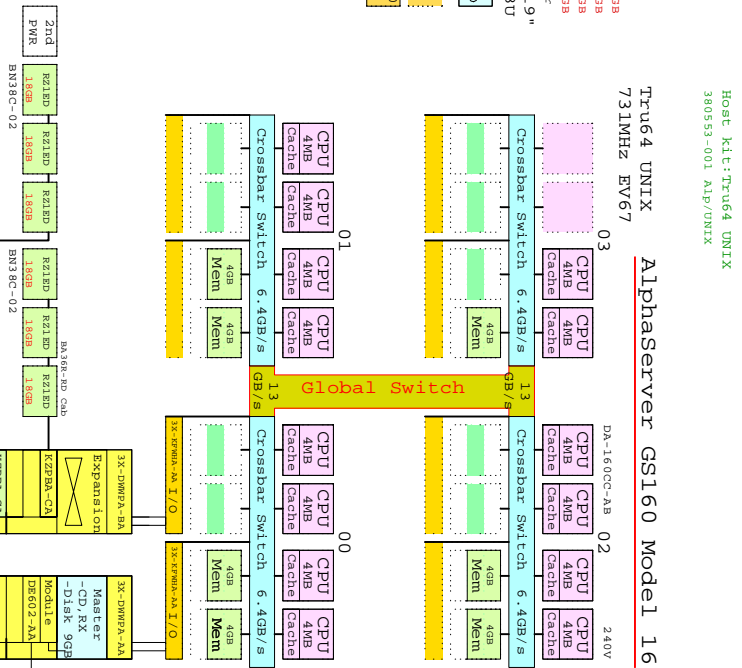
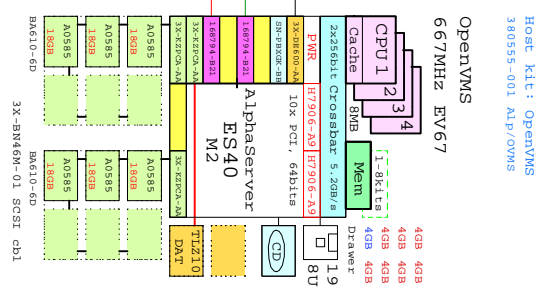
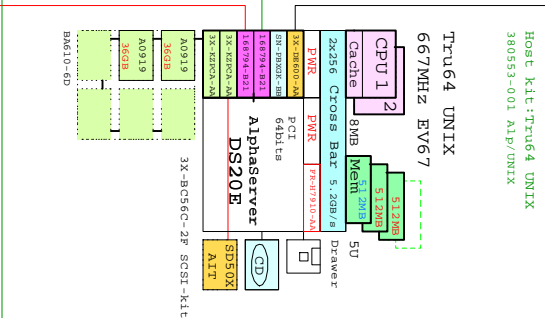

Modular Data Router 2FCI LVD

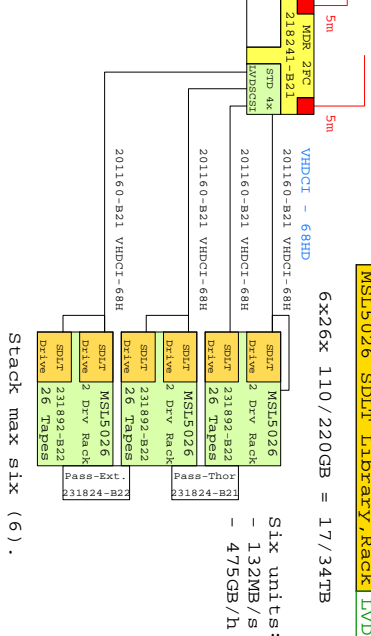

Modular Data Router 2FCI HVD

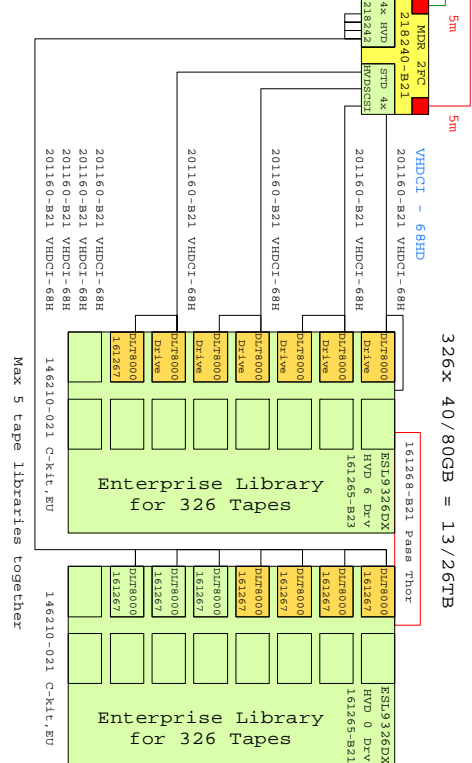

Tru64 UNIX AlphaServer GS160 Model 16

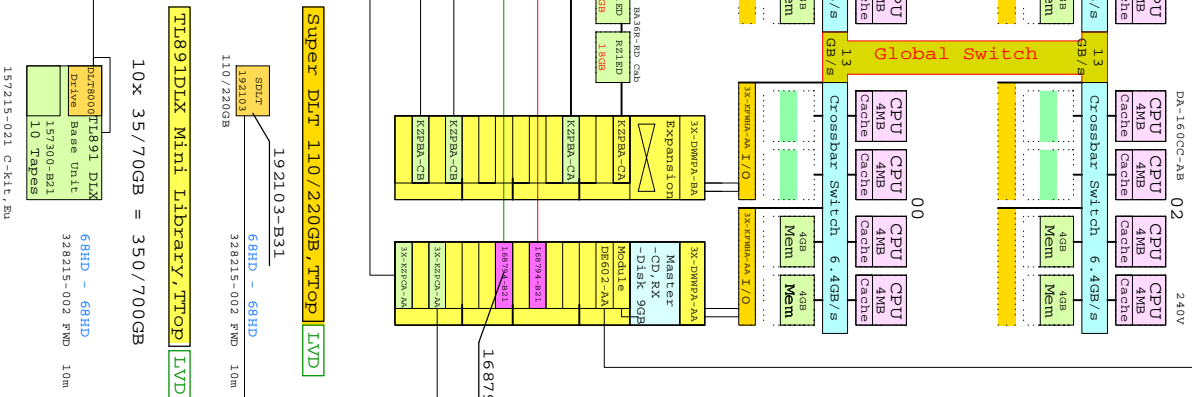

Ethernet

Compaq

Host Kit: IBM AIX
380558-001 IBM AIX

Host Kit: HP-UX
380557-001 HP-UX

Host Kit: Solaris
380554-001 SolarisKit

Host Kit: NT
380551-001 NT/INSTRIT
165989-B21 SecPath

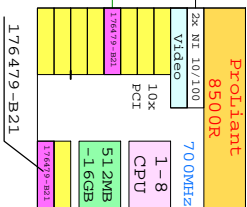
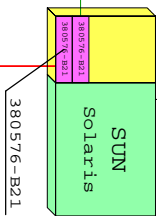
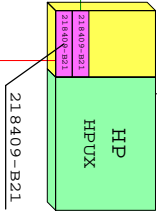
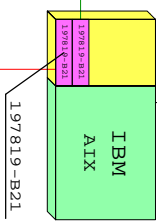

198x 40/80GB = 7.9/15.8TB

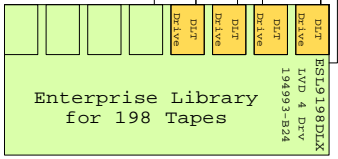
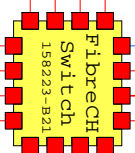
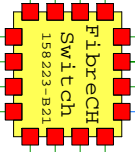

14621-0-021 C-Klt.EU

VHDCI - 68HD

20116-0-B21 VHDCI-68H

20116-0-B21 VHDCI-68H

20116-0-B21 VHDCI-68H

ESL9198DLX Enterprise Library LVD

SSL2020 AIT Library LVD

20x 50GB = 1000GB

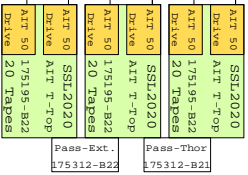

VHDCI - 68HD

34117-B21 VHDCI-68

34117-B21 VHDCI-68

34117-B21 VHDCI-68

EMAL2000 3x 42x 36GB = 4536GB

EMAL2000 D14 42U 175990-B22 50Hz opal

HS980 256MB *256MB

HS980 256MB *256MB

HS980 256MB *256MB

HS980 256MB *256MB

HS980 256MB *256MB

HS980 256MB *256MB

HS980 256MB *256MB

HS980 256MB *256MB

HS980 256MB *256MB

HS980 256MB *256MB

HS980 256MB *256MB

HS980 256MB *256MB

HS980 256MB *256MB

HS980 256MB *256MB

HS980 256MB *256MB

HS980 256MB *256MB

HS980 256MB *256MB

HS980 256MB *256MB

HS980 256MB *256MB

HS980 256MB *256MB

HS980 256MB *256MB

HS980 256MB *256MB

HS980 256MB *256MB

HS980 256MB *256MB

HS980 256MB *256MB

HS980 256MB *256MB

HS980 256MB *256MB

HS980 256MB *256MB

HS980 256MB *256MB

HS980 256MB *256MB

HS980 256MB *256MB

HS980 256MB *256MB

HS980 256MB *256MB

HS980 256MB *256MB

HS980 256MB *256MB

HS980 256MB *256MB

HS980 256MB *256MB

HS980 256MB *256MB

HS980 256MB *256MB

HS980 256MB *256MB

HS980 256MB *256MB

HS980 256MB *256MB

HS980 256MB *256MB

HS980 256MB *256MB

HS980 256MB *256MB

HS980 256MB *256MB

HS980 256MB *256MB

HS980 256MB *256MB

HS980 256MB *256MB

HS980 256MB *256MB

HS980 256MB *256MB

HS980 256MB *256MB

HS980 256MB *256MB

HS980 256MB *256MB

HS980 256MB *256MB

HS980 256MB *256MB

HS980 256MB *256MB

HS980 256MB *256MB

Generated with fresh GOLDEN EGGS Software Rev:27-Mar-2001

1-CPU, 1xPCI

AlphaServer Family Line

32-CPU, 223xPCI

DS10

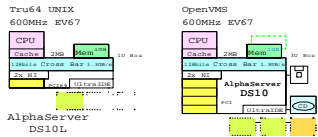

DS20E

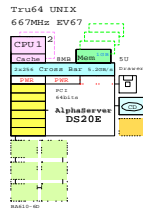

ES40

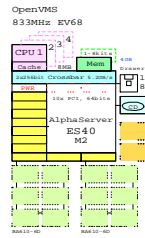

GS80

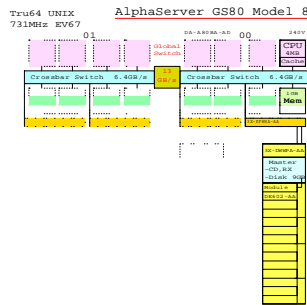

GS160

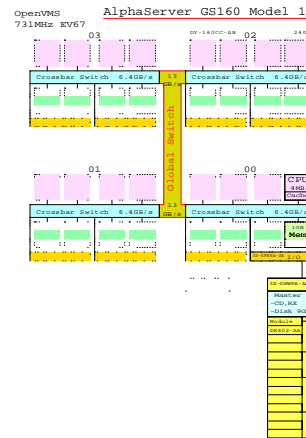

GS320

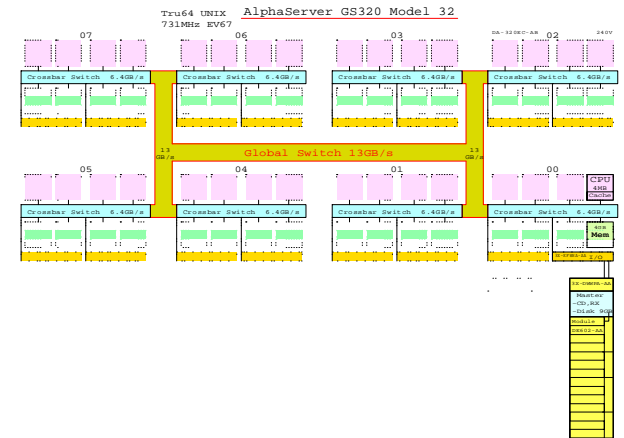

One U



DS10



AlphaServer DS20E
Footprint



AlphaServer ES40
Footprint



AlphaServer GS80

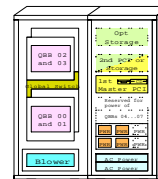

AlphaServer GS160

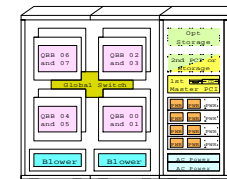

AlphaServer GS320

Cabinets..

Operating systems:

- Tru64 UNIX
- OpenVMS
- Linux

More Alpha GOLDEN EGGS Examples in Web: www.compaq.com/golden-eggs

GEO00M

AlphaServer Family: DS10L - ES40

DS10L

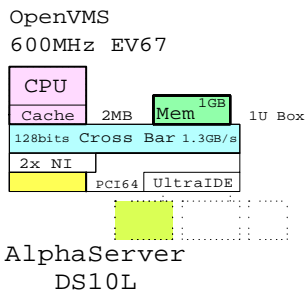

DS10

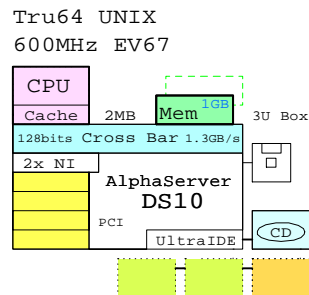

DS20E

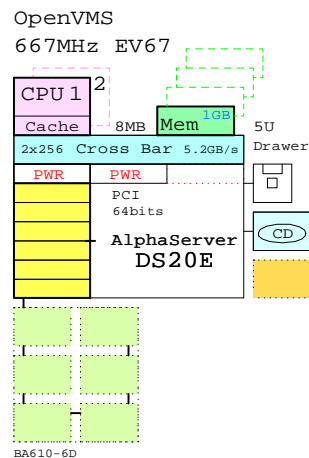

ES40

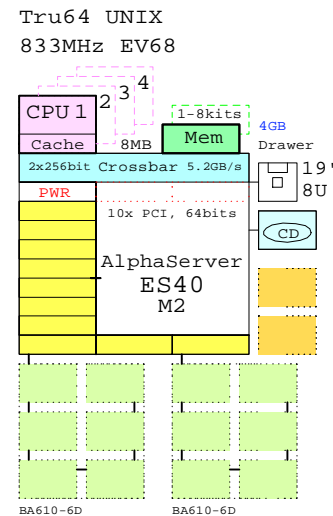

Operating systems:

- Tru64 UNIX
- OpenVMS
- Linux

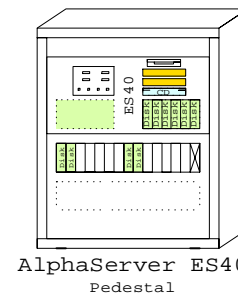
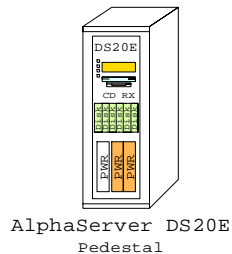
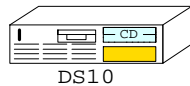
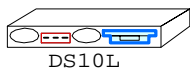

One U

Cabinets..

www.Compaq.com/golden-eggs
Since Oct-2000

COMPAQ 09-Feb-2001 GEA00K
Matti.Patari@Compaq.Com

Compaq AlphaServer Family
DS10L DS10 DS20E ES40

AlphaServer Family: GS80 - GS320

GS80

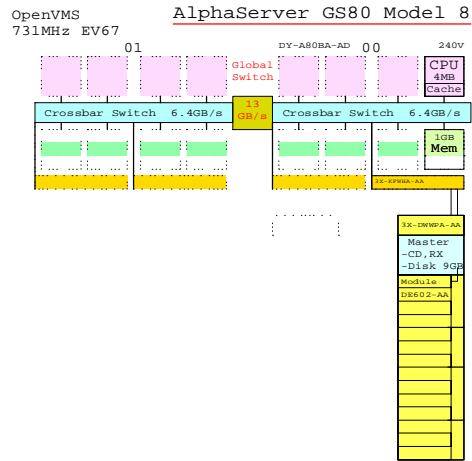

GS160

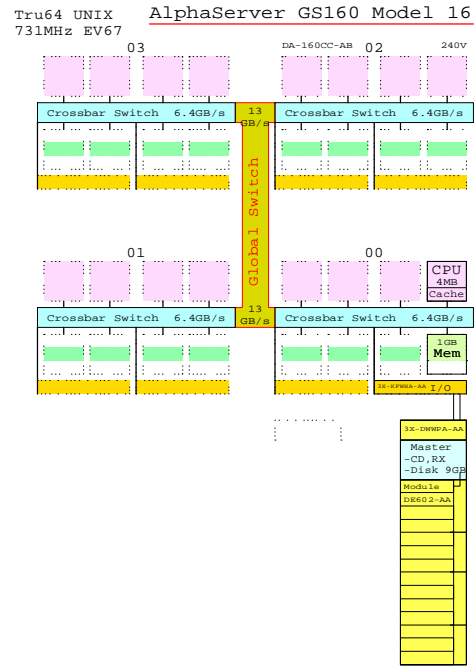

GS320

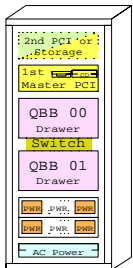
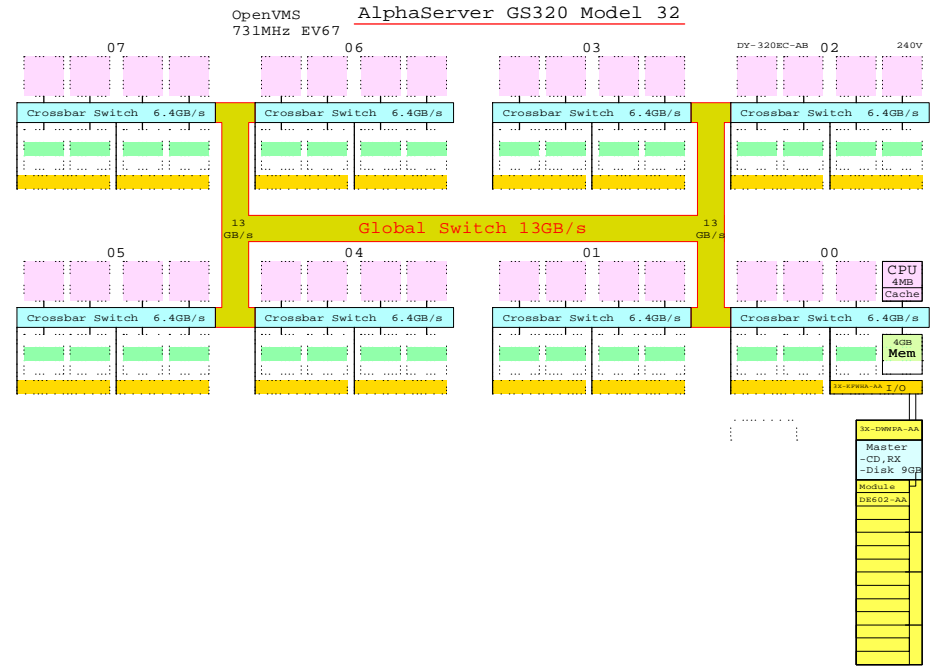

AlphaServer GS80

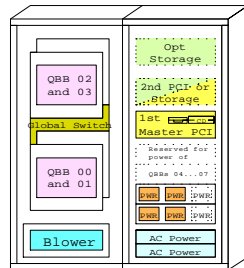

AlphaServer GS160

Operating systems:
 - Tru64 UNIX
 - OpenVMS

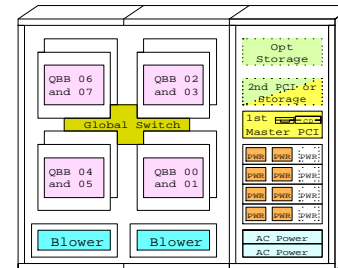

AlphaServer GS320

AlphaServer DS10, DS20 and ES40 Family

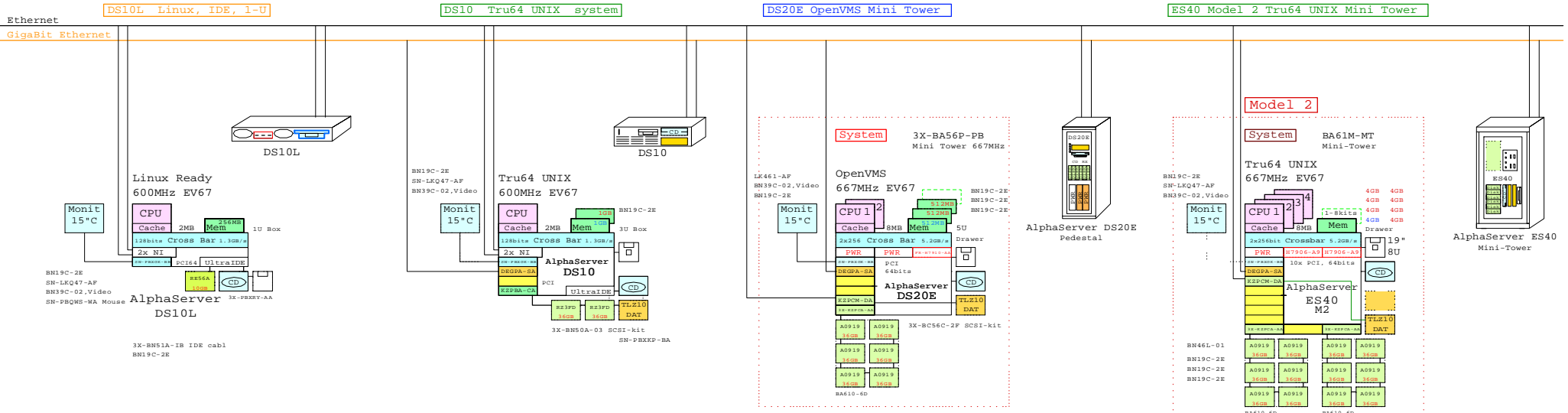

Bill of material

Part Number	Qty	Description
DI-718AA-DA	1	AS DS10L 67/600 256MB Linux Ready
3X-8B8F-AA	1	Diskette/ 24k CD-ROM Combo
3X-R35A-BA	1	DS10 10GB 7200 IDE-disk Drive 1"
SN-PB0K-BB	1	Eisa Gloria Synergy 8M Video Graphics
3X-VR0V-24	1	COMPAQ V55 CLR MON.NH.TC095
3X-BN1A-1B	1	One Drop DS10L IDE cable
SN-PB0W-WA	1	Standard Compaq opal mouse
BN19C-02	1	1.8 Video Extension Cable ****
SN-LK047-AF	1	102 KEY KYBD-NON-WIN, Finnish
BN19C-2E	2	PowerCable 240V, C-Europe

Bill of material

Part Number	Qty	Description
DA-73BAA-FA	1	AS DS10 67/600 1GB UNIX
3X-VR0V5-24	1	COMPAQ V55 CLR MON.NH.TC095
3X-R3510-AA	1	DS10 1GB DIMM MEM
BN19C-2E	1	PowerCable 240V, C-Europe
BN19C-02	1	1.8 Video Extension Cable ****
DGCPA-DA	1	PCI to GigabitEthernet 8X Adap
DS-R23PD-WA	2	36.4GB 10KRPM Ultra3 SCSI Disk
K2PDA-CA	1	PCI to UltraSCSI Adapter UMSB
SN-PB0K-BB	1	Eisa Gloria Synergy 8M Video Graphics
TL210-LB	1	12/24GB 4mm DAT 5.25" HB
3X-BN50A-03	1	SCSI cable kit, L&D, 3X disk
SN-LK047-AF	1	102 KEY KYBD-NON-WIN, Finnish
SN-PB0K-BA	1	WIDE TO NARROW SCSI ADAPTER
BN19C-2E	1	PowerCable 240V, C-Europe

Bill of material

Part Number	Qty	Description
3X-BA56P-PB	1	DS20E Mini tower pedestal kit,667MHz
3R-A2832-AA	1	COMPAQ Monitor S510 15" NH, EU
BN19C-02	4	PowerCable 240V, C-Europe
DY-56PAA-EA	1	AS DS20E 6/667 512MB Rack OVMS
3X-BC56C-2F	1	DS20E SCSI Cable Kit
3X-K2PDA-AA	1	Single channel LVD adapter
RM510-10	1	RS40 Disk Drive Cage, 6-Bay
3R-AD919-AA	6	36.4GB Ucsd19 10K Universal disk 1"
DGCPA-DA	1	PCI to GigabitEthernet 8X Adap
PR-87810-AA	1	75W power supply for DS20E
KN311-BC	1	AS DS20E 6/667 SMP UPD OpenVMS
MS340-DA	2	DS20 512MB SDRAM MEM 4x128MB
SN-PB0K-BB	1	Eisa Gloria Synergy 8M Video Graphics
TL210-LB	1	12/24GB 4mm DAT 5.25" HB
LK461-AF	1	VMS STYLE KEYBOARD, Pin/Swd

Bill of material, Model 2

Part Number	Qty	Description
BA61M-MT	1	ES40 Mini-Tower Enclosure
BN19C-2E	1	PowerCable 240V, C-Europe
DA-648AA-FA	1	ES40 67/667 Model 2 4GB UNIX 10PCI DWR
3R-VR0V5-24	1	COMPAQ V55 CLR MON.NH.TC095
3X-K2PDA-AA	2	Single channel LVD adapter
BA610-6D	1	ES40 Disk Drive Cage, 6-Bay
3R-AD919-AA	6	36.4GB Ucsd19 10K Universal disk 1"
BA610-6D	1	ES40 Disk Drive Cage, 6-Bay
3R-AD919-AA	6	36.4GB Ucsd19 10K Universal disk 1"
BN19C-2E	1	PowerCable 240V, C-Europe
BN19C-02	1	1.8 Video Extension Cable ****
BN461-01	1	Multi head SCSI cable, ES40
DGCPA-DA	1	PCI to GigabitEthernet 8X Adap
R7906-AS	2	ES40 Power Supply, 2nd or 3rd
RN610-BB	3	ES40 6/667MHz UNIX SMP 8mb cache
K2PDA-CA	1	Dual Channel LVD Adapter PCI
MS10-FA	1	ES40 4GB Memory Option
SN-PB0K-BB	1	Eisa Gloria Synergy 8M Video Graphics
TL210-LB	1	12/24GB 4mm DAT 5.25" HB
SN-LK047-AF	1	102 KEY KYBD-NON-WIN, Finnish

www.Compaq.com/golden-eggs

COMPAQ 05-Apr-2001 GEA00Ka
Matti.Pataria@Compaq.Com

Compaq AlphaServer Family
DS10L DS10 DS20E ES40

AlphaServer DS10L 67/600 Systems

Server systems, 64bits 600MHz

Memory	Tru64 UNIX	OpenVMS	Linux ready
256MB	DA-71BAA-DA	DY-71BAA-DA	DJ-71BAA-DA
512MB	DA-71BAA-EA	DY-71BAA-EA	DJ-71BAA-EA
1GB	DA-71BAA-FA	DY-71BAA-FA	DJ-71BAA-FA

Disk storage

IDE Disk	IDE
3X-RE56A-BA	10GB 7200r IDE drive
3X-RE57A-BA	30GB 7200r IDE drive
3X-BN51A-IB	One drop IDE cable, 1-2x
SCSI Disk	SCSI
DS-RZ1DD-WA	9.1GB 10k Ultra3 drive
DS-RZ3EF-WA	18GB 10k Ultra3 drive
DS-RZ3FD-WA	36GB 10k Ultra3 drive
3X-BN50A-05	One drop SCSI cable, 0-1x
3X-BN50A-02	Two drop SCSI cable, 0-1x

KZPBA-CA	UltraSCSI SE adapter
KZPAC-AA	UltraSCSI RAID adapter
3X-DEPVZ-AA	1 Ultra2, 2D Grap, Ether.
3X-DEPVD-AA	Permedia P2, Ethernet

Load device

3X-PBXRY-AA	CD and Diskette combo
-------------	-----------------------

Cabinet shelf kits

3X-PBX01-BE	Rack kit Single
3X-PBX01-BD	Rack kit Quad

Memory swap, max memory =1GB

3X-MS310-DA	512MB
3X-MS310-EA	1GB

Power cords

BN19C-2E	Europe
BN19A-2E	GB
BN19E-2E	CH
BN19K-2E	DK
BN19M-2E	I

SN-PBQWS-WA	Compaq mouse
-------------	--------------

Generated with fresh GOLDEN EGGS Software, Rev:20-Sep-2000

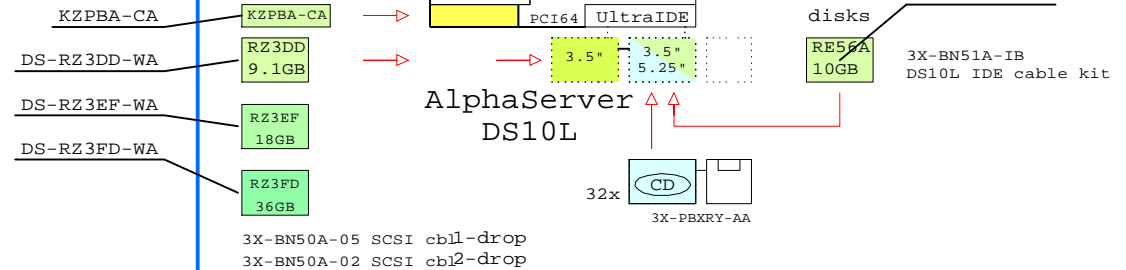

Mandatory options:

- System Disk, IDE or SCSI
- Drop cable

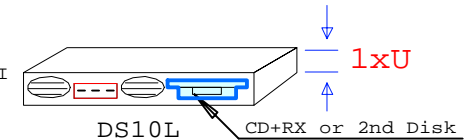

Licenses included:

- Tru64 UNIX V4.0F, Base license, 2-user Base license, Server Extension license, and Internet Access Software license and Netscape's Enterprise Server.

OpenVMS V7.2-1, Base license and DIGITAL Enterprise Integration Package.

	@600MHz	@466MHz
SPECint95	35	24
SPECfp95	56	47

Software Processor Code: E

COMPAQ	19-Dec-2000	GEADS10L2
	Matti.Patari@compaq.com	

AlphaServer DS10L 600MHz Syst.
GOLDEN EGGS Visuals, Helsinki

Since: Oct-2000 www.Compaq.com/golden-eggs **DS10L**

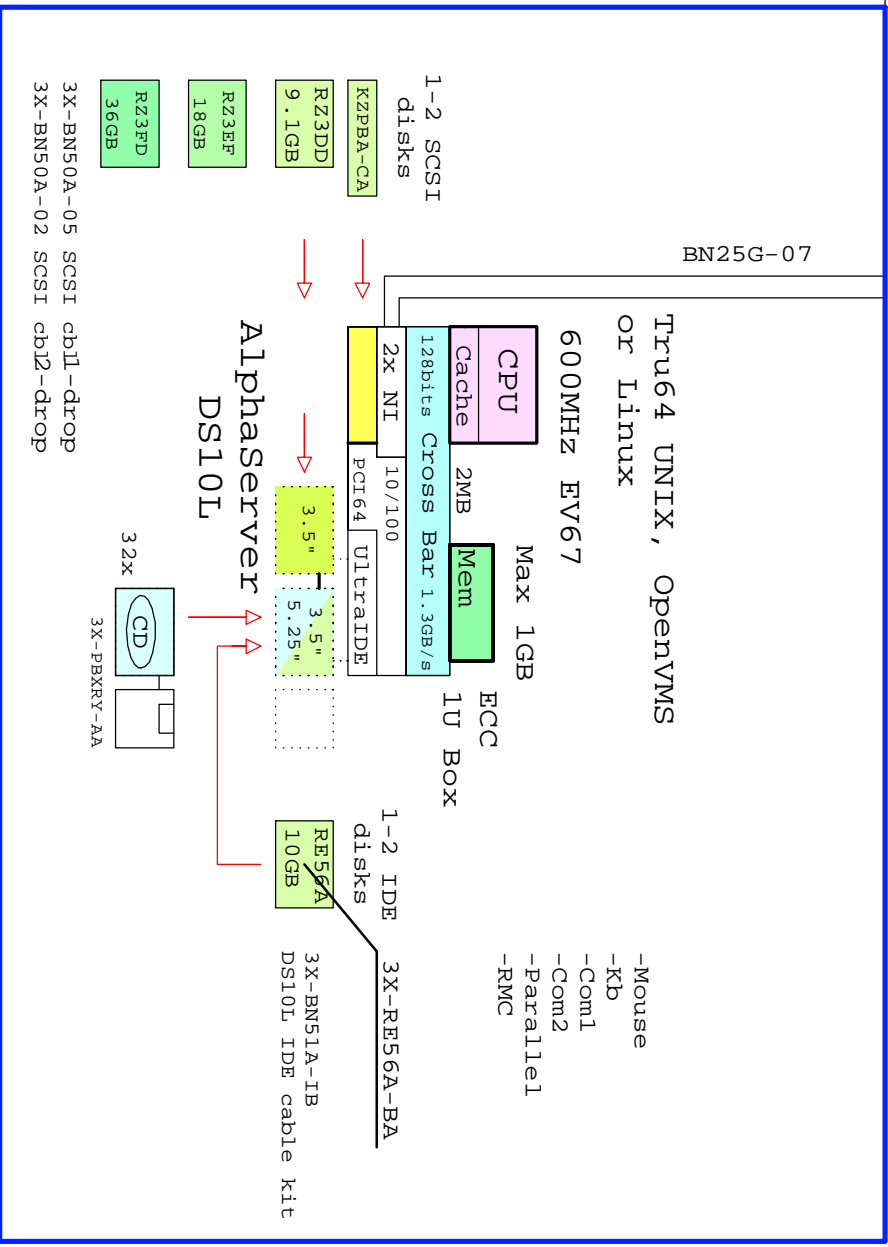

- Mandatory options:**
- System Disk, IDE or SCSI
 - Drop cable

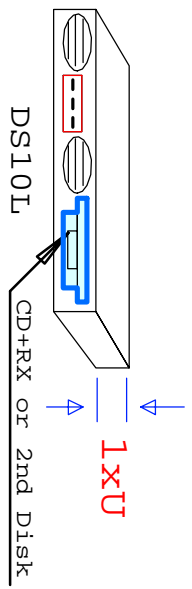

Licenses included:

- Tru64 UNIX V4.0F, Base license, 2-user Base license, Server Extension license, and Internet Access Software license and Netscape's Enterprise Server.

OpenVMS V7.2-1, Base license and DIGITAL Enterprise Integration Package.

	@600MHz	@466MHz
SPECint95	35	24
SPECfp95	56	47

Software Processor Code: **E**

COMPAQ	
19-Dec-2000	GEADS10L2
Matti.Patarri@compaq.com	

AlphaServer DS10L 600MHz Syst.
GOLDEN EGGS Visuals, Helsinki

DS10L

BN25G-07

Tru64 UNIX, OpenVMS
or Linux

600MHz EV67

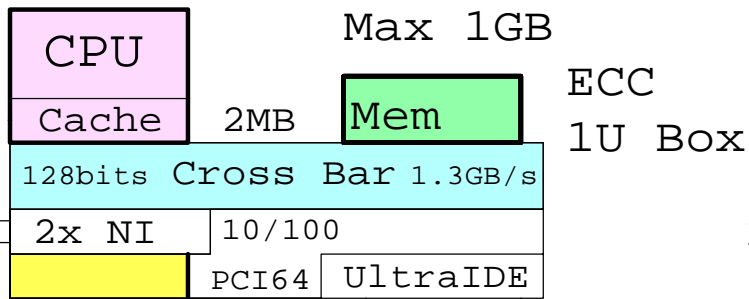

- Mouse
- Kb
- Com1
- Com2
- Parallel
- RMC

1-2 SCSI
disks

- KZPBA-CA
- RZ3DD
9.1GB
- RZ3EF
18GB
- RZ3FD
36GB

3X-BN50A-05 SCSI cb1-drop
3X-BN50A-02 SCSI cb2-drop

1-2 IDE
disks

- RE56A
10GB

3X-RE56A-BA
3X-BN51A-IB
DS10L IDE cable kit

AlphaServer
DS10L

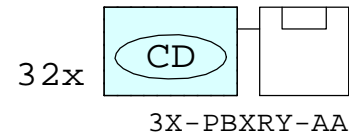

Ethernet
Ethernet

DS10L UNIX with External SCSI RAID

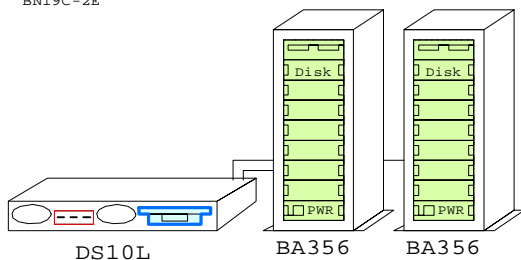
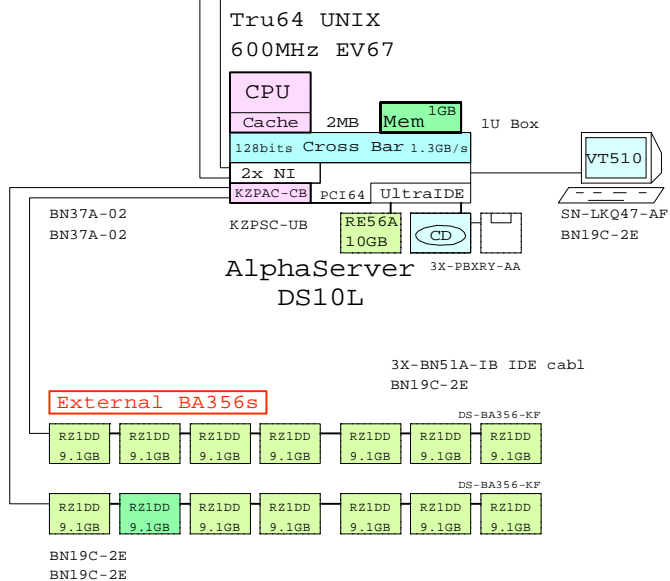

DS10L UNIX, SCSI, One-box

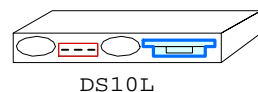
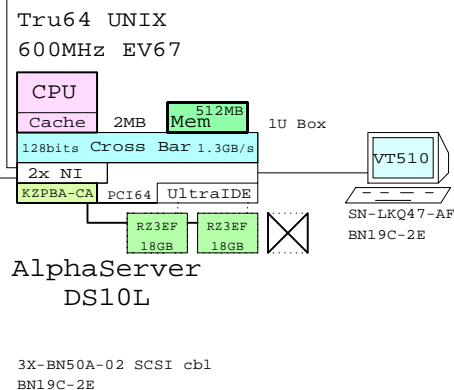

Bill of material

	Part Number	Qty	Description
	DA-71BAA-EA	1	AS DS10L 67/600 512MB UNIX
1	DA-71BAA-EA	1	AS DS10L 67/600 512MB UNIX
1.1	DS-RZ3EF-WA	2	18.2GB 10krRPM Ultra3 SCSI Disk
1.2	KZPBA-CA	1	PCI to UltraSCSI Adapter UWSE
2	VT510-A4	1	Text Terminal WH Intl No-hemi
3	3X-BN50A-02	1	Two drop SCSI cable, LED
4	SN-LKQ47-AF	1	102 KEY KYBD, NON-WIN, Finnish
5	BN19C-2E	2	PowerCable 240V, C-Europe

DS10L UNIX, IDE, One-box

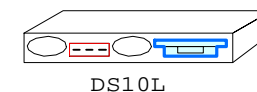
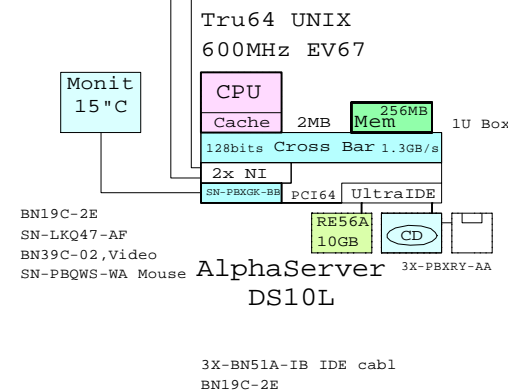

Bill of material

	Part Number	Qty	Description
	DA-71BAA-DA	1	AS DS10L 67/600 256MB UNIX
1	DA-71BAA-DA	1	AS DS10L 67/600 256MB UNIX
1.1	3X-PBXRY-AA	1	Diskette/ 24x CD-ROM Combo
1.2	3X-RE56A-BA	1	DS10 10GB 7200 IDE-disk drive 1"
1.3	SN-PBXGK-BB	1	Elsa Gloria Synergy 8M Video Graphics
2	3R-VRQV5-24	1	COMPAQ V55 CLR MON,NH,TCO95
3	3X-BN51A-IB	1	One drop DS10L IDE cable
4	SN-PBQWS-WA	1	Standard Compaq opal mouse
5	BN39C-02	1	1.8 Video Extension Cable ****
6	SN-LKQ47-AF	1	102 KEY KYBD, NON-WIN, Finnish
7	BN19C-2E	2	PowerCable 240V, C-Europe

www.Compaq.com/golden-eggs
Since:Oct-2000

Bill of material

	Part Number	Qty	Description
	DA-71BAA-FA	1	AS DS10L 67/600 1GB UNIX
1	DA-71BAA-FA	1	AS DS10L 67/600 1GB UNIX
1.1	3X-PBXRY-AA	1	Diskette/ 24x CD-ROM Combo
1.2	3X-RE56A-BA	1	DS10 10GB 7200 IDE-disk drive 1"
1.3	KZPAC-CB	1	3 Chan. SCSI RAID 8MB UltraW
1.4	KZPSC-UB	1	Battery Backup for KZPSC
2	DS-BA356-KF	1	Pedestal Storage, UltraW, Single-Bus
2.1	DS-RZ1DD-VW	7	9.1GB 10000r UltraSCSI disk
3	DS-BA356-KF	1	Pedestal Storage, UltraW, Single-Bus
3.1	DS-RZ1DD-VW	7	9.1GB 10000r UltraSCSI disk
4	VT510-A4	1	Text Terminal WH Intl No-hemi
5	3X-BN51A-IB	1	One drop DS10L IDE cable
6	SN-LKQ47-AF	1	102 KEY KYBD, NON-WIN, Finnish
7	BN19C-2E	4	PowerCable 240V, C-Europe
8	BN37A-02	2	Ultra Cbl VHDCI - VHDCI

This template is included in the present GOLDEN EGGS Software kit.

DS10L UNIX

COMPAQ	06-Feb-2001	GTAUDS10L3
	Matti.Patari@Compaq.com	
AlphaServer DS10L UNIX systems		
GOLDEN EGGS Visuals, Helsinki		

DS10L UNIX Cluster with in-cabinet RAID storage

Ethernet
Ethernet

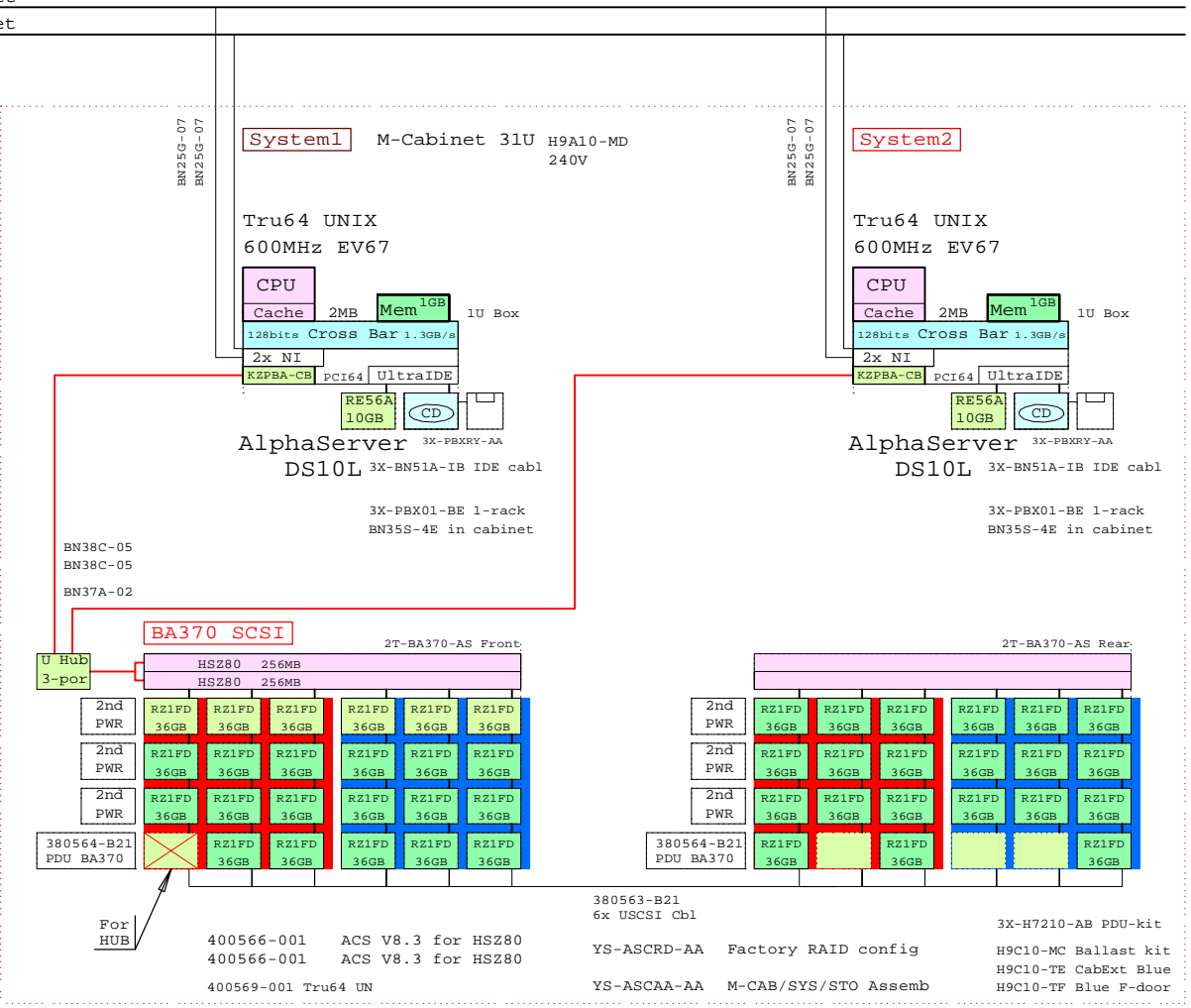

BOM for this cabinet system

Part Number	Qty	Description
H9A10-MD	1	M-Series Cab,H9A10,Blue,240V 31U
1.1	2T-BA370-AR	1 BA370 shelf,slides Rear RackMount
1.1.1	380564-B21	1 Power Distribution Unit RA8k/7k
1.1.2	380565-B21	3 Power Suply 180W Hot Plug SBB
1.1.3	DS-RZ1FD-VW	21 36GB 10000r UltraSCSI Disk
1.2	2T-BA370-AS	1 BA370 shelf,slides Front RackMount
1.2.1	380564-B21	1 Power Distribution Unit RA8k/7k
1.2.2	380565-B21	3 Power Suply 180W Hot Plug SBB
1.2.3	400565-B21	2 Ultra Opt.1 cont w 2x128MB cache HSZ80
1.2.4	DS-DWZ2H-03	1 Uscsi Act hub 0 SE:3/Dif 3.5" SBB
1.2.5	DS-RZ1FD-VW	23 36GB 10000r UltraSCSI Disk
1.3	380563-B21	1 Set of six USCSI cables
1.4	3X-H7210-AB	1 PDU Fan Cable mgt kit Europe
1.5	3X-PBX01-BB	2
1.6	400566-001	2 HSZ80 Controller Software ACS V8.3
1.7	400569-001	1 Ultra opt OS Software Tru64 UNIX
1.8	BN25G-07	4 17-03212-05 8MP-8MP PATCH CBL
1.9	BN35S-4E	2 PowerCord C13 to C14, Non US
1.10	BN37A-02	1 Ultra Cbl VHDCI - VHDCI
1.11	BN38C-05	2 Ultra Cbl VHDCI - 68HD
1.12	DA-71BAA-FA	1 AS DS10L 67/600 1GB UNIX
1.12.1	3X-BN51A-IB	1 One drop DS10L IDE cable
1.12.2	3X-PBXRY-AA	1 Diskette/ 24x CD-ROM Combo
1.12.3	3X-RE56A-BA	1 DS10 10GB 7200 IDE-disk drive 1"
1.12.4	KZPBA-CB	1 PCI to UltraSCSI Adapter UWdif
1.13	DA-71BAA-FA	1 AS DS10L 67/600 1GB UNIX
1.13.1	3X-BN51A-IB	1 One drop DS10L IDE cable
1.13.2	3X-PBXRY-AA	1 Diskette/ 24x CD-ROM Combo
1.13.3	3X-RE56A-BA	1 DS10 10GB 7200 IDE-disk drive 1"
1.13.4	KZPBA-CB	1 PCI to UltraSCSI Adapter UWdif
1.14	H9C10-MC	1 Ballast Kit for cabinets
1.15	H9C10-TE	1 Rear cab extender for H9A10 Blue
1.16	H9C10-TF	1 FrontDoorKit Blue for H9A10
1.17	YS-ASCAA-AA	1 M-CAB/SYS/STO Assembly
1.18	YS-ASCRD-AA	1 Factory configured RAID sets of BA370

www.Compaq.com/golden-eggs
Since:Oct-2000

COMPAQ	08-Nov-2000	GTAUDS10L4
	Matti.Patari@Compaq.com	

AlphaServer DS10L UNIX Cluster
GOLDEN EGGS Visuals, Helsinki

This template is included in the present GOLDEN EGGS Software kit.

DS10L UNIX

Ethernet
Ethernet

DS10L OpenVMS with External SCSI RAID

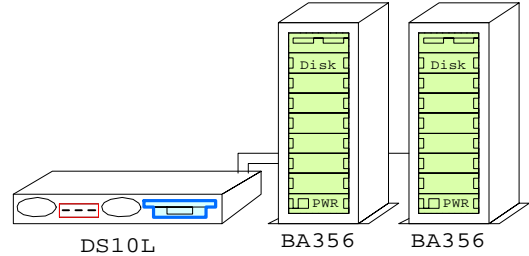
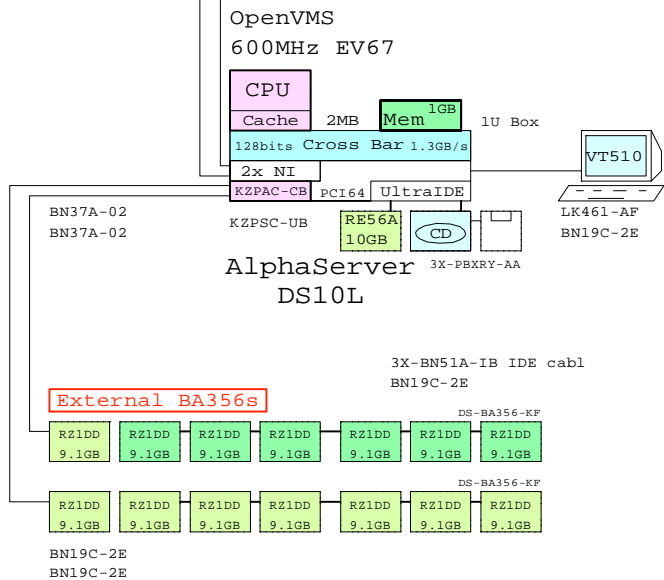

DS10L OpenVMS, SCSI, One-box

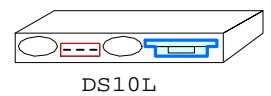
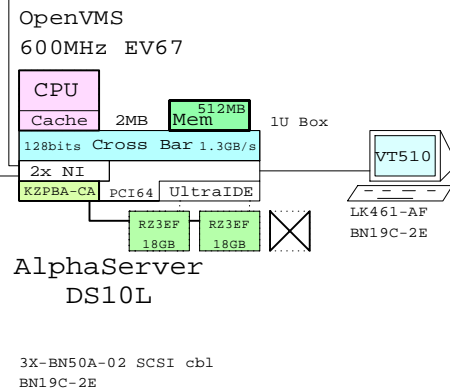

DS10L OpenVMS, IDE, One-box

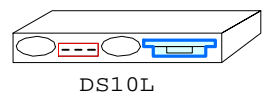
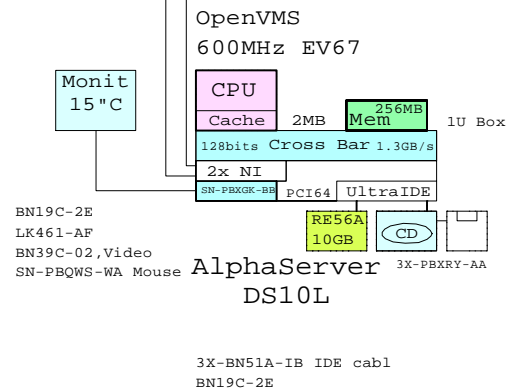

Bill of material

Part Number	Qty	Description
1	1	DY-71BAA-EA 1 AS DS10L 67/600 512MB OpenVMS
1.1	2	DS-RZ3EF-WA 2 18.2GB 10krRPM Ultra3 SCSI Disk
1.2	1	KZPBA-CA 1 PCI to UltraSCSI Adapter UWSE
2	1	VT510-A4 1 Text Terminal WH Intl No-hemi
3	1	3X-BN50A-02 1 Two drop SCSI cable, LED
4	2	BN19C-2E 2 PowerCable 240V, C-Europe
5	1	LK461-AF 1 VMS STYLE KEYBOARD, Fin/Swed

Bill of material

Part Number	Qty	Description
1	1	DY-71BAA-FA 1 AS DS10L 67/600 1GB OpenVMS
1.1	1	3X-PBXRY-AA 1 Diskette/ 24x CD-ROM Combo
1.2	1	3X-RE56A-BA 1 DS10 10GB 7200 IDE-disk drive 1"
1.3	1	KZPAC-CB 1 3 Chan. SCSI RAID 8MB UltraW
1.4	1	KZPSC-UB 1 Battery Backup for KZPSC
2	1	DS-BA356-KF 1 Pedestal Storage, UltraW, Single-Bus
2.1	7	DS-RZ1DD-VW 7 9.1GB 10000r UltraSCSI disk
3	1	DS-BA356-KF 1 Pedestal Storage, UltraW, Single-Bus
3.1	7	DS-RZ1DD-VW 7 9.1GB 10000r UltraSCSI disk
4	1	VT510-A4 1 Text Terminal WH Intl No-hemi
5	1	3X-BN51A-IB 1 One drop DS10L IDE cable
6	4	BN19C-2E 4 PowerCable 240V, C-Europe
7	2	BN37A-02 2 Ultra Cbl VHDCI - VHDCI
8	1	LK461-AF 1 VMS STYLE KEYBOARD, Fin/Swed

Bill of material

Part Number	Qty	Description
1	1	DY-71BAA-DA 1 AS DS10L 67/600 256MB OpenVMS
1.1	1	3X-PBXRY-AA 1 Diskette/ 24x CD-ROM Combo
1.2	1	3X-RE56A-BA 1 DS10 10GB 7200 IDE-disk drive 1"
1.3	1	SN-PBXGK-BB 1 Elsa Gloria Synergy 8M Video Graphics
2	1	3R-VRQV5-24 1 COMPAQ V55 CLR MON,NH,TCO95
3	1	3X-BN51A-IB 1 One drop DS10L IDE cable
4	1	SN-PBQWS-WA 1 Standard Compaq opal mouse
5	1	BN39C-02 1 1.8 Video Extension Cable ****
6	2	BN19C-2E 2 PowerCable 240V, C-Europe
7	1	LK461-AF 1 VMS STYLE KEYBOARD, Fin/Swed

www.Compaq.com/golden-eggs
Since:Oct-2000

COMPAQ	06-Feb-2001	GTAVDS10L3
	Matti.Patari@Compaq.com	
AlphaServer DS10L OVMS systems		
GOLDEN EGGS Visuals, Helsinki		

This template is included in the present GOLDEN EGGS Software kit.

DS10L OVMS

DS10L OpenVMS Cluster with in-cabinet RAID storage

Ethernet
Ethernet

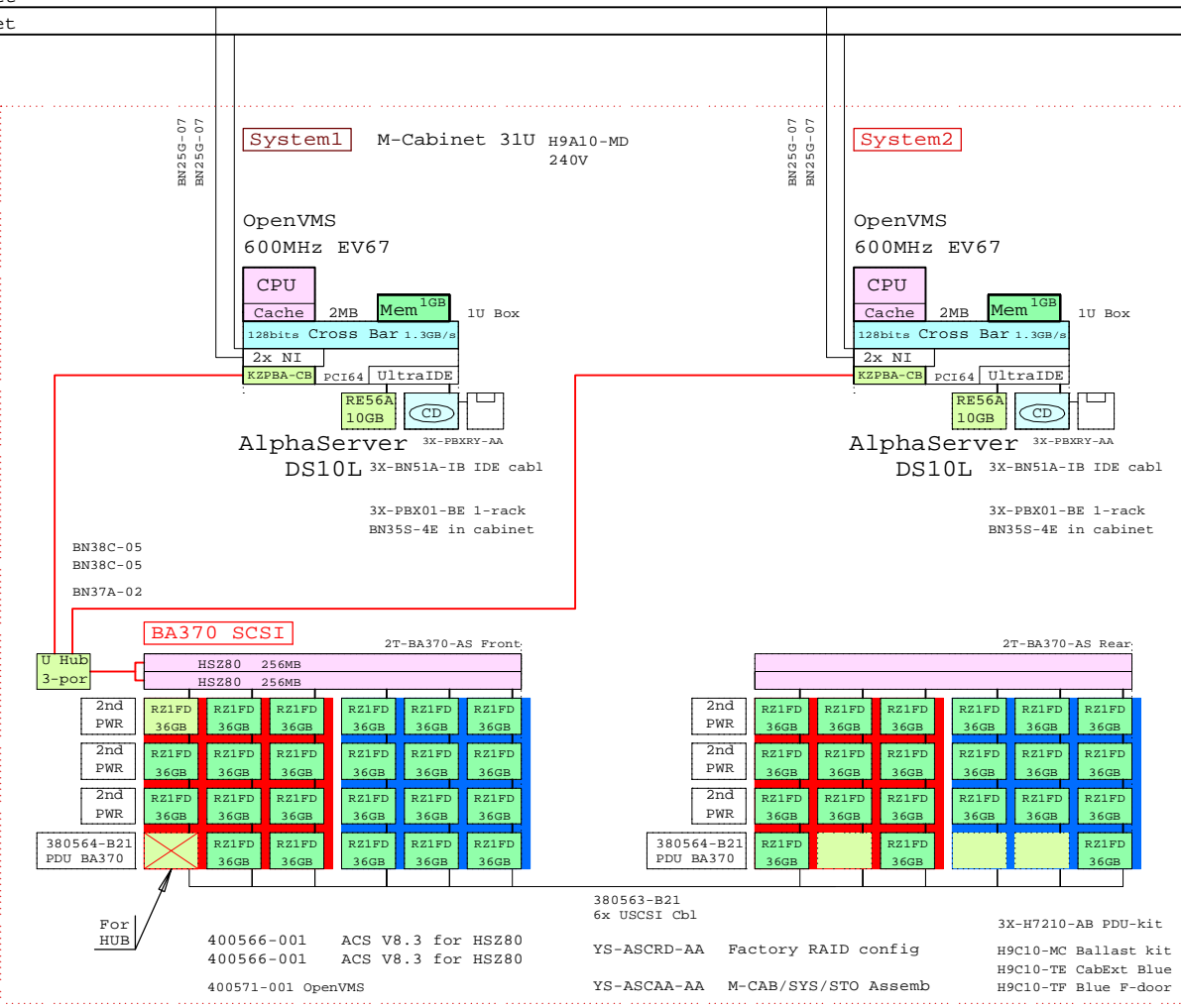

BOM for this cabinet system

Part Number	Qty	Description
H9A10-MD	1	M-Series Cab,H9A10,Blue,240V 31U
1.1	2T-BA370-AR	1 BA370 shelf,slides Rear RackMount
1.1.1	380564-B21	1 Power Distribution Unit RA8k/7k
1.1.2	380565-B21	3 Power Suply 180W Hot Plug SBB
1.1.3	DS-RZ1FD-VW	21 36GB 10000r UltraSCSI Disk
1.2	2T-BA370-AS	1 BA370 shelf,slides Front RackMount
1.2.1	380564-B21	1 Power Distribution Unit RA8k/7k
1.2.2	380565-B21	3 Power Suply 180W Hot Plug SBB
1.2.3	400565-B21	2 Ultra Opt.1 cont w 2x128MB cache HSZ80
1.2.4	DS-DWZ2H-03	1 Uscsi Act hub 0 SE:3/Dif 3.5" SBB
1.2.5	DS-RZ1FD-VW	23 36GB 10000r UltraSCSI Disk
1.3	380563-B21	1 Set of six USCSI cables
1.4	3X-H7210-AB	1 PDU Fan Cable mgt kit Europe
1.5	3X-PBX01-BB	2
1.6	400566-001	2 HSZ80 Controller Software ACS V8.3
1.7	400571-001	1 Ultra opt OS Software OpenVMS
1.8	BN25G-07	4 17-03212-05 8MP-8MP PATCH CBL
1.9	BN35S-4E	2 PowerCord C13 to C14, Non US
1.10	BN37A-02	1 Ultra Cbl VHDCI - VHDCI
1.11	BN38C-05	2 Ultra Cbl VHDCI - 68HD
1.12	DY-71BAA-FA	1 AS DS10L 67/600 1GB OpenVMS
1.12.1	3X-BN51A-IB	1 One drop DS10L IDE cable
1.12.2	3X-PBXRY-AA	1 Diskette/ 24x CD-ROM Combo
1.12.3	3X-RE56A-BA	1 DS10 10GB 7200 IDE-disk drive 1"
1.12.4	KZPBA-CB	1 PCI to UltraSCSI Adapter UWdif
1.13	DY-71BAA-FA	1 AS DS10L 67/600 1GB OpenVMS
1.13.1	3X-BN51A-IB	1 One drop DS10L IDE cable
1.13.2	3X-PBXRY-AA	1 Diskette/ 24x CD-ROM Combo
1.13.3	3X-RE56A-BA	1 DS10 10GB 7200 IDE-disk drive 1"
1.13.4	KZPBA-CB	1 PCI to UltraSCSI Adapter UWdif
1.14	H9C10-MC	1 Ballast Kit for cabinets
1.15	H9C10-TE	1 Rear cab extender for H9A10 Blue
1.16	H9C10-TF	1 FrontDoorKit Blue for H9A10
1.17	YS-ASCAA-AA	1 M-CAB/SYS/STO Assembly
1.18	YS-ASCRD-AA	1 Factory configured RAID sets of BA370

www.Compaq.com/golden-eggs
Since:Oct-2000

COMPAQ	08-Nov-2000	GTAVDS10L4
	Matti.Patari@Compaq.com	

AlphaServer DS10L OVMS Cluster
GOLDEN EGGS Visuals, Helsinki

This template is included in the present GOLDEN EGGS Software kit.

DS10L OVMS

Ethernet
Ethernet

DS10L Linux with External storage

DS10L Linux, SCSI, One-box

DS10L Linux, IDE, One-box

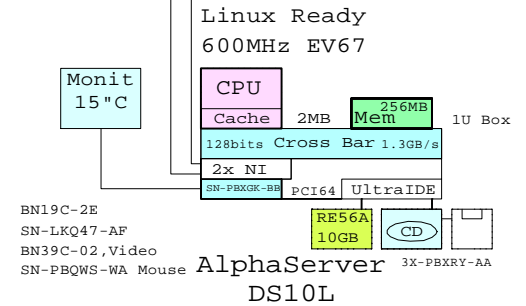
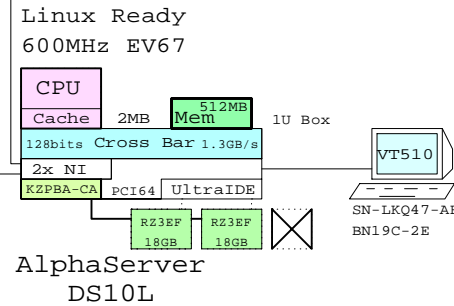
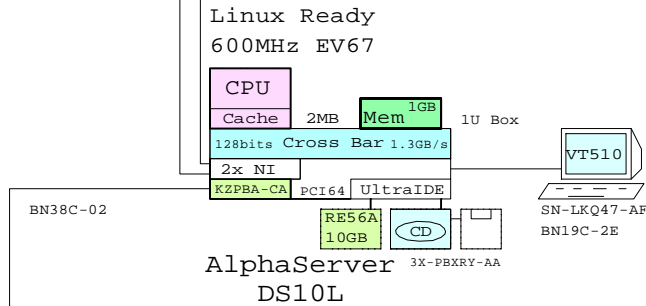

3X-BN51A-IB IDE cbl
BN19C-2E

3X-BN50A-02 SCSI cbl
BN19C-2E

3X-BN51A-IB IDE cbl
BN19C-2E

External BA356

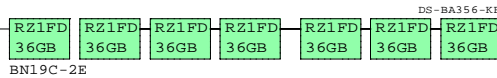

DS10L



DS10L

Bill of material

	Part Number	Qty	Description
	DJ-71BAA-EA	1	AS DS10L 67/600 512MB Linux Ready
1.1	DS-RZ3EF-WA	2	18.2GB 10krRPM Ultra3 SCSI Disk
1.2	KZPBA-CA	1	PCI to UltraSCSI Adapter UWSE
2	VT510-A4	1	Text Terminal WH Intl No-hemi
3	3X-BN50A-02	1	Two drop SCSI cable, LED
4	SN-LKQ47-AF	1	102 KEY KYBD, NON-WIN, Finnish
5	BN19C-2E	2	PowerCable 240V, C-Europe

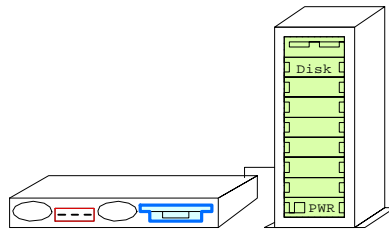

DS10L

BA356

Bill of material

	Part Number	Qty	Description
1	DJ-71BAA-FA	1	AS DS10L 67/600 1GB Linux Ready
1.1	3X-PBXRY-AA	1	Diskette/ 24x CD-ROM Combo
1.2	3X-RE56A-BA	1	DS10 10GB 7200 IDE-disk drive 1"
1.3	KZPBA-CA	1	PCI to UltraSCSI Adapter UWSE
2	DS-BA356-KF	1	Pedestal Storage, UltraW, Single-Bus
2.1	DS-RZ1FD-VW	7	36GB 10000r UltraSCSI Disk
3	VT510-A4	1	Text Terminal WH Intl No-hemi
4	3X-BN51A-IB	1	One drop DS10L IDE cable
5	SN-LKQ47-AF	1	102 KEY KYBD, NON-WIN, Finnish
6	BN19C-2E	3	PowerCable 240V, C-Europe
7	BN38C-02	1	Ultra Cbl VHDCI - 68HD

Bill of material

	Part Number	Qty	Description
1	DJ-71BAA-DA	1	AS DS10L 67/600 256MB Linux Ready
1.1	3X-PBXRY-AA	1	Diskette/ 24x CD-ROM Combo
1.2	3X-RE56A-BA	1	DS10 10GB 7200 IDE-disk drive 1"
1.3	SN-PBXGK-BB	1	Elsa Gloria Synergy 8M Video Graphics
2	3R-VRQV5-24	1	COMPAQ V55 CLR MON,NH,TC095
3	3X-BN51A-IB	1	One drop DS10L IDE cable
4	SN-PBQWS-WA	1	Standard Compaq opal mouse
5	BN39C-02	1	1.8 Video Extension Cable ****
6	SN-LKQ47-AF	1	102 KEY KYBD, NON-WIN, Finnish
7	BN19C-2E	2	PowerCable 240V, C-Europe

www.Compaq.com/golden-eggs
Since:Oct-2000

COMPAQ	08-Nov-2000	GTALDS10L3
	Matti.Patari@Compaq.com	
AlphaServer DS10L Linux system		
GOLDEN EGGS Visuals, Helsinki		

This template is included in the present GOLDEN EGGS Software kit.

DS10L Linux

AlphaServer DS10 67/600 Systems

Order number	Operating system	Server systems, 64bits 600MHz
#1 DA-73BAA -DA 256MB -EA 512MB -FA 1GB	Tru64 UNIX	(Disk) RX,CD,NI,(Graphics)
DY-73BAA-**	OpenVMS	(Disk) RX,CD,NI,(Graphics)
DJ-73BAA-**	Linux	(Disk) RX,CD,NI,(Graphics)

#2 Select a system disk, IDE or SCSI; SCSI adapter and cable kit.

#3 SVGA color monitor #4 For 240V, select 2x power cords and one keyboard.

15" 3R-VRQV5-24/11
17" 3R-VRQP7-24/23
North/South
BN39C-02 2m ext.cable

SN-LKQ47 UNIX,Lin	-AE GB -AB B -AD DK -AF FI	-AG G -AH NL -AI I -AK CH	-AM S -AN N -AP F -AS E	BN19C-2E Europe BN19A-2E GB BN19E-2E CH BN19K-2E DK BN19M-2E I
----------------------	-------------------------------------	------------------------------------	----------------------------------	--

Internal options

Memory expansion

3X-MS310-CA	256MB	Max memory 2x 1GB = 2GB
3X-MS310-DA	512MB	
3X-MS310-EA	1GB	

Internal storage

Tape storage

TLZ10-LB	12/24GB DAT SCSI tape
SN-PBXKP-BA	Wide to narrow adapt
KZPBA-CA	UltraSCSI SE adapter

Disk storage

3X-RE56A-BA	10GB IDE disk 7200
3X-RE57A-BA	30GB IDE disk 7200

3X-BN50A-03 SCSI Cable kit

DS-RZ3EF-WA	18.2GB Ultra3 disk 10k
DS-RZ3FD-WA	36.4GB Ultra3 disk 10k

KZPAC-CB	RAID 3-port, 8MB cache
KZPSC-UB	Cache battery
3X-PBX01-AB	H9Axx Cabinet shelf kit

Adapters

SN-PBXGK-BB	ELSA Gloria Syn. 8MB
3X-DE600-AA	Ethernet 10/100
DEGPA-SA	Gigabit Ethernet
KZPBA-CB	UltraSCSI Diff, 68HD
3X-DEPVZ-AA	1 Ultra2,2D Grap,Ether.
3X-DEPVD-AA	Permedia P2, Ethernet

External options

Tape storage

DS-TZ89N-TA	35/70GB DLT tape,TT
BN21K-02	SCSI cable, FWD
BN19C-2E	Power cord, Europe
KZPBA-CA	UltraSCSI SE adapter

Disk storage

DS-BA356-KF	Pedestal, single bus
DS-BA356-KG	Pedestal, split bus
BN37A-02	2m SCSI,VHDCI-VHDCI
BN19C-2E	Power cord, Europe
KZPAC-AA	RAID 1-port, 4Mbcache

DS-RZ1DD-VW	9.1GB UltraSCSI disk
DS-RZ1ED-VW	18 GB UltraSCSI disk

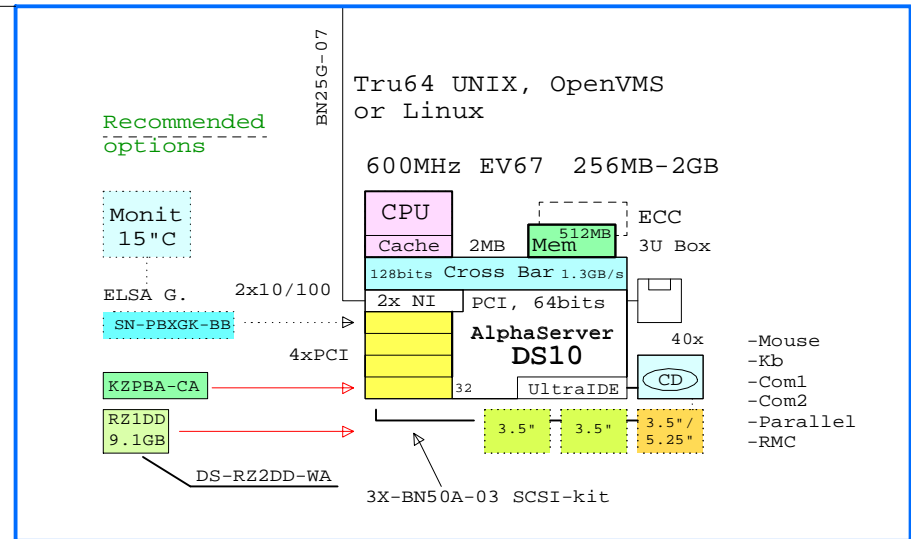

Mandatory options:

- SCSI adapter
- Cable kit
- System disk or IDE disk only

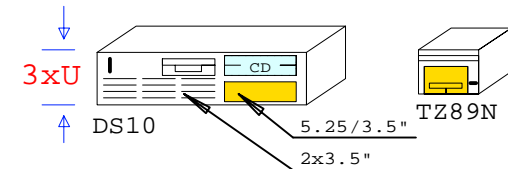

Licenses included:

- Tru64 UNIX V4.0F, Base license, Unlimited User license, Server Extension license, and Internet Access Software license and Netscape's Enterprise Server.
- OpenVMS V7.1-2, Base license and DIGITAL Enterprise Integration Package.

	@600MHz	@466MHz
SPECint95	35	24
SPECfp95	56	47

Software Processor Code: E

COMPAQ	19-Dec-2000	GEADS102
	Matti.Patari@Compaq.com	

AlphaServer DS10 600MHz System
GOLDEN EGGS Visuals, Helsinki

BN25G-07

Recommended options

Tru64 UNIX, OpenVMS
or Linux

600MHz EV67 256MB-2GB

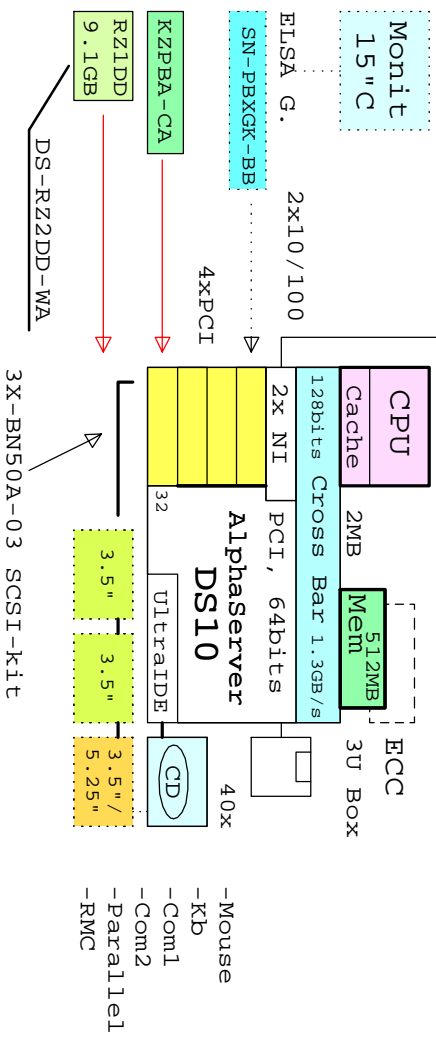

Mandatory options:

- SCSI adapter
- Cable kit
- System disk or IDE disk only

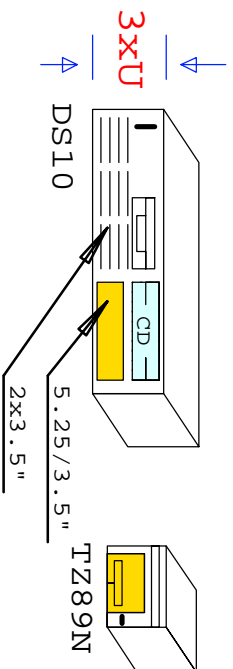

Licenses included:

- Tru64 UNIX V4.0F, Base license, Unlimited User license, Server Extension license, and Internet Access Software license and Netscape's Enterprise Server.
- OpenVMS V7.1-2, Base license and DIGITAL Enterprise Integration Package.

	@600MHz	@466MHz
SPECint95	35	24
SPECfp95	56	47
Software Processor Code: E		



19-Dec-2000	GEADS102
Matti.Patari@Compaq.com	

AlphaServer DS10 600MHz System
GOLDEN EGGS Visuals, Helsinki

DS10

BN25G-07

Tru64 UNIX, OpenVMS
or Linux

600MHz EV67 256MB-2GB

Recommended
options

Monit
15" C

ELSA G.

SN-PBXGK-BB

KZPBA-CA

RZ1DD
9.1GB

DS-RZ2DD-WA

CPU
Cache 2MB

512MB
Mem

ECC
3U Box

128bits Cross Bar 1.3GB/s

2x NI PCI, 64bits

4x PCI

AlphaServer
DS10

UltraIDE

40x

CD

3.5" 3.5" 3.5" / 5.25"

3X-BN50A-03 SCSI-kit

- Mouse
- Kb
- Com1
- Com2
- Parallel
- RMC

Ethernet DS10 UNIX Uscsi-based + External RAID DS10 UNIX One-box
 Ethernet
 FDDI

QA-054AA-H8 SW LP PKG U/A CDRM/D
 QA-MT4AA-GZ Dig UNIX Alpha DOC F
 QA-MT4AA-H8 Dig UNIX Alpha CDRM

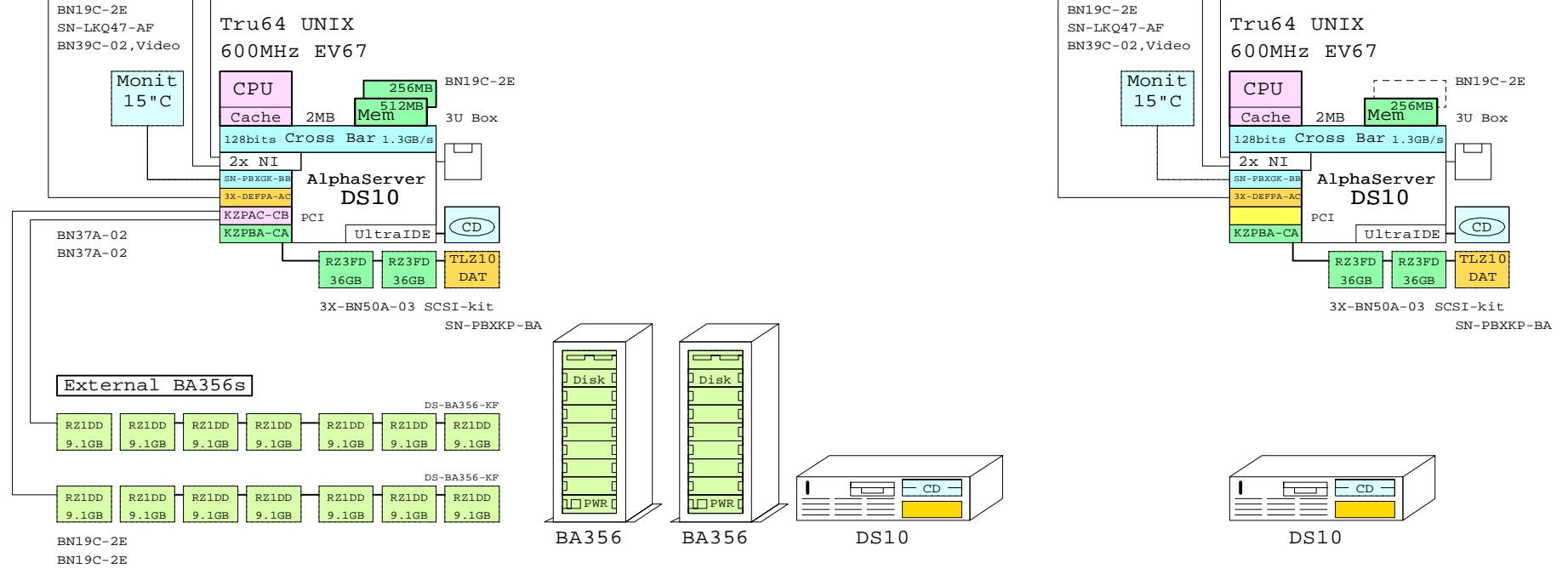

Bill of Material for Uscsi-system

Part Number	Qty	Description
1	1	DA-73BAA-EA AS DS10 67/600 512MB UNIX
1.1	1	3R-VRQV5-24 COMPAQ V55 CLR MON,NH,TCO95
1.2	1	3X-DEFPA-AC PCI to FDDI SAS MMF with SC,Universal
1.3	1	3X-MS310-CA DS10 256MB DIMM MEM
1.4	1	BN19C-2E PowerCable 240V, C-Europe
1.5	1	BN39C-02 1.8 Video Extension Cable ****
1.6	2	DS-RZ3FD-WA 36.4GB 10kRPM Ultra3 SCSI Disk
1.7	1	KZPAC-CB 3 Chan. SCSI RAID 8MB UltraW
1.8	1	KZPBA-CA PCI to UltraSCSI Adapter UWSE
1.9	1	SN-PBXGK-BB Elsa Gloria Synergy 8M Video Graphics
1.10	1	TLZ10-LB 12/24GB 4mm DAT 5.25" HH
2	1	DS-BA356-KF Pedestal Storage, UltraW, Single-Bus
2.1	7	DS-RZ1DD-VW 9.1GB 10000r UltraSCSI disk
3	1	DS-BA356-KF Pedestal Storage, UltraW, Single-Bus
3.1	7	DS-RZ1DD-VW 9.1GB 10000r UltraSCSI disk
4	1	3X-BN50A-03 SCSI cable kit, LED, 3x disk
5	1	SN-LKQ47-AF 102 KEY KYBD, NON-WIN, Finnish
6	1	SN-PBXKP-BA WIDE TO NARROW SCSI ADAPTER
7	3	BN19C-2E PowerCable 240V, C-Europe
8	2	BN37A-02 Ultra Chl VHDCI - VHDCI

Bill of Material for one-box system

Part Number	Qty	Description
1	1	DA-73BAA-DA AS DS10 67/600 256MB UNIX
1.1	1	3R-VRQV5-24 COMPAQ V55 CLR MON,NH,TCO95
1.2	1	3X-DEFPA-AC PCI to FDDI SAS MMF with SC,Universal
1.3	1	BN19C-2E PowerCable 240V, C-Europe
1.4	1	BN39C-02 1.8 Video Extension Cable ****
1.5	2	DS-RZ3FD-WA 36.4GB 10kRPM Ultra3 SCSI Disk
1.6	1	KZPBA-CA PCI to UltraSCSI Adapter UWSE
1.7	1	SN-PBXGK-BB Elsa Gloria Synergy 8M Video Graphics
1.8	1	TLZ10-LB 12/24GB 4mm DAT 5.25" HH
2	1	3X-BN50A-03 SCSI cable kit, LED, 3x disk
3	1	SN-LKQ47-AF 102 KEY KYBD, NON-WIN, Finnish
4	1	SN-PBXKP-BA WIDE TO NARROW SCSI ADAPTER
5	1	BN19C-2E PowerCable 240V, C-Europe

www.Compaq.com/golden-eggs
 Since: Oct-2000

COMPAQ 06-Feb-2001 GTAUDS102
 Matti.Patari@Compaq.com

AlphaServer DS10 UNIX Systems
 GOLDEN EGGS Visuals, Helsinki

Ethernet DS10 OpenVMS Uscsi-based + External RAID DS10 OpenVMS One-box
 Ethernet
 FDDI

QA-001AA-GZ OVMS Full Documentat
 QA-03XAA-H8 SW LP PKG V/A DOC CD
 QA-MT1AA-H8 OVMS Alpha Bin+Onlin

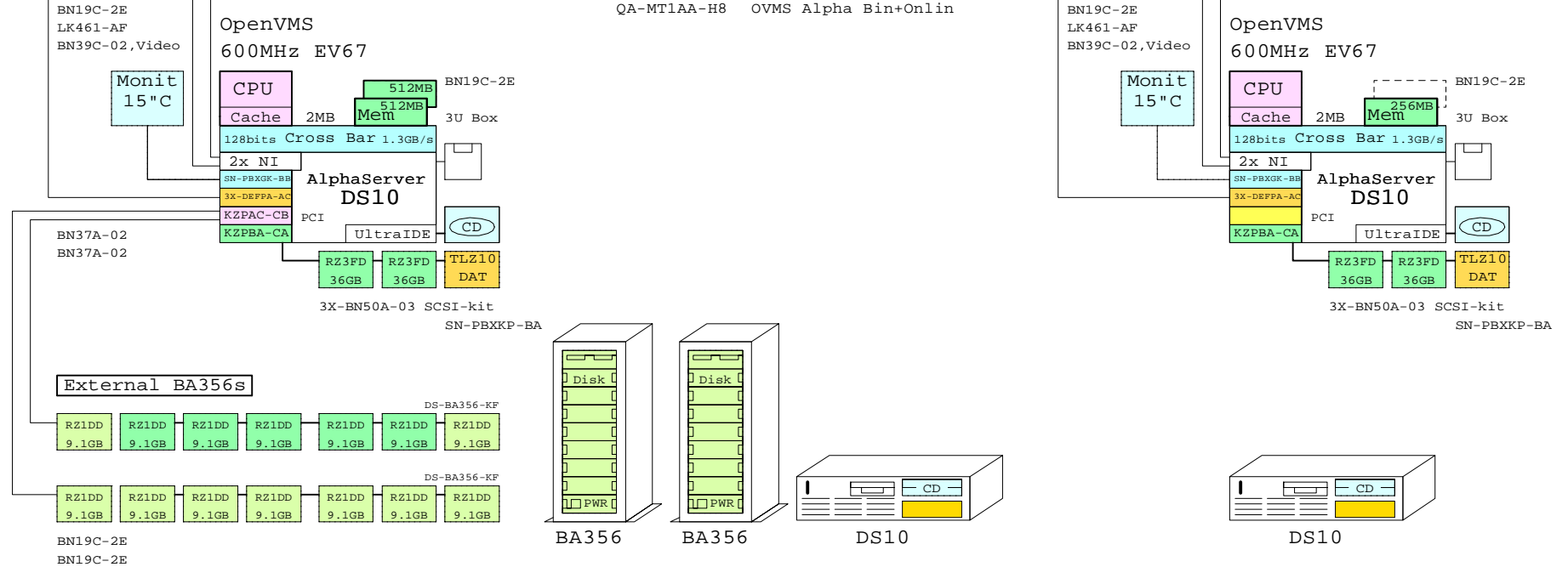

Bill of Material for Uscsi-system

Part Number	Qty	Description
1	1	DY-73BAA-EA AS DS10 67/600 512MB OpenVMS
1.1	1	3R-VRQV5-24 COMPAQ V55 CLR MON,NH,TCO95
1.2	1	3X-DEFFA-AC PCI to FDDI SAS MMF with SC,Universal
1.3	1	3X-MS310-DA DS10 512MB DIMM MEM
1.4	1	BN19C-2E PowerCable 240V, C-Europe
1.5	1	BN39C-02 1.8 Video Extension Cable ****
1.6	2	DS-RZ3FD-WA 36.4GB 10kRPM Ultra3 SCSI Disk
1.7	1	KZPAC-CB 3 Chan. SCSI RAID 8MB UltraW
1.8	1	KZPBA-CA PCI to UltraSCSI Adapter UWSE
1.9	1	SN-PBXGK-BB Elsa Gloria Synergy 8M Video Graphics
1.10	1	TLZ10-LB 12/24GB 4mm DAT 5.25" HH
2	1	DS-BA356-KF Pedestal Storage, UltraW, Single-Bus
2.1	7	DS-RZ1DD-VW 9.1GB 10000r UltraSCSI disk
3	1	DS-BA356-KF Pedestal Storage, UltraW, Single-Bus
3.1	7	DS-RZ1DD-VW 9.1GB 10000r UltraSCSI disk
4	1	3X-BN50A-03 SCSI cable kit, LED,3x disk
5	1	SN-PBXKP-BA WIDE TO NARROW SCSI ADAPTER
6	3	BN19C-2E PowerCable 240V, C-Europe
7	2	BN37A-02 Ultra Chl VHDCI - VHDCI
8	1	LK461-AF VMS STYLE KEYBOARD, Fin/Swed

Bill of Material for One-box system

Part Number	Qty	Description
1	1	DY-73BAA-DA AS DS10 67/600 256MB OpenVMS
1.1	1	3R-VRQV5-24 COMPAQ V55 CLR MON,NH,TCO95
1.2	1	3X-DEFFA-AC PCI to FDDI SAS MMF with SC,Universal
1.3	1	BN19C-2E PowerCable 240V, C-Europe
1.4	1	BN39C-02 1.8 Video Extension Cable ****
1.5	2	DS-RZ3FD-WA 36.4GB 10kRPM Ultra3 SCSI Disk
1.6	1	KZPBA-CA PCI to UltraSCSI Adapter UWSE
1.7	1	SN-PBXGK-BB Elsa Gloria Synergy 8M Video Graphics
1.8	1	TLZ10-LB 12/24GB 4mm DAT 5.25" HH
2	1	3X-BN50A-03 SCSI cable kit, LED,3x disk
3	1	SN-PBXKP-BA WIDE TO NARROW SCSI ADAPTER
4	1	BN19C-2E PowerCable 240V, C-Europe
5	1	LK461-AF VMS STYLE KEYBOARD, Fin/Swed

www.Compaq.com/golden-eggs
 Since:Oct-2000

COMPAQ 06-Feb-2001 GTAVDS102
 Matti.Patari@Compaq.com

AlphaServer DS10 OpenVMS Syst.
 GOLDEN EGGS Visuals, Helsinki

Ethernet
Ethernet

DS10 Linux Ready Uscsi-based + External RAID

DS10 Linux Ready One-box

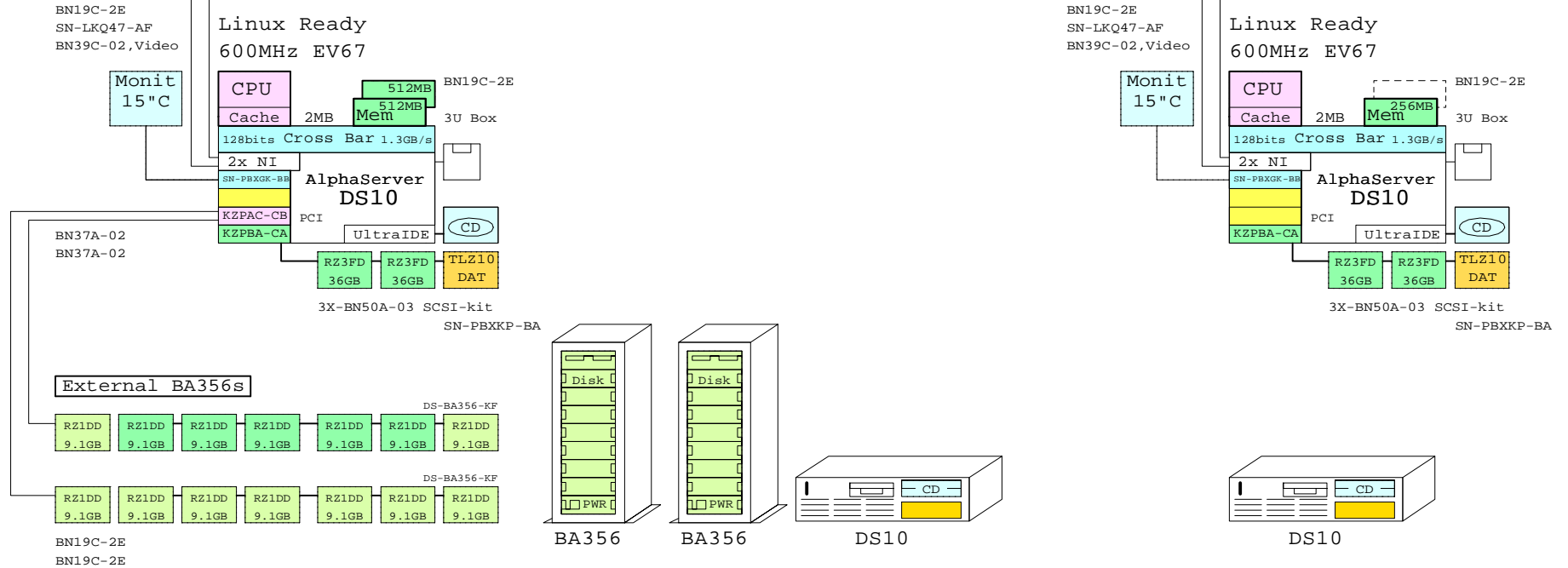

Bill of Material for Uscsi-system

	Part Number	Qty	Description
1	DJ-73BAA-EA	1	AS DS10 67/600 512MB Linux Ready
1.1	3R-VRQV5-24	1	COMPAQ V55 CLR MON,NH,TCO95
1.2	3X-MS310-DA	1	DS10 512MB DIMM MEM
1.3	BN19C-2E	1	PowerCable 240V, C-Europe
1.4	BN39C-02	1	1.8 Video Extension Cable ****
1.5	DS-RZ3FD-WA	2	36.4GB 10kRPM Ultra3 SCSI Disk
1.6	KZPAC-CB	1	3 Chan. SCSI RAID 8MB UltraW
1.7	KZPBA-CA	1	PCI to UltraSCSI Adapter UWSE
1.8	SN-PBXGK-BB	1	Elsa Gloria Synergy 8M Video Graphics
1.9	TLZ10-LB	1	12/24GB 4mm DAT 5.25" HH
2	DS-BA356-KF	1	Pedestal Storage, UltraW, Single-Bus
2.1	DS-RZ1DD-VW	7	9.1GB 10000r UltraSCSI disk
3	DS-BA356-KF	1	Pedestal Storage, UltraW, Single-Bus
3.1	DS-RZ1DD-VW	7	9.1GB 10000r UltraSCSI disk
4	3X-BN50A-03	1	SCSI cable kit, LED,3x disk
5	SN-LKQ47-AF	1	102 KEY KYBD, NON-WIN, Finnish
6	SN-PBXKP-BA	1	WIDE TO NARROW SCSI ADAPTER
7	BN19C-2E	3	PowerCable 240V, C-Europe
8	BN37A-02	2	Ultra Chl VHDCI - VHDCI

Bill of Material for one-box system

	Part Number	Qty	Description
1	DJ-73BAA-DA	1	AS DS10 67/600 256MB Linux Ready
1.1	3R-VRQV5-24	1	COMPAQ V55 CLR MON,NH,TCO95
1.2	BN19C-2E	1	PowerCable 240V, C-Europe
1.3	BN39C-02	1	1.8 Video Extension Cable ****
1.4	DS-RZ3FD-WA	2	36.4GB 10kRPM Ultra3 SCSI Disk
1.5	KZPBA-CA	1	PCI to UltraSCSI Adapter UWSE
1.6	SN-PBXGK-BB	1	Elsa Gloria Synergy 8M Video Graphics
1.7	TLZ10-LB	1	12/24GB 4mm DAT 5.25" HH
2	3X-BN50A-03	1	SCSI cable kit, LED,3x disk
3	SN-LKQ47-AF	1	102 KEY KYBD, NON-WIN, Finnish
4	SN-PBXKP-BA	1	WIDE TO NARROW SCSI ADAPTER
5	BN19C-2E	1	PowerCable 240V, C-Europe

www.Compaq.com/golden-eggs
Since: Oct-2000



06-Feb-2001 GTALDS102
Matti.Patari@Compaq.com

This template is included in the present GOLDEN EGGS Software kit.

DS10 Linux

AlphaServer DS10 Linux Systems
GOLDEN EGGS Visuals, Helsinki

AlphaServer DS20E 67/667 Systems

Order number	Operating system	Server systems, 64bits 667MHz
#1 DA-56PAA- -DA 256MB -EA 512MB -FA 1GB	DIGITAL UNIX	(Disk) RX,CD (NI SVGA)
DY-56PAA- **	OpenVMS	(Disk) RX,CD (NI SVGA)
DJ-56PAA- **	Linux Ready	(Disk) RX,CD (NI SVGA)
#2 Tower system		#2 Cabinet system
3X-BA56P-PB Tower kit		3X-BA56R-RC Rack mount kit
3X-BA610-6D Disk drive cage,6		3X-BA610-6D Disk drive cage,6
3R-A0585-AA Disk drive, 18GB		3R-A0585-AA Disk drive, 18GB
3X-KZPCA-AA Ultra2 SCSI adapter		3X-KZPCA-AA Ultra2 SCSI adapter
3X-DE600-AA Ethernet adapter		3X-DE600-AA Ethernet adapter
BN25G-10 Cable twisted, 10m		BN25G-10 Cable twisted, 10m
SN-PBXGK-BB Elsa Gloria 8MB		SN-PBXGK-BB Elsa Gloria 8MB
BN19C-2E Power cord		BN35S-4E CPU power cord for cab
		H9A15-MC/MD Cabinet 120V/240V 38U
		H9C15-TF Cabinet rear extender
		H9C15-TF Cabinet front door
		H9C10-MC Ballast kit 40lbs
		YS-ASCAA-AA Factory integration

#3 SVGA color monitor #4 Select a keyboard and one powercord for pedestal.

15" 3R-A2832-AA
17" 3R-A2261-AA
Europe
BN39C-02 2m ext.cable

SN-LKQ47 UNIX, Lin	-AE GB	-AG G	-AM S	BN19C-2E Europe
LK461 OVMS	-AB B	-AH NL	-AN N	BN19A-2E GB
	-AD DK	-AI I	-AP F	BN19E-2E CH
	-AF FI	-AK CH	-AS E	BN19K-2E DK
				BN19Z-2E I

Internal options

Memory expansion

DIMM-kits	Max memory
MS340-CA 256MB	4x 1GB =4GB
MS340-DA 512MB	
MS340-EA 1GB	

Additional CPUs

KN311-BB UNIX 667MHz
KN311-BC OVMS 667MHz
KN311-BD Linux 667MHz

3rd Power

FR-H7910-AA For N+1

Internal storage

Tape storage

TLZ10-LB 12/24GB DAT SCSI tape
3X-BC56C-2F SCSI cable for tape

Disk storage

3R-A0584-AA 9.2GB Ultra3 U-disk 10k
3R-A0585-AA 18.2GB Ultra3 U-disk 10k
3R-A0919-AA 36.4GB Ultra3 U-disk 10k

3X-KZPCA-AA LVD SCSI adapter
KZPBA-CA UltraSCSI SE adapter
BN38C-02 2m SCSI cable, 68HD-VHDCI.
KZPAC-CB RAID 3-port, 8MB cache
KZPSC-UB Cache battery
BN37A-02 2m SCSI cbl VHDCI-VHDCI.

Controllers

SN-PBXGK-BB ELSA Gloria Graph. 8MB
3X-DEPVD-AA Permedia 2 + Ethernet
3X-DE600-AA Fast Ethernet 10/100
3X-DEFPA-DC FDDI DAS MMF SC
DEGPA-SA Gigabit Ethernet
KZPBA-CB UltraSCSI Diff, 68HD

External options

Tape storage

DS-TZ89N-TA 35/70GB DLT tape, TT
BN21K-02 SCSI cable, FWD
BN19C-2E Power cord, Europe
KZPBA-CA UltraSCSI SE adapter

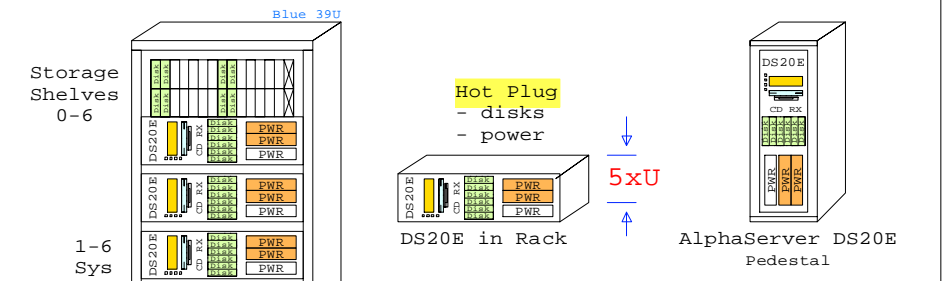
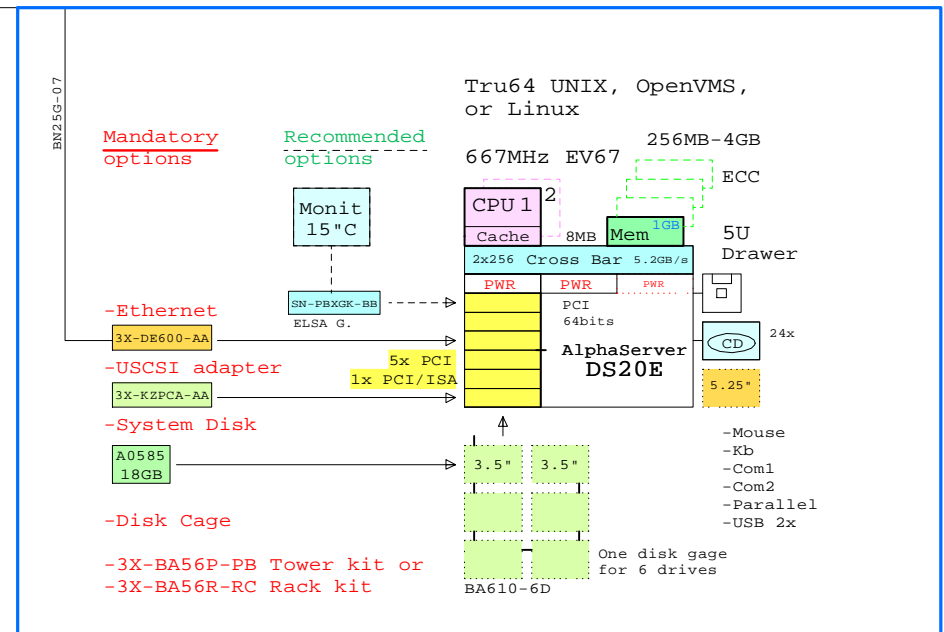

Licenses included:

- DIGITAL UNIX V4.0F, Base license, Unlimited User license, Server Extension license, and Internet Access Software license and Netscape's Enterprise Server 3.0.
- OpenVMS V7.2-1, Base license and DIGITAL Enterprise Integration Package.

	@667MHz
SPECint95	40
SPECfp95	84
SPECweb99	685
TPC

Software Processor Code: **E**

COMPAQ	05-Feb-2001	GEADS20E3
	Matti.Patari@compaq.com	
AlphaServer DS20E 667MHz Syst.		
GOLDEN EGGS Visuals, Helsinki		

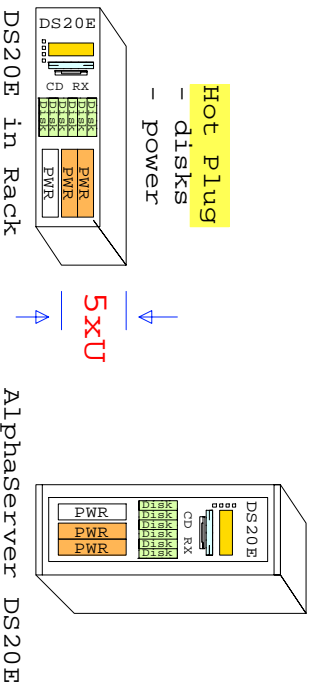
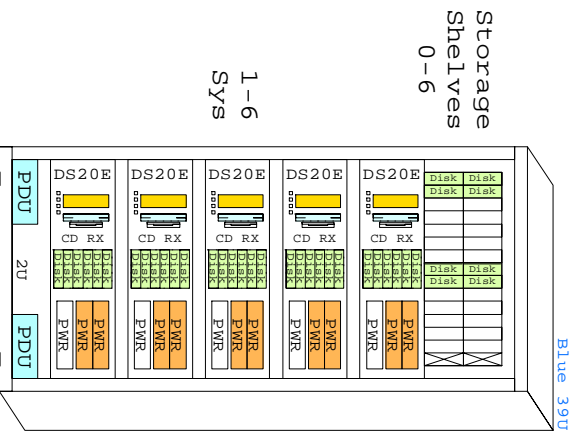
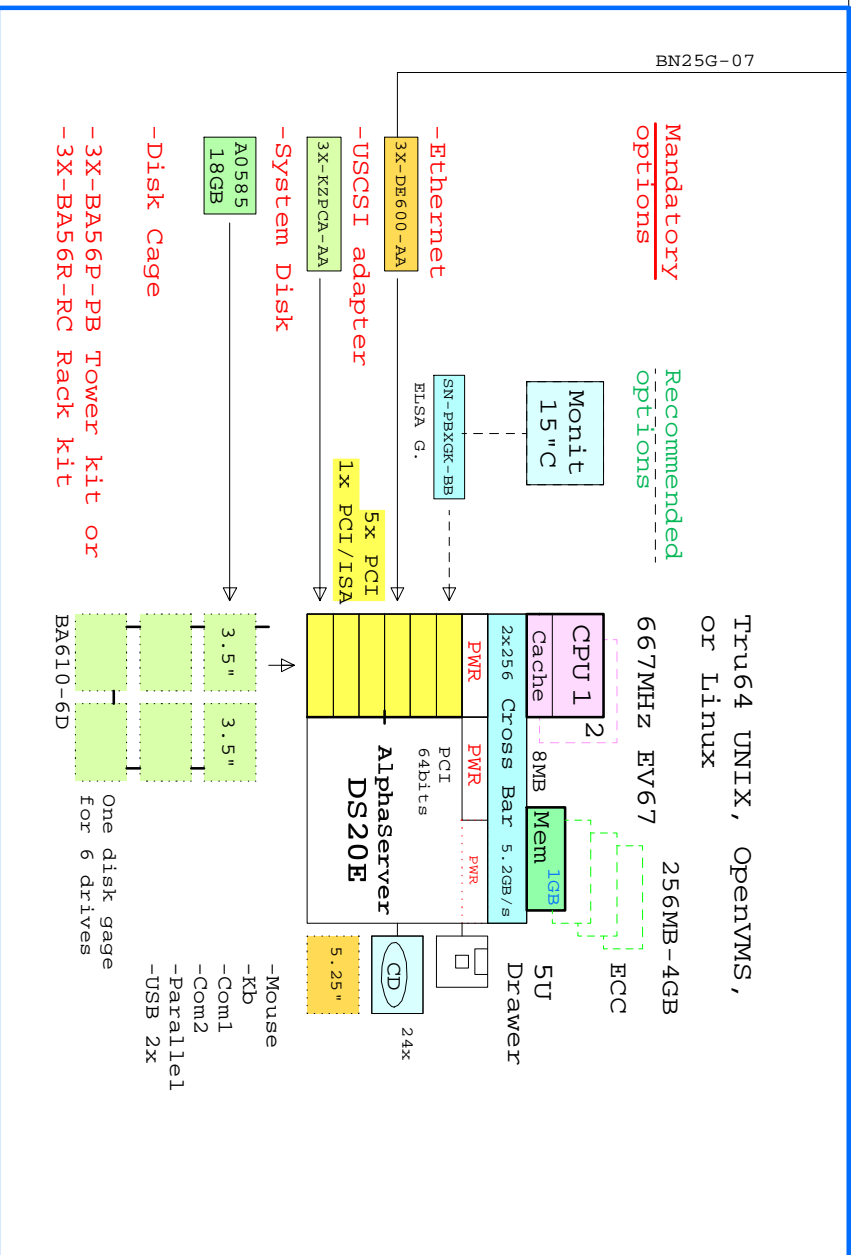

Licenses included:

- DIGITAL UNIX V4.0F, Base license, Unlimited User license, Server Extension license, and Internet Access Software license and Netscape's Enterprise Server 3.0.
- OpenVMS V7.2-1, Base license and DIGITAL Enterprise Integration Package.

	@667MHz
SPECint95	40
SPECfp95	84
SPECweb99	685
TPC	...

Software Processor Code: **E**

COMPAQ	05-Feb-2001	GEADSS20E3
	Matt.I.Patarl@compaq.com	

AlphaServer DS20E 667MHz Syst. GOLDEN EGGS Visuals, Helsinki

DS20E

BN25G-07

Tru64 UNIX, OpenVMS,
or Linux

Mandatory options

Recommended options

-Ethernet

3X-DE600-AA

-USCSI adapter

3X-KZPCA-AA

-System Disk

A0585
18GB

-Disk Cage

-3X-BA56P-PB Tower kit or
-3X-BA56R-RC Rack kit

Monit
15" C

SN-PBXGK-BB
ELSA G.

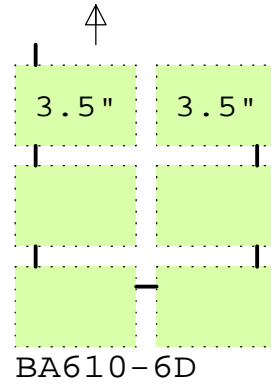
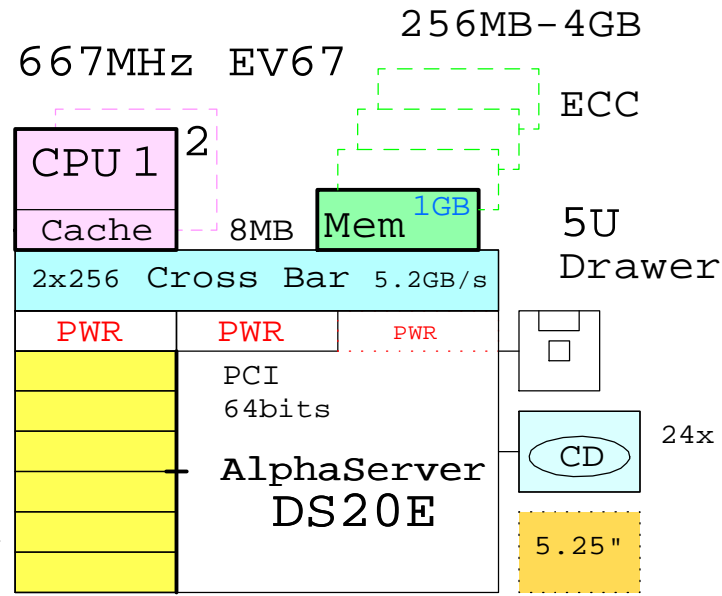

- Mouse
- Kb
- Com1
- Com2
- Parallel
- USB 2x

DS20E expanded Tru64 UNIX system

FDDI

Ethernet

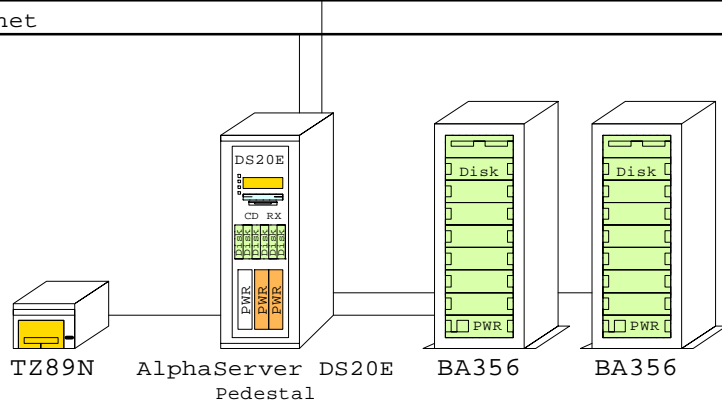

Bill of material

	Part Number	Qty	Description
1	3X-BA56P-PB	1	DS20E Mini tower pedestal kit,667MHz
1.1	DA-56PAA-EA	1	AS DS20E 6/667 512MB,Rack,UNIX
1.1.1	3X-BC56C-2F	1	DS20E SCSI Cable Kit
1.1.2	3X-DEFPA-DC	1	PCI to FDDI DAS MMF with SC,Universal
1.1.3	3X-KZPCA-AA	1	Single channel LVD adapter
1.1.4	BA610-6D	1	ES40 Disk Drive Cage, 6-Bay
1.1.4.1	3R-A0585-AA	4	18.2GB Uscsi3 10k Universal disk 1"
1.1.5	FR-H7910-AA	1	Third power supply for DS20E
1.1.6	KN311-BB	1	AS DS20E 6/667 SMP UPG UNIX
1.1.7	KZPBA-CA	2	PCI to UltraSCSI Adapter UWSE
1.1.8	KZPCM-DA	1	Dual Uscsi with FastEther PCI
1.1.9	MS340-CA	1	DS20 256MB SDIMM MEM 4x64MB
1.1.10	MS340-DA	1	DS20 512MB SDIMM MEM 4x128MB
1.1.11	SN-PBXGK-BB	1	Elsa Gloria Synergy 8M Video Graphics
1.1.12	TLZ10-LB	1	12/24GB 4mm DAT 5.25" HH
2	DS-BA356-KF	1	Pedestal Storage, UltraW, Single-Bus
2.1	BN19C-2E	2	PowerCable 240V, C-Europe
2.2	BN38C-02	1	Ultra Cbl VHDCI - 68HD
2.3	CK-BA35X-HH	1	180W Stor.Shelf PWR for AS4x00
2.4	DS-RZ1ED-VW	6	18.2GB 10000r UltraSCSI disk
3	DS-BA356-KF	1	Pedestal Storage, UltraW, Single-Bus
3.1	BN19C-2E	2	PowerCable 240V, C-Europe
3.2	BN38C-02	1	Ultra Cbl VHDCI - 68HD
3.3	CK-BA35X-HH	1	180W Stor.Shelf PWR for AS4x00
3.4	DS-RZ1ED-VW	6	18.2GB 10000r UltraSCSI disk
4	3R-A2832-AA	1	COMPAQ Monitor S510 15" NH, EU
5	DS-TZ89N-TA	1	35/70GB SE DLT-tape TT FWSE
6	BN39C-02	1	1.8 Video Extension Cable ****
7	SN-LKQ47-AF	1	102 KEY KYBD, NON-WIN, Finnish
8	BN19C-2E	5	PowerCable 240V, C-Europe
9	BN38C-02	1	Ultra Cbl VHDCI - 68HD

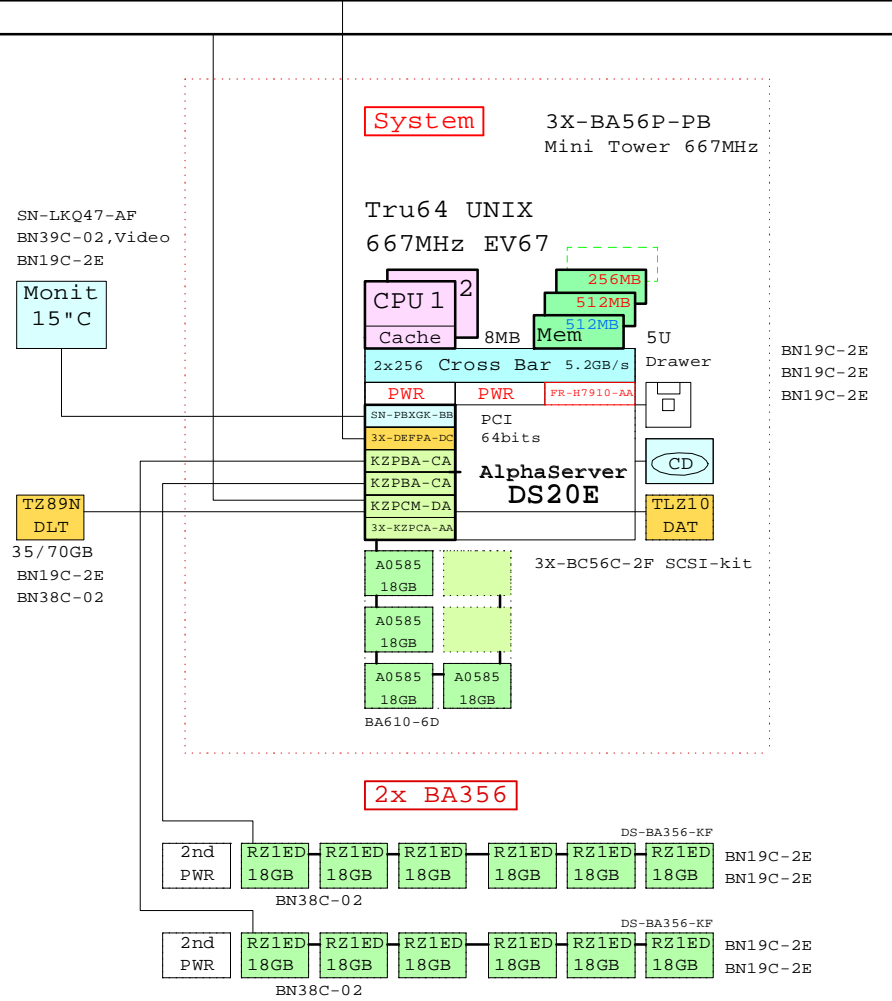

This template is included in the present GOLDEN EGGS Software kit.

DS20E UNIX

COMPAQ 05-Feb-2001 GTAUDS20EA
Matti.Patari@compaq.com

AlphaServer DS20E UNIX System
GOLDEN EGGS Visuals, Helsinki

DS20E expanded Tru64 UNIX RAID system

FDDI

Ethernet

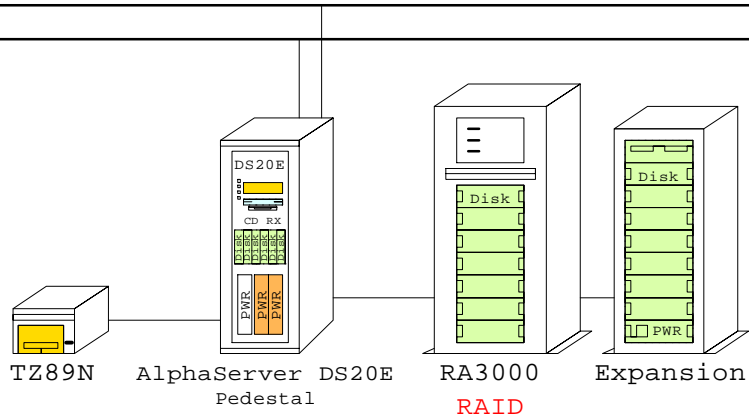

SN-LKQ47-AF
BN39C-02, Video
BN19C-2E

Monit
15" C

TZ89N
DLT
35/70GB
BN19C-2E
BN38C-02

System 3X-BA56P-PB
Mini Tower 667MHz

Tru64 UNIX
667MHz EV67

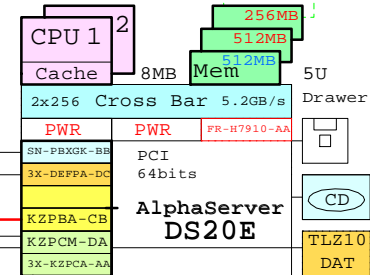

BN19C-2E
BN19C-2E
BN19C-2E

3X-BC56C-2F SCSI-kit

BA610-6D

RA3000 RAID and Expansion

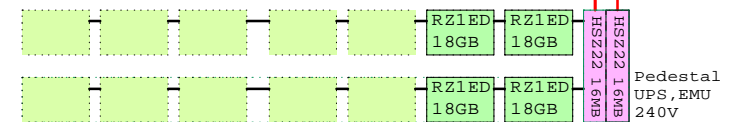

QB-5TWAB-SA Sol sw RA3000 Alp UN

BN19C-2E
BN19C-2E

Pedestal
UPS, EMU
240V

Bill of material

Part Number	Qty	Description
1	3X-BA56P-PB	1 DS20E Mini tower pedestal kit,667MHz
1.1	DA-56PAA-EA	1 AS DS20E 6/667 512MB,Rack,UNIX
1.1.1	3X-BC56C-2F	1 DS20E SCSI Cable Kit
1.1.2	3X-DEFFA-DC	1 PCI to FDDI DAS MMF with SC,Universal
1.1.3	3X-KZPCA-AA	1 Single channel LVD adapter
1.1.4	BA610-6D	1 ES40 Disk Drive Cage, 6-Bay
1.1.4.1	3R-A0585-AA	4 18.2GB Uscsi3 10k Universal disk 1"
1.1.5	FR-H7910-AA	1 Third power supply for DS20E
1.1.6	KN311-BB	1 AS DS20E 6/667 SMP UPG UNIX
1.1.7	KZPBA-CB	1 PCI to UltraSCSI Adapter UWdif
1.1.8	KZPCM-DA	1 Dual Uscsi with FastEther PCI
1.1.9	MS340-CA	1 DS20 256MB SDIMM MEM 4x64MB
1.1.10	MS340-DA	1 DS20 512MB SDIMM MEM 4x128MB
1.1.11	SN-PBXGK-BB	1 Elsa Gloria Synergy 8M Video Graphics
1.1.12	TLZ10-LB	1 12/24GB 4mm DAT 5.25" HH
2	DS-SWXRA-GC	1 RA3000 Pedestal one HSZ22 240V
2.1	DS-HSZ22-AA	1 HSZ22 controller 16MB
2.2	DS-RZ1ED-VW	2 18.2GB 10000r UltraSCSI disk
2.3	DS-SWXRA-GD	1 RA3000 Pedestal Expans 120/240
2.3.1	DS-RZ1ED-VW	2 18.2GB 10000r UltraSCSI disk
3	QB-5TWAB-SA	1 Sol sw RA3000 Alp UNIX
4	3R-A2832-AA	1 COMPAQ Monitor S510 15" NH, EU
5	DS-TZ89N-TA	1 35/70GB SE DLT-tape TT FWSE
6	BN39C-02	1 1.8 Video Extension Cable ****
7	SN-LKQ47-AF	1 102 KEY KYBD, NON-WIN, Finnish
8	BN19C-2E	7 PowerCable 240V, C-Europe
9	BN38C-02	1 Ultra Cbl VHDCI - 68HD

www.Compaq.com/golden-eggs
Since:Jun-2000

COMPAQ	05-Feb-2001	GTAUDS20EB
	Matti.Patari@compaq.com	

AlphaServer DS20E UNIX RAID
GOLDEN EGGS Visuals, Helsinki

DS20E UNIX Cluster with in-cabinet RA3000 RAID storage

Ethernet
FDDI

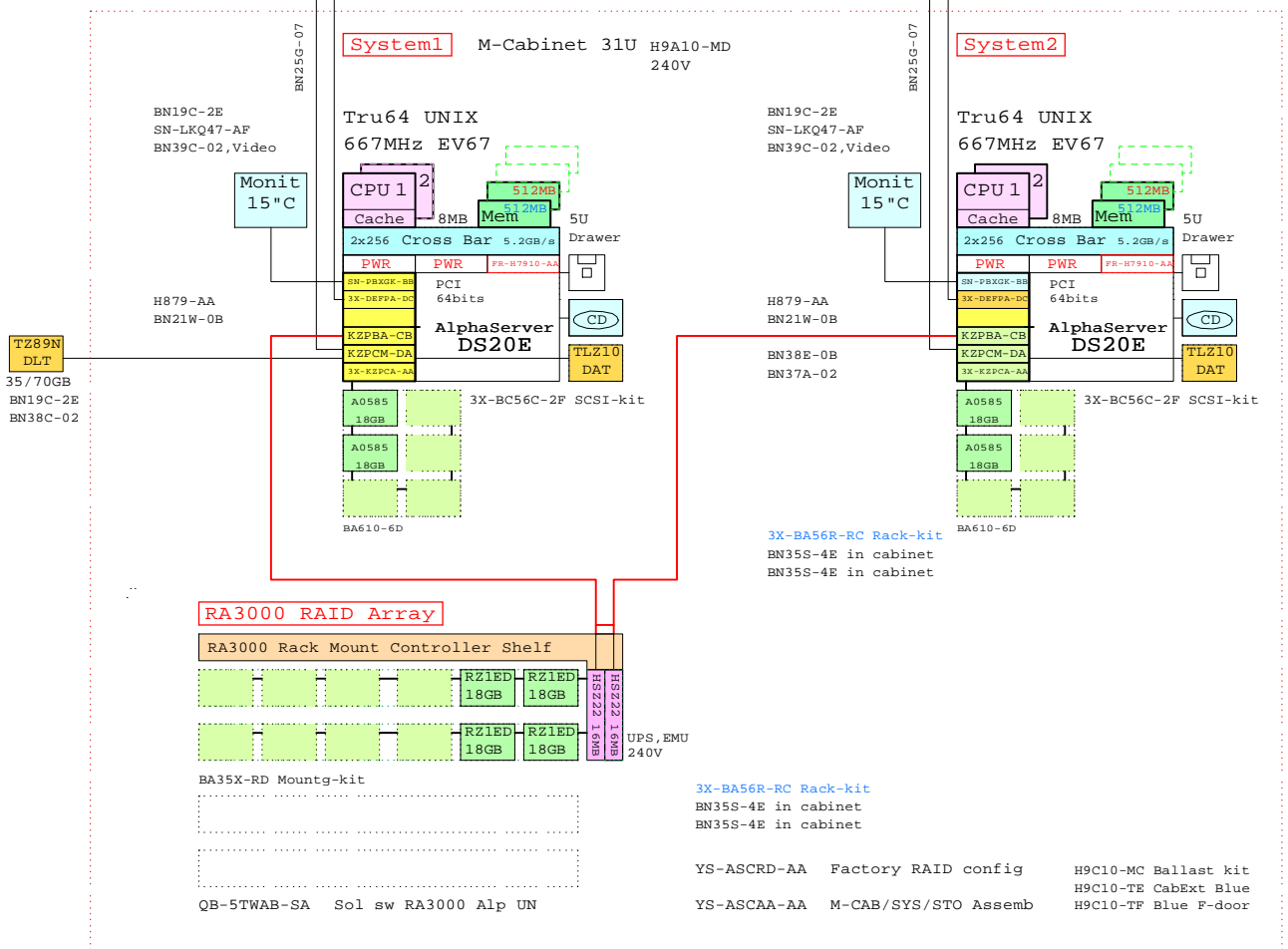

BOM for this cabinet system

Part Number	Qty	Description
1		H9A10-MD 1 M-Series Cab,H9A10 Blue,240V 31U
1.1		3X-A2832-AA 2 COMPAQ Monitor S510 15" NH, EU
1.2		3X-BA56R-RC 2 Rackm.kit_DS20E,667MHz for M-series
1.3		BA35X-RD 1 Mounting Kit, metric
1.4		BN19C-2E 2 PowerCable 240V, C-Europe
1.5		BN21W-0B 2 Y SCSI-2 Cable 68 pins/6".15m
1.6		BN25G-07 2 17-03212-05 8MP-8MP PATCH CBL
1.7		BN35S-4E 4 PowerCord C13 to C14, Non US
1.8		BN37A-02 1 Ultra Ch1 VHDCI - VHDCI
1.9		BN38E-0B 1 Ultra Ch1 VHDCI - 68HD
1.10		BN39C-02 2 1.8 Video Extension Cable ****
1.11		DA-56PAA-EA 1 AS DS20E 6/667 512MB,Rack,UNIX
1.11.1		3X-BC56C-2F 1 DS20E SCSI Cable Kit
1.11.2		3X-DEFFA-DC 2 PCI to FDDI DAS MMF with SC,Universal
1.11.3		3X-KZPCA-AA 1 Single channel LVD adapter
1.11.4		BA610-6D 1 BS40 Disk Drive Cage, 6-Bay
1.11.4.1		3R-A0585-AA 2 18.2GB Uscsi3 10k Universal disk 1"
1.11.5		FR-H7910-AA 1 Third power supply for DS20E
1.11.6		KN311-BB 1 AS DS20E 6/667 SMP UPG UNIX
1.11.7		KZPBA-CB 1 PCI to UltraSCSI Adapter UWdif
1.11.8		KZPCM-DA 1 Dual Uscsi with FastEther PCI
1.11.9		MS340-DA 1 DS20 512MB SDIMM MEM 4x128MB
1.11.10		SN-PBXGK-BB 1 Elsa Gloria Synergy 8M Video Graphics
1.11.11		TLZ10-LB 1 12/24GB 4mm DAT 5.25" HH
1.12		DA-56PAA-EA 1 AS DS20E 6/667 512MB,Rack,UNIX
1.12.1		3X-BC56C-2F 1 DS20E SCSI Cable Kit
1.12.2		3X-DEFFA-DC 2 PCI to FDDI DAS MMF with SC,Universal
1.12.3		3X-KZPCA-AA 1 Single channel LVD adapter
1.12.4		BA610-6D 1 BS40 Disk Drive Cage, 6-Bay
1.12.4.1		3R-A0585-AA 2 18.2GB Uscsi3 10k Universal disk 1"
1.12.5		FR-H7910-AA 1 Third power supply for DS20E
1.12.6		KN311-BB 1 AS DS20E 6/667 SMP UPG UNIX
1.12.7		KZPBA-CB 1 PCI to UltraSCSI Adapter UWdif
1.12.8		KZPCM-DA 1 Dual Uscsi with FastEther PCI
1.12.9		MS340-DA 1 DS20 512MB SDIMM MEM 4x128MB
1.12.10		SN-PBXGK-BB 1 Elsa Gloria Synergy 8M Video Graphics
1.12.11		TLZ10-LB 1 12/24GB 4mm DAT 5.25" HH
1.13		DS-SWXRA-GK 1 RA3000 Rackmount one HSZ22 240V
1.13.1		DS-HSZ22-AA 1 HSZ22 controller 16MB
1.13.2		DS-SWXRA-GN 1 RA3000 Rackmount Expan 120/240
1.13.2.1		DS-RZ1ED-VW 2 18.2GB 10000r UltraSCSI disk
1.13.3		DS-SWXRA-GN 1 RA3000 Rackmount Expan 120/240
1.13.3.1		DS-RZ1ED-VW 2 18.2GB 10000r UltraSCSI disk
1.14		H879-AA 2 SCSI-3 Term - 68 pin Male
1.15		H9C10-MC 1 Ballast Kit for cabinets
1.16		H9C10-TE 1 Rear cab extender for H9A10 Blue
1.17		H9C10-TF 1 FrontDoorKit Blue for H9A10
1.18		QB-5TWAB-SA 1 Sol sw RA3000 Alp UNIX
1.19		SN-LKQ47-AF 2 102 KEY KYBD,NON-WIN, Finnish
1.20		YS-ASCAA-AA 1 M-CAB/SYS/STO Assembly
1.21		YS-ASCRD-AA 1 Factory configured RAID sets of BA370
2		DS-TZ89N-TA 1 35/70GB SE DLT-tape TT FWSE
3		BN19C-2E 1 PowerCable 240V, C-Europe
4		BN38C-02 1 Ultra Ch1 VHDCI - 68HD

www.Compaq.com/golden-eggs
Since:Jun-2000

COMPAQ 05-Feb-2001 GTAUDS20EC
Matti.Patari@Compaq.com

AlphaServer DS20E UNIX Cluster
GOLDEN EGGS Visuals, Helsinki

DS20E UNIX

This template is included in the present GOLDEN EGGS Software kit.

DS20E UNIX Cluster with in-cabinet RAID storage

Ethernet
FDDI

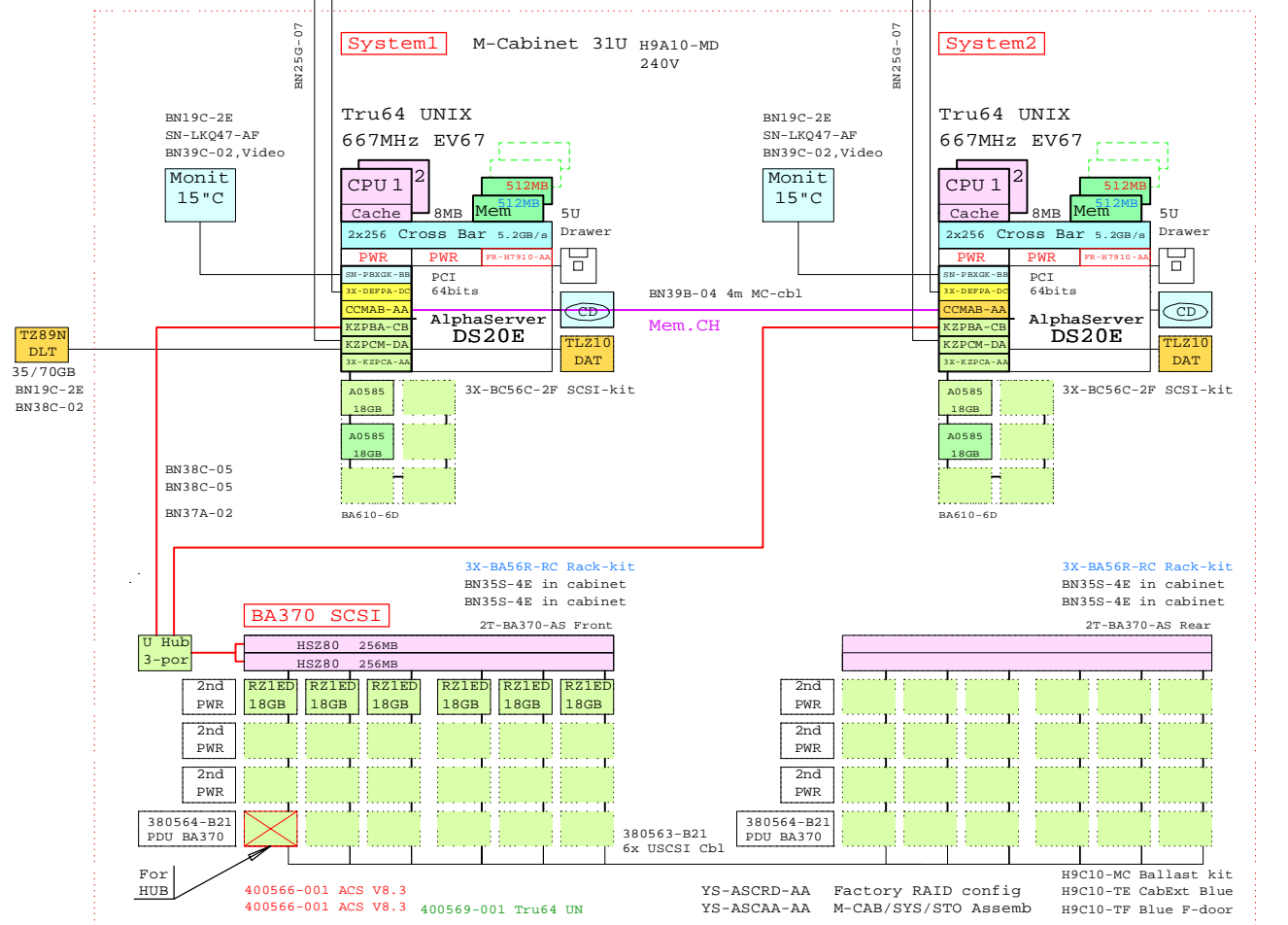

BOM for this cabinet system

Part Number	Qty	Description
1	H9A10-MD	1 M-Series Cab,H9A10.Blue,240V 31U
1.1	2T-BA370-AR	1 BA370 shelf,slides Rear RackMount
1.1.1	380564-B21	1 Power Distribution Unit RA8K/7K
1.1.2	380565-B21	3 Power Suply 180W Hot Plug SBB
1.2	2T-BA370-AS	1 BA370 shelf,slides Front RackMount
1.2.1	380564-B21	1 Power Distribution Unit RA8K/7K
1.2.2	380565-B21	3 Power Suply 180W Hot Plug SBB
1.2.3	400565-B21	2 Ultra Opt.1 cont w 2x128MB cache HS280
1.2.4	DS-DWZZH-03	1 Uscsi Act hub 0 SE:3/Dif 3.5" SBB
1.2.5	DS-RZ1ED-VW	6 18.2GB 10000R UltraSCSI disk
1.3	380563-B21	1 Set of six USCSI cables
1.4	3R-A2832-AA	2 COMPAQ Monitor S510 15" NH, EU
1.5	3X-BA56R-RC	2 Rackm.kit DS20E,667MHz for M-series
1.6	400566-001	2 SZ80 Controller Software ACS V8.3
1.7	400569-001	1 Ultra opt OS Software Tru64 UNIX
1.8	BN19C-2E	2 PowerCable 240V, C-Europe
1.9	BN25G-07	2 17-03212-05 8MP-8MP PATCH CBL
1.10	BN35S-4E	4 PowerCord CL3 to CL4, Non US
1.11	BN37A-02	1 Ultra Chl VHDCl - VHDCl
1.12	BN38C-05	2 Ultra Chl VHDCl - 68HD
1.13	BN39B-04	1 04m copper cbl for CCMAB Mem.Chan
1.14	BN39C-02	2 1.8 Video Extension Cable ****
1.15	DA-56PAA-EA	1 AS DS20E 6/667 512MB,Rack,UNIX
1.15.1	3X-BC56C-2F	1 DS20E SCSI Cable Kit
1.15.2	3X-DEFFA-DC	1 PCI to FDDI DAS MMF with SC,Universal
1.15.3	3X-KZPCA-AA	1 Single channel LVD adapter
1.15.4	BA610-6D	1 ES40 Disk Drive Cage, 6-Bay
1.15.4.1	3R-A0585-AA	2 18.2GB Uscsi3 10k Universal disk 1"
1.15.5	CCMAB-AA	1 PCI Mem. Channel-2 Cluster cntrl
1.15.6	FR-H7910-AA	1 Third power supply for DS20E
1.15.7	KN311-BB	1 AS DS20E 6/667 SMP UPG UNIX
1.15.8	KZPBA-CB	1 PCI to UltraSCSI Adapter UWdif
1.15.9	KZPCM-DA	1 Dual Uscsi with FastEther PCI
1.15.10	MS340-DA	1 DS20 512MB SDIMM MEM 4x128MB
1.15.11	SN-PBXGK-BB	1 Elsa Gloria Synergy 8M Video Graphics
1.15.12	TLZ10-LB	1 12/24GB 4mm DAT 5.25" HH
1.16	DA-56PAA-EA	1 AS DS20E 6/667 512MB,Rack,UNIX
1.16.1	3X-BC56C-2F	1 DS20E SCSI Cable Kit
1.16.2	3X-DEFFA-DC	1 PCI to FDDI DAS MMF with SC,Universal
1.16.3	3X-KZPCA-AA	1 Single channel LVD adapter
1.16.4	BA610-6D	1 ES40 Disk Drive Cage, 6-Bay
1.16.4.1	3R-A0585-AA	2 18.2GB Uscsi3 10k Universal disk 1"
1.16.5	CCMAB-AA	1 PCI Mem. Channel-2 Cluster cntrl
1.16.6	FR-H7910-AA	1 Third power supply for DS20E
1.16.7	KN311-BB	1 AS DS20E 6/667 SMP UPG UNIX
1.16.8	KZPBA-CB	1 PCI to UltraSCSI Adapter UWdif
1.16.9	KZPCM-DA	1 Dual Uscsi with FastEther PCI
1.16.10	MS340-DA	1 DS20 512MB SDIMM MEM 4x128MB
1.16.11	SN-PBXGK-BB	1 Elsa Gloria Synergy 8M Video Graphics
1.16.12	TLZ10-LB	1 12/24GB 4mm DAT 5.25" HH
1.17	H9C10-MC	1 Ballast Kit for cabinets
1.18	H9C10-TE	1 Rear cab extender for H9A10 Blue
1.19	H9C10-TF	1 FrontDoorKit Blue for H9A10
1.20	SN-LKQ47-AF	2 102 KEY KYBD, NON-WIN, Finnish
1.21	YS-ASCAA-AA	1 M-CAB/SYS/STO Assembly
1.22	YS-ASCRD-AA	1 Factory configured RAID sets of BA370
2	DS-TZ89N-TA	1 35/70GB SE DLT-tape TT FWSE
3	BN19C-2E	1 PowerCable 240V, C-Europe
4	BN38C-02	1 Ultra Chl VHDCl - 68HD

www.Compaq.com/golden-eggs
Since: Apr-2000

COMPAQ	06-Feb-2001	GTAUDS20ED
	Mattl.Patari@Compaq.com	

AlphaServer DS20E UNIX Cluster
GOLDEN EGGS Visuals, Helsinki

This template is included in the present GOLDEN EGGS Software kit.

DS20E UNIX

DS20E expanded OpenVMS system

FDDI

Ethernet

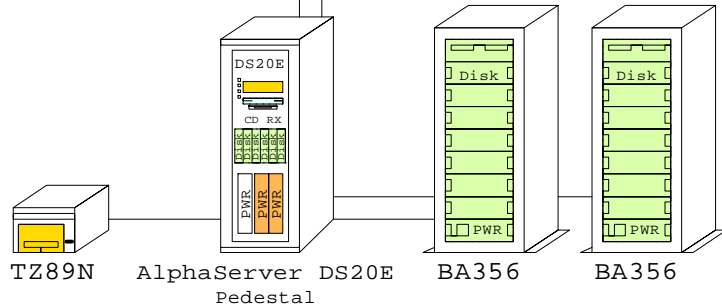

Bill of material

	Part Number	Qty	Description
1	3X-BA56P-PB	1	DS20E Mini tower pedestal kit,667MHz
1.1	DY-56PAA-EA	1	AS DS20E 6/667 512MB,Rack,OVMS
1.1.1	3X-BC56C-2F	1	DS20E SCSI Cable Kit
1.1.2	3X-DEFPA-DC	1	PCI to FDDI DAS MMF with SC,Universal
1.1.3	3X-KZPCA-AA	1	Single channel LVD adapter
1.1.4	BA610-6D	1	ES40 Disk Drive Cage, 6-Bay
1.1.4.1	3R-A0585-AA	4	18.2GB Uscsi3 10k Universal disk 1"
1.1.5	FR-H7910-AA	1	Third power supply for DS20E
1.1.6	KN311-BC	1	AS DS20E 6/667 SMP UPG OpenVMS
1.1.7	KZPBA-CA	2	PCI to UltraSCSI Adapter UWSE
1.1.8	KZPCM-DA	1	Dual Uscsi with FastEther PCI
1.1.9	MS340-CA	1	DS20 256MB SDIMM MEM 4x64MB
1.1.10	MS340-DA	1	DS20 512MB SDIMM MEM 4x128MB
1.1.11	SN-PBXGK-BB	1	Elsa Gloria Synergy 8M Video Graphics
1.1.12	TLZ10-LB	1	12/24GB 4mm DAT 5.25" HH
2	DS-BA356-KF	1	Pedestal Storage, UltraW, Single-Bus
2.1	BN19C-2E	2	PowerCable 240V, C-Europe
2.2	BN38C-02	1	Ultra Cbl VHDCI - 68HD
2.3	CK-BA35X-HH	1	180W Stor.Shelf PWR for AS4x00
2.4	DS-RZ1ED-VW	6	18.2GB 10000r UltraSCSI disk
3	DS-BA356-KF	1	Pedestal Storage, UltraW, Single-Bus
3.1	BN19C-2E	2	PowerCable 240V, C-Europe
3.2	BN38C-02	1	Ultra Cbl VHDCI - 68HD
3.3	CK-BA35X-HH	1	180W Stor.Shelf PWR for AS4x00
3.4	DS-RZ1ED-VW	6	18.2GB 10000r UltraSCSI disk
4	3R-A2832-AA	1	COMPAQ Monitor S510 15" NH, EU
5	DS-TZ89N-TA	1	35/70GB SE DLT-tape TT FWSE
6	BN39C-02	1	1.8 Video Extension Cable ****
7	BN19C-2E	5	PowerCable 240V, C-Europe
8	BN38C-02	1	Ultra Cbl VHDCI - 68HD
9	LK461-AF	1	VMS STYLE KEYBOARD, Fin/Swed

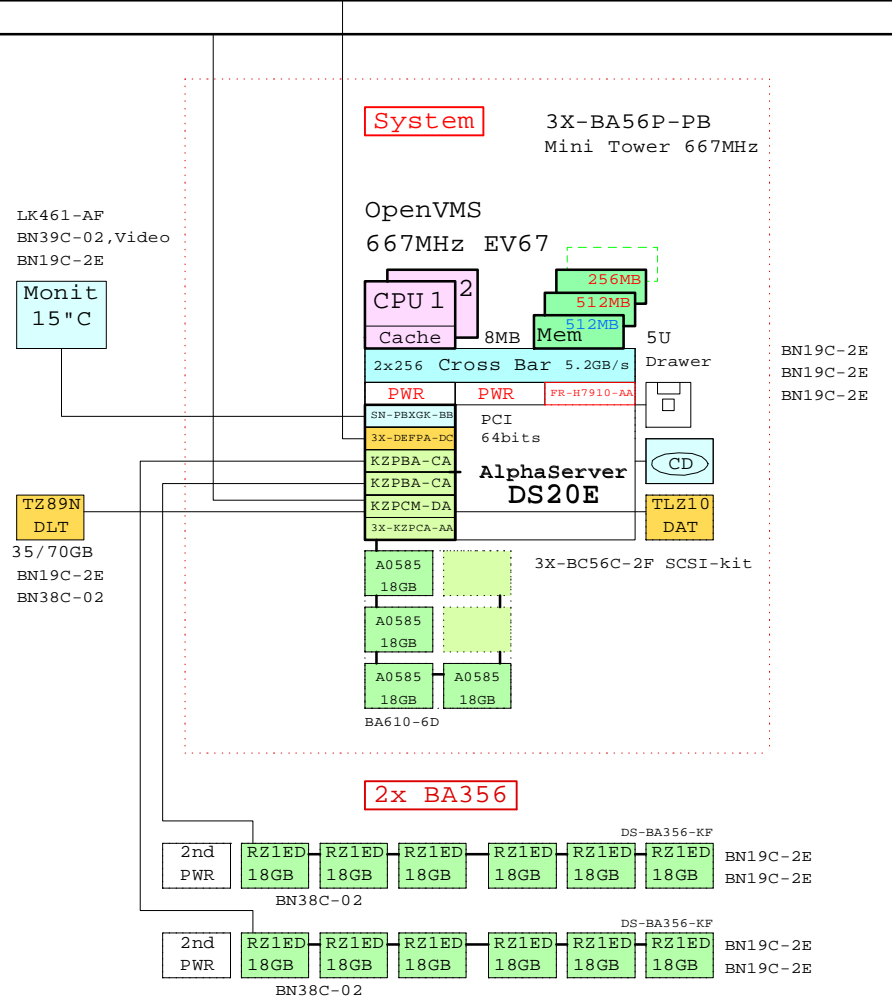

This template is included in the present GOLDEN EGGS Software kit.

DS20E OVMS

www.Compaq.com/golden-eggs
Since:Jun-2000

COMPAQ 05-Feb-2001 GTAVDS20EA
Matti.Patari@compaq.com

AlphaServer DS20E OpenVMS Syst
GOLDEN EGGS Visuals, Helsinki

DS20E expanded OpenVMS RAID system

FDDI

Ethernet

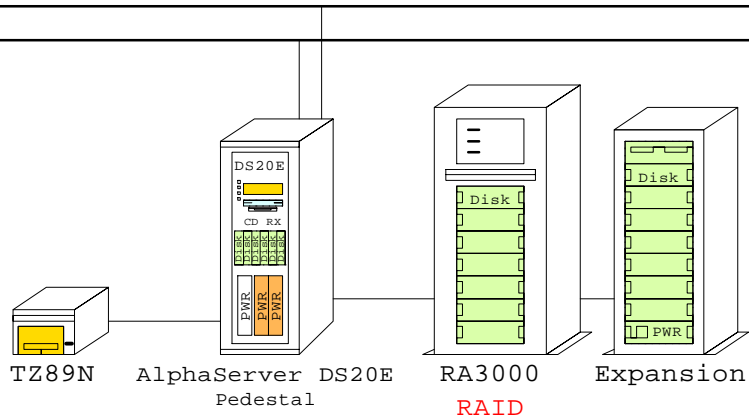

LK461-AF
BN39C-02, Video
BN19C-2E

Monit
15" C

TZ89N
DLT
35/70GB
BN19C-2E
BN38C-02

System
3X-BA56P-PB
Mini Tower 667MHz

OpenVMS
667MHz EV67

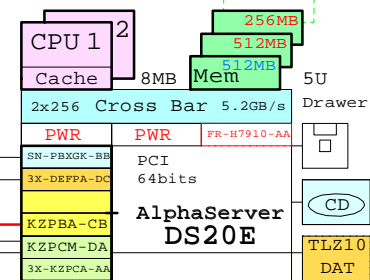

BN19C-2E
BN19C-2E
BN19C-2E

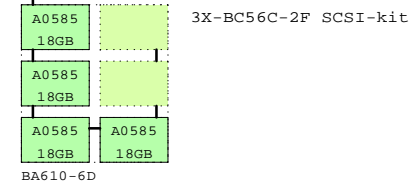

RA3000 RAID and Expansion

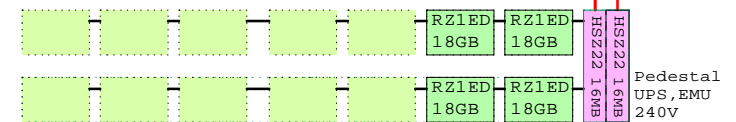

QB-5TWAC-SA Sol sw RA3000 Alp Ov BN19C-2E
BN19C-2E

Bill of material

Part Number	Qty	Description
1	3X-BA56P-PB	1 DS20E Mini tower pedestal kit,667MHz
1.1	DY-56PAA-EA	1 AS DS20E 6/667 512MB,Rack,OVMS
1.1.1	3X-BC56C-2F	1 DS20E SCSI Cable Kit
1.1.2	3X-DEFFA-DC	1 PCI to FDDI DAS MMF with SC,Universal
1.1.3	3X-KZPCA-AA	1 Single channel LVD adapter
1.1.4	BA610-6D	1 ES40 Disk Drive Cage, 6-Bay
1.1.4.1	3R-A0585-AA	4 18.2GB Uscsi3 10k Universal disk 1"
1.1.5	FR-H7910-AA	1 Third power supply for DS20E
1.1.6	KN311-BC	1 AS DS20E 6/667 SMP UPG OpenVMS
1.1.7	KZPBA-CB	1 PCI to UltraSCSI Adapter UWDif
1.1.8	KZPCM-DA	1 Dual Uscsi with FastEther PCI
1.1.9	MS340-CA	1 DS20 256MB SDIMM MEM 4x64MB
1.1.10	MS340-DA	1 DS20 512MB SDIMM MEM 4x128MB
1.1.11	SN-PBXGK-BB	1 Elsa Gloria Synergy 8M Video Graphics
1.1.12	TLZ10-LB	1 12/24GB 4mm DAT 5.25" HH
2	DS-SWXRA-GC	1 RA3000 Pedestal one Hsz22 240V
2.1	DS-HSZ22-AA	1 Hsz22 controller 16MB
2.2	DS-RZ1ED-VW	2 18.2GB 10000r UltraSCSI disk
2.3	DS-SWXRA-GD	1 RA3000 Pedestal Expans 120/240
2.3.1	DS-RZ1ED-VW	2 18.2GB 10000r UltraSCSI disk
3	QB-5TWAC-SA	1 Sol sw RA3000 Alp Ovms
4	3R-A2832-AA	1 COMPAQ Monitor S510 15" NH, EU
5	DS-TZ89N-TA	1 35/70GB SE DLT-tape TT FWSE
6	BN39C-02	1 1.8 Video Extension Cable ****
7	BN19C-2E	7 PowerCable 240V, C-Europe
8	BN38C-02	1 Ultra Cbl VHDCI - 68HD
9	LK461-AF	1 VMS STYLE KEYBOARD, Fin/Swed

www.Compaq.com/golden-eggs

Since:Jun-2000



05-Feb-2001 GTA VDS20EB
Matti.Patari@compaq.com

AlphaServer DS20E OpenVMS RAID
GOLDEN EGGS Visuals, Helsinki

DS20E OpenVMS Cluster with in-cabinet RA3000 RAID storage

Ethernet

FDDI

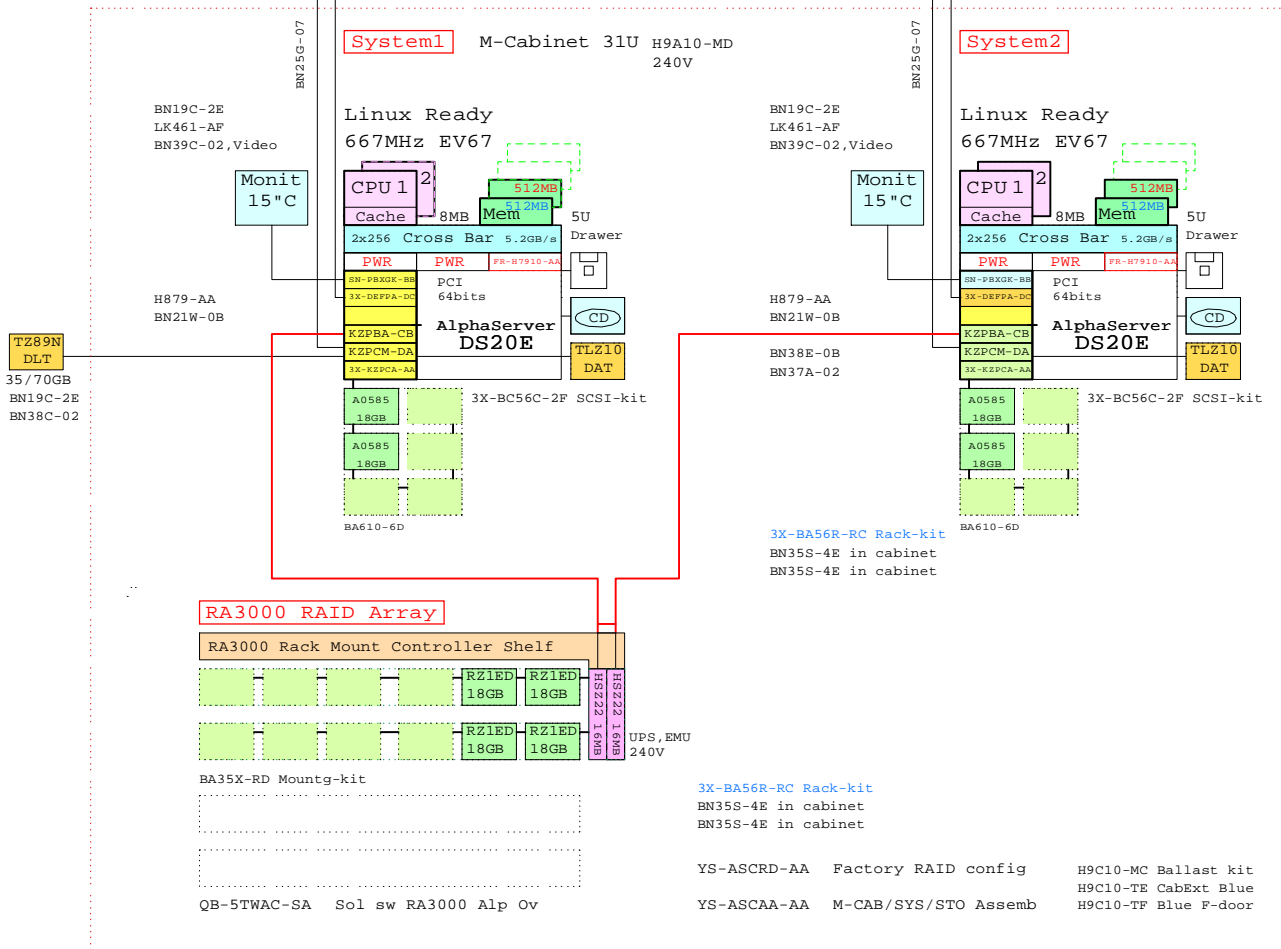

BOM for this cabinet system

	Part Number	Qty	Description
1	H9A10-MD	1	M-Series Cab,H9A10,Blue,240V 31U
1.1	3R-A2832-AA	2	COMPAQ Monitor S510 15" NH_EU
1.2	3X-BA56R-RC	2	Rackm.Kit, DS20E,667MHz for M-series
1.3	BA35X-RD	1	Mounting kit, metric
1.4	BN19C-2E	2	PowerCable 240V, C-Europe
1.5	BN21W-0B	2	Y SCSI-2 Cable 68 pins/6".15m
1.6	BN25G-07	2	17-03212-05 8MP-8MP PATCH CBL
1.7	BN35S-4E	4	PowerCord C13 to C14, Non US
1.8	BN37A-02	1	Ultra Cbl VHDCI - VHDCI
1.9	BN38E-0B	1	Ultra Cbl VHDCI - 68HD
1.10	BN39C-02	2	1.8 Video Extension Cable ****
1.11	DJ-56PAA-EA	1	AS DS20E 6/667 512MB,Rack,Linux
1.11.1	3X-BC56C-2F	1	DS20E SCSI Cable Kit
1.11.2	3X-DEFFA-DC	1	PCI to FDDI DAS MMF with SC,Universal
1.11.3	3X-KZPCA-AA	1	Single channel LVD adapter
1.11.4	BA610-6D	1	ES40 Disk Drive Cage, 6-Bay
1.11.4.1	3R-A0585-AA	2	18.2GB Uscsi3 10k Universal disk 1"
1.11.5	FR-H7910-AA	1	Third power supply for DS20E
1.11.6	KN311-BC	1	AS DS20E 6/667 SMP UPG OpenVMS
1.11.7	KZPBA-CB	1	PCI to UltraSCSI Adapter Uwdif
1.11.8	KZPCM-DA	1	Dual Uscsi with FastEther PCI
1.11.9	MS340-DA	1	DS20 512MB SDIMM MEM 4x128MB
1.11.10	SN-PBXGK-BB	1	Elsa Gloria Synergy 8M Video Graphics
1.11.11	TLZ10-LB	1	12/24GB 4mm DAT 5.25" HH
1.12	DJ-56PAA-EA	1	AS DS20E 6/667 512MB,Rack,Linux
1.12.1	3X-BC56C-2F	1	DS20E SCSI Cable Kit
1.12.2	3X-DEFFA-DC	1	PCI to FDDI DAS MMF with SC,Universal
1.12.3	3X-KZPCA-AA	1	Single channel LVD adapter
1.12.4	BA610-6D	1	ES40 Disk Drive Cage, 6-Bay
1.12.4.1	3R-A0585-AA	2	18.2GB Uscsi3 10k Universal disk 1"
1.12.5	FR-H7910-AA	1	Third power supply for DS20E
1.12.6	KN311-BC	1	AS DS20E 6/667 SMP UPG OpenVMS
1.12.7	KZPBA-CB	1	PCI to UltraSCSI Adapter Uwdif
1.12.8	KZPCM-DA	1	Dual Uscsi with FastEther PCI
1.12.9	MS340-DA	1	DS20 512MB SDIMM MEM 4x128MB
1.12.10	SN-PBXGK-BB	1	Elsa Gloria Synergy 8M Video Graphics
1.12.11	TLZ10-LB	1	12/24GB 4mm DAT 5.25" HH
1.13	DS-SWXRA-GK	1	RA3000 Rackmount one HSZ22 240V
1.13.1	DS-HSZ22-AA	1	HSZ22 controller 16MB
1.13.2	DS-SWXRA-GN	1	RA3000 Rackmount Expan 120/240
1.13.2.1	DS-RZ1ED-VN	2	18.2GB 10000r UltraSCSI disk
1.13.3	DS-SWXRA-GN	1	RA3000 Rackmount Expan 120/240
1.13.3.1	DS-RZ1ED-VN	2	18.2GB 10000r UltraSCSI disk
1.14	H879-AA	2	SCSI-3 Term - 68 pin Male
1.15	H9C10-MC	1	Ballast Kit for cabinets
1.16	H9C10-TE	1	Rear cab extender for H9A10 Blue
1.17	H9C10-TF	1	FrontDoorKit Blue for H9A10
1.18	LK461-AF	2	VMS STYLE KEYBOARD, Fin/Swed
1.19	QB-5TWAC-SA	1	Sol sw RA3000 Alp Ovms
1.20	YS-ASCAA-AA	1	M-CAB/SYS/STO Assembly
1.21	YS-ASCRD-AA	1	Factory configured RAID sets of BA370
2	DS-TZ89N-TA	1	35/70GB SE DLT-tape TT FWSE
3	BN19C-2E	1	PowerCable 240V, C-Europe
4	BN38C-02	1	Ultra Cbl VHDCI - 68HD

www.Compaq.com/golden-eggs
Since:Jun-2000

COMPAQ	05-Feb-2001	GTAVDS20EC
	MattI.Patari@Compaq.com	
AlphaServer DS20E OVMS Cluster		
GOLDEN EGGs Visuals, Helsinki		

This template is included in the present GOLDEN EGGs Software kit.

DS20E OVMS

DS20E OpenVMS Cluster with in-cabinet RAID storage

Ethernet

FDDI

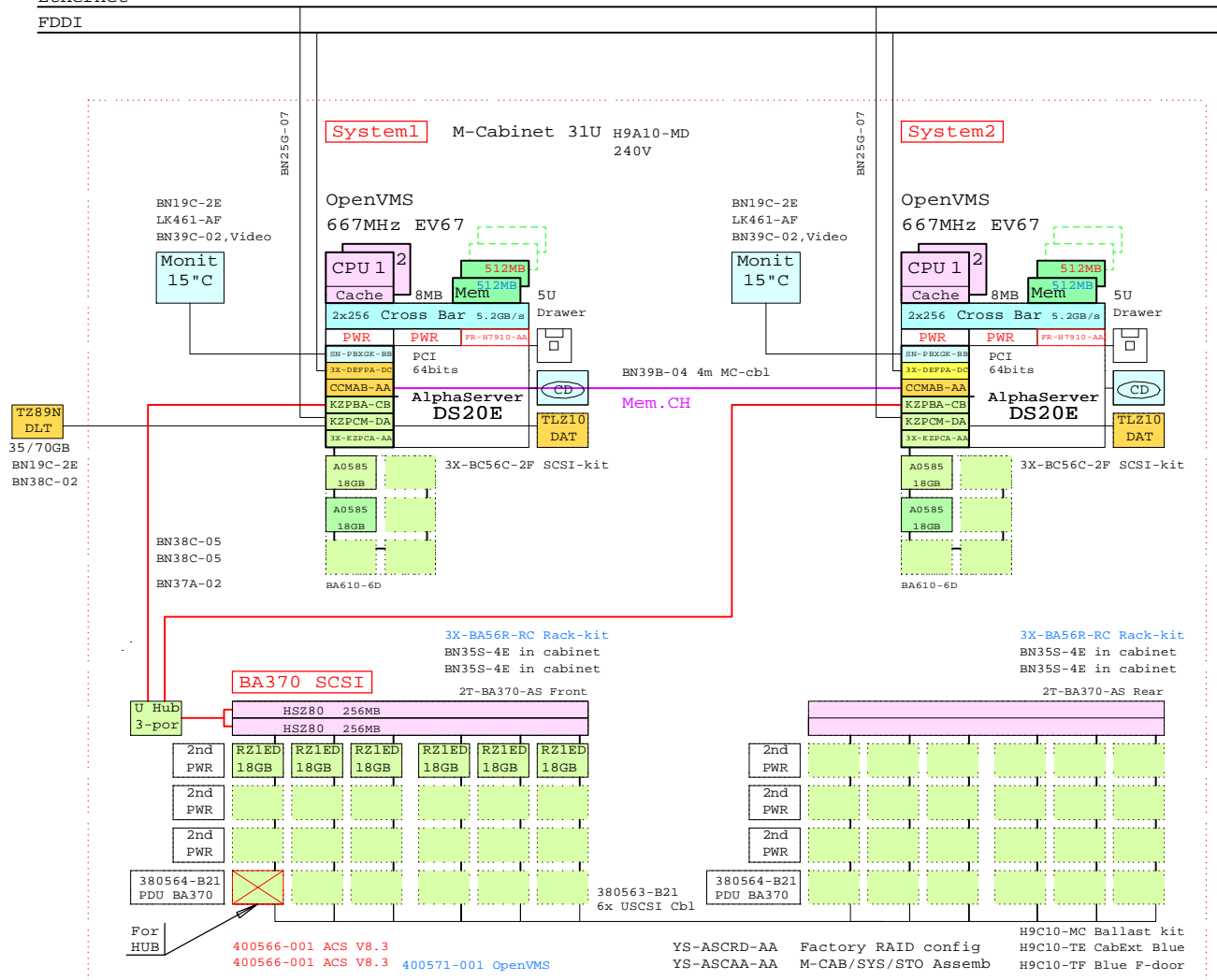

BOM for this cabinet system

Part Number	Qty	Description
1		H9A10-MD 1 M-Series Cab,H9A10,Blue,240V 31U
1.1		2T-BA370-AR 1 BA370 shelf,slides Rear RackMount
1.1.1		380564-B21 1 Power Distribution Unit RABk/7k
1.1.2		380565-B21 3 Power Supply 180W Hot Plug SBB
1.2		2T-BA370-AS 1 BA370 shelf,slides Front RackMount
1.2.1		380564-B21 3 Power Distribution Unit RABk/7k
1.2.2		380565-B21 3 Power Supply 180W Hot Plug SBB
1.2.3		400565-B21 2 Ultra Opt.1 cont w 2x128MB cache HSZ80
1.2.4		DS-DWZZH-03 1 Uscsi Act hub 0 SE:3/Dif 3.5" SBB
1.2.5		DS-RZ1ED-VW 6 18.2GB 10000r UltraSCSI disk
1.3		380563-B21 1 Set of six USCSI cables
1.4		3R-A2832-AA 2 COMPAQ Monitor S510 15" NH, EU
1.5		3X-BA56R-RC 2 Rackm.kit, DS20E,667MHz for M-series
1.6		400566-001 2 HSZ80 Controller Software ACS V8.3
1.7		400571-001 1 Ultra opt OS Software OpenVMS
1.8		BN19C-2E 2 PowerCable 240V, C-Europe
1.9		BN25G-07 2 17-03212-05 8MP-8MP PATCH CBL
1.10		BN35S-4E 4 PowerCord C13 to C14, Non US
1.11		BN37A-02 1 Ultra Cbl VHDCI - VHDCI
1.12		BN38C-05 2 Ultra Cbl VHDCI - 6BHD
1.13		BN39B-04 1 04m copper cbl for CCMAB Mem.Chan
1.14		BN39C-02 2 1.8 Video Extension Cable ****
1.15		DY-56PAA-EA 1 AS DS20E 6/667 512MB,Rack,OVMS
1.15.1		3X-BC56C-2F 1 DS20E SCSI Cable Kit
1.15.2		3X-DEFPA-DC 1 PCI to FDDI DAS MMF with SC,Universal
1.15.3		3X-KZPCA-AA 1 Single channel LVD adapter
1.15.4		BA610-6D 1 ES40 Disk Drive Cage, 6-Bay
1.15.4.1		3R-A0585-AA 2 18.2GB Uscsi3 10k Universal disk 1"
1.15.5		CCMAB-AA 1 PCI Mem. Channel-2 Cluster cntrl
1.15.6		FR-H7910-AA 1 Third power supply for DS20E
1.15.7		KN311-BC 1 AS DS20E 6/667 SMP UPG OpenVMS
1.15.8		KZPBA-CB 1 PCI to UltraSCSI Adapter Umdif
1.15.9		KZPCM-DA 1 Dual Uscsi with FastEther PCI
1.15.10		MS340-DA 1 DS20 512MB SDIMM MEM 4x128MB
1.15.11		SN-PBXGK-BB 1 Elsa Gloria Synergy 8M Video Graphics
1.15.12		TLZ10-LB 1 12/24GB 4mm DAT 5.25" HH
1.16		DY-56PAA-EA 1 AS DS20E 6/667 512MB,Rack,OVMS
1.16.1		3X-BC56C-2F 1 DS20E SCSI Cable Kit
1.16.2		3X-DEFPA-DC 1 PCI to FDDI DAS MMF with SC,Universal
1.16.3		3X-KZPCA-AA 1 Single channel LVD adapter
1.16.4		BA610-6D 1 ES40 Disk Drive Cage, 6-Bay
1.16.4.1		3R-A0585-AA 2 18.2GB Uscsi3 10k Universal disk 1"
1.16.5		CCMAB-AA 1 PCI Mem. Channel-2 Cluster cntrl
1.16.6		FR-H7910-AA 1 Third power supply for DS20E
1.16.7		KN311-BC 1 AS DS20E 6/667 SMP UPG OpenVMS
1.16.8		KZPBA-CB 1 PCI to UltraSCSI Adapter Umdif
1.16.9		KZPCM-DA 1 Dual Uscsi with FastEther PCI
1.16.10		MS340-DA 1 DS20 512MB SDIMM MEM 4x128MB
1.16.11		SN-PBXGK-BB 1 Elsa Gloria Synergy 8M Video Graphics
1.16.12		TLZ10-LB 1 12/24GB 4mm DAT 5.25" HH
1.17		H9C10-MC 1 Ballast Kit for cabinets
1.18		H9C10-TE 1 Rear cab extender for H9A10 Blue
1.19		H9C10-TF 1 FrontDoorKit Blue for H9A10
1.20		LK461-AF 2 VMS STYLE KEYBOARD, Fin/Swed
1.21		YS-ASCAA-AA 1 M-CAB/SYS/STO Assembly
1.22		YS-ASCRD-AA 1 Factory configured RAID sets of BA370
2		DS-TZ89N-TA 1 35/70GB SE DLT-tape TT FWSE
3		BN19C-2E 1 PowerCable 240V, C-Europe
4		BN38C-02 1 Ultra Cbl VHDCI - 6BHD

www.Compaq.com/golden-eggs
Since:Apr-2000

COMPAQ	06-Feb-2001	GTAVDS20ED
	Matti.Patari@Compaq.com	
AlphaServer DS20E OVMS Cluster GOLDEN EGGS Visuals, Helsinki		

This template is included in the present GOLDEN EGGS Software kit.

DS20E OVMS

DS20E OpenVMS Cluster with in-cabinet RAID storage, No single point.

Ethernet

FDI

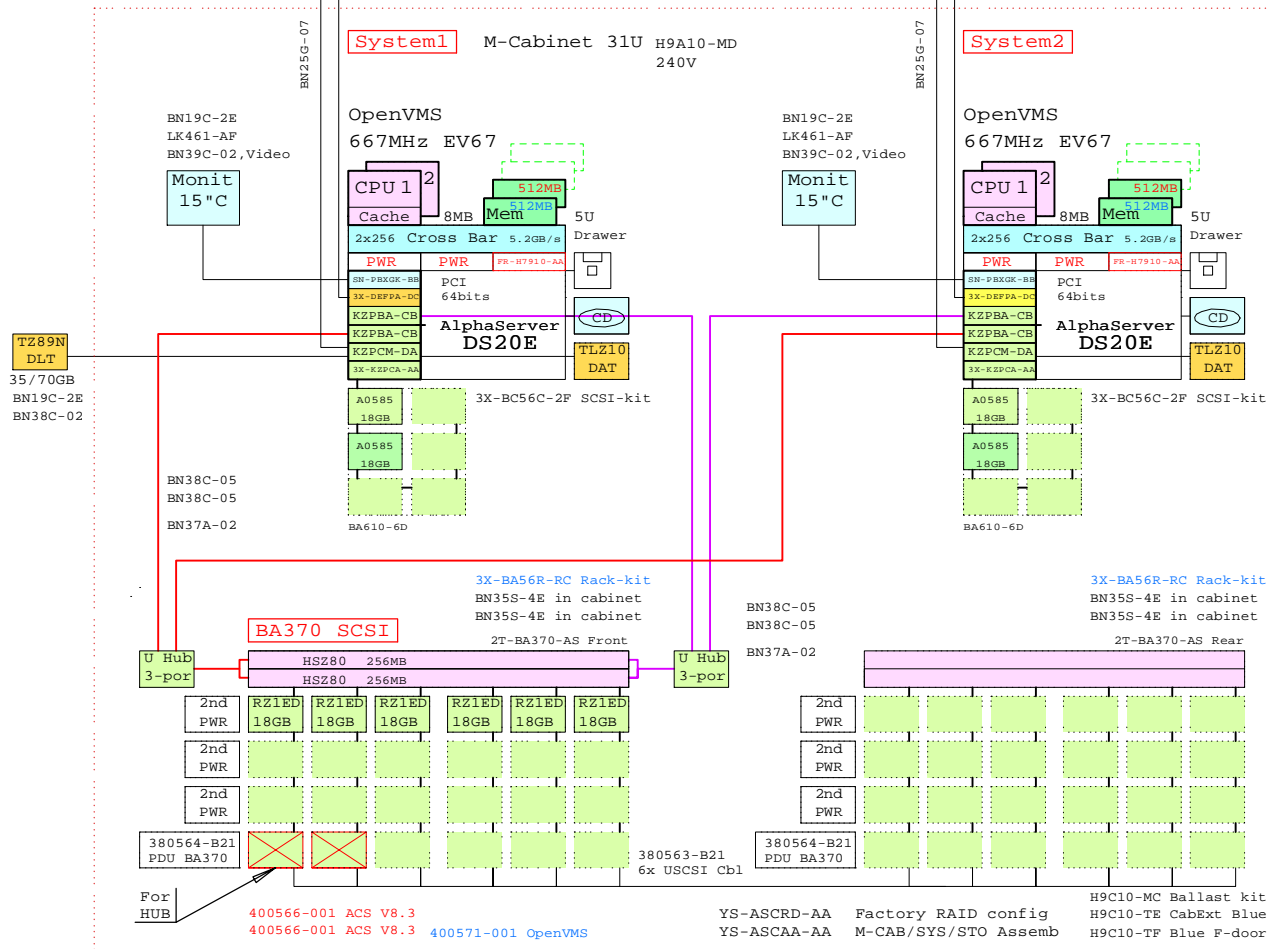

BOM for this cabinet system

Part Number	Qty	Description
1	H9A10-MD	1 M-Series Cab,H9A10,Blue,240V 31U
1.1	2T-BA370-AR	1 BA370 shelf,slides Rear RackMount
1.1.1	380564-B21	1 Power Distribution Unit RA8k/7k
1.1.2	380565-B21	3 Power Suply 180W Hot Plug SBB
1.1.3	BN37A-02	1 Ultra Cbl VHDCI - VHDCI
1.2	2T-BA370-AS	1 BA370 shelf,slides Front RackMount
1.2.1	380564-B21	1 Power Distribution Unit RA8k/7k
1.2.2	380565-B21	3 Power Suply 180W Hot Plug SBB
1.2.3	400565-B21	2 Ultra Opt.1 cont w 2x128MB cache HS280
1.2.4	DS-DWZZH-03	1 Uscsi Act hub 0 SE:3/Dif 3.5" SBB
1.2.5	DS-RZ1ED-VW	6 18.2GB 10000r UltraSCSI disk
1.3	380563-B21	1 Set of six USCSI cables
1.4	3R-A2832-AA	2 COMPAQ Monitor S510 15" NH, EU
1.5	3X-BA56R-RC	2 Rackm.kit, DS20E,667MHz for M-series
1.6	400566-001	2 HSZ80 Controller Software ACS V8.3
1.7	400571-001	1 Ultra opt OS Software OpenVMS
1.8	BN19C-2E	2 PowerCable 240V, C-Europe
1.9	BN25G-07	2 17-03212-05 8MP-8MP PATCH CBL
1.10	BN35S-4E	4 PowerCord C13 to C14, Non US
1.11	BN37A-02	1 Ultra Cbl VHDCI - VHDCI
1.12	BN38C-05	4 Ultra Cbl VHDCI - 68HD
1.13	BN39C-02	2 1.8 Video Extension Cable ****
1.14	DS-DWZZH-03	1 Uscsi Act hub 0 SE:3/Dif 3.5" SBB
1.15	DY-56PAA-EA	1 AS DS20E 6/667 512MB,Rack_OVMS
1.15.1	3X-BC56C-2F	1 DS20E SCSI Cable Kit
1.15.2	3X-DEPFA-DC	1 PCI to FDDI DAS MMF with SC,Universal
1.15.3	3X-KZPCA-AA	1 Single channel LVD adapter
1.15.4	BA610-6D	1 ES40 Disk Drive Cage, 6-Bay
1.15.4.1	3R-A0585-AA	2 18.2GB Uscsi3 10k Universal disk 1"
1.15.5	FR-H7910-AA	1 Third power supply for DS20E
1.15.6	KN311-BC	1 AS DS20E 6/667 SMP UPG OpenVMS
1.15.7	KZPBA-CB	2 PCI to UltraSCSI Adapter Uwdif
1.15.8	KZPCM-DA	1 Dual Uscsi with FastEther PCI
1.15.9	MS340-DA	1 DS20 512MB SDIMM MEM 4x128MB
1.15.10	SN-PBXGK-BB	1 Elsa Gloria Synergy 8M Video Graphics
1.15.11	TLZ10-LB	1 12/24GB 4mm DAT 5.25" HH
1.16	DY-56PAA-EA	1 AS DS20E 6/667 512MB,Rack_OVMS
1.16.1	3X-BC56C-2F	1 DS20E SCSI Cable Kit
1.16.2	3X-DEPFA-DC	1 PCI to FDDI DAS MMF with SC,Universal
1.16.3	3X-KZPCA-AA	1 Single channel LVD adapter
1.16.4	BA610-6D	1 ES40 Disk Drive Cage, 6-Bay
1.16.4.1	3R-A0585-AA	2 18.2GB Uscsi3 10k Universal disk 1"
1.16.5	FR-H7910-AA	1 Third power supply for DS20E
1.16.6	KN311-BC	1 AS DS20E 6/667 SMP UPG OpenVMS
1.16.7	KZPBA-CB	2 PCI to UltraSCSI Adapter Uwdif
1.16.8	KZPCM-DA	1 Dual Uscsi with FastEther PCI
1.16.9	MS340-DA	1 DS20 512MB SDIMM MEM 4x128MB
1.16.10	SN-PBXGK-BB	1 Elsa Gloria Synergy 8M Video Graphics
1.16.11	TLZ10-LB	1 12/24GB 4mm DAT 5.25" HH
1.17	H9C10-MC	1 Ballast Kit for cabinets
1.18	H9C10-TE	1 Rear cab extender for H9A10 Blue
1.19	H9C10-TF	1 FrontDoorKit Blue for H9A10
1.20	LK461-AF	2 VMS STYLE KEYBOARD, Fin/Swed
1.21	YS-ASCAA-AA	1 M-CAB/SYS/STO Assembly
1.22	YS-ASCRD-AA	1 Factory configured RAID sets of BA370
2	DS-TZ89N-TA	1 35/70GB SE DLT-tape TT FWSE
3	BN19C-2E	1 PowerCable 240V, C-Europe
4	BN38C-02	1 Ultra Cbl VHDCI - 68HD

www.Compaq.com/golden-eggs
Since:Apr-2000

COMPAQ	06-Feb-2001	GTAVIDS20EE
	MattI.Patarie@Compaq.com	

AlphaServer DS20E OVMS Cluster
GOLDEN EGGS Visuals, Helsinki

This template is included in the present GOLDEN EGGS Software kit.

DS20E OVMS

FDDI

Ethernet

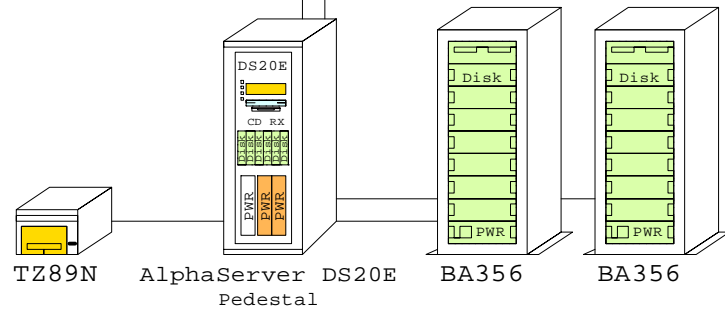

DS20E expanded Linux system

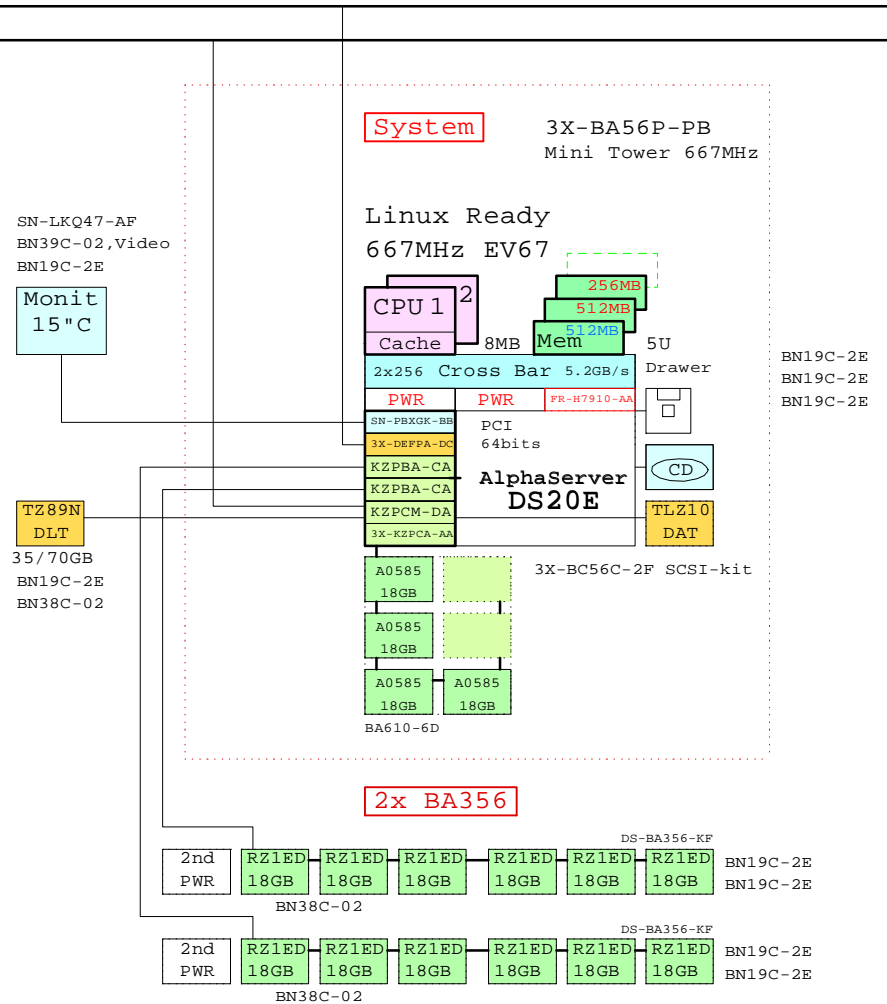

Bill of material

	Part Number	Qty	Description
1	3X-BA56P-PB	1	DS20E Mini tower pedestal kit,667MHz
1.1	DJ-56PAA-EA	1	AS DS20E 6/667 512MB,Rack, Linux
1.1.1	3X-BC56C-2F	1	DS20E SCSI Cable Kit
1.1.2	3X-DEFPA-DC	1	PCI to FDDI DAS MMF with SC,Universal
1.1.3	3X-KZPCA-AA	1	Single channel LVD adapter
1.1.4	BA610-6D	1	ES40 Disk Drive Cage, 6-Bay
1.1.4.1	3R-A0585-AA	4	18.2GB Uscsi3 10k Universal disk 1"
1.1.5	FR-H7910-AA	1	Third power supply for DS20E
1.1.6	KN311-BD	1	AS DS20E 6/667 SMP UPG for Linux
1.1.7	KZPBA-CA	2	PCI to UltraSCSI Adapter UWSE
1.1.8	KZPCM-DA	1	Dual Uscsi with FastEther PCI
1.1.9	MS340-CA	1	DS20 256MB SDIMM MEM 4x64MB
1.1.10	MS340-DA	1	DS20 512MB SDIMM MEM 4x128MB
1.1.11	SN-PBXGK-BB	1	Elsa Gloria Synergy 8M Video Graphics
1.1.12	TLZ10-LB	1	12/24GB 4mm DAT 5.25" HH
2	DS-BA356-KF	1	Pedestal Storage, UltraW, Single-Bus
2.1	BN19C-2E	2	PowerCable 240V, C-Europe
2.2	BN38C-02	1	Ultra Cbl VHDCI - 68HD
2.3	CK-BA35X-HH	1	180W Stor.Shelf PWR for AS4x00
2.4	DS-RZ1ED-VW	6	18.2GB 10000r UltraSCSI disk
3	DS-BA356-KF	1	Pedestal Storage, UltraW, Single-Bus
3.1	BN19C-2E	2	PowerCable 240V, C-Europe
3.2	BN38C-02	1	Ultra Cbl VHDCI - 68HD
3.3	CK-BA35X-HH	1	180W Stor.Shelf PWR for AS4x00
3.4	DS-RZ1ED-VW	6	18.2GB 10000r UltraSCSI disk
4	3R-A2832-AA	1	COMPAQ Monitor S510 15" NH, EU
5	DS-TZ89N-TA	1	35/70GB SE DLT-tape TT FWSE
6	BN39C-02	1	1.8 Video Extension Cable ****
7	SN-LKQ47-AF	1	102 KEY KYBD, NON-WIN, Finnish
8	BN19C-2E	5	PowerCable 240V, C-Europe
9	BN38C-02	1	Ultra Cbl VHDCI - 68HD

www.Compaq.com/golden-eggs
Since: Jun-2000



05-Feb-2001 GTALDS20EA
Matti.Patari@compaq.com

AlphaServer DS20E Linux System
GOLDEN EGGS Visuals, Helsinki

This template is included in the present GOLDEN EGGS Software kit.

DS20E Linux

AlphaServer ES40 68/833 Systems, 64bits 833MHz

Model	Tru64 UNIX	OpenVMS	Linux Ready
#1 M1 6xPCI	-CA 512MB -DA 1GB -EA 2GB	-CA 512MB -DA 1GB -EA 2GB	DJ-62CAA-CA 512MB
M2 10xPCI	-DA 1GB -EA 2GB -FA 4GB	-DA 1GB -EA 2GB -FA 4GB	

#2 Select Enclosure, Disk Cage, Disk Drive, USCSI Controller, Ethernet and Graphics.

Mini-Tower	Pedestal - BA356	Cabinet - Modula
BA61M-MT Mini-Tower box	BA61P-PA/PB Pedestal 120/240V	H9A15-MC/MD Cabinet 120V/240V, 39U
3X-KZPCA-AA USCSI adapter	KZPCM-DA 2xUSCSI+ Ethernet	H9C15-TE Cabinet rear extender
BA610-6D Disk Drive Cage	BN37A-02 SCSI cable, 2m	H9C15-TF Cabinet front door
3R-A0585-AA Disk 18.2GB 10k	BA36R-RC Single-buss shelf	H9C10-MC Ballast kit, 40lbs
3R-A0919-AA Disk 36.4GB 10k	BA36R-RD Split-buss shelf	BA61R-RM Rack mount kit
3X-DE600-AA Ethernet 10/100	DS-RZ1DD-VW Disk 9.1GB 10k	YS-ASCAA-AA Factory integration
BN25G-10 Cable, twisted	DS-RZ1ED-VW Disk 18.2GB 10k	3X-KZPCA-AA Ultra2 SCSI adapte, 1-2
SN-PBXGK-BB ElsaGloria 8MB	BN25G-10 Cable, twisted	BN38C-05 SCSI cable, 5m, 1-2
	SN-PBXGK-BB ElsaGloria 8MB	DS-SL13R-AB Shelf M4314, single b.
		DS-SL13R-BB Shelf M4354, dual bus
		3R-A1543-AA Disk 18.2GB 15k
		3X-DE600-AA Ethernet 10/100
		BN25G-10 Cable, twisted
		SN-PBXGK-BB ElsaGloria 8MB

#3 SVGA color monitor **#4** For 240V use, select keyboard and power cord

15" 3R-VRQV5-24/11	SN-LKQ47 -AE GB -AG G -AM S	BN19C-2E Europe
17" 3R-VRQP7-24/23	UNIX, Lin -AB B -AH NL -AN N	BN19A-2E GB
North/South	LK461 -AD DK -AI I -AP F	BN19E-2E CH
BN39C-02 2m ext.cable	OVMS -AF FI -AK CH -AS E	BN19K-2E DK
		BN19Z-2E I

Internal options

Memory expansion

MS610-DA	1GB
MS610-EA	2GB
MS610-FA	4GB

Additional CPUs, Max 4

UNIX	KN610-CB	833MHz
OVMS	KN610-CC	833MHz
Linux	KN610-CA	833MHz

Power supplies, CPU 3-4 and/or for the second disk cage

H7906-A9	CPU power
CK-BA35X-HH	2nd disk pwr

Internal storage

Tape storage

TLZ10-LB	12/24GB DAT Tape drive
3X-BN46M-01	Multi head SCSI cable

Disk storage

3R-A0585-AA	18GB Universal disk 10k
3R-A0919-AA	36GB Universal disk 10k

KZPBA-CA	UltraSCSI SE adapter
BN38C-02	2m SCSI cable, 68HD-VHDCI
KZPCM-DA	Dual UltraSCSI+ Ethernet
BN37A-02	2m SCSI cable, VHDCI-VHDC

KZPAC-CB	RAID 3-port, 8MB cache
KZPSC-UB	Cache battery
KZPAC-SB	Dual cable bulkhead
BN37A-02	2m SCSI cable VHDCI-VHDCI

Controllers

3X-DE600-AA	Fast Ethernet
DEGPA-SA	Gigabit Ethernet
3X-DEFPA-AC	FDDI adapter, SAS MMF
CCMAB-AA	Memory Channel
CIPCA-BA	CI controller
DS-KGPSA-CA	Fibre Channel adapt
168794-B21	--" --

External options

Tape storage

DS-TZ89N-TA	35/70GB DLT tape, TT
BN21K-02	SCSI cable, FWD
BN19C-2E	Power cord, Europe
KZPBA-CA	UltraSCSI SE adapter

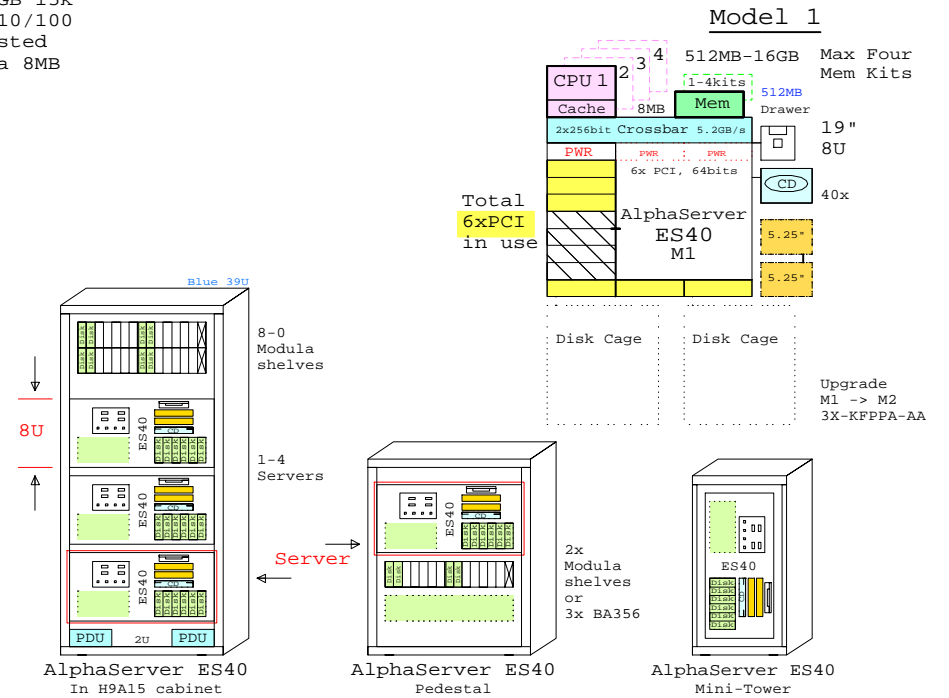
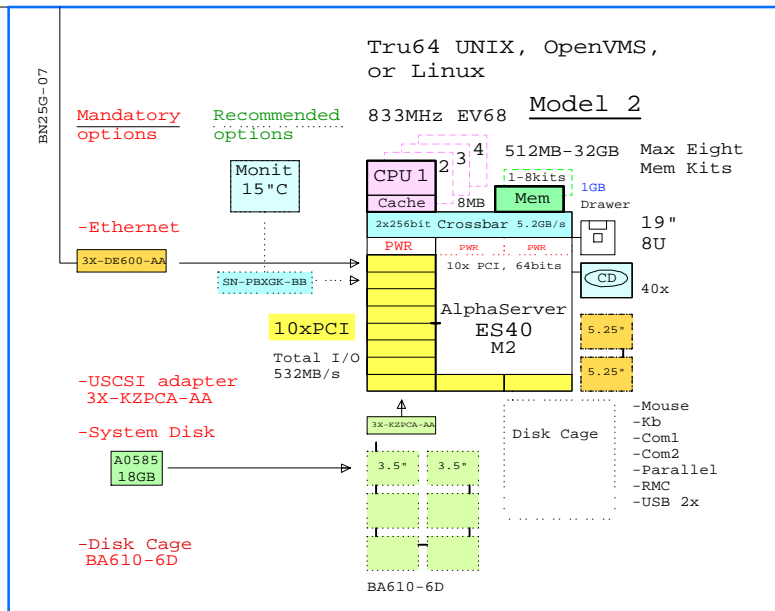

	@833MHz	@667MHz
SPECint95	40	83
SPECfp95	68	685
SPECweb99		

Software Processor Code: **E**

COMPAQ	30-Jan-2001	GEAES403
	Matti.Patari@compaq.com	

AlphaServer ES40 833MHz Syst.
GOLDEN EGGS Visuals, Helsinki

Tru64 UNIX, OpenVMS,
or Linux

833MHz EV68 Model 1

BN25G-07

Mandatory options

Recommended options

Monit
15" C

-Ethernet
3X-DE600-AA

SN-PBXGK-BB

-USCSI adapter
3X-KZPCA-AA

-System Disk
A0585
18GB

-Disk Cage
BA610-6D

512MB-32GB Max Eight
Mem Kits

2 CPU 1
Cache 8MB

3 Mem 512MB-32GB
1GB

4 2x256bit Crossbar 5.2GB/s
PWR 10x PCI, 64bits

AlphaServer
ES40
M2

2x 3.5" 3.5" 5.25" 5.25"

3X-KZPCA-AA
Disk Cage
-Mouse
-Kb
-Com1
-Com2
-Parallel
-RMC
-USB 2x

Model 1

512MB-16GB Max Four
Mem Kits

2 CPU 1
Cache 8MB

3 Mem 512MB
512MB

4 2x256bit Crossbar 5.2GB/s
PWR 6x PCI, 64bits

AlphaServer
ES40
M1

2x 3.5" 3.5" 5.25" 5.25"

40x CD
Upgrade
M1 -> M2
3X-KPPA-AA

Total
6xPCI
in use

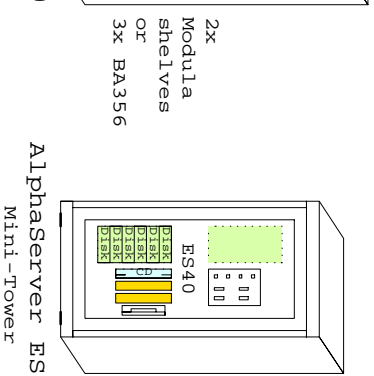
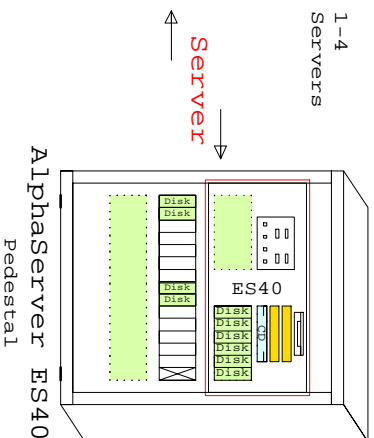
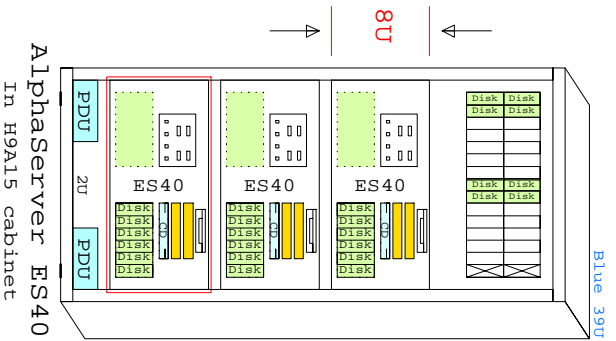
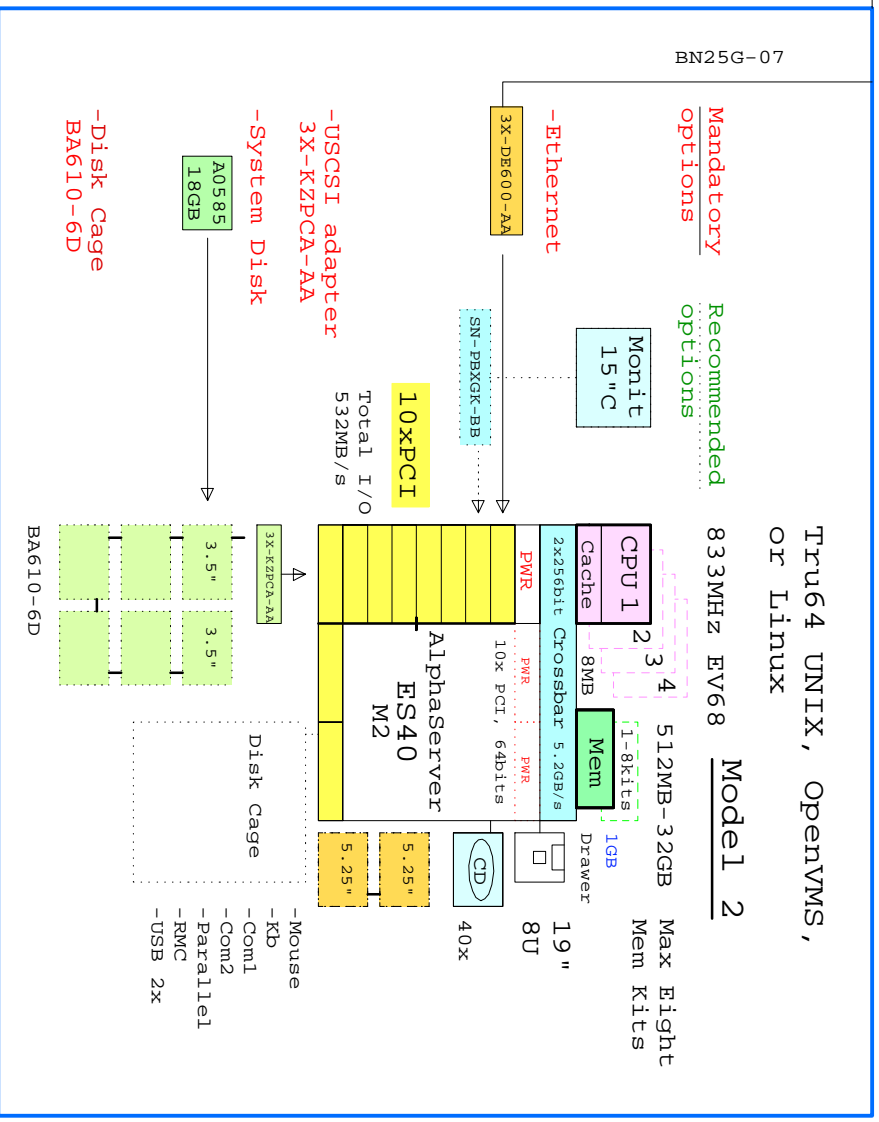

Software Processor Code: **E**

COMPAQ
AlphaServer ES40 833MHz Syst.
GOLDEN EGGS Visuals, Helsinki

SPECInt95
SPECfp95
SPECweb99

@833MHZ @667MHZ
40 83 685

www.Compaq.com/golden-eggs

Since Jan-2001

ES40

BN25G-07

Tru64 UNIX, OpenVMS,
or Linux

833MHz EV68 Model 2

Mandatory options

Recommended options

512MB-32GB Max Eight Mem Kits

Monit
15" C

CPU 1
Cache

2 3 4
8MB

1-8kits
Mem

1GB
Drawer

2x256bit Crossbar 5.2GB/s

-Ethernet

3X-DE600-AA

SN-PBXGK-BB

PWR

PWR

PWR

19"
8U

10x PCI, 64bits

CD

40x

10xPCI

Total I/O
532MB/s

AlphaServer
ES40
M2

5.25"

5.25"

-USCSI adapter
3X-KZPCA-AA

-System Disk

A0585
18GB

3X-KZPCA-AA

- Mouse
- Kb
- Com1
- Com2
- Parallel
- RMC
- USB 2x

-Disk Cage
BA610-6D

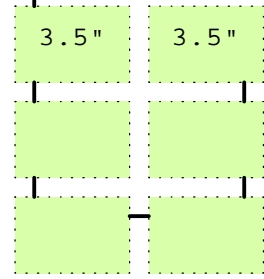

BA610-6D

ES40 Model 2 Mini Tower System

ES40 Model 1 Mini Tower System

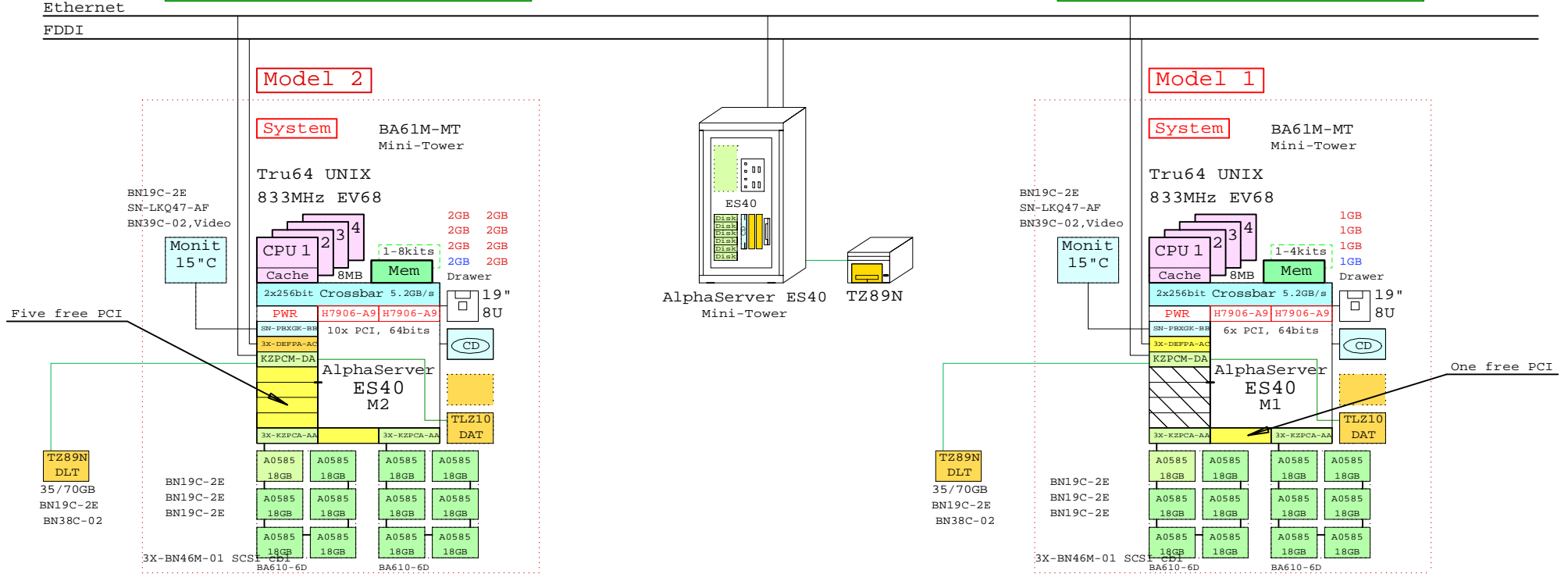

Bill of material, Model 2

Part Number	Qty	Description
1	1	BA61M-MT ES40 Mini-Tower Enclosure
1.1	1	3X-BN46M-01 SCSI cable for Tape
1.2	1	BN19C-2E PowerCable 240V, C-Europe
1.3	1	DA-64CAA-EA ES40 68/833 Model 2 2GB UNIX 10PCI DWR
1.3.1	1	3R-VROV5-24 COMPAQ V55 CLR MON,NH,TCO95
1.3.2	1	3X-DEFFA-AC PCI to FDDI SAS MMF with SC,Universal
1.3.3	2	3X-KZPCA-AA Single channel LVD adapter
1.3.4	1	BA610-6D ES40 Disk Drive Cage, 6-Bay
1.3.4.1	6	3R-A0585-AA 18.2GB Uscsi3 10k Universal disk 1"
1.3.5	1	BA610-6D ES40 Disk Drive Cage, 6-Bay
1.3.5.1	6	3R-A0585-AA 18.2GB Uscsi3 10k Universal disk 1"
1.3.6	3	BN19C-2E PowerCable 240V, C-Europe
1.3.7	1	BN39C-02 1.8 Video Extension Cable ****
1.3.8	2	H7906-A9 ES40 Power Syply, 2nd or 3rd
1.3.9	3	KN610-CB ES40 68/833MHz UNIX SMP 8mb cache
1.3.10	1	KZPCM-DA Dual Uscsi with FastEther PCI
1.3.11	7	MS610-EA ES40 2GB Memory Option
1.3.12	1	SN-PBXGK-BB Elsa Gloria Synergy 8M Video Graphics
1.3.13	1	TLZ10-LB 12/24GB 4mm DAT 5.25" HH
1.4	1	SN-LKQ47-AF 102 KEY KYBD,NON-WIN, Finnish
2	1	DS-TZ89N-TA 35/70GB SE DLT-tape TT FWSE
3	1	BN19C-2E PowerCable 240V, C-Europe
4	1	BN38C-02 Ultra Cbl VHDCI - 68HD

Bill of material, Model 1

Part Number	Qty	Description
1	1	BA61M-MT ES40 Mini-Tower Enclosure
1.1	1	3X-BN46M-01 SCSI cable for Tape
1.2	1	BN19C-2E PowerCable 240V, C-Europe
1.3	1	DA-62CAA-DA ES40 68/833 Model 1 1GB UNIX 6PCI DWR
1.3.1	1	3R-VROV5-24 COMPAQ V55 CLR MON,NH,TCO95
1.3.2	1	3X-DEFFA-AC PCI to FDDI SAS MMF with SC,Universal
1.3.3	2	3X-KZPCA-AA Single channel LVD adapter
1.3.4	1	BA610-6D ES40 Disk Drive Cage, 6-Bay
1.3.4.1	6	3R-A0585-AA 18.2GB Uscsi3 10k Universal disk 1"
1.3.5	1	BA610-6D ES40 Disk Drive Cage, 6-Bay
1.3.5.1	6	3R-A0585-AA 18.2GB Uscsi3 10k Universal disk 1"
1.3.6	3	BN19C-2E PowerCable 240V, C-Europe
1.3.7	1	BN39C-02 1.8 Video Extension Cable ****
1.3.8	2	H7906-A9 ES40 Power Syply, 2nd or 3rd
1.3.9	3	KN610-CB ES40 68/833MHz UNIX SMP 8mb cache
1.3.10	1	KZPCM-DA Dual Uscsi with FastEther PCI
1.3.11	3	MS610-DA ES40 1GB Memory Option
1.3.12	1	SN-LKQ47-AF 102 KEY KYBD,NON-WIN, Finnish
1.3.13	1	SN-PBXGK-BB Elsa Gloria Synergy 8M Video Graphics
1.3.14	1	TLZ10-LB 12/24GB 4mm DAT 5.25" HH
2	1	DS-TZ89N-TA 35/70GB SE DLT-tape TT FWSE
3	1	BN19C-2E PowerCable 240V, C-Europe
4	1	BN38C-02 Ultra Cbl VHDCI - 68HD

www.Compaq.com/golden-eggs
Since:Jan-2001

COMPAQ	30-Jan-2001	GTAUES40A
	Matti.Patari@compaq.com	
AlphaServer ES40 Mini Tower		
GOLDEN EGGS Visuals, Helsinki		

Ethernet
FDDI

ES40 Model 2 Pedestal System

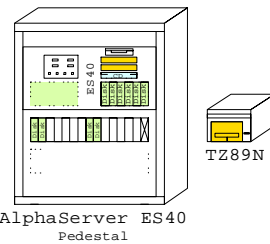
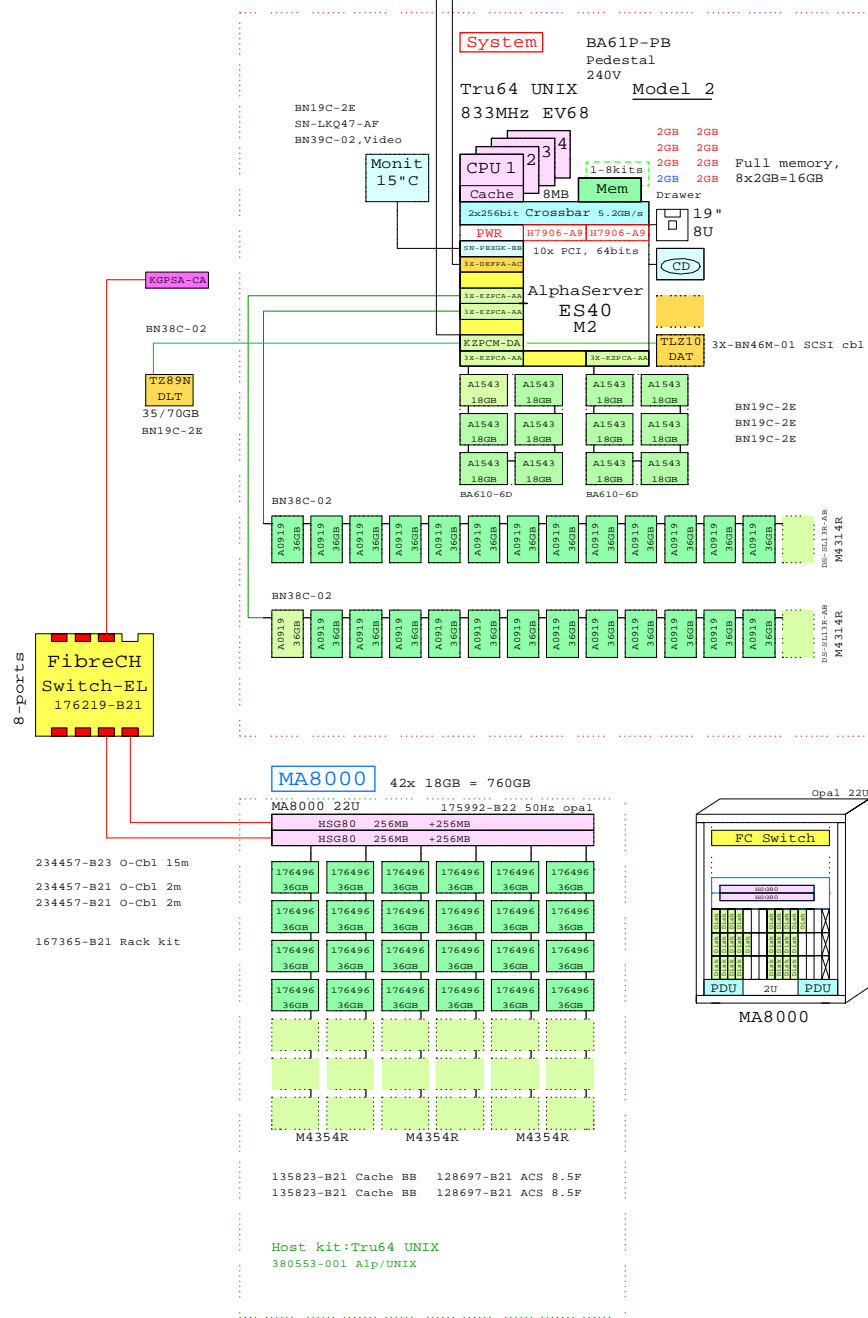

Bill of material for the base Pedestal

Part Number	Qty	Description
1	1	BA61P-PB 1 ES40 Pedestal Enclosure 240V Europe
1.1	1	3X-BN46M-01 1 SCSI cable for Tape
1.2	4	BN19C-2E 4 PowerCable 240V, C-Europe
1.3	2	BN38C-02 2 Ultra Cbl VHDCI - 68HD
1.4	1	BN39C-02 1 1.8 Video Extension Cable ****
1.5	1	DA-64CAA-EA 1 ES40 68/833 Model 2 2GB UNIX 10PCI DWR
1.5.1	1	3R-VRQV5-24 1 COMPAQ V55 CLR MON,NH,TCO95
1.5.2	1	3X-DEFPAC-AA 1 PCI to FDDI SAS MMF with SC,Universal
1.5.3	4	3X-KZPCA-AA 4 Single channel LVD adapter
1.5.4	1	BA610-6D 1 ES40 Disk Drive Cage, 6-Bay
1.5.4.1	6	3R-A1543-AA 6 18.2GB Uscsi3 15k Universal disk 1"
1.5.5	1	BA610-6D 1 ES40 Disk Drive Cage, 6-Bay
1.5.5.1	6	3R-A1543-AA 6 18.2GB Uscsi3 15k Universal disk 1"
1.5.6	2	H7906-A9 2 ES40 Power Syply, 2nd or 3rd
1.5.7	3	KN610-CB 3 ES40 68/833MHz UNIX SMP 8mb cache
1.5.8	1	KZPCM-DA 1 Dual Uscsi with FastEther PCI
1.5.9	7	MS10-EA 7 ES40 2GB Memory Option
1.5.10	1	SN-PBXGK-BB 1 Elsa Gloria Synergy 8M Video Graphics
1.5.11	1	TLZ10-LB 1 12/24GB 4mm DAT 5.25" HH
1.6	1	DS-SL13R-AB 1 Modula M4314R single buss,14x 1.0" Int
1.6.1	13	3R-A0919-AA 13 36.4GB Uscsi3 10k Universal disk 1"
1.7	1	DS-SL13R-AB 1 Modula M4314R single buss,14x 1.0" Int
1.7.1	13	3R-A0919-AA 13 36.4GB Uscsi3 10k Universal disk 1"
1.8	1	SN-LKQ47-AF 1 102 KEY KYBD,NON-WIN, Finnish
2	1	DS-TZ89N-TA 1 35/70GB SE DLT-tape "T" FWSE
3	1	BN19C-2E 1 PowerCable 240V, C-Europe
4	1	BN38C-02 1 Ultra Cbl VHDCI - 68HD

BOM for the external RA8000 RAID

Part Number	Qty	Description
1	1	175992-B22 1 MA8000 6x7 22U 50Hz opal
1.1	2	128697-B21 2 ACS V8.5F controller FCAL/FCSW
1.2	2	135823-B21 2 HSGxx Single external cache battery
1.3	24	176496-B22 24 36GB 10000r Ultra3 SCSI disk 1"
1.4	1	176622-B21 1 HSG80 FC Contr with 256MB cache
1.4.1	1	380674-B21 1 Cache Upg RA8k ESA12k 256MB
1.5	1	176622-B21 1 HSG80 FC Contr with 256MB cache
1.5.1	1	380674-B21 1 Cache Upg RA8k ESA12k 256MB
1.6	1	380553-001 1 OS Platf,Softw,Kit for FC Alpha UNIX
2	1	176219-B21 1 SAN Switch EL 8-Ports
3	1	234457-B23 1 Fibre Channel 15m Optical Cable
4	1	167365-B21 1 Rack mount kit for SAN switch
5	2	234457-B21 2 Fibre Channel 02m Optical Cable
6	1	168794-B21 1 Host Buss Cntr KGPSA-CA,OVMS,UNIX

www.Compaq.com/golden-eggs
Since:Jan-2001

COMPAQ 30-Jan-2001 GTAUES40B
Matti.Patari@compaq.com

AlphaServer ES40 UNIX Pedestal
GOLDEN EGGS Visuals, Helsinki

ES40 Model 2 Systems in Cabinet M15

Ethernet
FDDI

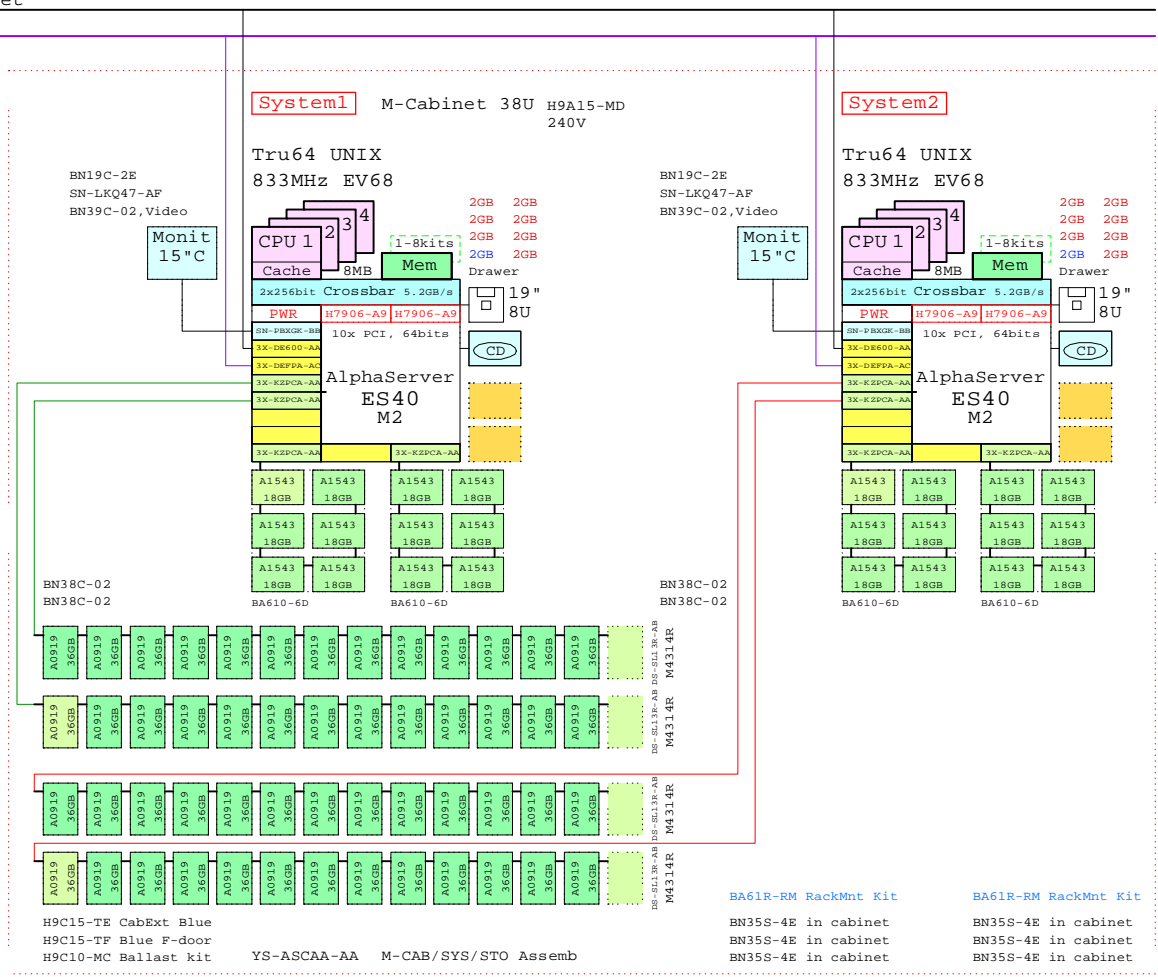

Bill of material for Cabinet and System 1

Part Number	Qty	Description
1	1	H9A15-MD 1 M-Series Cab,H9A15,Blue,240V 38U
1.1	1	BA61R-RM 1 ES40 Rackmount Kit
1.2	1	BN19C-2E 1 PowerCable 240V, C-Europe
1.3	3	BN35S-4E 3 PowerCord Cl3 to Cl4, Non US
1.4	2	BN38C-02 2 Ultra Cbl VHDCI - 68HD
1.5	1	BN39C-02 1 1.8 Video Extension Cable ****
1.6	1	DA-64CAA-EA 1 ES40 68/833 Model 2 2GB UNIX 10PCI DWR
1.6.1	1	3R-VRQV5-24 1 COMPAQ V55 CLR MON,NH,TCO95
1.6.2	1	3X-DE600-AA 1 10/100 1xChannel Ethernet, Twisted
1.6.3	1	3X-DEFFA-AC 1 PCI to FDDI SAS MMF with SC,Universal
1.6.4	4	3X-KZPCA-AA 4 Single channel LVD adapter
1.6.5	1	BA610-6D 1 ES40 Disk Drive Cage, 6-Bay
1.6.5.1	6	3R-A1543-AA 6 18.2GB Uscsi3 15k Universal disk 1"
1.6.6	1	BA610-6D 1 ES40 Disk Drive Cage, 6-Bay
1.6.6.1	6	3R-A1543-AA 6 18.2GB Uscsi3 15k Universal disk 1"
1.6.7	2	H7906-A9 2 ES40 Power Syply, 2nd or 3rd
1.6.8	3	KN610-CB 3 ES40 68/833MHz UNIX SMP 8mb cache
1.6.9	7	MS610-EA 7 ES40 2GB Memory Option
1.6.10	1	SN-PBXGK-BB 1 Elsa Gloria Synergy 8M Video Graphics
1.7	1	DS-SL13R-AB 1 Modula M4314R single buss,14x 1.0" Int
1.7.1	13	3R-A0919-AA 13 36.4GB Uscsi3 10k Universal disk 1"
1.8	1	DS-SL13R-AB 1 Modula M4314R single buss,14x 1.0" Int
1.8.1	13	3R-A0919-AA 13 36.4GB Uscsi3 10k Universal disk 1"
1.9	1	H9C10-MC 1 Ballast Kit for cabinets
1.10	1	H9C15-TE 1 Rear cab extender for H9A15 Blue
1.11	1	H9C15-TF 1 FrontDoorKit Blue for H9A15
1.12	1	SN-LKQ47-AF 1 102 KEY KYBD,NON-WIN, Finnish
1.13	1	YS-ASCAA-AA 1 M-CAB/SYS/STO Assembly

Bill of material for System 2

Part Number	Qty	Description
1	1	DA-64CAA-EA 1 ES40 68/833 Model 2 2GB UNIX 10PCI DWR
1.1	1	3R-VRQV5-24 1 COMPAQ V55 CLR MON,NH,TCO95
1.2	1	3X-DE600-AA 1 10/100 1xChannel Ethernet, Twisted
1.3	1	3X-DEFFA-AC 1 PCI to FDDI SAS MMF with SC,Universal
1.4	4	3X-KZPCA-AA 4 Single channel LVD adapter
1.5	1	BA610-6D 1 ES40 Disk Drive Cage, 6-Bay
1.5.1	6	3R-A1543-AA 6 18.2GB Uscsi3 15k Universal disk 1"
1.6	1	BA610-6D 1 ES40 Disk Drive Cage, 6-Bay
1.6.1	6	3R-A1543-AA 6 18.2GB Uscsi3 15k Universal disk 1"
1.7	2	H7906-A9 2 ES40 Power Syply, 2nd or 3rd
1.8	3	KN610-CB 3 ES40 68/833MHz UNIX SMP 8mb cache
1.9	7	MS610-EA 7 ES40 2GB Memory Option
1.10	1	SN-PBXGK-BB 1 Elsa Gloria Synergy 8M Video Graphics
2	1	DS-SL13R-AB 1 Modula M4314R single buss,14x 1.0" Int
2.1	13	3R-A0919-AA 13 36.4GB Uscsi3 10k Universal disk 1"
3	1	DS-SL13R-AB 1 Modula M4314R single buss,14x 1.0" Int
3.1	13	3R-A0919-AA 13 36.4GB Uscsi3 10k Universal disk 1"
4	1	BA61R-RM 1 ES40 Rackmount Kit
5	3	BN35S-4E 3 PowerCord Cl3 to Cl4, Non US
6	1	BN39C-02 1 1.8 Video Extension Cable ****
7	1	SN-LKQ47-AF 1 102 KEY KYBD,NON-WIN, Finnish
8	1	BN19C-2E 1 PowerCable 240V, C-Europe
9	2	BN38C-02 2 Ultra Cbl VHDCI - 68HD

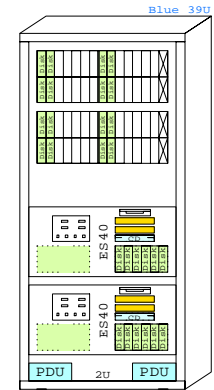

AlphaServer ES40 In H9A15 cabinet

This template is included in the present GOLDEN EGGS Software kit.

ES40 UNIX

www.Compaq.com/golden-eggs
Since:Jan-2001

COMPAQ 30-Jan-2001 GTAUES40C
Mattti.Patari@compaq.com

AlphaServer ES40 UNIX Cabinet
GOLDEN EGGS Visuals, Helsinki

ES40 Model 2 TruCluster with external storage

Ethernet

FDDI

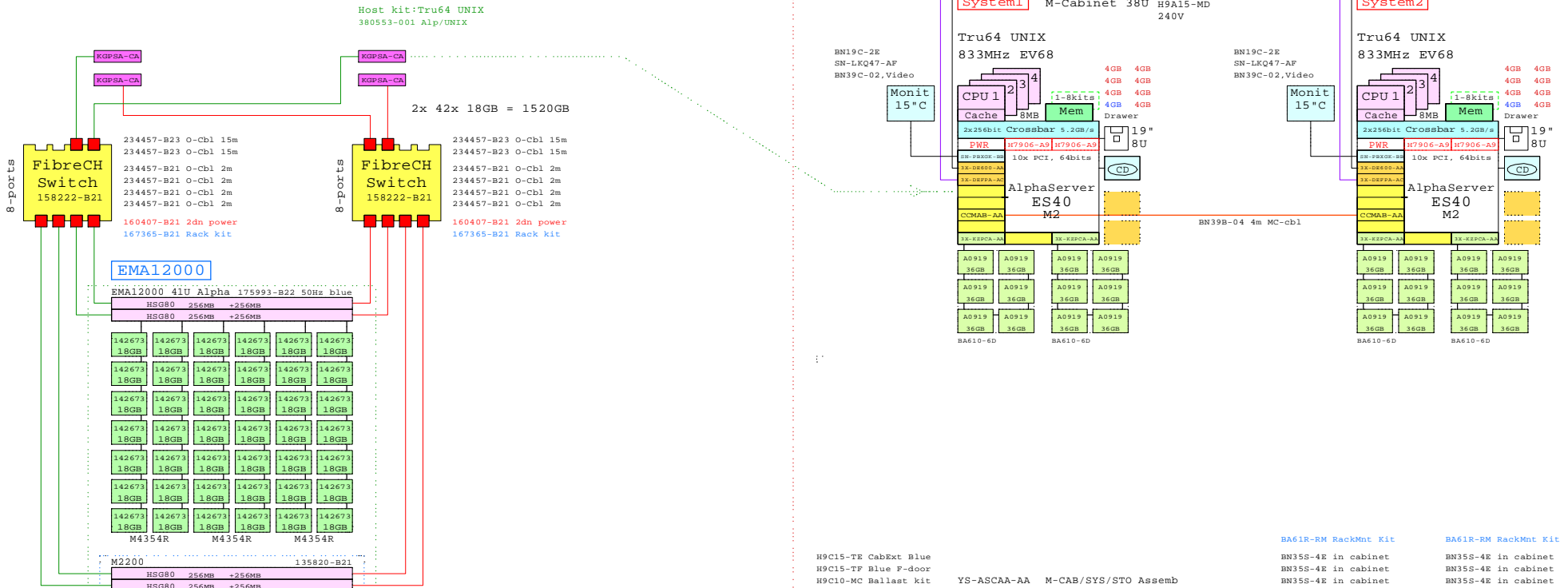

BOM of External Storage

Part Number	Qty	Description
1	1	175993-B22 1 EMA12000 6x7 41U 50Hz blue
1.1	2	128697-B21 2 ACS V8.5F controller FCAL/PCSW
1.2	1	135820-B21 1 Module M2200 shelf, NO controller
1.2.1	2	ACS V8.5F controller FCAL/PCSW
1.2.2	2	HSGKX Single external cache battery
1.2.3	6	SCSI cable VHDCI-VHDCI, 1m
1.2.4	1	HSG80 FC Contr with 256MB cache
1.2.4.1	1	Cache Upg RABK ESA12K 256MB
1.2.5	1	HSG80 FC Contr with 256MB cache
1.2.5.1	1	Cache Upg RABK ESA12K 256MB
1.2.6	1	Module M4354R dual buss, 7+7, 1.0"
1.2.6.1	8	18.2GB 10000r Ultra3 SCSI disk 1"
1.2.7	1	Module M4354R dual buss, 7+7, 1.0"
1.2.7.1	8	18.2GB 10000r Ultra3 SCSI disk 1"
1.2.8	1	Module M4354R dual buss, 7+7, 1.0"
1.2.8.1	9	18.2GB 10000r Ultra3 SCSI disk 1"
1.3	2	HSGKX Single external cache battery
1.4	42	18.2GB 10000r Ultra3 SCSI disk 1"
1.5	1	HSG80 FC Contr with 256MB cache
1.5.1	1	Cache Upg RABK ESA12K 256MB
1.6	1	HSG80 FC Contr with 256MB cache
1.6.1	1	Cache Upg RABK ESA12K 256MB
2	1	158222-B21 1 SAN Switch 8 Ports
2.1	6	FC Optical Short Wave GRIC 500
158222-B21	1	SAN Switch 8 Ports
3.1	6	FC Optical Short Wave GRIC 500
4	2	SAN switch redundant power supply
5	4	Fibre Channel 15m Optical Cable
6	1	Rack mount kit for SAN switch
7	8	Fibre Channel 02m Optical Cable
8	1	OS Platf Softw Kit for FC Alpha UNIX
9	4	Host Bus Cntr KQPSA-CA, OVMS, UNIX

BOM of Dual ES40 Cabinet

Part Number	Qty	Description
1	1	H9A15-MD 1 M-Series Cab, H9A15, Blue, 240V 38U
1.1	2	BA61R-RM 2 ES40 Rackmount Kit
1.2	2	PowerCable 240V, C-Europan
1.3	6	PowerCord c13 to c14, Non US
1.4	1	4m copper cbl for CCMB Mem, Chan
1.5	2	1.8 Video Extension Cable ***
1.6	1	DA-64CAA-FA 1 ES40 68/833 Model 2 4GB UNIX 10PCI DWR
1.6.1	3R-VRQV5-24	1 COMPAQ V55 CLR MEM, NH, TCC95
1.6.2	3X-DEPFA-AC	1 PCI to FDDI SAS MMF with SC, Universal
1.6.3	3X-DEPFA-AC	1 PCI to FDDI SAS MMF with SC, Universal
1.6.4	3X-RZPCA-AA	2 Single channel LVD adapter
1.6.5	BA610-6D	1 ES40 Disk Drive Cage, 6-Bay
1.6.5.1	3R-A0919-AA	6 36.4GB Ucsd3 10K Universal disk 1"
1.6.6	BA610-6D	1 ES40 Disk Drive Cage, 6-Bay
1.6.6.1	3R-A0919-AA	6 36.4GB Ucsd3 10K Universal disk 1"
1.6.7	CCMB-AA	1 PCI Mem. Channel-2 Cluster cntrl
1.6.8	H7906-AA	2 ES40 Power Supply, 2nd or 3rd
1.6.9	RN610-CB	2 ES40 4GB Memory Option
1.6.10	MS610-FA	7 ES40 4GB Memory Option
1.6.11	SN-PBXGR-BB	1 Elpa Gloria Synergy 8M Video Graphics
1.7	1	DA-64CAA-FA 1 ES40 68/833 Model 2 4GB UNIX 10PCI DWR
1.7.1	3R-VRQV5-24	1 COMPAQ V55 CLR MEM, NH, TCC95
1.7.2	3X-DEPFA-AC	1 PCI to FDDI SAS MMF with SC, Universal
1.7.3	3X-DEPFA-AC	1 PCI to FDDI SAS MMF with SC, Universal
1.7.4	3X-DEPFA-AC	2 Single channel LVD adapter
1.7.5	BA610-6D	1 ES40 Disk Drive Cage, 6-Bay
1.7.5.1	3R-A0919-AA	6 36.4GB Ucsd3 10K Universal disk 1"
1.7.6	BA610-6D	1 ES40 Disk Drive Cage, 6-Bay
1.7.6.1	3R-A0919-AA	6 36.4GB Ucsd3 10K Universal disk 1"
1.7.7	CCMB-AA	1 PCI Mem. Channel-2 Cluster cntrl
1.7.8	H7906-AA	2 ES40 Power Supply, 2nd or 3rd
1.7.9	RN610-CB	2 ES40 4GB Memory Option
1.7.10	MS610-FA	7 ES40 4GB Memory Option
1.7.11	SN-PBXGR-BB	1 Elpa Gloria Synergy 8M Video Graphics
1.8	1	Ballast Kit for cabinets
1.9	1	Rear cab extender for H9A15 Blue
1.10	1	FrontDoorKit Blue for H9A15
1.11	2	102 KEY KYBD, NON-WIN, Finish
1.12	1	M-CAB/SYS/STO Assembly

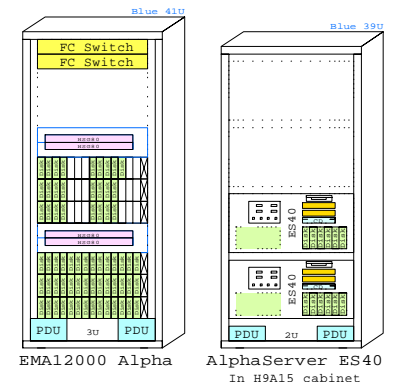

www.compaq.com/golden-eggs

COMPAQ 30-Jan-2001 GTAUES40D
Matti.Patari@compaq.com

ES40 UNIX AlphaServer ES40 UNIX Cluster GOLDEN EGGS Visuals, Helsinki

This template is included in the present GOLDEN EGGS Software kit.

Ethernet
FDDI

ES40 Model 2 Mini Tower System

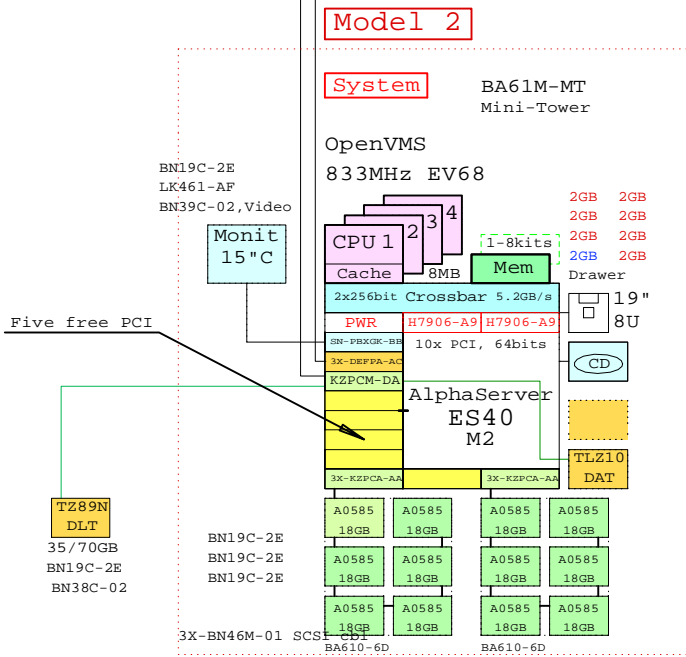

Bill of material, Model 2

Part Number	Qty	Description
1	1	BA61M-MT 1 ES40 Mini-Tower Enclosure
1.1	1	3X-BN46M-01 1 SCSI cable for Tape
1.2	1	BN19C-2E 1 PowerCable 240V, C-Europe
1.3	1	DY-64CAA-EA 1 ES40 68/833 Model 2 2GB OVMS 10PCI DWR
1.3.1	1	3R-VROV5-24 1 COMPAQ V55 CLR MON,NH,TCO95
1.3.2	1	3X-DEPFA-AC 1 PCI to FDDI SAS MMF with SC,Universal
1.3.3	2	3X-KZPCA-AA 2 Single channel LVD adapter
1.3.4	1	BA610-6D 1 ES40 Disk Drive Cage, 6-Bay
1.3.4.1	6	3R-A0585-AA 6 18.2GB Uscsi3 10k Universal disk 1"
1.3.5	1	BA610-6D 1 ES40 Disk Drive Cage, 6-Bay
1.3.5.1	6	3R-A0585-AA 6 18.2GB Uscsi3 10k Universal disk 1"
1.3.6	3	BN19C-2E 3 PowerCable 240V, C-Europe
1.3.7	1	BN39C-02 1 1.8 Video Extension Cable ****
1.3.8	2	H7906-A9 2 ES40 Power Sypl, 2nd or 3rd
1.3.9	3	KN610-CC 3 ES40 68/833MHz OVMS SMP 8mb cache
1.3.10	1	KZPCM-DA 1 Dual Uscsi with FastEther PCI
1.3.11	7	MS610-EA 7 ES40 2GB Memory Option
1.3.12	1	SN-PBXGK-BB 1 Elsa Gloria Synergy 8M Video Graphics
1.3.13	1	TLZ10-LB 1 12/24GB 4mm DAT 5.25" HH
1.4	1	LK461-AF 1 VMS STYLE KEYBOARD, Fin/Swed
2	1	DS-TZ89N-TA 1 35/70GB SE DLT-tape TT FWSE
3	1	BN19C-2E 1 PowerCable 240V, C-Europe
4	1	BN38C-02 1 Ultra Cbl VHDCI - 68HD

ES40 Model 1 Mini Tower System

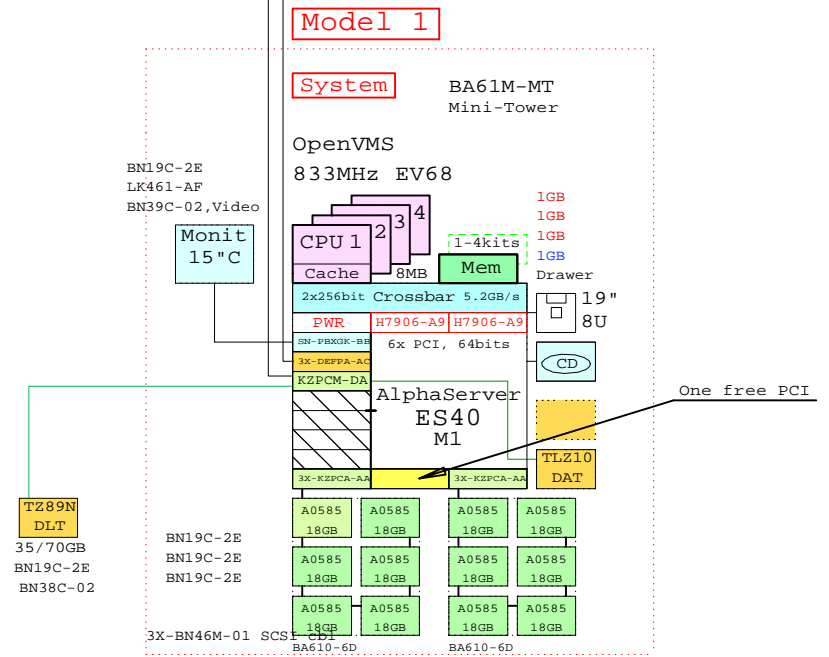

Bill of material, Model 1

Part Number	Qty	Description
1	1	BA61M-MT 1 ES40 Mini-Tower Enclosure
1.1	1	3X-BN46M-01 1 SCSI cable for Tape
1.2	1	BN19C-2E 1 PowerCable 240V, C-Europe
1.3	1	DY-62CAA-DA 1 ES40 68/833 Model 1 1GB OVMS 6PCI DWR
1.3.1	1	3R-VROV5-24 1 COMPAQ V55 CLR MON,NH,TCO95
1.3.2	1	3X-DEPFA-AC 1 PCI to FDDI SAS MMF with SC,Universal
1.3.3	2	3X-KZPCA-AA 2 Single channel LVD adapter
1.3.4	1	BA610-6D 1 ES40 Disk Drive Cage, 6-Bay
1.3.4.1	6	3R-A0585-AA 6 18.2GB Uscsi3 10k Universal disk 1"
1.3.5	1	BA610-6D 1 ES40 Disk Drive Cage, 6-Bay
1.3.5.1	6	3R-A0585-AA 6 18.2GB Uscsi3 10k Universal disk 1"
1.3.6	3	BN19C-2E 3 PowerCable 240V, C-Europe
1.3.7	1	BN39C-02 1 1.8 Video Extension Cable ****
1.3.8	2	H7906-A9 2 ES40 Power Sypl, 2nd or 3rd
1.3.9	3	KN610-CC 3 ES40 68/833MHz OVMS SMP 8mb cache
1.3.10	1	KZPCM-DA 1 Dual Uscsi with FastEther PCI
1.3.11	3	MS610-EA 3 ES40 1GB Memory Option
1.3.12	1	SN-PBXGK-BB 1 Elsa Gloria Synergy 8M Video Graphics
1.3.13	1	TLZ10-LB 1 12/24GB 4mm DAT 5.25" HH
1.4	1	LK461-AF 1 VMS STYLE KEYBOARD, Fin/Swed
2	1	DS-TZ89N-TA 1 35/70GB SE DLT-tape TT FWSE
3	1	BN19C-2E 1 PowerCable 240V, C-Europe
4	1	BN38C-02 1 Ultra Cbl VHDCI - 68HD

www.Compaq.com/golden-eggs
Since:Jan-2001

COMPAQ	30-Jan-2001	GTAVES40A
		Matti.Patari@compaq.com

AlphaServer ES40 Mini Tower
GOLDEN EGGS Visuals, Helsinki

Ethernet
FDDI

ES40 Model 2 Pedestal System

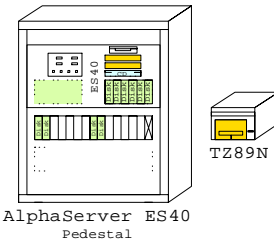
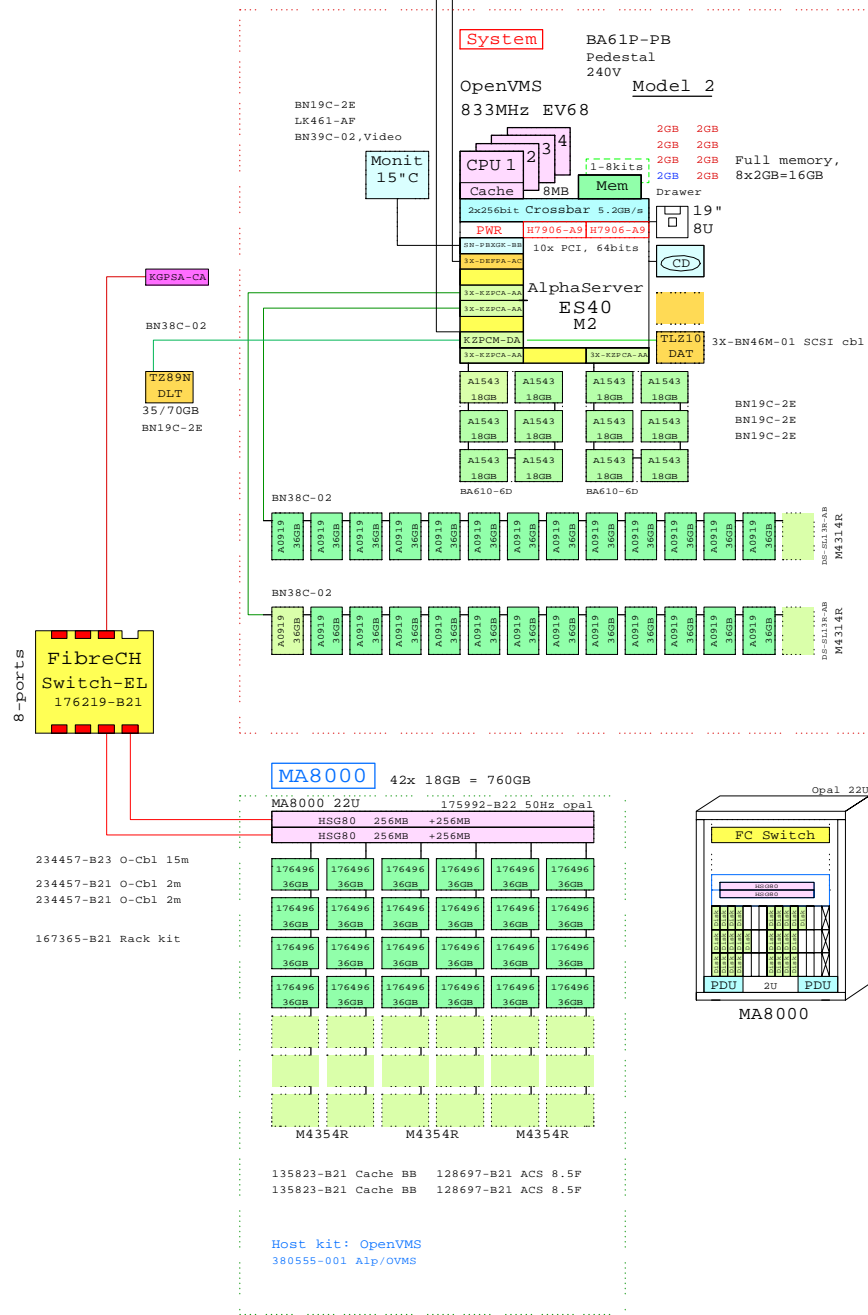

Bill of material for the base Pedestal

Part Number	Qty	Description
1	1	ES40 Pedestal Enclosure 240V Europe
1.1	1	SCSI cable for Tape
1.2	4	PowerCable 240V, C-Europe
1.3	2	Ultra Cbl VHDCI - 68HD
1.4	1	1.8 Video Extension Cable ****
1.5	1	Modula M4314R single buss,14x 1.0\"/>

BOM for the external RA8000 RAID

Part Number	Qty	Description
1	1	MA8000 6x7 22U 50Hz opal
1.1	2	ACS V8.5F controller FCAL/FCSW
1.2	2	HSGxx Single external cache battery
1.3	24	36GB 10000r Ultra3 SCSI disk 1\"/>

www.Compaq.com/golden-eggs
Since:Jan-2001

COMPAQ 30-Jan-2001 GTAVES40B
Matti.Patari@compaq.com

AlphaServer ES40 OVMS Pedestal
GOLDEN EGGS Visuals, Helsinki

ES40 OVMS

ES40 Model 2 Systems in Cabinet M15

Ethernet

FDDI

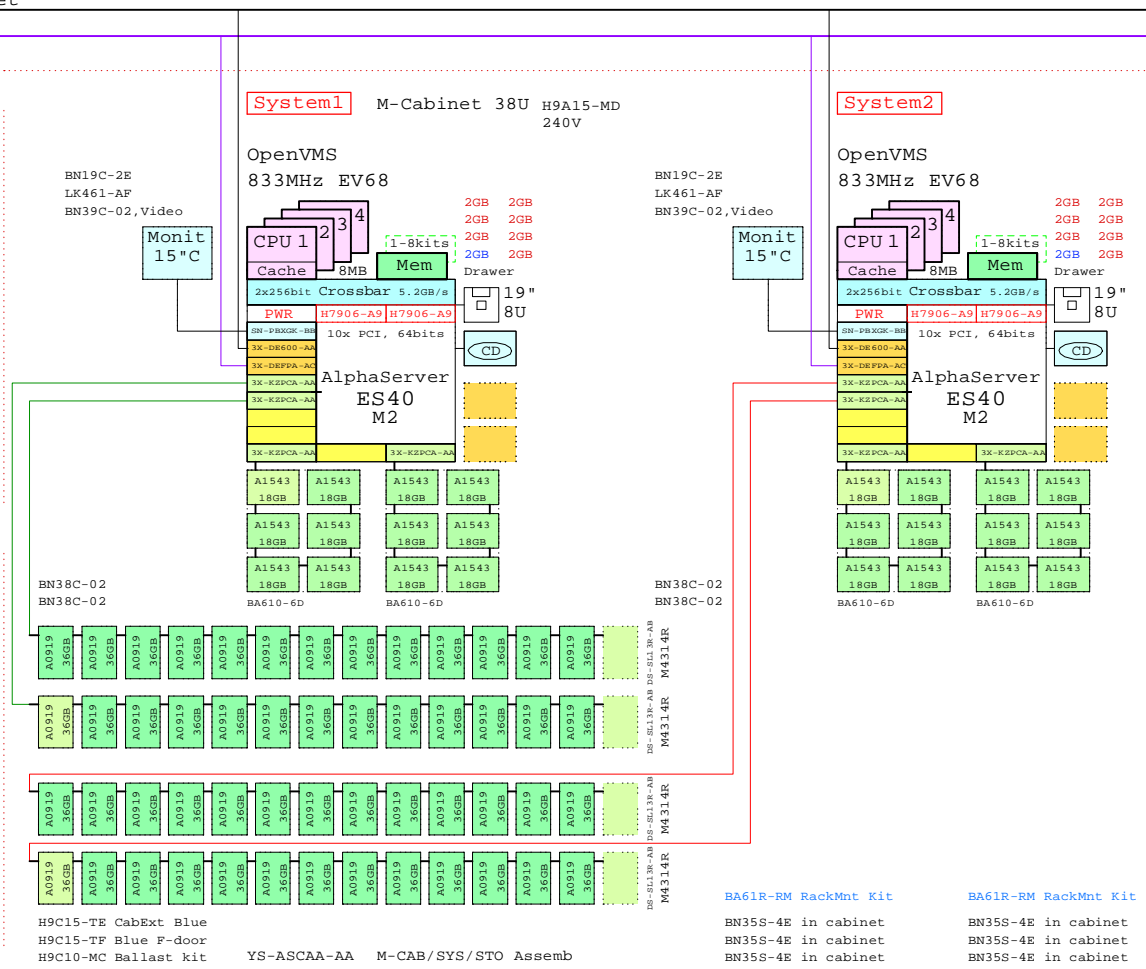

This template is included in the present GOLDEN EGGS Software kit.

Bill of material for Cabinet and System 1

Part Number	Qty	Description
1	H9A15-MD	1 M-Series Cab,H9A15,Blue,240V 38U
1.1	BA61R-RM	1 ES40 Rackmount Kit
1.2	BN19C-2E	1 PowerCable 240V, C-Europe
1.3	BN35S-4E	3 PowerCord C13 to C14, Non US
1.4	BN38C-02	2 Ultra Cbl VHDCI - 68HD
1.5	BN39C-02	1 1.8 Video Extension Cable ****
1.6	DS-SL13R-AB	1 Modula M4314R single buss,14x 1.0" Int
1.6.1	3R-A0919-AA	13 36.4GB Uscsi3 10k Universal disk 1"
1.7	DS-SL13R-AB	1 Modula M4314R single buss,14x 1.0" Int
1.7.1	3R-A0919-AA	13 36.4GB Uscsi3 10k Universal disk 1"
1.8	DY-64CAA-EA	1 ES40 68/833 Model 2 2GB OVMS 10PCI DW
1.8.1	3R-VRQV5-24	1 COMPAQ V55 CLR MON,NH,TCO95
1.8.2	3X-DE600-AA	1 10/100 1xChannel Ethernet, Twisted
1.8.3	3X-DEFPA-AC	1 PCI to FDDI SAS MMF with SC,Universal
1.8.4	3X-KZPCA-AA	4 Single channel LVD adapter
1.8.5	BA610-6D	1 ES40 Disk Drive Cage, 6-Bay
1.8.5.1	3R-A1543-AA	6 18.2GB Uscsi3 15k Universal disk 1"
1.8.6	BA610-6D	1 ES40 Disk Drive Cage, 6-Bay
1.8.6.1	3R-A1543-AA	6 18.2GB Uscsi3 15k Universal disk 1"
1.8.7	H7906-A9	2 ES40 Power Sply, 2nd or 3rd
1.8.8	KN610-CC	3 ES40 68/833MHz OVMS SMP 8mb cache
1.8.9	MS610-EA	7 ES40 2GB Memory Option
1.8.10	SN-PBXGK-BB	1 Elsa Gloria Synergy 8M Video Graphics
1.9	H9C10-MC	1 Ballast Kit for cabinets
1.10	H9C15-TE	1 Rear cab extender for H9A15 Blue
1.11	H9C15-TF	1 FrontDoorKit Blue for H9A15
1.12	LK461-AF	1 VMS STYLE KEYBOARD, Fin/Swed
1.13	YS-ASCAA-AA	1 M-CAB/SYS/STO Assembly

Bill of material for System 2

Part Number	Qty	Description
1	DY-64CAA-EA	1 ES40 68/833 Model 2 2GB OVMS 10PCI DW
1.1	3R-VRQV5-24	1 COMPAQ V55 CLR MON,NH,TCO95
1.2	3X-DE600-AA	1 10/100 1xChannel Ethernet, Twisted
1.3	3X-DEFPA-AC	1 PCI to FDDI SAS MMF with SC,Universal
1.4	3X-KZPCA-AA	4 Single channel LVD adapter
1.5	BA610-6D	1 ES40 Disk Drive Cage, 6-Bay
1.5.1	3R-A1543-AA	6 18.2GB Uscsi3 15k Universal disk 1"
1.6	BA610-6D	1 ES40 Disk Drive Cage, 6-Bay
1.6.1	3R-A1543-AA	6 18.2GB Uscsi3 15k Universal disk 1"
1.7	H7906-A9	2 ES40 Power Sply, 2nd or 3rd
1.8	KN610-CC	3 ES40 68/833MHz OVMS SMP 8mb cache
1.9	MS610-EA	7 ES40 2GB Memory Option
1.10	SN-PBXGK-BB	1 Elsa Gloria Synergy 8M Video Graphics
2	DS-SL13R-AB	1 Modula M4314R single buss,14x 1.0" Int
2.1	3R-A0919-AA	13 36.4GB Uscsi3 10k Universal disk 1"
3	DS-SL13R-AB	1 Modula M4314R single buss,14x 1.0" Int
3.1	3R-A0919-AA	13 36.4GB Uscsi3 10k Universal disk 1"
4	BA61R-RM	1 ES40 Rackmount Kit
5	BN35S-4E	3 PowerCord C13 to C14, Non US
6	BN39C-02	1 1.8 Video Extension Cable ****
7	BN19C-2E	1 PowerCable 240V, C-Europe
8	BN38C-02	2 Ultra Cbl VHDCI - 68HD
9	LK461-AF	1 VMS STYLE KEYBOARD, Fin/Swed

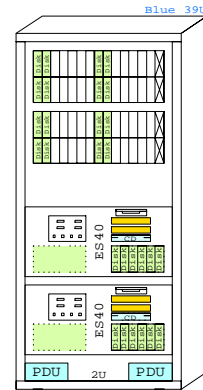

AlphaServer ES40 In H9A15 cabinet

www.Compaq.com/golden-eggs
Since:Jan-2001

COMPAQ	30-Jan-2001	GTAVES40C
	Matti.Patari@compaq.com	

ES40 OVMS

AlphaServer ES40 OpenVMS Cab.
GOLDEN EGGS Visuals, Helsinki

ES40 Model 2 OpenVMS Cluster with external storage

Ethernet

FDDI

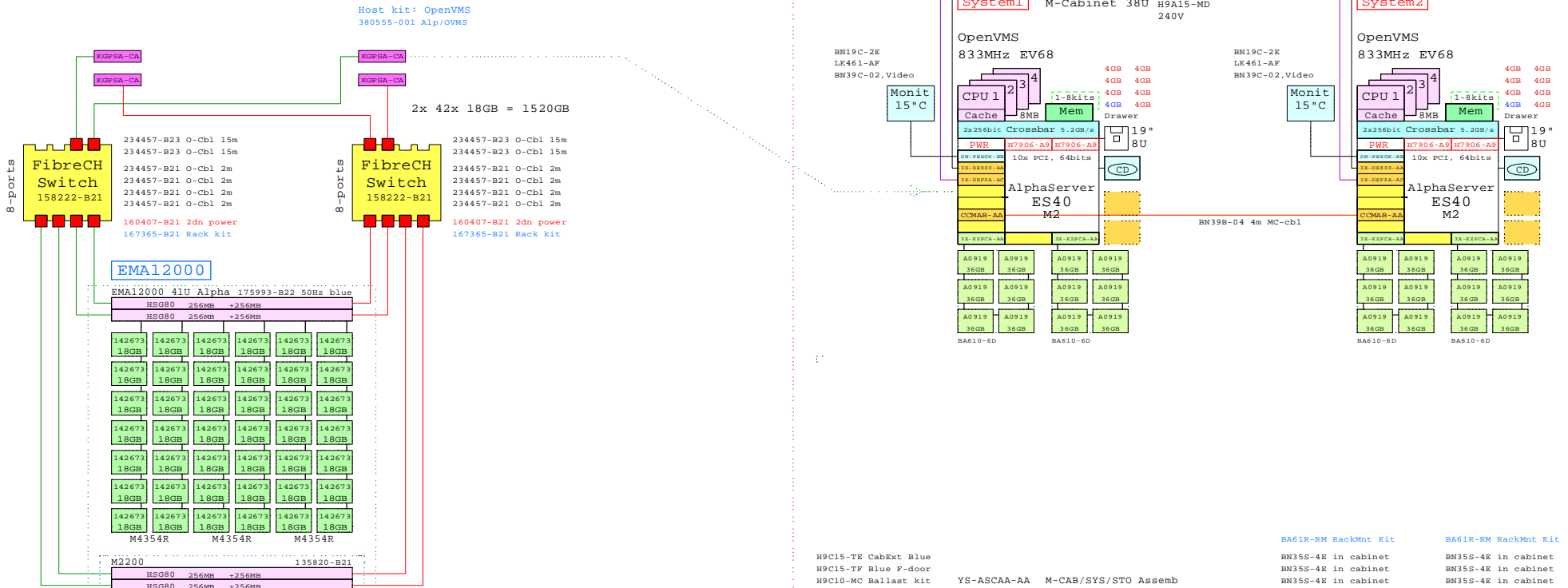

BOM of External Storage

Part Number	Qty	Description
1	175993-B22	1 EMA12000 6x7 41U 50Hz blue
1.1	128697-B21	2 ACS V8.5F controller FCAL/PCSW
1.2	135820-B21	1 Module M2200 shelf, NO controller
1.2.1	128697-B21	2 ACS V8.5F controller FCAL/PCSW
1.2.2	135823-B21	2 HSGKX Single external cache battery
1.2.3	168256-B21	6 SCSI cable VHDCI-VHDCI, 1m
1.2.4	176622-B21	1 HSG80 FC Contr with 256MB cache
1.2.4.1	380674-B21	1 Cache Upg RARk ESA12k 256MB
1.2.5	176622-B21	1 HSG80 FC Contr with 256MB cache
1.2.5.1	380674-B21	1 Cache Upg RARk ESA12k 256MB
1.2.6	190211-B31	1 Modula M4354R dual buss, 7+7, 1.0"
1.2.6.1	142673-B22	8 18.20B 10000r Ultra3 SCSI disk 1"
1.2.7	190211-B31	1 Modula M4354R dual buss, 7+7, 1.0"
1.2.7.1	142673-B22	8 18.20B 10000r Ultra3 SCSI disk 1"
1.2.8	190211-B31	1 Modula M4354R dual buss, 7+7, 1.0"
1.2.8.1	142673-B22	9 18.20B 10000r Ultra3 SCSI disk 1"
1.3	135823-B21	2 HSGKX Single external cache battery
1.4	142673-B22	42 18.20B 10000r Ultra3 SCSI disk 1"
1.5	176622-B21	1 HSG80 FC Contr with 256MB cache
1.5.1	380674-B21	1 Cache Upg RARk ESA12k 256MB
1.6	176622-B21	1 HSG80 FC Contr with 256MB cache
1.6.1	380674-B21	1 Cache Upg RARk ESA12k 256MB
2	158222-B21	1 SAN Switch 8 Ports
2.1	380561-B21	6 FC Optical Short Wave GRIC 500
2.2	158222-B21	1 SAN Switch 8 Ports
2.3	380561-B21	6 FC Optical Short Wave GRIC 500
4	160407-B21	2 SAN switch redundant power supply
5	234457-B23	4 Fibre Channel 15m Optical Cable
6	167365-B21	2 Rack mount kit for SAN switch
7	234457-B21	8 Fibre Channel 15m Optical Cable
8	380555-001	1 OS Platf Softw Kit for FC Alpha OVMS
9	168794-B21	4 Host Bus Cntr KQPSA-CA,OVMS,UNIX

BOM of Dual ES40 Cabinet

Part Number	Qty	Description
1	H9A15-MD	1 M-Series Cab,H9A15,Blue,240V 38U
1.1	BA61R-RM	2 ES40 Rackmount Kit
1.2	BN19C-2E	2 PowerCable 240V, C-Europe
1.3	BN15S-4E	6 PowerCord c13 to c14, Rom US
1.4	BN39B-04	1 04m copper cbl for CCMAB Mem,Chan
1.5	BN39C-02	2 1.8 Video Extension Cable ***
1.6	DV-64CAA-FA	1 ES40 68/833 Model 2 4GB OVMS 10PCI DWR
1.6.1	3R-VRQV5-24	1 COMPAQ V55 CLR MEM,NH,TC095
1.6.2	3X-DEPPA-AA	1 10/100 1xChannel Ethernet, Twisted
1.6.3	3X-DEPPA-AA	1 PCI to FDDI SAS MMF with SC/Universal
1.6.4	3X-KZPCA-AA	2 Single channel LVD adapter
1.6.5	BA610-6D	1 ES40 Disk Drive Cage, 6-Bay
1.6.5.1	3R-A0919-AA	6 36.4GB Ucsd3 10K Universal disk 1"
1.6.6	BA610-6D	1 ES40 Disk Drive Cage, 6-Bay
1.6.6.1	3R-A0919-AA	6 36.4GB Ucsd3 10K Universal disk 1"
1.6.7	CCMAB-AA	1 PCI Mem. Channel-2 Cluster cntrl
1.6.8	H7906-AA	3 ES40 Power Supply, 2nd or 3rd
1.6.9	RN610-CC	2 ES40 4GB Memory Option
1.6.10	MS610-FA	7 ES40 4GB Memory Option
1.6.11	SN-PBXKX-BB	1 Elpa Gloria Synergy 8M Video Graphics
1.7	DV-64CAA-FA	1 ES40 68/833 Model 2 4GB OVMS 10PCI DWR
1.7.1	3R-VRQV5-24	1 COMPAQ V55 CLR MEM,NH,TC095
1.7.2	3X-DEPPA-AA	1 10/100 1xChannel Ethernet, Twisted
1.7.3	3X-DEPPA-AA	1 PCI to FDDI SAS MMF with SC/Universal
1.7.4	3X-KZPCA-AA	2 Single channel LVD adapter
1.7.5	BA610-6D	1 ES40 Disk Drive Cage, 6-Bay
1.7.5.1	3R-A0919-AA	6 36.4GB Ucsd3 10K Universal disk 1"
1.7.6	BA610-6D	1 ES40 Disk Drive Cage, 6-Bay
1.7.6.1	3R-A0919-AA	6 36.4GB Ucsd3 10K Universal disk 1"
1.7.7	CCMAB-AA	1 PCI Mem. Channel-2 Cluster cntrl
1.7.8	H7906-AA	2 ES40 Power Supply, 2nd or 3rd
1.7.9	RN610-CC	2 ES40 4GB Memory Option
1.7.10	MS610-FA	7 ES40 4GB Memory Option
1.7.11	SN-PBXKX-BB	1 Elpa Gloria Synergy 8M Video Graphics
1.8	H9C10-MC	1 Ballast Kit for cabinets
1.9	H9C15-TE	1 Rear cab extender for H9A15 Blue
1.10	H9C15-TF	1 FrontSupport Blue for H9A15
1.11	LK461-AF	2 VMS STYLE KEYBOARD, Pin/Swed
1.12	YS-ASCAA-AA	1 M-CAB/SYS/STO Assembly

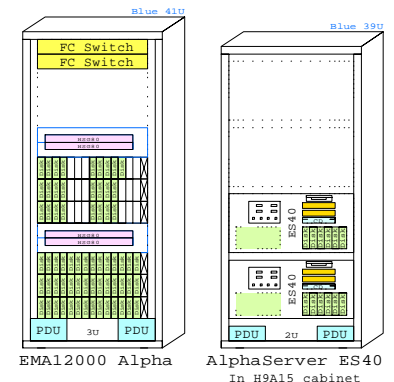

www.compaq.com/golden-eggs
Since 12-Jan-2001

COMPAQ 30-Jan-2001 GTAVES40D
Matti.Patari@compaq.com

ES40 OVMS AlphaServer ES40 OpenVMS Clust
GOLDEN EGGS Visuals, Helsinki

This template is included in the present GOLDEN EGGS Software kit.

Optional External Fibre Channel Storage

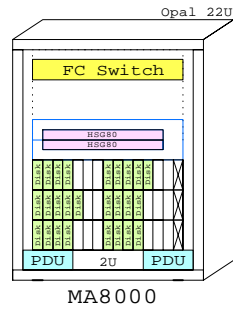

MA8000

MA8000 42x 18GB = 760GB

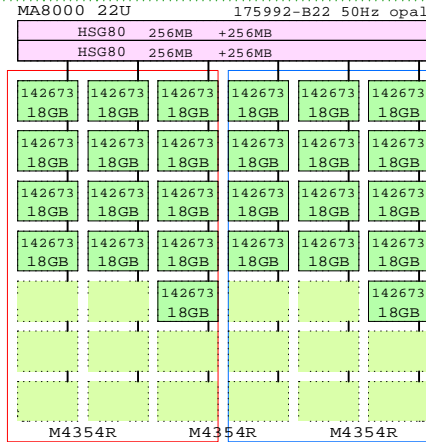

135823-B21 Cache BB 128697-B21 ACS 8.5F
135823-B21 Cache BB 128697-B21 ACS 8.5F

BOM for External Storage

Part Number	Qty	Description
1	1	175992-B22 1 MA8000 6x7 22U 50Hz opal
1.1	2	128697-B21 2 ACS V8.5F controller FCAL/FCSW
1.2	2	135823-B21 2 HSGxx Single external cache battery
1.3	26	142673-B22 26 18.2GB 10000r Ultra3 SCSI disk 1"
1.4	1	176622-B21 1 HSG80 FC Contr with 256MB cache
1.4.1	1	380674-B21 1 Cache Upg RA8k ESA12k 256MB
1.5	1	176622-B21 1 HSG80 FC Contr with 256MB cache
1.5.1	1	380674-B21 1 Cache Upg RA8k ESA12k 256MB
2	1	158222-B21 1 SAN Switch 8 Ports
2.1	4	380561-B21 4 FC Optical Short Wave GBIC
3	1	160407-B21 1 SAN switch redundant power supply
4	1	167365-B21 1 Rack mount kit for SAN switch
5	4	234457-B21 4 Fibre Channel 02m Optical Cable
6	1	380555-001 1 OS Platf.Softw.Kit for FC Alpha OVMS
7	2	168794-B21 2 Host Buss Cntr KGPSA-CA,OVMS,UNIX

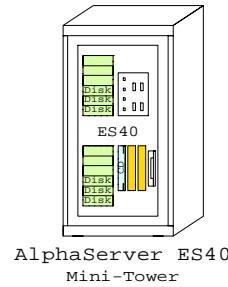

AlphaServer ES40 Mini-Tower

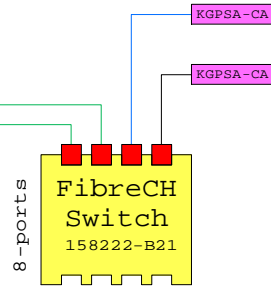

234457-B21 O-Cbl 2m
234457-B21 O-Cbl 2m
234457-B21 O-Cbl 2m
234457-B21 O-Cbl 2m
160407-B21 2dn power
167365-B21 Rack kit
Host kit: OpenVMS
380555-001 Alp/OVMS

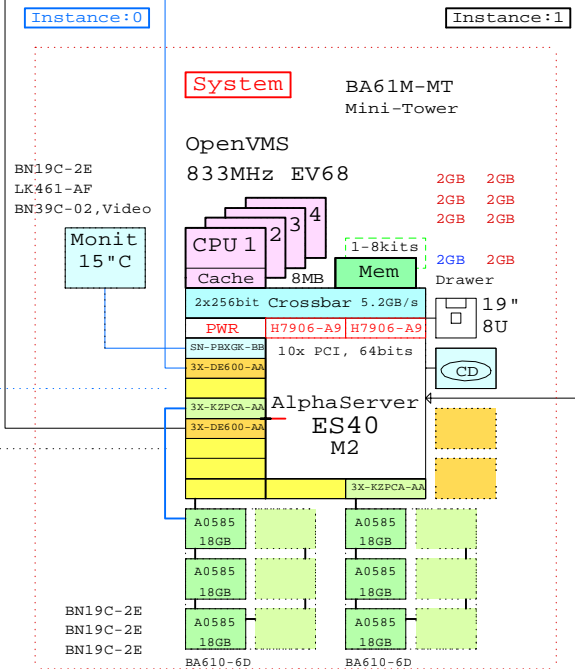

BOM for Instance: 0

Part Number	Qty	Description
1	1	BA61M-MT ES40 Mini-Tower Enclosure
1.1	1	BN19C-2E PowerCable 240V, C-Europe
1.2	1	DY-64CAA-EA ES40 68/833 Model 2 2GB OVMS 10PCI DWR
1.2.1	1	3R-VRQV5-24 COMPAQ V55 CLR MON,NH,TC095
1.2.2	1	3X-DE600-AA 1 10/100 1xChannel Ethernet, Twisted
1.2.3	1	3X-KZPCA-AA 1 Single channel LVD adapter
1.2.4	1	BA610-6D ES40 Disk Drive Cage, 6-Bay
1.2.4.1	3	3R-A0585-AA 3 18.2GB Uscsi3 10k Universal disk 1"
1.2.5	1	BN19C-2E PowerCable 240V, C-Europe
1.2.6	1	BN39C-02 1 1.8 Video Extension Cable ****
1.2.7	1	SN-PBXGK-BB 1 Elsa Gloria Synergy 8M Video Graphics
1.3	1	LK461-AF 1 VMS STYLE KEYBOARD, Fin/Swed

BOM for Instance: 1

Part Number	Qty	Description
1	1	BA610-6D ES40 Disk Drive Cage, 6-Bay
1.1	3	3R-A0585-AA 3 18.2GB Uscsi3 10k Universal disk 1"
2	3	KN610-CC 3 ES40 6/833MHz OVMS SMP 8mb cache
3	1	3X-DE600-AA 1 10/100 1xChannel Ethernet, Twisted
4	1	3X-KZPCA-AA 1 Single channel LVD adapter
5	2	H7906-A9 2 ES40 Power Syplly, 2nd or 3rd
6	2	BN19C-2E 2 PowerCable 240V, C-Europe
7	7	MS610-EA 7 ES40 2GB Memory Option

www.Compaq.com/golden-eggs Since:Nov-2000

COMPAQ 30-Jan-2001 GTAVES40E
Matti.Patari@compaq.com

AlphaServer ES40 with OpenVMS/Galaxy

Ethernet

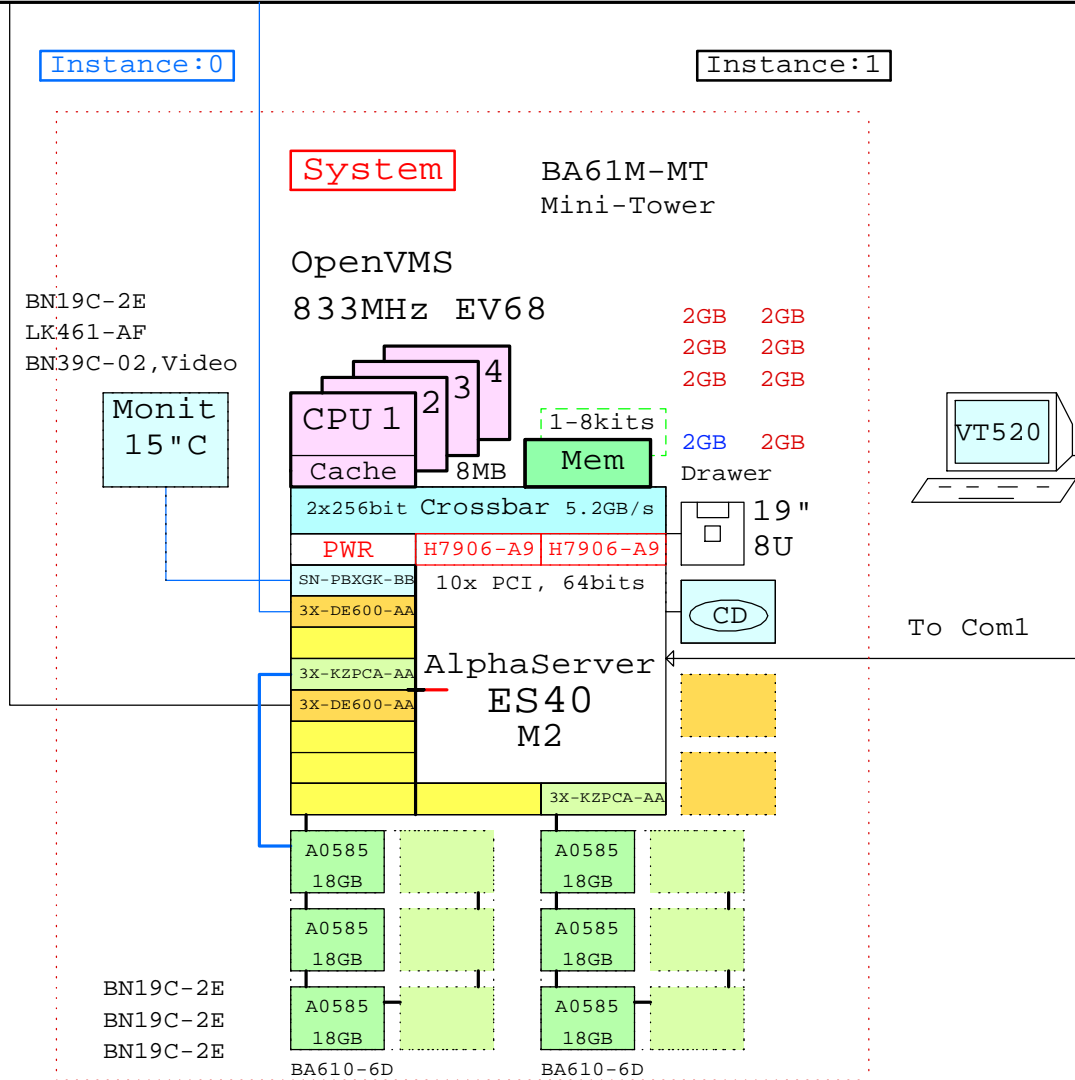

Ethernet

ES40 Model 1 Pedestal System

ES40 Model 1 Mini Tower System

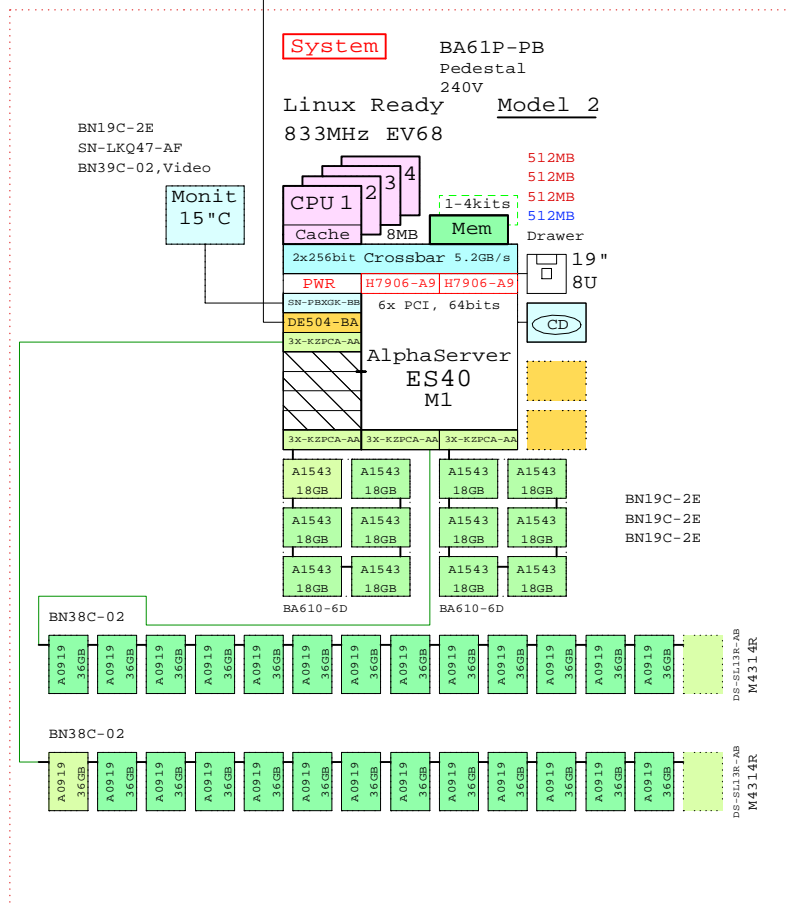

Gigabit Ethernet

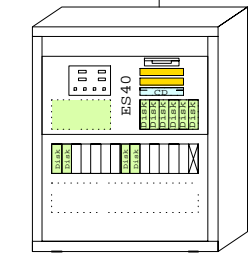

AlphaServer ES40 Pedestal

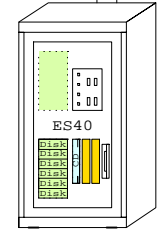

AlphaServer ES40 Mini-Tower

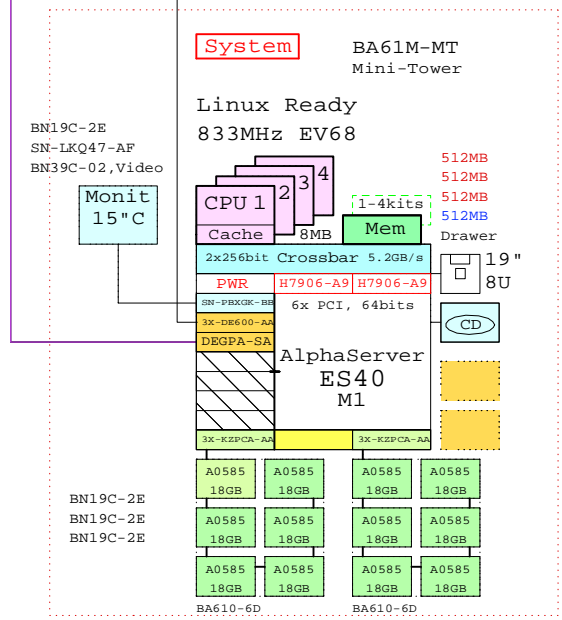

Part Number	Qty	Description
1	1	BA61P-PB ES40 Pedestal Enclosure 240V Europe
1.1	4	BN19C-2E PowerCable 240V, C-Europe
1.2	2	BN38C-02 Ultra Cbl VHDCI - 68HD
1.3	1	BN39C-02 1.8 Video Extension Cable ****
1.4	1	DJ-62CAA-CA ES40 68/833 Model 1 512MB LinuxReady 6PC
1.4.1	1	3R-VROV5-24 COMPAQ V55 CLR MON,NH,TCO95
1.4.2	4	3X-KZPCA-AA Single channel LVD adapter
1.4.3	1	BA610-6D ES40 Disk Drive Cage, 6-Bay
1.4.3.1	6	3R-A1543-AA 18.2GB Uscsi3 15k Universal disk 1"
1.4.4	1	BA610-6D ES40 Disk Drive Cage, 6-Bay
1.4.4.1	6	3R-A1543-AA 18.2GB Uscsi3 15k Universal disk 1"
1.4.5	1	DE504-BA PCI 10/100 MbitX4 ETHNT ALPHA
1.4.6	2	H7906-A9 ES40 Power Syplly, 2nd or 3rd
1.4.7	3	KN610-CA ES40 68/833MHz SMP 8mb cache
1.4.8	3	MS610-CA ES40 512MB Memory Option
1.4.9	1	SN-PBXGK-BB Elsa Gloria Synergy 8M Video Graphics
1.5	1	DS-SL13R-AB Modula M4314R single buss,14x 1.0" Int
1.5.1	13	3R-A0919-AA 36.4GB Uscsi3 10k Universal disk 1"
1.6	1	DS-SL13R-AB Modula M4314R single buss,14x 1.0" Int
1.6.1	13	3R-A0919-AA 36.4GB Uscsi3 10k Universal disk 1"
1.7	1	SN-LKQ47-AF 102 KEY KYBD,NON-WIN, Finnish

Part Number	Qty	Description
1	1	BA61M-MT ES40 Mini-Tower Enclosure
1.1	1	BN19C-2E PowerCable 240V, C-Europe
1.2	1	DJ-62CAA-CA ES40 68/833 Model 1 512MB LinuxReady 6PC
1.2.1	1	3R-VROV5-24 COMPAQ V55 CLR MON,NH,TCO95
1.2.2	1	3X-DE600-AA 10/100 1xChannel Ethernet, Twisted
1.2.3	2	3X-KZPCA-AA Single channel LVD adapter
1.2.4	1	BA610-6D ES40 Disk Drive Cage, 6-Bay
1.2.4.1	6	3R-A0585-AA 18.2GB Uscsi3 10k Universal disk 1"
1.2.5	1	BA610-6D ES40 Disk Drive Cage, 6-Bay
1.2.5.1	6	3R-A0585-AA 18.2GB Uscsi3 10k Universal disk 1"
1.2.6	3	BN19C-2E PowerCable 240V, C-Europe
1.2.7	1	BN39C-02 1.8 Video Extension Cable ****
1.2.8	1	DEGPA-SA PCI to GigabitEthernet SX Adap
1.2.9	2	H7906-A9 ES40 Power Syplly, 2nd or 3rd
1.2.10	3	KN610-CA ES40 68/833MHz SMP 8mb cache
1.2.11	3	MS610-CA ES40 512MB Memory Option
1.2.12	1	SN-PBXGK-BB Elsa Gloria Synergy 8M Video Graphics
1.3	1	SN-LKQ47-AF 102 KEY KYBD,NON-WIN, Finnish

www.Compaq.com/golden-eggs Since Jan-2001

COMPAQ 30-Jan-2001 GTALES40A Matti.Patari@compaq.com

ES40 Linux Golden Eggs Visuals, Helsinki

This template is included in the present GOLDEN EGGS Software kit.

AlphaServer GS80 M4 and M8, 67/731 Systems

AlphaServer GS80 Model 4

DA-A80AA-AC/AD/AE Model 4 Tru64 UNIX
 DY-A80AA-AC/AD/AE Model 4 OpenVMS
 US/EU/JP

AlphaServer GS80 Model 8

DA-A80BA-AC/AD/AE Model 8 Tru64 UNIX
 DY-A80BA-AC/AD/AE Model 8 OpenVMS

Upgrade: M4->M8

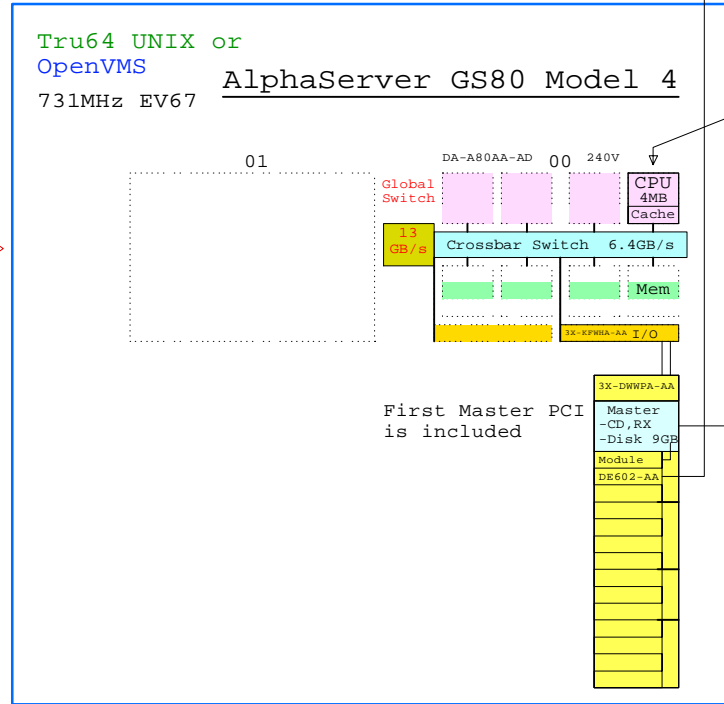
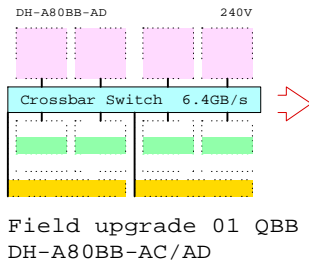

HxWxD 170x80x100cm

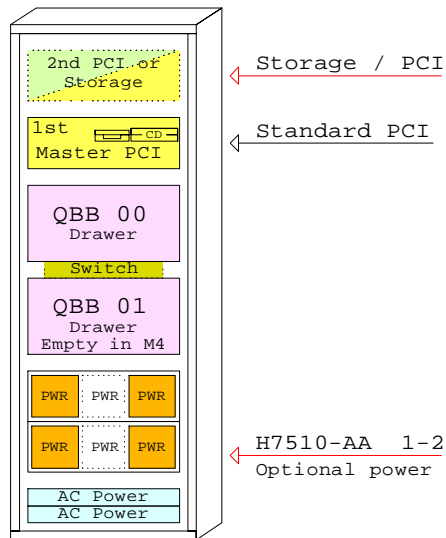

AlphaServer GS80

One optional storage shelf

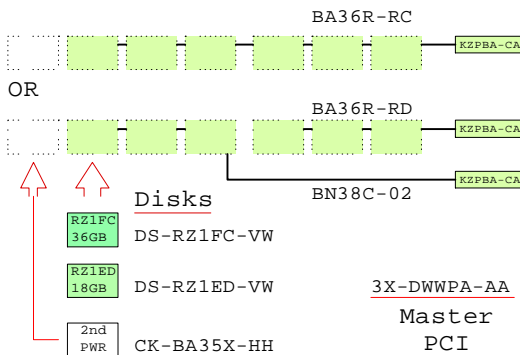

Licenses included:

- Tru64 UNIX V4.0G, Base license, Unlimited User license, Server Extension license, and Internet Solutions Software license and Netscape's Enterprise Server 3.0.
- OpenVMS V7.2-1H1 Base license and Enterprise Integration Package V3.0.

@731MHz
 SPECint95 -
 SPECfp95 -
 SPECweb96 -
 TPC -
 Software Processor Code: G

COMPAQ 23-Feb-2001 GEAGS801
 Matti.Patari@compaq.com

AlphaServer GS80 M8 System
 GOLDEN EGGS Visuals, Helsinki

AlphaServer GS80 Tru64 UNIX System, 8xCPU, 64GB

Ethernet
FDDI

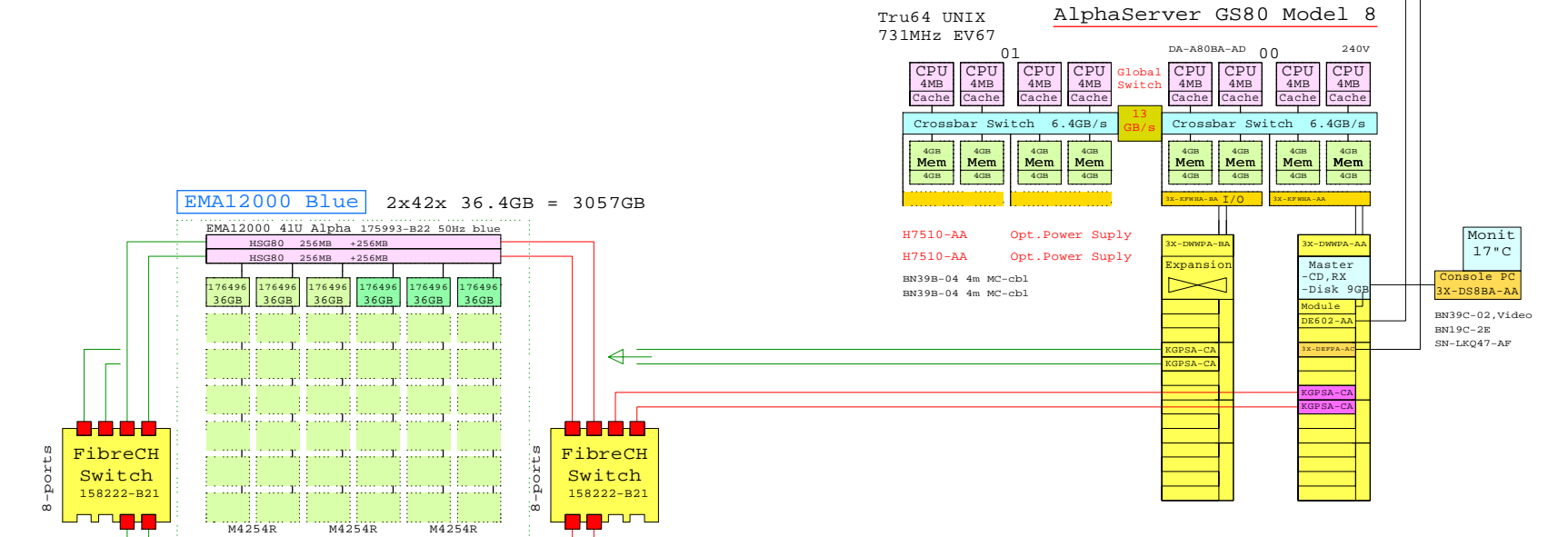

EMA12000 Blue 2x42x 36.4GB = 3057GB

EMA12000 41U Alpha 175993-B22 50Hz blue

M2200 135820-B21

Host kit:Tru64 UNIX 380553-001 Alp/UNIX

138151-B31	M4254R	138151-B31	M4254R
168256-B21	SCSI 1m	135823-B21	Cache BB
168256-B21	SCSI 1m	135823-B21	Cache BB
168256-B21	SCSI 1m	128697-B21	ACS 8.5F
168256-B21	SCSI 1m	128697-B21	ACS 8.5F
168256-B21	SCSI 1m		
135823-B21	Cache BB	128697-B21	ACS 8.5F
135823-B21	Cache BB	128697-B21	ACS 8.5F

234457-B23	O-Chbl 15m	234457-B23	O-Chbl 15m
234457-B23	O-Chbl 15m	234457-B23	O-Chbl 15m
234457-B21	O-Chbl 2m	234457-B21	O-Chbl 2m
234457-B21	O-Chbl 2m	234457-B21	O-Chbl 2m
234457-B21	O-Chbl 2m	234457-B21	O-Chbl 2m
234457-B21	O-Chbl 2m	234457-B21	O-Chbl 2m
160407-B21	2dn power	160407-B21	2dn power
167365-B21	Rack kit	167365-B21	Rack kit

BOM of this system

Part Number	Qty	Description
3R-VROP7-24	1	COMPAQ P75 CLR MON,NH,TCO99
3X-DEFFA-AC	1	PCI to FDDI SAS MMF with SC,Universal
3X-DSSBA-AA	1	PC-based system console, tower, US
3X-DWMPA-BA	1	PCI Shelf Expansion for GS160/320
3X-KFWHA-BA	1	I/O module for AS GS80, !! 2xCbl
3X-KNBAA-AB	7	CPU Module GS80 6/731MHz Tru64 UNIX
3X-MSBAA-DB	8	4GB AlphaServer GS320 Memory module
3X-MSBAA-DU	8	4GB AlphaServer GS320 Memory DIMM
128697-B21	4	ACS V8.5F controller FCAL/FCSW
135820-B21	1	Modula M2200 shelf, NO controller
135823-B21	1	HSGXX Single external cache battery
138151-B31	2	Modula M4254R dual buss, 7+7, 1.0"
158222-B21	2	SAN Switch 8 Ports
160407-B21	2	SAN switch redundant power supply
167365-B21	2	Rack mount kit for SAN switch
168256-B21	6	SCSI cable VHDCI-VHDCI, 1m
168794-B21	4	Host Buss Cntr KGPSA-CA,OVMS,UNIX
175993-B22	1	EMA12000 6x7 41U 50Hz blue
176496-B22	12	36GB 10000r Ultra3 SCSI disk 1"
176622-B21	4	HSG80 FC Contr with 256MB cache
234457-B21	8	Fibre Channel 02m Optical Cable
234457-B23	4	Fibre Channel 15m Optical Cable
380553-001	1	OS Platf,Softw,Kit for FC Alpha UNIX
380561-B21	12	FC Optical Short Wave GBIC
380674-B21	4	Cache Upgr RA8k ESA12k 256MB
BN19C-2E	1	PowerCable 240V, C-Europe
BN39B-04	2	04m copper cbl for COMAB Mem.Chan
BN39C-02	1	1.8 Video Extension Cable ****
DA-A80BA-AD	1	AS GS80 M08 for 08 CPU 240V EU UNIX
H7510-AA	2	Power Supply for AS GS80 Need: 1 or 2
SN-LKQ47-AF	1	102 KEY KYBD, NON-WIN, Finnish

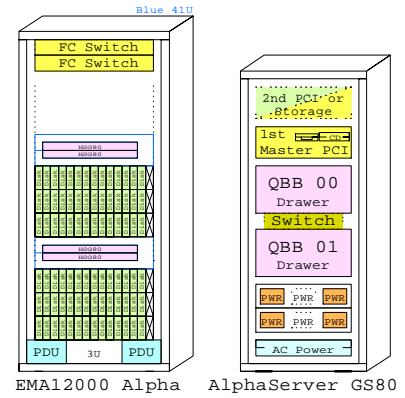

EMA12000 Alpha AlphaServer GS80

www.Compaq.com/golden-eggs
Since Sep-2000

COMPAQ	23-Feb-2001	GTAUGS803
	Matti.Patari@compaq.com	

AlphaServer GS80 UNIX System
GOLDEN EGGS Visuals, Helsinki

GS80 UNIX

Ethernet FDDI Ethernet FDDI

AlphaServer GS80 TruCluster

Tru64 UNIX 731MHz EV67

AlphaServer GS80 Model 8

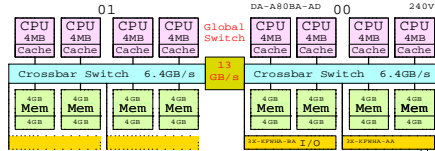

H7510-AA Opt.Power Supply
H7510-AA Opt.Power Supply

BN39B-04 4m MC-cbl
BN39B-04 4m MC-cbl

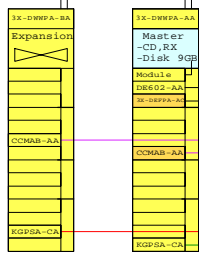

BOM of the shared Storage

Part Number	Qty	Description
138697-B21	6	ACS V8 SF controller FCAL/FCSW
13523-B21	6	HSBxx Single external cache battery
15822-B21	2	SAN Switch 8 Ports
160407-B21	2	SAN switch redundant power supply
167365-B21	2	Rack mount kit for SAN switch
175990-B22	1	EMA12000 D14 42U 50Hz opal
176496-B22	18	36GB 10000r Ultra3 SCSI disk 1"
176622-B21	6	HS800 FC Contr with 256MB cache
234457-B21	12	Fibre Channel 02m Optical Cable
234457-B23	4	Fibre Channel 15m Optical Cable
380553-001	1	OS Platf.Softw.Kit for FC Alpha UNIX
380561-B21	16	FC Optical Short Wave GBIC
380674-B21	6	Cache Upg RASK ESAL2K 256MB

EMA12000 D14 3x42x 36.4GB = 4586GB

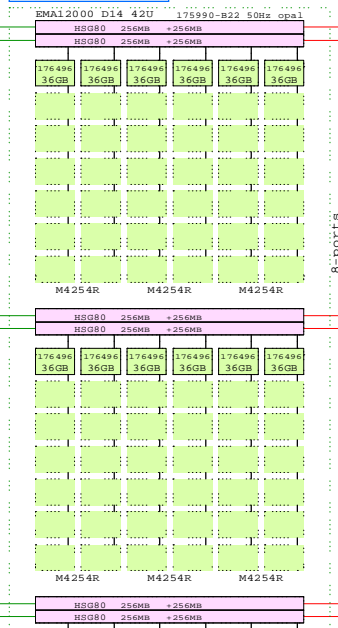

BOM of this GS80 TruCluster

Part Number	Qty	Description
1	1	175990-B22 1 EMA12000 D14 42U 50Hz opal
1.1	128697-B21	6 ACS V8 SF controller FCAL/FCSW
1.2	13523-B21	6 HSBxx Single external cache battery
1.3	176496-B22	18 36GB 10000r Ultra3 SCSI disk 1"
1.4	176622-B21	1 HS800 FC Contr with 256MB cache
1.4.1	380674-B23	1 Cache Upg RASK ESAL2K 256MB
1.5	176622-B21	1 HS800 FC Contr with 256MB cache
1.5.1	380674-B21	1 Cache Upg RASK ESAL2K 256MB
1.6	176622-B21	1 HS800 FC Contr with 256MB cache
1.6.1	380674-B21	1 Cache Upg RASK ESAL2K 256MB
1.7	176622-B21	1 HS800 FC Contr with 256MB cache
1.7.1	380674-B23	1 Cache Upg RASK ESAL2K 256MB
1.8	176622-B21	1 HS800 FC Contr with 256MB cache
1.8.1	380674-B21	1 Cache Upg RASK ESAL2K 256MB
1.9	176622-B21	1 HS800 FC Contr with 256MB cache
1.9.1	380674-B21	1 Cache Upg RASK ESAL2K 256MB
2	DA-A80BA-AD	1 AS GS80 M08 for 08 CPU 240V RU UNIX
2.1	168794-B21	1 Host Bus Cntr KGPSA-CA,OVMS,UNIX
2.2	3X-DEPPA-AC	1 PCI to FDDI SAS MMF with SC,Universal
2.3	3X-DWPA-BA	1 PCI Shelf Expansion for GS160/320
2.3.1	168794-B21	1 Host Bus Cntr KGPSA-CA,OVMS,UNIX
2.3.2	CCMAB-AA	1 PCI Mem. Channel-2 Cluster entrl
2.4	3X-KFPA-BA	1 I/O module for AS GS80 1" 2xChl
2.5	3X-KNSAA-AB	7 CPU Module GS80 6731MHz Tru64 UNIX
2.6	3X-MS8AA-DB	8 4GB AlphaServer GS320 Memory module
2.7	3X-MS8AA-DB	8 4GB AlphaServer GS320 Memory DIMM
2.8	BN39B-04	2 04m copper cbl for CCMAB Mem.Chan
2.9	CCMAB-AA	1 PCI Mem. Channel-2 Cluster entrl
2.10	H7510-AA	2 Power Supply for AS GS80 Need: 1 or 2
3	DA-A80BA-AD	1 AS GS80 M08 for 08 CPU 240V RU UNIX
3.1	168794-B21	1 Host Bus Cntr KGPSA-CA,OVMS,UNIX
3.2	3X-DEPPA-AC	1 PCI to FDDI SAS MMF with SC,Universal
3.3	3X-DWPA-BA	1 PCI Shelf Expansion for GS160/320
3.3.1	168794-B21	1 Host Bus Cntr KGPSA-CA,OVMS,UNIX
3.3.2	CCMAB-AA	1 PCI Mem. Channel-2 Cluster entrl
3.4	3X-KFPA-BA	1 I/O module for AS GS80 1" 2xChl
3.5	3X-KNSAA-AB	7 CPU Module GS80 6731MHz Tru64 UNIX
3.6	3X-MS8AA-DB	8 4GB AlphaServer GS320 Memory module
3.7	3X-MS8AA-DB	8 4GB AlphaServer GS320 Memory DIMM
3.8	BN39B-04	2 04m copper cbl for CCMAB Mem.Chan
3.9	CCMAB-AA	1 PCI Mem. Channel-2 Cluster entrl
3.10	H7510-AA	2 Power Supply for AS GS80 Need: 1 or 2
4	158222-B21	1 SAN Switch 8 Ports
4.1	380561-B21	8 FC Optical Short Wave GBIC
5	158222-B21	1 SAN Switch 8 Ports
5.1	380561-B21	8 FC Optical Short Wave GBIC
6	3R-VR0P7-24	2 COMPAQ P75 CLR MON,NH,TC099
7	3X-DS8BA-AA	2 PC-based system console, tower, US
8	160407-B21	2 SAN switch redundant power supply
9	234457-B23	4 Fibre Channel 15m Optical cable
10	167365-B21	2 Rack mount kit for SAN switch
11	234457-B21	12 Fibre Channel 02m Optical Cable
12	380553-001	1 OS Platf.Softw.Kit for FC Alpha UNIX
13	BN39B-10	2 10m copper cbl for CCMAB Mem.Chan
14	BN39C-03	2 1.8 Video Extension Cable ****
15	SN-LK047-AF	2 102 KEY KYBD,NON-WIN, Finnish
16	BN19C-2E	2 PowerCable 240V, C-Europe

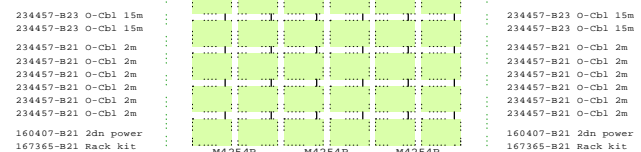

Tru64 UNIX 731MHz EV67

AlphaServer GS80 Model 8

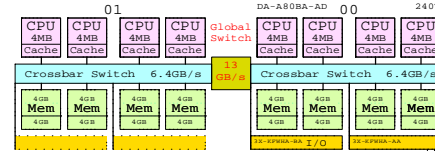

H7510-AA Opt.Power Supply
H7510-AA Opt.Power Supply

BN39B-04 4m MC-cbl
BN39B-04 4m MC-cbl

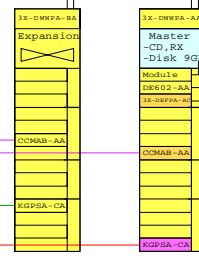

BOM of one Host

Part Number	Qty	Description
168794-B21	2	Host Bus Cntr KGPSA-CA,OVMS,UNIX
3R-VR0P7-24	2	COMPAQ P75 CLR MON,NH,TC099
3X-DEPPA-AC	1	PCI to FDDI SAS MMF with SC,Universal
3X-DSBA-AA	1	PC-based system console, tower, US
3X-DWPA-BA	1	PCI Shelf Expansion for GS160/320
3X-KFPA-BA	1	I/O module for AS GS80, 1" 2xChl
3X-KNSAA-AB	7	CPU Module GS80 6731MHz Tru64 UNIX
3X-MS8AA-DB	8	4GB AlphaServer GS320 Memory module
3X-MS8AA-DB	8	4GB AlphaServer GS320 Memory DIMM
BN19C-2E	1	PowerCable 240V, C-Europe
BN39B-04	2	04m copper cbl for CCMAB Mem.Chan
BN39C-02	1	1.8 Video Extension Cable ****
CCMAB-AA	2	PCI Mem. Channel-2 Cluster entrl
DA-A80BA-AD	1	AS GS80 M08 for 08 CPU 240V RU UNIX
H7510-AA	2	Power Supply for AS GS80 Need: 1 or 2
SN-LK047-AF	1	102 KEY KYBD,NON-WIN, Finnish

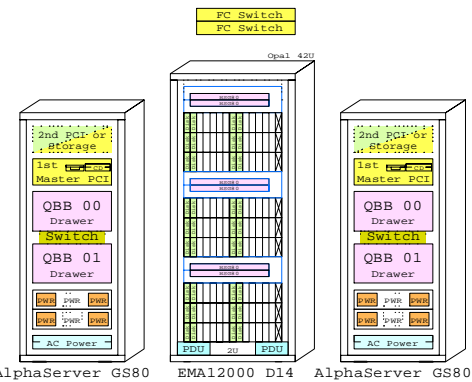

www.compaq.com/golden-eggs

COMPAQ 09-Mar-2001 GTAUGS804 Matti.Patar@compaq.com

GS80 UNIX

AlphaServer GS80 UNIX Cluster GOLDEN EGGS Visuals, Helsinki

AlphaServer GS80 OpenVMS System, 8xCPU, 64GB

Ethernet
FDDI

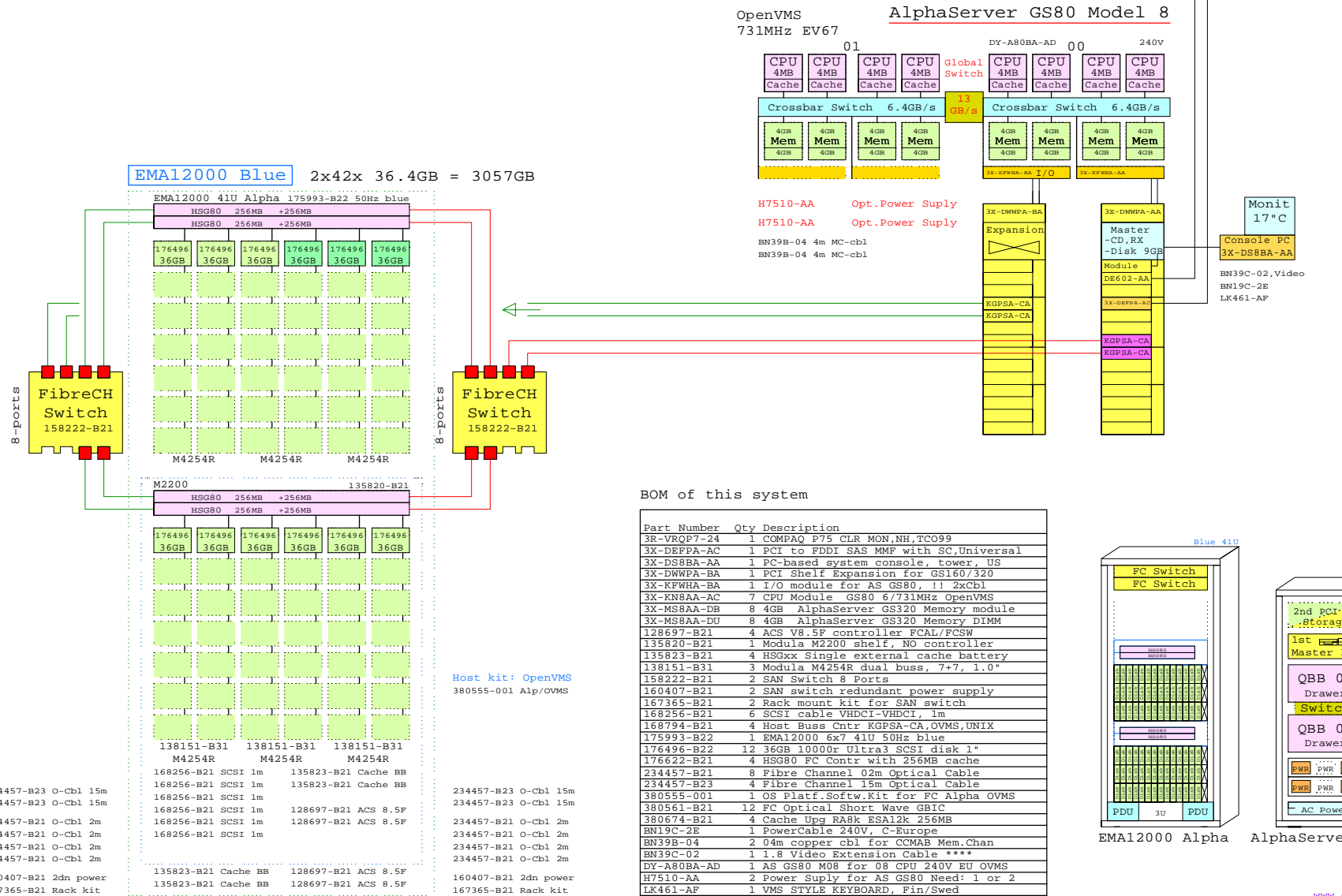

BOM of this system

Part Number	Qty	Description
3R-VROP7-24	1	COMPAQ P75 CLR MON,NH,TCO99
3X-DEFFA-AC	1	PCI to FDDI SAS MMF with SC,Universal
3X-DSSBA-AA	1	PC-based system console, tower, US
3X-DWMPA-BA	1	PCI Shelf Expansion for GS160/320
3X-KFWHA-BA	1	I/O module for AS GS80, !! 2xCbl
3X-KNBAA-AC	7	CPU Module GS80 6/731MHz OpenVMS
3X-MSBAA-DB	8	4GB AlphaServer GS320 Memory module
3X-MSBAA-DU	8	4GB AlphaServer GS320 Memory DIMM
128697-B21	4	ACS V8.5F controller FCAL/PCSW
135820-B21	1	Modula M2200 shelf, NO controller
135823-B21	4	HSGXX Single external cache battery
138151-B31	3	Modula M4254R dual buss, 7+7, 1.0"
158222-B21	2	SAN Switch 8 Ports
160407-B21	2	SAN switch redundant power supply
167365-B21	2	Rack mount kit for SAN switch
168256-B21	6	SCSI cable VHDCI-VHDCI, 1m
168794-B21	4	Host Buss Cntr KGPSA-CA,OVMS,UNIX
175993-B22	1	EMA12000 6x7 41U 50Hz blue
176496-B22	12	36GB 10000r Ultra3 SCSI disk 1"
176622-B21	4	HSG80 FC Contr with 256MB cache
234457-B21	8	Fibre Channel 02m Optical Cable
234457-B23	4	Fibre Channel 15m Optical Cable
380555-001	1	OS Platf,Softw,Kit for FC Alpha OVMS
380561-B21	12	FC Optical Short Wave GBIC
380674-B21	4	Cache Upgr RA8k ESA12k 256MB
BN19C-2E	1	PowerCable 240V, C-Europe
BN39B-04	2	04m copper cbl for COMAB Mem.Chan
BN39C-02	1	1.8 Video Extension Cable ****
DY-A80BA-AD	1	AS GS80 M08 for 08 CPU 240V EU OVMS
H7510-AA	2	Power Supply for AS GS80 Need: 1 or 2
LK461-AF	1	VMS STYLE KEYBOARD, Fin/Swed

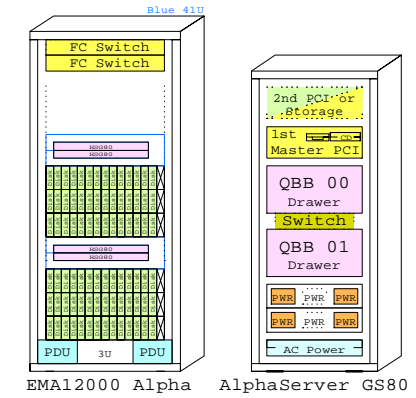

www.Compaq.com/golden-eggs
Since Sep-2000

COMPAQ	14-Sep-2000	GTAVGS803
	Matti.Patari@compaq.com	
AlphaServer GS80 OpenVMS System		
GOLDEN EGGS Visuals, Helsinki		

Ethernet
FDDI

Ethernet
FDDI

AlphaServer GS80 OpenVMS Cluster

OpenVMS
731MHz EV67

AlphaServer GS80 Model 8

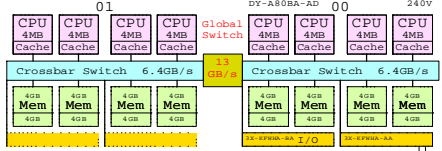

H7510-AA Opt.Power Supply
H7510-AA Opt.Power Supply
BN39B-04 4m MC-cbl
BN39B-04 4m MC-cbl

BOM of the shared Storage

Part Number	Qty	Description
128697-B21	6	ACS V8 SF controller FCAL/FCSM
135823-B21	6	HS08x Single external cache battery
158222-B21	2	SAN Switch 8 Ports
160407-B21	2	SAN switch redundant power supply
167365-B21	2	Rack mount kit for SAN switch
175990-B22	1	EMA12000 D14 42U 50Hz opal
176496-B22	18	36GB 10000r Ultra3 SCSI disk 1"
176622-B21	6	HS080 FC contr with 256MB cache
234457-B21	12	Fibre Channel 02m Optical Cable
234457-B23	4	Fibre Channel 15m Optical Cable
380555-001	1	OS Platf.Softw.Kit for FC Alpha OVMS
380561-B21	16	FC Optical Short Wave GBIC
380674-B21	6	Cache Upg RASK ESAL2K 256MB

EMA12000 D14 3x42x 36.4GB = 4586GB

EMA12000 D14 42U 175990-B22 50Hz opal

HS080 256MB +256MB

HS080 256MB +256MB

176496 36GB 176496 36GB 176496 36GB 176496 36GB 176496 36GB

HS080 256MB +256MB

HS080 256MB +256MB

176496 36GB 176496 36GB 176496 36GB 176496 36GB

HS080 256MB +256MB

HS080 256MB +256MB

176496 36GB 176496 36GB 176496 36GB 176496 36GB

HS080 256MB +256MB

HS080 256MB +256MB

176496 36GB 176496 36GB 176496 36GB 176496 36GB

HS080 256MB +256MB

HS080 256MB +256MB

176496 36GB 176496 36GB 176496 36GB 176496 36GB

HS080 256MB +256MB

HS080 256MB +256MB

176496 36GB 176496 36GB 176496 36GB 176496 36GB

HS080 256MB +256MB

HS080 256MB +256MB

176496 36GB 176496 36GB 176496 36GB 176496 36GB

HS080 256MB +256MB

HS080 256MB +256MB

176496 36GB 176496 36GB 176496 36GB 176496 36GB

HS080 256MB +256MB

HS080 256MB +256MB

176496 36GB 176496 36GB 176496 36GB 176496 36GB

HS080 256MB +256MB

HS080 256MB +256MB

176496 36GB 176496 36GB 176496 36GB 176496 36GB

HS080 256MB +256MB

HS080 256MB +256MB

176496 36GB 176496 36GB 176496 36GB 176496 36GB

HS080 256MB +256MB

HS080 256MB +256MB

176496 36GB 176496 36GB 176496 36GB 176496 36GB

HS080 256MB +256MB

HS080 256MB +256MB

176496 36GB 176496 36GB 176496 36GB 176496 36GB

HS080 256MB +256MB

HS080 256MB +256MB

176496 36GB 176496 36GB 176496 36GB 176496 36GB

HS080 256MB +256MB

HS080 256MB +256MB

OpenVMS
731MHz EV67

AlphaServer GS80 Model 8

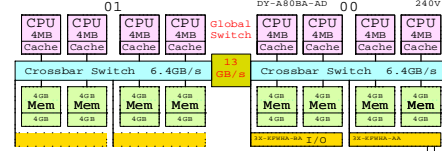

H7510-AA Opt.Power Supply
H7510-AA Opt.Power Supply
BN39B-04 4m MC-cbl
BN39B-04 4m MC-cbl

Dual Memory Channel

BOM of this GS80 OpenVMS Cluster

Part Number	Qty	Description
1	1	175990-B22 1 EMA12000 D14 42U 50Hz opal
1.1	6	ACS V8 SF controller FCAL/FCSM
1.2	6	HS08x Single external cache battery
1.3	18	36GB 10000r Ultra3 SCSI disk 1"
1.4	6	HS080 FC Contr with 256MB cache
1.4.1	1	Cache Upg RASK ESAL2K 256MB
1.5	6	HS080 FC Contr with 256MB cache
1.5.1	1	Cache Upg RASK ESAL2K 256MB
1.6	6	HS080 FC Contr with 256MB cache
1.6.1	1	Cache Upg RASK ESAL2K 256MB
1.7	6	HS080 FC Contr with 256MB cache
1.7.1	1	Cache Upg RASK ESAL2K 256MB
1.8	6	HS080 FC Contr with 256MB cache
1.8.1	1	Cache Upg RASK ESAL2K 256MB
1.9	6	HS080 FC Contr with 256MB cache
1.9.1	1	Cache Upg RASK ESAL2K 256MB
2	1	DY-A808A-AD 1 AS GS80 M08 For 08 CPU 240V EU OVMS
2.1	1	Host Bus Cntr KGPSA-CA.OVMS.UNIX
2.2	1	3X-DEPPA-AC 1 PCI to FDDI SAS MMF with SC.Universal
2.3	1	3X-DWPA-BA 1 PCI Shelf Expansion For GS160/320
2.3.1	1	Host Bus Cntr KGPSA-CA.OVMS.UNIX
2.3.2	1	CCMAB-AA 1 PCI Mem. Channel-2 Cluster cntrl
2.4	1	3X-KFWHA-BA 1 I/O module For AS GS80, 1" 2xchl
2.5	7	3X-KNSAA-AC 7 CPU Module GS80 6731MHz OpenVMS
2.6	8	3X-MS8AA-DB 8 4GB AlphaServer GS320 Memory module
2.7	8	3X-MS8AA-DU 8 4GB AlphaServer GS320 Memory DIMM
2.8	2	BN39B-04 2 04m copper cbl for CCMAB Mem.Chan
2.9	1	CCMAB-AA 1 PCI Mem. Channel-2 Cluster cntrl
2.10	2	H7510-AA 2 Power Supply For AS GS80 Need: 1 or 2
3	1	DY-A808A-AD 1 AS GS80 M08 For 08 CPU 240V EU OVMS
3.1	1	Host Bus Cntr KGPSA-CA.OVMS.UNIX
3.2	1	3X-DEPPA-AC 1 PCI to FDDI SAS MMF with SC.Universal
3.3	1	3X-DWPA-BA 1 PCI Shelf Expansion For GS160/320
3.3.1	1	Host Bus Cntr KGPSA-CA.OVMS.UNIX
3.3.2	1	CCMAB-AA 1 PCI Mem. Channel-2 Cluster cntrl
3.4	1	3X-KFWHA-BA 1 I/O module For AS GS80, 1" 2xchl
3.5	7	3X-KNSAA-AC 7 CPU Module GS80 6731MHz OpenVMS
3.6	8	3X-MS8AA-DB 8 4GB AlphaServer GS320 Memory module
3.7	8	3X-MS8AA-DU 8 4GB AlphaServer GS320 Memory DIMM
3.8	2	BN39B-04 2 04m copper cbl for CCMAB Mem.Chan
3.9	1	CCMAB-AA 1 PCI Mem. Channel-2 Cluster cntrl
3.10	2	H7510-AA 2 Power Supply For AS GS80 Need: 1 or 2
4	1	158222-B21 1 SAN Switch 8 Ports
4.1	8	380561-B21 8 FC Optical Short Wave GBIC
5	1	158222-B21 1 SAN Switch 8 Ports
5.1	8	380561-B21 8 FC Optical Short Wave GBIC
6	2	3R-VR0P7-24 2 COMPAQ P75 CLR MON.NH.TC099
7	2	3X-DS8BA-AB 2 PC-based system console, lower, Europe
8	2	160407-B21 2 SAN switch redundant power supply
9	2	234457-B23 4 Fibre Channel 15m Optical cable
10	2	167365-B21 2 Rack mount kit for SAN switch
11	12	234457-B21 12 Fibre Channel 02m Optical Cable
12	1	380555-001 1 OS Platf.Softw.Kit for FC Alpha OVMS
13	2	BN39B-10 2 10m copper cbl for CCMAB Mem.Chan
14	2	BN19C-02 2 1.8 Video Extension Cable ***
15	2	BN19C-2E 2 PowerCable 240V -Europe
16	2	LK461-AF 2 VMS STYLE KEYBOARD, Fin/Swed

This template is included in the present GOLDEN EGGS Software kit.

BOM of one Host

Part Number	Qty	Description
168794-B21	2	Host Bus Cntr KGPSA-CA.OVMS.UNIX
3R-VR0P7-24	1	COMPAQ P75 CLR MON.NH.TC099
3X-DEPPA-AC	1	PCI to FDDI SAS MMF with SC.Universal
3X-DS8BA-AB	1	PC-based system console, lower, Europe
3X-DWPA-BA	1	PCI Shelf Expansion For GS160/320
3X-KFWHA-BA	1	I/O module For AS GS80, 1" 2xchl
3X-KNSAA-AC	7	CPU Module GS80 6731MHz OpenVMS
3X-MS8AA-DB	8	4GB AlphaServer GS320 Memory module
3X-MS8AA-DU	8	4GB AlphaServer GS320 Memory DIMM
BN19C-2E	1	PowerCable 240V -C-Europe
BN39B-04	2	04m copper cbl for CCMAB Mem.Chan
BN19C-02	1	1.8 Video Extension Cable ***
CCMAB-AA	2	PCI Mem. Channel-2 Cluster cntrl
DY-A808A-AD	1	AS GS80 M08 For 08 CPU 240V EU OVMS
H7510-AA	2	Power Supply For AS GS80 Need: 1 or 2
LK461-AF	1	VMS STYLE KEYBOARD, Fin/Swed

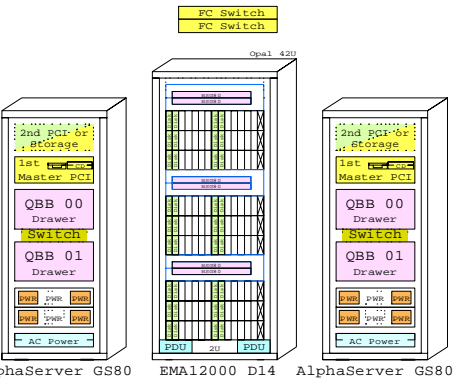

AlphaServer GS80 EMA12000 D14 AlphaServer GS80

www.compaq.com/golden-eggs

COMPAQ 09-Mar-2001 GTAVGS804
Matti.Patar@compaq.com

GS80 OVMS

AlphaServer GS80 OVMS Cluster
GOLDEN EGGS Visuals, Helsinki

Ethernet
GigaBitEthernet

AlphaServer GS80 OpenVMS system, 8xCPU, 64GB

Ethernet
GigaBitEthernet

AlphaServer GS80 OpenVMS system, 8xCPU, 64GB

OpenVMS
731MHz EV67
AlphaServer GS80 Model 8

OpenVMS
731MHz EV67
AlphaServer GS80 Model 8

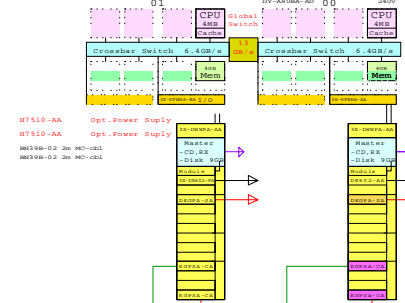
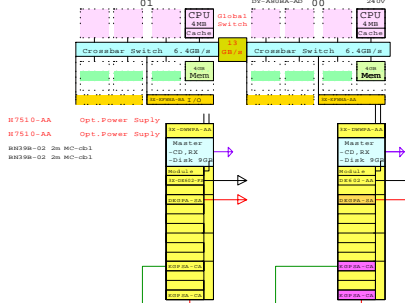

FC < 10km

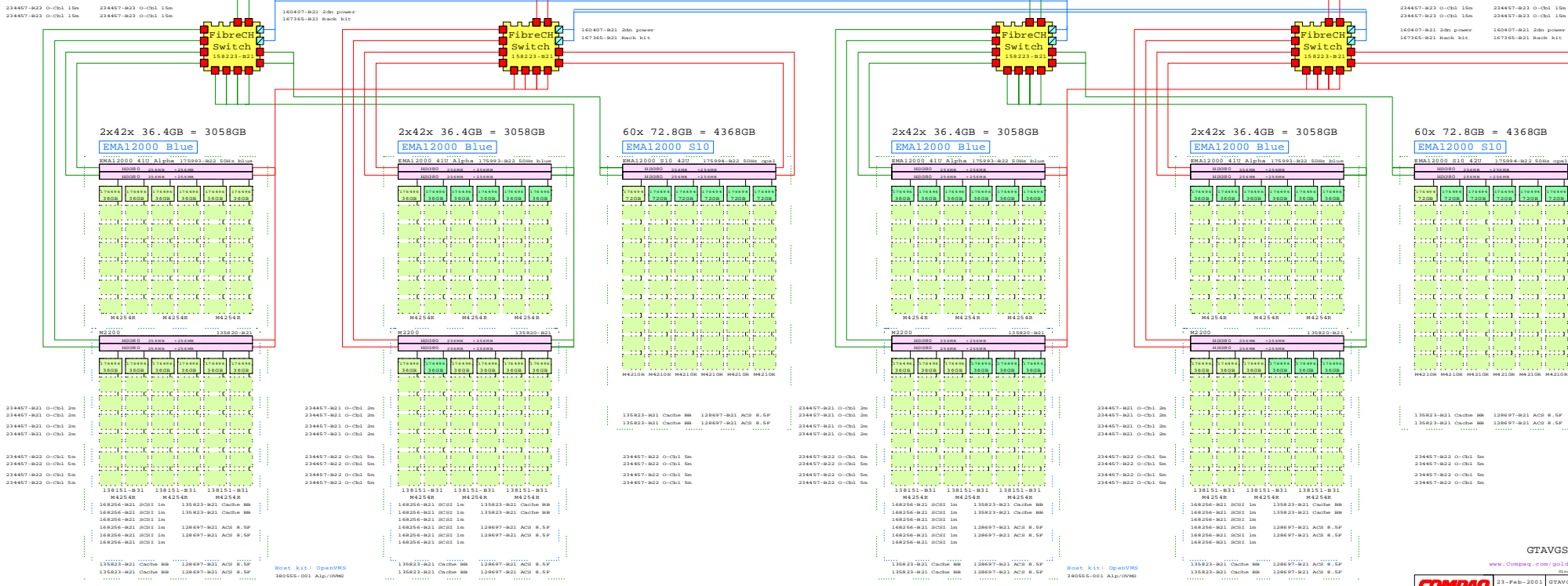

GTAVGS805

www.compaq.com/golden-eggs
 23-Feb-2001 GTAVGS805
 Matti.Patila@compaq.com

COMPAQ
 Remote FC GS80 OpenVMS Clust.
 GOLDEN EGGS Visuals, Helsinki

AlphaServer GS160 M8 and M16, 67/731 Systems

Upgrade: M8 -> M16

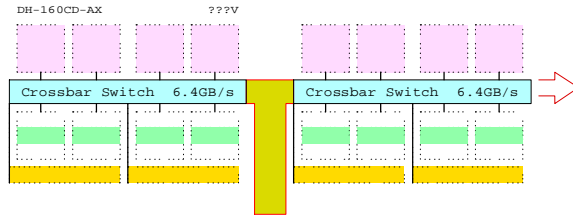

Field upgrade 02-03 QBB
DH-160CD-AX

AlphaServer GS160 Model 8

DA-160BC-AA/AB Model 8 Tru64 UNIX
DY-160BC-AA/AB Model 8 OpenVMS
208/416V

AlphaServer GS160 Model 16

DA-160CC-AA/AB Model 16 Tru64 UNIX
DY-160CC-AA/AB Model 16 OpenVMS
208/416V

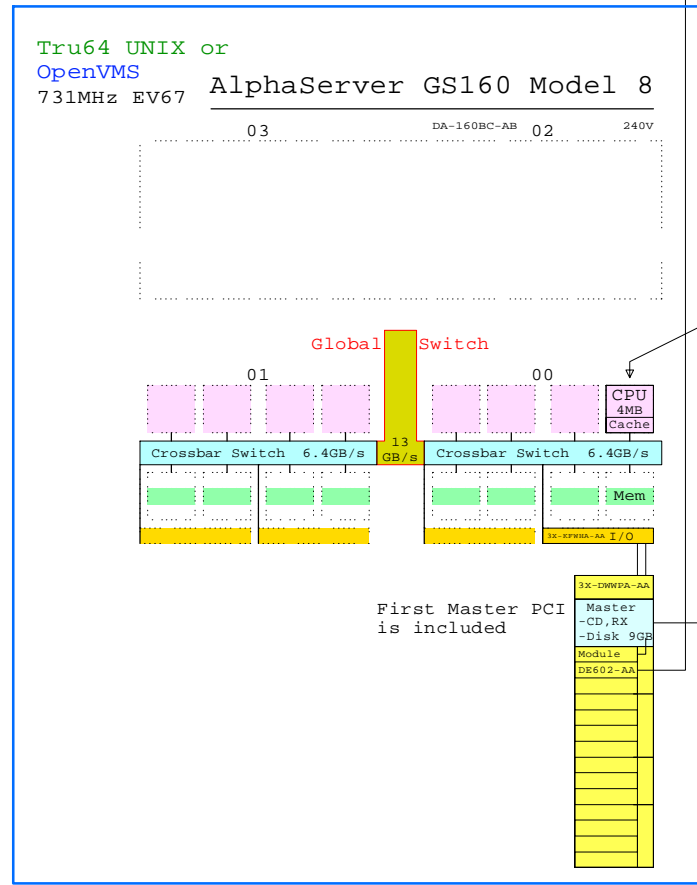

One CPU included

3X-KN8AA-AD UNIX
CPU 4MB Cache
3X-KN8AA-AE OpenVMS

Memory Upgrade
1GB Mem

3X-MS8AA-BB 1GB Module
3X-MS8AA-BU 1GB DIMM
3X-MS8AA-CB 2GB Module
3X-MS8AA-CU 2GB DIMM
3X-MS8AA-DB 4GB Module
3X-MS8AA-DU 4GB DIMM

3R-VRQP7-24 Monit 17" C
3X-DS8BA-AA/AB Console PC
3X-DS8BA-AA Hub for 2nd partition
3X-DS8AA-AA Console HUB

BN39C-02, Video
BN19C-2E
SN-LKQ47-AF

HxWxD 170x140x100cm

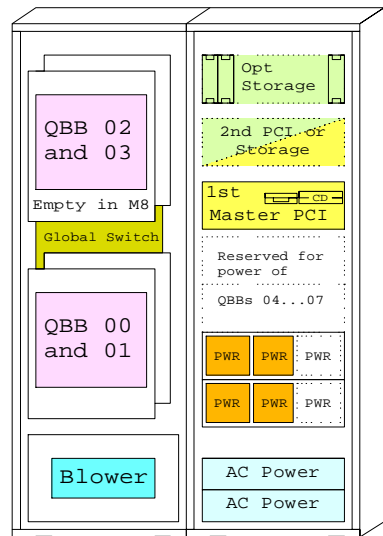

AlphaServer GS160

- ← One Storage
- ← Storage / PCI
- ← Standard PCI
- ← H7506-AA 1-2 Optional power

I/O module 3X-KFWHA-AA
Two cables BN39B-04

Optional storage shelf, 1-2

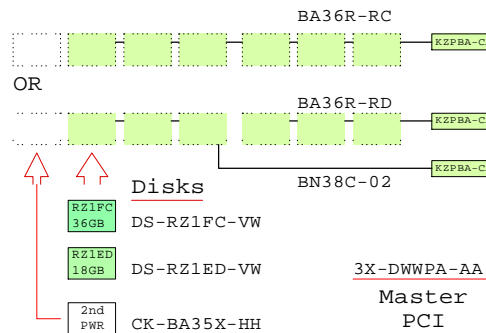

Licenses included:

- Tru64 UNIX V4.0G, Base license, Unlimited User license, Server Extension license, and Internet Solutions Software license and Netscape's Enterprise Server 3.0.
- OpenVMS V7.2-1H1 Base license and Enterprise Integration Package V3.0.

@731MHz
SPECint95 -
SPECfp95 -
SPECweb96 -
TPC -

Software Processor Code: Q

COMPAQ	23-Feb-2001	GEAGS1601
	Matti.Patari@compaq.com	

AlphaServer GS160 M16 System
GOLDEN EGGS Visuals, Helsinki

Ethernet
FDDI

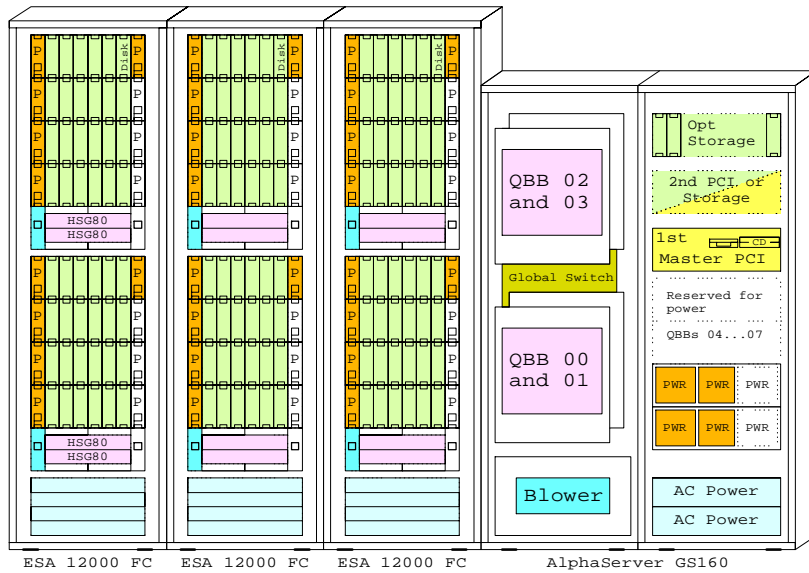

Tru64 UNIX AlphaServer GS160 Model 16
731MHz EV67

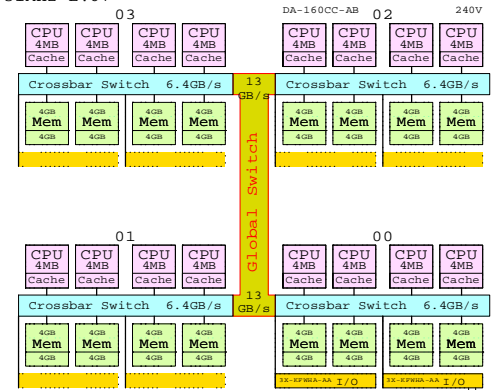

H7506-AA Opt. Power Suply
H7506-AA Opt. Power Suply
BN39B-04 4m MC-cbl
BN39B-04 4m MC-cbl

3X-DWPA-AA
Expansion
3X-DWPA-AA
Master
-CD, RX
-Disk 9Gb
Module
DE602-AA
3X-DEPPA-AA
3X-KGPSA-AA
I/O

Monit
17°C
Console PC
3X-DS8BA-AA
BN19C-02, Video
BN19C-2E
SN-LKQ47-AP

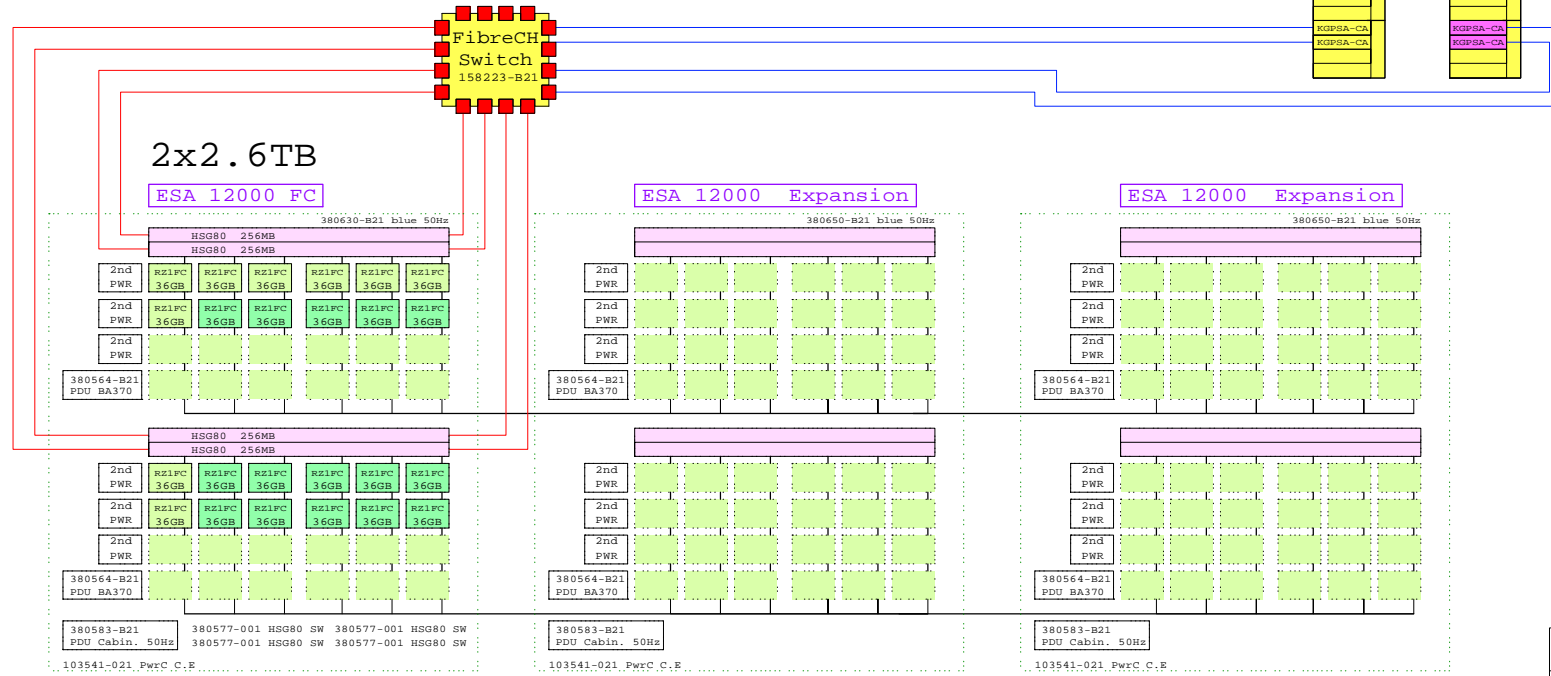

www.Compaq.com/golden-eggs
Since May-2000

COMPAQ 23-Feb-2001 GTAUGS1603
Matti.Patari@compaq.com

Ethernet
FDDI

AlphaServer GS160 Tru64 UNIX System, 16xCPU, 128GB

AlphaServer GS160 Tru64 UNIX System, 16xCPU, 128GB

Ethernet
FDDI

Tru64 UNIX AlphaServer GS160 Model 16
731MHz EV67

Tru64 UNIX AlphaServer GS160 Model 16
731MHz EV67

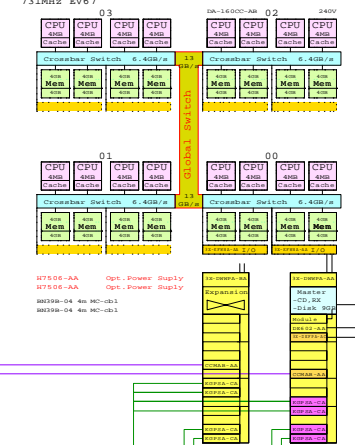
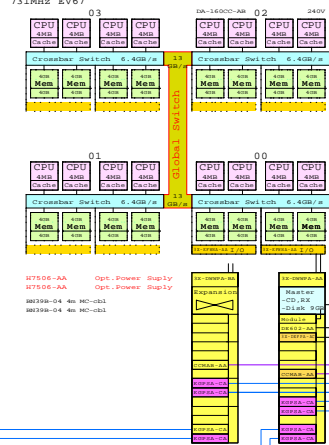

Dual Memory Channel

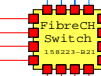

2x2.6TB
ESA 12000 FC

ESA 12000 Expansion

ESA 12000 Expansion

2x2.6TB
ESA 12000 FC

ESA 12000 Expansion

ESA 12000 Expansion

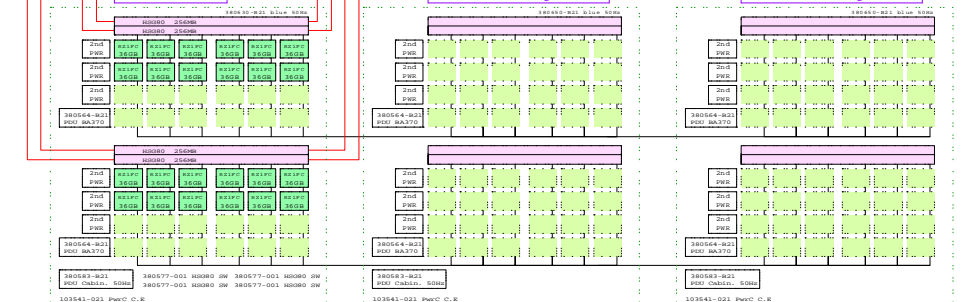
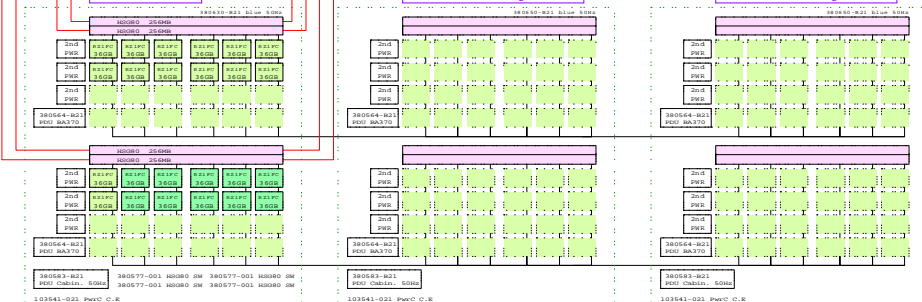

AlphaServer GS160 OpenVMS System, 16xCPU, 128GB

Ethernet
FDDI



OpenVMS AlphaServer GS160 Model 16
731MHz EV67

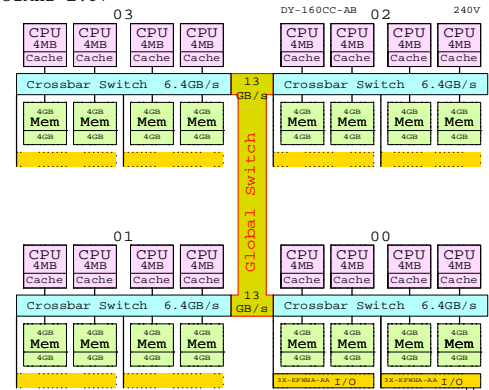

- H7506-AA Opt.Power Suply
- H7506-AA Opt.Power Suply
- BN39B-04 4m MC-cbl
- BN39B-04 4m MC-cbl
- 3X-DWPA-AA Expansion
- 3X-DWPA-AA Master -CD, RX -Disk 9Gb
- Module DE602-AA
- 3X-DEPPA-AA
- 3X-KPSA-AA I/O
- 3X-KPSA-AA
- 3X-KPSA-AA
- 3X-KPSA-AA
- Monit 17°C
- Console PC 3X-DS8BA-AA
- BN39C-02.Video
- BN19C-2E
- LK461-AA

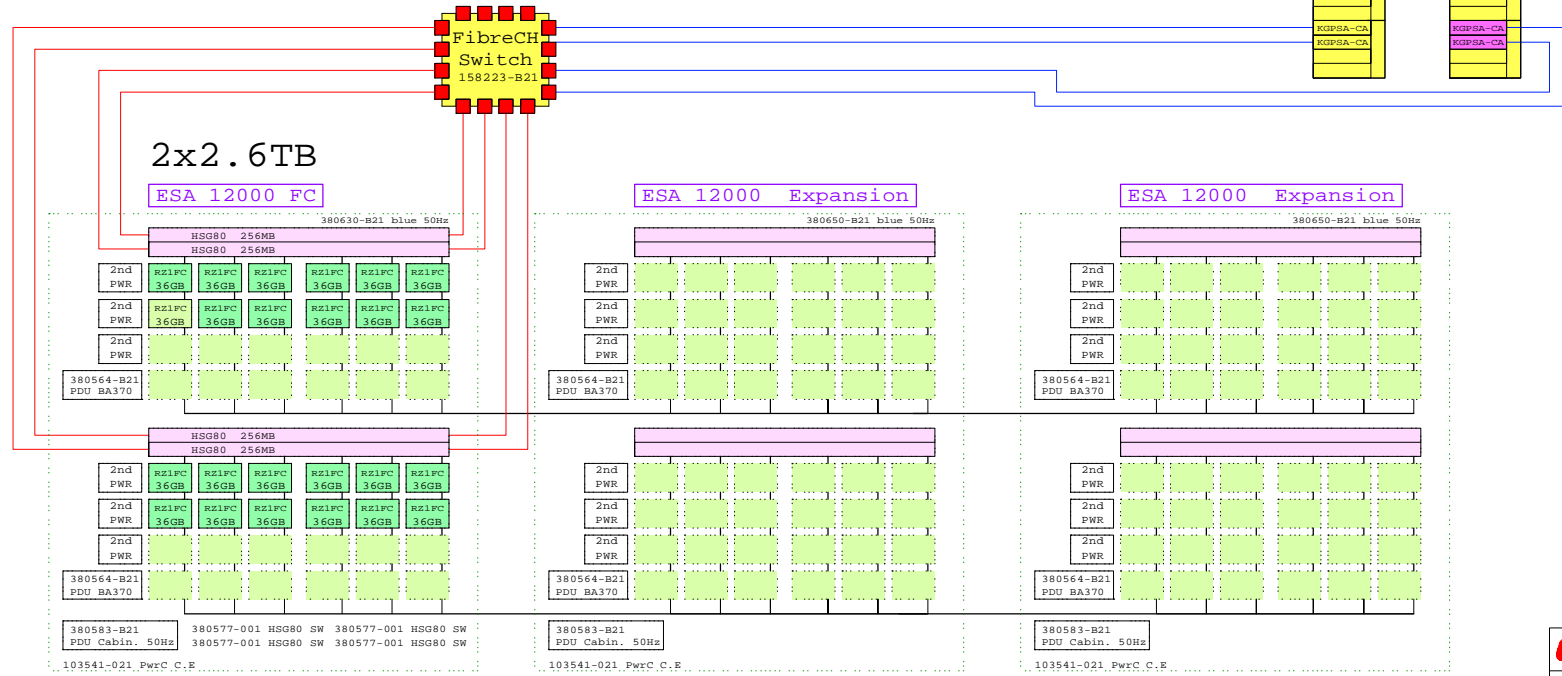

www.Compaq.com/golden-eggs
Since May-2000

COMPAQ 23-Feb-2001 GTAVGS1603
Matti.Patari@compaq.com

This template is included in the present GOLDEN EGGS Software kit.

GS160 OVMS

AlphaServer GS160 OVMS System
GOLDEN EGGS Visuals, Helsinki

AlphaServer GS160 OpenVMS Cluster

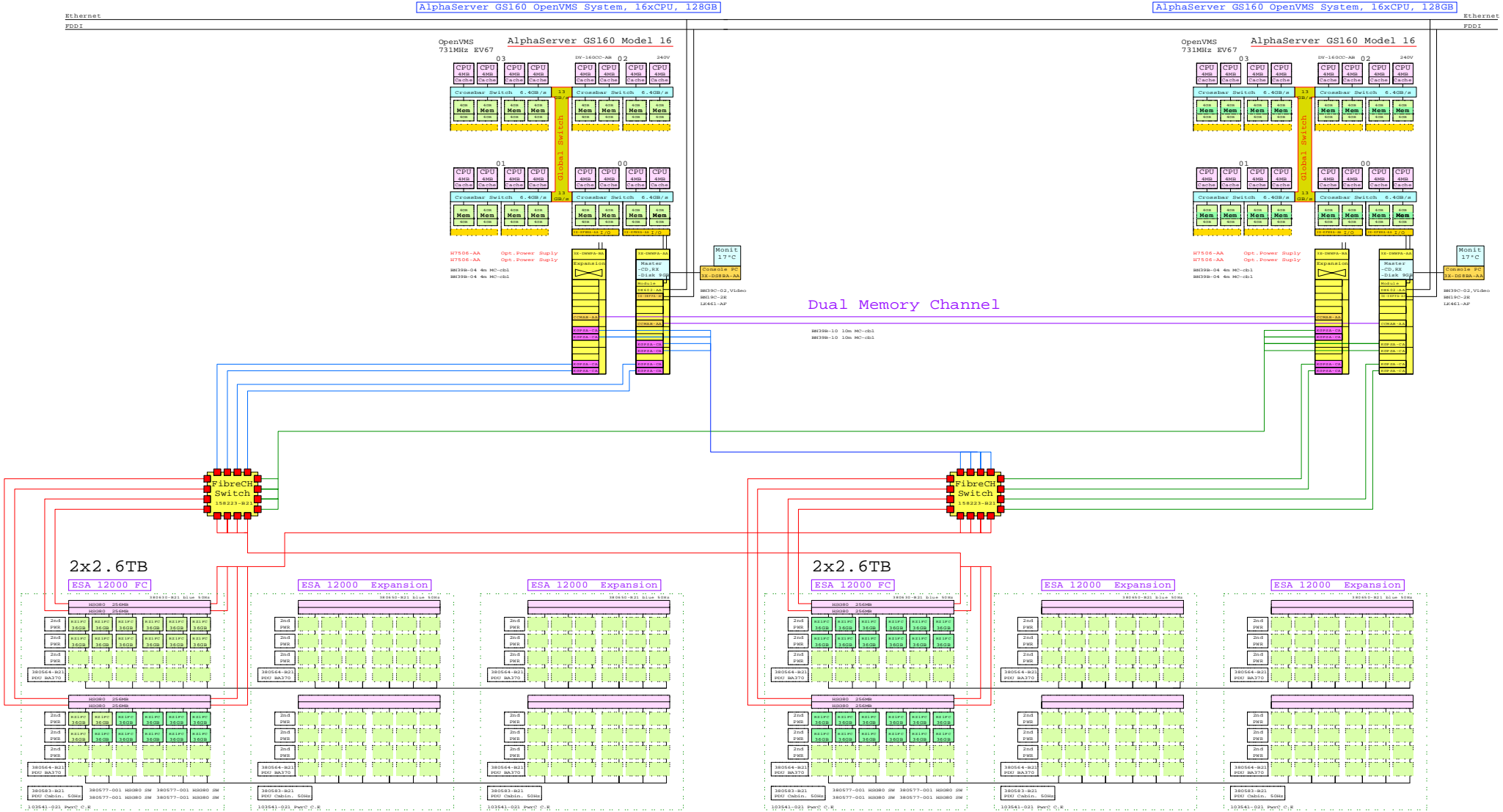

40571-001 OpenVMS

www.Compaq.com/golden-eggs
© 1999 May 2000

GTAVGS1604

30-MAR-2001 GTAVGS1604
Matti.Patarin@compaq.com

AlphaServer GS160 OVMs Cluster
GOLDEN EGGS Visuals, Helsinki

This template is included in the present GOLDEN EGGS Software kit.

GS160 OVMs

Ethernet
GigaBitEthernet

AlphaServer GS160 OpenVMS system, 16xCPU, 128GB

Ethernet
GigaBitEthernet

AlphaServer GS160 OpenVMS system, 16xCPU, 128GB

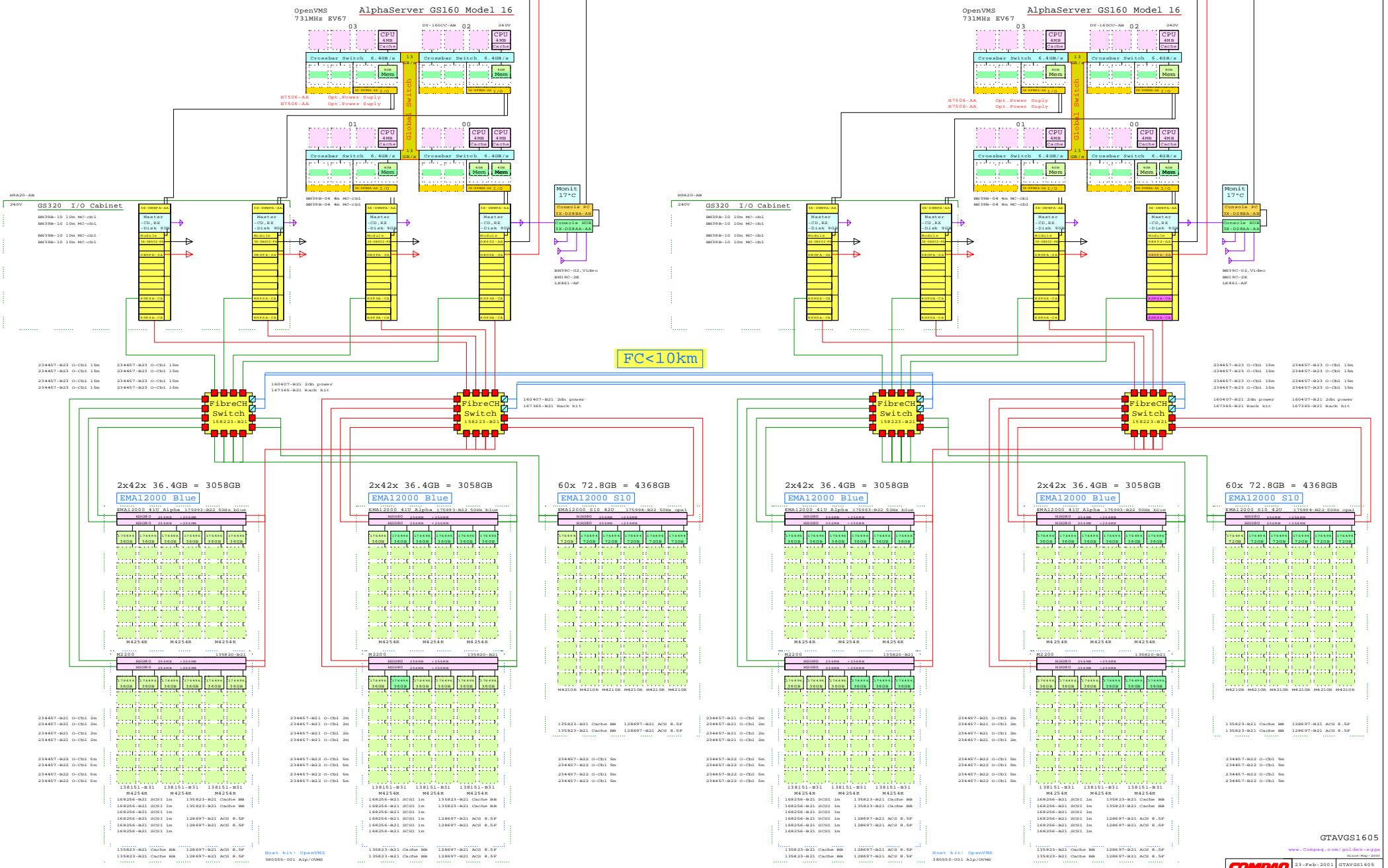

FC<10km

GTAVGS1605

COMPAQ 23-Feb-2001 STAVGS1605
Matt.Patel@compaq.com

Remote FC GS160 OpenVMS Clust.
GOLDEN EGGS Visuals, Helsinki

This template is included in the present GOLDEN EGGS Software kit.

GS160 ovms

AlphaServer GS320 M24 and M32, 67/731 Systems

Upgrade: M24 -> M32

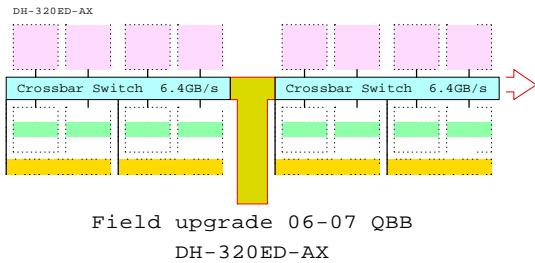

AlphaServer GS320 Model 24

DA-320DC-AA/AB Model 24 Tru64 UNIX
DY-320DC-AA/AB Model 24 OpenVMS
208/416V

AlphaServer GS320 Model 32

DA-320EC-AA/AB Model 32 Tru64 UNIX
DY-320EC-AA/AB Model 32 OpenVMS
208/416V

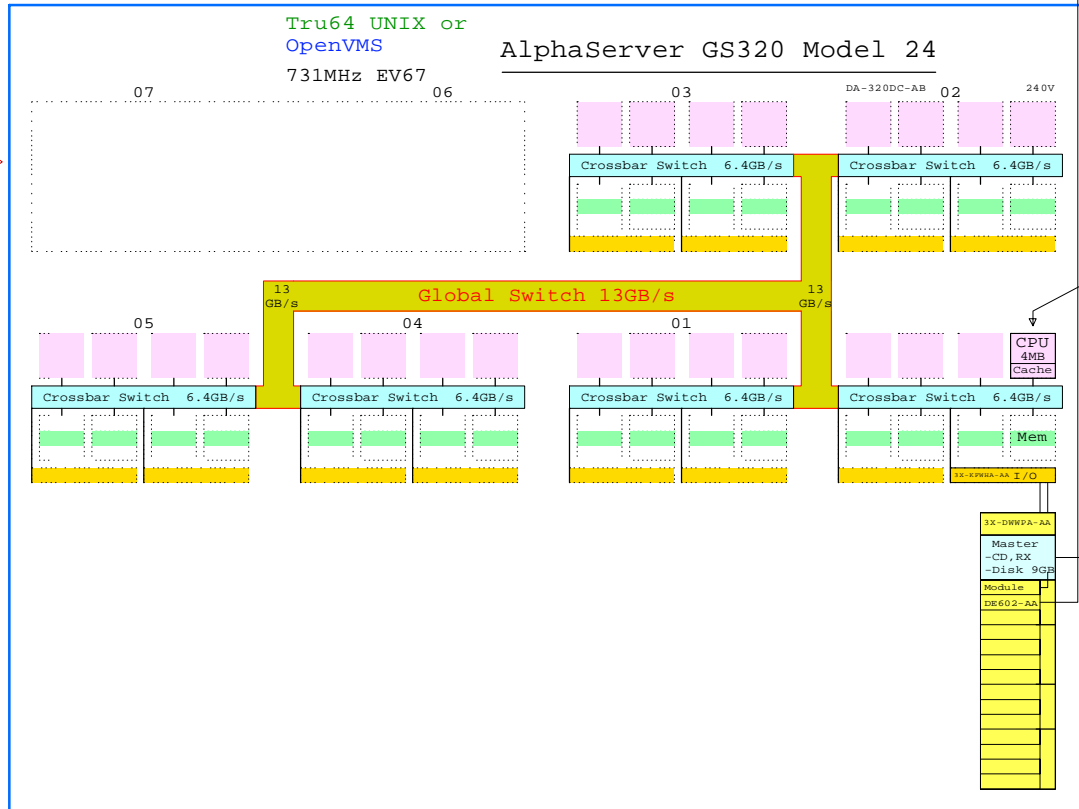

One CPU included

3X-KN8AA-AD
CPU UNIX
CPU 4MB Cache
3X-KN8AA-AE
OpenVMS

Memory Upgrade
1GB Mem

3X-MS8AA-BB 1GB Module
3X-MS8AA-BU 1GB DIMM
3X-MS8AA-CB 2GB Module
3X-MS8AA-CU 2GB DIMM
3X-MS8AA-DB 4GB Module
3X-MS8AA-DU 4GB DIMM

Monit 17°C
3R-VRQP7-24
Console PC 3X-DS8BA-AA
Console HUB 3X-DS8AA-AA
Hub for 2nd partition

BN39C-02.Video
BN19C-2E
SN-LKQ47-AF

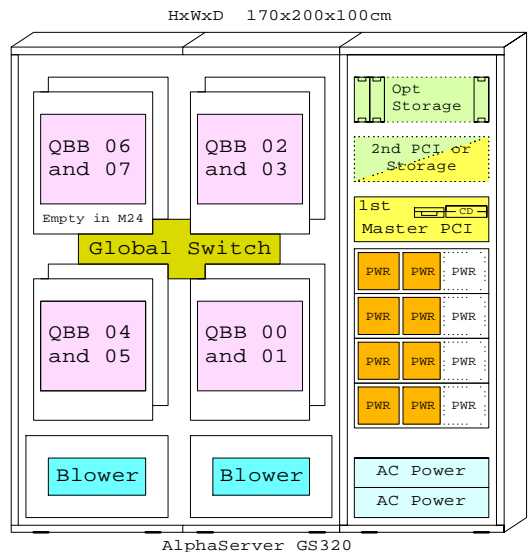

One Storage
Storage / PCI
Standard PCI
H7506-AA 1-4
Optional power

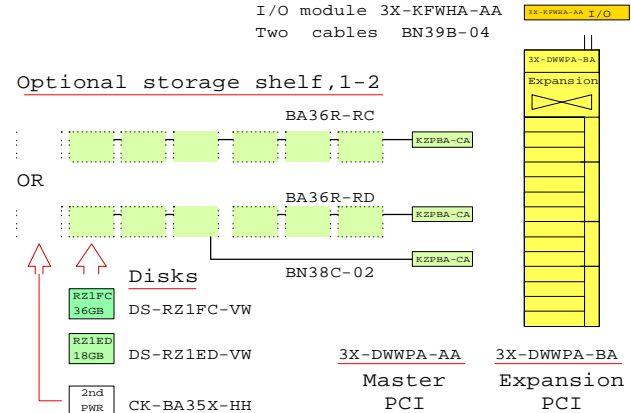

Licenses included:

- Tru64 UNIX V4.0G, Base license, Unlimited User license, Server Extension license, and Internet Solutions Software license and Netscape's Enterprise Server 3.0.
- OpenVMS V7.2-1H1 Base license and Enterprise Integration Package V3.0.

@731MHz
SPECint95 -
SPECfp95 -
SPECweb96 -
TPC -

Software Processor Code: Q

COMPAQ 23-Feb-2001 GEAGS3201
Matti.Patari@compaq.com

AlphaServer GS320 M32 System
GOLDEN EGGS Visuals, Helsinki

BOM of this Storage

Part Number	Qty	Description
128697-B21	6	ACS V8.5F controller FCAL/FCSW
135823-B21	6	HSG8x Single external cache Battery
158222-B21	2	SAN Switch 8 Ports
160407-B21	2	SAN switch redundant power supply
167365-B21	2	Rack mount kit for SAN switch
175990-B22	1	EMA12000 D14 42U 50Hz opal
176496-B22	18	36GB 10000r Ultra3 SCSI disk 1"
176622-B21	6	HSG80 FC Contr with 256MB cache
234457-B21	12	Fibre Channel 02m Optical Cable
234457-B23	4	Fibre Channel 15m Optical Cable
380553-001	1	OS Platf.Softw.Kit for FC Alpha UNIX
380561-B21	16	FC Optical Short Wave GBIC
380674-B21	6	Cache Upg RABK ESA12K 256MB

Ethernet
FDDI

AlphaServer GS320 Tru64 UNIX System, 32xCPU, 256GB

Tru64 UNIX AlphaServer GS320 Model 32
731MHz EV67

EMA12000 D14 3x42x 36.4GB = 4586GB

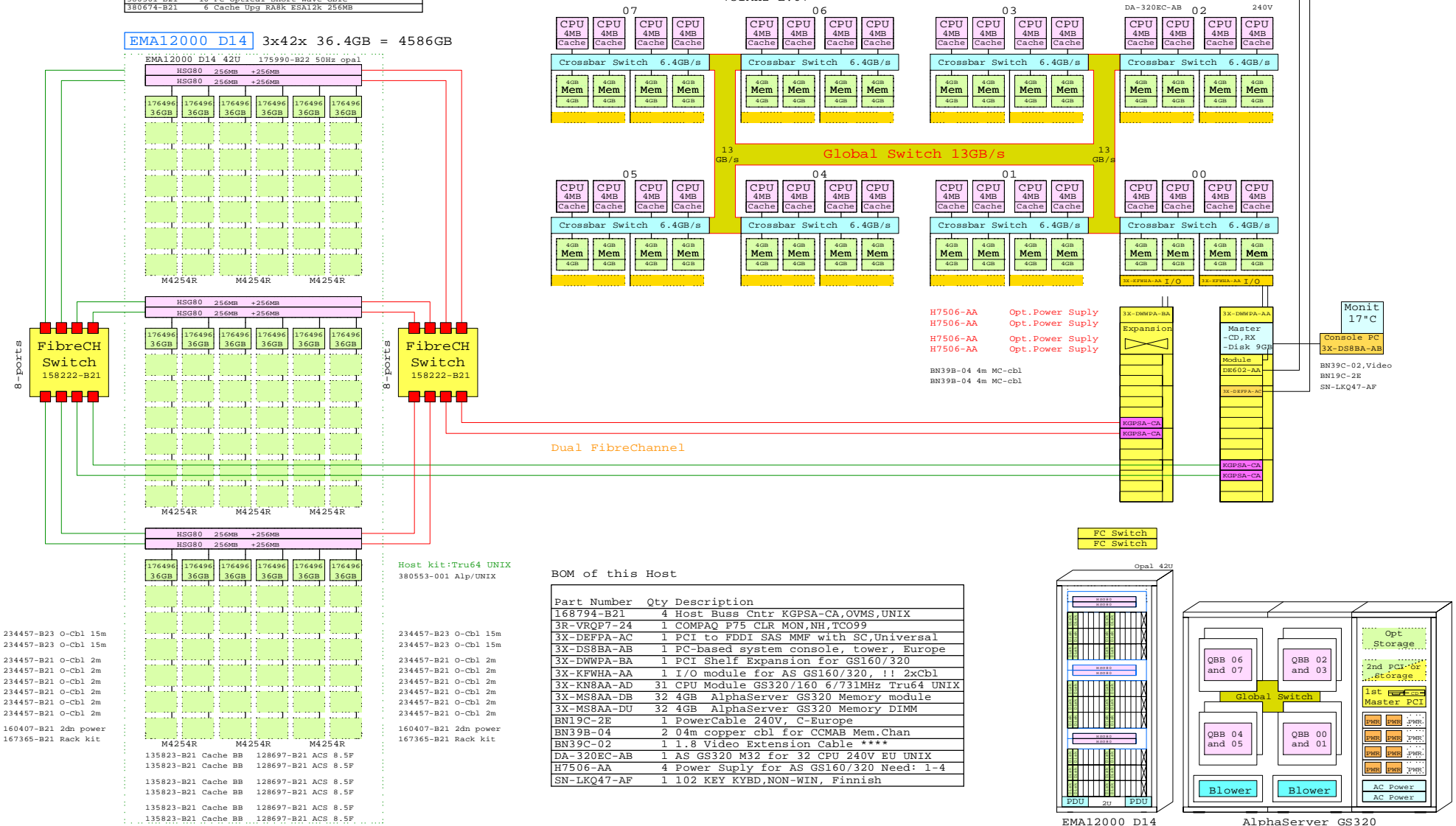

BOM of this Host

Part Number	Qty	Description
168794-B21	4	Host Buss Cntr KGP5A-CA, OVMS, UNIX
3R-VRQP7-24	1	COMPAQ P75 CLR MON, NH, FC099
3X-DFEPA-AC	1	PCI to FDDI SAS MMF with SC, Universal
3X-DS8BA-AB	1	PC-based system console, tower, Europe
3X-DWHPA-BA	1	PCI Shelf Expansion for GS160/320
3X-KFWHA-AA	1	I/O module for AS GS160/320, 1! 2xCbl
3X-KN8AA-AD	31	CPU Module GS320/160 6/731MHz Tru64 UNIX
3X-MS8AA-DB	32	4GB AlphaServer GS320 Memory module
3X-MS8AA-DU	32	4GB AlphaServer GS320 Memory DIMM
BN19C-2E	1	PowerCable 240V, C-Europe
BN39B-04	2	04m copper cbl for CCMAB Mem.Chan
BN39C-02	1	1.8 Video Extension Cable ****
DA-320EC-AB	1	AS GS320 M32 for 32 CPU 240V EU UNIX
H7506-AA	4	Power Supply for AS GS160/320 Need: 1-4
SN-LKQ47-AF	1	1 02 KEY KYBD, NON-WIN, Finnish

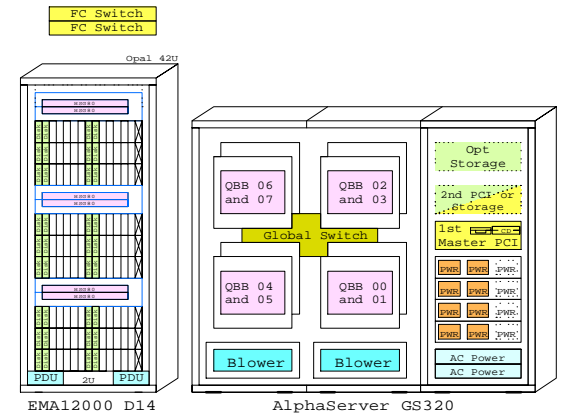

234457-B23 O-Cbl 15m
234457-B23 O-Cbl 15m
234457-B21 O-Cbl 2m
234457-B21 O-Cbl 2m
234457-B21 O-Cbl 2m
234457-B21 O-Cbl 2m
234457-B21 O-Cbl 2m
234457-B21 O-Cbl 2m
160407-B21 2dn power
167365-B21 Rack kit

M4254R M4254R M4254R
135823-B21 Cache BB 128697-B21 ACS 8.5F
135823-B21 Cache BB 128697-B21 ACS 8.5F
135823-B21 Cache BB 128697-B21 ACS 8.5F
135823-B21 Cache BB 128697-B21 ACS 8.5F
135823-B21 Cache BB 128697-B21 ACS 8.5F
135823-B21 Cache BB 128697-B21 ACS 8.5F

Host kit:Tru64 UNIX
380553-001 Alp/UNIX

234457-B23 O-Cbl 15m
234457-B23 O-Cbl 15m
234457-B21 O-Cbl 2m
234457-B21 O-Cbl 2m
234457-B21 O-Cbl 2m
234457-B21 O-Cbl 2m
234457-B21 O-Cbl 2m
234457-B21 O-Cbl 2m
160407-B21 2dn power
167365-B21 Rack kit

AlphaServer GS320 TruCluster

AlphaServer GS320 Tru64 UNIX System, 32xCPU, 256GB

AlphaServer GS320 Tru64 UNIX System, 32xCPU, 256GB

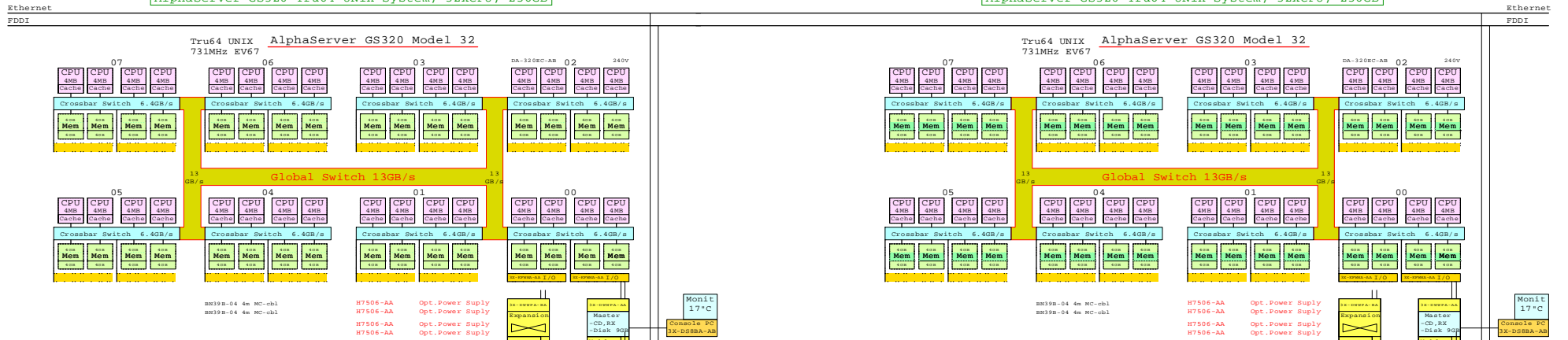

BOM of one GS320 Host

Part Number	Qty	Description
15374-R21	2	Host Base Unit (HUB) DA-320EC-AB
18-VGGP7-24	1	COMPAQ 275 High Mod. NB Tru64
1X-D8RPA-AC	1	PCI to PDDI - 8AP MMF with SC Unbuffered
1X-D8RPA-AB	1	PCI based system console - 16vms - 8AP MMF
1X-D8RPA-BA	1	PCI Shell Expansion for GS320/320
1X-D8RPA-AA	1	I/O module for AS GS320/320 (11 Jacks)
1X-D8RPA-AD	1	CPU Module GS320/320 5731MHz Tru64 UNIX
1X-D8RPA-AB	12	4GB AlphaServer GS320 Memory Module
1X-D8RPA-DU	12	4GB AlphaServer GS320 Memory DIMM
BN19C-2E	1	Powerable 17°C console PC
BN19B-04	2	4A copper cbl for COMMA Mem Chan
BN19C-02	1	18 Video Extension Cable ***
COMMA-2A	2	PCI Mem Channel-2 Cluster ext
DA-320EC-AB	1	AS GS320 HUB for 32 CPU 240V NB UPS
H7506-AA	4	Power Supply for AS GS320/320 Stand-4
BN-18Q47-AP	1	102 KEY KVBD-NON-MEM Finnish

Dual Memory Channel

FibreChannel

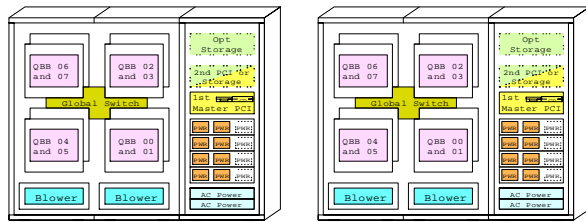

AlphaServer GS320

AlphaServer GS320

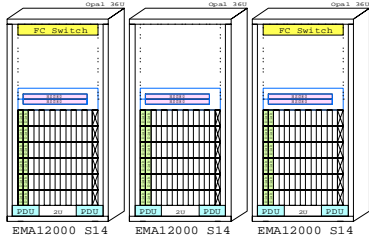

BOM of the shared Storage

Part Number	Qty	Description
13807-R21	6	AS 16.6 GB non-volatile RAM/FCMB
13823-R21	6	8GBx3 Single external cache battery
15070-R21	2	2A8 16A100 16 pins
15070-R21	2	2A8 16A100 redundant power supply
15715-R21	2	2 Rack-mount kit for SAN switch
17571-R21	3	EMA12000 S14 300 300mm opt
17572-R21	18	16GB 10000 Ultra3 SCSI disk 3"
17622-R21	6	6GB FC Controller with 2GB cache
23457-R21	12	Fibre Channel 02m Optical Cable
23457-R21	4	Fibre Channel 10m Optical Cable
18053-001	1	OS Plat softw kit for FC Alpha UNIX
18053-R21	18	FC Optical Fibre Mem Cable
18074-R21	2	Cache Upg BAKS EMA12K 256MB

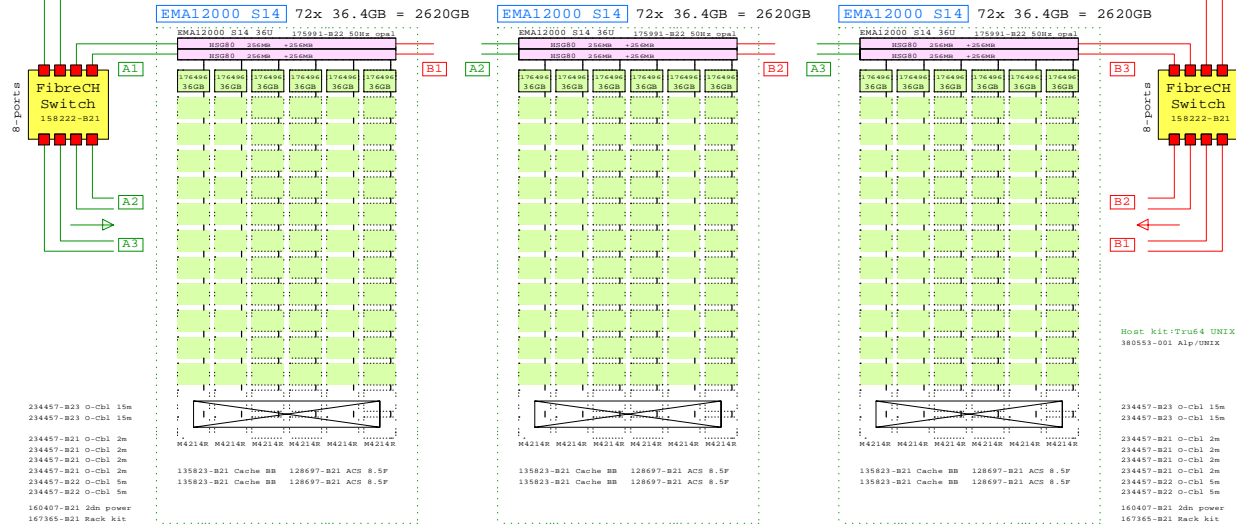

Host kit / Tru64 UNIX
380553-001 Alpmix

www.Compaq.com/golden-eggs

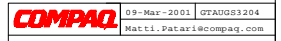

AlphaServer GS320 UNIX Cluster
GOLDEN EGGS Visuals, Helsinki

BOM of this Storage

Part Number	Qty	Description
128697-B21	6	ACS V8.5F controller FCAL/FCSW
135823-B21	6	HSG8x Single external cache Battery
158222-B21	2	SAN Switch 8 Ports
160407-B21	2	SAN switch redundant power supply
167365-B21	2	Rack mount kit for SAN switch
175990-B22	1	EMA12000 D14 42U 50Hz opal
176496-B22	18	36GB 10000r Ultra3 SCSI disk 1"
176622-B21	6	HSG80 FC Contr with 256MB cache
234457-B21	12	Fibre Channel 02m Optical Cable
234457-B23	4	Fibre Channel 15m Optical Cable
380555-001	1	OS Platf.Softw.Kit for FC Alpha OVMS
380561-B21	16	FC Optical Short Wave GBIC
380674-B21	6	Cache Upg RABK ESA12K 256MB

AlphaServer GS320 OpenVMS System, 32xCPU, 256GB

Ethernet
FDDI

OpenVMS AlphaServer GS320 Model 32
731MHz EV67

EMA12000 D14 3x42x 36.4GB = 4586GB

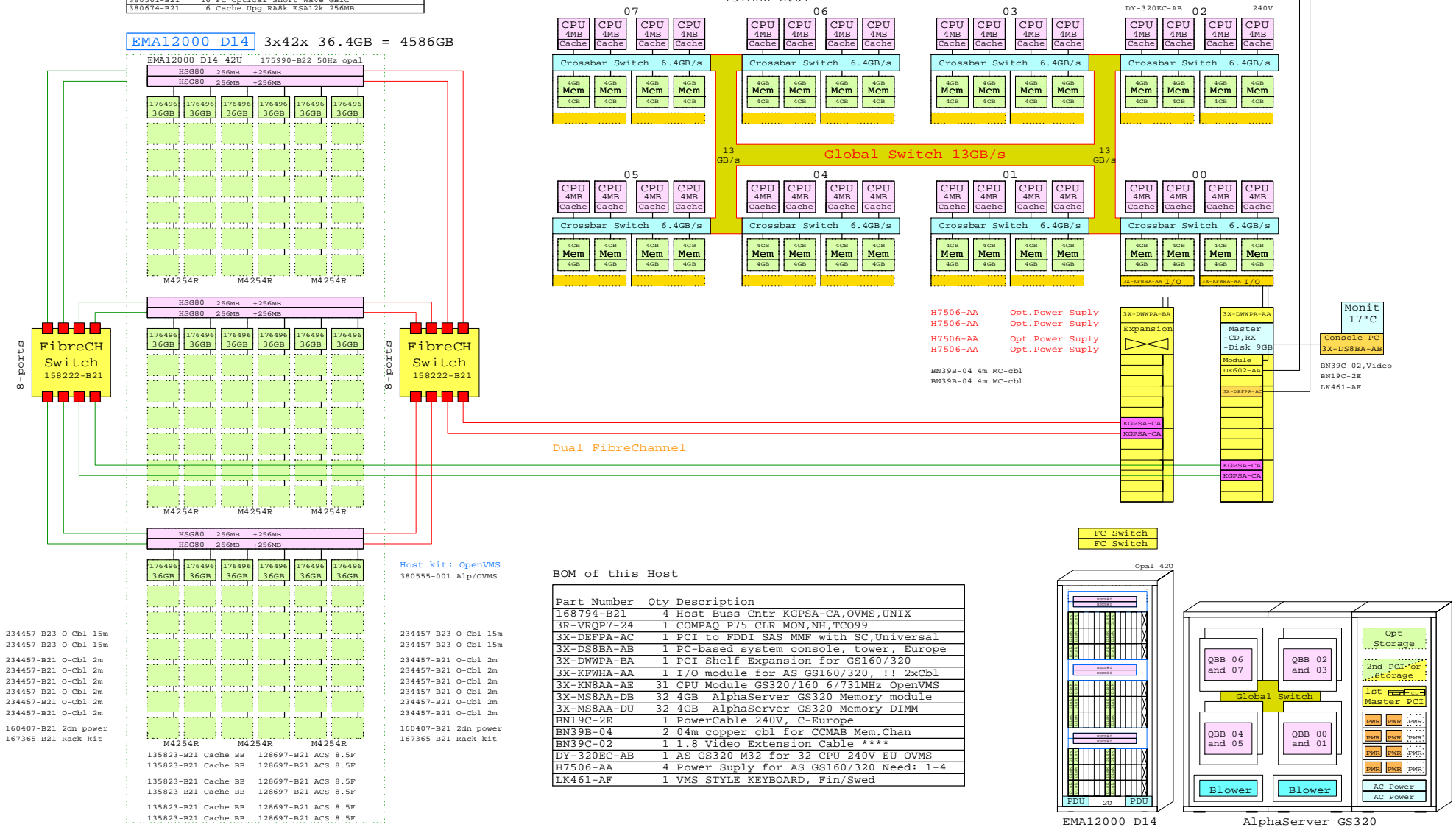

BOM of this Host

Part Number	Qty	Description
168794-B21	4	Host Buss Cntr KGPSA-CA, OVMS, UNIX
3R-VRQP7-24	1	COMPAQ P75 CLR MON, NH, FC099
3X-DFPPA-AC	1	PCI to FDDI SAS MMF with SC, Universal
3X-DS8BA-AB	1	PC-based system console, tower, Europe
3X-DWHPA-BA	1	PCI Shelf Expansion for GS160/320
3X-KFWHA-AA	1	I/O module for AS GS160/320, !: 2xCbl
3X-KN8AA-AE	31	CPU Module GS320/160 6/731MHz OpenVMS
3X-MS8AA-DB	32	4GB AlphaServer GS320 Memory module
3X-MS8AA-DU	32	4GB AlphaServer GS320 Memory DIMM
BN19C-2E	1	PowerCable 240V, C-Europe
BN39B-04	2	04m copper cbl for CCMAB Mem.Chan
BN39C-02	1	1.8 Video Extension Cable ****
DY-320EC-AB	1	AS GS320 M32 for 32 CPU 240V EU OVMS
H7506-AA	4	Power Supply for AS GS160/320 Need: 1-4
LK461-AF	1	VMS STYLE KEYBOARD, Fin/Swed

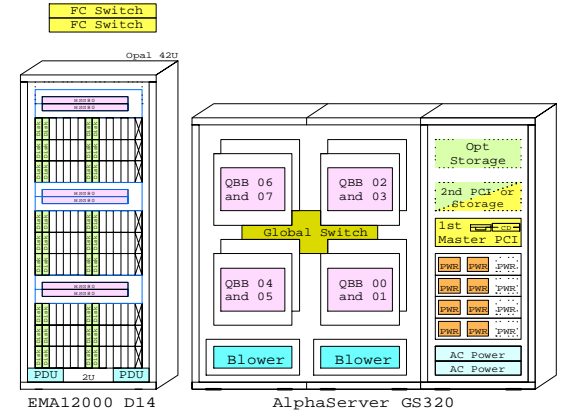

234457-B23	O-Cbl	15m	234457-B23	O-Cbl	15m
234457-B23	O-Cbl	15m	234457-B21	O-Cbl	2m
234457-B21	O-Cbl	2m	234457-B21	O-Cbl	2m
234457-B21	O-Cbl	2m	234457-B21	O-Cbl	2m
234457-B21	O-Cbl	2m	234457-B21	O-Cbl	2m
234457-B21	O-Cbl	2m	234457-B21	O-Cbl	2m
234457-B21	O-Cbl	2m	234457-B21	O-Cbl	2m
160407-B21	2dn	power	160407-B21	2dn	power
167365-B21	Rack	kit	167365-B21	Rack	kit
M4254R	M4254R	M4254R	135823-B21	Cache	BB
135823-B21	Cache	BB	128697-B21	ACS	8.5F
135823-B21	Cache	BB	128697-B21	ACS	8.5F
135823-B21	Cache	BB	128697-B21	ACS	8.5F
135823-B21	Cache	BB	128697-B21	ACS	8.5F
135823-B21	Cache	BB	128697-B21	ACS	8.5F
135823-B21	Cache	BB	128697-B21	ACS	8.5F
135823-B21	Cache	BB	128697-B21	ACS	8.5F

www.Compaq.com/golden-eggs

COMPAQ 23-Feb-2001 GTAVGS3203
Matti.Patari@compaq.com

GS320 OVMS

AlphaServer GS320 OVMS System
GOLDEN EGGS Visuals, Helsinki

This template is included in the present GOLDEN EGGS Software kit.

AlphaServer GS320 OpenVMS Cluster

AlphaServer GS320 OpenVMS System, 32xCPU, 256GB

AlphaServer GS320 OpenVMS System, 32xCPU, 256GB

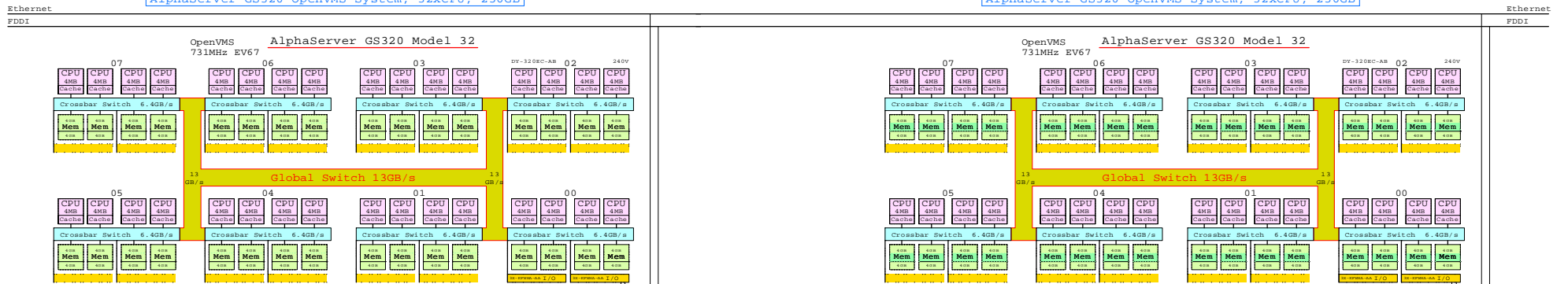

BOM of one GS320 Host

Part Number	Qty	Description
18874-031	2	Host Base Unit RGS2A-CA OVMS UNIX
18-VDD7-24	1	COMPAQ P75 CPU MOD. 70000
1X-DRRA-AC	1	PCI slot board, 160 MB with 80 Universal
1X-DRRA-AB	1	PC-based system console tower, Europe
1X-DRRA-AA	1	PCI slot expansion for 100 50/320
1X-RPWA-AA	1	170 module (eg. AS G610/320 /1 Zacht)
1X-MBAA-AA	31	256 Module GS320 4MB / 32MB OpenVMS
1X-MBAA-AB	12	4MB AlphaServer GS320 Memory module
1X-MBAA-AD	32	4MB AlphaServer GS320 Memory DIMM
1X-DC-AS	1	PowerCable 240V, 0-2000W
1X178-04	2	04m copper cbl for COMPA Mem Chan
1X178-10	1	10m copper cbl for COMPA Mem Chan
1X193C-02	1	1.8 Video Extension Cable ***
1XMSA-AA	2	PCI Mem Channel 2 Cluster (opt)
DV-320C-AB	1	AS GS320 H12 for 32 CPU 240V EU OVMS
1X150-AB	1	Power supply for AS GS320 H12 Model 1.4
1X441-AP	1	VMS SVTLE KEYBOARD, Fin/Swed

H7506-AA Opt.Power Supply
 H7506-AA Opt.Power Supply
 H7506-AA Opt.Power Supply
 H7506-AA Opt.Power Supply

H7506-AA Opt.Power Supply
 H7506-AA Opt.Power Supply
 H7506-AA Opt.Power Supply
 H7506-AA Opt.Power Supply

Dual Memory Channel

FibreChannel

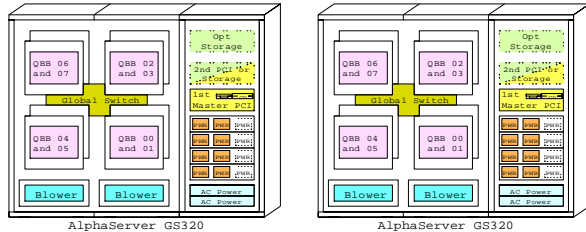

AlphaServer GS320 AlphaServer GS320

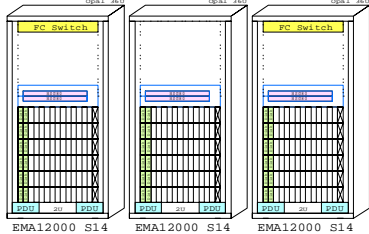

EMA12000 S14 EMA12000 S14 EMA12000 S14

BOM of the shared Storage

Part Number	Qty	Description
13807-021	4	4GB 16K SR nonvolatile RAM PC/CM
13823-021	4	CR024 Single external cache battery
13822-021	2	2 24V 10AH 8.5 amp
13040-021	4	8AN switch redundant power supply
13755-021	2	2 Rack mount kit for SAN switch
17591-021	6	EMA12000 S14 360 9000 opt
17498-021	18	18 36GB 10000 Ultra3 SCSI disk 3"
17622-021	6	6 600MB PC Cache with 256KB cache
234457-021	12	12 Fibre Channel 02m Optical Cable
234457-021	6	6 Fibre Channel 10m Optical Cable
18055-001	1	08 Plat softw kit for PC Alpha OVMS
18051-021	18	18 PC Optical Fibre Mem QCIC
18074-021	2	2 Cache Upg BARK EMA12K-256MB

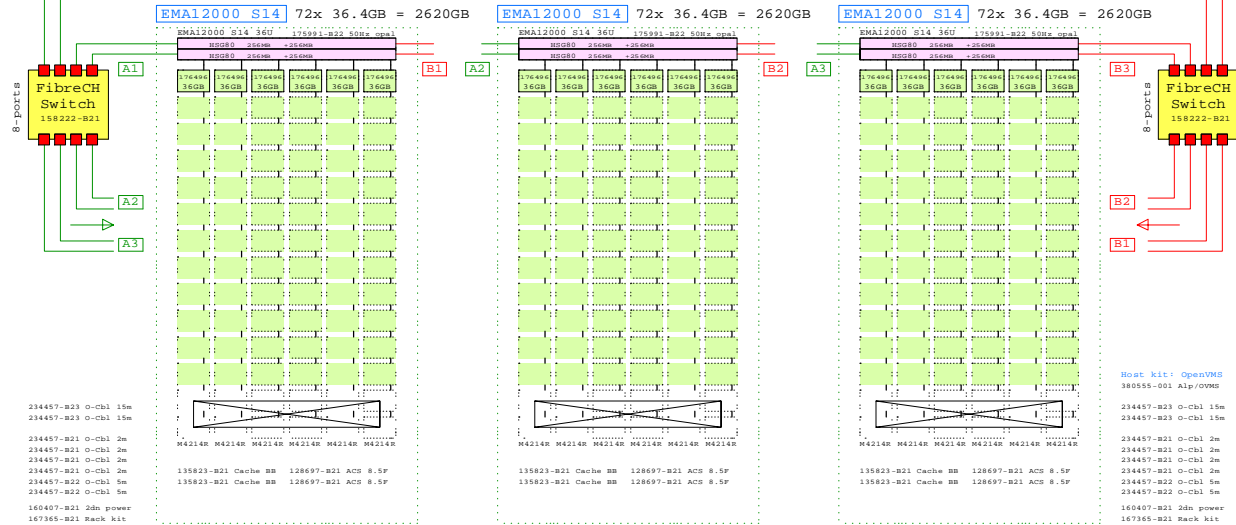

234457-023 0-cbl 15m
 234457-023 0-cbl 15m
 234457-021 0-cbl 2m
 234457-021 0-cbl 2m
 234457-021 0-cbl 2m
 234457-021 0-cbl 2m
 234457-022 0-cbl 5m
 234457-022 0-cbl 5m
 160407-021 2dn power
 167945-021 Rack kit

www.Compaq.com/golden-eggs

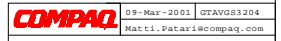

09-Mar-2001 GTAVGS3204
 Matti.Dataricompaq.com
 AlphaServer GS320 OVMS Cluster
 GOLDEN EGGS Visuals, Helsinki

Ethernet
GigaBitEthernet

AlphaServer GS320 OpenVMS system, 32xCPU, 256GB

Ethernet
GigaBitEthernet

AlphaServer GS320 OpenVMS system, 32xCPU, 256GB

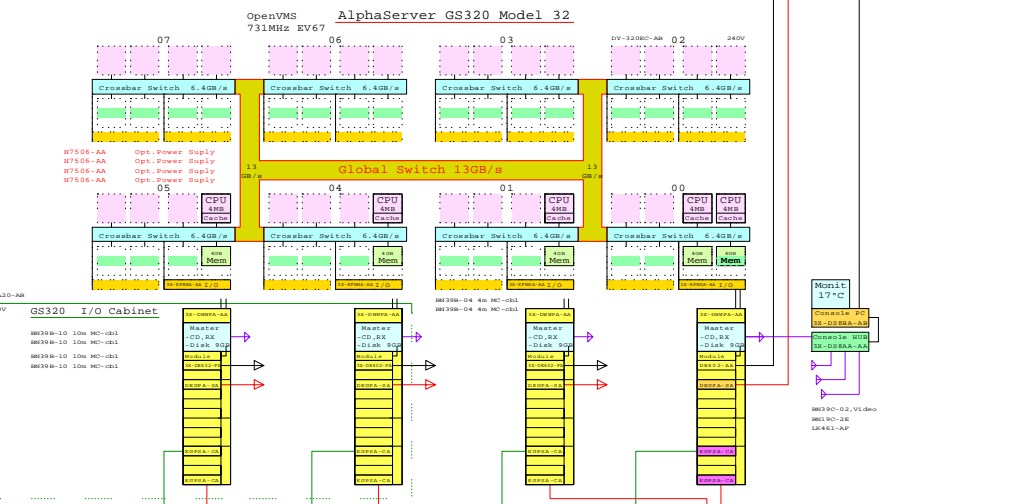
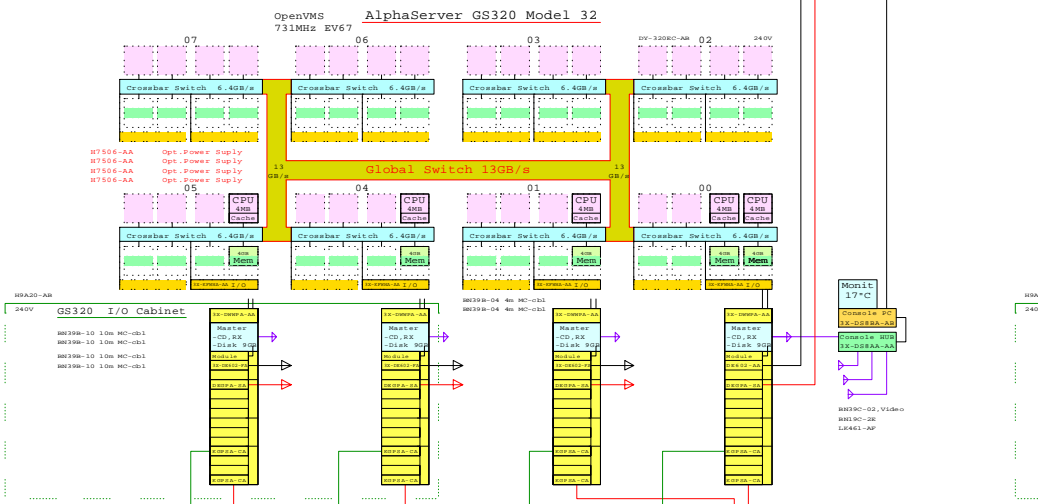

FC<10km



GTAVGS3205

www.Compaq.com/golden-eggs
 23-Feb-2001 GTAVGS3205
 Matt.L.Patel@compaq.com

COMPAQ
 Remote FC GS320 OpenVMS Clust.
 GOLDEN EGGS Visuals, Helsinki

Packaged cabinets:

Add ins: Disks & Controllers

MA6000

- NO cabinet
- For 1.0" disks



Two (2) channel
logical
controller tray,
-NO cabinet
-NO controller

M2100

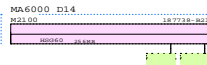

Two (2) channel
logical
controller tray,
-NO cabinet
-ONE controller
-ONE disk tray

MA6000 D14

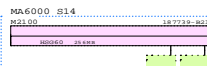

Two (2) channel
logical
controller tray,
-NO cabinet
-NO controller
-TWO disk trays

MA6000 S14

EMA12000 D14

- Cabinet 42U
- NO controllers
- For 1.0" disks
- Max 126 disks

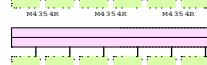

EMA12000 S14

- Cabinet 36U
- NO controllers
- For 1.0" disks
- Max 84 disks

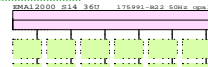

EMA12000 S10

- Cabinet 42U
- NO controllers
- For 1.6" disks
- Max 126 disks

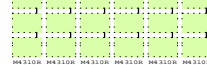
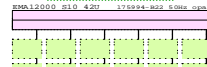

EMA12000 Blue

- Cabinet 41U
- NO controllers
- For 1.0" disks
- Max 84 disks

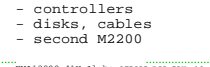
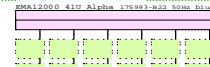

MA8000

- Cabinet 22U
- NO controllers
- For 1.0" disks
- Max 42 disks

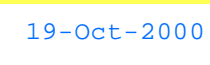
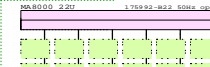

Tray_Controller

- NO controllers



Six (6) channel
logical
controller tray,
-NO cabinet

M2200

- M2200 tray with controllers
- disk trays
- disks....

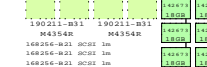

Tray_Storage

- NO disks

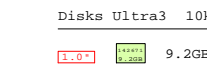
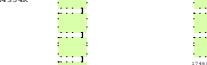

Modula
19-Oct-2000

BOM for this EMA12000 Blue + M2200

Part Number	Qty	Description
175993-B22	1	EMA12000 6x7 41U 50Hz blue
1.1	2	ACS V8.5F controller FCAL/PCSW
1.2	1	Modula M2200 shelf, NO controller
1.2.1	2	ACS V8.5F controller FCAL/PCSW
1.2.2	2	HS8xx Single external cache battery
1.2.3	6	SCSI cable VHDCI-VHDCI, 1m
1.2.4	1	HS80 FC Contr with 256MB cache
1.2.4.1	1	Cache Upg RASK ESA12K 256MB
1.2.5	1	HS80 FC Contr with 256MB cache
1.2.5.1	1	Cache Upg RASK ESA12K 256MB
1.2.6	1	Modula M4354R dual buss, 7+7, 1.0"
1.2.6.1	8	18.2GB 10000r Ultra3 SCSI disk 1"
1.2.7	1	Modula M4354R dual buss, 7+7, 1.0"
1.2.7.1	8	18.2GB 10000r Ultra3 SCSI disk 1"
1.2.8	1	Modula M4354R dual buss, 7+7, 1.0"
1.2.8.1	9	18.2GB 10000r Ultra3 SCSI disk 1"
1.3	2	HS8xx Single external cache battery
1.4	28	18.2GB 10000r Ultra3 SCSI disk 1"
1.5	1	HS80 FC Contr with 256MB cache
1.5.1	1	Cache Upg RASK ESA12K 256MB
1.6	1	HS80 FC Contr with 256MB cache
1.6.1	1	Cache Upg RASK ESA12K 256MB

EMA12000 Blue and controllers - disks, cables - second M2200

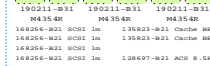
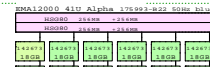

BOM for M2200, controllers and disks

Part Number	Qty	Description
135820-B21	1	Modula M2200 shelf, NO controller
1.1	2	ACS V8.5F controller FCAL/PCSW
1.2	6	SCSI cable VHDCI-VHDCI, 1m
1.3	1	HS80 FC Contr with 256MB cache
1.3.1	1	Cache Upg RASK ESA12K 256MB
1.4	1	HS80 FC Contr with 256MB cache
1.4.1	1	Cache Upg RASK ESA12K 256MB
1.5	1	Modula M4314R single buss, 14x 1.0"
1.5.1	10	18.2GB 10000r Ultra3 SCSI disk 1"
1.6	1	Modula M4314R single buss, 14x 1.0"
1.6.1	12	18.2GB 10000r Ultra3 SCSI disk 1"
1.7	1	Modula M4354R dual buss, 7+7, 1.0"
1.7.1	7	18.2GB 10000r Ultra3 SCSI disk 1"
1.8	1	Modula M4354R dual buss, 7+7, 1.0"
1.8.1	9	18.2GB 10000r Ultra3 SCSI disk 1"
2	2	HS8xx Single external cache battery
3	2	Modula M4214R 2nd power supply

Disks Ultra3 10k rpm

- 1.0" 9.2GB
- 1.0" 18.2GB
- 1.0" 36.4GB
- 1.0" 72.8GB

Disks Ultra3 15k rpm

- 1.0" 9.2GB
- 1.0" 18.2GB

Enterprise Modular Array EMA12000 D14

Ethernet

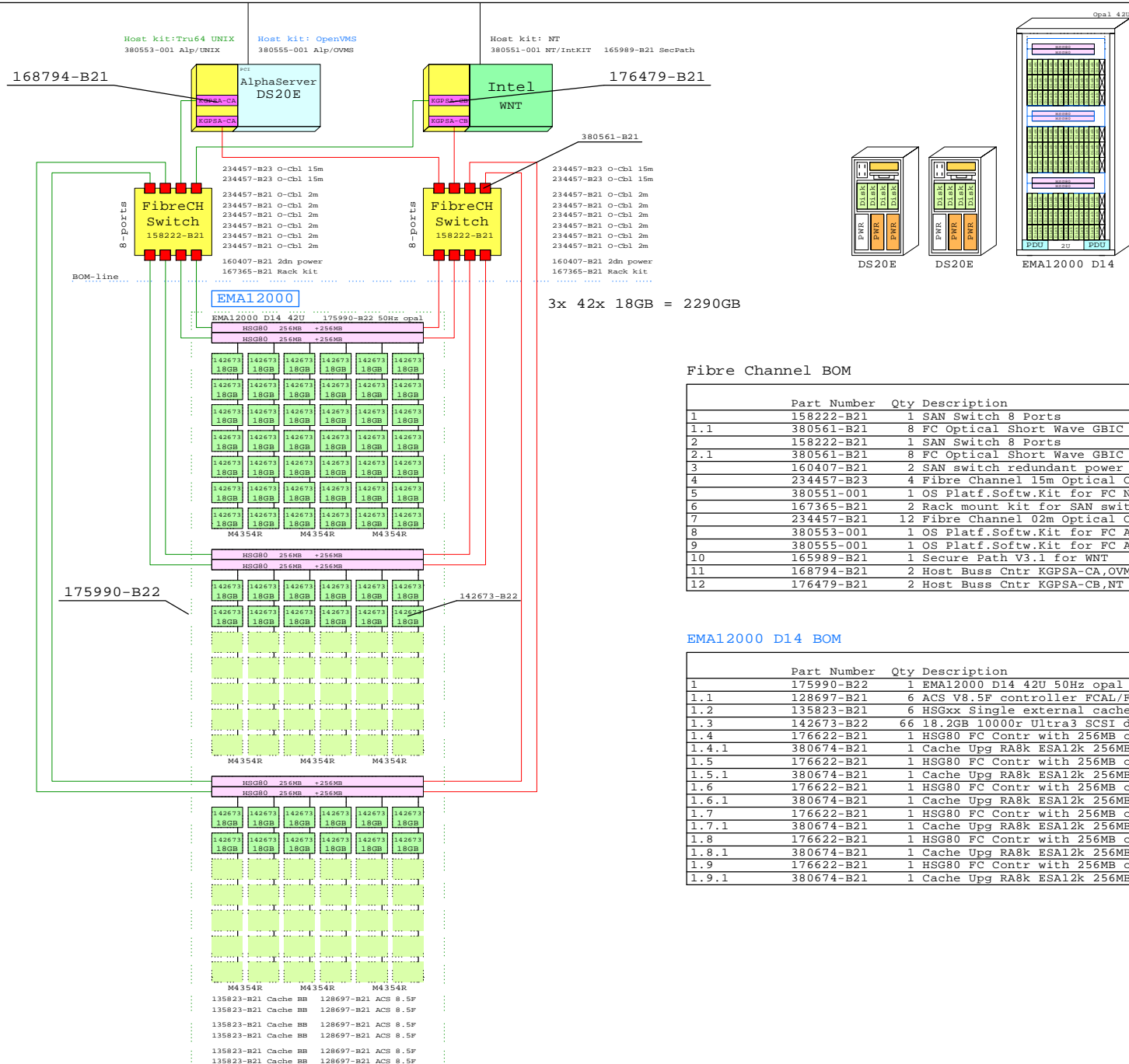

3x 42x 18GB = 2290GB

Fibre Channel BOM

Part Number	Qty	Description
158222-B21	1	SAN Switch 8 Ports
1.1	380561-B21	8 FC Optical Short Wave GBIC
2	158222-B21	1 SAN Switch 8 Ports
2.1	380561-B21	8 FC Optical Short Wave GBIC
3	160407-B21	2 SAN switch redundant power supply
4	234457-B23	4 Fibre Channel 15m Optical Cable
5	380551-001	1 OS Platf.Softw.Kit for FC NT/Intel
6	167365-B21	2 Rack mount kit for SAN switch
7	234457-B21	12 Fibre Channel 02m Optical Cable
8	380553-001	1 OS Platf.Softw.Kit for FC Alpha UNIX
9	380555-001	1 OS Platf.Softw.Kit for FC Alpha OVMS
10	165989-B21	1 Secure Path V3.1 for WNT
11	168794-B21	2 Host Buss Cntr KGPSA-CA,OVMS,UNIX
12	176479-B21	2 Host Buss Cntr KGPSA-CB,NT only

EMA12000 D14 BOM

Part Number	Qty	Description
1	175990-B22	1 EMA12000 D14 42U 50Hz opal
1.1	128697-B21	6 ACS V8.5F controller FCAL/FCSW
1.2	135823-B21	6 HSGxx Single external cache battery
1.3	142673-B22	66 18.2GB 10000r Ultra3 SCSI disk 1"
1.4	176622-B21	1 HSG80 FC Contr with 256MB cache
1.4.1	380674-B21	1 Cache Upg RA8k ESA12k 256MB
1.5	176622-B21	1 HSG80 FC Contr with 256MB cache
1.5.1	380674-B21	1 Cache Upg RA8k ESA12k 256MB
1.6	176622-B21	1 HSG80 FC Contr with 256MB cache
1.6.1	380674-B21	1 Cache Upg RA8k ESA12k 256MB
1.7	176622-B21	1 HSG80 FC Contr with 256MB cache
1.7.1	380674-B21	1 Cache Upg RA8k ESA12k 256MB
1.8	176622-B21	1 HSG80 FC Contr with 256MB cache
1.8.1	380674-B21	1 Cache Upg RA8k ESA12k 256MB
1.9	176622-B21	1 HSG80 FC Contr with 256MB cache
1.9.1	380674-B21	1 Cache Upg RA8k ESA12k 256MB

www.Compaq.com/golden-eggs

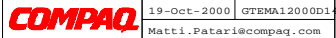

Enterprise Modular Array 12000
GOLDEN EGGS Visuals, Helsinki

EMA12000 D14

This template is included in the present GOLDEN EGGS Software kit.

Enterprise Modular Array EMA12000 S14

Ethernet

Host kit: Tru64 UNIX
380553-001 Alp/UNIX

Host kit: OpenVMS
380555-001 Alp/OVMS

Host kit: NT
380551-001 NT/IntKIT 165989-B21 SecPath

168794-B21

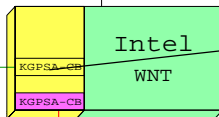
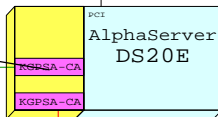

176479-B21

8-ports

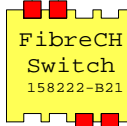

- 234457-B23 0-Cbl 15m
- 234457-B23 0-Cbl 15m
- 234457-B21 0-Cbl 2m
- 234457-B21 0-Cbl 2m
- 160407-B21 2dn power
- 167365-B21 Rack kit

8-ports

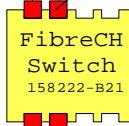

- 380561-B21
- 234457-B23 0-Cbl 15m
- 234457-B23 0-Cbl 15m
- 234457-B21 0-Cbl 2m
- 234457-B21 0-Cbl 2m
- 160407-B21 2dn power
- 167365-B21 Rack kit

BOM-line

EMA12000

72x 18GB = 1310GB

EMA12000 S14 36U 175991-B22 50Hz opal

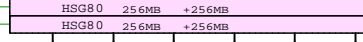

175991-B22

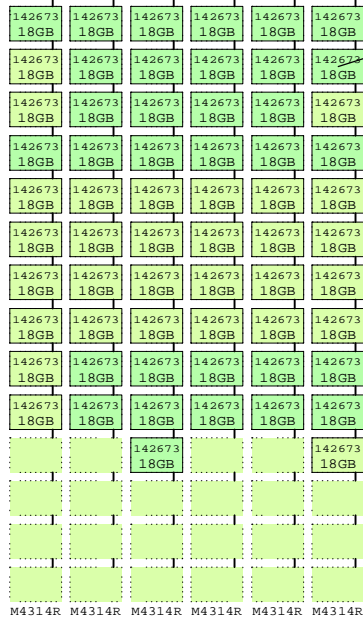

142673-B22

M4314R M4314R M4314R M4314R M4314R M4314R

135823-B21 Cache BB 128697-B21 ACS 8.5F
135823-B21 Cache BB 128697-B21 ACS 8.5F

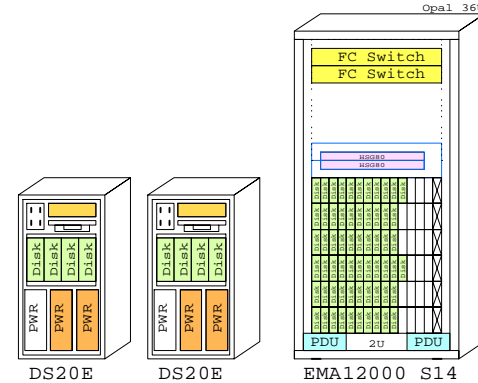

Fibre Channel BOM

	Part Number	Qty	Description
	158222-B21	1	SAN Switch 8 Ports
1	158222-B21	1	SAN Switch 8 Ports
1.1	380561-B21	4	FC Optical Short Wave GBIC
2	158222-B21	1	SAN Switch 8 Ports
2.1	380561-B21	4	FC Optical Short Wave GBIC
3	160407-B21	2	SAN switch redundant power supply
4	234457-B23	4	Fibre Channel 15m Optical Cable
5	380551-001	1	OS Platf.Software.Kit for FC NT/Intel
6	167365-B21	2	Rack mount kit for SAN switch
7	234457-B21	4	Fibre Channel 02m Optical Cable
8	380553-001	1	OS Platf.Software.Kit for FC Alpha UNIX
9	380555-001	1	OS Platf.Software.Kit for FC Alpha OVMS
10	165989-B21	1	Secure Path V3.1 for WNT
11	168794-B21	2	Host Buss Cntr KGPSA-CA,OVMS,UNIX
12	176479-B21	2	Host Buss Cntr KGPSA-CB,NT only

EMA12000 S14 BOM

	Part Number	Qty	Description
1	175991-B22	1	EMA12000 S14 36U 50Hz opal
1.1	128697-B21	2	ACS V8.5F controller FCAL/FCSW
1.2	135823-B21	2	HSGxx Single external cache battery
1.3	142673-B22	62	18.2GB 10000r Ultra3 SCSI disk
1.4	176622-B21	1	HSG80 FC Contr with 256MB cache
1.4.1	380674-B21	1	Cache Upg RA8k ESA12k 256MB
1.5	176622-B21	1	HSG80 FC Contr with 256MB cache
1.5.1	380674-B21	1	Cache Upg RA8k ESA12k 256MB

www.Compaq.com/golden-eggs

Since Jul-2000

COMPAQ

19-Oct-2000 | GTEMA12000S14
Matti.Patari@compaq.com

This template is included in the present GOLDEN EGGS Software kit.

EMA12000 S14

Enterprise Modular Array 12000
GOLDEN EGGS Visuals, Helsinki

Enterprise Modular Array EMA12000 S10

Ethernet

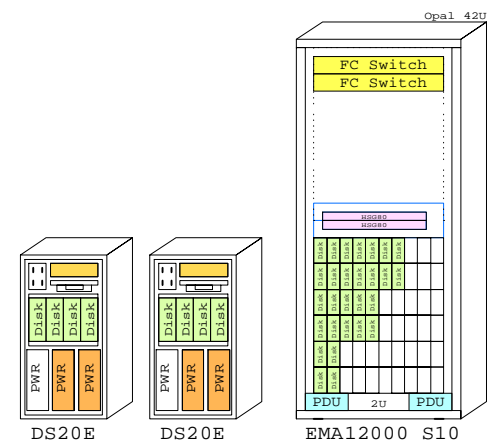
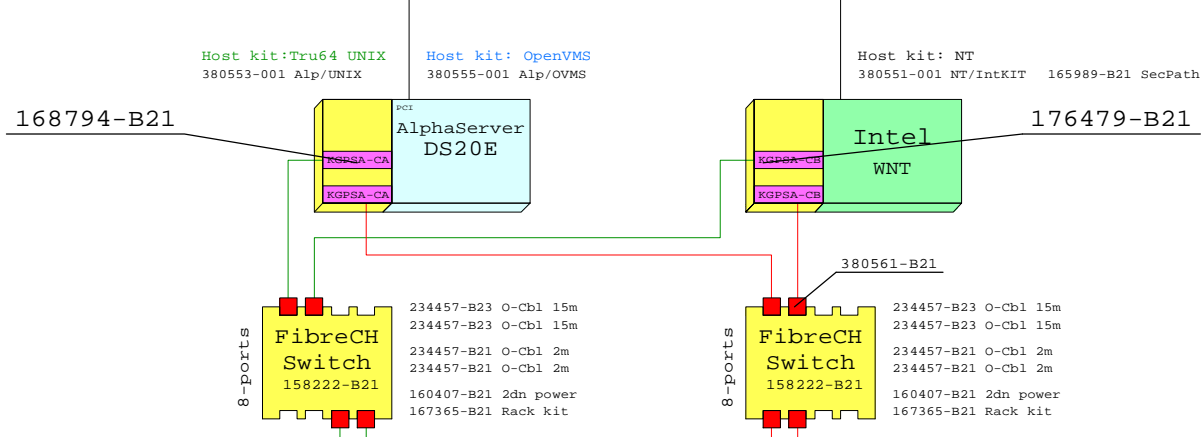

BOM-line

EMA12000 60x 72.8GB = 4368GB

EMA12000 S10 42U 175994-B22 50Hz opal

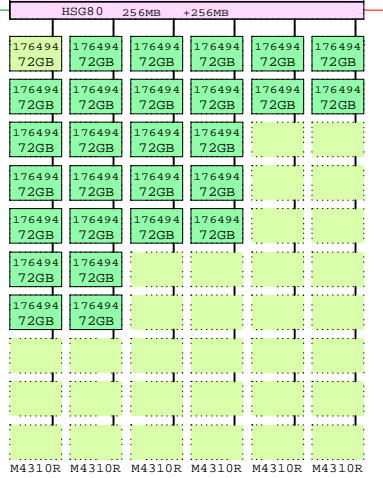

EMA12000 S10 42U 50Hz opal
175994-B22

135823-B21 Cache BB 128697-B21 ACS 8.5F
135823-B21 Cache BB 128697-B21 ACS 8.5F

Fibre Channel BOM

	Part Number	Qty	Description
	158222-B21	1	SAN Switch 8 Ports
1.1	380561-B21	4	FC Optical Short Wave GBIC
2	158222-B21	1	SAN Switch 8 Ports
2.1	380561-B21	4	FC Optical Short Wave GBIC
3	160407-B21	2	SAN switch redundant power supply
4	234457-B23	4	Fibre Channel 15m Optical Cable
5	380551-001	1	OS Platf.Softw.Kit for FC NT/Intel
6	167365-B21	2	Rack mount kit for SAN switch
7	234457-B21	4	Fibre Channel 02m Optical Cable
8	380553-001	1	OS Platf.Softw.Kit for FC Alpha UNIX
9	380555-001	1	OS Platf.Softw.Kit for FC Alpha OVMS
10	165989-B21	1	Secure Path V3.1 for WNT
11	168794-B21	2	Host Buss Cntr KGPSA-CA,OVMS,UNIX
12	176479-B21	2	Host Buss Cntr KGPSA-CB,NT only

EMA12000 S10 BOM

	Part Number	Qty	Description
1	175994-B22	1	EMA12000 S10 42U 50Hz opal
1.1	128697-B21	2	ACS V8.5F controller FCAL/FCSW
1.2	135823-B21	2	HSGxx Single external cache battery
1.3	176494-B21	28	72GB 10000r Ultra3 SCSI disk
1.4	176622-B21	1	HSG80 FC Contr with 256MB cache
1.4.1	380674-B21	1	Cache Upg RA8k ESA12k 256MB
1.5	176622-B21	1	HSG80 FC Contr with 256MB cache
1.5.1	380674-B21	1	Cache Upg RA8k ESA12k 256MB

www.Compaq.com/golden-eggs
Since: Jul-2000

COMPAQ 19-Oct-2000 GTEMA12000S10
Matti.Patari@compaq.com

Enterprise Modular Array 12000
GOLDEN EGGs Visuals, Helsinki

Enterprise Modular Array EMA12000 Blue

Ethernet

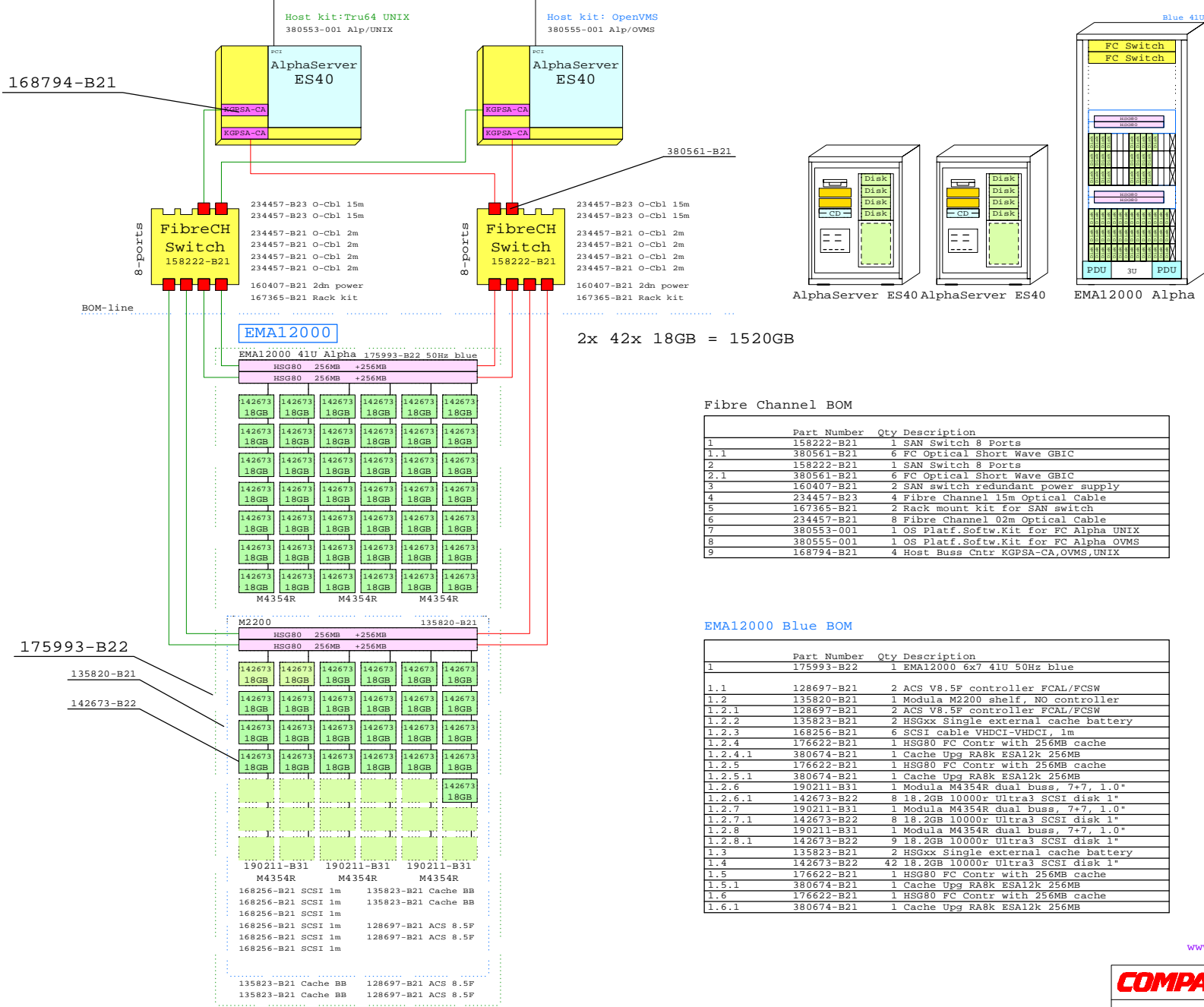

2x 42x 18GB = 1520GB

Fibre Channel BOM

Part Number	Qty	Description
1	15822-B21	1 SAN Switch 8 Ports
1.1	380561-B21	6 FC Optical Short Wave GBIC
2	15822-B21	1 SAN Switch 8 Ports
2.1	380561-B21	6 FC Optical Short Wave GBIC
3	160407-B21	2 SAN switch redundant power supply
4	234457-B23	4 Fibre Channel 15m Optical Cable
5	167365-B21	2 Rack mount kit for SAN switch
6	234457-B21	8 Fibre Channel 02m Optical Cable
7	380553-001	1 OS Platf.Softw.Kit for FC Alpha UNIX
8	380555-001	1 OS Platf.Softw.Kit for FC Alpha OVMS
9	168794-B21	4 Host Buss Cntr KGPSA-CA,OVMS,UNIX

EMA12000 Blue BOM

Part Number	Qty	Description
1	175993-B22	1 EMA12000 6x7 41U 50Hz blue
1.1	128697-B21	2 ACS V8.5F controller FCAL/FCSW
1.2	135820-B21	1 Modula M2200 shelf, NO controller
1.2.1	128697-B21	2 ACS V8.5F controller FCAL/FCSW
1.2.2	135823-B21	2 HSGxx Single external cache battery
1.2.3	168256-B21	6 SCSI cable VHDCI-VHDCI, 1m
1.2.4	176622-B21	1 HSG80 FC Contr with 256MB cache
1.2.4.1	380674-B21	1 Cache Upg RA8K ESA12k 256MB
1.2.5	176622-B21	1 HSG80 FC Contr with 256MB cache
1.2.5.1	380674-B21	1 Cache Upg RA8K ESA12k 256MB
1.2.6	190211-B31	1 Modula M4354R dual buss, 7+7, 1.0"
1.2.6.1	142673-B22	8 18.2GB 10000r Ultra3 SCSI disk 1"
1.2.7	190211-B31	1 Modula M4354R dual buss, 7+7, 1.0"
1.2.7.1	142673-B22	8 18.2GB 10000r Ultra3 SCSI disk 1"
1.2.8	190211-B31	1 Modula M4354R dual buss, 7+7, 1.0"
1.2.8.1	142673-B22	9 18.2GB 10000r Ultra3 SCSI disk 1"
1.3	135823-B21	2 HSGxx Single external cache battery
1.4	142673-B22	42 18.2GB 10000r Ultra3 SCSI disk 1"
1.5	176622-B21	1 HSG80 FC Contr with 256MB cache
1.5.1	380674-B21	1 Cache Upg RA8K ESA12k 256MB
1.6	176622-B21	1 HSG80 FC Contr with 256MB cache
1.6.1	380674-B21	1 Cache Upg RA8K ESA12k 256MB

www.Compaq.com/golden-eggs
Since Jul-2000

COMPAQ 19-Oct-2000 GTEMA12000bl
Matti.Patari@compaq.com

Enterprise Modular Array 12000
GOLDEN EGGS Visuals, Helsinki

This template is included in the present GOLDEN EGGS Software kit.

EMA12000 Blue

Enterprise Modular Array EMA12000 CI

1.6" drives

1.0" drives

Ethernet

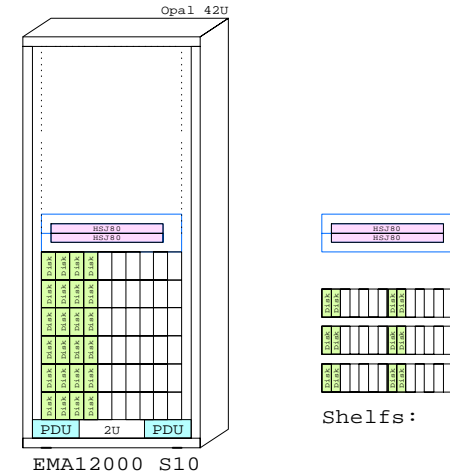
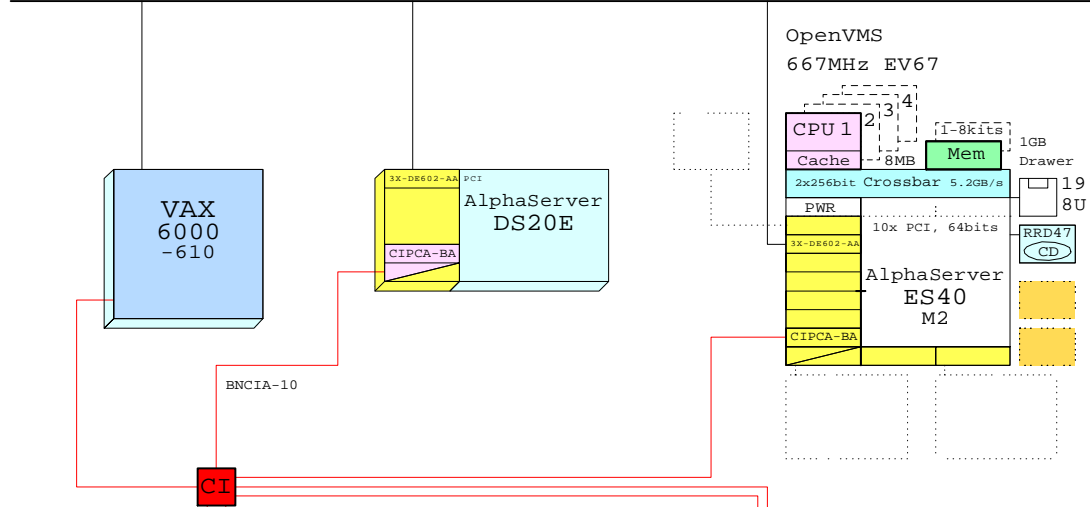

203694-B21 OpenVMS

BOM-line

1.6" drives

1.0" drives

EMA12000

60x 72.8GB = 4368GB

Shelves:M2200+ 3xM4354R

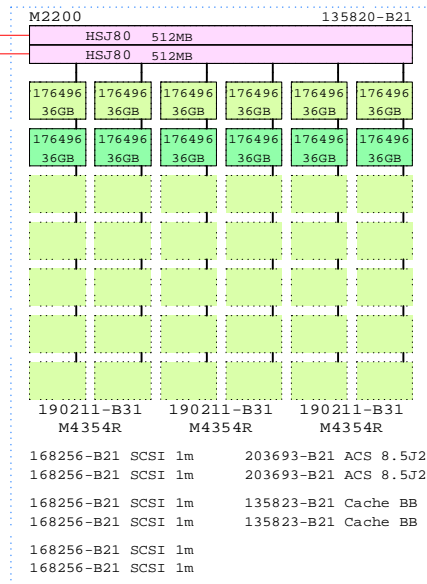
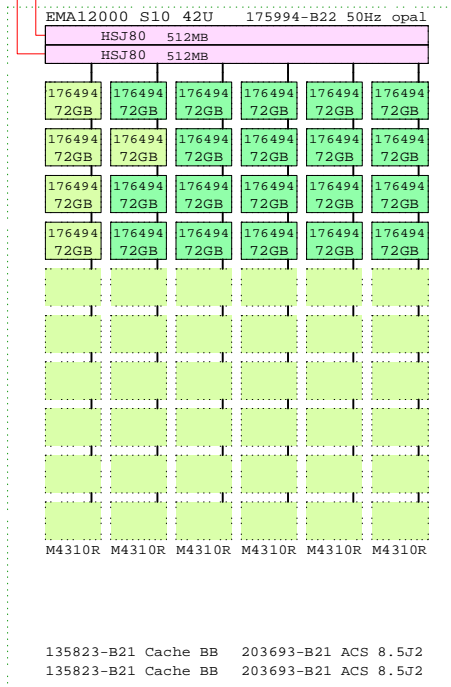

BOM for EMA12000

	Part Number	Qty	Description
	175994-B22	1	EMA12000 S10 42U 50Hz opal
1	135823-B21	2	HSGxx Single external cache battery
1.1	176494-B21	24	72GB 10000r Ultra3 SCSI disk 1.6"
1.2	203693-B21	2	ACS V8.5J-2 controller CI software
1.3	204305-B21	2	HSJ80 CI Contr 512MB cache
1.4	203694-B21	1	OS Platf.Softw.Kit for HSI80 OpenVMS
2			

BOM for Shelves

	Part Number	Qty	Description
1	135820-B21	1	Modula M2200 shelf, NO controller
1.1	135823-B21	2	HSGxx Single external cache battery
1.2	168256-B21	6	SCSI cable VHDCI-VHDCI, 1m
1.3	190211-B31	1	Modula M4354R dual buss, 7+7, 1.0"
1.3.1	176496-B22	4	36GB 10000r Ultra3 SCSI disk 1"
1.4	190211-B31	1	Modula M4354R dual buss, 7+7, 1.0"
1.4.1	176496-B22	4	36GB 10000r Ultra3 SCSI disk 1"
1.5	190211-B31	1	Modula M4354R dual buss, 7+7, 1.0"
1.5.1	176496-B22	4	36GB 10000r Ultra3 SCSI disk 1"
1.6	203693-B21	2	ACS V8.5J-2 controller CI software
1.7	204305-B21	2	HSJ80 CI Contr 512MB cache
2	203694-B21	1	OS Platf.Softw.Kit for HSI80 OpenVMS

135823-B21 Cache BB 203693-B21 ACS 8.5J2
135823-B21 Cache BB 203693-B21 ACS 8.5J2

www.Compaq.com/golden-eggs

Since: Oct-2000

COMPAQ 20-Oct-2000 GTEMA1200OCI
Matti.Patari@compaq.com

This template is included in the present GOLDEN EGGS Software kit.

EMA12000 CI

EMA12000 for CI
GOLDEN EGGS Visuals, Helsinki

Modular Array MA8000

Ethernet

Host kit: Tru64 UNIX
380553-001 Alp/UNIX

Host kit: OpenVMS
380555-001 Alp/OVMS

Host kit: NT
380551-001 NT/IntKIT 165989-B21 SecPath

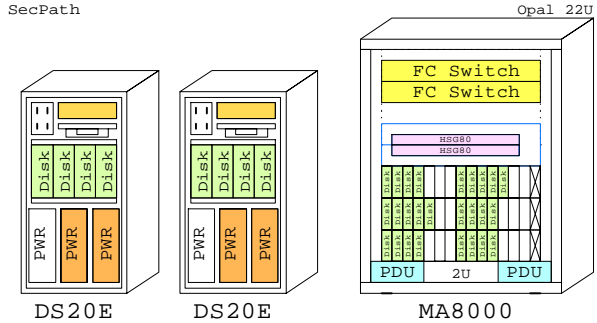
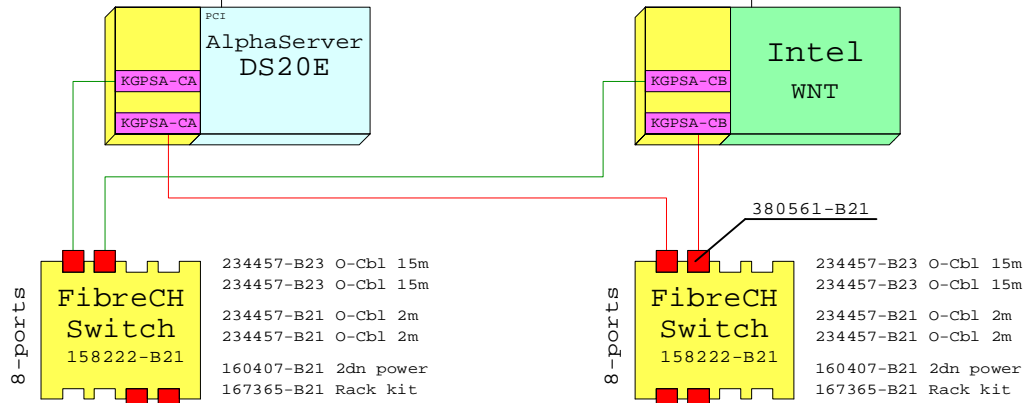

BOM-line

MA8000 42x 18GB = 760GB

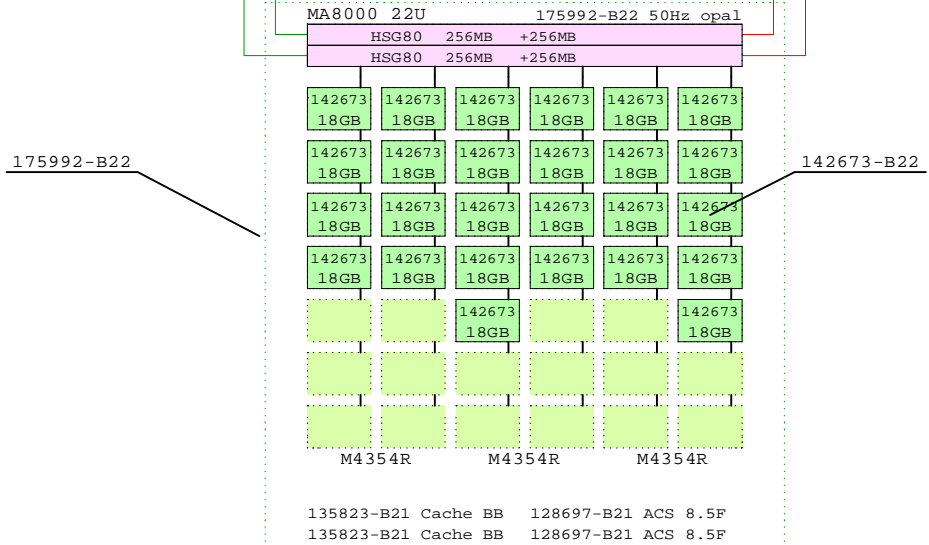

Fibre Channel BOM

	Part Number	Qty	Description
1	158222-B21	1	SAN Switch 8 Ports
1.1	380561-B21	4	FC Optical Short Wave GBIC
2	158222-B21	1	SAN Switch 8 Ports
2.1	380561-B21	4	FC Optical Short Wave GBIC
3	160407-B21	2	SAN switch redundant power supply
4	234457-B23	4	Fibre Channel 15m Optical Cable
5	380551-001	1	OS Platf.Softw.Kit for FC NT/Intel
6	167365-B21	2	Rack mount kit for SAN switch
7	234457-B21	4	Fibre Channel 02m Optical Cable
8	380553-001	1	OS Platf.Softw.Kit for FC Alpha UNIX
9	380555-001	1	OS Platf.Softw.Kit for FC Alpha OVMS
10	168794-B21	2	Host Buss Cntr KGPSA-CA,OVMS,UNIX
11	176479-B21	2	Host Buss Cntr KGPSA-CB,NT only

MA8000 BOM

	Part Number	Qty	Description
1	175992-B22	1	MA8000 6x7 22U 50Hz opal
1.1	128697-B21	2	ACS V8.5F controller FCAL/FCSW
1.2	135823-B21	2	HSGxx Single external cache battery
1.3	142673-B22	26	18.2GB 10000r Ultra3 SCSI disk
1.4	176622-B21	1	HSG80 FC Contr with 256MB cache
1.4.1	380674-B21	1	Cache Upg RA8k ESA12k 256MB
1.5	176622-B21	1	HSG80 FC Contr with 256MB cache
1.5.1	380674-B21	1	Cache Upg RA8k ESA12k 256MB

www.Compaq.com/golden-eggs

Since:Jul-2000



19-Oct-2000 GTMA8000a
Matti.Patari@compaq.com

Modular Array, MA8000
GOLDEN EGGS Visuals, Helsinki

This template is included in the present GOLDEN EGGS Software kit.

MA8000

Modular Array MA6000 D14

Ethernet

Host kit: Tru64 UNIX
192211-B21 Tru64

Host kit: OpenVMS
192217-B21 OpenVMS

Host kit: NT
192214-B21 NT/IntKIT 165989-B21 SecPath

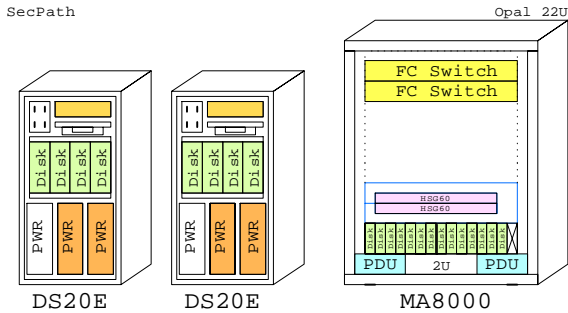
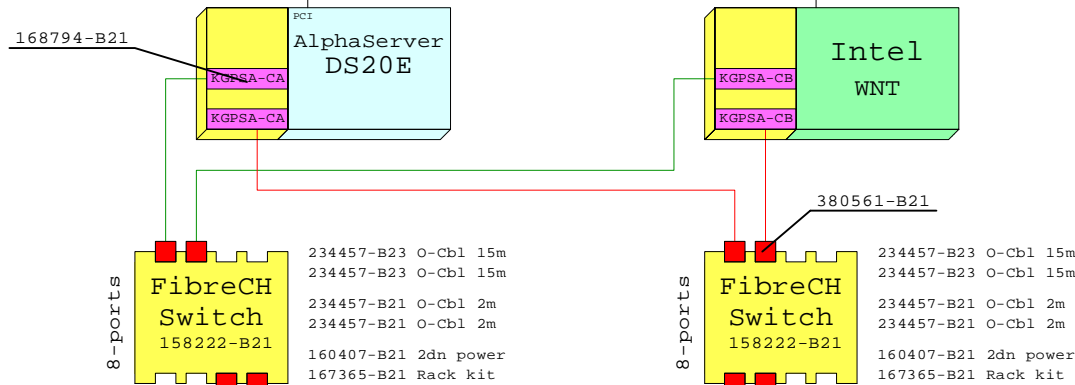

BOM-line

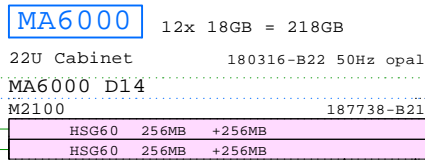

180316-B22

187738-B21

- 180319-B21 ACS 8.5L
- 180319-B21 ACS 8.5L
- 135823-B21 Cache BB

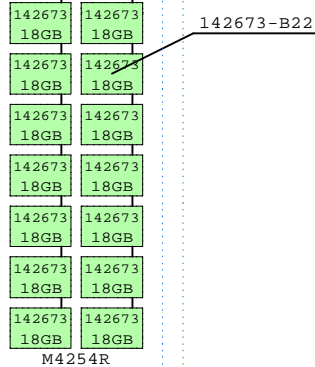

Fibre Channel BOM

Part Number	Qty	Description
1	1	158222-B21 SAN Switch 8 Ports
1.1	4	380561-B21 FC Optical Short Wave GBIC
2	1	158222-B21 SAN Switch 8 Ports
2.1	4	380561-B21 FC Optical Short Wave GBIC
3	2	160407-B21 SAN switch redundant power supply
4	1	192214-B21 OS Platf.Softw.Kit for HSG60 NT/Intel
5	4	234457-B23 Fibre Channel 15m Optical Cable
6	2	167365-B21 Rack mount kit for SAN switch
7	4	234457-B21 Fibre Channel 02m Optical Cable
8	1	192217-B21 OS Platf.Softw.Kit for HSG60 OpenVMS
9	1	192211-B21 OS Platf.Softw.Kit for HSG60 Tru64 UNIX
10	2	168794-B21 Host Buss Cntr KGPSA-CA,OVMS,UNIX
11	2	176479-B21 Host Buss Cntr KGPSA-CB,NT only

MA6000 D14 BOM

Part Number	Qty	Description
1	1	180316-B22 Empty 22U Modula cabinet 50Hz opal
1.1	1	187738-B21 MA6000 D14 1xHSG60 256MB
1.1.1	1	135823-B21 HSGxx Single external cache battery
1.1.2	14	142673-B22 14 18.2GB 10000r Ultra3 SCSI disk
1.1.3	1	174134-B21 HSG60 FC Contr with 256MB cache
1.1.3.1	1	380674-B21 Cache Upg RA8k ESA12k 256MB
1.1.4	2	180319-B21 ACS V8.5L FC-fab,FC-loop, HSG60
1.1.5	1	380674-B21 Cache Upg RA8k ESA12k 256MB

www.Compaq.com/golden-eggs

COMPAQ	07-Sep-2000	GTMA6000a
	Matti.Patari@compaq.com	

Modular Array, MA6000 S14
GOLDEN EGGS Visuals, Helsinki

This template is included in the present GOLDEN EGGS Software kit.

MA6000 D14

Modular Array MA6000 S14

Ethernet

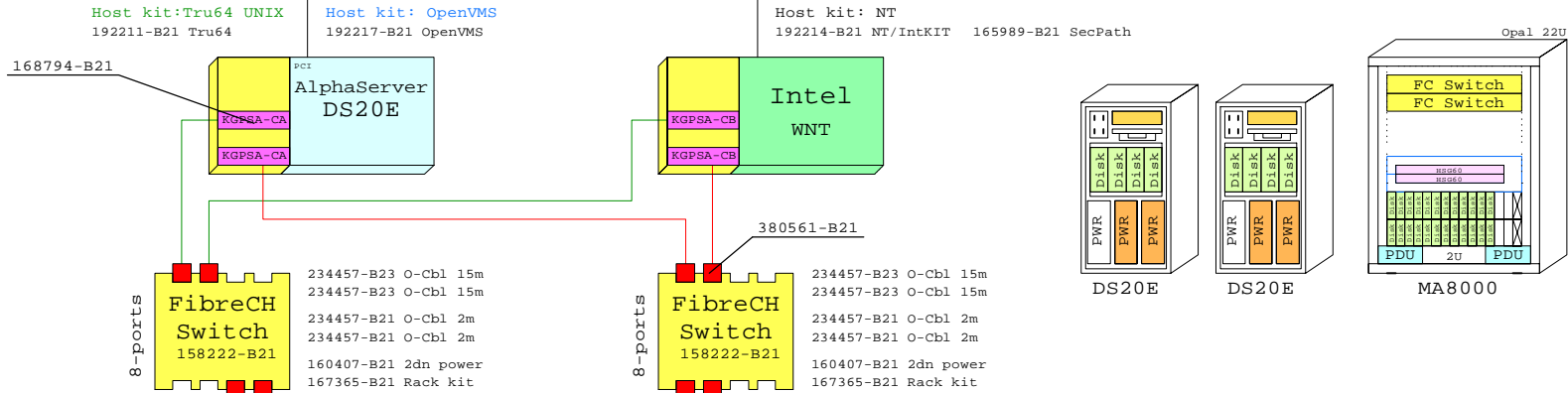

BOM-line

MA6000	24x 18GB = 436GB
22U Cabinet	180316-B22 50Hz opal
MA6000 S14	
M2100	187739-B21
HSG60	256MB +256MB
HSG60	256MB +256MB

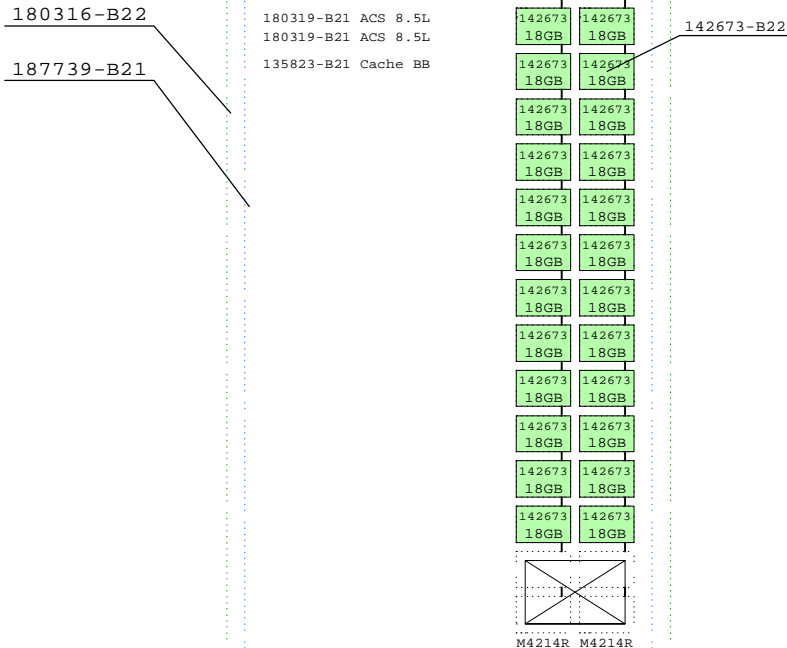

Fibre Channel BOM

	Part Number	Qty	Description
1	158222-B21	1	SAN Switch 8 Ports
1.1	380561-B21	4	FC Optical Short Wave GBIC
2	158222-B21	1	SAN Switch 8 Ports
2.1	380561-B21	4	FC Optical Short Wave GBIC
3	160407-B21	2	SAN switch redundant power supply
4	192214-B21	1	OS Platf.Softw.Kit for HSG60 NT/Intel
5	234457-B23	4	Fibre Channel 15m Optical Cable
6	167365-B21	2	Rack mount kit for SAN switch
7	234457-B21	4	Fibre Channel 02m Optical Cable
8	192217-B21	1	OS Platf.Softw.Kit for HSG60 OpenVMS
9	192211-B21	1	OS Platf.Softw.Kit for HSG60 Tru64 UNIX
10	168794-B21	2	Host Buss Cntr KGPSA-CA,OVMS,UNIX
11	176479-B21	2	Host Buss Cntr KGPSA-CB,NT only

MA6000 S14 BOM

	Part Number	Qty	Description
1	180316-B22	1	Empty 22U Modula cabinet 50Hz opal
1.1	187739-B21	1	MA6000 S14 1xHSG60 256MB
1.1.1	135823-B21	1	HSGxx Single external cache battery
1.1.2	142673-B22	24	18.2GB 10000r Ultra3 SCSI disk
1.1.3	174134-B21	1	HSG60 FC Contr with 256MB cache
1.1.3.1	380674-B21	1	Cache Upg RA8k ESA12k 256MB
1.1.4	180319-B21	2	ACS V8.5L FC-fab,FC-loop, HSG60
1.1.5	380674-B21	1	Cache Upg RA8k ESA12k 256MB

www.Compaq.com/golden-eggs

COMPAQ	07-Sep-2000	GTMA6000b
	Mattti.Patari@compaq.com	

Modular Array, MA6000 S14
GOLDEN EGGS Visuals, Helsinki

This template is included in the present GOLDEN EGGS Software kit.

MA6000 S14

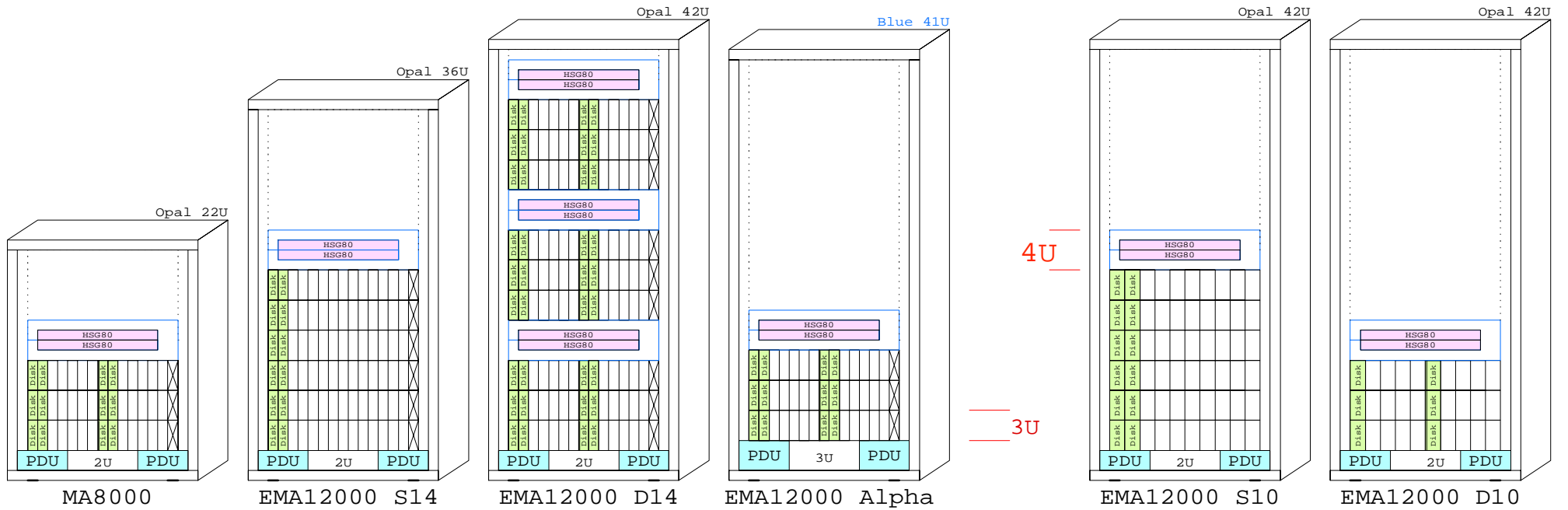

COMPAQ

29-Jun-2000 Modula-Cabs

Matti.Patari@compaq.com

Modula Cabinets
GOLDEN EGGS Visuals, Helsinki

Enterprise Modular Array EMA16000 D14

Ethernet

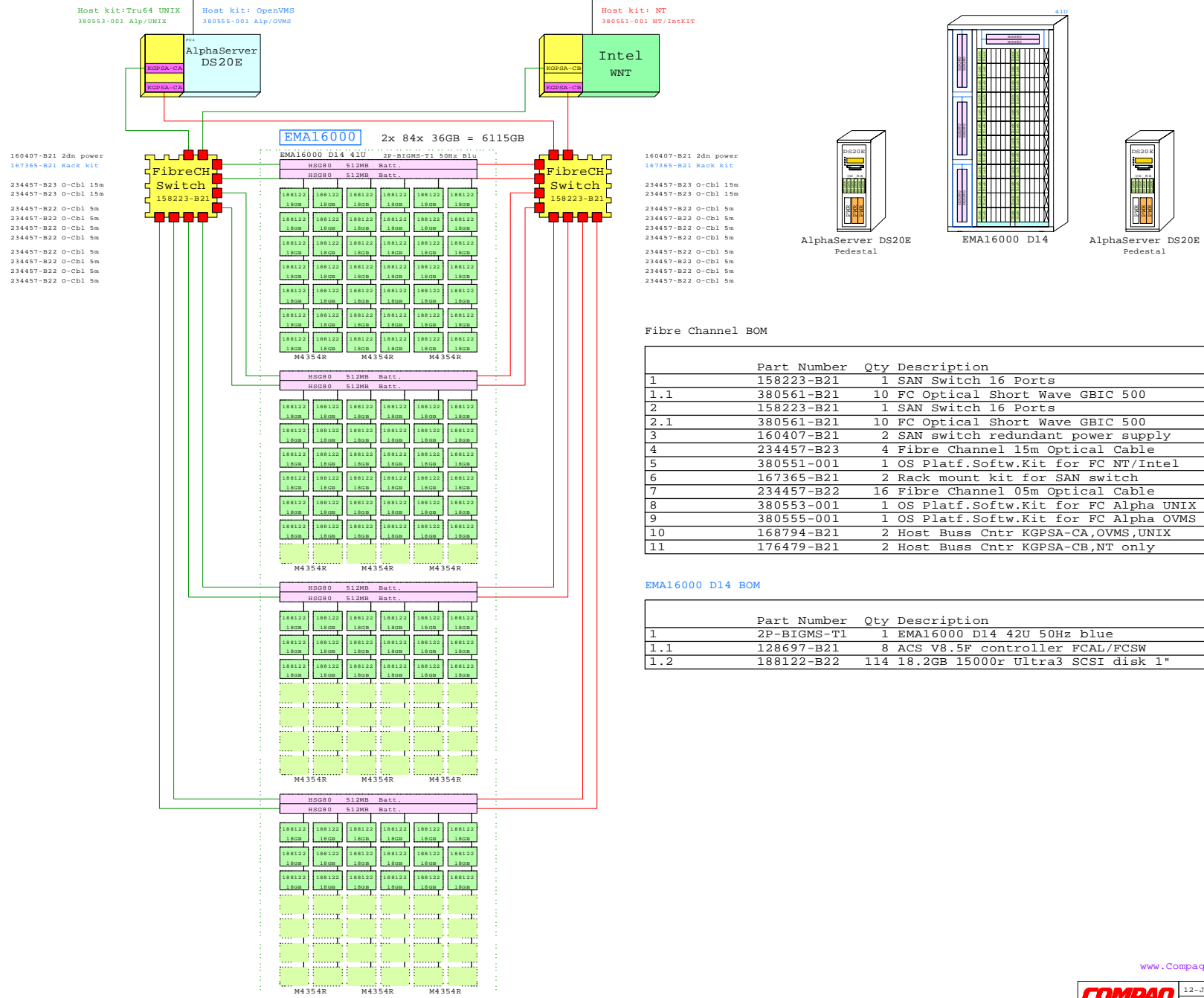

160407-B21 2dn power
167365-B21 Rack Kit
234457-B23 O-Cbl 15m
234457-B23 O-Cbl 15m
234457-B22 O-Cbl 5m
234457-B22 O-Cbl 5m
234457-B22 O-Cbl 5m
234457-B22 O-Cbl 5m
234457-B22 O-Cbl 5m
234457-B22 O-Cbl 5m
234457-B22 O-Cbl 5m

160407-B21 2dn power
167365-B21 Rack Kit
234457-B23 O-Cbl 15m
234457-B23 O-Cbl 15m
234457-B22 O-Cbl 5m
234457-B22 O-Cbl 5m
234457-B22 O-Cbl 5m
234457-B22 O-Cbl 5m
234457-B22 O-Cbl 5m
234457-B22 O-Cbl 5m
234457-B22 O-Cbl 5m

Fibre Channel BOM

	Part Number	Qty	Description
1	158223-B21	1	SAN Switch 16 Ports
1.1	380561-B21	10	FC Optical Short Wave GBIC 500
2	158223-B21	1	SAN Switch 16 Ports
2.1	380561-B21	10	FC Optical Short Wave GBIC 500
3	160407-B21	2	SAN switch redundant power supply
4	234457-B23	4	Fibre Channel 15m Optical Cable
5	380551-001	1	OS Platf.Softw.Kit for FC NT/Intel
6	167365-B21	2	Rack mount kit for SAN switch
7	234457-B22	16	Fibre Channel 05m Optical Cable
8	380553-001	1	OS Platf.Softw.Kit for FC Alpha UNIX
9	380555-001	1	OS Platf.Softw.Kit for FC Alpha OVMS
10	168794-B21	2	Host Buss Cntr KGPSA-CA,OVMS,UNIX
11	176479-B21	2	Host Buss Cntr KGPSA-CB,NT only

EMA16000 D14 BOM

	Part Number	Qty	Description
1	2P-BIGMS-T1	1	EMA16000 D14 42U 50Hz blue
1.1	128697-B21	8	ACS V8.5F controller FCAL/FCSW
1.2	188122-B22	114	18.2GB 15000r Ultra3 SCSI disk 1"

128697-B21 ACS 8.5F 128697-B21 ACS 8.5F
128697-B21 ACS 8.5F 128697-B21 ACS 8.5F
128697-B21 ACS 8.5F 128697-B21 ACS 8.5F
128697-B21 ACS 8.5F 128697-B21 ACS 8.5F

www.Compaq.com/golden-eggs
Since Jan 2001

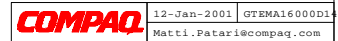

Enterprise Modular Array 16000
GOLDEN EGGS Visuals, Helsinki

EMA16000 D14

Enterprise Modular Array EMA16000 S14

Ethernet

Host kit: Tru64 UNIX
380553-001 Alp/UNIX

Host kit: OpenVMS
380555-001 Alp/OVMS

Host kit: NT
380551-001 NT/tntKIT

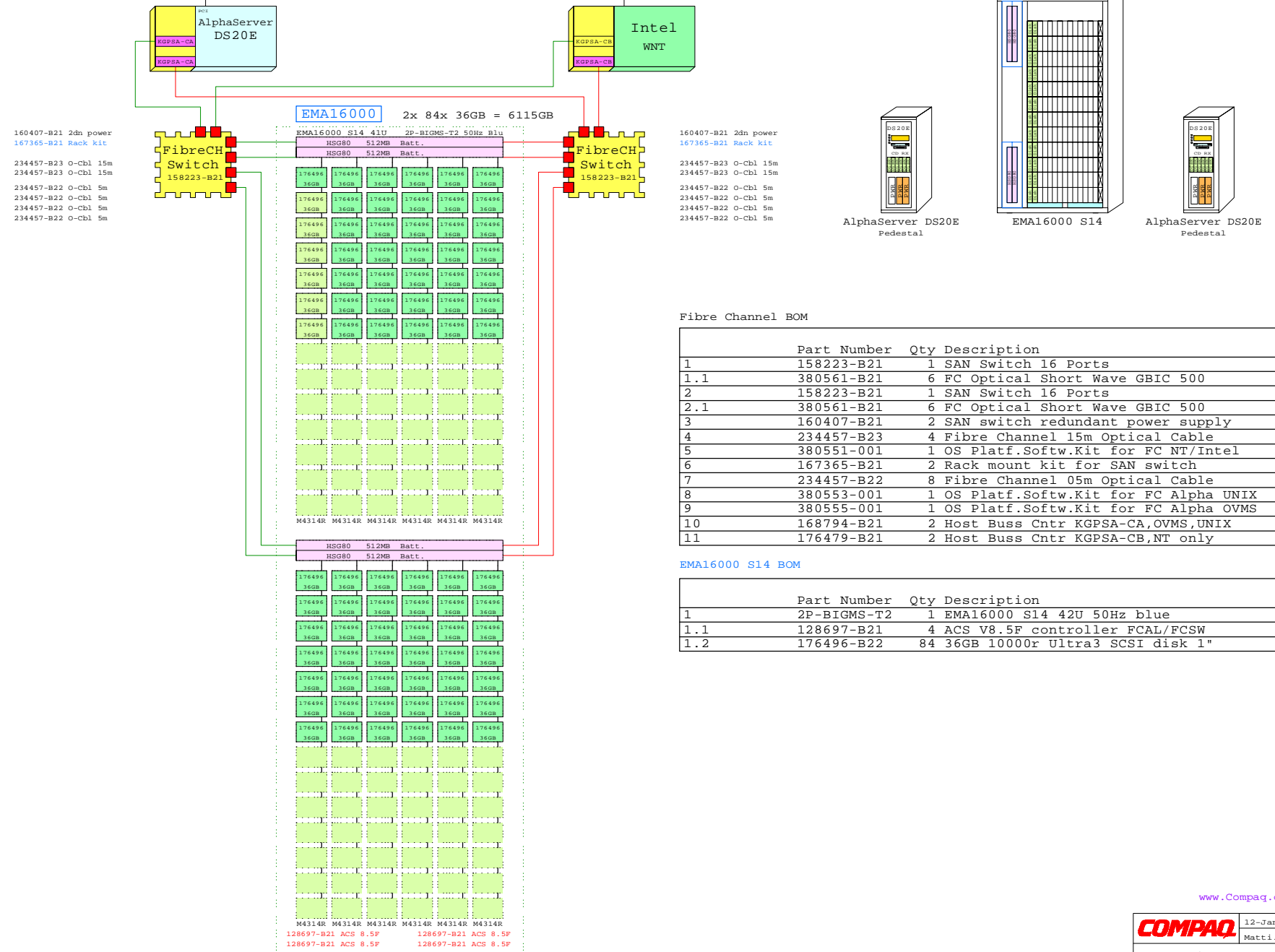

160407-B21 2dn power
167365-B21 Rack kit

234457-B23 O-Cbl 15m
234457-B23 O-Cbl 15m
234457-B22 O-Cbl 5m
234457-B22 O-Cbl 5m
234457-B22 O-Cbl 5m

160407-B21 2dn power
167365-B21 Rack kit

234457-B23 O-Cbl 15m
234457-B23 O-Cbl 15m
234457-B22 O-Cbl 5m
234457-B22 O-Cbl 5m
234457-B22 O-Cbl 5m

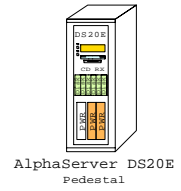
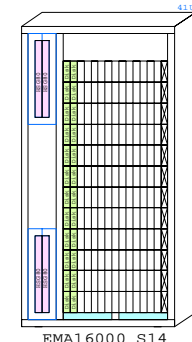
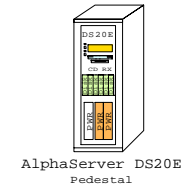

Fibre Channel BOM

Part Number	Qty	Description
1	1	158223-B21 SAN Switch 16 Ports
1.1	6	380561-B21 FC Optical Short Wave GBIC 500
2	1	158223-B21 SAN Switch 16 Ports
2.1	6	380561-B21 FC Optical Short Wave GBIC 500
3	2	160407-B21 SAN switch redundant power supply
4	4	234457-B23 Fibre Channel 15m Optical Cable
5	1	380551-001 OS Platf.Softw.Kit for FC NT/Intel
6	2	167365-B21 Rack mount kit for SAN switch
7	8	234457-B22 Fibre Channel 05m Optical Cable
8	1	380553-001 OS Platf.Softw.Kit for FC Alpha UNIX
9	1	380555-001 OS Platf.Softw.Kit for FC Alpha OVMS
10	2	168794-B21 Host Buss Cntr KGPSA-CA,OVMS,UNIX
11	2	176479-B21 Host Buss Cntr KGPSA-CB,NT only

EMA16000 S14 BOM

Part Number	Qty	Description
1	1	2P-BIGMS-T2 EMA16000 S14 42U 50Hz blue
1.1	4	128697-B21 ACS V8.5F controller FCAL/FCSW
1.2	84	176496-B22 36GB 10000r Ultra3 SCSI disk 1"

www.Compaq.com/golden-eggs
© Since Jan 2001

COMPAQ	12-Jan-2001	GTEMA16000S14
	Matti.Patar@compaq.com	

Enterprise Modular Array 16000
GOLDEN EGGS Visuals, Helsinki

This template is included in the present GOLDEN EGGS Software kit.

EMA16000 S14

Enterprise Modular Array EMA16000 D10

Ethernet

Host kit: Tru64 UNIX
380553-001 Alp/UNIX

Host kit: OpenVMS
380555-001 Alp/OVMS

Host kit: NT
380551-001 NT/IneKIT

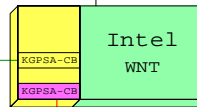
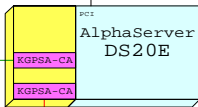

EMA16000

4x 30x 72GB = 8640GB

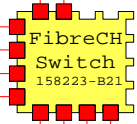
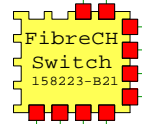

128697-B21 ACS 8.5F 128697-B21 ACS 8.5F
128697-B21 ACS 8.5F 128697-B21 ACS 8.5F
128697-B21 ACS 8.5F 128697-B21 ACS 8.5F
128697-B21 ACS 8.5F 128697-B21 ACS 8.5F

- 160407-B21 2dn power
- 167365-B21 Rack kit
- 234457-B23 0-cbl 15m
- 234457-B23 0-cbl 15m
- 234457-B22 0-cbl 5m
- 234457-B22 0-cbl 5m
- 234457-B22 0-cbl 5m
- 234457-B22 0-cbl 5m
- 234457-B22 0-cbl 5m
- 234457-B22 0-cbl 5m
- 234457-B22 0-cbl 5m
- 234457-B22 0-cbl 5m
- 234457-B22 0-cbl 5m

- 160407-B21 2dn power
- 167365-B21 Rack kit
- 234457-B23 0-cbl 15m
- 234457-B23 0-cbl 15m
- 234457-B22 0-cbl 5m
- 234457-B22 0-cbl 5m
- 234457-B22 0-cbl 5m
- 234457-B22 0-cbl 5m
- 234457-B22 0-cbl 5m
- 234457-B22 0-cbl 5m
- 234457-B22 0-cbl 5m
- 234457-B22 0-cbl 5m
- 234457-B22 0-cbl 5m

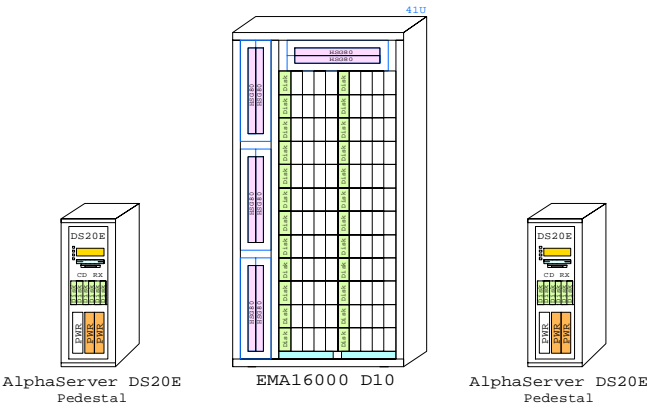

Fibre Channel BOM

	Part Number	Qty	Description
	158223-B21	1	SAN Switch 16 Ports
1	380561-B21	10	FC Optical Short Wave GBIC 500
2	158223-B21	1	SAN Switch 16 Ports
2.1	380561-B21	10	FC Optical Short Wave GBIC 500
3	160407-B21	2	SAN switch redundant power supply
4	234457-B23	4	Fibre Channel 15m Optical Cable
5	380551-001	1	OS Platf.Softw.Kit for FC NT/Intel
6	167365-B21	2	Rack mount kit for SAN switch
7	234457-B22	16	Fibre Channel 05m Optical Cable
8	380553-001	1	OS Platf.Softw.Kit for FC Alpha UNIX
9	380555-001	1	OS Platf.Softw.Kit for FC Alpha OVMS
10	168794-B21	2	Host Buss Cntr KGPSA-CA,OVMS,UNIX
11	176479-B21	2	Host Buss Cntr KGPSA-CB,NT only

EMA16000 D10 BOM

	Part Number	Qty	Description
1	2P-BIGMS-T3	1	EMA16000 D10 42U 50Hz blue
1.1	128697-B21	8	ACS V8.5F controller FCAL/FCSW
1.2	176494-B21	78	72GB 10000r Ultra3 SCSI disk 1.6"

www.Compaq.com/golden-eggs
Since Jan 2001

This template is included in the present GOLDEN EGGS Software kit.

EMA16000 D10

COMPAQ	12-Jan-2001	GTEMA16000D10
	Matti.Patari@compaq.com	
Enterprise Modular Array 16000 GOLDEN EGGS Visuals, Helsinki		

Enterprise Modular Array EMA16000 S10

Ethernet

Host kit: Tru64 UNIX
380553-001 Alp/UNIX

Host kit: OpenVMS
380555-001 Alp/OVMS

Host kit: NT
380551-001 NT/IntKIT



160407-B21 2dn power
167365-B21 Rack kit

234457-B23 O-Cbl 15m
234457-B23 O-Cbl 15m
234457-B22 O-Cbl 5m
234457-B22 O-Cbl 5m
234457-B22 O-Cbl 5m

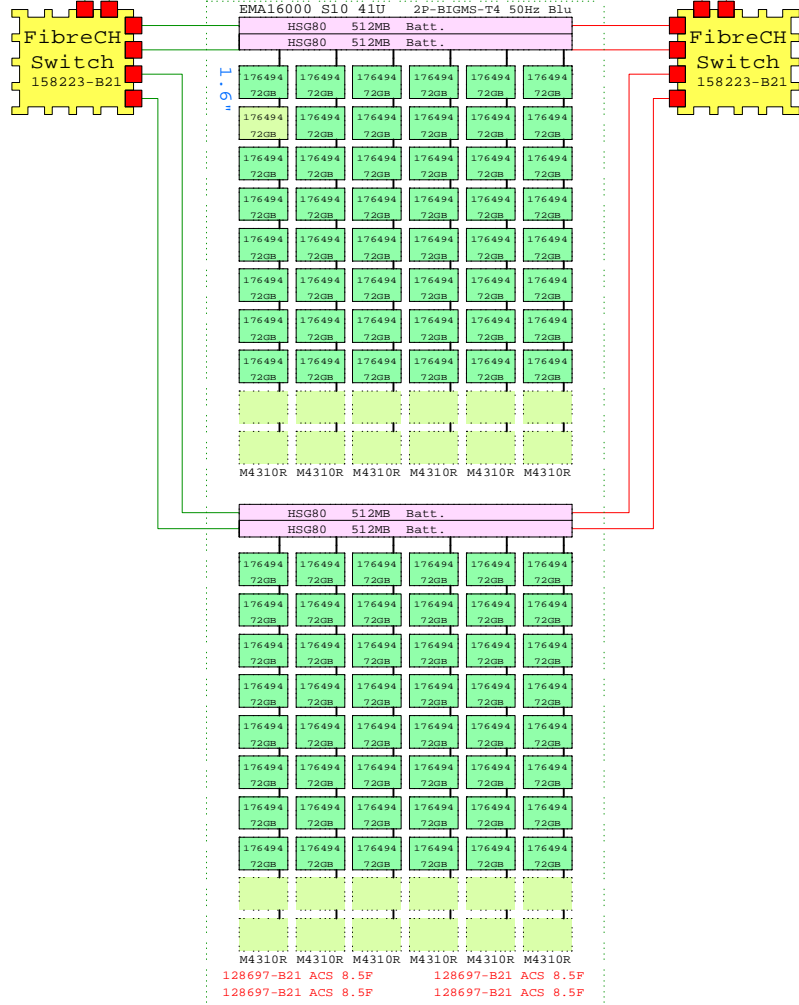

160407-B21 2dn power
167365-B21 Rack kit

234457-B23 O-Cbl 15m
234457-B23 O-Cbl 15m
234457-B22 O-Cbl 5m
234457-B22 O-Cbl 5m
234457-B22 O-Cbl 5m

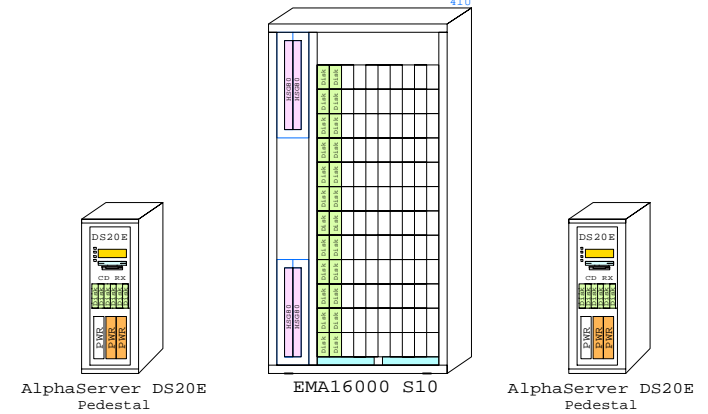

Fibre Channel BOM

Part Number	Qty	Description
158223-B21	1	SAN Switch 16 Ports
1.1	380561-B21	6 FC Optical Short Wave GBIC 500
2	158223-B21	1 SAN Switch 16 Ports
2.1	380561-B21	6 FC Optical Short Wave GBIC 500
3	160407-B21	2 SAN switch redundant power supply
4	234457-B23	4 Fibre Channel 15m Optical Cable
5	380551-001	1 OS Platf.Software Kit for FC NT/Intel
6	167365-B21	2 Rack mount kit for SAN switch
7	234457-B22	8 Fibre Channel 05m Optical Cable
8	380553-001	1 OS Platf.Software Kit for FC Alpha UNIX
9	380555-001	1 OS Platf.Software Kit for FC Alpha OVMS
10	168794-B21	2 Host Buss Cntr KGPSA-CA,OVMS,UNIX
11	176479-B21	2 Host Buss Cntr KGPSA-CB,NT only

EMA16000 S10 BOM

Part Number	Qty	Description
1	2P-BIGMS-T4	1 EMA16000 S10 42U 50Hz blue
1.1	128697-B21	4 ACS V8.5F controller FCAL/FCSW
1.2	176494-B21	96 72GB 10000r Ultra3 SCSI disk 1.6"

www.Compaq.com/golden-eggs
Since: Jan 2001

COMPAQ	12-Jan-2001	GTEMA16000S10
	Matti.Patari@compaq.com	

This template is included in the present GOLDEN EGGS Software kit.

EMA16000 S10

Enterprise Modular Array 16000
GOLDEN EGGS Visuals, Helsinki

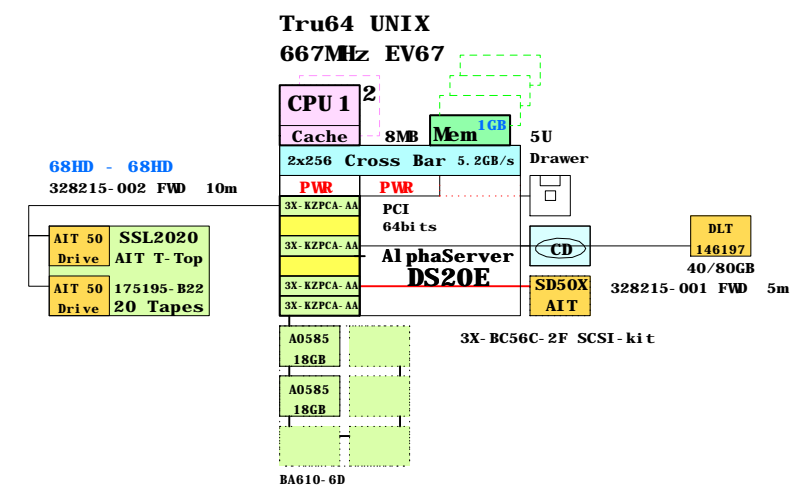
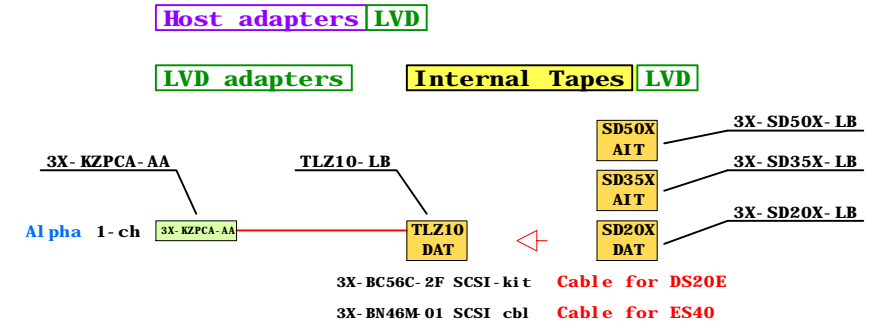
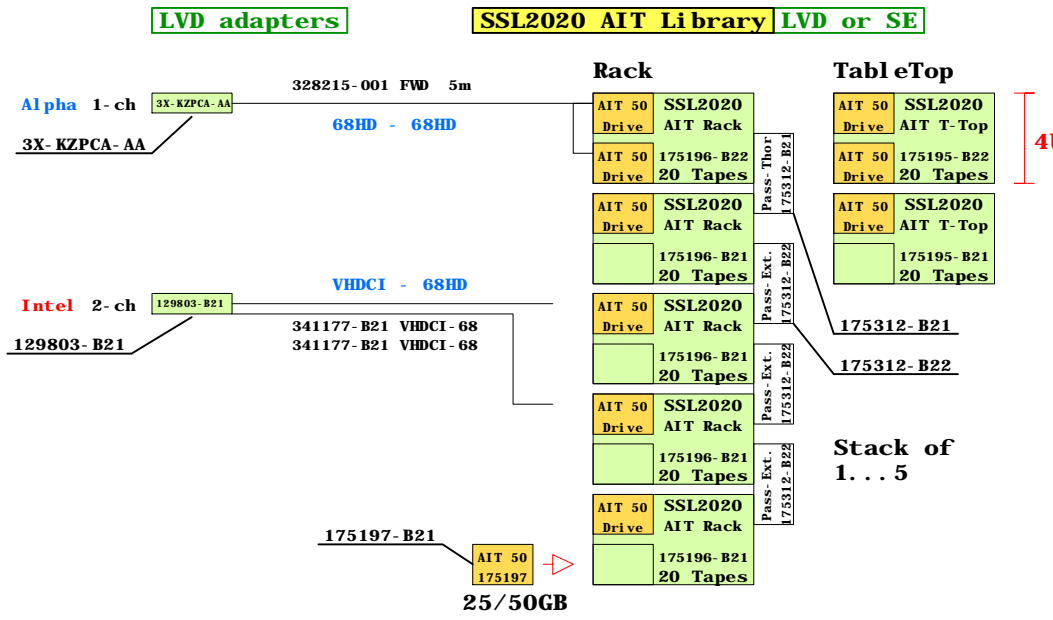
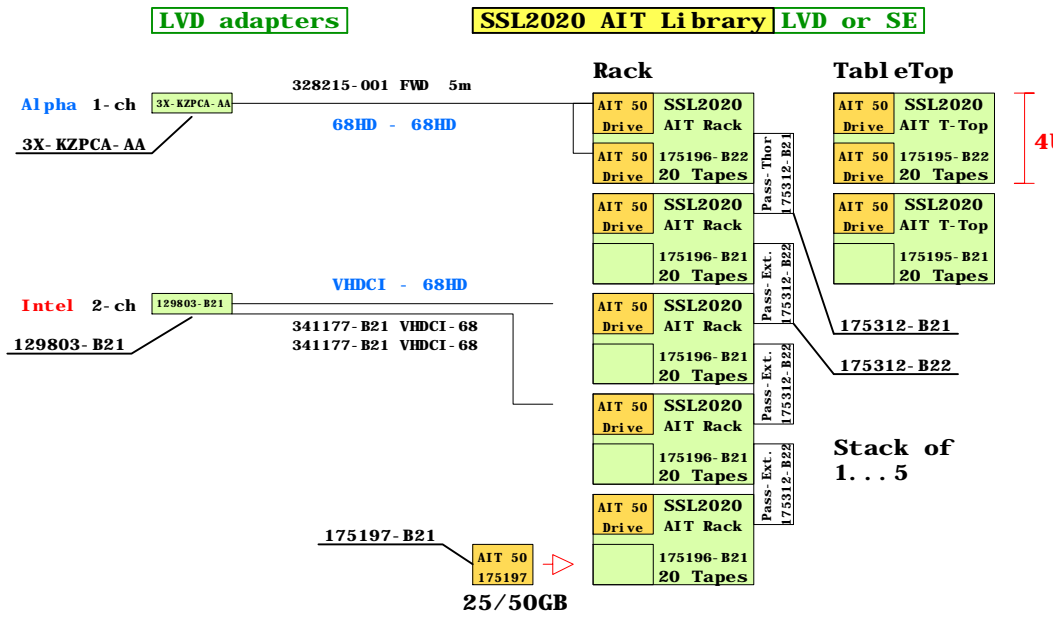
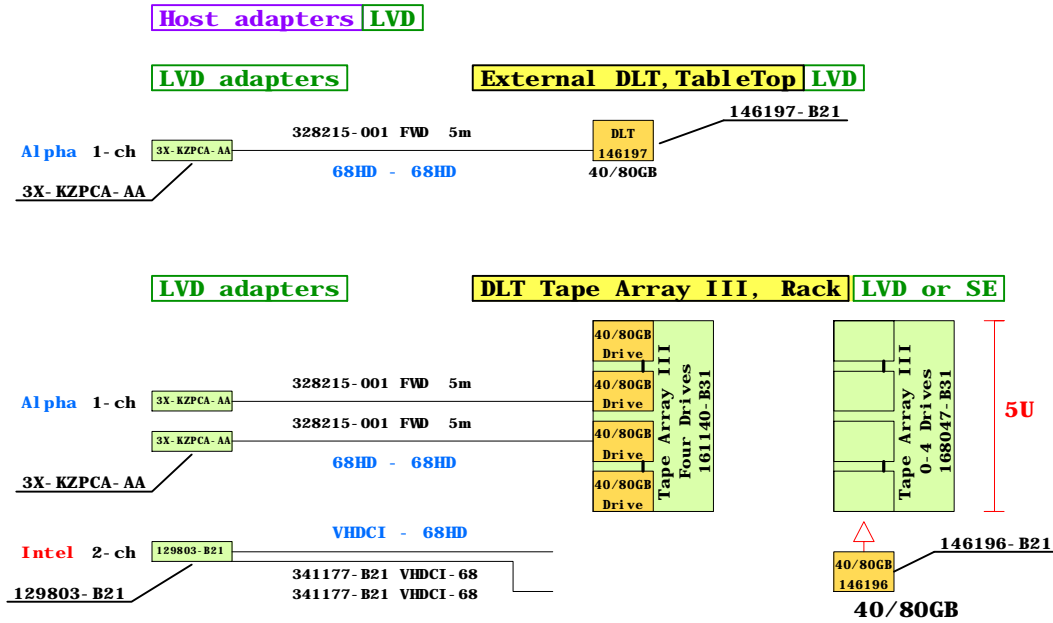

BOM of DS20E "tape system" above

Part Number	Qty	Description
1	1	DA-56PAA-FA AS DS20E 6/667 1GB, Rack, UNIX
1.1	1	3X-BC56C-2F DS20E SCSI Cable Kit
1.2	4	3X-KZPCA-AA Single channel LVD adapter
1.3	1	3X-SD50X-LB 50/100GB AIT tape drive, blue
1.4	1	BA610-6D ES40 Disk Drive Cage, 6-Bay
1.4.1	2	3R-A0585-AA 18.2GB Uscsi3 10k Universal disk 1"
2	1	175195-B22 SSL2020 AIT Lib. 2xDrive, 20slot, TT, LVD
3	1	146197-B21 40/80GB DLT Drive, TableTop, Opal
4	1	328215-002 Wide Differential SCSI Cable Kit 10m
5	1	328215-001 Wide Differential SCSI Cable Kit 5m

www.Compaq.com/golden-eggs
Since: Mar-2001

COMPAQ	30-Mar-2001	GTtape1
	Matti.Patari@Compaq.com	

Tape drives, host driven
GOLDEN EGGS Visuals, Helsinki

Tape1

This template is included in the present GOLDEN EGGS Software kit.

Host adapters LVD

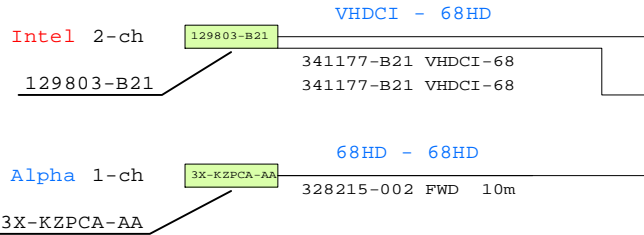

SCSI terms:

- LVD Low Voltage Differential
- HVD High Voltage Differential
- VHD CI Very High Density Cable Interconnect
- 68HD 68 pin High Density

Modular Data Router 2FC LVD

MSL5026 SDLT Library,Rack LVD

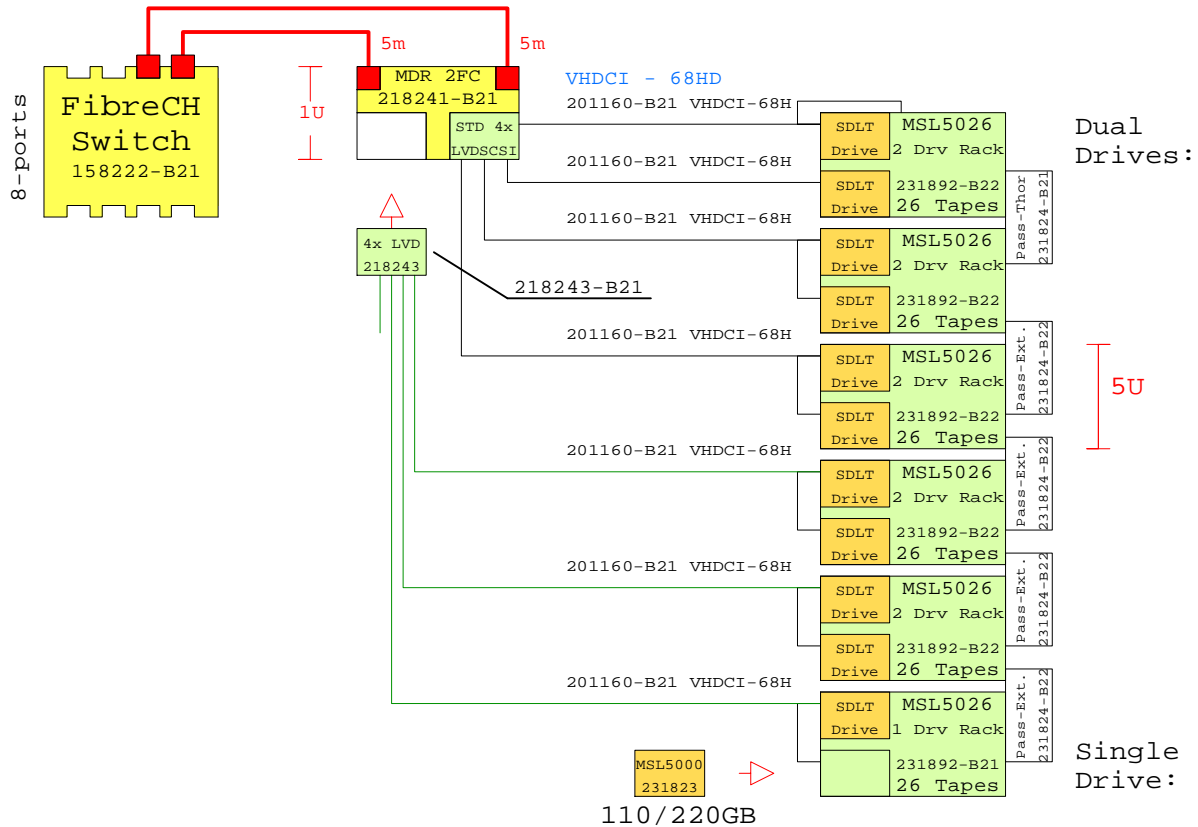

BOM of options on the left, Rack mount

Part Number	Qty	Description
3X-KZPCA-AA	1	Single channel LVD adapter
129803-B21	1	Dual CH UWD SCSI dapter LVD 2xVHD CI
158222-B21	1	SAN Switch 8 Ports
201160-B21	7	Ultra Cbl VHD CI - 68HD 10m
218241-B21	1	Mod. Data Router 2xFC,4xLVD,4xGBIG,2X5m
218243-B21	1	Mod. Data Router 4-port LVDscsi option
231823-B22	1	MSL5000 Add-on Drive SDLT110/220,LVD
231824-B21	1	MSL5026 Pass-Thorough Mechanism
231824-B22	4	MSL5026 Pass-Thorough Extender
231892-B21	1	MSL5026 SDLT Lib.1xDrive,RackM,LVD
231892-B22	5	MSL5026 SDLT Lib.2xDrive,RackM,LVD
328215-002	1	Wide Differential SCSI Cable Kit 10m
341177-B21	2	VHD CI to 68 pin SCSI Cable 12FT

BOM of options, TableTop

Part Number	Qty	Description
231822-B21	1	MSL5026 SDLT Lib.1xDrive,TableT,LVD
231822-B22	1	MSL5026 SDLT Lib.2xDrive,TableT,LVD
231838-B21	1	MSL5026 SDLT Lib.No Drive,TableT,LVD

www.Compaq.com/golden-eggs

Since:Apr-2001

COMPAQ	04-Apr-2001	GTMSL5026a
	Matti.Patari@Compaq.com	

MSL5026-SDLT Library
GOLDEN EGGS Visuals, Helsinki

This template is included in the present GOLDEN EGGS Software kit.

MSL5026

Stack of six (6) max.

Dual Drives:

Single Drive:

MSL5000 231823
110/220GB

Host adapters HVD

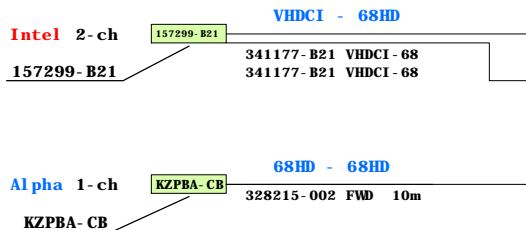

SCSI terms:

LVD Low Voltage Differential
 HVD High Voltage Differential
 VHDCI Very High Density Cable Interconnect
 68HD 68 pin High Density

Host adapters LVD

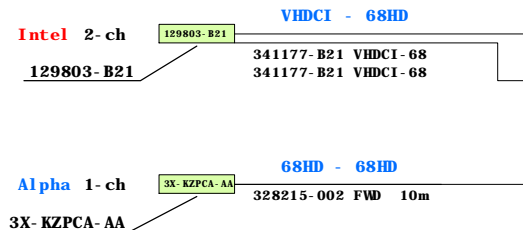

Modular Data Router 1FC HVD

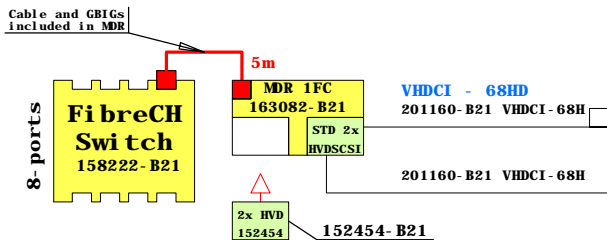

TL891 Mini Library, Rack HVD

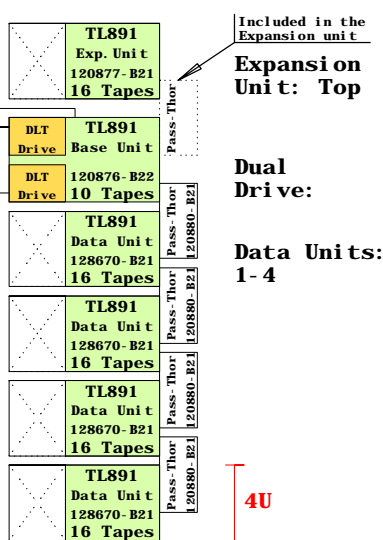

157215-021 C-kit, Eu

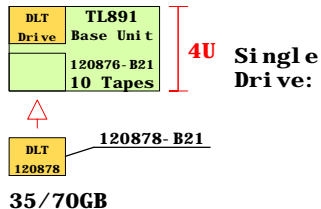

BOM of HVD options above, Rack mount

Part Number	Qty	Description
120876-B21	1	TL891 DLT Lib. 1xDrive, RackM, FWD
120876-B22	1	TL891 DLT Lib. 2xDrive, RackM, FWD
120877-B21	1	TL891 DLT Lib. Expansion Unit
120878-B21	1	TL891 Add-On 35/70 Drive
120880-B21	4	TL891 Pass-Thorough Mechanism Kit
128670-B21	4	TL891 DLT Lib. Data Unit
152454-B21	1	Mod. Data Router 2-port HVDscsi option
157215-021	1	Country Kit Europe for TL891 DLX
157299-B21	1	Dual CH UWD SCSI dapter HVD 2xVHDCI
158222-B21	1	SAN Switch 8 Ports
163082-B21	1	Mod. Data Router 1xFC, 2xHVD, 2xGBIG, 5m
201160-B21	2	Ultra Cbl VHDCI - 68HD 10m
328215-002	1	Wide Differential SCSI Cable Kit 10m
341177-B21	2	VHDCI to 68 pin SCSI Cable 12FT
KZPBA-CB	1	PCI to UltraSCSI Adapter UWif

BOM of HVD options, TableTop

Part Number	Qty	Description
120875-B21	1	TL891 DLT Lib. 1xDrive, TableT, FWD
120875-B22	1	TL891 DLT Lib. 2xDrive, TableT, FWD

This template is included in the present GOLDEN EGGS Software kit.

Modular Data Router 1FC LVD

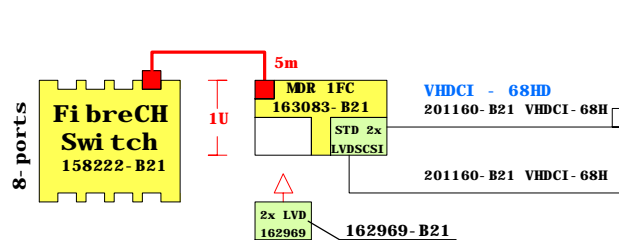

TL891DLX Mini Library, Rack LVD

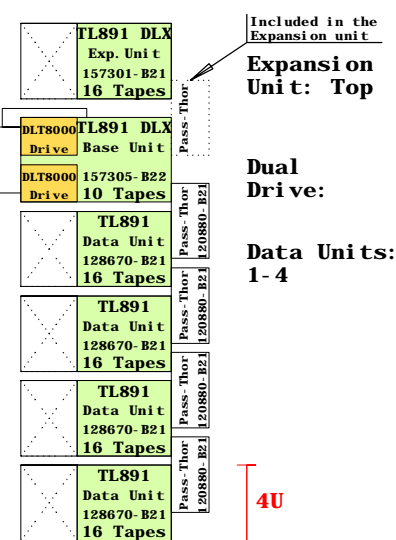

157215-021 C-kit, Eu

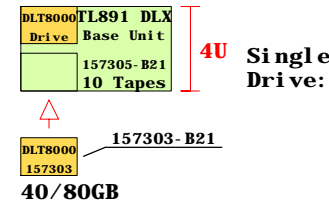

BOM of LVD options above, Rack mount

Part Number	Qty	Description
120880-B21	4	TL891 Pass-Thorough Mechanism Kit
128670-B21	4	TL891 DLT Lib. Data Unit
129803-B21	1	Dual CH UWD SCSI dapter LVD 2xVHDCI
157215-021	1	Country Kit Europe for TL891 DLX
157301-B21	1	TL891 DLX DLT Lib. Expansion Unit
157303-B21	1	TL891 DLX Add-On 40/80 Drive
157305-B21	1	TL891 DLX DLT Lib. 1xDrive, RackM, LVD
157305-B22	1	TL891 DLX DLT Lib. 2xDrive, RackM, LVD
158222-B21	1	SAN Switch 8 Ports
162969-B21	1	Mod. Data Router 2-port LVDscsi option
163083-B21	1	Mod. Data Router 1xFC, 2xLDV, 2xGBIG, 5m
201160-B21	2	Ultra Cbl VHDCI - 68HD 10m
328215-002	1	Wide Differential SCSI Cable Kit 10m
341177-B21	2	VHDCI to 68 pin SCSI Cable 12FT
3X-KZPCA-AA	1	Single channel LVD adapter

BOM of LVD options, TableTop

Part Number	Qty	Description
157300-B21	1	TL891 DLX DLT Lib. 1xDrive, TableT, LVD
157300-B22	1	TL891 DLX DLT Lib. 2xDrive, TableT, LVD

www.Compaq.com/golden-eggs

COMPAQ	30-Mar-2001	GTTL891a
		Matti.Patari@Compaq.com

TL891/DLX Mini-Library
 GOLDEN EGGS Visuals, Helsinki

TL891

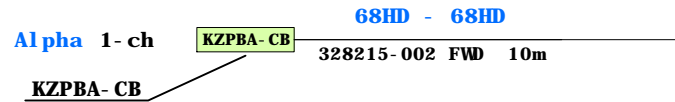
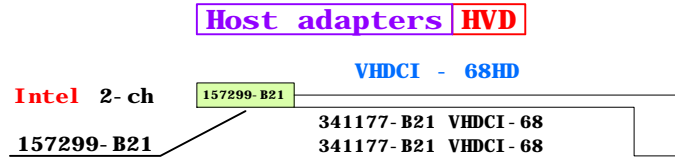

SCSI tems:

- LVD Low Voltage Differential
- HVD High Voltage Diffrential
- VHDCI Very High Density Cable Interconnect
- 68HD 68 pin High Density

BOM of options on the left

Part Number	Qty	Description
152454- B21	1	Mbd. Data Router 2- port HVDscsi option
157299- B21	1	Dual CH UWD SCSI dapter HVD 2xVHDCI
158222- B21	1	SAN Switch 8 Ports
163082- B21	1	Mbd. Data Router 1xFC, 2xHVD, 2xGBIG, 5m
201160- B21	2	Ultra Cbl VHDCI - 68HD 10m
218242- B21	1	Mbd. Data Router 4- port HVDscsi option
328215- 002	1	Wde Differential SCSI Cable Kit 10m
341177- B21	2	VHDCI to 68 pin SCSI Cable 12FT
349350- B23	1	TL895, 96- Slots, 3- Drive, DLT- Library
349351- B21	1	TL895 DLT 35/70 Drive Upgarde
349386- 021	1	Country Kit Europe for TL891 TL895
KZPBA- CB	1	PCI to UltraSCSI Adapter UWdif

Available TL895 DLT Libraries

Part Number	Qty	Description
349350- B22	1	TL895, 96- Slots, 2- Drive, DLT- Library
349350- B23	1	TL895, 96- Slots, 3- Drive, DLT- Library
349350- B24	1	TL895, 96- Slots, 4- Drive, DLT- Library
349350- B25	1	TL895, 96- Slots, 5- Drive, DLT- Library
349350- B26	1	TL895, 96- Slots, 6- Drive, DLT- Library
349350- B27	1	TL895, 96- Slots, 7- Drive, DLT- Library

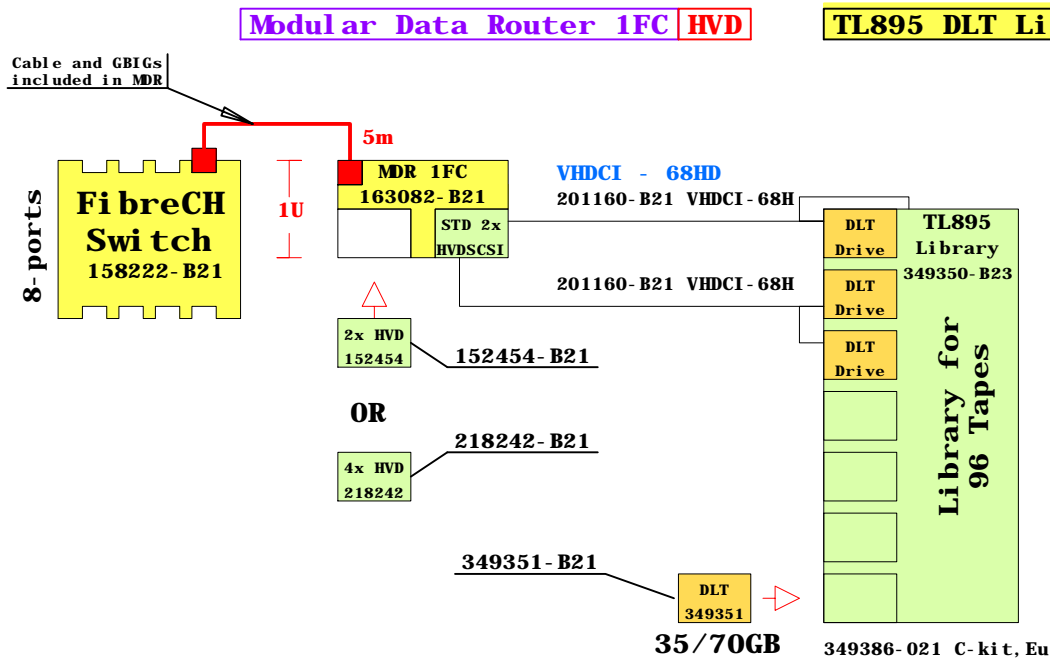

www.Compaq.com/golden-eggs

Since: Mar- 2001

COMPAQ	30- Mar- 2001	GTTL895a
	Matti. Patari@Compaq.com	

TL895 DLT Library
GOLDEN EGGS Visuals, Helsinki

TL895

This template is included in the present GOLDEN EGGS Software kit.

Host adapters LVD

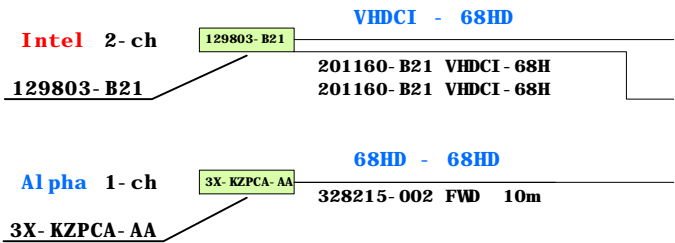

SCSI terms:

- LVD** Low Voltage Differential
- HVD** High Voltage Differential
- VHD CI** Very High Density Cable Interconnect
- 68HD** 68 pin High Density

Modular Data Router 1FC LVD

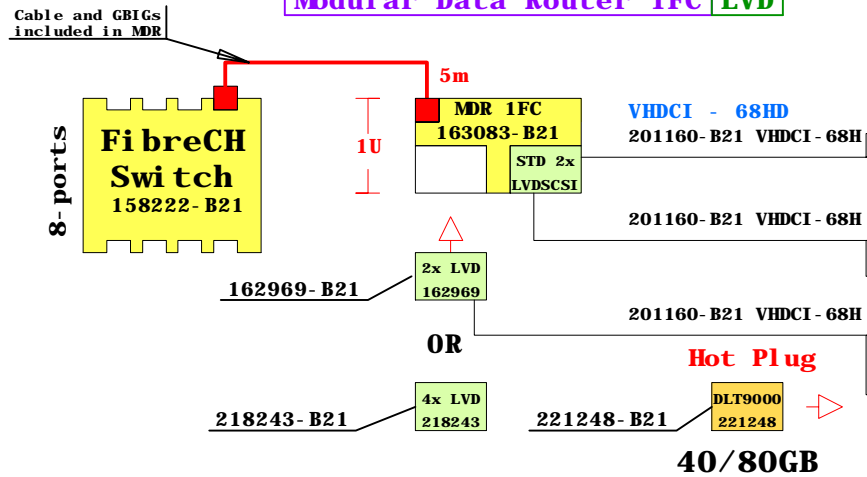

ESL9198DLX Enterprise Library LVD

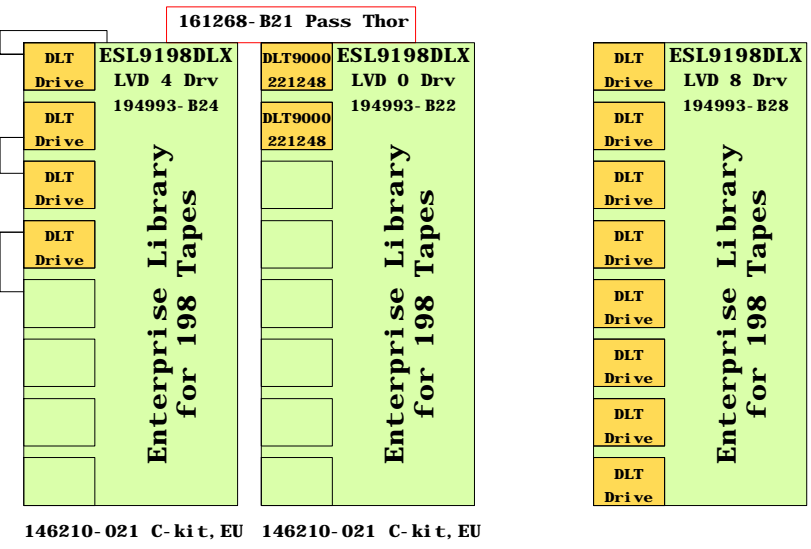

146210-021 C-kit, EU 146210-021 C-kit, EU

Max 5 tape libraries together

BOM of LVD options above

	Part Number	Qty	Description
1	194993-B21	1	ESL9198DLX 198-Slot, 0-Dr, DLT, LVD
1.1	221248-B21	2	ESL 9000 Hot-plug Drive 40/80GB LVD
2	194993-B24	1	ESL9198DLX 198-Slot, 4-Dr, DLT, LVD
3	194993-B28	1	ESL9198DLX 198-Slot, 8-Dr, DLT, LVD
4	158222-B21	1	SAN Switch 8 Ports
5	163083-B21	1	Mod. Data Router 1xFC, 2xLDV, 2xGBIG, 5m
6	161268-B21	1	ESL9000 Pass thorough mechanism kit
7	201160-B21	5	Ultra Cbl VHD CI - 68HD 10m
8	146210-021	2	ESL9000 Power Country Kit, Europe
9	328215-002	1	Wide Differential SCSI Cable Kit 10m
10	162969-B21	1	Mod. Data Router 2-port LVDscsi option
11	218243-B21	1	Mod. Data Router 4-port LVDscsi option
12	221248-B21	1	ESL 9000 Hot-plug Drive 40/80GB LVD
13	129803-B21	1	Dual CH UWD SCSI dapter LVD 2xVHD CI
14	3X-KZPCA-AA	1	Single channel LVD adapter

www.Compaq.com/golden-eggs

Since: Mar-2001

COMPAQ	30-Mar-2001	GTESL9198a
	Matti.Patari@Compaq.com	

This template is included in the present GOLDEN EGGS Software kit.

ESL9198

ESL9198DLX Enterprise Library
GOLDEN EGGS Visuals, Helsinki

Host adapters HVD

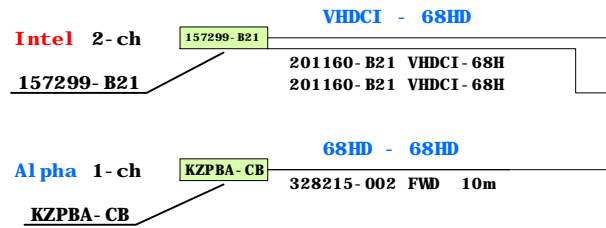

SCSI terms:

- LVD Low Voltage Differential
- HVD High Voltage Differential
- VHDCI Very High Density Cable Interconnect
- 68HD 68 pin High Density

Modular Data Router 2FC HVD

ESL9326DX Enterprise Library HVD

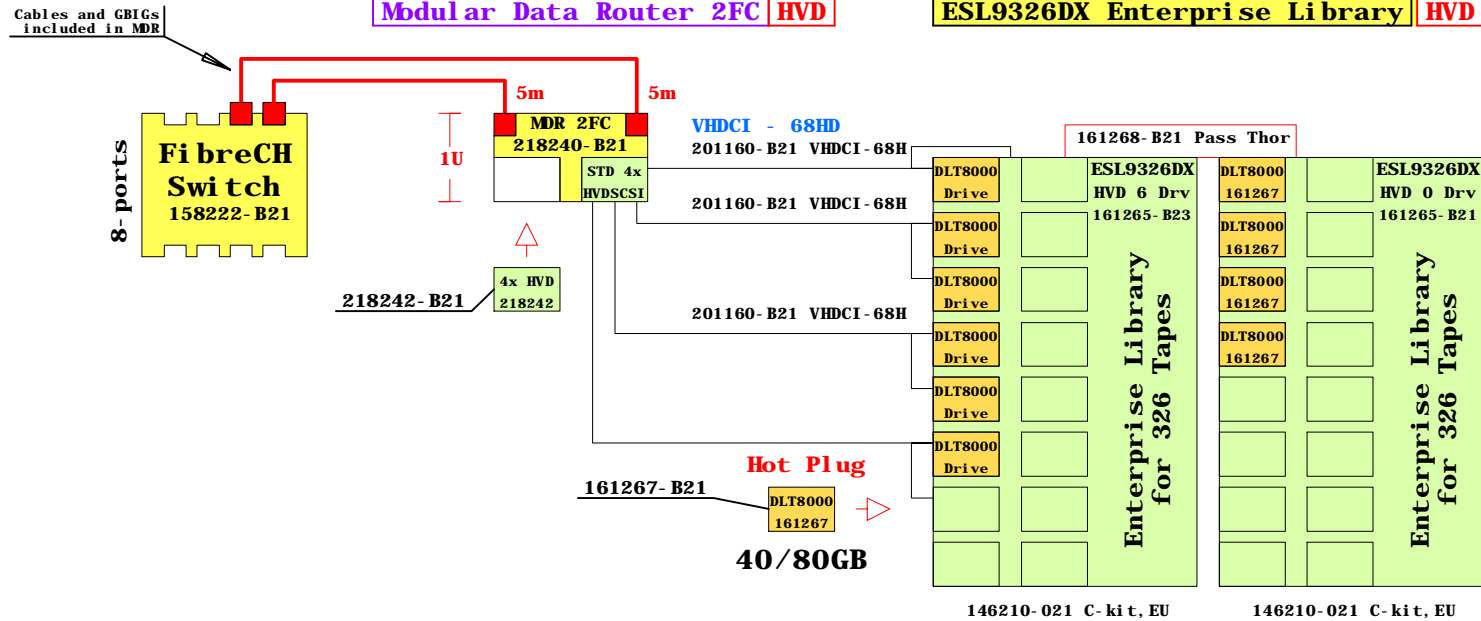

BOM of HVD options above

Part Number	Qty	Description
1	161265-B21	1 ESL9326DX Library 0 drives, 40/80GB HVD
1.1	161267-B21	4 ESL9326DX Add-on Drive 40/80GB HVD
2	161265-B23	1 ESL9326DX Library 6 drives, 40/80GB HVD
3	158222-B21	1 SAN Switch 8 Ports
4	218240-B21	1 Mod. Data Router 2xFC, 4xHVD, 4xCBIG, 2X5m
5	161268-B21	1 ESL9000 Pass thorough mechanism kit
6	201160-B21	5 Ultra Cbl VHDCI - 68HD 10m
7	328215-002	1 Wide Differential SCSI Cable Kit 10m
8	146210-021	2 ESL9000 Power Country Kit, Europe
9	161267-B21	1 ESL9326DX Add-on Drive 40/80GB HVD
10	218242-B21	1 Mod. Data Router 4-port HVDscsi option
11	157299-B21	1 Dual CH UWD SCSI dapter HVD 2xVHDCI
12	KZPBA-CB	1 PCI to UltraSCSI Adapter UWDif

Max 5 tape libraries together

Available ESL9326DX libraries

Part Number	Qty	Description
161265-B21	1	ESL9326DX Library 0 drives, 40/80GB HVD
161265-B23	1	ESL9326DX Library 6 drives, 40/80GB HVD
161265-B24	1	ESL9326DX Library 8 drives, 40/80GB HVD
161265-B25	1	ESL9326DX Library 10 drives, 40/80GB HVD
161265-B26	1	ESL9326DX Library 12 drives, 40/80GB HVD
161265-B27	1	ESL9326DX Library 14 drives, 40/80GB HVD
161265-B28	1	ESL9326DX Library 16 drives, 40/80GB HVD

www.Compaq.com/golden-eggs

COMPAQ

30-Mar-2001 GTESL9326a
Mattti.Patari@Compaq.com

ESL9326DX Enterprise Library
GOLDEN EGGS Visuals, Helsinki

This template is included in the present GOLDEN EGGS Software kit.

ESL9326

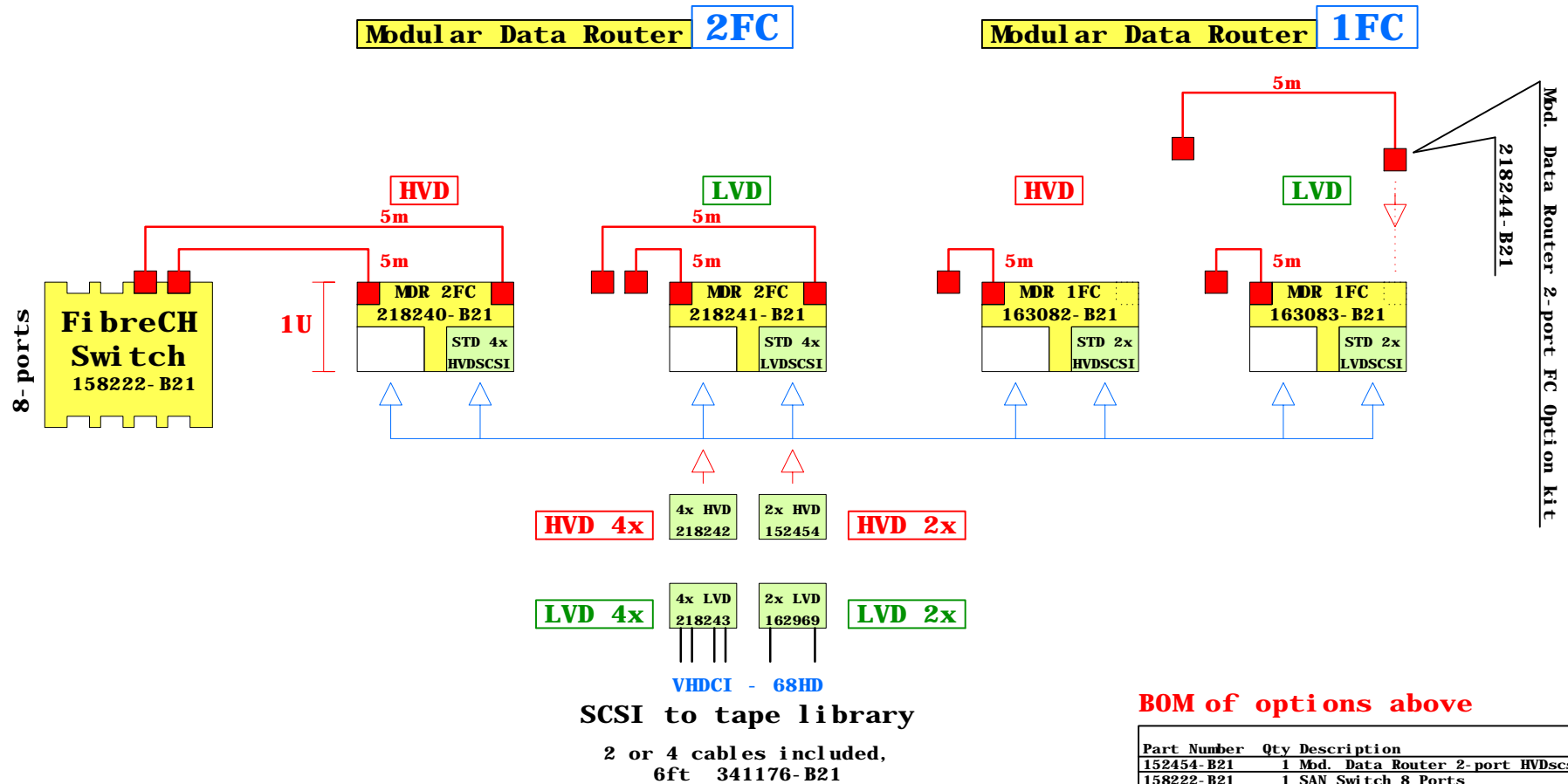

SCSI to tape library
 2 or 4 cables included,
 6ft 341176-B21

BOM of options above

Part Number	Qty	Description
152454-B21	1	Md. Data Router 2-port HVDscsi option
158222-B21	1	SAN Switch 8 Ports
162969-B21	1	Md. Data Router 2-port LVDscsi option
163082-B21	1	Md. Data Router 1xFC, 2xHVD, 2xGBIG, 5m
163083-B21	1	Md. Data Router 1xFC, 2xLDV, 2xGBIG, 5m
218240-B21	1	Md. Data Router 2xFC, 4xHVD, 4xGBIG, 2X5m
218241-B21	1	Md. Data Router 2xFC, 4xLVD, 4xGBIG, 2X5m
218242-B21	1	Md. Data Router 4-port HVDscsi option
218243-B21	1	Md. Data Router 4-port LVDscsi option
218244-B21	1	Md. Data Router 2-port FC Option kit

SCSI terms:

- LVD** Low Voltage Differential
- HVD** High Voltage Differential
- VHDCI** Very High Density Cable Interconnect
- 68HD** 68 pin High Density

This template is included in the present GOLDEN EGGS Software kit.



www.Compaq.com/golden-eggs
 Since: Mar-2001

COMPAQ	23-Mar-2001	GTMDR1
	Matti.Patari@Compaq.com	

**MDR Modular Data Router, FC
 GOLDEN EGGS Visuals, Helsinki**

Key to GOLDEN EGGS

Ethernet

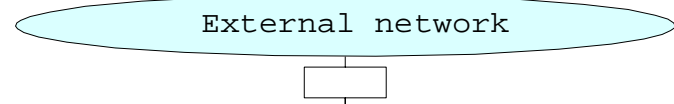

External site

Internal site

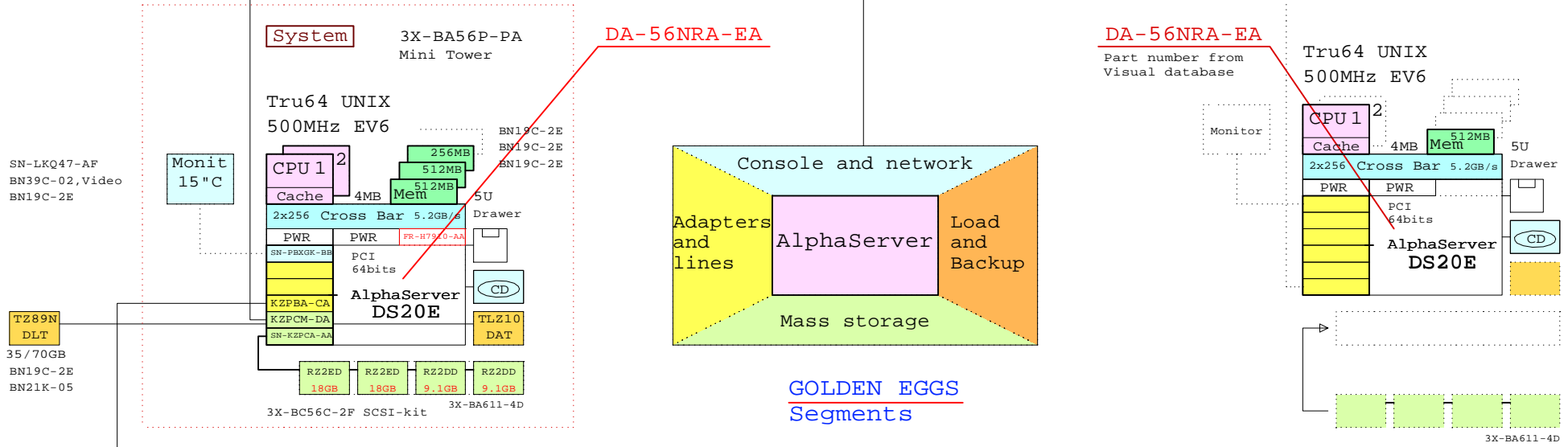

GOLDEN EGGS Segments

GOLDEN EGGS Presentation

Bill of material, BOM

Part Number	Qty	Description
1	1	3X-BA56P-PA DS20E Mini tower pedestal kit
1.1	1	3X-BC56C-2F DS20E SCSI Cable Kit
1.2	3	BN19C-2E PowerCable 240V, C-Europe
1.3	1	DA-56NRA-EA AS DS20E 6/500 512MB,Rack,UNIX
1.3.1	1	3R-VRQV5-24 COMPAQ V55 CLR MON,NH,TC095
1.3.2	1	3X-BA611-4D Disk Cage for DS20E, 4x disk
1.3.2.1	2	DS-RZ2DD-16 ES40 Disk 9.1GB 10k Ultra2 SCSI
1.3.2.2	2	DS-RZ2ED-16 ES40 Disk 18GB 10k Ultra2 SCSI
1.3.3	1	FR-H7910-AA Third power supply for DS20E
1.3.4	1	KN310-BB AS DS20E 6/500 SMP UPG UNIX
1.3.5	1	KZPBA-CA PCI to UltraSCSI Adapter UWSE
1.3.6	1	KZPCM-DA Dual Uscsi with FastEther PCI
1.3.7	1	MS340-CA DS20 256MB SDIMM MEM 4x64MB
1.3.8	1	MS340-DA DS20 512MB SDIMM MEM 4x128MB
1.3.9	1	SN-KZPCA-AA Single channel LVD adapter
1.3.10	1	SN-PBXGK-BB Elsa Gloria Synergy 8M Video Graphics
1.3.11	1	TLZ10-LB 12/24GB 4mm DAT 5.25" HH
2	1	DS-BA356-KF Pedestal Storage, UltraW, Single-Bus
2.1	2	BN19C-2E PowerCable 240V, C-Europe
2.2	1	BN38C-02 Ultra Cbl VHDCI - 68HD
2.3	1	CK-BA35X-HH 180W Stor.Shelf PWR for AS4x00
2.4	6	DS-RZ1ED-VW 18.2GB 10000r UltraSCSI disk
3	1	DS-TZ89N-TA 35/70GB SE DLT-tape TT FWSE
4	1	BN39C-02 1.8 Video Extension Cable ****
5	1	SN-LKQ47-AF 102 KEY KYBD, NON-WIN, Finnish
6	2	BN19C-2E PowerCable 240V, C-Europe
7	1	BN21K-05 68HD SCSI cable 5m

System kernel

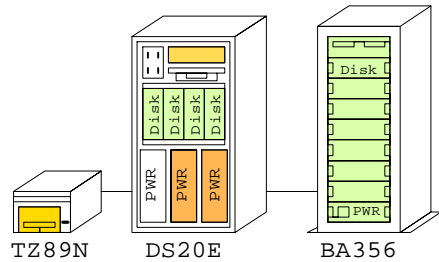

Internet pointer to GE-libray

Name of the page
 - GExxxx = GOLDEN EGGS page
 - GTxxxx = GOLDEN Template
 Templates are included in GOLDEN EGGS Software kit.

Date of update

COMPAQ	05-Apr-2001	GEG00B
www.compaq.com/golden-eggs		

KEY

To GOLDEN EGGS
 GOLDEN EGGS Visual Configurations, Helsinki

Ethernet

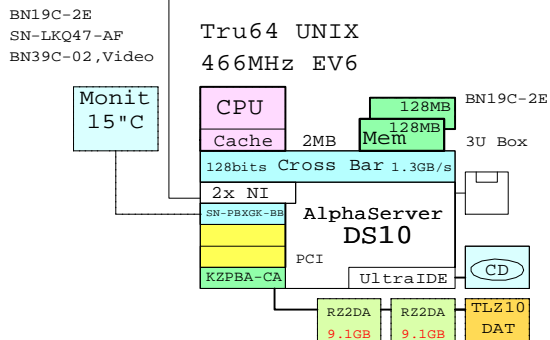

These visuals make this system.

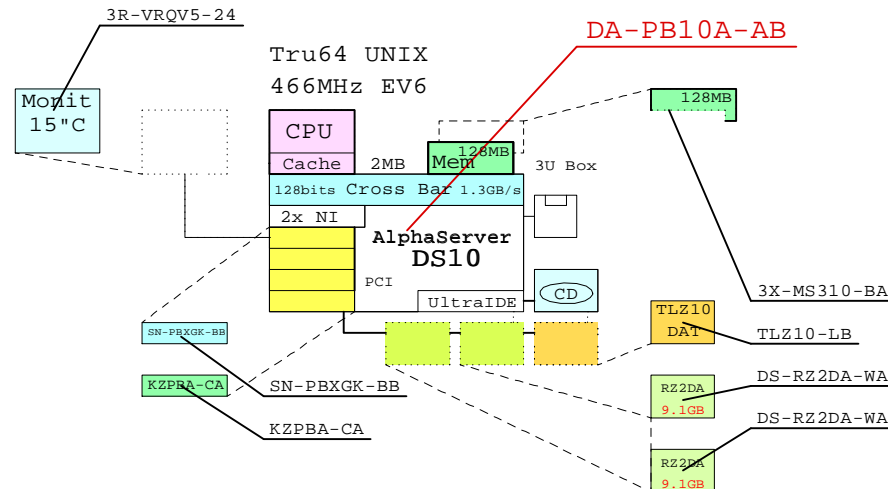

Bill of Material, no price

Part Number	Qty	Description
1	1	DA-PB10A-AB 1 AS DS10 6/466 128MB UNIX
1.1	1	3R-VRQV5-24 1 COMPAQ V55 CLR MON,NH,TCO95
1.2	1	3X-MS310-BA 1 DS10 128MB DIMM MEM
1.3	1	BN19C-2E 1 PowerCable 240V, C-Europe
1.4	1	BN39C-02 1 1.8 Video Extension Cable ****
1.5	2	DS-RZ2DA-WA 2 9.1GB 7200RPM UltraSCSI Disk
1.6	1	KZPBA-CA 1 PCI to UltraSCSI Adapter UWSE
1.7	1	SN-PBXGK-BB 1 Elsa Gloria Synergy 8M Video Graphics
1.8	1	TLZ10-LB 1 12/24GB 4mm DAT 5.25" HH
2	1	SN-LKQ47-AF 1 102 KEY KYBD, NON-WIN, Finnish
3	1	BN19C-2E 1 PowerCable 240V, C-Europe

Bill of Material with local currency, Fimk

GOLDEN EGGS
 Drawing: p_GEG00C
 Date: 1999-12-13 10:12:00
 Price file: GEFim071199.Dat

Bill of Material

Part Number	Qty	Description	E/U OEM	Price	Sub.tot
1	1	DA-PB10A-AB 1 AS DS10 6/466 128MB UNIX	X X	34150	34150
1.1	1	3R-VRQV5-24 1 COMPAQ V55 CLR MON,NH,TCO95	N A	2086	2086
1.2	1	3X-MS310-BA 1 DS10 128MB DIMM MEM	X X	4052	4052
1.3	1	BN19C-2E 1 PowerCable 240V, C-Europe	N R	58	58
1.4	1	BN39C-02 1 1.8 Video Extension Cable ****	X X	161	161
1.5	2	DS-RZ2DA-WA 2 9.1GB 7200RPM UltraSCSI Disk	Y M	2800	5600
1.6	1	KZPBA-CA 1 PCI to UltraSCSI Adapter UWSE	Y M	2732	2732
1.7	1	SN-PBXGK-BB 1 Elsa Gloria Synergy 8M Video Graphics	N A	1799	1799
1.8	1	TLZ10-LB 1 12/24GB 4mm DAT 5.25" HH	Y M	8300	8300
2	1	SN-LKQ47-AF 1 102 KEY KYBD, NON-WIN, Finnish	N A	154	154
3	1	BN19C-2E 1 PowerCable 240V, C-Europe	N R	58	58

Grand Total: 59150

System and options have been dragged from GOLDEN EGGS menu.

GOLDEN EGGS Software:

- This software runs on a normal office PC or LapTop.
- Tool for Compaq system designer and Sales.
- Rich Compaq product palette for Alpha and StorageWorks.
- Easy to use, just drag and drop.
- One picture talks thousands of words!
- Contains a rich set of ready made system templates.
- Bill of material, BOM, is pulled from the picture.
- Configuration pricing is available in local currency.

How to get GOLDEN EGGS Software:

Send your request to:

Matti.Patari@compaq.comm

COMPAQ	05-Apr-2001	GEG00C
	Matti.Patari@Compaq.com	
GOLDEN EGGS Software, 05-Apr-01		
GOLDEN EGGS Visuals, Helsinki		

GOLDEN EGGS

World Services

Alpha Examples

<http://www.compaq.com/golden-eggs>

GOLDEN EGGS

World Station

Software kits

<http://www.compaq.com/info/golden-eggs/software>

GOLDEN EGGS in eBusiness since 1988

COMPAQ

21-Jun-2000 GE-Internet

Matti.Patari@compaq.com

GOLDEN EGGS Internet Outlets
GOLDEN EGGS Visuals, Helsinki