

Print Colour and  
staple here.

Electric

# GOLDEN EGGS Colour

Visual Configurations

Rev: 14-Feb-2001

Main index for the next 94 pages:

- Upd --> - AlphaServer family DS10L..ES40..GS320  
- AlphaServer DS10L Unix,OpenVMS and Linux  
- AlphaServer DS10 Unix,OpenVMS and Linux  
- AlphaServer DS20E Unix,OpenVMS, and Linux  
- AlphaServer ES40 Unix,OpenVMS, and Linux  
- AlphaServer GS80 Unix,OpenVMS  
- AlphaServer GS160 Unix,OpenVMS  
- AlphaServer GS320 Unix,OpenVMS  
- StorageWorks EMA12000
- New --> - StorageWorks EMA16000  
- GE-KEY, GE-Software, GE in Internet

New/Updated since  
26-Oct-2000

More GE-pages at:  
[www.compaq.com/golden-eggs](http://www.compaq.com/golden-eggs)

For details, call:  
[Matti.Patari@compaq.com](mailto:Matti.Patari@compaq.com)

Painted with GOLDEN EGGS Software,  
Rev: 09-Feb-2001

**COMPAQ**

14-Feb-2001	GEG00D
<a href="mailto:Matti.Patari@Compaq.com">Matti.Patari@Compaq.com</a>	

GOLDEN EGGS in eBusiness since 1988 12 years.

Electric

Electric GOLDEN EGGS, Colour  
GOLDEN EGGS Visuals, Helsinki

1-CPU, 1xPCI

# AlphaServer Family Line

32-CPU, 223xPCI

DS10

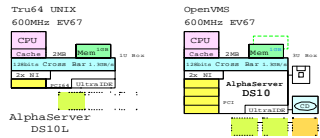

DS20E

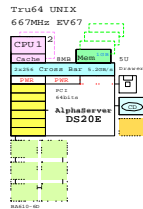

ES40

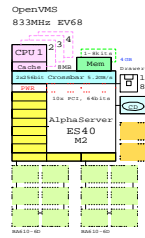

GS80

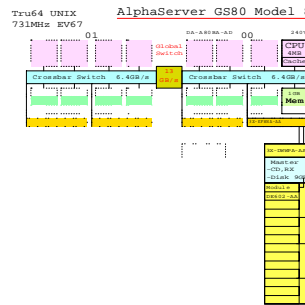

GS160

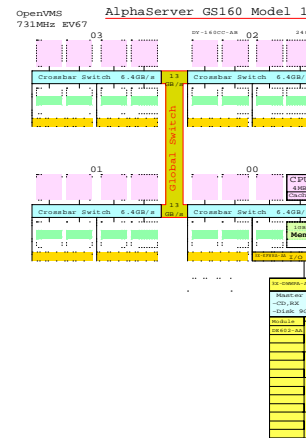

GS320

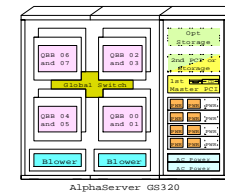
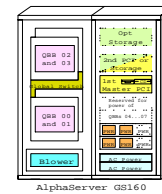
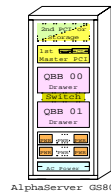
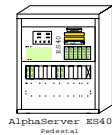
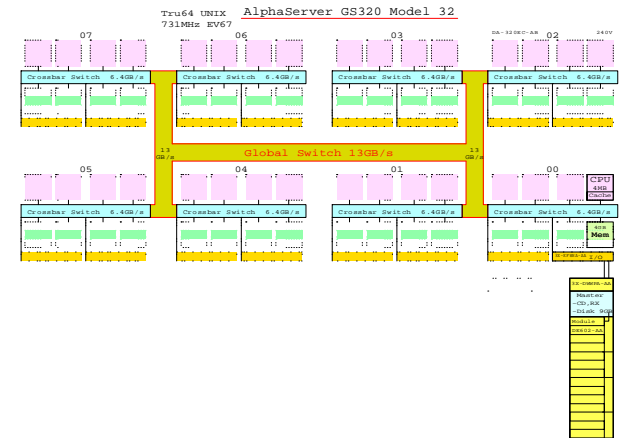

Operating systems:

- Tru64 UNIX
- OpenVMS
- Linux

One U

Cabinets..

GEO00M

More Alpha GOLDEN EGGS Examples in Web: [www.compaq.com/golden-eggs](http://www.compaq.com/golden-eggs)

# AlphaServer Family: DS10L - ES40

## DS10L

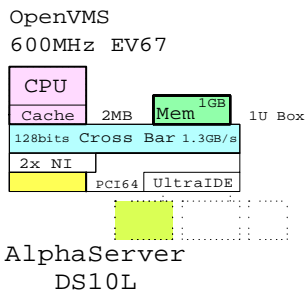

## DS10

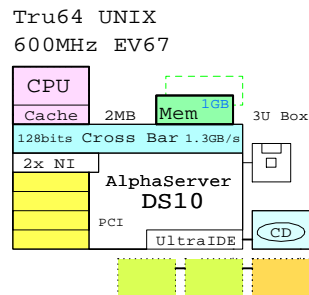

## DS20E

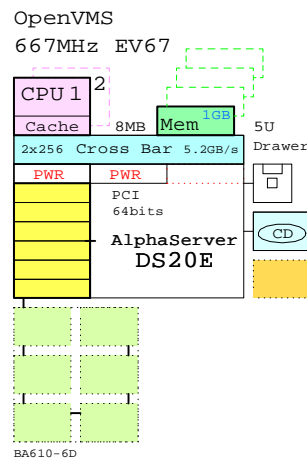

## ES40

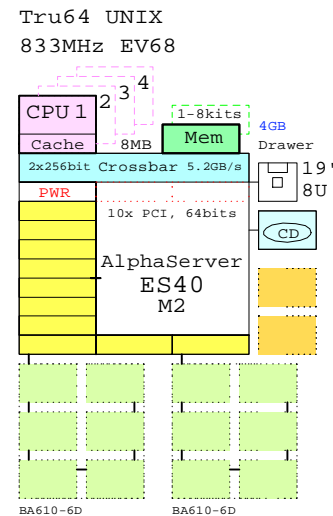

- Operating systems:
- Tru64 UNIX
  - OpenVMS
  - Linux

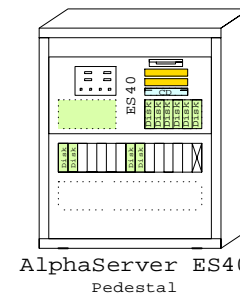
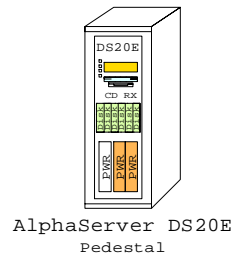
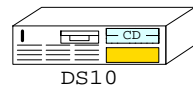

One U

Cabinets..

[www.Compaq.com/golden-eggs](http://www.Compaq.com/golden-eggs)  
Since Oct-2000

<b>COMPAQ</b>	09-Feb-2001	GEA00K
	Matti.Patari@Compaq.Com	
Compaq AlphaServer Family		
DS10L DS10 DS20E ES40		

# AlphaServer Family: GS80 - GS320

## GS80

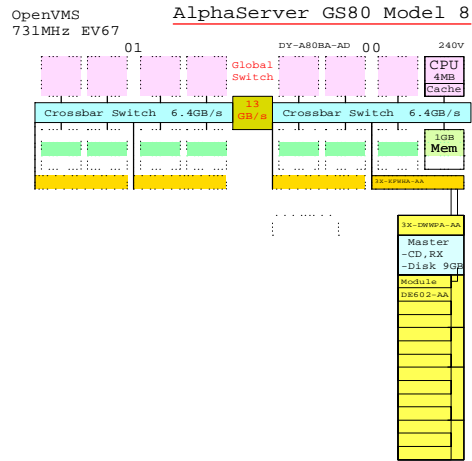

## GS160

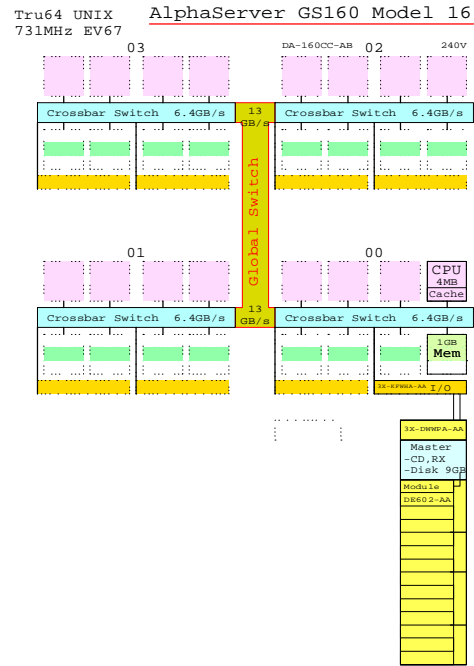

## GS320

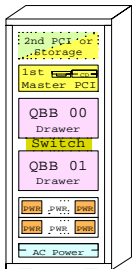

AlphaServer GS80

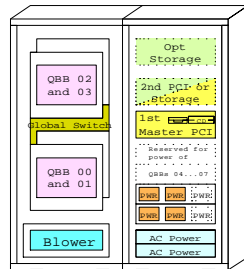

AlphaServer GS160

Operating systems:  
- Tru64 UNIX  
- OpenVMS

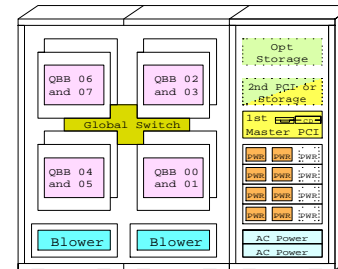

AlphaServer GS320

[www.Compaq.com/golden-eggs](http://www.Compaq.com/golden-eggs)

**COMPAQ** 09-Feb-2001 GEA00L  
Matt.I.Patazi@Compaq.Com

Compaq AlphaServer Family  
GS80 GS160 and GS320

# AlphaServer DS10, DS20 and ES40 Family

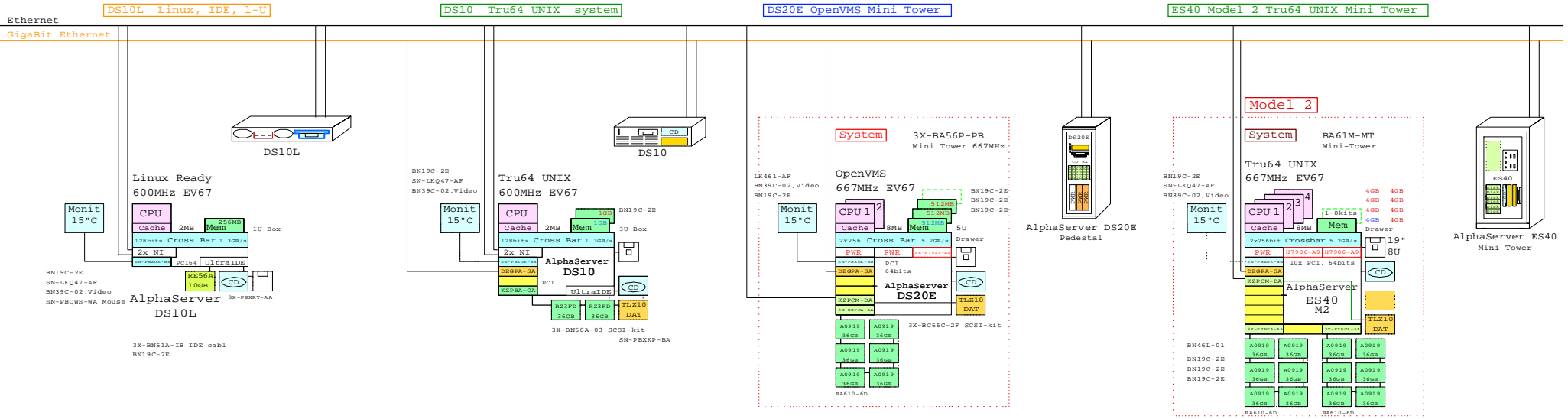

### Bill of material

Part Number	Qty	Description
DI-718AA-DA	1	AS DS10L 67/600 256MB Linux Ready
3X-PB8F-AA	1	Diskette/ 24k CD-ROM Combo
3X-R35A-BA	1	DS10 10GB 7200 IDE-disk Drive 1"
SN-PB2K-BB	1	Elsa Gloria Synergy 8M Video Graphics
3X-VB0V-24	1	COMPAQ V55 CLR MON.NH.TC095
3X-BN1A-1B	1	One Drop DS10L IDE cable
SN-PB0W-WA	1	Standard Compaq opal mouse
BN19C-02	1	1.8 Video Extension Cable ****
SN-LK047-AF	1	102 KEY KYBD.NON-WIN, Finnish
BN19C-2E	2	PowerCable 240V, C-Europe

### Bill of material

Part Number	Qty	Description
DA-73BAA-FA	1	AS DS10 67/600 1GB UNIX
3X-VB0V-24	1	COMPAQ V55 CLR MON.NH.TC095
3X-R3510-BA	1	DS10 1GB DIMM MEM
BN19C-2E	1	PowerCable 240V, C-Europe
BN19C-02	1	1.8 Video Extension Cable ****
DGCPA-DA	1	PCI to GigabitEthernet 8X Adap
DS-R23PD-WA	2	36.4GB 10KRPM Ultra3 SCSI Disk
K2PDA-CA	1	PCI to UltraSCSI Adapter UMSB
SN-PB2K-BB	1	Elsa Gloria Synergy 8M Video Graphics
TL210-LB	1	12/24GB 4mm DAT 5.25" HB
3X-RB5A-03	1	SCSI cable Kit, L&D, 3X Disk
SN-LK047-AF	1	102 KEY KYBD.NON-WIN, Finnish
SN-PB2K-BB	1	WIDE TO NARROW SCSI ADAPTER
BN19C-2E	1	PowerCable 240V, C-Europe

### Bill of material

Part Number	Qty	Description
3X-BA56P-PB	1	DS20E Mini tower pedestal kit,667MHz
3R-A2832-AA	1	COMPAQ Monitor S510 15" NH, EU
BN19C-02	4	PowerCable 240V, C-Europe
DY-56PAA-EA	1	AS DS20E 6/667 512MB Rack OVMS
3X-BC56C-2F	1	DS20E SCSI Cable Kit
3X-K2PDA-AA	1	Single channel LVD adapter
RM510-10	1	RS40 Disk Drive Cage, 6-Bay
3R-AD919-AA	6	36.4GB Ucsd19 10K Universal disk 1"
DGCPA-DA	1	PCI to GigabitEthernet 8X Adap
FR-87810-AA	1	75W power supply for DS20E
KN311-BC	1	AS DS20E 6/667 SMP UFD OpenVMS
MS340-DA	2	DS20 512MB SDRAM MEM 4x128MB
SN-PB2K-BB	1	Elsa Gloria Synergy 8M Video Graphics
TL210-LB	1	12/24GB 4mm DAT 5.25" HB
LK461-AF	1	VMS STYLE KEYBOARD, Pin/Swd

### Bill of material, Model 2

Part Number	Qty	Description
BA61M-MT	1	ES40 Mini-Tower Enclosure
BN19C-2E	1	PowerCable 240V, C-Europe
DA-64BAA-FA	1	ES40 67/667 Model 2 4GB UNIX 10PCI DMR
3R-VB0V-24	1	COMPAQ V55 CLR MON.NH.TC095
3X-K2PDA-AA	2	Single channel LVD adapter
BA610-6D	1	ES40 Disk Drive Cage, 6-Bay
3R-AD919-AA	6	36.4GB Ucsd19 10K Universal disk 1"
BA610-6D	1	ES40 Disk Drive Cage, 6-Bay
3R-AD919-AA	6	36.4GB Ucsd19 10K Universal disk 1"
BN19C-2E	1	PowerCable 240V, C-Europe
BN19C-02	1	1.8 Video Extension Cable ****
BN461-01	1	Multi head SCSI cable, ES40
DGCPA-DA	1	PCI to GigabitEthernet 8X Adap
R7906-AS	2	ES40 Power Supply, 2nd or 3rd
RN610-BB	3	ES40 6/667MHz UNIX SMP 8mb cache
K2PDA-CA	1	Dual Channel LVD Adapter PCI
MS10-FA	1	ES40 4GB Memory Option
SN-PB2K-BB	1	Elsa Gloria Synergy 8M Video Graphics
TL210-LB	1	12/24GB 4mm DAT 5.25" HB
SN-LK047-AF	1	102 KEY KYBD.NON-WIN, Finnish

[www.Compaq.com/golden-eggs](http://www.Compaq.com/golden-eggs)

**COMPAQ** 09-Feb-2001 GEA00Ka  
Matti.Pataria@Compaq.Com

Compaq AlphaServer Family  
DS10L DS10 DS20E ES40

# AlphaServer DS10L 67/600 Systems

## Server systems, 64bits 600MHz

Memory	Tru64 UNIX	OpenVMS	Linux ready
256MB	DA-71BAA-DA	DY-71BAA-DA	DJ-71BAA-DA
512MB	DA-71BAA-EA	DY-71BAA-EA	DJ-71BAA-EA
1GB	DA-71BAA-FA	DY-71BAA-FA	DJ-71BAA-FA

## Disk storage

IDE Disk	IDE
3X-RE56A-BA	10GB 7200r IDE drive
3X-RE57A-BA	30GB 7200r IDE drive
3X-BN51A-IB	One drop IDE cable, 1-2x
SCSI Disk	SCSI
DS-RZ1DD-WA	9.1GB 10k Ultra3 drive
DS-RZ3EF-WA	18GB 10k Ultra3 drive
DS-RZ3FD-WA	36GB 10k Ultra3 drive
3X-BN50A-05	One drop SCSI cable, 0-1x
3X-BN50A-02	Two drop SCSI cable, 0-1x

KZPBA-CA	UltraSCSI SE adapter
KZPAC-AA	UltraSCSI RAID adapter
3X-DEPVZ-AA	1 Ultra2, 2D Grap, Ether.
3X-DEPVD-AA	Permedia P2, Ethernet

## Load device

3X-PBXRY-AA	CD and Diskette combo
-------------	-----------------------

## Cabinet shelf kits

3X-PBX01-BE	Rack kit Single
3X-PBX01-BD	Rack kit Quad

## Memory swap, max memory =1GB

3X-MS310-DA	512MB
3X-MS310-EA	1GB

## Power cords

BN19C-2E	Europe
BN19A-2E	GB
BN19E-2E	CH
BN19K-2E	DK
BN19M-2E	I

SN-PBQWS-WA	Compaq mouse
-------------	--------------

Generated with fresh GOLDEN EGGS Software, Rev:20-Sep-2000

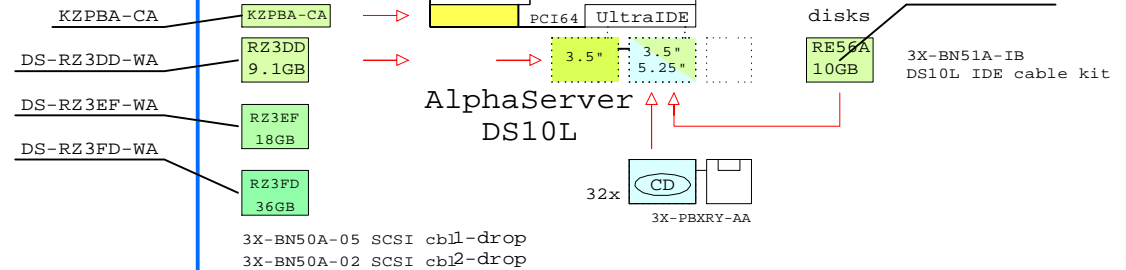

- Mouse
- Kb
- Com1
- Com2
- Parallel
- RMC

## Mandatory options:

- System Disk, IDE or SCSI
- Drop cable

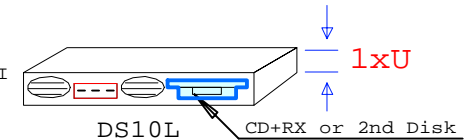

## Licenses included:

- Tru64 UNIX V4.0F, Base license, 2-user Base license, Server Extension license, and Internet Access Software license and Netscape's Enterprise Server.

OpenVMS V7.2-1, Base license and DIGITAL Enterprise Integration Package.

	@600MHz	@466MHz
SPECint95	35	24
SPECfp95	56	47

Software Processor Code: E

<b>COMPAQ</b>	19-Dec-2000	GEADS10L2
	Matti.Patari@compaq.com	

AlphaServer DS10L 600MHz Syst.  
GOLDEN EGGS Visuals, Helsinki

Since: Oct-2000  
[www.Compaq.com/golden-eggs](http://www.Compaq.com/golden-eggs) **DS10L**

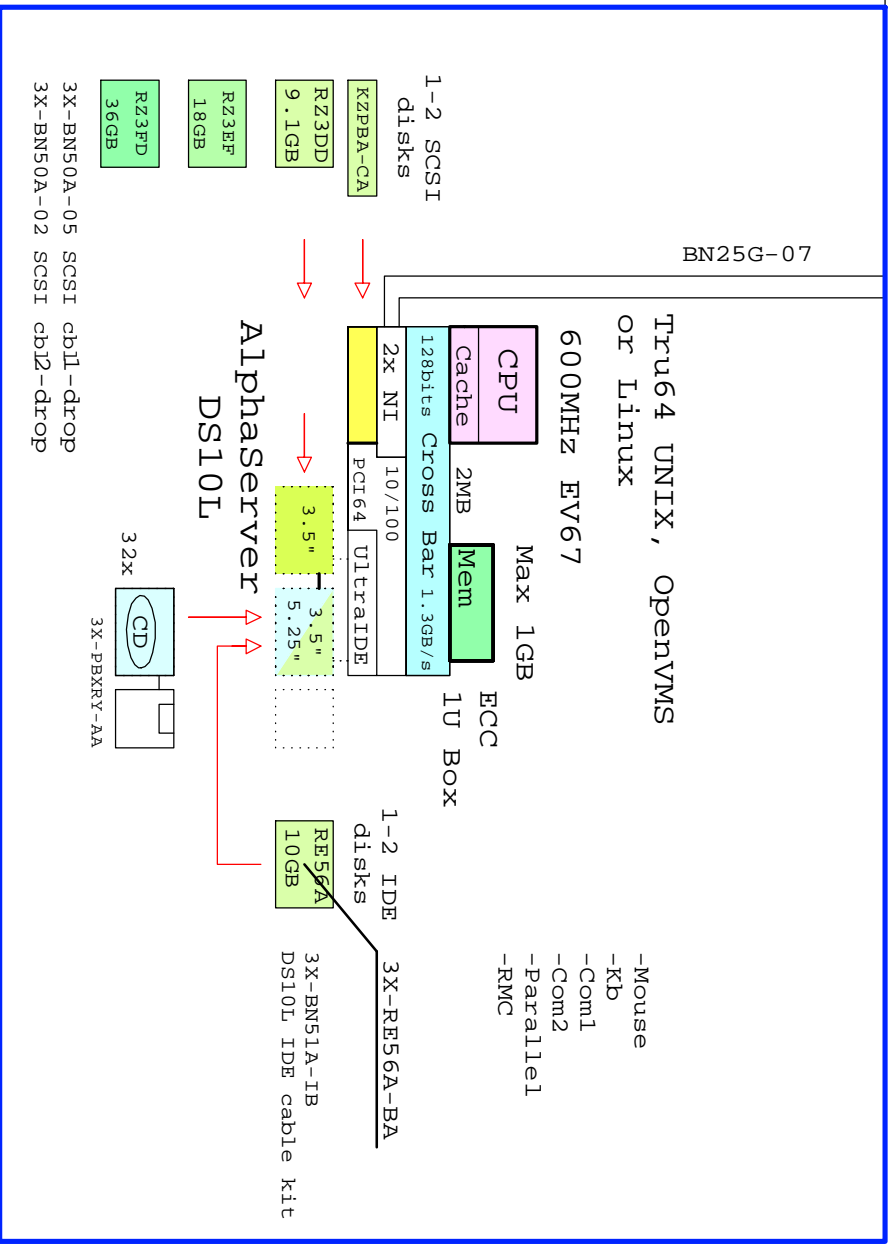

**Mandatory options:**

- System Disk, IDE or SCSI
- Drop cable

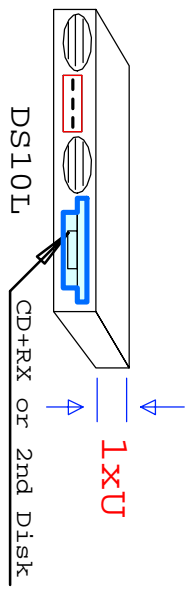

Licenses included:

- Tru64 UNIX V4.0F, Base license, 2-user Base license, Server Extension license, and Internet Access Software license and Netscape's Enterprise Server.

OpenVMS V7.2-1, Base license and DIGITAL Enterprise Integration Package.

	@600MHz	@466MHz
SPECint95	35	24
SPECfp95	56	47

Software Processor Code: **E**

<b>COMPAQ</b>	
19-Dec-2000	GEADS10L2
Matti.Patarri@compaq.com	

AlphaServer DS10L 600MHz Syst.  
GOLDEN EGGS Visuals, Helsinki

# DS10L

BN25G-07

Tru64 UNIX, OpenVMS  
or Linux

600MHz EV67

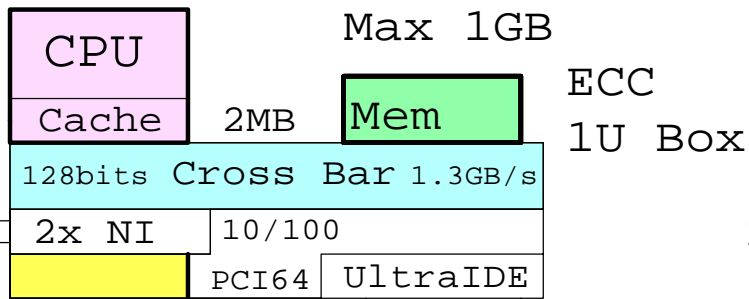

- Mouse
- Kb
- Com1
- Com2
- Parallel
- RMC

1-2 SCSI  
disks

- KZPBA-CA
- RZ3DD  
9.1GB
- RZ3EF  
18GB
- RZ3FD  
36GB

3X-BN50A-05 SCSI cb1-drop  
3X-BN50A-02 SCSI cb2-drop

1-2 IDE  
disks

- RE56A  
10GB

3X-RE56A-BA  
3X-BN51A-IB  
DS10L IDE cable kit

AlphaServer  
DS10L

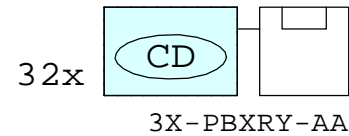



Ethernet  
Ethernet

DS10L UNIX with External SCSI RAID

Tru64 UNIX  
600MHz EV67

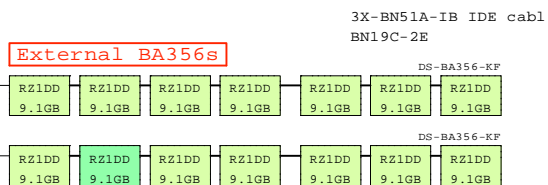
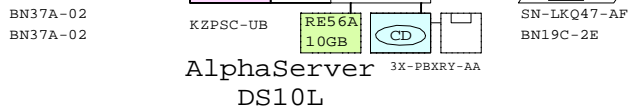
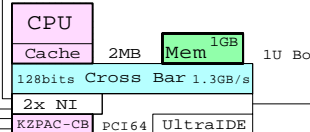

BN19C-2E  
BN19C-2E

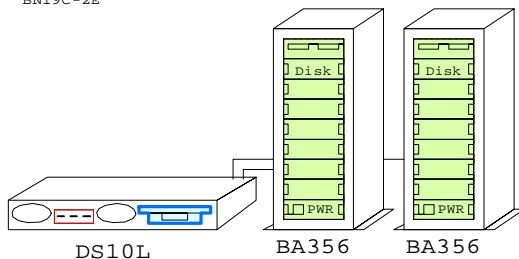

DS10L UNIX, SCSI, One-box

Tru64 UNIX  
600MHz EV67

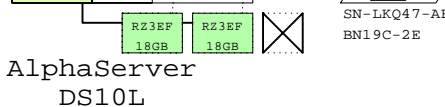
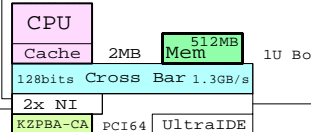

3X-BN50A-02 SCSI cbl  
BN19C-2E

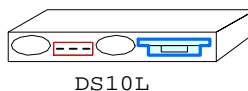

DS10L UNIX, IDE, One-box

Tru64 UNIX  
600MHz EV67

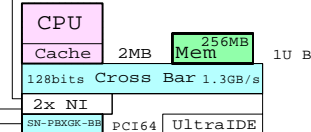

3X-BN51A-IB IDE cabl  
BN19C-2E



Bill of material

	Part Number	Qty	Description
	DA-71BAA-EA	1	AS DS10L 67/600 512MB UNIX
1	DA-71BAA-EA	1	AS DS10L 67/600 512MB UNIX
1.1	DS-RZ3EF-WA	2	18.2GB 10krRPM Ultra3 SCSI Disk
1.2	KZPBA-CA	1	PCI to UltraSCSI Adapter UWSE
2	VT510-A4	1	Text Terminal WH Intl No-hemi
3	3X-BN50A-02	1	Two drop SCSI cable, LED
4	SN-LKQ47-AF	1	102 KEY KYBD, NON-WIN, Finnish
5	BN19C-2E	2	PowerCable 240V, C-Europe

Bill of material

	Part Number	Qty	Description
1	DA-71BAA-FA	1	AS DS10L 67/600 1GB UNIX
1.1	3X-PBXRY-AA	1	Diskette/ 24x CD-ROM Combo
1.2	3X-RE56A-BA	1	DS10 10GB 7200 IDE-disk drive 1"
1.3	KZPAC-CB	1	3 Chan. SCSI RAID 8MB UltraW
1.4	KZPSC-UB	1	Battery Backup for KZPSC
2	DS-BA356-KF	1	Pedestal Storage, UltraW, Single-Bus
2.1	DS-RZ1DD-VW	7	9.1GB 10000r UltraSCSI disk
3	DS-BA356-KF	1	Pedestal Storage, UltraW, Single-Bus
3.1	DS-RZ1DD-VW	7	9.1GB 10000r UltraSCSI disk
4	VT510-A4	1	Text Terminal WH Intl No-hemi
5	3X-BN51A-IB	1	One drop DS10L IDE cable
6	SN-LKQ47-AF	1	102 KEY KYBD, NON-WIN, Finnish
7	BN19C-2E	4	PowerCable 240V, C-Europe
8	BN37A-02	2	Ultra Cbl VHDCI - VHDCI

Bill of material

	Part Number	Qty	Description
1	DA-71BAA-DA	1	AS DS10L 67/600 256MB UNIX
1.1	3X-PBXRY-AA	1	Diskette/ 24x CD-ROM Combo
1.2	3X-RE56A-BA	1	DS10 10GB 7200 IDE-disk drive 1"
1.3	SN-PBXGK-BB	1	Elsa Gloria Synergy 8M Video Graphics
2	3R-VRQV5-24	1	COMPAQ V55 CLR MON,NH,TCO95
3	3X-BN51A-IB	1	One drop DS10L IDE cable
4	SN-PBQWS-WA	1	Standard Compaq opal mouse
5	BN39C-02	1	1.8 Video Extension Cable ****
6	SN-LKQ47-AF	1	102 KEY KYBD, NON-WIN, Finnish
7	BN19C-2E	2	PowerCable 240V, C-Europe

[www.Compaq.com/golden-eggs](http://www.Compaq.com/golden-eggs)  
Since:Oct-2000

This template is included in the present GOLDEN EGGS Software kit.

DS10L UNIX

<b>COMPAQ</b>	06-Feb-2001	GTAUDS10L3
	Matti.Patari@Compaq.com	
AlphaServer DS10L UNIX systems		
GOLDEN EGGS Visuals, Helsinki		

**DS10L UNIX Cluster with in-cabinet RAID storage**

Ethernet  
Ethernet

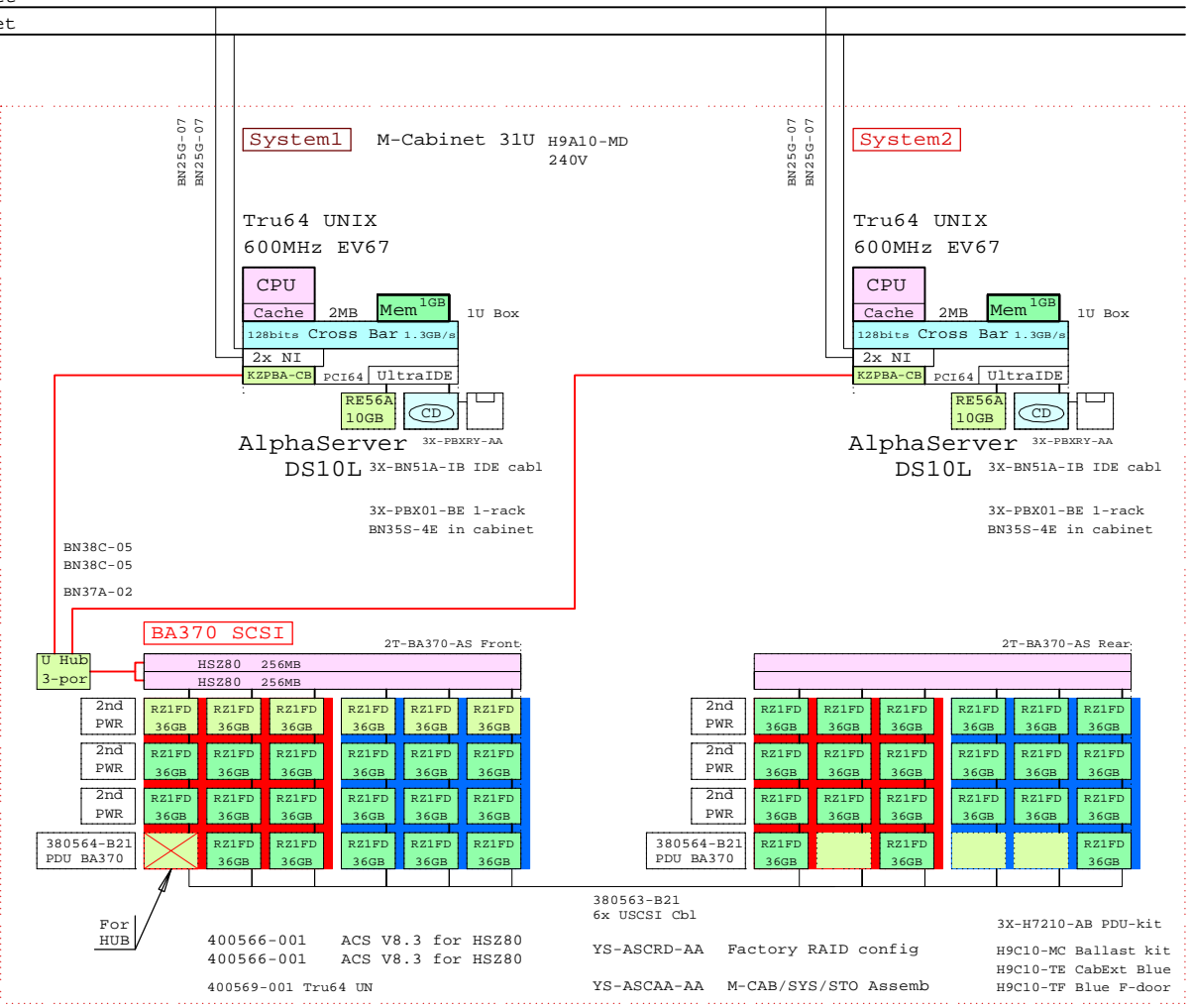

BOM for this cabinet system

Part Number	Qty	Description
H9A10-MD	1	M-Series Cab,H9A10,Blue,240V 31U
1.1	2T-BA370-AR	1 BA370 shelf,slides Rear RackMount
1.1.1	380564-B21	1 Power Distribution Unit RA8k/7k
1.1.2	380565-B21	3 Power Suply 180W Hot Plug SBB
1.1.3	DS-RZ1FD-VW	21 36GB 10000r UltraSCSI Disk
1.2	2T-BA370-AS	1 BA370 shelf,slides Front RackMount
1.2.1	380564-B21	1 Power Distribution Unit RA8k/7k
1.2.2	380565-B21	3 Power Suply 180W Hot Plug SBB
1.2.3	400565-B21	2 Ultra Opt.1 cont w 2x128MB cache HSZ80
1.2.4	DS-DWZ2H-03	1 Uscsi Act hub 0 SE:3/Dif 3.5" SBB
1.2.5	DS-RZ1FD-VW	23 36GB 10000r UltraSCSI Disk
1.3	380563-B21	1 Set of six USCSI cables
1.4	3X-H7210-AB	1 PDU Fan Cable mgt kit Europe
1.5	3X-PBX01-BB	2
1.6	400566-001	2 HSZ80 Controller Software ACS V8.3
1.7	400569-001	1 Ultra opt OS Software Tru64 UNIX
1.8	BN25G-07	4 17-03212-05 8MP-8MP PATCH CBL
1.9	BN35S-4E	2 PowerCord C13 to C14, Non US
1.10	BN37A-02	1 Ultra Cbl VHDCI - VHDCI
1.11	BN38C-05	2 Ultra Cbl VHDCI - 68HD
1.12	DA-71BAA-FA	1 AS DS10L 67/600 1GB UNIX
1.12.1	3X-BN51A-IB	1 One drop DS10L IDE cable
1.12.2	3X-PBXRY-AA	1 Diskette/ 24x CD-ROM Combo
1.12.3	3X-RE56A-BA	1 DS10 10GB 7200 IDE-disk drive 1"
1.12.4	KZPBA-CB	1 PCI to UltraSCSI Adapter UWdif
1.13	DA-71BAA-FA	1 AS DS10L 67/600 1GB UNIX
1.13.1	3X-BN51A-IB	1 One drop DS10L IDE cable
1.13.2	3X-PBXRY-AA	1 Diskette/ 24x CD-ROM Combo
1.13.3	3X-RE56A-BA	1 DS10 10GB 7200 IDE-disk drive 1"
1.13.4	KZPBA-CB	1 PCI to UltraSCSI Adapter UWdif
1.14	H9C10-MC	1 Ballast Kit for cabinets
1.15	H9C10-TE	1 Rear cab extender for H9A10 Blue
1.16	H9C10-TF	1 FrontDoorKit Blue for H9A10
1.17	YS-ASCAA-AA	1 M-CAB/SYS/STO Assembly
1.18	YS-ASCRD-AA	1 Factory configured RAID sets of BA370

www.Compaq.com/golden-eggs  
Since:Oct-2000

<b>COMPAQ</b>	08-Nov-2000	GTAUDS10L4
	Matti.Patari@Compaq.com	

AlphaServer DS10L UNIX Cluster  
GOLDEN EGGS Visuals, Helsinki

This template is included in the present GOLDEN EGGS Software kit.

**DS10L UNIX**

Ethernet  
Ethernet

DS10L OpenVMS with External SCSI RAID

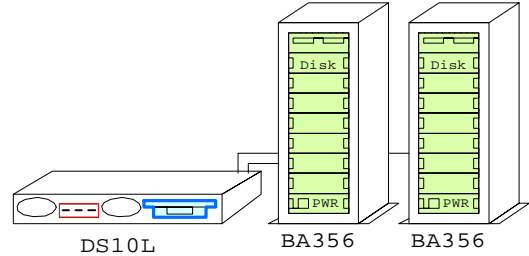
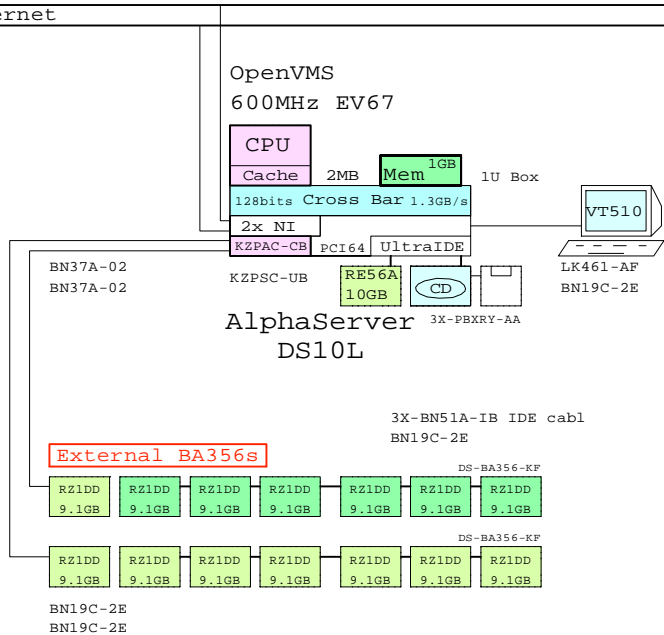

DS10L OpenVMS, SCSI, One-box

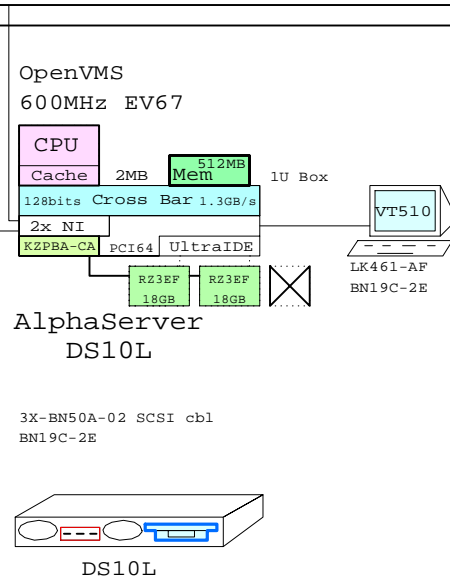

Bill of material

Part Number	Qty	Description
1	1	DY-71BAA-EA 1 AS DS10L 67/600 512MB OpenVMS
1.1	2	DS-RZ3EF-WA 2 18.2GB 10krRPM Ultra3 SCSI Disk
1.2	1	KZPBA-CA 1 PCI to UltraSCSI Adapter UWSE
2	1	VT510-A4 1 Text Terminal WH Intl No-hemi
3	1	3X-BN50A-02 1 Two drop SCSI cable, LED
4	2	BN19C-2E 2 PowerCable 240V, C-Europe
5	1	LK461-AF 1 VMS STYLE KEYBOARD, Fin/Swed

DS10L OpenVMS, IDE, One-box

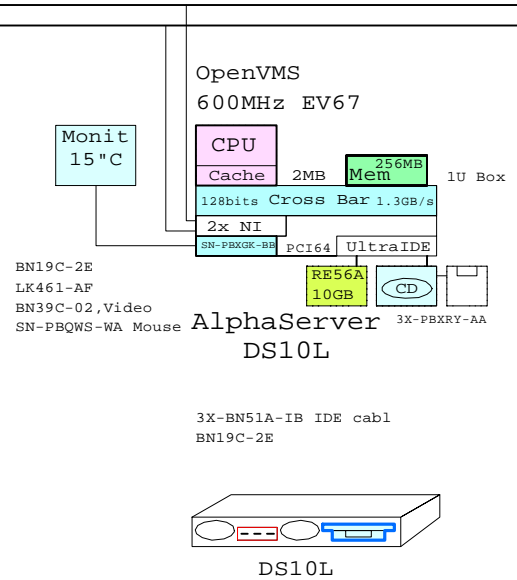

Bill of material

Part Number	Qty	Description
1	1	DY-71BAA-FA 1 AS DS10L 67/600 1GB OpenVMS
1.1	1	3X-PBXRY-AA 1 Diskette/ 24x CD-ROM Combo
1.2	1	3X-RE56A-BA 1 DS10 10GB 7200 IDE-disk drive 1"
1.3	1	KZPAC-CB 1 3 Chan. SCSI RAID 8MB UltraW
1.4	1	KZPSC-UB 1 Battery Backup for KZPSC
2	1	DS-BA356-KF 1 Pedestal Storage, UltraW, Single-Bus
2.1	7	DS-RZ1DD-VW 7 9.1GB 10000r UltraSCSI disk
3	1	DS-BA356-KF 1 Pedestal Storage, UltraW, Single-Bus
3.1	7	DS-RZ1DD-VW 7 9.1GB 10000r UltraSCSI disk
4	1	VT510-A4 1 Text Terminal WH Intl No-hemi
5	1	3X-BN51A-IB 1 One drop DS10L IDE cable
6	4	BN19C-2E 4 PowerCable 240V, C-Europe
7	2	BN37A-02 2 Ultra Cbl VHDCI - VHDCI
8	1	LK461-AF 1 VMS STYLE KEYBOARD, Fin/Swed

Bill of material

Part Number	Qty	Description
1	1	DY-71BAA-DA 1 AS DS10L 67/600 256MB OpenVMS
1.1	1	3X-PBXRY-AA 1 Diskette/ 24x CD-ROM Combo
1.2	1	3X-RE56A-BA 1 DS10 10GB 7200 IDE-disk drive 1"
1.3	1	SN-PBXGK-BB 1 Elsa Gloria Synergy 8M Video Graphics
2	1	3R-VRQV5-24 1 COMPAQ V55 CLR MON,NH,TCO95
3	1	3X-BN51A-IB 1 One drop DS10L IDE cable
4	1	SN-PBQWS-WA 1 Standard Compaq opal mouse
5	1	BN39C-02 1 1.8 Video Extension Cable ****
6	2	BN19C-2E 2 PowerCable 240V, C-Europe
7	1	LK461-AF 1 VMS STYLE KEYBOARD, Fin/Swed

[www.Compaq.com/golden-eggs](http://www.Compaq.com/golden-eggs)  
Since:Oct-2000

This template is included in the present GOLDEN EGGS Software kit.

DS10L OVMS

<b>COMPAQ</b>	06-Feb-2001	GTAVDS10L3
	Matti.Patari@Compaq.com	
AlphaServer DS10L OVMS systems		
GOLDEN EGGS Visuals, Helsinki		

DS10L OpenVMS Cluster with in-cabinet RAID storage

Ethernet  
Ethernet

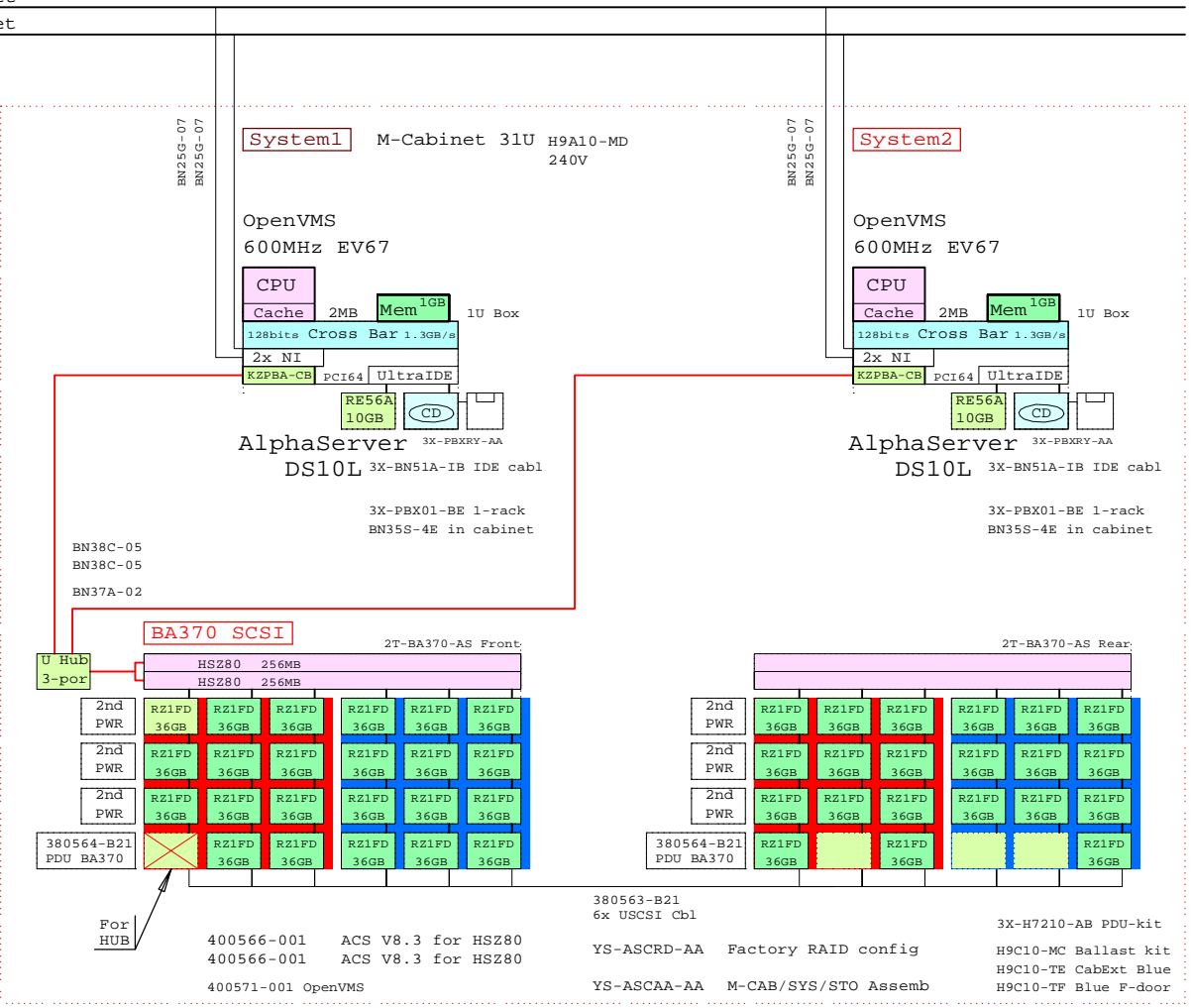

BOM for this cabinet system

	Part Number	Qty	Description
1	H9A10-MD	1	M-Series Cab,H9A10,Blue,240V 31U
1.1	2T-BA370-AR	1	BA370 shelf_slides Rear RackMount
1.1.1	380564-B21	1	Power Distribution Unit RA8k/7k
1.1.2	380565-B21	3	Power Suply 180W Hot Plug SBB
1.1.3	DS-RZ1FD-VW	21	36GB 10000r UltraSCSI Disk
1.2	2T-BA370-AS	1	BA370 shelf_slides Front RackMount
1.2.1	380564-B21	1	Power Distribution Unit RA8k/7k
1.2.2	380565-B21	3	Power Suply 180W Hot Plug SBB
1.2.3	400565-B21	2	Ultra Opt.1 cont w 2x128MB cache HSZ80
1.2.4	DS-DWZ2H-03	1	Uschi Act hub 0 SE:3/Dif 3.5" SBB
1.2.5	DS-RZ1FD-VW	23	36GB 10000r UltraSCSI Disk
1.3	380563-B21	1	Set of six USCSI cables
1.4	3X-H7210-AB	1	PDU Fan Cable mgt kit Europe
1.5	3X-PBX01-BB	2	
1.6	400566-001	2	HSZ80 Controller Software ACS V8.3
1.7	400571-001	1	Ultra opt OS Software OpenVMS
1.8	BN25G-07	4	17-03212-05 8MP-8MP PATCH CBL
1.9	BN35S-4E	2	PowerCord C13 to C14, Non US
1.10	BN37A-02	1	Ultra Cbl VHDCI - VHDCI
1.11	BN38C-05	2	Ultra Cbl VHDCI - 68HD
1.12	DY-71BAA-FA	1	AS DS10L 67/600 1GB OpenVMS
1.12.1	3X-BN51A-IB	1	One drop DS10L IDE cable
1.12.2	3X-PBXRY-AA	1	Diskette/ 24x CD-ROM Combo
1.12.3	3X-RE56A-BA	1	DS10 10GB 7200 IDE-disk drive 1"
1.12.4	KZPBA-CB	1	PCI to UltraSCSI Adapter UWdif
1.13	DY-71BAA-FA	1	AS DS10L 67/600 1GB OpenVMS
1.13.1	3X-BN51A-IB	1	One drop DS10L IDE cable
1.13.2	3X-PBXRY-AA	1	Diskette/ 24x CD-ROM Combo
1.13.3	3X-RE56A-BA	1	DS10 10GB 7200 IDE-disk drive 1"
1.13.4	KZPBA-CB	1	PCI to UltraSCSI Adapter UWdif
1.14	H9C10-MC	1	Ballast Kit for cabinets
1.15	H9C10-TE	1	Rear cab extender for H9A10 Blue
1.16	H9C10-TF	1	FrontDoorKit Blue for H9A10
1.17	YS-ASCAA-AA	1	M-CAB/SYS/STO Assembly
1.18	YS-ASCRD-AA	1	Factory configured RAID sets of BA370

This template is included in the present GOLDEN EGGS Software kit.

DS10L OVMS

www.Compaq.com/golden-eggs  
Since:Oct-2000

<b>COMPAQ</b>	08-Nov-2000	GTAVDS10L4
	Matti.Patari@Compaq.com	
AlphaServer DS10L OVMS Cluster		
GOLDEN EGGS Visuals, Helsinki		

Ethernet  
Ethernet

DS10L Linux with External storage

DS10L Linux, SCSI, One-box

DS10L Linux, IDE, One-box

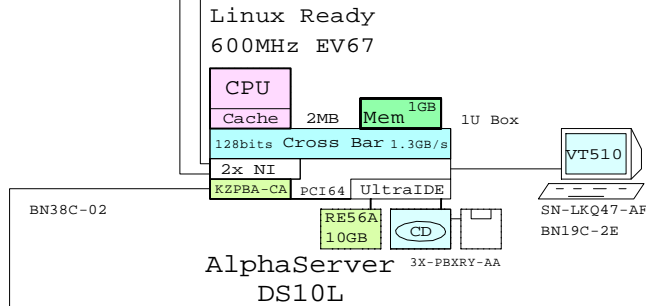

3X-BN51A-IB IDE cabl  
BN19C-2E

External BA356

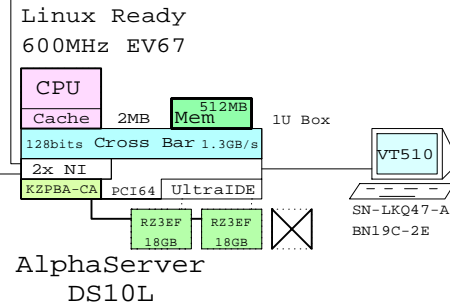
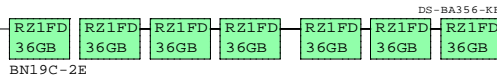

3X-BN50A-02 SCSI cbl  
BN19C-2E



DS10L

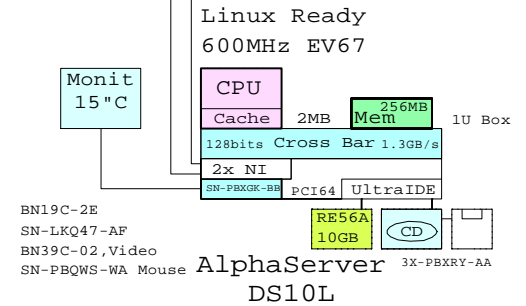

3X-BN51A-IB IDE cabl  
BN19C-2E



DS10L

Bill of material

	Part Number	Qty	Description
	DJ-71BAA-EA	1	AS DS10L 67/600 512MB Linux Ready
1.1	DS-RZ3EF-WA	2	18.2GB 10krPM Ultra3 SCSI Disk
1.2	KZPBA-CA	1	PCI to UltraSCSI Adapter UWSE
2	VT510-A4	1	Text Terminal WH Intl No-hemi
3	3X-BN50A-02	1	Two drop SCSI cable, LED
4	SN-LKQ47-AF	1	102 KEY KYBD, NON-WIN, Finnish
5	BN19C-2E	2	PowerCable 240V, C-Europe

Bill of material

	Part Number	Qty	Description
1	DJ-71BAA-FA	1	AS DS10L 67/600 1GB Linux Ready
1.1	3X-PBXRY-AA	1	Diskette/ 24x CD-ROM Combo
1.2	3X-RE56A-BA	1	DS10 10GB 7200 IDE-disk drive 1"
1.3	KZPBA-CA	1	PCI to UltraSCSI Adapter UWSE
2	DS-BA356-KF	1	Pedestal Storage, UltraW, Single-Bus
2.1	DS-RZ1FD-VW	7	36GB 10000r UltraSCSI Disk
3	VT510-A4	1	Text Terminal WH Intl No-hemi
4	3X-BN51A-IB	1	One drop DS10L IDE cable
5	SN-LKQ47-AF	1	102 KEY KYBD, NON-WIN, Finnish
6	BN19C-2E	3	PowerCable 240V, C-Europe
7	BN38C-02	1	Ultra Cbl VHDCI - 68HD

Bill of material

	Part Number	Qty	Description
1	DJ-71BAA-DA	1	AS DS10L 67/600 256MB Linux Ready
1.1	3X-PBXRY-AA	1	Diskette/ 24x CD-ROM Combo
1.2	3X-RE56A-BA	1	DS10 10GB 7200 IDE-disk drive 1"
1.3	SN-PBXGK-BB	1	Elsa Gloria Synergy 8M Video Graphics
2	3R-VRQV5-24	1	COMPAQ V55 CLR MON,NH,TCO95
3	3X-BN51A-IB	1	One drop DS10L IDE cable
4	SN-PBQWS-WA	1	Standard Compaq opal mouse
5	BN39C-02	1	1.8 Video Extension Cable ****
6	SN-LKQ47-AF	1	102 KEY KYBD, NON-WIN, Finnish
7	BN19C-2E	2	PowerCable 240V, C-Europe

[www.Compaq.com/golden-eggs](http://www.Compaq.com/golden-eggs)  
Since:Oct-2000

<b>COMPAQ</b>	08-Nov-2000	GTALDS10L3
	Matti.Patari@Compaq.com	

AlphaServer DS10L Linux system  
GOLDEN EGGS Visuals, Helsinki

This template is included in the present GOLDEN EGGS Software kit.

DS10L Linux

# AlphaServer DS10 67/600 Systems

Order number	Operating system	Server systems, 64bits 600MHz
#1 DA-73BAA -DA 256MB -EA 512MB -FA 1GB	Tru64 UNIX	(Disk) RX,CD,NI,(Graphics)
DY-73BAA-**	OpenVMS	(Disk) RX,CD,NI,(Graphics)
DJ-73BAA-**	Linux	(Disk) RX,CD,NI,(Graphics)

#2 Select a system disk, IDE or SCSI; SCSI adapter and cable kit.

#3 SVGA color monitor #4 For 240V, select 2x power cords and one keyboard.

15" 3R-VRQV5-24/11  
17" 3R-VRQP7-24/23  
North/South  
BN39C-02 2m ext.cable

SN-LKQ47 UNIX,Lin	-AE GB -AB B	-AG G -AH NL	-AM S -AN N	BN19C-2E Europe BN19A-2E GB BN19E-2E CH BN19K-2E DK BN19M-2E I
LK461 OVMS	-AD DK -AF FI	-AI I -AK CH	-AP F -AS E	

## Internal options

Memory expansion

3X-MS310-CA	256MB	Max memory
3X-MS310-DA	512MB	
3X-MS310-EA	1GB	2x 1GB = 2GB

Internal storage

### Tape storage

TLZ10-LB	12/24GB DAT SCSI tape
SN-PBXKP-BA	Wide to narrow adapt
KZPBA-CA	UltraSCSI SE adapter

### Disk storage

3X-RE56A-BA	10GB IDE disk 7200
3X-RE57A-BA	30GB IDE disk 7200

3X-BN50A-03 SCSI Cable kit

DS-RZ3EF-WA	18.2GB Ultra3 disk 10k
DS-RZ3FD-WA	36.4GB Ultra3 disk 10k

KZPAC-CB	RAID 3-port, 8MB cache
KZPSC-UB	Cache battery
3X-PBX01-AB	H9Axx Cabinet shelf kit

## Adapters

SN-PBXGK-BB	ELSA Gloria Syn. 8MB
3X-DE600-AA	Ethernet 10/100
DEGPA-SA	Gigabit Ethernet
KZPBA-CB	UltraSCSI Diff, 68HD
3X-DEPVZ-AA	1 Ultra2,2D Grap,Ether.
3X-DEPVD-AA	Permedia P2, Ethernet

## External options

### Tape storage

DS-TZ89N-TA	35/70GB DLT tape,TT
BN21K-02	SCSI cable, FWD
BN19C-2E	Power cord, Europe
KZPBA-CA	UltraSCSI SE adapter

### Disk storage

DS-BA356-KF	Pedestal, single bus
DS-BA356-KG	Pedestal, split bus
BN37A-02	2m SCSI,VHDCI-VHDCI
BN19C-2E	Power cord, Europe
KZPAC-AA	RAID 1-port, 4Mbcache

DS-RZ1DD-VW	9.1GB UltraSCSI disk
DS-RZ1ED-VW	18 GB UltraSCSI disk

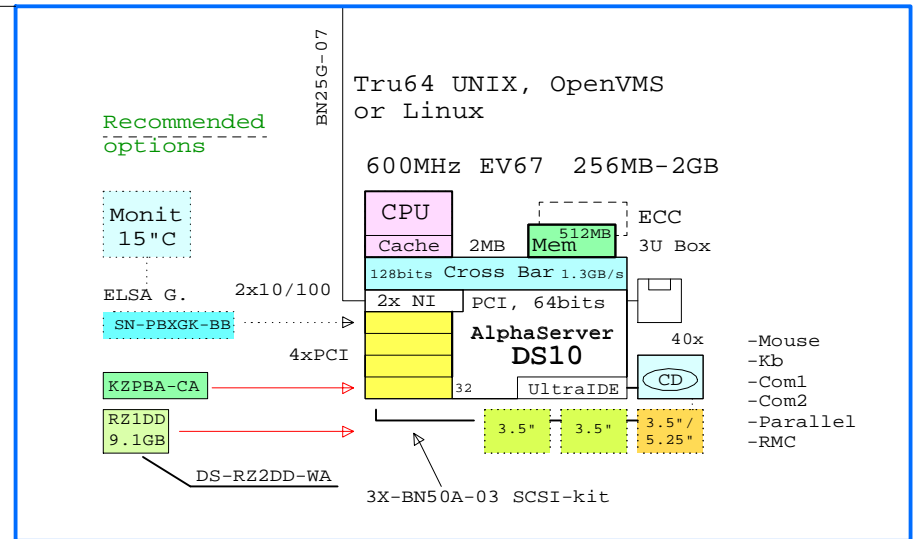

## Mandatory options:

- SCSI adapter
- Cable kit
- System disk or IDE disk only

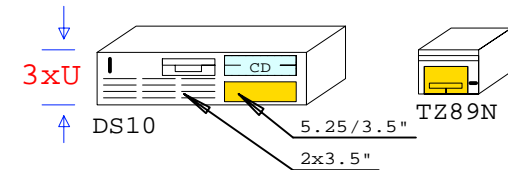

## Licenses included:

- Tru64 UNIX V4.0F, Base license, Unlimited User license, Server Extension license, and Internet Access Software license and Netscape's Enterprise Server.
- OpenVMS V7.1-2, Base license and DIGITAL Enterprise Integration Package.

	@600MHz	@466MHz
SPECint95	35	24
SPECfp95	56	47

Software Processor Code: E

<b>COMPAQ</b>	19-Dec-2000	GEADS102
	Matti.Patari@Compaq.com	

AlphaServer DS10 600MHz System  
GOLDEN EGGS Visuals, Helsinki

BN25G-07

Recommended options

Tru64 UNIX, OpenVMS  
or Linux

600MHz EV67 256MB-2GB

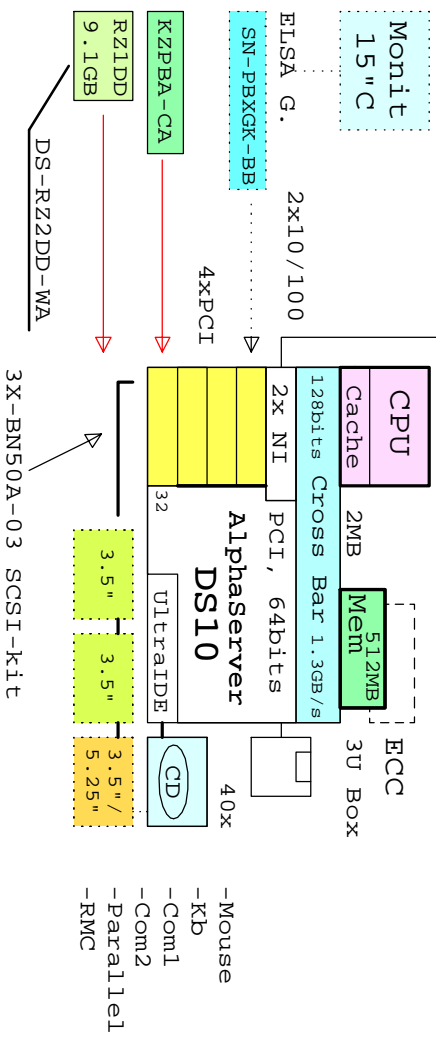

Mandatory options:

- SCSI adapter
- Cable kit
- System disk or IDE disk only

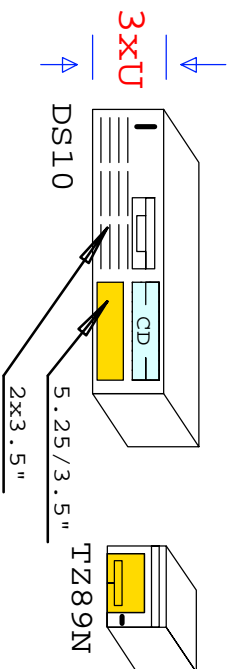

Licenses included:

- Tru64 UNIX V4.0F, Base license, Unlimited User license, Server Extension license, and Internet Access Software license and Netscape's Enterprise Server.
- OpenVMS V7.1-2, Base license and DIGITAL Enterprise Integration Package.

	@600MHz	@466MHz
SPECint95	35	24
SPECfp95	56	47
Software Processor Code: <b>E</b>		



19-Dec-2000	GEADS102
Matti.Patari@Compaq.com	

AlphaServer DS10 600MHz System  
GOLDEN EGGS Visuals, Helsinki

# DS10

BN25G-07

Tru64 UNIX, OpenVMS  
or Linux

600MHz EV67 256MB-2GB

Recommended  
options

Monit  
15" C

ELSA G.

SN-PBXGK-BB

KZPBA-CA

RZ1DD  
9.1GB

DS-RZ2DD-WA

CPU  
Cache 2MB

512MB  
Mem

ECC  
3U Box

128bits Cross Bar 1.3GB/s

2x NI PCI, 64bits

4xPCI  
32

AlphaServer  
DS10

UltraIDE

40x

CD

3.5" 3.5" 3.5" / 5.25"

3X-BN50A-03 SCSI-kit

- Mouse
- Kb
- Com1
- Com2
- Parallel
- RMC



Ethernet DS10 UNIX Uscsi-based + External RAID DS10 UNIX One-box  
 Ethernet  
 FDDI

QA-054AA-H8 SW LP PKG U/A CDRM/D  
 QA-MT4AA-GZ Dig UNIX Alpha DOC F  
 QA-MT4AA-H8 Dig UNIX Alpha CDRM

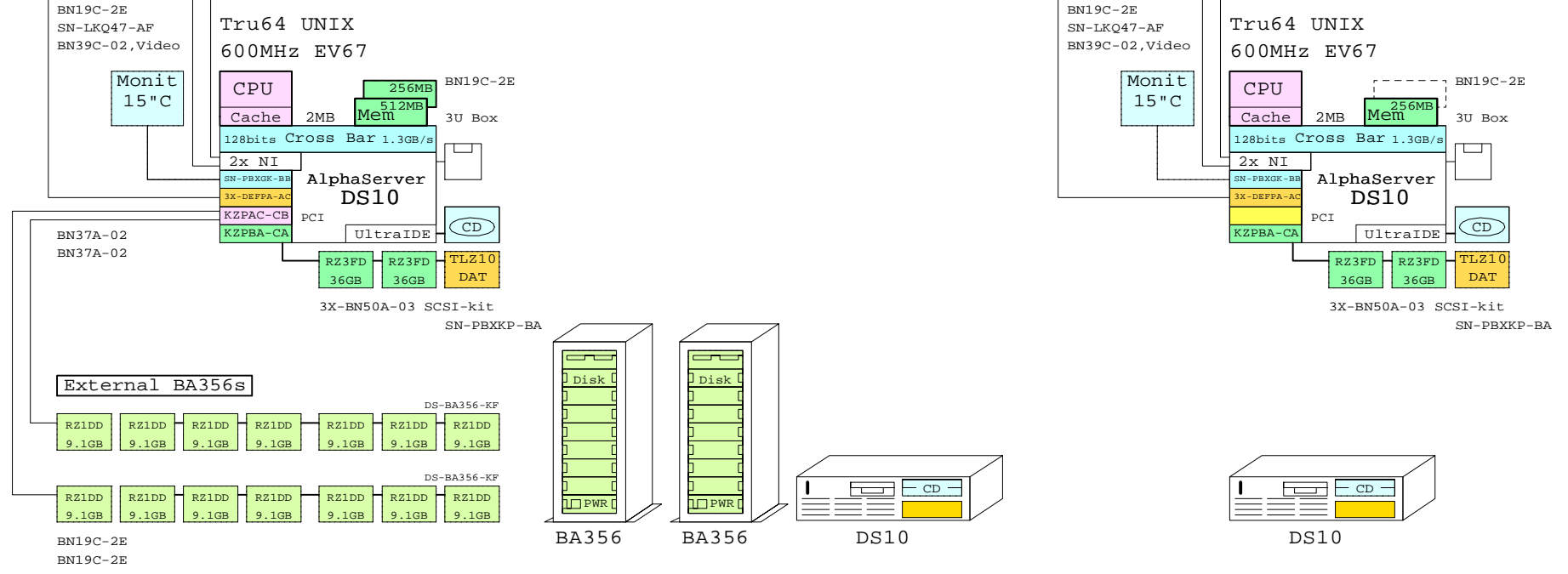

Bill of Material for Uscsi-system

Part Number	Qty	Description
1	1	DA-73BAA-EA AS DS10 67/600 512MB UNIX
1.1	1	3R-VRQV5-24 COMPAQ V55 CLR MON,NH,TCO95
1.2	1	3X-DEFPA-AC PCI to FDDI SAS MMF with SC,Universal
1.3	1	3X-MS310-CA DS10 256MB DIMM MEM
1.4	1	BN19C-2E PowerCable 240V, C-Europe
1.5	1	BN39C-02 1.8 Video Extension Cable ****
1.6	2	DS-RZ3FD-WA 36.4GB 10kRPM Ultra3 SCSI Disk
1.7	1	KZPAC-CB 3 Chan. SCSI RAID 8MB UltraW
1.8	1	KZPBA-CA PCI to UltraSCSI Adapter UWSE
1.9	1	SN-PBXGK-BB Elsa Gloria Synergy 8M Video Graphics
1.10	1	TLZ10-LB 12/24GB 4mm DAT 5.25" HH
2	1	DS-BA356-KF Pedestal Storage, UltraW, Single-Bus
2.1	7	DS-RZ1DD-VW 9.1GB 10000r UltraSCSI disk
3	1	DS-BA356-KF Pedestal Storage, UltraW, Single-Bus
3.1	7	DS-RZ1DD-VW 9.1GB 10000r UltraSCSI disk
4	1	3X-BN50A-03 SCSI cable kit, LED, 3x disk
5	1	SN-LKQ47-AF 102 KEY KYBD, NON-WIN, Finnish
6	1	SN-PBXKP-BA WIDE TO NARROW SCSI ADAPTER
7	3	BN19C-2E PowerCable 240V, C-Europe
8	2	BN37A-02 Ultra Chl VHDCI - VHDCI

Bill of Material for one-box system

Part Number	Qty	Description
1	1	DA-73BAA-DA AS DS10 67/600 256MB UNIX
1.1	1	3R-VRQV5-24 COMPAQ V55 CLR MON,NH,TCO95
1.2	1	3X-DEFPA-AC PCI to FDDI SAS MMF with SC,Universal
1.3	1	BN19C-2E PowerCable 240V, C-Europe
1.4	1	BN39C-02 1.8 Video Extension Cable ****
1.5	2	DS-RZ3FD-WA 36.4GB 10kRPM Ultra3 SCSI Disk
1.6	1	KZPBA-CA PCI to UltraSCSI Adapter UWSE
1.7	1	SN-PBXGK-BB Elsa Gloria Synergy 8M Video Graphics
1.8	1	TLZ10-LB 12/24GB 4mm DAT 5.25" HH
2	1	3X-BN50A-03 SCSI cable kit, LED, 3x disk
3	1	SN-LKQ47-AF 102 KEY KYBD, NON-WIN, Finnish
4	1	SN-PBXKP-BA WIDE TO NARROW SCSI ADAPTER
5	1	BN19C-2E PowerCable 240V, C-Europe

[www.Compaq.com/golden-eggs](http://www.Compaq.com/golden-eggs)  
 Since: Oct-2000

**COMPAQ** 06-Feb-2001 GTAUDS102  
 Matti.Patari@Compaq.com

AlphaServer DS10 UNIX Systems  
 GOLDEN EGGS Visuals, Helsinki

Ethernet DS10 OpenVMS Uscsi-based + External RAID DS10 OpenVMS One-box  
 Ethernet  
 FDDI

QA-001AA-GZ OVMS Full Documentat  
 QA-03XAA-H8 SW LP PKG V/A DOC CD  
 QA-MT1AA-H8 OVMS Alpha Bin+Onlin

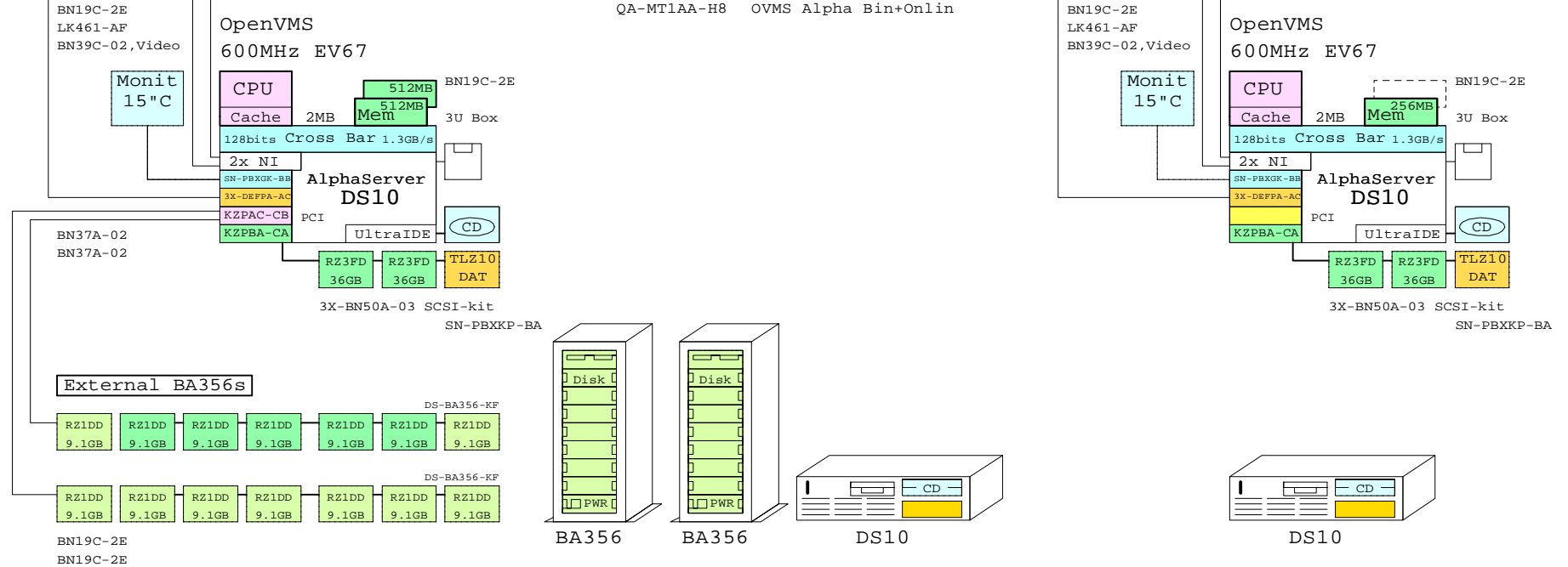

Bill of Material for Uscsi-system

Part Number	Qty	Description
1	1	DY-73BAA-EA AS DS10 67/600 512MB OpenVMS
1.1	1	3R-VRQV5-24 COMPAQ V55 CLR MON,NH,TCO95
1.2	1	3X-DEFFPA-AC PCI to FDDI SAS MMF with SC,Universal
1.3	1	3X-MS310-DA DS10 512MB DIMM MEM
1.4	1	BN19C-2E PowerCable 240V, C-Europe
1.5	1	BN39C-02 1.8 Video Extension Cable ****
1.6	2	DS-RZ3FD-WA 36.4GB 10kRPM Ultra3 SCSI Disk
1.7	1	KZPAC-CB 3 Chan. SCSI RAID 8MB UltraW
1.8	1	KZPBA-CA PCI to UltraSCSI Adapter UWSE
1.9	1	SN-PBXGK-BB Elsa Gloria Synergy 8M Video Graphics
1.10	1	TLZ10-LB 12/24GB 4mm DAT 5.25" HH
2	1	DS-BA356-KF Pedestal Storage, UltraW, Single-Bus
2.1	7	DS-RZ1DD-VW 9.1GB 10000r UltraSCSI disk
3	1	DS-BA356-KF Pedestal Storage, UltraW, Single-Bus
3.1	7	DS-RZ1DD-VW 9.1GB 10000r UltraSCSI disk
4	1	3X-BN50A-03 SCSI cable kit, LED,3x disk
5	1	SN-PBXKP-BA WIDE TO NARROW SCSI ADAPTER
6	3	BN19C-2E PowerCable 240V, C-Europe
7	2	BN37A-02 Ultra Chl VHDCI - VHDCI
8	1	LK461-AF VMS STYLE KEYBOARD, Fin/Swed

Bill of Material for One-box system

Part Number	Qty	Description
1	1	DY-73BAA-DA AS DS10 67/600 256MB OpenVMS
1.1	1	3R-VRQV5-24 COMPAQ V55 CLR MON,NH,TCO95
1.2	1	3X-DEFFPA-AC PCI to FDDI SAS MMF with SC,Universal
1.3	1	BN19C-2E PowerCable 240V, C-Europe
1.4	1	BN39C-02 1.8 Video Extension Cable ****
1.5	2	DS-RZ3FD-WA 36.4GB 10kRPM Ultra3 SCSI Disk
1.6	1	KZPBA-CA PCI to UltraSCSI Adapter UWSE
1.7	1	SN-PBXGK-BB Elsa Gloria Synergy 8M Video Graphics
1.8	1	TLZ10-LB 12/24GB 4mm DAT 5.25" HH
2	1	3X-BN50A-03 SCSI cable kit, LED,3x disk
3	1	SN-PBXKP-BA WIDE TO NARROW SCSI ADAPTER
4	1	BN19C-2E PowerCable 240V, C-Europe
5	1	LK461-AF VMS STYLE KEYBOARD, Fin/Swed

[www.Compaq.com/golden-eggs](http://www.Compaq.com/golden-eggs)  
 Since:Oct-2000

**COMPAQ** 06-Feb-2001 GTAVDS102  
 Matti.Patari@Compaq.com

This template is included in the present GOLDEN EGGS Software kit.

DS10 OVMS

AlphaServer DS10 OpenVMS Syst.  
 GOLDEN EGGS Visuals, Helsinki

Ethernet  
Ethernet

DS10 Linux Ready Uscsi-based + External RAID

DS10 Linux Ready One-box

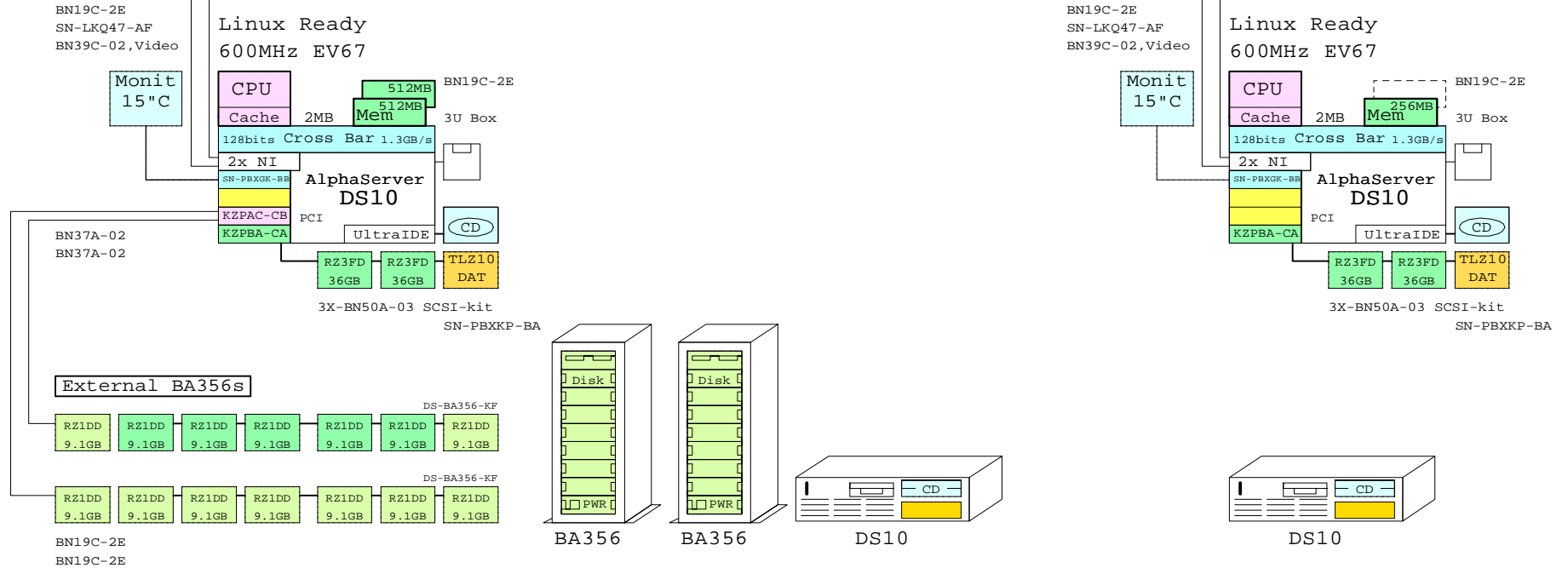

Bill of Material for Uscsi-system

	Part Number	Qty	Description
1	DJ-73BAA-EA	1	AS DS10 67/600 512MB Linux Ready
1.1	3R-VRQV5-24	1	COMPAQ V55 CLR MON,NH,TCO95
1.2	3X-MS310-DA	1	DS10 512MB DIMM MEM
1.3	BN19C-2E	1	PowerCable 240V, C-Europe
1.4	BN39C-02	1	1.8 Video Extension Cable ****
1.5	DS-RZ3FD-WA	2	36.4GB 10kRPM Ultra3 SCSI Disk
1.6	KZPAC-CB	1	3 Chan. SCSI RAID 8MB UltraW
1.7	KZPBA-CA	1	PCI to UltraSCSI Adapter UWSE
1.8	SN-PBXGK-BB	1	Elsa Gloria Synergy 8M Video Graphics
1.9	TLZ10-LB	1	12/24GB 4mm DAT 5.25" HH
2	DS-BA356-KF	1	Pedestal Storage, UltraW, Single-Bus
2.1	DS-RZ1DD-VW	7	9.1GB 10000r UltraSCSI disk
3	DS-BA356-KF	1	Pedestal Storage, UltraW, Single-Bus
3.1	DS-RZ1DD-VW	7	9.1GB 10000r UltraSCSI disk
4	3X-BN50A-03	1	SCSI cable kit, LED,3x disk
5	SN-LKQ47-AF	1	102 KEY KYBD, NON-WIN, Finnish
6	SN-PBXKP-BA	1	WIDE TO NARROW SCSI ADAPTER
7	BN19C-2E	3	PowerCable 240V, C-Europe
8	BN37A-02	2	Ultra Chl VHDCI - VHDCI

Bill of Material for one-box system

	Part Number	Qty	Description
1	DJ-73BAA-DA	1	AS DS10 67/600 256MB Linux Ready
1.1	3R-VRQV5-24	1	COMPAQ V55 CLR MON,NH,TCO95
1.2	BN19C-2E	1	PowerCable 240V, C-Europe
1.3	BN39C-02	1	1.8 Video Extension Cable ****
1.4	DS-RZ3FD-WA	2	36.4GB 10kRPM Ultra3 SCSI Disk
1.5	KZPBA-CA	1	PCI to UltraSCSI Adapter UWSE
1.6	SN-PBXGK-BB	1	Elsa Gloria Synergy 8M Video Graphics
1.7	TLZ10-LB	1	12/24GB 4mm DAT 5.25" HH
2	3X-BN50A-03	1	SCSI cable kit, LED,3x disk
3	SN-LKQ47-AF	1	102 KEY KYBD, NON-WIN, Finnish
4	SN-PBXKP-BA	1	WIDE TO NARROW SCSI ADAPTER
5	BN19C-2E	1	PowerCable 240V, C-Europe

[www.Compaq.com/golden-eggs](http://www.Compaq.com/golden-eggs)  
Since:Oct-2000



06-Feb-2001 GTALDS102  
Matti.Patari@Compaq.com

This template is included in the present GOLDEN EGGS Software kit.

DS10 Linux

AlphaServer DS10 Linux Systems  
GOLDEN EGGS Visuals, Helsinki

# AlphaServer DS20E 67/667 Systems

Order number	Operating system	Server systems, 64bits 667MHz
<b>#1</b> DA-56PAA- -DA 256MB -EA 512MB -FA 1GB	DIGITAL UNIX	(Disk) RX,CD (NI SVGA)
DY-56PAA-**	OpenVMS	(Disk) RX,CD (NI SVGA)
DJ-56PAA-**	Linux Ready	(Disk) RX,CD (NI SVGA)
<b>#2 Tower system</b>		<b>#2 Cabinet system</b>
3X-BA56P-PB Tower kit		3X-BA56R-RC Rack mount kit
3X-BA610-6D Disk drive cage,6		3X-BA610-6D Disk drive cage,6
3R-A0585-AA Disk drive, 18GB		3R-A0585-AA Disk drive, 18GB
3X-KZPCA-AA Ultra2 SCSI adapter		3X-KZPCA-AA Ultra2 SCSI adapter
3X-DE600-AA Ethernet adapter		3X-DE600-AA Ethernet adapter
BN25G-10 Cable twisted, 10m		BN25G-10 Cable twisted, 10m
SN-PBXGK-BB Elsa Gloria 8MB		SN-PBXGK-BB Elsa Gloria 8MB
BN19C-2E Power cord		BN35S-4E CPU power cord for cab
		H9A15-MC/MD Cabinet 120V/240V 38U
		H9C15-TE Cabinet rear extender
		H9C15-TF Cabinet front door
		H9C10-MC Ballast kit 40lbs
		YS-ASCAA-AA Factory integration

**#3** SVGA color monitor      **#4** Select a keyboard and one powercord for pedestal.

15" 3R-A2832-AA
17" 3R-A2261-AA
Europe
BN39C-02 2m ext.cable

SN-LKQ47 UNIX, Lin	-AE GB	-AG G	-AM S	BN19C-2E Europe
LK461 OVMS	-AB B	-AH NL	-AN N	BN19A-2E GB
	-AD DK	-AI I	-AP F	BN19E-2E CH
	-AF FI	-AK CH	-AS E	BN19K-2E DK
				BN19Z-2E I

### Internal options

#### Memory expansion

DIMM-kits	Max memory
MS340-CA 256MB	4x 1GB =4GB
MS340-DA 512MB	
MS340-EA 1GB	

#### Additional CPUs

KN311-BB	UNIX	667MHz
KN311-BC	OVMS	667MHz
KN311-BD	Linux	667MHz

#### 3rd Power

FR-H7910-AA	For N+1
-------------	---------

#### Internal storage

##### Tape storage

TLZ10-LB	12/24GB DAT SCSI tape
3X-BC56C-2F	SCSI cable for tape

##### Disk storage

3R-A0584-AA	9.2GB Ultra3 U-disk 10k
3R-A0585-AA	18.2GB Ultra3 U-disk 10k
3R-A0919-AA	36.4GB Ultra3 U-disk 10k

3X-KZPCA-AA	LVD SCSI adapter
KZPBA-CA	UltraSCSI SE adapter
BN38C-02	2m SCSI cable, 68HD-VHDCI.
KZPAC-CB	RAID 3-port, 8MB cache
KZPSC-UB	Cache battery
BN37A-02	2m SCSI cbl VHDCI-VHDCI.

#### Controllers

SN-PBXGK-BB	ELSA Gloria Graph. 8MB
3X-DEPVD-AA	Permedia 2 + Ethernet
3X-DE600-AA	Fast Ethernet 10/100
3X-DEFPA-DC	FDDI DAS MMF SC
DEGPA-SA	Gigabit Ethernet
KZPBA-CB	UltraSCSI Diff, 68HD

### External options

#### Tape storage

DS-TZ89N-TA	35/70GB DLT tape, TT
BN21K-02	SCSI cable, FWD
BN19C-2E	Power cord, Europe
KZPBA-CA	UltraSCSI SE adapter

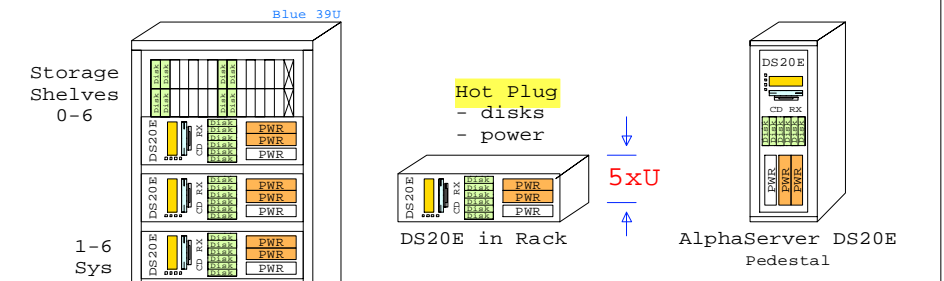
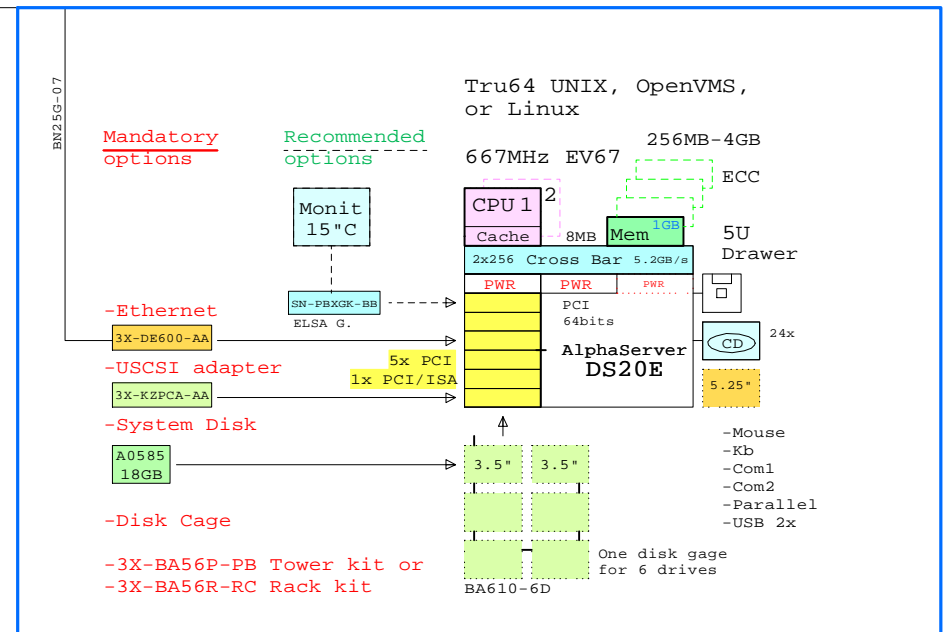

### Licenses included:

- DIGITAL UNIX V4.0F, Base license, Unlimited User license, Server Extension license, and Internet Access Software license and Netscape's Enterprise Server 3.0.
- OpenVMS V7.2-1, Base license and DIGITAL Enterprise Integration Package.

	@667MHz
SPECint95	40
SPECfp95	84
SPECweb99	685
TPC	....

Software Processor Code: **E**

<b>COMPAQ</b>	05-Feb-2001	GEADS20E3
	Matti.Patari@compaq.com	
AlphaServer DS20E 667MHz Syst.		
GOLDEN EGGS Visuals, Helsinki		

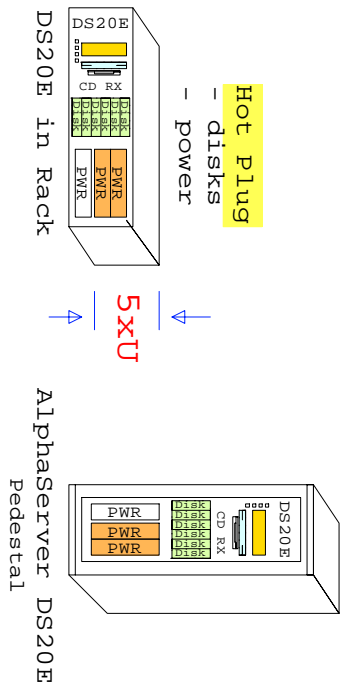
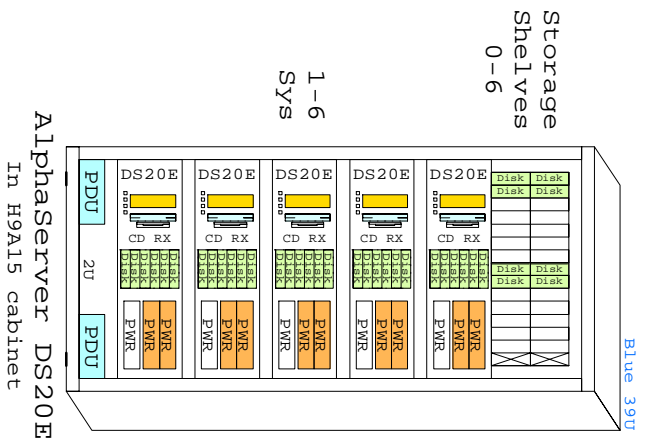
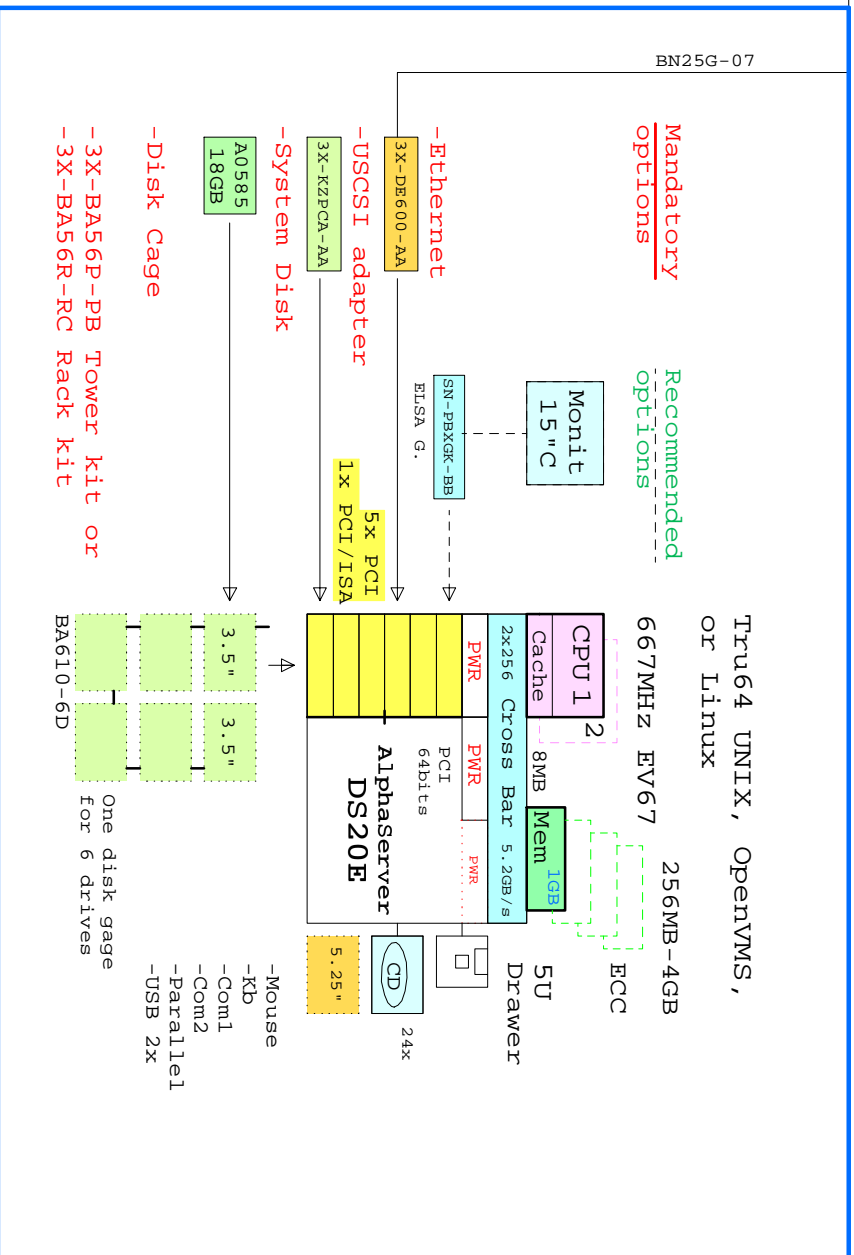

Licenses included:

- DIGITAL UNIX V4.0F, Base license, Unlimited User license, Server Extension license, and Internet Access Software license and Netscape's Enterprise Server 3.0.
- OpenVMS V7.2-1, Base license and DIGITAL Enterprise Integration Package.

@667MHz

SPECInt95	40
SPECfp95	84
SPECweb99	685
TPC	...

Software Processor Code: **E**

<b>COMPAQ</b>	05-Feb-2001	GEADSS20E3
	Matt.I.Patar.i@compaq.com	

# DS20E

BN25G-07

Tru64 UNIX, OpenVMS,  
or Linux

Mandatory options

Recommended options

-Ethernet

3X-DE600-AA

-USCSI adapter

3X-KZPCA-AA

-System Disk

A0585  
18GB

-Disk Cage

-3X-BA56P-PB Tower kit or  
-3X-BA56R-RC Rack kit

Monit  
15" C

SN-PBXGK-BB  
ELSA G.

CPU 1  
Cache

2  
8MB

Mem 1GB

256MB-4GB

ECC

5U  
Drawer

2x256 Cross Bar 5.2GB/s

PWR	PWR	PWR
	PCI 64bits	
AlphaServer DS20E		



24x

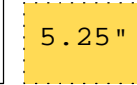

5.25"

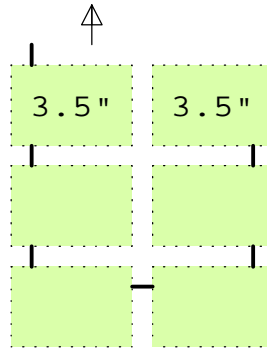

BA610-6D

One disk gage  
for 6 drives

- Mouse
- Kb
- Com1
- Com2
- Parallel
- USB 2x

DS20E expanded Tru64 UNIX system

FDDI

Ethernet

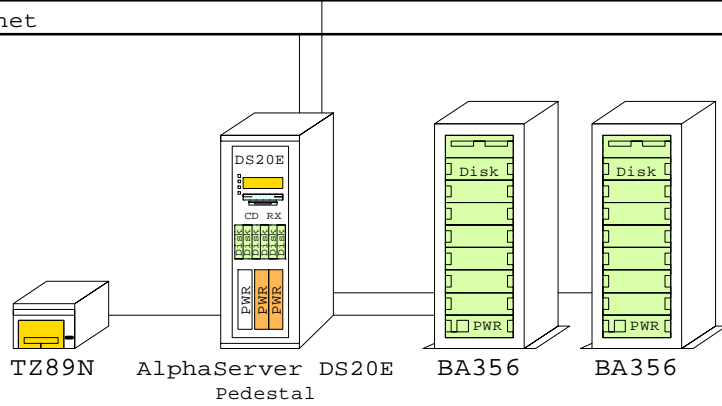

Bill of material

	Part Number	Qty	Description
1	3X-BA56P-PB	1	DS20E Mini tower pedestal kit,667MHz
1.1	DA-56PAA-EA	1	AS DS20E 6/667 512MB,Rack,UNIX
1.1.1	3X-BC56C-2F	1	DS20E SCSI Cable Kit
1.1.2	3X-DEPFA-DC	1	PCI to FDDI DAS MMF with SC,Universal
1.1.3	3X-KZPCA-AA	1	Single channel LVD adapter
1.1.4	BA610-6D	1	ES40 Disk Drive Cage, 6-Bay
1.1.4.1	3R-A0585-AA	4	18.2GB Uscsi3 10k Universal disk 1"
1.1.5	FR-H7910-AA	1	Third power supply for DS20E
1.1.6	KN311-BB	1	AS DS20E 6/667 SMP UPG UNIX
1.1.7	KZPBA-CA	2	PCI to UltraSCSI Adapter UWSE
1.1.8	KZPCM-DA	1	Dual Uscsi with FastEther PCI
1.1.9	MS340-CA	1	DS20 256MB SDIMM MEM 4x64MB
1.1.10	MS340-DA	1	DS20 512MB SDIMM MEM 4x128MB
1.1.11	SN-PBXGK-BB	1	Elsa Gloria Synergy 8M Video Graphics
1.1.12	TLZ10-LB	1	12/24GB 4mm DAT 5.25" HH
2	DS-BA356-KF	1	Pedestal Storage, UltraW, Single-Bus
2.1	BN19C-2E	2	PowerCable 240V, C-Europe
2.2	BN38C-02	1	Ultra Cbl VHDCI - 68HD
2.3	CK-BA35X-HH	1	180W Stor.Shelf PWR for AS4x00
2.4	DS-RZ1ED-VW	6	18.2GB 10000r UltraSCSI disk
3	DS-BA356-KF	1	Pedestal Storage, UltraW, Single-Bus
3.1	BN19C-2E	2	PowerCable 240V, C-Europe
3.2	BN38C-02	1	Ultra Cbl VHDCI - 68HD
3.3	CK-BA35X-HH	1	180W Stor.Shelf PWR for AS4x00
3.4	DS-RZ1ED-VW	6	18.2GB 10000r UltraSCSI disk
4	3R-A2832-AA	1	COMPAQ Monitor S510 15" NH, EU
5	DS-TZ89N-TA	1	35/70GB SE DLT-tape TT FWSE
6	BN39C-02	1	1.8 Video Extension Cable ****
7	SN-LKQ47-AF	1	102 KEY KYBD,NON-WIN, Finnish
8	BN19C-2E	5	PowerCable 240V, C-Europe
9	BN38C-02	1	Ultra Cbl VHDCI - 68HD

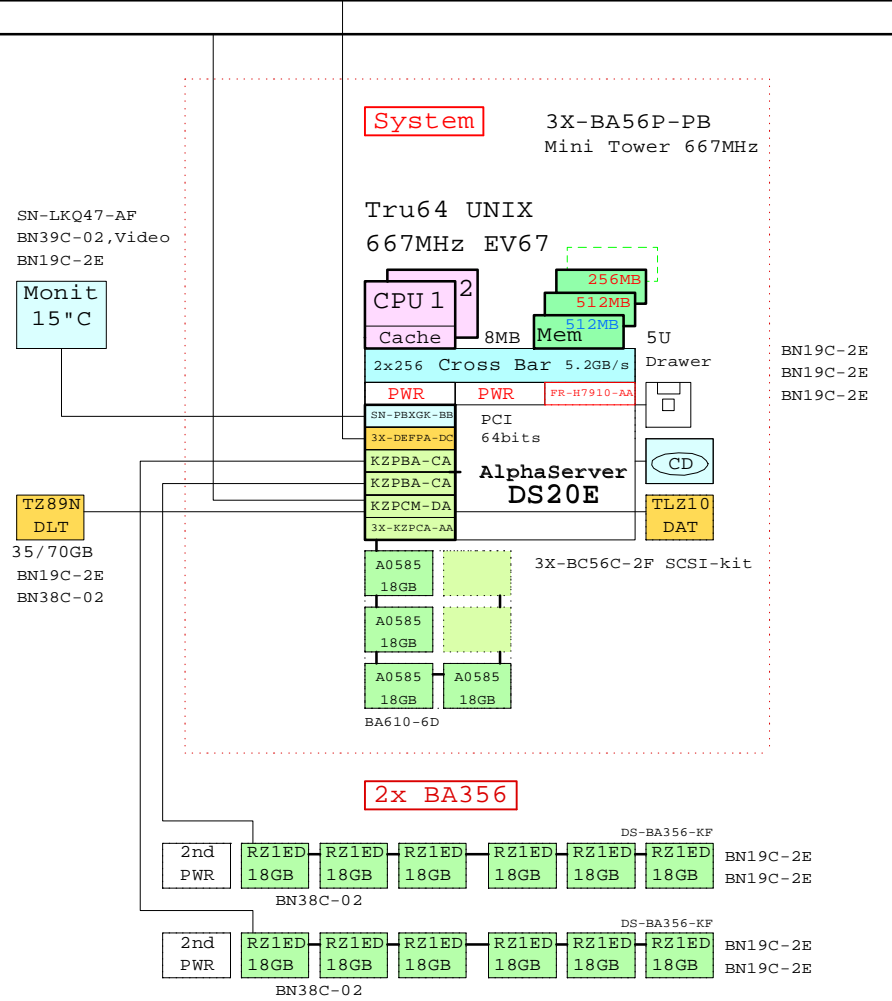

[www.Compaq.com/golden-eggs](http://www.Compaq.com/golden-eggs)  
Since: Jun-2000

<b>COMPAQ</b>	05-Feb-2001	GTAUDS20EA
	Matti.Patari@compaq.com	

This template is included in the present GOLDEN EGGS Software kit.

DS20E UNIX

AlphaServer DS20E UNIX System  
GOLDEN EGGS Visuals, Helsinki

DS20E expanded Tru64 UNIX RAID system

FDDI

Ethernet

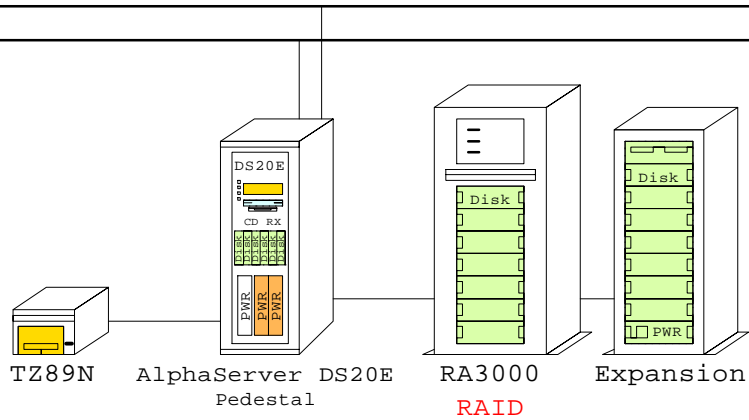

SN-LKQ47-AF  
BN39C-02, Video  
BN19C-2E

Monit  
15" C

TZ89N  
DLT  
35/70GB  
BN19C-2E  
BN38C-02

System 3X-BA56P-PB  
Mini Tower 667MHz

Tru64 UNIX  
667MHz EV67

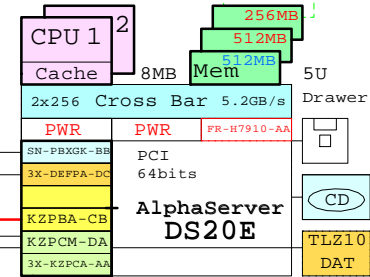

BN19C-2E  
BN19C-2E  
BN19C-2E

3X-BC56C-2F SCSI-kit

BA610-6D

RA3000 RAID and Expansion

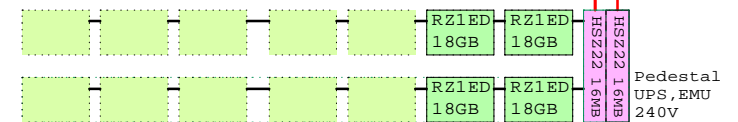

QB-5TWAB-SA Sol sw RA3000 Alp UN

BN19C-2E  
BN19C-2E

Bill of material

Part Number	Qty	Description
1	3X-BA56P-PB	1 DS20E Mini tower pedestal kit,667MHz
1.1	DA-56PAA-EA	1 AS DS20E 6/667 512MB,Rack,UNIX
1.1.1	3X-BC56C-2F	1 DS20E SCSI Cable Kit
1.1.2	3X-DEFFA-DC	1 PCI to FDDI DAS MMF with SC,Universal
1.1.3	3X-KZPCA-AA	1 Single channel LVD adapter
1.1.4	BA610-6D	1 ES40 Disk Drive Cage, 6-Bay
1.1.4.1	3R-A0585-AA	4 18.2GB Uscsi3 10k Universal disk 1"
1.1.5	FR-H7910-AA	1 Third power supply for DS20E
1.1.6	KN311-BB	1 AS DS20E 6/667 SMP UPG UNIX
1.1.7	KZPBA-CB	1 PCI to UltraSCSI Adapter UWdif
1.1.8	KZPCM-DA	1 Dual Uscsi with FastEther PCI
1.1.9	MS340-CA	1 DS20 256MB SDIMM MEM 4x64MB
1.1.10	MS340-DA	1 DS20 512MB SDIMM MEM 4x128MB
1.1.11	SN-PBXGK-BB	1 Elsa Gloria Synergy 8M Video Graphics
1.1.12	TLZ10-LB	1 12/24GB 4mm DAT 5.25" HH
2	DS-SWXRA-GC	1 RA3000 Pedestal one HSZ22 240V
2.1	DS-HSZ22-AA	1 HSZ22 controller 16MB
2.2	DS-RZ1ED-VW	2 18.2GB 10000r UltraSCSI disk
2.3	DS-SWXRA-GD	1 RA3000 Pedestal Expans 120/240
2.3.1	DS-RZ1ED-VW	2 18.2GB 10000r UltraSCSI disk
3	QB-5TWAB-SA	1 Sol sw RA3000 Alp UNIX
4	3R-A2832-AA	1 COMPAQ Monitor S510 15" NH, EU
5	DS-TZ89N-TA	1 35/70GB SE DLT-tape TT FWSE
6	BN39C-02	1 1.8 Video Extension Cable ****
7	SN-LKQ47-AF	1 102 KEY KYBD, NON-WIN, Finnish
8	BN19C-2E	7 PowerCable 240V, C-Europe
9	BN38C-02	1 Ultra Cbl VHDCI - 68HD

www.Compaq.com/golden-eggs  
Since:Jun-2000

<b>COMPAQ</b>	05-Feb-2001	GTAUDS20EB
	Matti.Patari@compaq.com	

AlphaServer DS20E UNIX RAID  
GOLDEN EGGS Visuals, Helsinki



**DS20E UNIX Cluster with in-cabinet RA3000 RAID storage**

Ethernet  
FDDI

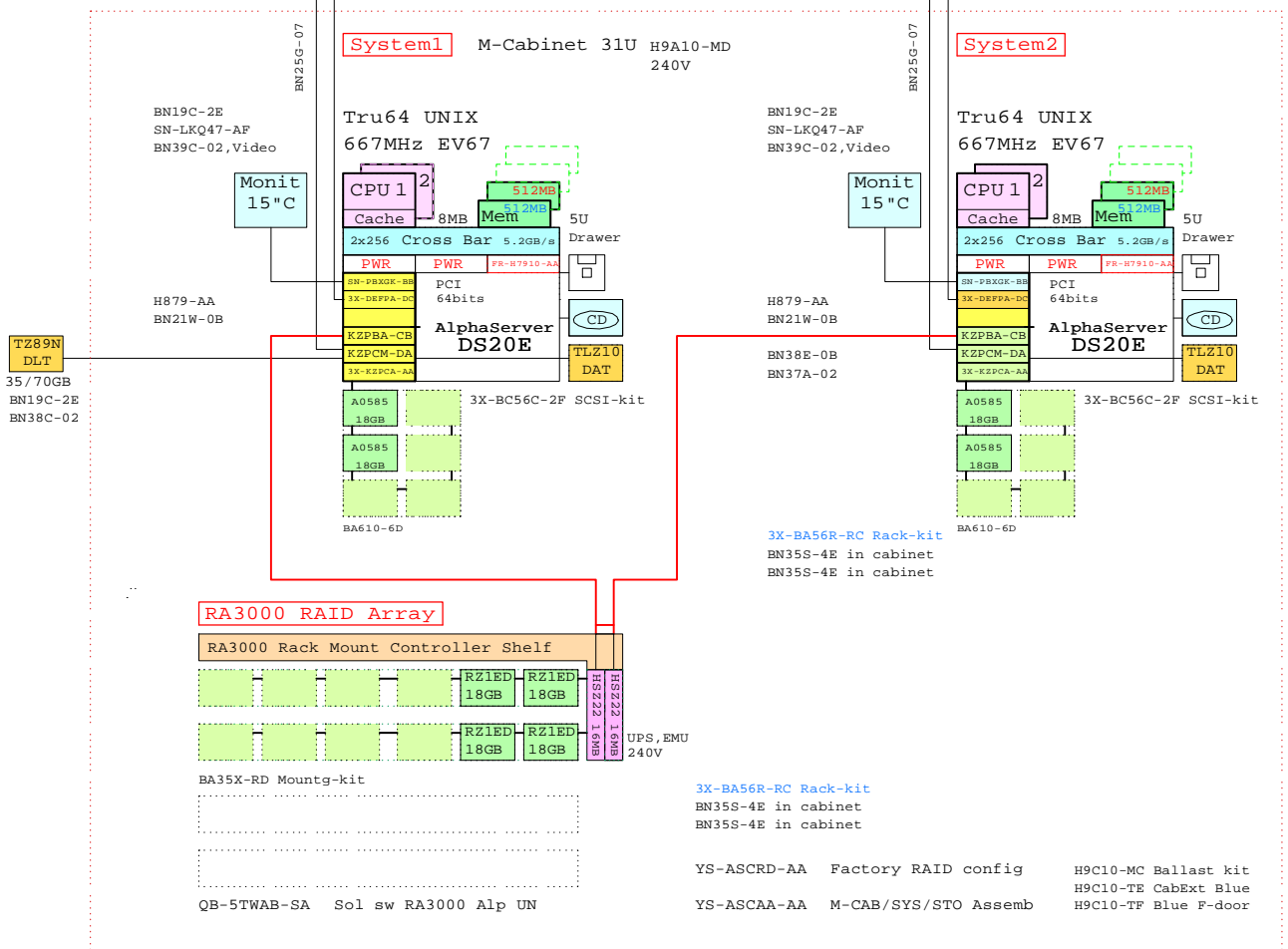

BOM for this cabinet system

Part Number	Qty	Description
1		H9A10-MD 1 M-Series Cab,H9A10,Blue,240V 31U
1.1		3X-A2832-AA 2 COMPAQ Monitor S510 15" NH, EU
1.2		3X-BA56R-RC 2 Rackm.kit_DS20E,667MHz for M-series
1.3		BA35X-RD 1 Mounting Kit, metric
1.4		BN19C-2E 2 PowerCable 240V, C-Europe
1.5		BN21W-0B 2 Y SCSI-2 Cable 68 pins/6".15m
1.6		BN25G-07 2 17-03212-05 8MP-8MP PATCH CBL
1.7		BN35S-4E 4 PowerCord C13 to C14, Non US
1.8		BN37A-02 1 Ultra Chl VHDCl - VHDCl
1.9		BN38E-0B 1 Ultra Chl VHDCl - 68HD
1.10		BN39C-02 2 1.8 Video Extension Cable ****
1.11		DA-56PAA-EA 1 AS DS20E 6/667 512MB,Rack,UNIX
1.11.1		3X-BC56C-2F 1 DS20E SCSI Cable Kit
1.11.2		3X-DEFFA-DC 2 PCI to FDDI DAS MMF with SC,Universal
1.11.3		3X-KZPCA-AA 1 Single channel LVD adapter
1.11.4		BA610-6D 1 BS40 Disk Drive Cage, 6-Bay
1.11.4.1		3R-A0585-AA 2 18.2GB Uscsi3 10k Universal disk 1"
1.11.5		FR-H7910-AA 1 Third power supply for DS20E
1.11.6		KN311-BB 1 AS DS20E 6/667 SMP UPG UNIX
1.11.7		KZPBA-CB 1 PCI to UltraSCSI Adapter UWdif
1.11.8		KZPCM-DA 1 Dual Uscsi with FastEther PCI
1.11.9		MS340-DA 1 DS20 512MB SDIMM MEM 4x128MB
1.11.10		SN-PBXGK-BB 1 Elsa Gloria Synergy 8M Video Graphics
1.11.11		TLZ10-LB 1 12/24GB 4mm DAT 5.25" HH
1.12		DA-56PAA-EA 1 AS DS20E 6/667 512MB,Rack,UNIX
1.12.1		3X-BC56C-2F 1 DS20E SCSI Cable Kit
1.12.2		3X-DEFFA-DC 2 PCI to FDDI DAS MMF with SC,Universal
1.12.3		3X-KZPCA-AA 1 Single channel LVD adapter
1.12.4		BA610-6D 1 BS40 Disk Drive Cage, 6-Bay
1.12.4.1		3R-A0585-AA 2 18.2GB Uscsi3 10k Universal disk 1"
1.12.5		FR-H7910-AA 1 Third power supply for DS20E
1.12.6		KN311-BB 1 AS DS20E 6/667 SMP UPG UNIX
1.12.7		KZPBA-CB 1 PCI to UltraSCSI Adapter UWdif
1.12.8		KZPCM-DA 1 Dual Uscsi with FastEther PCI
1.12.9		MS340-DA 1 DS20 512MB SDIMM MEM 4x128MB
1.12.10		SN-PBXGK-BB 1 Elsa Gloria Synergy 8M Video Graphics
1.12.11		TLZ10-LB 1 12/24GB 4mm DAT 5.25" HH
1.13		DS-SWXRA-GK 1 RA3000 Rackmount one HSZ22 240V
1.13.1		DS-HSZ22-AA 1 HSZ22 controller 16MB
1.13.2		DS-SWXRA-GN 1 RA3000 Rackmount Expan 120/240
1.13.2.1		DS-RZ1ED-VW 2 18.2GB 10000r UltraSCSI disk
1.13.3		DS-SWXRA-GN 1 RA3000 Rackmount Expan 120/240
1.13.3.1		DS-RZ1ED-VW 2 18.2GB 10000r UltraSCSI disk
1.14		H879-AA 2 SCSI-3 Term - 68 pin Male
1.15		H9C10-MC 1 Ballast Kit for cabinets
1.16		H9C10-TE 1 Rear cab extender for H9A10 Blue
1.17		H9C10-TF 1 FrontDoorKit Blue for H9A10
1.18		QB-5TWAB-SA 1 Sol sw RA3000 Alp UNIX
1.19		SN-LKQ47-AF 2 102 KEY KYBD,NON-WIN, Finnish
1.20		YS-ASCAA-AA 1 M-CAB/SYS/STO Assembly
1.21		YS-ASCRD-AA 1 Factory configured RAID sets of BA370
2		DS-TZ89N-TA 1 35/70GB SE DLT-tape TT FWSE
3		BN19C-2E 1 PowerCable 240V, C-Europe
4		BN38C-02 1 Ultra Chl VHDCl - 68HD

www.Compaq.com/golden-eggs  
Since:Jun-2000

**COMPAQ** 05-Feb-2001 GTAUDS20EC  
Matti.Patari@Compaq.com

AlphaServer DS20E UNIX Cluster  
GOLDEN EGGS Visuals, Helsinki

DS20E UNIX

This template is included in the present GOLDEN EGGS Software kit.

**DS20E UNIX Cluster with in-cabinet RAID storage**

Ethernet  
FDDI

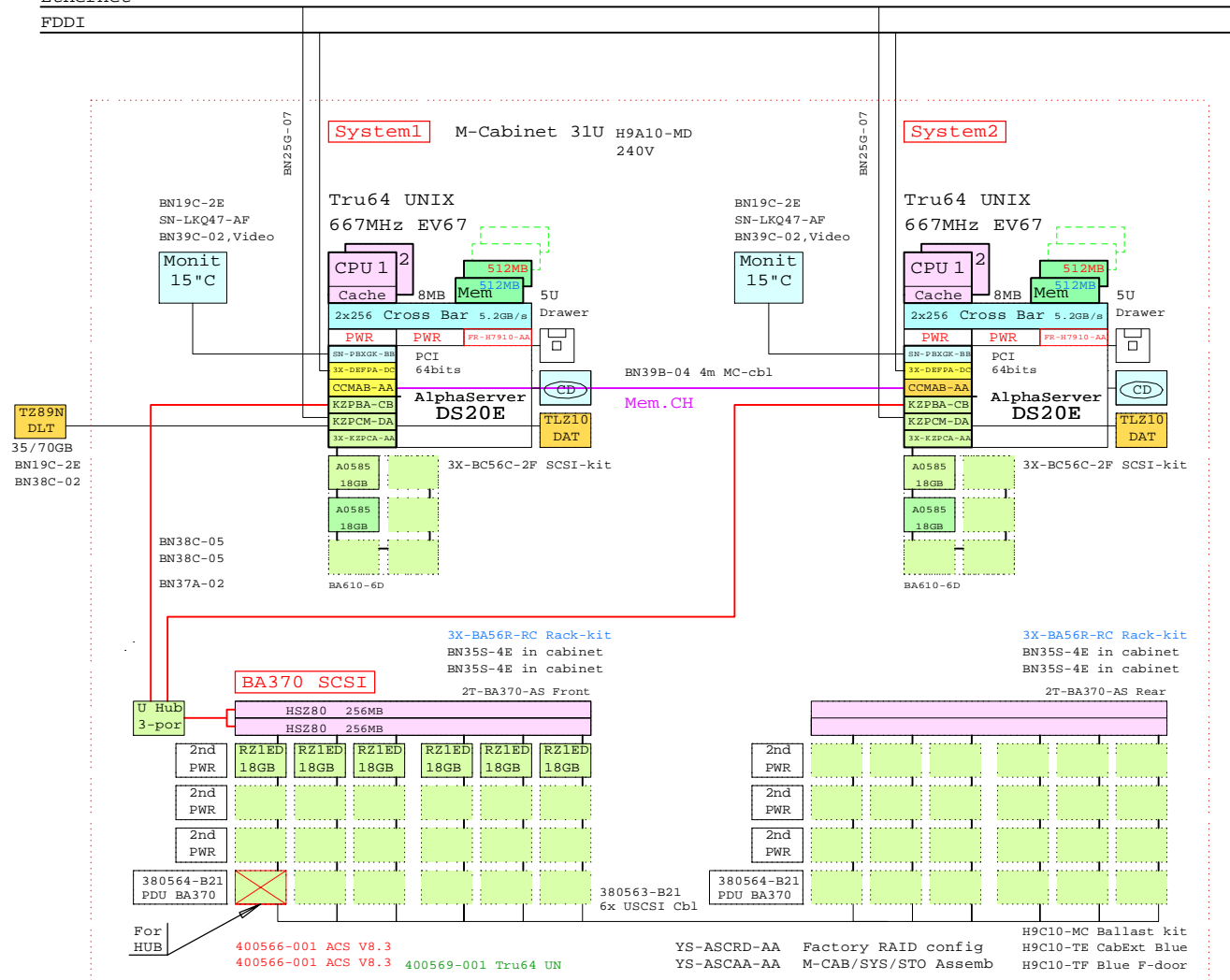

BOM for this cabinet system

Part Number	Qty	Description
1	H9A10-MD	1 M-Series Cab,H9A10.Blue,240V 31U
1.1	2T-BA370-AR	1 BA370 shelf,slides Rear RackMount
1.1.1	380564-B21	1 Power Distribution Unit RA8K/7K
1.1.2	380565-B21	3 Power Suply 180W Hot Plug SBB
1.2	2T-BA370-AS	1 BA370 shelf,slides Front RackMount
1.2.1	380564-B21	1 Power Distribution Unit RA8K/7K
1.2.2	380565-B21	3 Power Suply 180W Hot Plug SBB
1.2.3	400565-B21	2 Ultra Opt.1 cont w 2x128MB cache HSZ80
1.2.4	DS-DWZZH-03	1 Uscsi Act hub 0 SE:3/Dif 3.5" SBB
1.2.5	DS-RZ1ED-VW	6 18.2GB 10000F UltraSCSI disk
1.3	380563-B21	1 Set of six USCSI cables
1.4	3R-A2832-AA	2 COMPAQ Monitor S510 15" NH, EU
1.5	3X-BA56R-RC	2 Rackm.kit DS20E,667MHz for M-series
1.6	400566-001	2 SZ80 Controller Software ACS V8.3
1.7	400569-001	1 Ultra opt OS Software Tru64 UNIX
1.8	BN19C-2E	2 PowerCable 240V, C-Europe
1.9	BN25G-07	2 17-03212-05 8MP-8MP PATCH CBL
1.10	BN35S-4E	4 PowerCord CL3 to CL4, Non US
1.11	BN37A-02	1 Ultra Chl VHDCl - VHDCl
1.12	BN38C-05	2 Ultra Chl VHDCl - 68HD
1.13	BN39B-04	1 04m copper cbl for CCMAB Mem.Chan
1.14	BN39C-02	2 1.8 Video Extension Cable ****
1.15	DA-56PAA-EA	1 AS DS20E 6/667 512MB,Rack,UNIX
1.15.1	3X-BC56C-2F	1 DS20E SCSI Cable Kit
1.15.2	3X-DEFFA-DC	1 PCI to FDDI DAS MMF with SC,Universal
1.15.3	3X-KZPCA-AA	1 Single channel LVD adapter
1.15.4	BA610-6D	1 ES40 Disk Drive Cage, 6-Bay
1.15.4.1	3R-A0585-AA	2 18.2GB Uscsi3 10k Universal disk 1"
1.15.5	CCMAB-AA	1 PCI Mem. Channel-2 Cluster cntrl
1.15.6	FR-H7910-AA	1 Third power supply for DS20E
1.15.7	KN311-BB	1 AS DS20E 6/667 SMP UPG UNIX
1.15.8	KZPBA-CB	1 PCI to UltraSCSI Adapter UWdif
1.15.9	KZPCM-DA	1 Dual Uscsi with FastEther PCI
1.15.10	MS340-DA	1 DS20 512MB SDIMM MEM 4x128MB
1.15.11	SN-PBXGK-BB	1 Elsa Gloria Synergy 8M Video Graphics
1.15.12	TLZ10-LB	1 12/24GB 4mm DAT 5.25" HH
1.16	DA-56PAA-EA	1 AS DS20E 6/667 512MB,Rack,UNIX
1.16.1	3X-BC56C-2F	1 DS20E SCSI Cable Kit
1.16.2	3X-DEFFA-DC	1 PCI to FDDI DAS MMF with SC,Universal
1.16.3	3X-KZPCA-AA	1 Single channel LVD adapter
1.16.4	BA610-6D	1 ES40 Disk Drive Cage, 6-Bay
1.16.4.1	3R-A0585-AA	2 18.2GB Uscsi3 10k Universal disk 1"
1.16.5	CCMAB-AA	1 PCI Mem. Channel-2 Cluster cntrl
1.16.6	FR-H7910-AA	1 Third power supply for DS20E
1.16.7	KN311-BB	1 AS DS20E 6/667 SMP UPG UNIX
1.16.8	KZPBA-CB	1 PCI to UltraSCSI Adapter UWdif
1.16.9	KZPCM-DA	1 Dual Uscsi with FastEther PCI
1.16.10	MS340-DA	1 DS20 512MB SDIMM MEM 4x128MB
1.16.11	SN-PBXGK-BB	1 Elsa Gloria Synergy 8M Video Graphics
1.16.12	TLZ10-LB	1 12/24GB 4mm DAT 5.25" HH
1.17	H9C10-MC	1 Ballast Kit for cabinets
1.18	H9C10-TE	1 Rear cab extender for H9A10 Blue
1.19	H9C10-TF	1 FrontDoorKit Blue for H9A10
1.20	SN-LKQ47-AF	2 102 KEY KYBD,NON-WIN, Finnish
1.21	YS-ASCAA-AA	1 M-CAB/SYS/STO Assembly
1.22	YS-ASCRD-AA	1 Factory configured RAID sets of BA370
2	DS-TZ89N-TA	1 35/70GB SE DLT-tape TT FWSE
3	BN19C-2E	1 PowerCable 240V, C-Europe
4	BN38C-02	1 Ultra Chl VHDCl - 68HD

www.Compaq.com/golden-eggs  
Since:Apr-2000

<b>COMPAQ</b>	06-Feb-2001	GTAUDS20ED
	MattI.Patari@Compaq.com	

AlphaServer DS20E UNIX Cluster  
GOLDEN EGGS Visuals, Helsinki

DS20E UNIX

This template is included in the present GOLDEN EGGS Software kit.

DS20E expanded OpenVMS system

FDDI

Ethernet

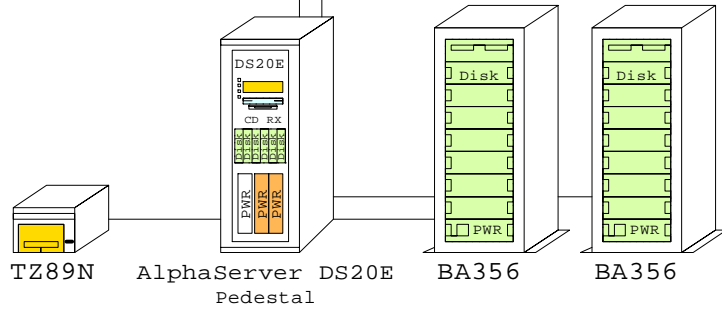

Bill of material

	Part Number	Qty	Description
1	3X-BA56P-PB	1	DS20E Mini tower pedestal kit,667MHz
1.1	DY-56PAA-EA	1	AS DS20E 6/667 512MB,Rack,OVMS
1.1.1	3X-BC56C-2F	1	DS20E SCSI Cable Kit
1.1.2	3X-DEFPA-DC	1	PCI to FDDI DAS MMF with SC,Universal
1.1.3	3X-KZPCA-AA	1	Single channel LVD adapter
1.1.4	BA610-6D	1	ES40 Disk Drive Cage, 6-Bay
1.1.4.1	3R-A0585-AA	4	18.2GB Uscsi3 10k Universal disk 1"
1.1.5	FR-H7910-AA	1	Third power supply for DS20E
1.1.6	KN311-BC	1	AS DS20E 6/667 SMP UPG OpenVMS
1.1.7	KZPBA-CA	2	PCI to UltraSCSI Adapter UWSE
1.1.8	KZPCM-DA	1	Dual Uscsi with FastEther PCI
1.1.9	MS340-CA	1	DS20 256MB SDIMM MEM 4x64MB
1.1.10	MS340-DA	1	DS20 512MB SDIMM MEM 4x128MB
1.1.11	SN-PBXGK-BB	1	Elsa Gloria Synergy 8M Video Graphics
1.1.12	TLZ10-LB	1	12/24GB 4mm DAT 5.25" HH
2	DS-BA356-KF	1	Pedestal Storage, UltraW, Single-Bus
2.1	BN19C-2E	2	PowerCable 240V, C-Europe
2.2	BN38C-02	1	Ultra Cbl VHDCI - 68HD
2.3	CK-BA35X-HH	1	180W Stor.Shelf PWR for AS4x00
2.4	DS-RZ1ED-VW	6	18.2GB 10000r UltraSCSI disk
3	DS-BA356-KF	1	Pedestal Storage, UltraW, Single-Bus
3.1	BN19C-2E	2	PowerCable 240V, C-Europe
3.2	BN38C-02	1	Ultra Cbl VHDCI - 68HD
3.3	CK-BA35X-HH	1	180W Stor.Shelf PWR for AS4x00
3.4	DS-RZ1ED-VW	6	18.2GB 10000r UltraSCSI disk
4	3R-A2832-AA	1	COMPAQ Monitor S510 15" NH, EU
5	DS-TZ89N-TA	1	35/70GB SE DLT-tape TT FWSE
6	BN39C-02	1	1.8 Video Extension Cable ****
7	BN19C-2E	5	PowerCable 240V, C-Europe
8	BN38C-02	1	Ultra Cbl VHDCI - 68HD
9	LK461-AF	1	VMS STYLE KEYBOARD, Fin/Swed

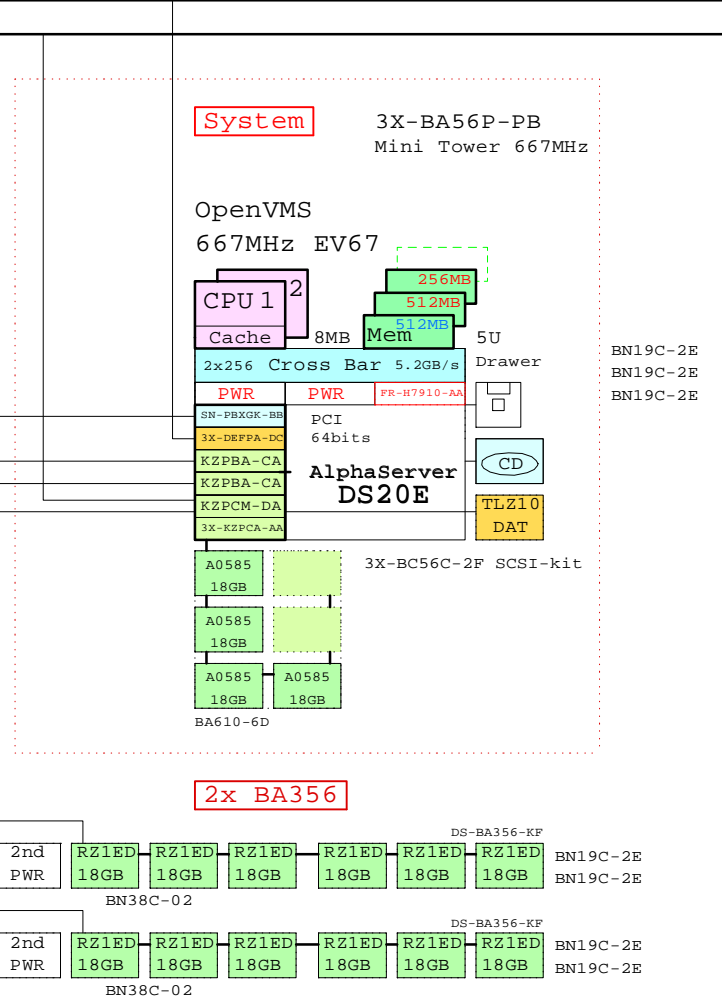
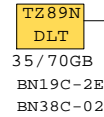
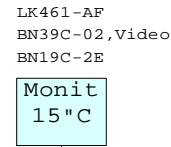

[www.Compaq.com/golden-eggs](http://www.Compaq.com/golden-eggs)  
Since:Jun-2000

<b>COMPAQ</b>	05-Feb-2001	GTAVDS20EA
	Matti.Patari@compaq.com	

AlphaServer DS20E OpenVMS Syst  
GOLDEN EGGS Visuals, Helsinki

This template is included in the present GOLDEN EGGS Software kit.

DS20E OVMS

DS20E expanded OpenVMS RAID system

FDDI

Ethernet

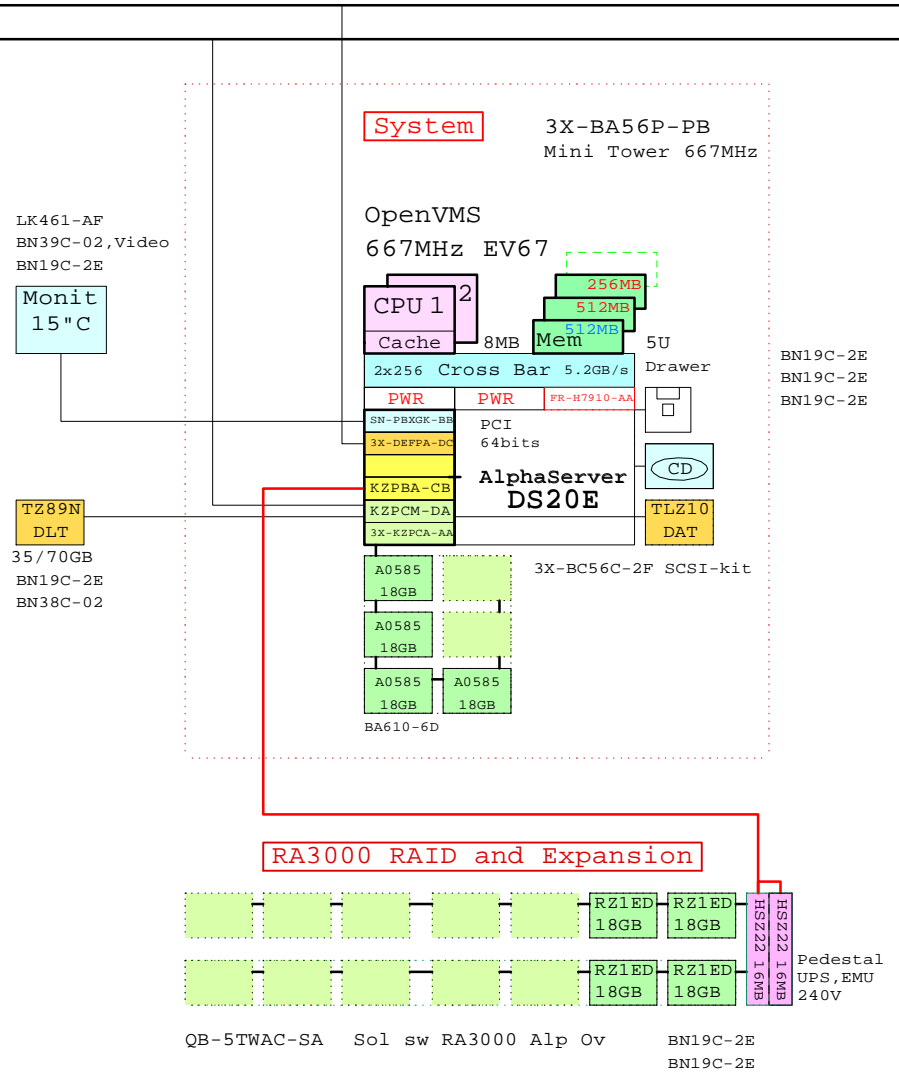
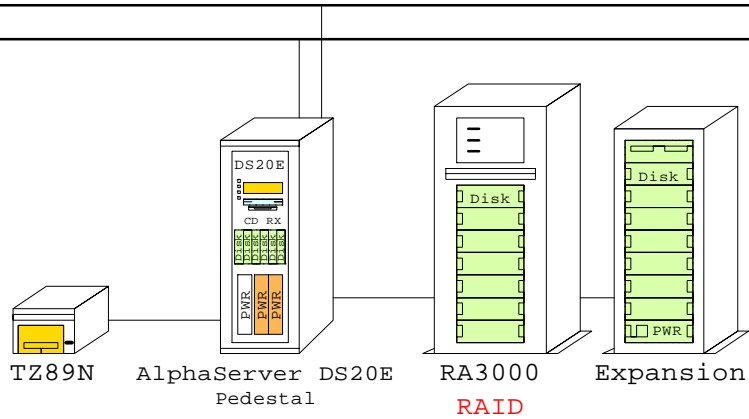

Bill of material

Part Number	Qty	Description
1	3X-BA56P-PB	1 DS20E Mini tower pedestal kit,667MHz
1.1	DY-56PAA-EA	1 AS DS20E 6/667 512MB,Rack,OVMS
1.1.1	3X-BC56C-2F	1 DS20E SCSI Cable Kit
1.1.2	3X-DEFFA-DC	1 PCI to FDDI DAS MMF with SC,Universal
1.1.3	3X-KZPCA-AA	1 Single channel LVD adapter
1.1.4	BA610-6D	1 ES40 Disk Drive Cage, 6-Bay
1.1.4.1	3R-A0585-AA	4 18.2GB Uscsi3 10k Universal disk 1"
1.1.5	FR-H7910-AA	1 Third power supply for DS20E
1.1.6	KN311-BC	1 AS DS20E 6/667 SMP UPG OpenVMS
1.1.7	KZPBA-CB	1 PCI to UltraSCSI Adapter UWDif
1.1.8	KZPCM-DA	1 Dual Uscsi with FastEther PCI
1.1.9	MS340-CA	1 DS20 256MB SDIMM MEM 4x64MB
1.1.10	MS340-DA	1 DS20 512MB SDIMM MEM 4x128MB
1.1.11	SN-PBXGK-BB	1 Elsa Gloria Synergy 8M Video Graphics
1.1.12	TLZ10-LB	1 12/24GB 4mm DAT 5.25" HH
2	DS-SWXRA-GC	1 RA3000 Pedestal one Hsz22 240V
2.1	DS-HSZ22-AA	1 Hsz22 controller 16MB
2.2	DS-RZ1ED-VW	2 18.2GB 10000r UltraSCSI disk
2.3	DS-SWXRA-GD	1 RA3000 Pedestal Expans 120/240
2.3.1	DS-RZ1ED-VW	2 18.2GB 10000r UltraSCSI disk
3	QB-5TWAC-SA	1 Sol sw RA3000 Alp Ovms
4	3R-A2832-AA	1 COMPAQ Monitor S510 15" NH, EU
5	DS-TZ89N-TA	1 35/70GB SE DLT-tape TT FWSE
6	BN39C-02	1 1.8 Video Extension Cable ****
7	BN19C-2E	7 PowerCable 240V, C-Europe
8	BN38C-02	1 Ultra Cbl VHDCI - 68HD
9	LK461-AF	1 VMS STYLE KEYBOARD, Fin/Swed

[www.Compaq.com/golden-eggs](http://www.Compaq.com/golden-eggs)

Since:Jun-2000

<b>COMPAQ</b>	05-Feb-2001	GTAVDS20EB
	Matti.Patari@compaq.com	
AlphaServer DS20E OpenVMS RAID		
GOLDEN EGGS Visuals, Helsinki		

DS20E OpenVMS Cluster with in-cabinet RA3000 RAID storage

Ethernet

FDDI

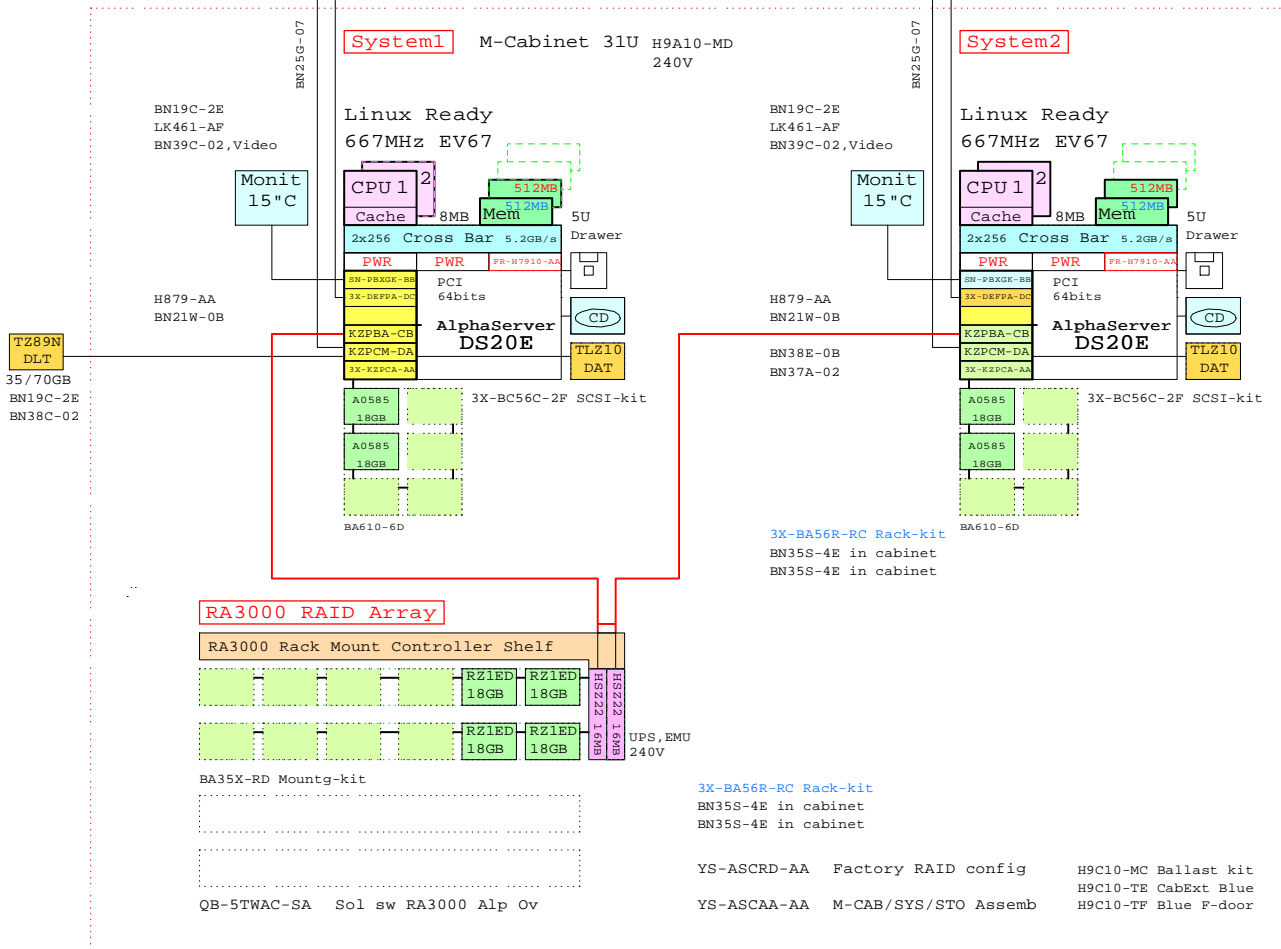

BOM for this cabinet system

Part Number	Qty	Description
1	1	H9A10-MD 1 M-Series Cab,H9A10,Blue,240V 31U
1.1	2	3R-A2832-AA 2 COMPAQ Monitor S510 15" NH_EU
1.2	2	3X-BA56R-RC 2 Rackm.Kit, DS20E,667MHz for M-series
1.3	1	BA35X-RD 1 Mounting kit, metric
1.4	2	BN19C-2E 2 PowerCable 240V, C-Europe
1.5	2	BN21W-0B 2 Y SCSI-2 Cable 68 pins/6".15m
1.6	2	BN25G-07 2 17-03212-05 8MP-8MP PATCH CBL
1.7	4	BN35S-4E 4 PowerCord C13 to C14, Non US
1.8	1	BN37A-02 1 Ultra Cbl VHDCI - VHDCI
1.9	1	BN38E-0B 1 Ultra Cbl VHDCI - 68HD
1.10	2	BN39C-02 2 1.8 Video Extension Cable ****
1.11	1	DJ-56PAA-EA 1 AS DS20E 6/667 512MB,Rack,Linux
1.11.1	1	3X-BC56C-2F 1 DS20E SCSI Cable Kit
1.11.2	1	3X-DEFFA-DC 1 PCI to FDDI DAS MMF with SC,Universal
1.11.3	1	3X-KZPCA-AA 1 Single channel LVD adapter
1.11.4	1	BA610-6D 1 ES40 Disk Drive Cage, 6-Bay
1.11.4.1	2	3R-A0585-AA 2 18.2GB Uscsi3 10k Universal disk 1"
1.11.5	1	FR-H7910-AA 1 Third power supply for DS20E
1.11.6	1	KN311-BC 1 AS DS20E 6/667 SMP UPG OpenVMS
1.11.7	1	KZPBA-CB 1 PCI to UltraSCSI Adapter Uwdif
1.11.8	1	KZPCM-DA 1 Dual Uscsi with FastEther PCI
1.11.9	1	MS340-DA 1 DS20 512MB SDIMM MEM 4x128MB
1.11.10	1	SN-PBXGK-BB 1 Elsa Gloria Synergy 8M Video Graphics
1.11.11	1	TLZ10-LB 1 12/24GB 4mm DAT 5.25" HH
1.12	1	DJ-56PAA-EA 1 AS DS20E 6/667 512MB,Rack,Linux
1.12.1	1	3X-BC56C-2F 1 DS20E SCSI Cable Kit
1.12.2	1	3X-DEFFA-DC 1 PCI to FDDI DAS MMF with SC,Universal
1.12.3	1	3X-KZPCA-AA 1 Single channel LVD adapter
1.12.4	1	BA610-6D 1 ES40 Disk Drive Cage, 6-Bay
1.12.4.1	2	3R-A0585-AA 2 18.2GB Uscsi3 10k Universal disk 1"
1.12.5	1	FR-H7910-AA 1 Third power supply for DS20E
1.12.6	1	KN311-BC 1 AS DS20E 6/667 SMP UPG OpenVMS
1.12.7	1	KZPBA-CB 1 PCI to UltraSCSI Adapter Uwdif
1.12.8	1	KZPCM-DA 1 Dual Uscsi with FastEther PCI
1.12.9	1	MS340-DA 1 DS20 512MB SDIMM MEM 4x128MB
1.12.10	1	SN-PBXGK-BB 1 Elsa Gloria Synergy 8M Video Graphics
1.12.11	1	TLZ10-LB 1 12/24GB 4mm DAT 5.25" HH
1.13	1	DS-SWXRA-GK 1 RA3000 Rackmount one HSZ22 240V
1.13.1	1	DS-HSZ22-AA 1 HSZ22 controller 16MB
1.13.2	1	DS-SWXRA-GN 1 RA3000 Rackmount Expan 120/240
1.13.2.1	2	DS-RZ1ED-VN 2 18.2GB 10000r UltraSCSI disk
1.13.3	1	DS-SWXRA-GN 1 RA3000 Rackmount Expan 120/240
1.13.3.1	2	DS-RZ1ED-VN 2 18.2GB 10000r UltraSCSI disk
1.14	2	H879-AA 2 SCSI-3 Term - 68 pin Male
1.15	1	H9C10-MC 1 Ballast Kit for cabinets
1.16	1	H9C10-TE 1 Rear cab extender for H9A10 Blue
1.17	1	H9C10-TF 1 FrontDoorKit Blue for H9A10
1.18	2	LK461-AF 2 VMS STYLE KEYBOARD, Fin/Swed
1.19	1	QB-5TWAC-SA 1 Sol sw RA3000 Alp Ovms
1.20	1	YS-ASCAA-AA 1 M-CAB/SYS/STO Assembly
1.21	1	YS-ASCRD-AA 1 Factory configured RAID sets of BA370
2	1	DS-TZ89N-TA 1 35/70GB SE DLT-tape TT FWSE
3	1	BN19C-2E 1 PowerCable 240V, C-Europe
4	1	BN38C-02 1 Ultra Cbl VHDCI - 68HD

www.Compaq.com/golden-eggs  
Since:Jun-2000

<b>COMPAQ</b>	05-Feb-2001	GTAVDS20EC
	Mattl.Patari@Compaq.com	

AlphaServer DS20E OVMS Cluster  
GOLDEN EGGs Visuals, Helsinki

DS20E OVMS

This template is included in the present GOLDEN EGGs Software kit.

## DS20E OpenVMS Cluster with in-cabinet RAID storage

Ethernet

FDDI

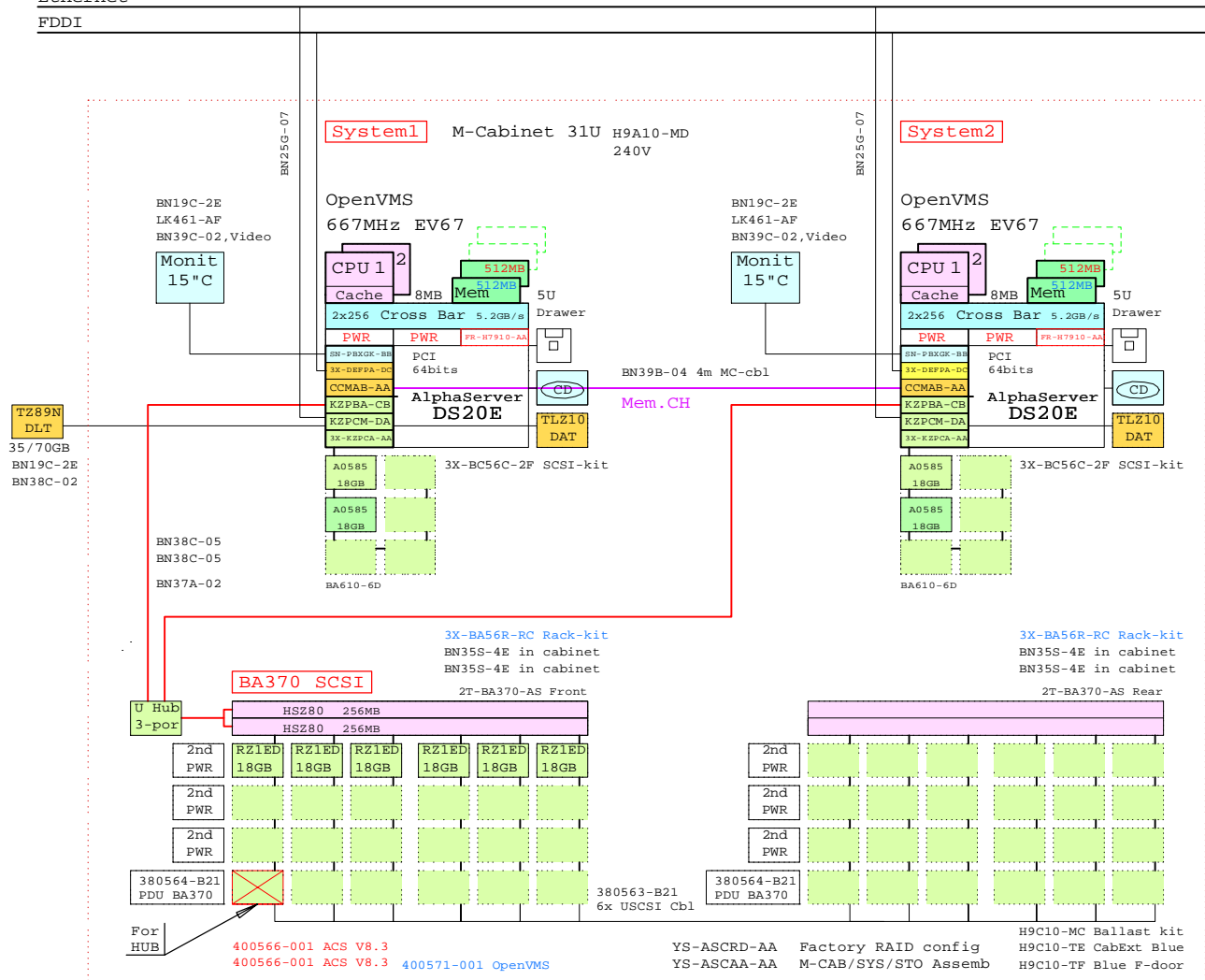

BOM for this cabinet system

Part Number	Qty	Description
1		H9A10-MD 1 M-Series Cab,H9A10,Blue,240V 31U
1.1		2T-BA370-AR 1 BA370 shelf,slides Rear RackMount
1.1.1		380564-B21 1 Power Distribution Unit RABk/7k
1.1.2		380565-B21 3 Power Supply 180W Hot Plug SBB
1.2		2T-BA370-AS 1 BA370 shelf,slides Front RackMount
1.2.1		380564-B21 3 Power Distribution Unit RABk/7k
1.2.2		380565-B21 3 Power Supply 180W Hot Plug SBB
1.2.3		400565-B21 2 Ultra Opt.1 cont w 2x128MB cache HSZ80
1.2.4		DS-DWZZH-03 1 Uscsi Act hub 0 SE:3/Dif 3.5" SBB
1.2.5		DS-RZ1ED-VW 6 18.2GB 10000r UltraSCSI disk
1.3		380563-B21 1 Set of six USCSI cables
1.4		3R-A2832-AA 2 COMPAQ Monitor S510 15" NH, EU
1.5		3X-BA56R-RC 2 Rackm.kit, DS20E,667MHz for M-series
1.6		400566-001 2 HSZ80 Controller Software ACS V8.3
1.7		400571-001 1 Ultra opt OS Software OpenVMS
1.8		BN19C-2E 2 PowerCable 240V, C-Europe
1.9		BN25G-07 2 17-03212-05 8MP-8MP PATCH CBL
1.10		BN35S-4E 4 PowerCord C13 to C14, Non US
1.11		BN37A-02 1 Ultra Cbl VHDCI - VHDCI
1.12		BN38C-05 2 Ultra Cbl VHDCI - 6BHD
1.13		BN39B-04 1 04m copper cbl for CCMAB Mem.Chan
1.14		BN39C-02 2 1.8 Video Extension Cable ****
1.15		DY-56PAA-EA 1 AS DS20E 6/667 512MB,Rack,OVMS
1.15.1		3X-BC56C-2F 1 DS20E SCSI Cable Kit
1.15.2		3X-DEFPA-DC 1 PCI to FDDI DAS MMF with SC,Universal
1.15.3		3X-KZPCA-AA 1 Single channel LVD adapter
1.15.4		BA610-6D 1 ES40 Disk Drive Cage, 6-Bay
1.15.4.1		3R-A0585-AA 2 18.2GB Uscsi3 10k Universal disk 1"
1.15.5		CCMAB-AA 1 PCI Mem. Channel-2 Cluster cntrl
1.15.6		FR-H7910-AA 1 Third power supply for DS20E
1.15.7		KN311-BC 1 AS DS20E 6/667 SMP UPG OpenVMS
1.15.8		KZPBA-CB 1 PCI to UltraSCSI Adapter Umdif
1.15.9		KZPCM-DA 1 Dual Uscsi with FastEther PCI
1.15.10		MS340-DA 1 DS20 512MB SDIMM MEM 4x128MB
1.15.11		SN-PBXGK-BB 1 Elsa Gloria Synergy 8M Video Graphics
1.15.12		TLZ10-LB 1 12/24GB 4mm DAT 5.25" HH
1.16		DY-56PAA-EA 1 AS DS20E 6/667 512MB,Rack,OVMS
1.16.1		3X-BC56C-2F 1 DS20E SCSI Cable Kit
1.16.2		3X-DEFPA-DC 1 PCI to FDDI DAS MMF with SC,Universal
1.16.3		3X-KZPCA-AA 1 Single channel LVD adapter
1.16.4		BA610-6D 1 ES40 Disk Drive Cage, 6-Bay
1.16.4.1		3R-A0585-AA 2 18.2GB Uscsi3 10k Universal disk 1"
1.16.5		CCMAB-AA 1 PCI Mem. Channel-2 Cluster cntrl
1.16.6		FR-H7910-AA 1 Third power supply for DS20E
1.16.7		KN311-BC 1 AS DS20E 6/667 SMP UPG OpenVMS
1.16.8		KZPBA-CB 1 PCI to UltraSCSI Adapter Umdif
1.16.9		KZPCM-DA 1 Dual Uscsi with FastEther PCI
1.16.10		MS340-DA 1 DS20 512MB SDIMM MEM 4x128MB
1.16.11		SN-PBXGK-BB 1 Elsa Gloria Synergy 8M Video Graphics
1.16.12		TLZ10-LB 1 12/24GB 4mm DAT 5.25" HH
1.17		H9C10-MC 1 Ballast Kit for cabinets
1.18		H9C10-TE 1 Rear cab extender for H9A10 Blue
1.19		H9C10-TF 1 FrontDoorKit Blue for H9A10
1.20		LK461-AF 2 VMS STYLE KEYBOARD, Fin/Swed
1.21		YS-ASCAA-AA 1 M-CAB/SYS/STO Assembly
1.22		YS-ASCRD-AA 1 Factory configured RAID sets of BA370
2		DS-TZ89N-TA 1 35/70GB SE DLT-tape TT FWSE
3		BN19C-2E 1 PowerCable 240V, C-Europe
4		BN38C-02 1 Ultra Cbl VHDCI - 6BHD

www.Compaq.com/golden-eggs  
Since:Apr-2000

<b>COMPAQ</b>	06-Feb-2001	GTAVDS20ED
	Matti.Patari@Compaq.com	
AlphaServer DS20E OVMS Cluster GOLDEN EGGS Visuals, Helsinki		

This template is included in the present GOLDEN EGGS Software kit.

**DS20E** OVMS

**DS20E OpenVMS Cluster with in-cabinet RAID storage, No single point.**

Ethernet

FDI

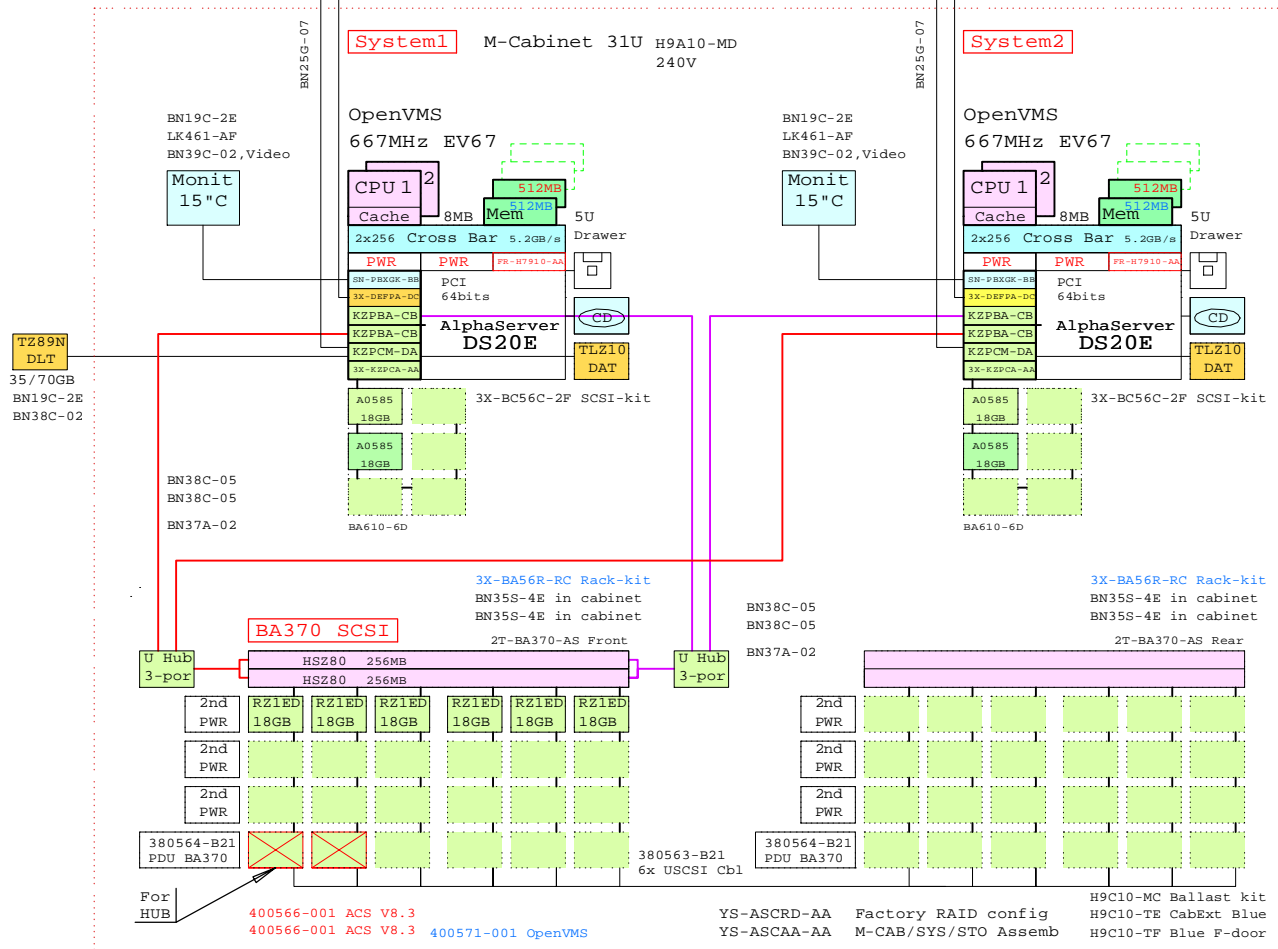

BOM for this cabinet system

Part Number	Qty	Description
1	H9A10-MD	1 M-Series Cab,H9A10,Blue,240V 31U
1.1	2T-BA370-AR	1 BA370 shelf,slides Rear RackMount
1.1.1	380564-B21	1 Power Distribution Unit RA8k/7k
1.1.2	380565-B21	3 Power Suply 180W Hot Plug SBB
1.1.3	BN37A-02	1 Ultra Cbl VHDCI - VHDCI
1.2	2T-BA370-AS	1 BA370 shelf,slides Front RackMount
1.2.1	380564-B21	1 Power Distribution Unit RA8k/7k
1.2.2	380565-B21	3 Power Suply 180W Hot Plug SBB
1.2.3	400565-B21	2 Ultra Opt.1 cont w 2x128MB cache HS280
1.2.4	DS-DWZZH-03	1 Uscsi Act hub 0 SE:3/Dif 3.5" SBB
1.2.5	DS-RZ1ED-VW	6 18.2GB 10000r UltraSCSI disk
1.3	380563-B21	1 Set of six USCSI cables
1.4	3R-A2832-AA	2 COMPAQ Monitor S510 15" NH, EU
1.5	3X-BA56R-RC	2 Rackm.kit, DS20E,667MHz for M-series
1.6	400566-001	2 HSZ80 Controller Software ACS V8.3
1.7	400571-001	1 Ultra opt OS Software OpenVMS
1.8	BN19C-2E	2 PowerCable 240V, C-Europe
1.9	BN25G-07	2 17-03212-05 8MP-8MP PATCH CBL
1.10	BN35S-4E	4 PowerCord C13 to C14, Non US
1.11	BN37A-02	1 Ultra Cbl VHDCI - VHDCI
1.12	BN38C-05	4 Ultra Cbl VHDCI - 68HD
1.13	BN39C-02	2 1.8 Video Extension Cable ****
1.14	DS-DWZZH-03	1 Uscsi Act hub 0 SE:3/Dif 3.5" SBB
1.15	DY-56PAA-EA	1 AS DS20E 6/667 512MB,Rack_OVMS
1.15.1	3X-BC56C-2F	1 DS20E SCSI Cable Kit
1.15.2	3X-DEPFA-DC	1 PCI to FDDI DAS MMF with SC,Universal
1.15.3	3X-KZPCA-AA	1 Single channel LVD adapter
1.15.4	BA610-6D	1 ES40 Disk Drive Cage, 6-Bay
1.15.4.1	3R-A0585-AA	2 18.2GB Uscsi3 10k Universal disk 1"
1.15.5	FR-H7910-AA	1 Third power supply for DS20E
1.15.6	KN311-BC	1 AS DS20E 6/667 SMP UPG OpenVMS
1.15.7	KZPBA-CB	2 PCI to UltraSCSI Adapter Uwdif
1.15.8	KZPCM-DA	1 Dual Uscsi with FastEther PCI
1.15.9	MS340-DA	1 DS20 512MB SDIMM MEM 4x128MB
1.15.10	SN-PBXGK-BB	1 Elsa Gloria Synergy 8M Video Graphics
1.15.11	TLZ10-LB	1 12/24GB 4mm DAT 5.25" HH
1.16	DY-56PAA-EA	1 AS DS20E 6/667 512MB,Rack_OVMS
1.16.1	3X-BC56C-2F	1 DS20E SCSI Cable Kit
1.16.2	3X-DEPFA-DC	1 PCI to FDDI DAS MMF with SC,Universal
1.16.3	3X-KZPCA-AA	1 Single channel LVD adapter
1.16.4	BA610-6D	1 ES40 Disk Drive Cage, 6-Bay
1.16.4.1	3R-A0585-AA	2 18.2GB Uscsi3 10k Universal disk 1"
1.16.5	FR-H7910-AA	1 Third power supply for DS20E
1.16.6	KN311-BC	1 AS DS20E 6/667 SMP UPG OpenVMS
1.16.7	KZPBA-CB	2 PCI to UltraSCSI Adapter Uwdif
1.16.8	KZPCM-DA	1 Dual Uscsi with FastEther PCI
1.16.9	MS340-DA	1 DS20 512MB SDIMM MEM 4x128MB
1.16.10	SN-PBXGK-BB	1 Elsa Gloria Synergy 8M Video Graphics
1.16.11	TLZ10-LB	1 12/24GB 4mm DAT 5.25" HH
1.17	H9C10-MC	1 Ballast Kit for cabinets
1.18	H9C10-TE	1 Rear cab extender for H9A10 Blue
1.19	H9C10-TF	1 FrontDoorKit Blue for H9A10
1.20	LK461-AF	2 VMS STYLE KEYBOARD, Fin/Swed
1.21	YS-ASCAA-AA	1 M-CAB/SYS/STO Assembly
1.22	YS-ASCRD-AA	1 Factory configured RAID sets of BA370
2	DS-TZ89N-TA	1 35/70GB SE DLT-tape TT FWSE
3	BN19C-2E	1 PowerCable 240V, C-Europe
4	BN38C-02	1 Ultra Cbl VHDCI - 68HD

www.Compaq.com/golden-eggs  
Since:Apr-2000

<b>COMPAQ</b>	06-Feb-2001	GTAVIDS20EE
	MattI.Patarie@Compaq.com	

AlphaServer DS20E OVMS Cluster  
GOLDEN EGGS Visuals, Helsinki

This template is included in the present GOLDEN EGGS Software kit.

**DS20E** OVMS

FDDI

Ethernet

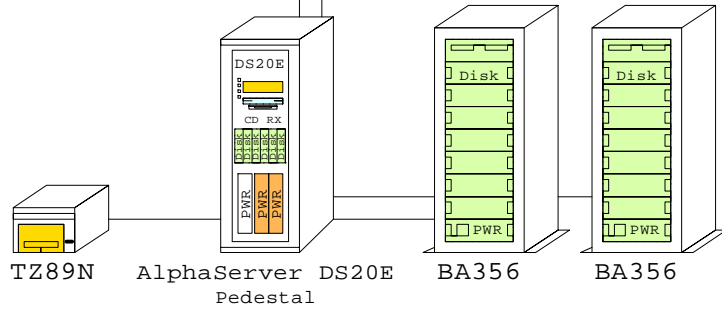

DS20E expanded Linux system

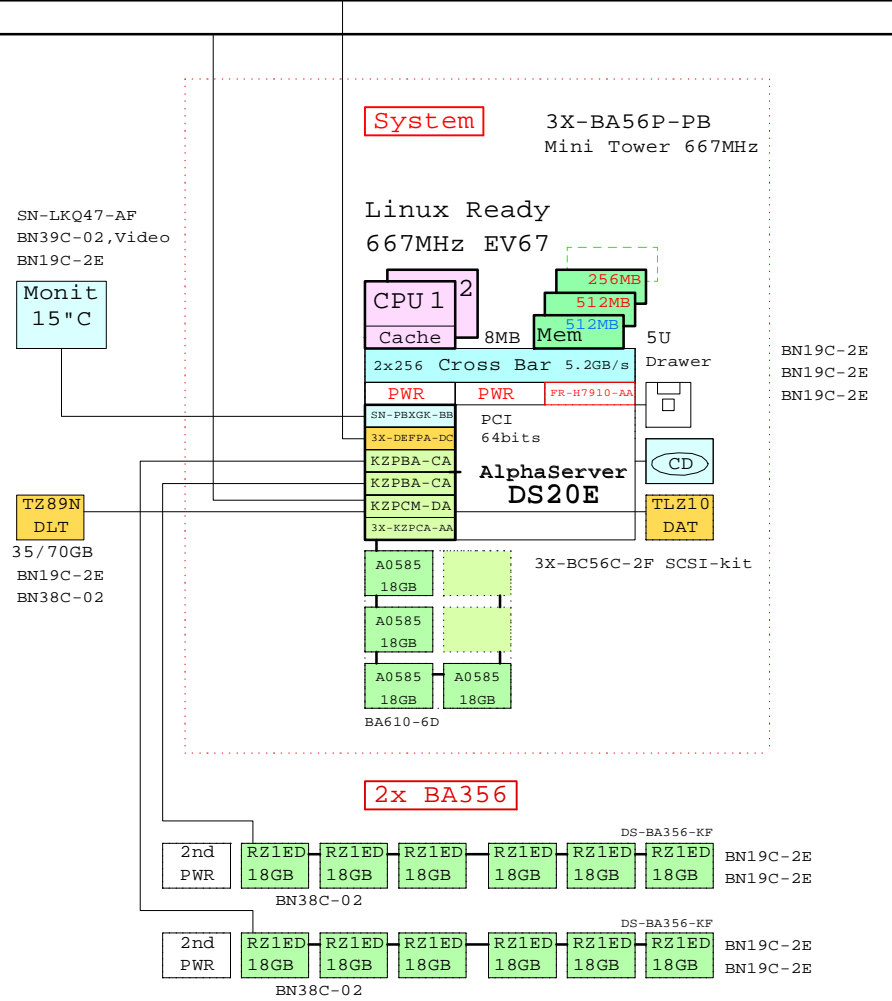

Bill of material

	Part Number	Qty	Description
1	3X-BA56P-PB	1	DS20E Mini tower pedestal kit,667MHz
1.1	DJ-56PAA-EA	1	AS DS20E 6/667 512MB,Rack, Linux
1.1.1	3X-BC56C-2F	1	DS20E SCSI Cable Kit
1.1.2	3X-DEFPA-DC	1	PCI to FDDI DAS MMF with SC,Universal
1.1.3	3X-KZPCA-AA	1	Single channel LVD adapter
1.1.4	BA610-6D	1	ES40 Disk Drive Cage, 6-Bay
1.1.4.1	3R-A0585-AA	4	18.2GB Uscsi3 10k Universal disk 1"
1.1.5	FR-H7910-AA	1	Third power supply for DS20E
1.1.6	KN311-BD	1	AS DS20E 6/667 SMP UPG for Linux
1.1.7	KZPBA-CA	2	PCI to UltraSCSI Adapter UWSE
1.1.8	KZPCM-DA	1	Dual Uscsi with FastEther PCI
1.1.9	MS340-CA	1	DS20 256MB SDIMM MEM 4x64MB
1.1.10	MS340-DA	1	DS20 512MB SDIMM MEM 4x128MB
1.1.11	SN-PBXGK-BB	1	Elsa Gloria Synergy 8M Video Graphics
1.1.12	TLZ10-LB	1	12/24GB 4mm DAT 5.25" HH
2	DS-BA356-KF	1	Pedestal Storage, UltraW, Single-Bus
2.1	BN19C-2E	2	PowerCable 240V, C-Europe
2.2	BN38C-02	1	Ultra Cbl VHDCI - 68HD
2.3	CK-BA35X-HH	1	180W Stor.Shelf PWR for AS4x00
2.4	DS-RZ1ED-VW	6	18.2GB 10000r UltraSCSI disk
3	DS-BA356-KF	1	Pedestal Storage, UltraW, Single-Bus
3.1	BN19C-2E	2	PowerCable 240V, C-Europe
3.2	BN38C-02	1	Ultra Cbl VHDCI - 68HD
3.3	CK-BA35X-HH	1	180W Stor.Shelf PWR for AS4x00
3.4	DS-RZ1ED-VW	6	18.2GB 10000r UltraSCSI disk
4	3R-A2832-AA	1	COMPAQ Monitor S510 15" NH, EU
5	DS-TZ89N-TA	1	35/70GB SE DLT-tape TT FWSE
6	BN39C-02	1	1.8 Video Extension Cable ****
7	SN-LKQ47-AF	1	102 KEY KYBD, NON-WIN, Finnish
8	BN19C-2E	5	PowerCable 240V, C-Europe
9	BN38C-02	1	Ultra Cbl VHDCI - 68HD

This template is included in the present GOLDEN EGGS Software kit.

DS20E Linux

[www.Compaq.com/golden-eggs](http://www.Compaq.com/golden-eggs)  
Since: Jun-2000

**COMPAQ** 05-Feb-2001 GTALDS20EA  
Matti.Patari@compaq.com

AlphaServer DS20E Linux System  
GOLDEN EGGS Visuals, Helsinki



# AlphaServer ES40 68/833 Systems, 64bits 833MHz

Model	Tru64 UNIX	OpenVMS	Linux Ready
<b>#1</b> M1 6xPCI	-CA 512MB -DA 1GB -EA 2GB	-CA 512MB -DA 1GB -EA 2GB	DJ-62CAA-CA 512MB
M2 10xPCI	-DA 1GB -EA 2GB -FA 4GB	-DA 1GB -EA 2GB -FA 4GB	

**#2** Select Enclosure, Disk Cage, Disk Drive, USCSI Controller, Ethernet and Graphics.

Mini-Tower	Pedestal - BA356	Cabinet - Modula
BA61M-MT Mini-Tower box	BA61P-PA/PB Pedestal 120/240V	H9A15-MC/MD Cabinet 120V/240V, 39U
3X-KZPCA-AA USCSI adapter	KZPCM-DA 2xUSCSI+ Ethernet	H9C15-TE Cabinet rear extender
BA610-6D Disk Drive Cage	BN37A-02 SCSI cable, 2m	H9C15-TF Cabinet front door
3R-A0585-AA Disk 18.2GB 10k	BA36R-RC Single-buss shelf	H9C10-MC Ballast kit, 40lbs
3R-A0919-AA Disk 36.4GB 10k	BA36R-RD Split-buss shelf	BA61R-RM Rack mount kit
3X-DE600-AA Ethernet 10/100	DS-RZ1DD-VW Disk 9.1GB 10k	YS-ASCAA-AA Factory integration
BN25G-10 Cable, twisted	DS-RZ1ED-VW Disk 18.2GB 10k	3X-KZPCA-AA Ultra2 SCSI adapte, 1-2
SN-PBXGK-BB ElsaGloria 8MB	BN25G-10 Cable, twisted	BN38C-05 SCSI cable, 5m, 1-2
	SN-PBXGK-BB ElsaGloria 8MB	DS-SL13R-AB Shelf M4314, single b.
		DS-SL13R-BB Shelf M4354, dual bus
		3R-A1543-AA Disk 18.2GB 15k
		3X-DE600-AA Ethernet 10/100
		BN25G-10 Cable, twisted
		SN-PBXGK-BB ElsaGloria 8MB

**#3** SVGA color monitor **#4** For 240V use, select keyboard and power cord

15" 3R-VRQV5-24/11	SN-LKQ47 -AE GB -AG G -AM S	BN19C-2E Europe
17" 3R-VRQP7-24/23	UNIX, Lin -AB B -AH NL -AN N	BN19A-2E GB
North/South	LK461 -AD DK -AI I -AP F	BN19E-2E CH
BN39C-02 2m ext.cable	OVMS -AF FI -AK CH -AS E	BN19K-2E DK
		BN19Z-2E I

## Internal options

### Memory expansion

MS610-DA	1GB
MS610-EA	2GB
MS610-FA	4GB

### Additional CPUs, Max 4

UNIX	KN610-CB	833MHz
OVMS	KN610-CC	833MHz
Linux	KN610-CA	833MHz

### Power supplies, CPU 3-4 and/or for the second disk cage

H7906-A9	CPU power
CK-BA35X-HH	2nd disk pwr

### Internal storage

#### Tape storage

TLZ10-LB	12/24GB DAT Tape drive
3X-BN46M-01	Multi head SCSI cable

#### Disk storage

3R-A0585-AA	18GB Universal disk 10k
3R-A0919-AA	36GB Universal disk 10k

KZPBA-CA	UltraSCSI SE adapter
BN38C-02	2m SCSI cable, 68HD-VHDCI
KZPCM-DA	Dual UltraSCSI+ Ethernet
BN37A-02	2m SCSI cable, VHDCI-VHDC

KZPAC-CB	RAID 3-port, 8MB cache
KZPSC-UB	Cache battery
KZPAC-SB	Dual cable bulkhead
BN37A-02	2m SCSI cable VHDCI-VHDCI

### Controllers

3X-DE600-AA	Fast Ethernet
DEGPA-SA	Gigabit Ethernet
3X-DEFPA-AC	FDDI adapter, SAS MMF
CCMAB-AA	Memory Channel
CIPCA-BA	CI controller
DS-KGPSA-CA	Fibre Channel adapt
168794-B21	--" --

### External options

DS-TZ89N-TA	35/70GB DLT tape, TT
BN21K-02	SCSI cable, FWD
BN19C-2E	Power cord, Europe
KZPBA-CA	UltraSCSI SE adapter

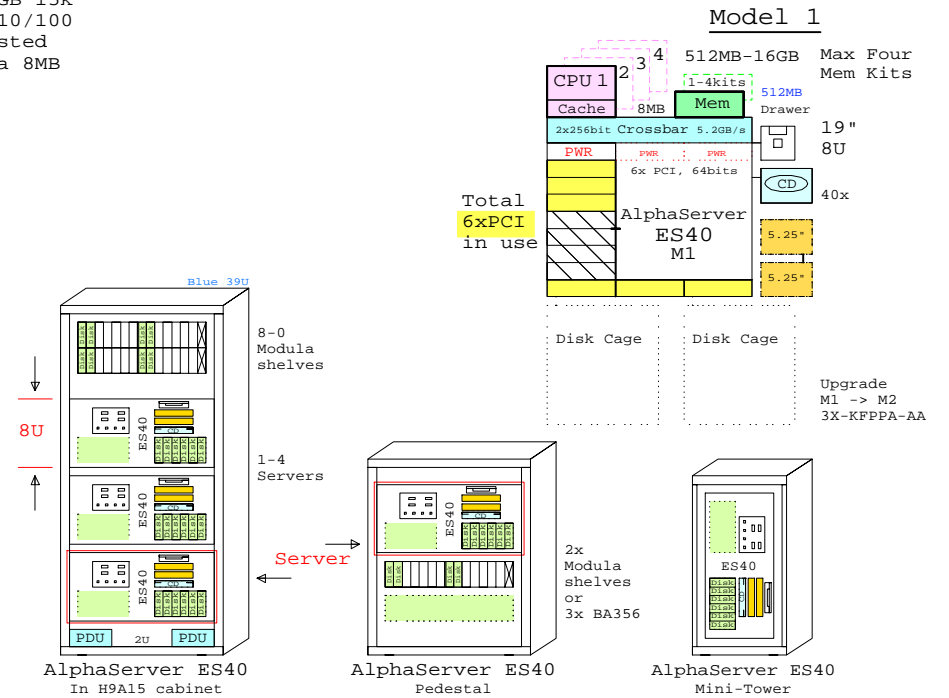
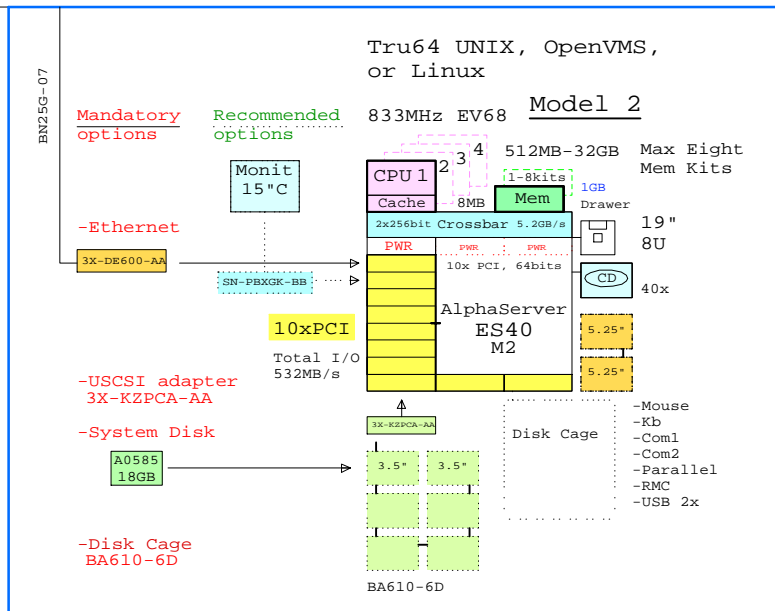

	@833MHz	@667MHz
SPECint95	40	83
SPECfp95	68	685
SPECweb99		

Software Processor Code: **E**

<b>COMPAQ</b>	30-Jan-2001	GEAES403
	Matti.Patari@compaq.com	

AlphaServer ES40 833MHz Syst.  
GOLDEN EGGS Visuals, Helsinki

Tru64 UNIX, OpenVMS,  
or Linux

833MHz EV68 Model 1

BN25G-07

**Mandatory options**

**Recommended options**

Monit  
15" C

-Ethernet  
3X-DE600-AA

SN-PBXK-BB

-USCSI adapter  
3X-KZPCA-AA

**10xPCI**

-System Disk  
A0585  
18GB

-Disk Cage  
BA610-6D

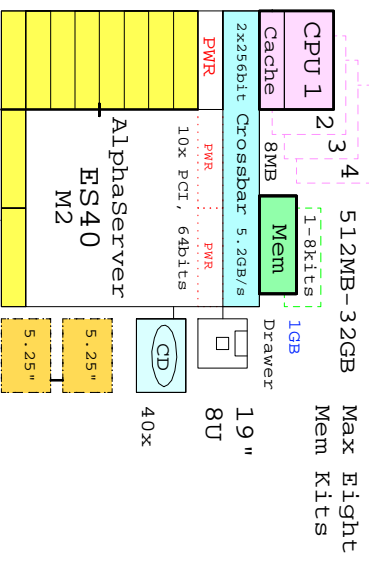

Model 2

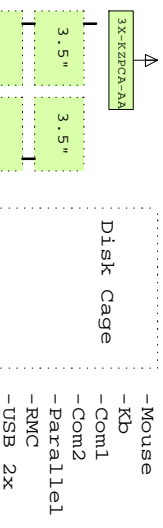

Model 1

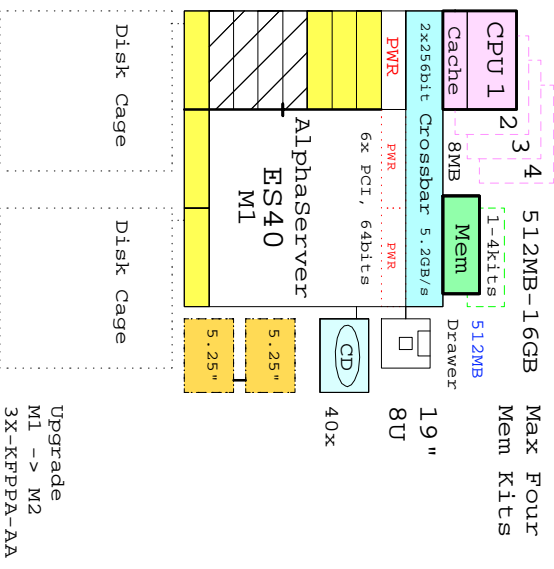

Total  
**6xPCI**  
in use

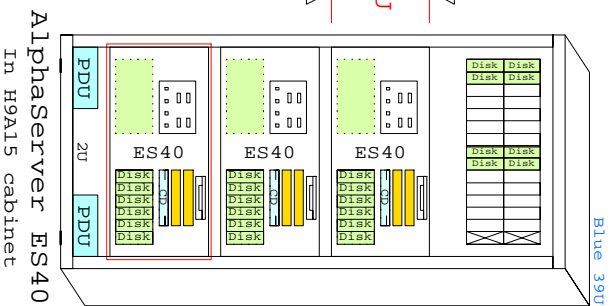

AlphaServer ES40  
In H9A15 cabinet

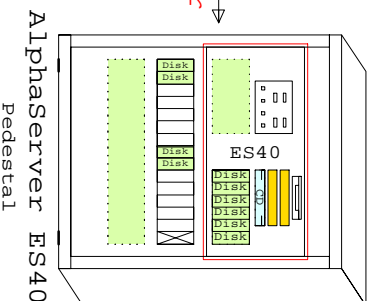

AlphaServer ES40  
Pedestal

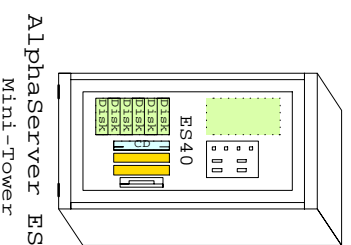

AlphaServer ES40  
Mini-Tower

Software Processor Code: **E**

**COMPAQ**

30-Jan-2001 GEAES403  
Mattei.Patarini@compaq.com

SPECInt95  
SPECfp95  
SPECweb99

@833MHZ @667MHZ  
40 83 685

www.Compaq.com/golden-eggs

Since Jan-2001

**ES40**

AlphaServer ES40 833MHz Syst.  
GOLDEN EGGS Visuals, Helsinki

BN25G-07

Tru64 UNIX, OpenVMS,  
or Linux

833MHz EV68 Model 2

Mandatory options

Recommended options

512MB-32GB Max Eight Mem Kits

Monit  
15" C

CPU 1  
Cache

2 3 4  
8MB

1-8kits  
Mem  
1GB  
Drawer

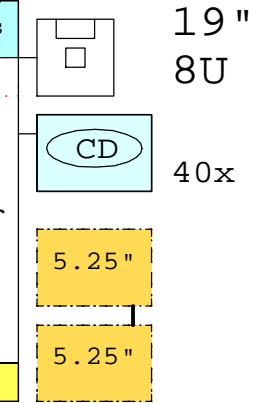
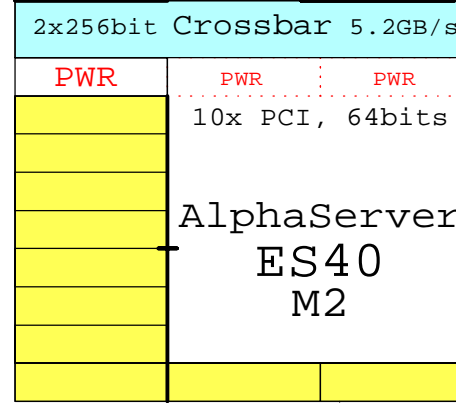

-Ethernet

3X-DE600-AA

SN-PBXGK-BB

10xPCI

Total I/O  
532MB/s

-USCSI adapter  
3X-KZPCA-AA

-System Disk

A0585  
18GB

3X-KZPCA-AA

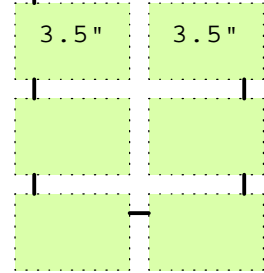

-Disk Cage  
BA610-6D

BA610-6D

- Disk Cage
- Mouse
  - Kb
  - Com1
  - Com2
  - Parallel
  - RMC
  - USB 2x

Ethernet  
FDDI

ES40 Model 2 Mini Tower System

ES40 Model 1 Mini Tower System

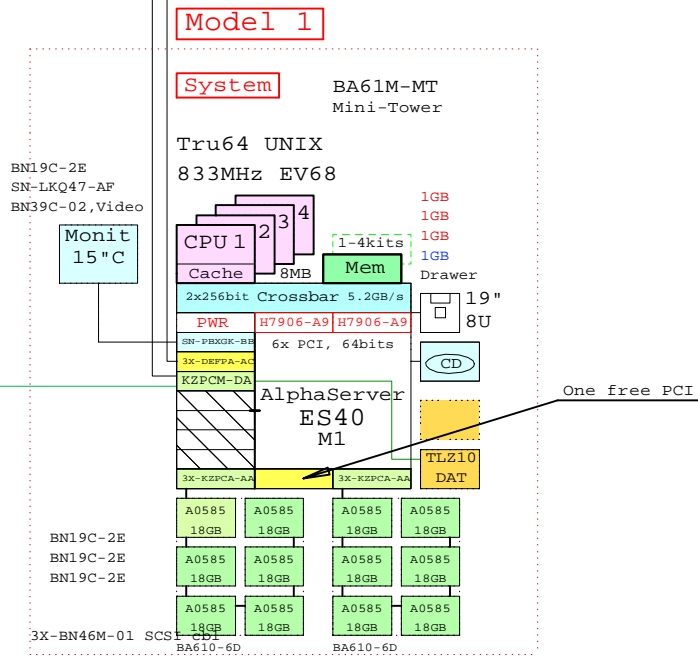
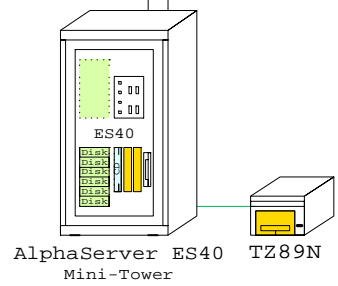
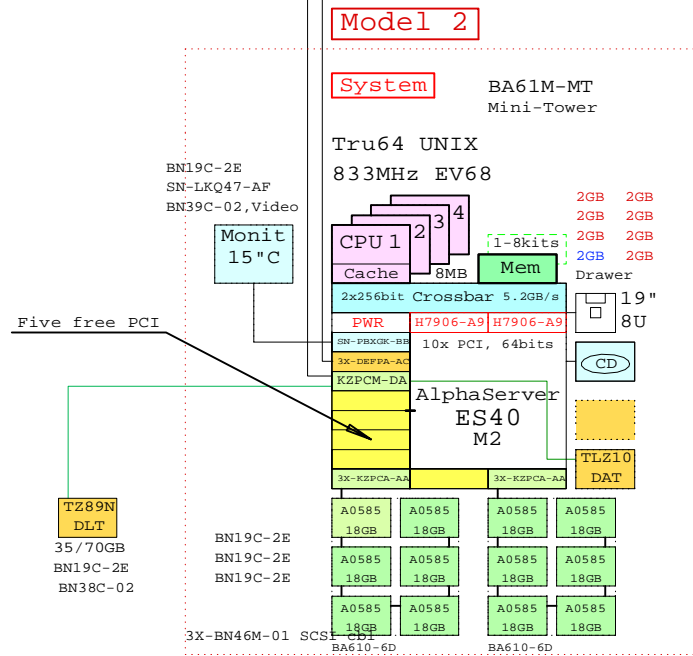

Bill of material, Model 2

Part Number	Qty	Description
1	1	BA61M-MT ES40 Mini-Tower Enclosure
1.1	1	3X-BN46M-01 SCSI cable for Tape
1.2	1	BN19C-2E PowerCable 240V, C-Europe
1.3	1	DA-64CAA-EA ES40 68/833 Model 2 2GB UNIX 10PCI DWR
1.3.1	1	3R-VROV5-24 COMPAQ V55 CLR MON,NH,TCO95
1.3.2	1	3X-DEFFA-AC PCI to FDDI SAS MMF with SC,Universal
1.3.3	2	3X-KZPCA-AA Single channel LVD adapter
1.3.4	1	BA610-6D ES40 Disk Drive Cage, 6-Bay
1.3.4.1	6	3R-A0585-AA 18.2GB Uscsi3 10k Universal disk 1"
1.3.5	1	BA610-6D ES40 Disk Drive Cage, 6-Bay
1.3.5.1	6	3R-A0585-AA 18.2GB Uscsi3 10k Universal disk 1"
1.3.6	3	BN19C-2E PowerCable 240V, C-Europe
1.3.7	1	BN39C-02 1.8 Video Extension Cable ****
1.3.8	2	H7906-A9 ES40 Power Sypl, 2nd or 3rd
1.3.9	3	KN610-CB ES40 68/833MHz UNIX SMP 8mb cache
1.3.10	1	KZPCM-DA Dual Uscsi with FastEther PCI
1.3.11	7	MS610-EA ES40 2GB Memory Option
1.3.12	1	SN-PBXGK-BB Elsa Gloria Synergy 8M Video Graphics
1.3.13	1	TLZ10-LB 12/24GB 4mm DAT 5.25" HH
1.4	1	SN-LKQ47-AF 102 KEY KYBD,NON-WIN, Finnish
2	1	DS-TZ89N-TA 35/70GB SE DLT-tape TT FWSE
3	1	BN19C-2E PowerCable 240V, C-Europe
4	1	BN38C-02 Ultra Cbl VHDCI - 68HD

Bill of material, Model 1

Part Number	Qty	Description
1	1	BA61M-MT ES40 Mini-Tower Enclosure
1.1	1	3X-BN46M-01 SCSI cable for Tape
1.2	1	BN19C-2E PowerCable 240V, C-Europe
1.3	1	DA-62CAA-DA ES40 68/833 Model 1 1GB UNIX 6PCI DWR
1.3.1	1	3R-VROV5-24 COMPAQ V55 CLR MON,NH,TCO95
1.3.2	1	3X-DEFFA-AC PCI to FDDI SAS MMF with SC,Universal
1.3.3	2	3X-KZPCA-AA Single channel LVD adapter
1.3.4	1	BA610-6D ES40 Disk Drive Cage, 6-Bay
1.3.4.1	6	3R-A0585-AA 18.2GB Uscsi3 10k Universal disk 1"
1.3.5	1	BA610-6D ES40 Disk Drive Cage, 6-Bay
1.3.5.1	6	3R-A0585-AA 18.2GB Uscsi3 10k Universal disk 1"
1.3.6	3	BN19C-2E PowerCable 240V, C-Europe
1.3.7	1	BN39C-02 1.8 Video Extension Cable ****
1.3.8	2	H7906-A9 ES40 Power Sypl, 2nd or 3rd
1.3.9	3	KN610-CB ES40 68/833MHz UNIX SMP 8mb cache
1.3.10	1	KZPCM-DA Dual Uscsi with FastEther PCI
1.3.11	3	MS610-DA ES40 1GB Memory Option
1.3.12	1	SN-LKQ47-AF 102 KEY KYBD,NON-WIN, Finnish
1.3.13	1	SN-PBXGK-BB Elsa Gloria Synergy 8M Video Graphics
1.3.14	1	TLZ10-LB 12/24GB 4mm DAT 5.25" HH
2	1	DS-TZ89N-TA 35/70GB SE DLT-tape TT FWSE
3	1	BN19C-2E PowerCable 240V, C-Europe
4	1	BN38C-02 Ultra Cbl VHDCI - 68HD

[www.Compaq.com/golden-eggs](http://www.Compaq.com/golden-eggs)  
Since:Jan-2001

<b>COMPAQ</b>	30-Jan-2001	GTAUES40A
	Matti.Patari@compaq.com	
AlphaServer ES40 Mini Tower		
GOLDEN EGGS Visuals, Helsinki		

Ethernet  
FDDI

ES40 Model 2 Pedestal System

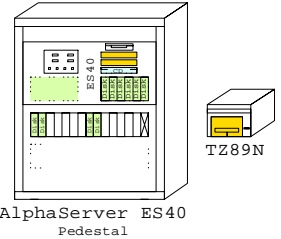
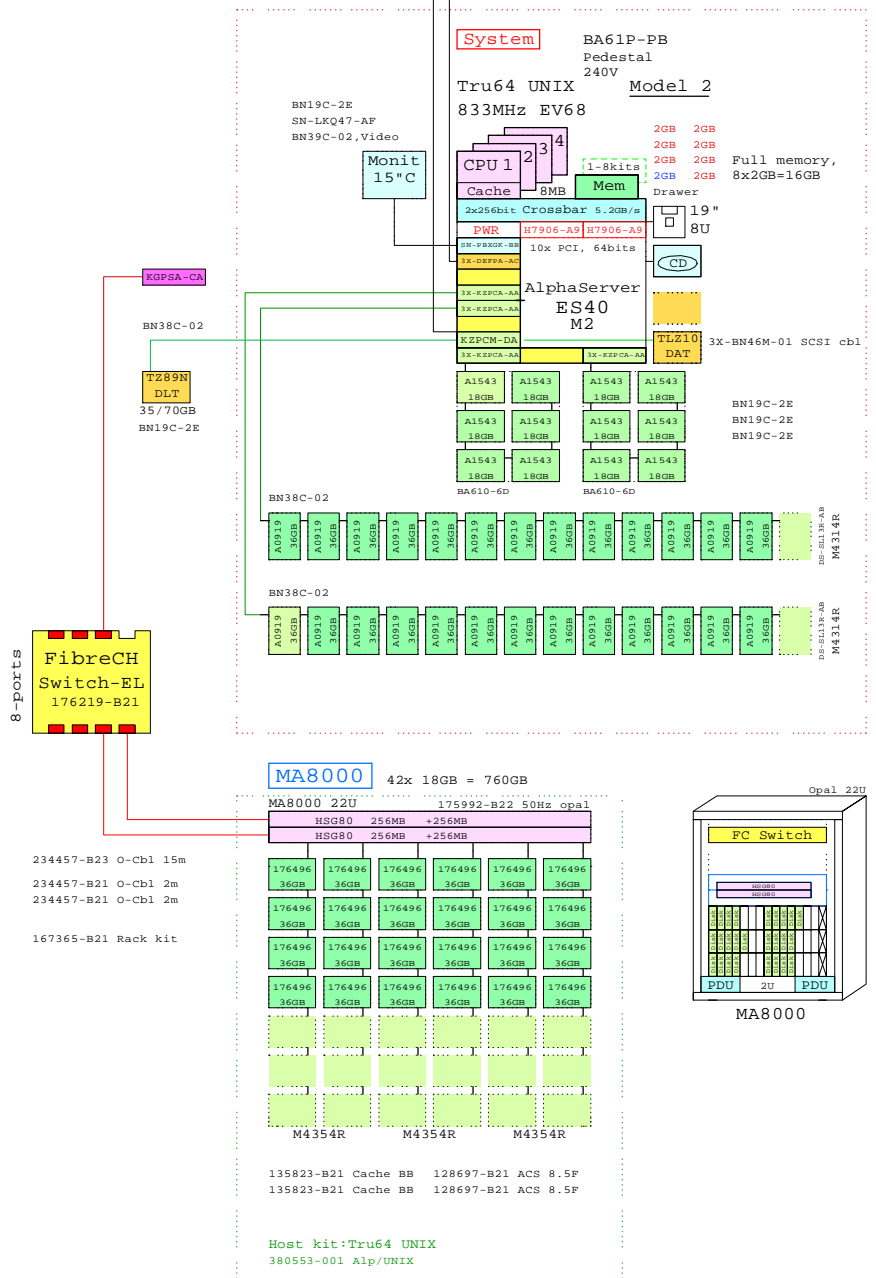

AlphaServer ES40 Pedestal

Bill of material for the base Pedestal

	Part Number	Qty	Description
	BA61P-PB	1	ES40 Pedestal Enclosure 240V Europe
1.1	3X-BN46M-01	1	SCSI cable for Tape
1.2	BN19C-2E	4	PowerCable 240V, C-Europe
1.3	BN38C-02	2	Ultra Cbl VHDCI - 68HD
1.4	BN39C-02	1	1.8 Video Extension Cable ****
1.5	DA-64CAA-EA	1	ES40 68/833 Model 2 2GB UNIX 10PCI DWR
1.5.1	3R-VRQV5-24	1	COMPAQ V55 CLR MON,NH,TCO95
1.5.2	3X-DEFPAC-AA	1	PCI to FDDI SAS MMF with SC,Universal
1.5.3	3X-KZPCA-AA	4	Single channel LVD adapter
1.5.4	BA610-6D	1	ES40 Disk Drive Cage, 6-Bay
1.5.4.1	3R-A1543-AA	6	18.2GB Uscsi3 15k Universal disk 1"
1.5.5	BA610-6D	1	ES40 Disk Drive Cage, 6-Bay
1.5.5.1	3R-A1543-AA	6	18.2GB Uscsi3 15k Universal disk 1"
1.5.6	H7906-A9	2	ES40 Power Syply, 2nd or 3rd
1.5.7	KN610-CB	3	ES40 68/833MHz UNIX SMP 8mb cache
1.5.8	KZPCM-DA	1	Dual Uscsi with FastEther PCI
1.5.9	MS610-EA	7	ES40 2GB Memory Option
1.5.10	SN-PBXGK-BB	1	Elsa Gloria Synergy 8M Video Graphics
1.5.11	TLZ10-LB	1	12/24GB 4mm DAT 5.25" HH
1.6	DS-SL13R-AB	1	Modula M4314R single buss,14x 1.0" Int
1.6.1	3R-A0919-AA	13	36.4GB Uscsi3 10k Universal disk 1"
1.7	DS-SL13R-AB	1	Modula M4314R single buss,14x 1.0" Int
1.7.1	3R-A0919-AA	13	36.4GB Uscsi3 10k Universal disk 1"
1.8	SN-LKQ47-AF	1	102 KEY KYBD,NON-WIN, Finnish
2	DS-TZ89N-TA	1	35/70GB SE DLT-tape "T FWSE
3	BN19C-2E	1	PowerCable 240V, C-Europe
4	BN38C-02	1	Ultra Cbl VHDCI - 68HD

BOM for the external RA8000 RAID

	Part Number	Qty	Description
1	175992-B22	1	MA8000 6x7 22U 50Hz opal
1.1	128697-B21	2	ACS V8.5F controller FCAL/FCSW
1.2	135823-B21	2	HSGxx Single external cache battery
1.3	176496-B22	24	36GB 10000r Ultra3 SCSI disk 1"
1.4	176622-B21	1	HSG80 FC Contr with 256MB cache
1.4.1	380674-B21	1	Cache Upg RA8k ESA12k 256MB
1.5	176622-B21	1	HSG80 FC Contr with 256MB cache
1.5.1	380674-B21	1	Cache Upg RA8k ESA12k 256MB
1.6	380553-001	1	OS Platf.Softw.Kit for FC Alpha UNIX
2	176219-B21	1	SAN Switch EL 8-Ports
3	234457-B23	1	Fibre Channel 15m Optical Cable
4	167365-B21	1	Rack mount kit for SAN switch
5	234457-B21	2	Fibre Channel 02m Optical Cable
6	168794-B21	1	Host Buss Cntr KGPSA-CA,OVMS,UNIX

www.Compaq.com/golden-eggs  
Since:Jan-2001

**COMPAQ** 30-Jan-2001 GTAUES40B  
Matti.Patari@compaq.com

AlphaServer ES40 UNIX Pedestal  
GOLDEN EGGS Visuals, Helsinki

This template is included in the present GOLDEN EGGS Software kit.

ES40 UNIX

ES40 Model 2 Systems in Cabinet M15

Ethernet  
FDDI

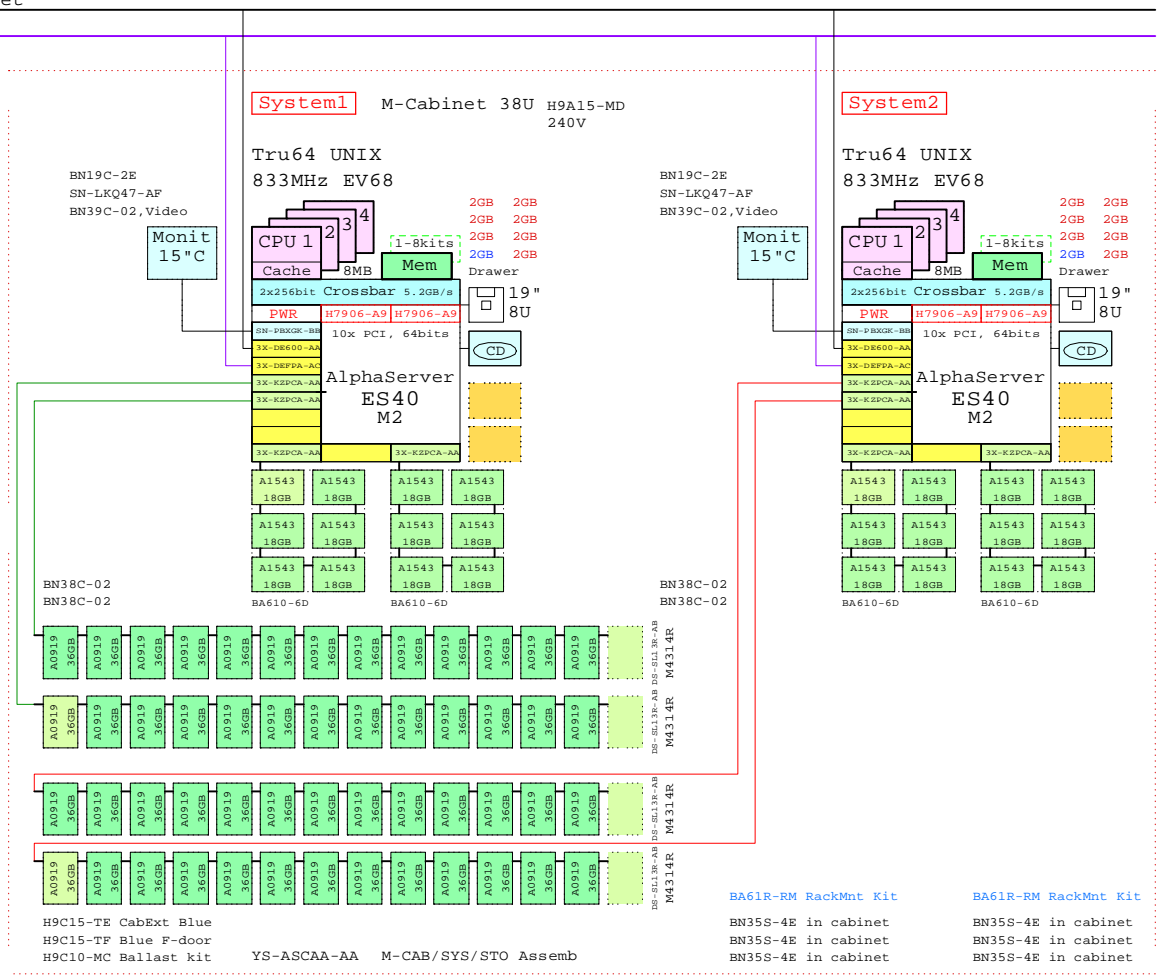

Bill of material for Cabinet and System 1

Part Number	Qty	Description
1	1	H9A15-MD 1 M-Series Cab,H9A15,Blue,240V 38U
1.1	1	BA61R-RM 1 ES40 Rackmount Kit
1.2	1	BN19C-2E 1 PowerCable 240V, C-Europe
1.3	3	BN35S-4E 3 PowerCord Cl3 to Cl4, Non US
1.4	2	BN38C-02 2 Ultra Cbl VHDCI - 68HD
1.5	1	BN39C-02 1 1.8 Video Extension Cable ****
1.6	1	DA-64CAA-EA 1 ES40 68/833 Model 2 2GB UNIX 10PCI DWR
1.6.1	1	3R-VRQV5-24 1 COMPAQ V55 CLR MON,NH,TCO95
1.6.2	1	3X-DE600-AA 1 10/100 1xChannel Ethernet, Twisted
1.6.3	1	3X-DEFFA-AC 1 PCI to FDDI SAS MMF with SC,Universal
1.6.4	4	3X-KZPCA-AA 4 Single channel LVD adapter
1.6.5	1	BA610-6D 1 ES40 Disk Drive Cage, 6-Bay
1.6.5.1	6	3R-A1543-AA 6 18.2GB Uscsi3 15k Universal disk 1"
1.6.6	1	BA610-6D 1 ES40 Disk Drive Cage, 6-Bay
1.6.6.1	6	3R-A1543-AA 6 18.2GB Uscsi3 15k Universal disk 1"
1.6.7	2	H7906-A9 2 ES40 Power Syply, 2nd or 3rd
1.6.8	3	KN610-CB 3 ES40 68/833MHz UNIX SMP 8mb cache
1.6.9	7	MS610-EA 7 ES40 2GB Memory Option
1.6.10	1	SN-PBXGK-BB 1 Elsa Gloria Synergy 8M Video Graphics
1.7	1	DS-SL13R-AB 1 Modula M4314R single buss,14x 1.0" Int
1.7.1	13	3R-A0919-AA 13 36.4GB Uscsi3 10k Universal disk 1"
1.8	1	DS-SL13R-AB 1 Modula M4314R single buss,14x 1.0" Int
1.8.1	13	3R-A0919-AA 13 36.4GB Uscsi3 10k Universal disk 1"
1.9	1	H9C10-MC 1 Ballast Kit for cabinets
1.10	1	H9C15-TE 1 Rear cab extender for H9A15 Blue
1.11	1	H9C15-TF 1 FrontDoorKit Blue for H9A15
1.12	1	SN-LKQ47-AF 1 102 KEY KYBD,NON-WIN, Finnish
1.13	1	YS-ASCAA-AA 1 M-CAB/SYS/STO Assembly

Bill of material for System 2

Part Number	Qty	Description
1	1	DA-64CAA-EA 1 ES40 68/833 Model 2 2GB UNIX 10PCI DWR
1.1	1	3R-VRQV5-24 1 COMPAQ V55 CLR MON,NH,TCO95
1.2	1	3X-DE600-AA 1 10/100 1xChannel Ethernet, Twisted
1.3	1	3X-DEFFA-AC 1 PCI to FDDI SAS MMF with SC,Universal
1.4	4	3X-KZPCA-AA 4 Single channel LVD adapter
1.5	1	BA610-6D 1 ES40 Disk Drive Cage, 6-Bay
1.5.1	6	3R-A1543-AA 6 18.2GB Uscsi3 15k Universal disk 1"
1.6	1	BA610-6D 1 ES40 Disk Drive Cage, 6-Bay
1.6.1	6	3R-A1543-AA 6 18.2GB Uscsi3 15k Universal disk 1"
1.7	2	H7906-A9 2 ES40 Power Syply, 2nd or 3rd
1.8	3	KN610-CB 3 ES40 68/833MHz UNIX SMP 8mb cache
1.9	7	MS610-EA 7 ES40 2GB Memory Option
1.10	1	SN-PBXGK-BB 1 Elsa Gloria Synergy 8M Video Graphics
2	1	DS-SL13R-AB 1 Modula M4314R single buss,14x 1.0" Int
2.1	13	3R-A0919-AA 13 36.4GB Uscsi3 10k Universal disk 1"
3	1	DS-SL13R-AB 1 Modula M4314R single buss,14x 1.0" Int
3.1	13	3R-A0919-AA 13 36.4GB Uscsi3 10k Universal disk 1"
4	1	BA61R-RM 1 ES40 Rackmount Kit
5	3	BN35S-4E 3 PowerCord Cl3 to Cl4, Non US
6	1	BN39C-02 1 1.8 Video Extension Cable ****
7	1	SN-LKQ47-AF 1 102 KEY KYBD,NON-WIN, Finnish
8	1	BN19C-2E 1 PowerCable 240V, C-Europe
9	2	BN38C-02 2 Ultra Cbl VHDCI - 68HD

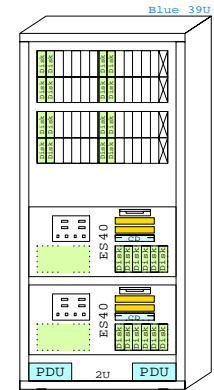

AlphaServer ES40 In H9A15 cabinet

This template is included in the present GOLDEN EGGS Software kit.

ES40 UNIX

www.Compaq.com/golden-eggs  
Since:Jan-2001

**COMPAQ** 30-Jan-2001 GTAUES40C  
Matti.Patari@compaq.com

AlphaServer ES40 UNIX Cabinet  
GOLDEN EGGS Visuals, Helsinki

## ES40 Model 2 TruCluster with external storage

Ethernet

FDDI

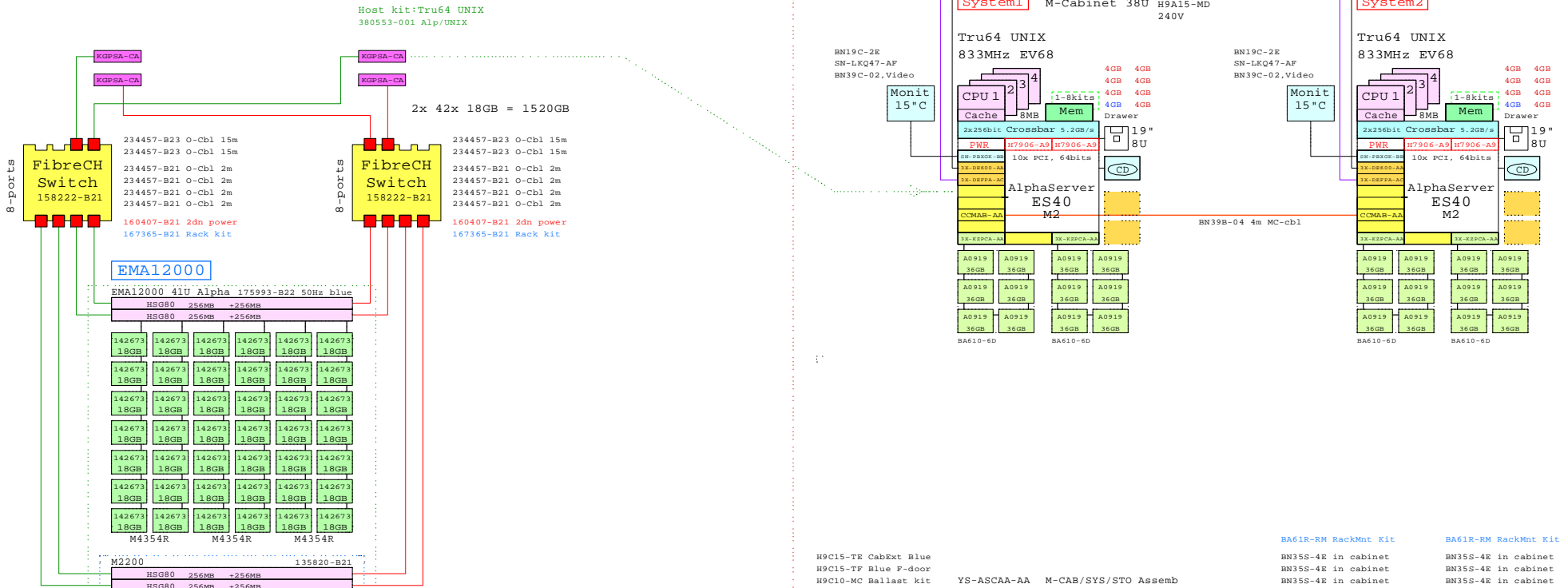

### BOM of Dual ES40 Cabinet

Part Number	Qty	Description
1	1	H9A15-MD 1 M-Series Cab, H9A15, Blue, 240V 38U
1.1	1	BA61R-RM 2 ES40 Rackmount Kit
1.2	1	BN19C-2E 2 PowerCable 240V, C-Europe
1.3	1	BN35S-4E 6 PowerCord c13 to c14, Non US
1.4	1	BN39B-04 1 04m copper cbl for CCMB Mem, Chan
1.5	1	BN39C-02 2 1.8 Video Extension Cable ***
1.6	1	DA-64CAA-FA 1 ES40 68/833 Model 2 4GB UNIX 10PCI DWR
1.6.1	1	3R-VRQV5-24 1 COMPAQ V55 CLR MEM, NH, TCC95
1.6.2	1	3X-DEP60-AA 1 PCI to FDDI SAS MPF with 8C, Universal
1.6.3	1	3X-DEPFA-AC 1 PCI to FDDI SAS MPF with 8C, Universal
1.6.4	1	3X-RZPCA-AA 2 Single channel LVD adapter
1.6.5	1	BA610-6D 1 ES40 Disk Drive Cage, 6-Bay
1.6.5.1	1	3R-A0919-AA 6 36.4GB Ucsd1 10K Universal disk 1"
1.6.6	1	BA610-6D 1 ES40 Disk Drive Cage, 6-Bay
1.6.6.1	1	3R-A0919-AA 6 36.4GB Ucsd1 10K Universal disk 1"
1.6.7	1	CCMB-AA 1 PCI Mem. Channel-2 Cluster cntrl
1.6.8	1	H7906-AA 2 ES40 Power Sply, 2nd or 3rd
1.6.9	1	RN610-CB 2 ES40 4GB Memory Option
1.6.10	1	MS610-FA 7 ES40 4GB Memory Option
1.6.11	1	SN-PBXGK-BB 1 Elpa Gloria Synergy 8M Video Graphics
1.7	1	DA-64CAA-FA 1 ES40 68/833 Model 2 4GB UNIX 10PCI DWR
1.7.1	1	3R-VRQV5-24 1 COMPAQ V55 CLR MEM, NH, TCC95
1.7.2	1	3X-DEP60-AA 1 PCI to FDDI SAS MPF with 8C, Universal
1.7.3	1	3X-DEPFA-AC 1 PCI to FDDI SAS MPF with 8C, Universal
1.7.4	1	3X-RZPCA-AA 2 Single channel LVD adapter
1.7.5	1	BA610-6D 1 ES40 Disk Drive Cage, 6-Bay
1.7.5.1	1	3R-A0919-AA 6 36.4GB Ucsd1 10K Universal disk 1"
1.7.6	1	BA610-6D 1 ES40 Disk Drive Cage, 6-Bay
1.7.6.1	1	3R-A0919-AA 6 36.4GB Ucsd1 10K Universal disk 1"
1.7.7	1	CCMB-AA 1 PCI Mem. Channel-2 Cluster cntrl
1.7.8	1	H7906-AA 2 ES40 Power Sply, 2nd or 3rd
1.7.9	1	RN610-CB 2 ES40 4GB Memory Option
1.7.10	1	MS610-FA 7 ES40 4GB Memory Option
1.7.11	1	SN-PBXGK-BB 1 Elpa Gloria Synergy 8M Video Graphics
1.8	1	H9C10-MC 1 Ballast Kit for cabinets
1.9	1	H9C15-TE 1 Rear Cab extender for H9A15 Blue
1.10	1	H9C15-TF 1 FrontPortKit Blue for H9A15
1.11	1	SN-LKQ47-AA 2 102 KEY KYBD, NON-WIN, Finish
1.12	1	YS-ASCAA-AA 1 M-CAB/SYS/STO Assembly

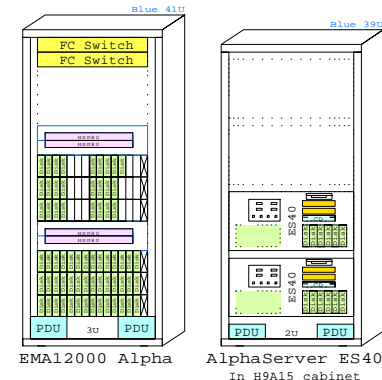

www.compaq.com/golden-eggs  
Since 12-Jan-2001

**COMPAQ** 30-Jan-2001 GTAUES40D  
Matti.Patari@compaq.com

**ES40** UNIX AlphaServer ES40 UNIX Cluster  
GOLDEN EGG Visuals, Helsinki

This template is included in the present GOLDEN EGG Software kit.

Ethernet  
FDDI

ES40 Model 2 Mini Tower System

ES40 Model 1 Mini Tower System

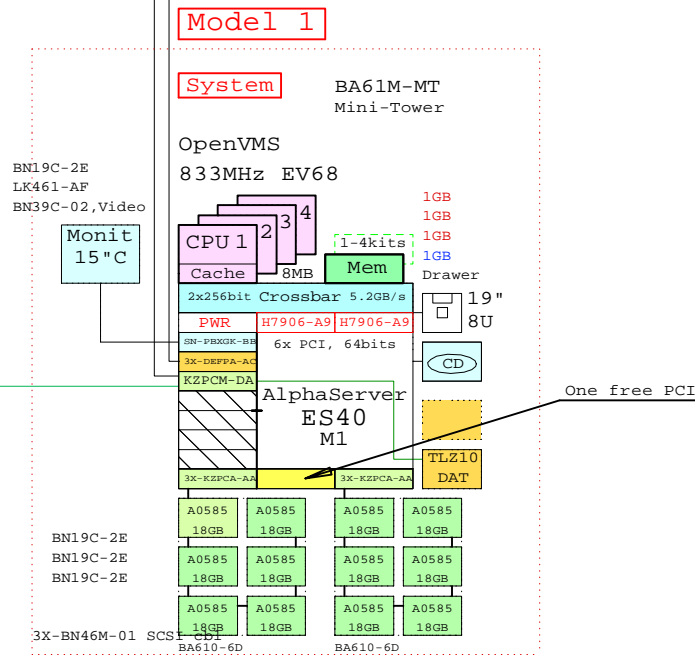
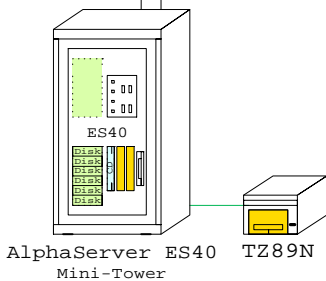
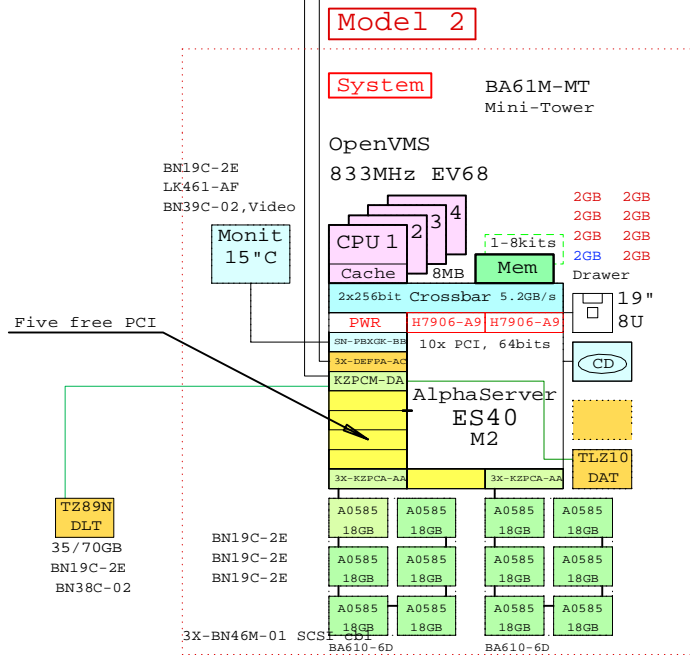

Bill of material, Model 2

Part Number	Qty	Description
1	1	BA61M-MT ES40 Mini-Tower Enclosure
1.1	1	3X-BN46M-01 SCSI cable for Tape
1.2	1	BN19C-2E PowerCable 240V, C-Europe
1.3	1	DY-64CAA-EA ES40 68/833 Model 2 2GB OVMS 10PCI DWR
1.3.1	1	3R-VROV5-24 COMPAQ V55 CLR MON,NH,TCO95
1.3.2	1	3X-DEPFA-AC PCI to FDDI SAS MMF with SC,Universal
1.3.3	2	3X-KZPCA-AA Single channel LVD adapter
1.3.4	1	BA610-6D ES40 Disk Drive Cage, 6-Bay
1.3.4.1	6	3R-A0585-AA 18.2GB Uscsi3 10k Universal disk 1"
1.3.5	1	BA610-6D ES40 Disk Drive Cage, 6-Bay
1.3.5.1	6	3R-A0585-AA 18.2GB Uscsi3 10k Universal disk 1"
1.3.6	3	BN19C-2E PowerCable 240V, C-Europe
1.3.7	1	BN39C-02 1.8 Video Extension Cable ****
1.3.8	2	H7906-A9 ES40 Power Syply, 2nd or 3rd
1.3.9	3	KN610-CC ES40 68/833MHz OVMS SMP 8mb cache
1.3.10	1	KZPCM-DA Dual Uscsi with FastEther PCI
1.3.11	7	MS610-EA ES40 2GB Memory Option
1.3.12	1	SN-PBXGK-BB Elsa Gloria Synergy 8M Video Graphics
1.3.13	1	TLZ10-LB 12/24GB 4mm DAT 5.25" HH
1.4	1	LK461-AF VMS STYLE KEYBOARD, Fin/Swed
2	1	DS-TZ89N-TA 35/70GB SE DLT-tape TT FWSE
3	1	BN19C-2E PowerCable 240V, C-Europe
4	1	BN38C-02 Ultra Cbl VHDCI - 68HD

Bill of material, Model 1

Part Number	Qty	Description
1	1	BA61M-MT ES40 Mini-Tower Enclosure
1.1	1	3X-BN46M-01 SCSI cable for Tape
1.2	1	BN19C-2E PowerCable 240V, C-Europe
1.3	1	DY-62CAA-DA ES40 68/833 Model 1 1GB OVMS 6PCI DWR
1.3.1	1	3R-VROV5-24 COMPAQ V55 CLR MON,NH,TCO95
1.3.2	1	3X-DEPFA-AC PCI to FDDI SAS MMF with SC,Universal
1.3.3	2	3X-KZPCA-AA Single channel LVD adapter
1.3.4	1	BA610-6D ES40 Disk Drive Cage, 6-Bay
1.3.4.1	6	3R-A0585-AA 18.2GB Uscsi3 10k Universal disk 1"
1.3.5	1	BA610-6D ES40 Disk Drive Cage, 6-Bay
1.3.5.1	6	3R-A0585-AA 18.2GB Uscsi3 10k Universal disk 1"
1.3.6	3	BN19C-2E PowerCable 240V, C-Europe
1.3.7	1	BN39C-02 1.8 Video Extension Cable ****
1.3.8	2	H7906-A9 ES40 Power Syply, 2nd or 3rd
1.3.9	3	KN610-CC ES40 68/833MHz OVMS SMP 8mb cache
1.3.10	1	KZPCM-DA Dual Uscsi with FastEther PCI
1.3.11	3	MS610-EA ES40 1GB Memory Option
1.3.12	1	SN-PBXGK-BB Elsa Gloria Synergy 8M Video Graphics
1.3.13	1	TLZ10-LB 12/24GB 4mm DAT 5.25" HH
1.4	1	LK461-AF VMS STYLE KEYBOARD, Fin/Swed
2	1	DS-TZ89N-TA 35/70GB SE DLT-tape TT FWSE
3	1	BN19C-2E PowerCable 240V, C-Europe
4	1	BN38C-02 Ultra Cbl VHDCI - 68HD

[www.Compaq.com/golden-eggs](http://www.Compaq.com/golden-eggs)  
Since:Jan-2001

<b>COMPAQ</b>	30-Jan-2001	GTAVES40A
	Matti.Patari@compaq.com	
AlphaServer ES40 Mini Tower		
GOLDEN EGGS Visuals, Helsinki		



Ethernet  
FDDI

ES40 Model 2 Pedestal System

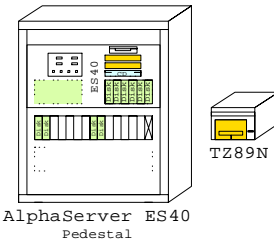
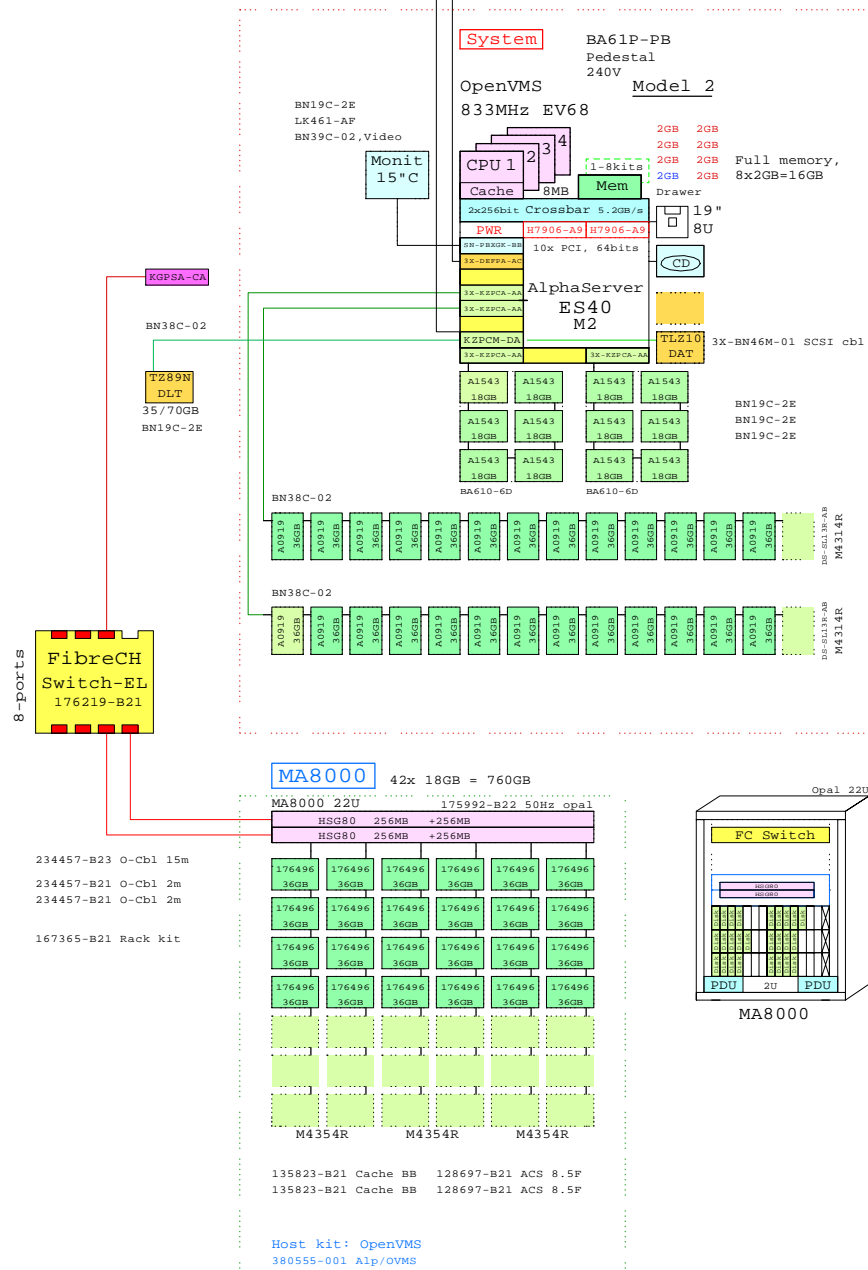

Bill of material for the base Pedestal

Part Number	Qty	Description
1	1	ES40 Pedestal Enclosure 240V Europe
1.1	1	SCSI cable for Tape
1.2	4	PowerCable 240V, C-Europe
1.3	2	Ultra Cbl VHDCI - 68HD
1.4	1	1.8 Video Extension Cable ****
1.5	1	Modula M4314R single buss,14x 1.0" Int
1.5.1	13	36.4GB Uscsi3 10k Universal disk 1"
1.6	1	Modula M4314R single buss,14x 1.0" Int
1.6.1	13	36.4GB Uscsi3 10k Universal disk 1"
1.7	1	ES40 68/833 Model 2 2GB OVMS 10PCI DWR
1.7.1	1	COMPAQ V55 CLR MON,NH,TC095
1.7.2	1	PCI to FDDI SAS MMF with SC,Universal
1.7.3	4	Single channel LVD adapter
1.7.4	1	ES40 Disk Drive Cage, 6-Bay
1.7.4.1	6	18.2GB Uscsi3 15k Universal disk 1"
1.7.5	1	ES40 Disk Drive Cage, 6-Bay
1.7.5.1	6	18.2GB Uscsi3 15k Universal disk 1"
1.7.6	2	ES40 Power Syply, 2nd or 3rd
1.7.7	3	ES40 68/833MHz OVMS SMP 8mb cache
1.7.8	1	Dual Uscsi with FastEther PCI
1.7.9	7	ES40 2GB Memory Option
1.7.10	1	Elsa Gloria Synergy 8M Video Graphics
1.7.11	1	12/24GB 4mm DAT 5.25" HH
1.8	1	VMS STYLE KEYBOARD, Fin/Swed
2	1	35/70GB SE DLT-tape TT FWSE
3	1	PowerCable 240V, C-Europe
4	1	Ultra Cbl VHDCI - 68HD

BOM for the external RA8000 RAID

Part Number	Qty	Description
1	1	MA8000 6x7 22U 50Hz opal
1.1	2	ACS V8.5F controller FCAL/FCSW
1.2	2	HSGxx Single external cache battery
1.3	24	36GB 10000r Ultra3 SCSI disk 1"
1.4	1	HSG80 FC Contr with 256MB cache
1.4.1	1	Cache Upg RA8k ESA12k 256MB
1.5	1	HSG80 FC Contr with 256MB cache
1.5.1	1	Cache Upg RA8k ESA12k 256MB
1.6	1	OS Platf.Softw.Kit for FC Alpha OVMS
2	1	SAN Switch EL 8-Ports
3	1	Fibre Channel 15m Optical Cable
4	1	Rack mount kit for SAN switch
5	2	Fibre Channel 02m Optical Cable
6	1	Host Buss Cntr KGPSA-CA,OVMS,UNIX

www.Compaq.com/golden-eggs  
Since:Jan-2001

**COMPAQ** 30-Jan-2001 GTAVES40B  
Matti.Patari@compaq.com

AlphaServer ES40 OVMS Pedestal  
GOLDEN EGGS Visuals, Helsinki

ES40 OVMS

ES40 Model 2 Systems in Cabinet M15

Ethernet

FDDI

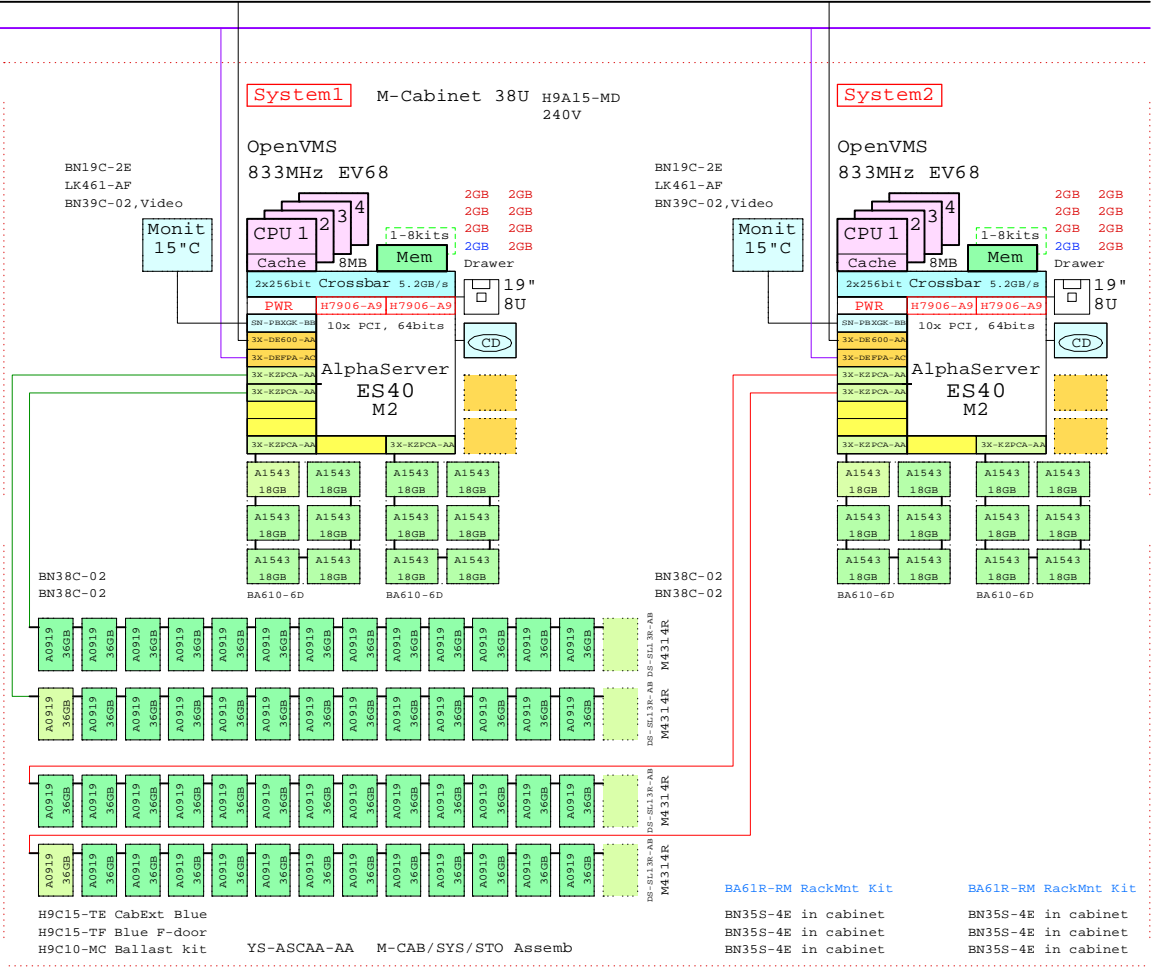

This template is included in the present GOLDEN EGGS Software kit.

Bill of material for Cabinet and System 1

Part Number	Qty	Description
1	H9A15-MD	1 M-Series Cab,H9A15,Blue,240V 38U
1.1	BA61R-RM	1 ES40 Rackmount Kit
1.2	BN19C-2E	1 PowerCable 240V, C-Europe
1.3	BN35S-4E	3 PowerCord C13 to C14, Non US
1.4	BN38C-02	2 Ultra Cbl VHDCI - 68HD
1.5	BN39C-02	1 1.8 Video Extension Cable ****
1.6	DS-SL13R-AB	1 Modula M4314R single buss,14x 1.0" Int
1.6.1	3R-A0919-AA	13 36.4GB Uscsi3 10k Universal disk 1"
1.7	DS-SL13R-AB	1 Modula M4314R single buss,14x 1.0" Int
1.7.1	3R-A0919-AA	13 36.4GB Uscsi3 10k Universal disk 1"
1.8	DY-64CAA-EA	1 ES40 68/833 Model 2 2GB OVMS 10PCI DW
1.8.1	3R-VRQV5-24	1 COMPAQ V55 CLR MON,NH,TCO95
1.8.2	3X-DE600-AA	1 10/100 1xChannel Ethernet, Twisted
1.8.3	3X-DEFPA-AC	1 PCI to FDDI SAS MMF with SC,Universal
1.8.4	3X-KZPCA-AA	4 Single channel LVD adapter
1.8.5	BA610-6D	1 ES40 Disk Drive Cage, 6-Bay
1.8.5.1	3R-A1543-AA	6 18.2GB Uscsi3 15k Universal disk 1"
1.8.6	BA610-6D	1 ES40 Disk Drive Cage, 6-Bay
1.8.6.1	3R-A1543-AA	6 18.2GB Uscsi3 15k Universal disk 1"
1.8.7	H7906-A9	2 ES40 Power Sply, 2nd or 3rd
1.8.8	KN610-CC	3 ES40 68/833MHz OVMS SMP 8mb cache
1.8.9	MS610-EA	7 ES40 2GB Memory Option
1.8.10	SN-PBXGK-BB	1 Elsa Gloria Synergy 8M Video Graphics
1.9	H9C10-MC	1 Ballast Kit for cabinets
1.10	H9C15-TE	1 Rear cab extender for H9A15 Blue
1.11	H9C15-TF	1 FrontDoorKit Blue for H9A15
1.12	LK461-AF	1 VMS STYLE KEYBOARD, Fin/Swed
1.13	YS-ASCAA-AA	1 M-CAB/SYS/STO Assembly

Bill of material for System 2

Part Number	Qty	Description
1	DY-64CAA-EA	1 ES40 68/833 Model 2 2GB OVMS 10PCI DW
1.1	3R-VRQV5-24	1 COMPAQ V55 CLR MON,NH,TCO95
1.2	3X-DE600-AA	1 10/100 1xChannel Ethernet, Twisted
1.3	3X-DEFPA-AC	1 PCI to FDDI SAS MMF with SC,Universal
1.4	3X-KZPCA-AA	4 Single channel LVD adapter
1.5	BA610-6D	1 ES40 Disk Drive Cage, 6-Bay
1.5.1	3R-A1543-AA	6 18.2GB Uscsi3 15k Universal disk 1"
1.6	BA610-6D	1 ES40 Disk Drive Cage, 6-Bay
1.6.1	3R-A1543-AA	6 18.2GB Uscsi3 15k Universal disk 1"
1.7	H7906-A9	2 ES40 Power Sply, 2nd or 3rd
1.8	KN610-CC	3 ES40 68/833MHz OVMS SMP 8mb cache
1.9	MS610-EA	7 ES40 2GB Memory Option
1.10	SN-PBXGK-BB	1 Elsa Gloria Synergy 8M Video Graphics
2	DS-SL13R-AB	1 Modula M4314R single buss,14x 1.0" Int
2.1	3R-A0919-AA	13 36.4GB Uscsi3 10k Universal disk 1"
3	DS-SL13R-AB	1 Modula M4314R single buss,14x 1.0" Int
3.1	3R-A0919-AA	13 36.4GB Uscsi3 10k Universal disk 1"
4	BA61R-RM	1 ES40 Rackmount Kit
5	BN35S-4E	3 PowerCord C13 to C14, Non US
6	BN39C-02	1 1.8 Video Extension Cable ****
7	BN19C-2E	1 PowerCable 240V, C-Europe
8	BN38C-02	2 Ultra Cbl VHDCI - 68HD
9	LK461-AF	1 VMS STYLE KEYBOARD, Fin/Swed

www.Compaq.com/golden-eggs  
Since:Jan-2001

<b>COMPAQ</b>	30-Jan-2001	GTAVES40C
	Matti.Patari@compaq.com	

AlphaServer ES40 OpenVMS Cab.  
GOLDEN EGGS Visuals, Helsinki

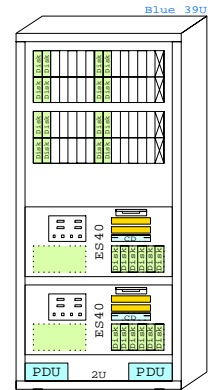

ES40 OVMS

AlphaServer ES40  
In H9A15 cabinet

# ES40 Model 2 OpenVMS Cluster with external storage

Ethernet

FDDI

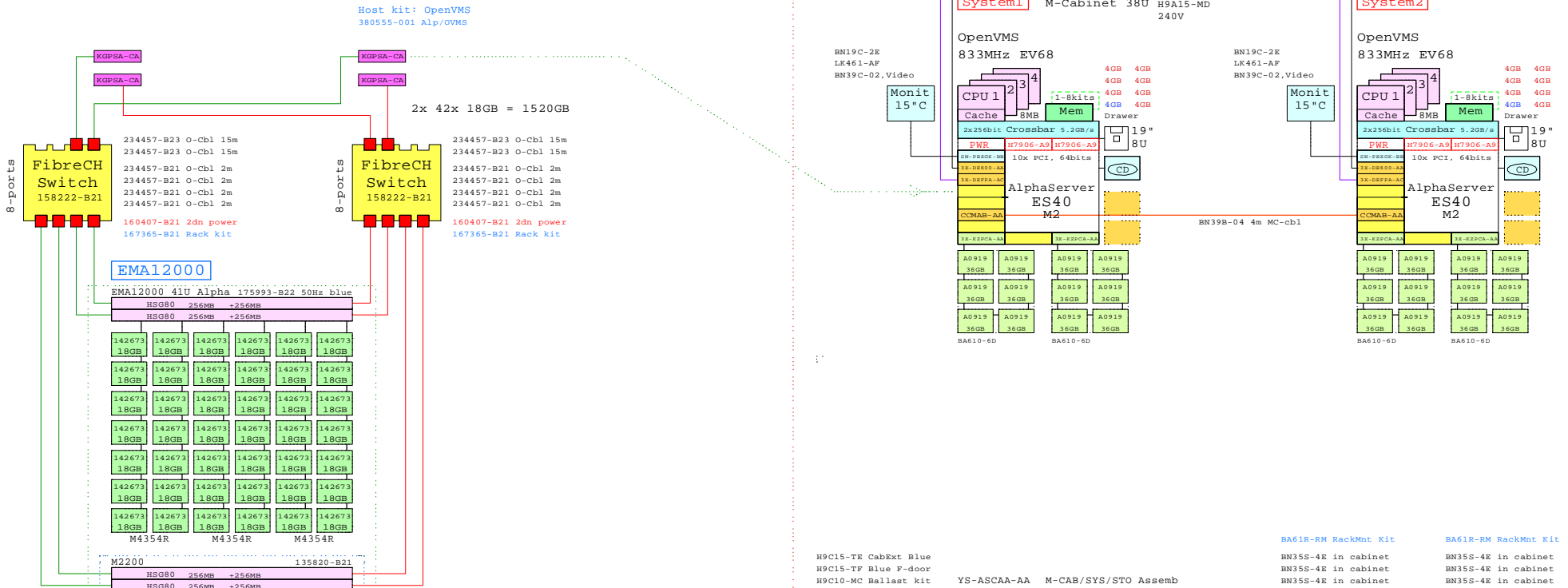

### EMA12000

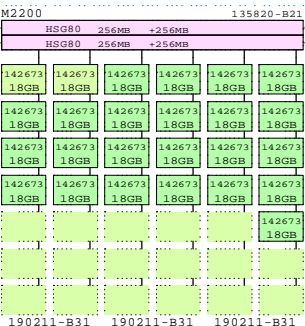
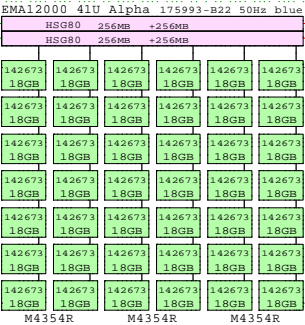

### BOM of External Storage

Part Number	Qty	Description
1	175993-B22	1 EMA12000 6x7 41U 50Hz blue
1.1	128697-B21	2 ACS V8.5F controller FCAL/PCSW
1.2	135820-B21	1 Module M2200 shelf, NO controller
1.2.1	128697-B21	2 ACS V8.5F controller FCAL/PCSW
1.2.2	135823-B21	2 HSGKX Single external cache battery
1.2.3	168256-B21	6 SCSI cable VHDCI-VHDCI, 1m
1.2.4	176622-B21	1 HSG80 FC Contr with 256MB cache
1.2.4.1	380674-B21	1 Cache Upg RARk ESA12k 256MB
1.2.5	176622-B21	1 HSG80 FC Contr with 256MB cache
1.2.5.1	380674-B21	1 Cache Upg RARk ESA12k 256MB
1.2.6	190211-B31	1 Modula M4354R dual buss, 7+7, 1.0"
1.2.6.1	142673-B22	8 18.20B 10000r Ultra3 SCSI disk 1"
1.2.7	190211-B31	1 Modula M4354R dual buss, 7+7, 1.0"
1.2.7.1	142673-B22	8 18.20B 10000r Ultra3 SCSI disk 1"
1.2.8	190211-B31	1 Modula M4354R dual buss, 7+7, 1.0"
1.2.8.1	142673-B22	9 18.20B 10000r Ultra3 SCSI disk 1"
1.3	135823-B21	2 HSGKX Single external cache battery
1.4	142673-B22	42 18.20B 10000r Ultra3 SCSI disk 1"
1.5	176622-B21	1 HSG80 FC Contr with 256MB cache
1.5.1	380674-B21	1 Cache Upg RARk ESA12k 256MB
1.6	176622-B21	1 HSG80 FC Contr with 256MB cache
1.6.1	380674-B21	1 Cache Upg RARk ESA12k 256MB
2	158222-B21	1 SAN Switch 8 Ports
2.1	380561-B21	6 FC Optical Short Wave GRIC 500
158222-B21	1 SAN Switch 8 Ports	
3.1	380561-B21	6 FC Optical Short Wave GRIC 500
4	160407-B21	2 SAN switch redundant power supply
5	234457-B23	4 Fibre Channel 15m Optical Cable
6	167365-B21	2 Rack mount kit for SAN switch
7	234457-B21	8 Fibre Channel 15m Optical Cable
8	380555-001	1 OS Platf Softw Kit for FC Alpha OVMS
9	168794-B21	4 Host Bus Cntr KQPSA-CA,OVMS,UNIX

### BOM of Dual ES40 Cabinet

Part Number	Qty	Description
1	H9A15-MD	1 M-Series Cab,H9A15,Blue,240V 38U
1.1	BA61R-RM	2 ES40 Rackmount Kit
1.2	BN19C-2E	2 PowerCable 240V, C-Europe
1.3	BN355-4E	6 PowerCord c13 to c14, Rom US
1.4	BN39B-04	1 04m copper cbl for CCMAB Mem,Chan
1.5	BN39C-02	2 1.8 Video Extension Cable ***
1.6	DV-64CAA-FA	1 ES40 68/833 Model 2 4GB OVMS 10PCI DWR
1.6.1	3R-VRQV5-24	1 COMPAQ V55 CLR MEM,NH,TC095
1.6.2	3X-DEPPA-AA	1 10/100 1xChannel Ethernet, Twisted
1.6.3	3X-DEPPA-AA	1 PCI to FDDI SAS MMF with SC/Universal
1.6.4	3X-KZPCA-AA	2 Single channel LVD adapter
1.6.5	BA610-6D	1 ES40 Disk Drive Cage, 6-Bay
1.6.5.1	3R-A0919-AA	6 36.4GB Uscsi3 10K Universal disk 1"
1.6.6	BA610-6D	1 ES40 Disk Drive Cage, 6-Bay
1.6.6.1	3R-A0919-AA	6 36.4GB Uscsi3 10K Universal disk 1"
1.6.7	CCMAB-AA	1 PCI Mem, Channel-2 Cluster cntrl
1.6.8	H7906-AA	3 ES40 Power Sply, 2nd or 3rd
1.6.9	RN610-CC	2 ES40 4GB Memory Option
1.6.10	MS610-FA	7 ES40 4GB Memory Option
1.6.11	SN-PBXKX-BB	1 Elpa Gloria Synergy 8M Video Graphics
1.7	DV-64CAA-FA	1 ES40 68/833 Model 2 4GB OVMS 10PCI DWR
1.7.1	3R-VRQV5-24	1 COMPAQ V55 CLR MEM,NH,TC095
1.7.2	3X-DEPPA-AA	1 10/100 1xChannel Ethernet, Twisted
1.7.3	3X-DEPPA-AA	1 PCI to FDDI SAS MMF with SC/Universal
1.7.4	3X-KZPCA-AA	2 Single channel LVD adapter
1.7.5	BA610-6D	1 ES40 Disk Drive Cage, 6-Bay
1.7.5.1	3R-A0919-AA	6 36.4GB Uscsi3 10K Universal disk 1"
1.7.6	BA610-6D	1 ES40 Disk Drive Cage, 6-Bay
1.7.6.1	3R-A0919-AA	6 36.4GB Uscsi3 10K Universal disk 1"
1.7.7	CCMAB-AA	1 PCI Mem, Channel-2 Cluster cntrl
1.7.8	H7906-AA	2 ES40 Power Sply, 2nd or 3rd
1.7.9	RN610-CC	2 ES40 4GB Memory Option
1.7.10	MS610-FA	7 ES40 4GB Memory Option
1.7.11	SN-PBXKX-BB	1 Elpa Gloria Synergy 8M Video Graphics
1.8	H9C10-MC	1 Ballast Kit for cabinets
1.9	H9C15-TE	1 Rear cab extender for H9A15 Blue
1.10	H9C15-TF	1 FrontDoorKit Blue for H9A15
1.11	LK461-AF	2 VMS STYLE KEYBOARD, Pin/Swed
1.12	YS-ASCAA-AA	1 M-CAB/SYS/STO Assembly

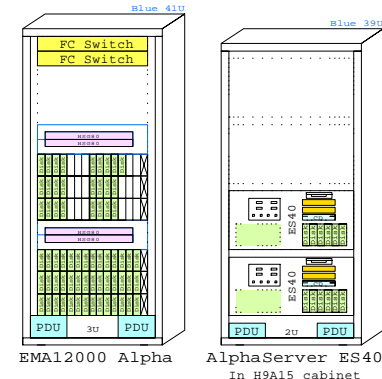

www.Compaq.com/golden-eggs

**COMPAQ** 30-Jan-2001 GTAVES40D  
Matti.Patari@compaq.com

**ES40** OVMS AlphaServer ES40 OpenVMS Clust  
GOLDEN EGGS Visuals, Helsinki

This template is included in the present GOLDEN EGGS Software kit.

Optional External Fibre Channel Storage

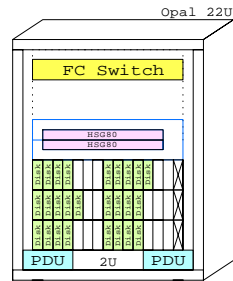

MA8000

MA8000 42x 18GB = 760GB

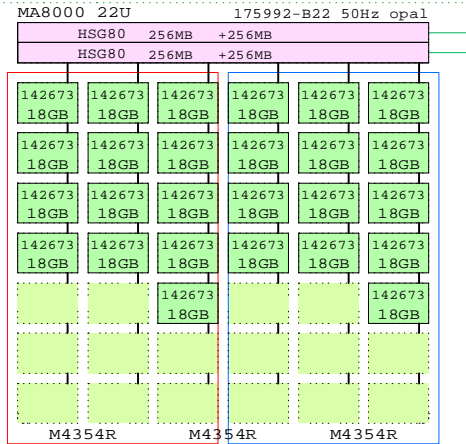

135823-B21 Cache BB 128697-B21 ACS 8.5F  
135823-B21 Cache BB 128697-B21 ACS 8.5F

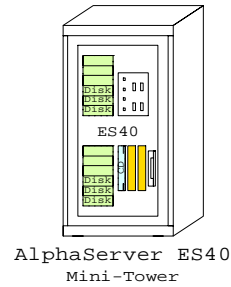

AlphaServer ES40 Mini-Tower

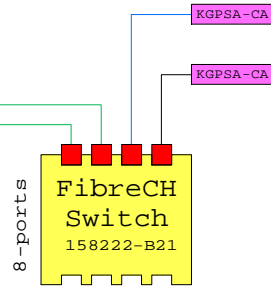

234457-B21 O-Cbl 2m  
234457-B21 O-Cbl 2m  
234457-B21 O-Cbl 2m  
234457-B21 O-Cbl 2m  
160407-B21 2dn power  
167365-B21 Rack kit  
Host kit: OpenVMS  
380555-001 Alp/OVMS

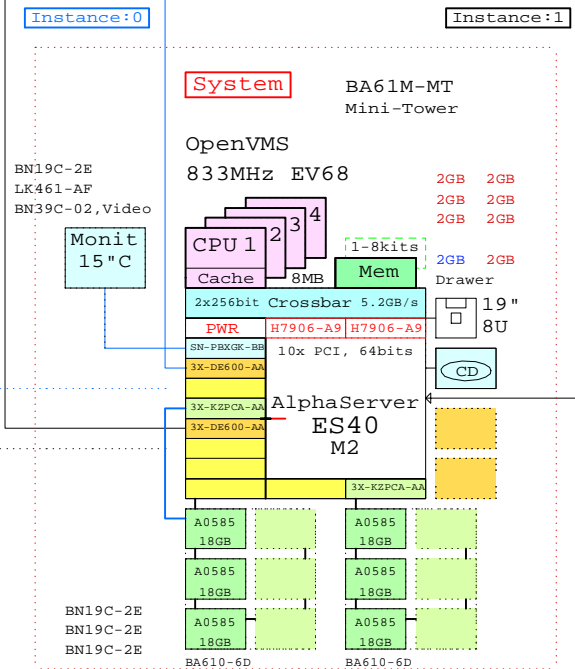

BOM for Instance: 0

Part Number	Qty	Description
1	1	BA61M-MT ES40 Mini-Tower Enclosure
1.1	1	BN19C-2E PowerCable 240V, C-Europe
1.2	1	DY-64CAA-EA ES40 68/833 Model 2 2GB OVMS 10PCI DWR
1.2.1	1	3R-VRQV5-24 COMPAQ V55 CLR MON,NH,TC095
1.2.2	1	3X-DE600-AA 10/100 1xChannel Ethernet, Twisted
1.2.3	1	3X-KZPCA-AA Single channel LVD adapter
1.2.4	1	BA610-6D ES40 Disk Drive Cage, 6-Bay
1.2.4.1	3	3R-A0585-AA 18.2GB Uscsi3 10k Universal disk 1"
1.2.5	1	BN19C-2E PowerCable 240V, C-Europe
1.2.6	1	BN39C-02 1.8 Video Extension Cable ****
1.2.7	1	SN-PBXGK-BB Elsa Gloria Synergy 8M Video Graphics
1.3	1	LK461-AF VMS STYLE KEYBOARD, Fin/Swed

BOM for Instance: 1

Part Number	Qty	Description
1	1	BA610-6D ES40 Disk Drive Cage, 6-Bay
1.1	3	3R-A0585-AA 18.2GB Uscsi3 10k Universal disk 1"
2	3	KN610-CC ES40 6/833MHz OVMS SMP 8mb cache
3	1	3X-DE600-AA 10/100 1xChannel Ethernet, Twisted
4	1	3X-KZPCA-AA Single channel LVD adapter
5	2	H7906-A9 ES40 Power Syplly, 2nd or 3rd
6	2	BN19C-2E PowerCable 240V, C-Europe
7	7	MS610-EA ES40 2GB Memory Option

BOM for External Storage

Part Number	Qty	Description
1	1	175992-B22 MA8000 6x7 22U 50Hz opal
1.1	2	128697-B21 ACS V8.5F controller FCAL/FCSW
1.2	2	135823-B21 HSGxx Single external cache battery
1.3	26	142673-B22 18.2GB 10000r Ultra3 SCSI disk 1"
1.4	1	176622-B21 HSG80 FC Contr with 256MB cache
1.4.1	1	380674-B21 Cache Upg RA8k ESA12k 256MB
1.5	1	176622-B21 HSG80 FC Contr with 256MB cache
1.5.1	1	380674-B21 Cache Upg RA8k ESA12k 256MB
2	1	158222-B21 SAN Switch 8 Ports
2.1	4	380561-B21 FC Optical Short Wave GBIC
3	1	160407-B21 SAN switch redundant power supply
4	1	167365-B21 Rack mount kit for SAN switch
5	4	234457-B21 Fibre Channel O2m Optical Cable
6	1	380555-001 OS Platf.Softw.Kit for FC Alpha OVMS
7	2	168794-B21 Host Buss Cntr KGPSA-CA,OVMS,UNIX

This template is included in the present GOLDEN EGGS Software kit.

ES40 OVMS

www.Compaq.com/golden-eggs  
Since:Nov-2000

**COMPAQ** 30-Jan-2001 GTAVES40E  
Matti.Patari@compaq.com

Alpha ES40 with OpenVMS/Galaxy  
GOLDEN EGGS Visuals, Helsinki

AlphaServer ES40 with OpenVMS/Galaxy

Ethernet

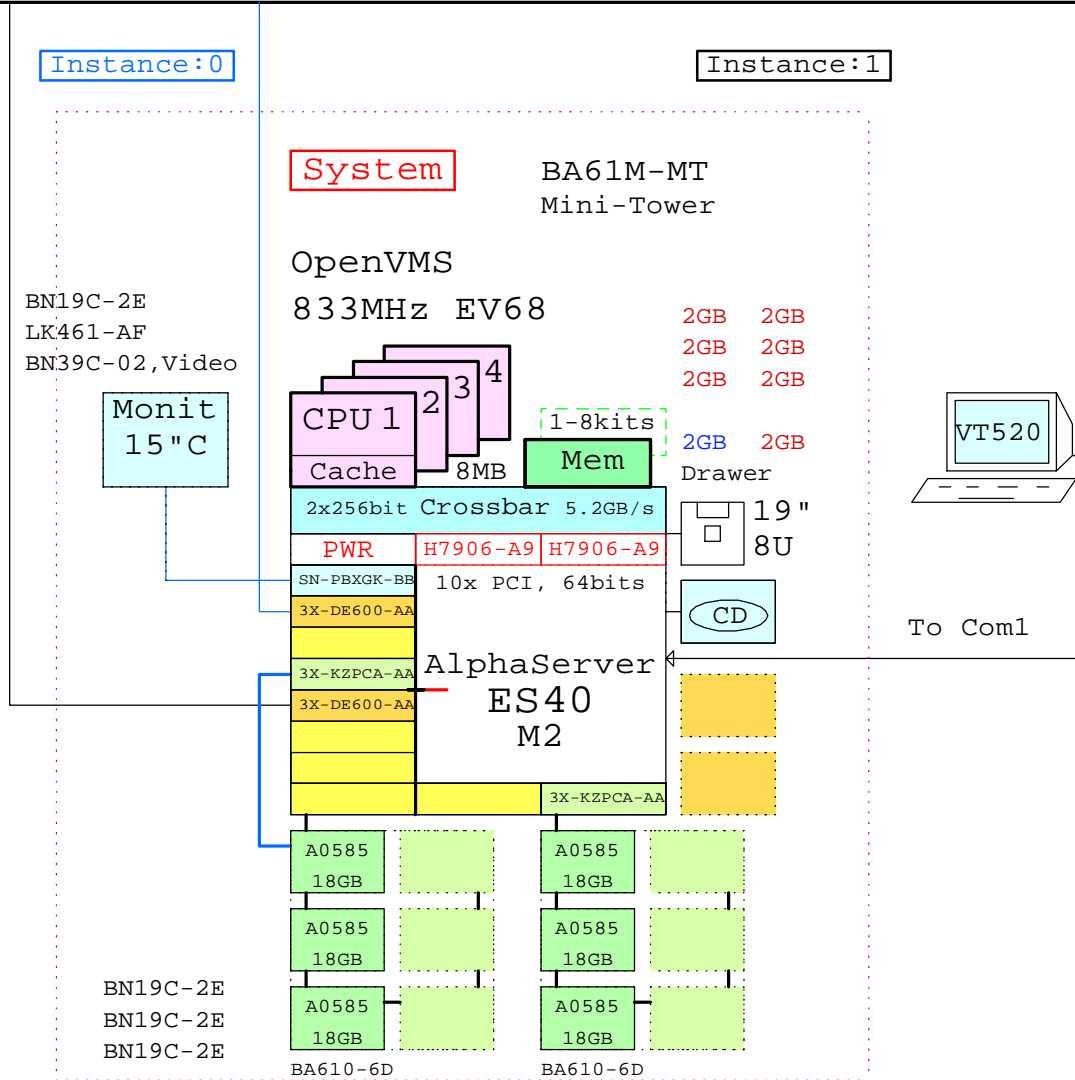

Ethernet

ES40 Model 1 Pedestal System

ES40 Model 1 Mini Tower System

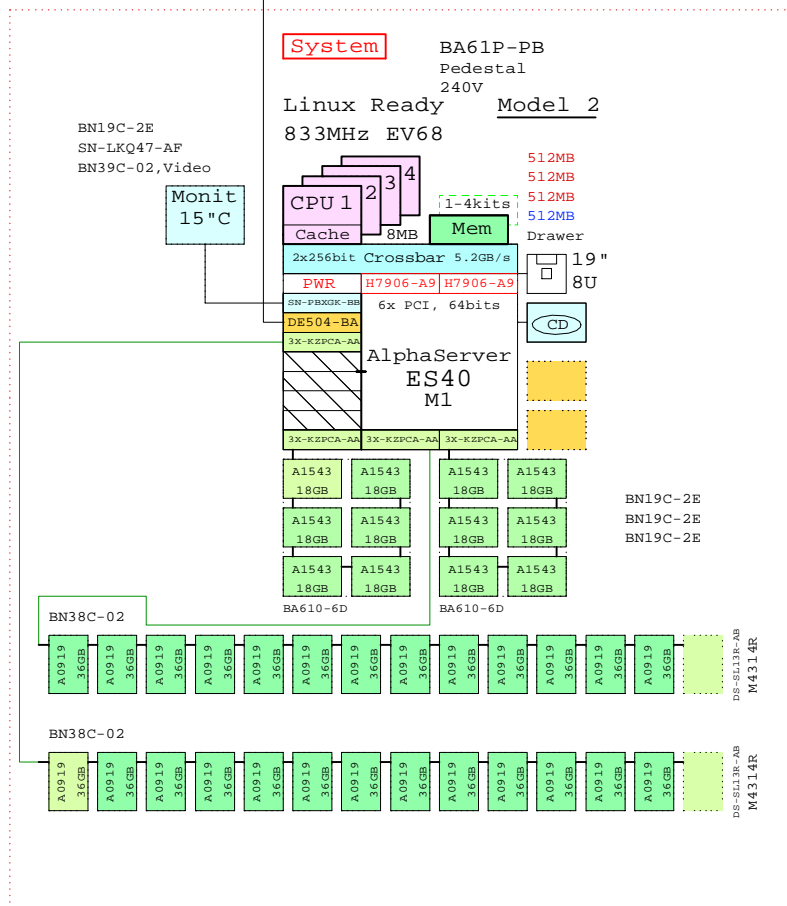

Gigabit Ethernet

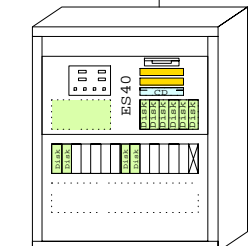

AlphaServer ES40 Pedestal

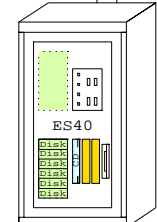

AlphaServer ES40 Mini-Tower

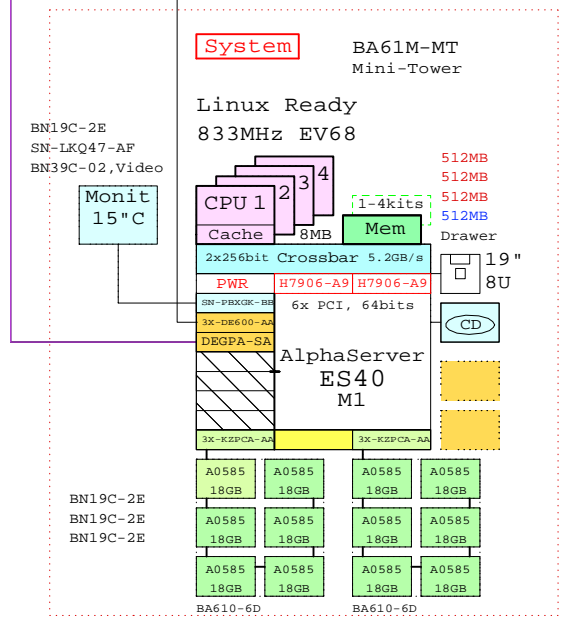

Part Number	Qty	Description
1	1	BA61P-PB ES40 Pedestal Enclosure 240V Europe
1.1	4	BN19C-2E PowerCable 240V, C-Europe
1.2	2	BN38C-02 Ultra Cbl VHDCI - 68HD
1.3	1	BN39C-02 1.8 Video Extension Cable ****
1.4	1	DJ-62CAA-CA ES40 68/833 Model 1 512MB LinuxReady 6PC
1.4.1	1	3R-VROV5-24 COMPAQ V55 CLR MON,NH,TCO95
1.4.2	4	3X-KZPCA-AA Single channel LVD adapter
1.4.3	1	BA610-6D ES40 Disk Drive Cage, 6-Bay
1.4.3.1	6	3R-A1543-AA 18.2GB Uscsi3 15k Universal disk 1"
1.4.4	1	BA610-6D ES40 Disk Drive Cage, 6-Bay
1.4.4.1	6	3R-A1543-AA 18.2GB Uscsi3 15k Universal disk 1"
1.4.5	1	DE504-BA PCI 10/100 MbitX4 ETHNT ALPHA
1.4.6	2	H7906-A9 ES40 Power Syplly, 2nd or 3rd
1.4.7	3	KN610-CA ES40 68/833MHz SMP 8mb cache
1.4.8	3	MS610-CA ES40 512MB Memory Option
1.4.9	1	SN-PBXGK-BB Elsa Gloria Synergy 8M Video Graphics
1.5	1	DS-SL13R-AB Modula M4314R single buss,14x 1.0" Int
1.5.1	13	3R-A0919-AA 36.4GB Uscsi3 10k Universal disk 1"
1.6	1	DS-SL13R-AB Modula M4314R single buss,14x 1.0" Int
1.6.1	13	3R-A0919-AA 36.4GB Uscsi3 10k Universal disk 1"
1.7	1	SN-LKQ47-AF 102 KEY KYBD,NON-WIN, Finnish

Part Number	Qty	Description
1	1	BA61M-MT ES40 Mini-Tower Enclosure
1.1	1	BN19C-2E PowerCable 240V, C-Europe
1.2	1	DJ-62CAA-CA ES40 68/833 Model 1 512MB LinuxReady 6PC
1.2.1	1	3R-VROV5-24 COMPAQ V55 CLR MON,NH,TCO95
1.2.2	1	3X-DE600-AA 10/100 1xChannel Ethernet, Twisted
1.2.3	2	3X-KZPCA-AA Single channel LVD adapter
1.2.4	1	BA610-6D ES40 Disk Drive Cage, 6-Bay
1.2.4.1	6	3R-A0585-AA 18.2GB Uscsi3 10k Universal disk 1"
1.2.5	1	BA610-6D ES40 Disk Drive Cage, 6-Bay
1.2.5.1	6	3R-A0585-AA 18.2GB Uscsi3 10k Universal disk 1"
1.2.6	3	BN19C-2E PowerCable 240V, C-Europe
1.2.7	1	BN39C-02 1.8 Video Extension Cable ****
1.2.8	1	DEGPA-SA PCI to GigabitEthernet SX Adap
1.2.9	2	H7906-A9 ES40 Power Syplly, 2nd or 3rd
1.2.10	3	KN610-CA ES40 68/833MHz SMP 8mb cache
1.2.11	3	MS610-CA ES40 512MB Memory Option
1.2.12	1	SN-PBXGK-BB Elsa Gloria Synergy 8M Video Graphics
1.3	1	SN-LKQ47-AF 102 KEY KYBD,NON-WIN, Finnish

www.Compaq.com/golden-eggs Since Jan-2001

**COMPAQ** 30-Jan-2001 GTALES40A Matti.Patari@compaq.com

ES40 Linux Golden Eggs Visuals, Helsinki

This template is included in the present GOLDEN EGGS Software kit.

# AlphaServer GS80 67/731 Systems

## AlphaServer GS80 Model 4

DA-A80AA-AC/AD/AE Model 4 Tru64 UNIX  
 DY-A80AA-AC/AD/AE Model 4 OpenVMS  
 US/EU/JP

## AlphaServer GS80 Model 8

DA-A80BA-AC/AD/AE Model 8 Tru64 UNIX  
 DY-A80BA-AC/AD/AE Model 8 OpenVMS

Tru64 UNIX or  
 OpenVMS  
 731MHz EV67

## AlphaServer GS80 Model 4

### Upgrade: M4->M8

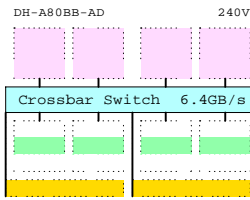

Field upgrade 01 QBB  
 DH-A80BB-AC/AD

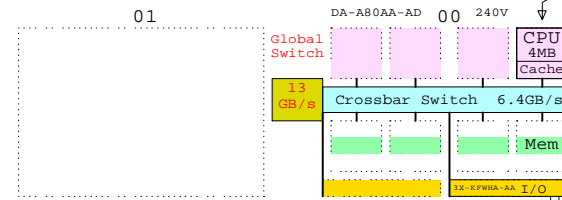

### Storage Shelves, 1-2

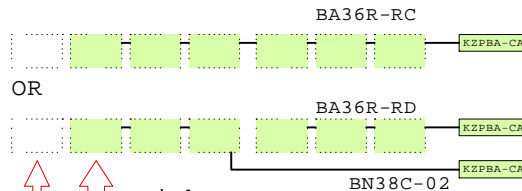

### Disks

- RZ1FC 36GB DS-RZ1FC-VW
- RZ1ED 18GB DS-RZ1ED-VW
- 2nd PWR CK-BA35X-HH

HxWxD 170x80x100cm

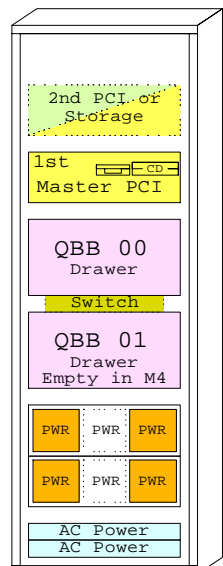

AlphaServer GS80

### Licenses included:

- Tru64 UNIX V4.0G, Base license, Unlimited User license, Server Extension license, and Internet Solutions Software license and Netscape's Enterprise Server 3.0.
- OpenVMS V7.2-1H1 Base license and Enterprise Integration Package V3.0.

@731MHz  
 SPECint95 -  
 SPECfp95 -  
 SPECweb96 -  
 TPC -

Software Processor Code: G

<b>COMPAQ</b>	12-Sep-2000	GEAGS801
	Matti.Patari@compaq.com	

AlphaServer GS80 M8 System  
 GOLDEN EGGS Visuals, Helsinki

BN25G-07

One CPU included

3X-KN8AA-AB UNIX  
 CPU 4MB Cache  
 3X-KN8AA-AC OpenVMS

Memory Upgrade  
 1GB Mem 1GB Mem

3X-MS8AA-BB 1GB Module  
 3X-MS8AA-BU 1GB DIMM

3X-MS8AA-CB 2GB Module  
 3X-MS8AA-CU 2GB DIMM

3X-MS8AA-DB 4GB Module  
 3X-MS8AA-DU 4GB DIMM

3R-VRQP7-24  
 Monit 17"C

Console PC 3X-DS8BA-AA  
 Console HUB 3X-DS8AA-AA  
 Hub for 2nd partition

BN39C-02.Video  
 BN19C-2E  
 SN-LKQ47-AF

First Master PCI included

3X-DWWPA-AA  
 Master PCI

3X-DWWPA-BA  
 Expansion PCI

3X-KFWHA-BA  
 I/O module

BN39B-04  
 BN39B-04  
 Two cables

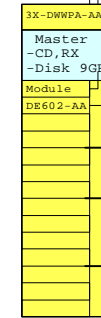
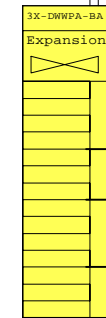
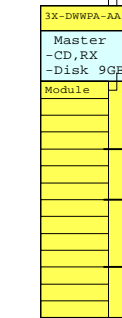

# AlphaServer GS80 Tru64 UNIX System

Ethernet

FDDI

BOM for M04 -> M08 upgrade

Part Number	Qty	Description
DH-A80BB-AD	1	1xQBB AlphaServer GS80 for 5-8 240V EU
H7510-AA	1	Power Suply for AS GS80 Need: 1 or 2

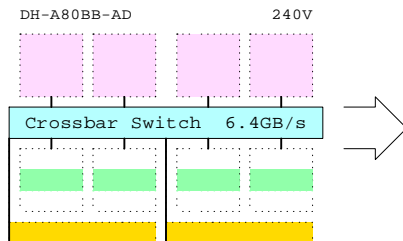

Field upgrade  
second QBB

H7510-AA Opt.Power Suply

Tru64 UNIX  
731MHz EV67

AlphaServer GS80 Model 4

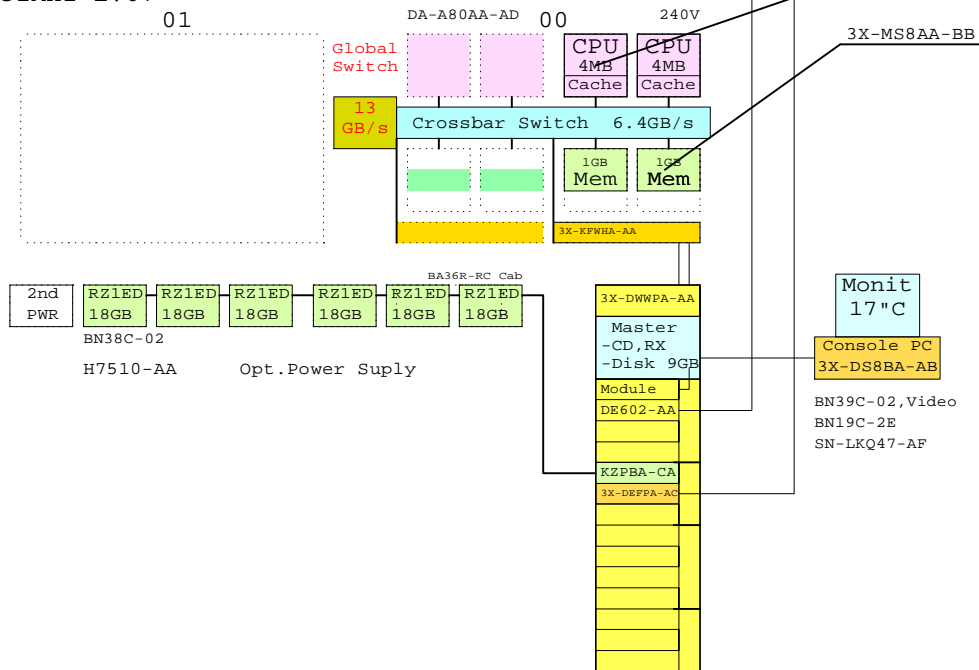

H7510-AA Opt.Power Suply

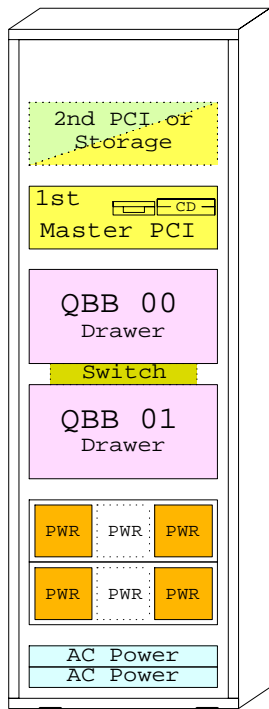

AlphaServer GS80

BOM for this M04 entry system

Part Number	Qty	Description
1	1	AS GS80 M04 for 04 CPU 240V EU UNIX
1.1	1	3X-DEPPA-AC PCI to FDDI SAS MMF with SC,Universal
1.2	1	3X-KN8AA-AB CPU Module GS80 6/731MHz Tru64 UNIX
1.3	2	3X-MS8AA-BB 1GB AlphaServer GS320 Memory module
1.4	1	BA36R-RC RH ULTRASCASI SHELF CAB SINGLE
1.4.1	1	CK-BA35X-HH 180W Stor.Shelf PWR for AS4x00
1.4.2	6	DS-RZ1ED-VW 18.2GB 10000r UltraSCSI disk
1.5	1	BN38C-02 Ultra Cbl VHDCI - 68HD
1.6	1	H7510-AA Power Suply for AS GS80 Need: 1 or 2
1.7	1	KZPBA-CA PCI to UltraSCSI Adapter UWSE
2	1	3R-VRQP7-24 COMPAQ P75 CLR MON,NH,TCO99
3	1	3X-DS8BA-AB PC-based system console, tower, Europe
4	1	BN39C-02 1.8 Video Extension Cable ****
5	1	SN-LKQ47-AF 102 KEY KYBD, NON-WIN, Finnish
6	1	BN19C-2E PowerCable 240V, C-Europe

[www.Compaq.com/golden-eggs](http://www.Compaq.com/golden-eggs)

Since: Sep-2000



11-Sep-2000 GTAUGS801  
Matti.Patari@compaq.com

AlphaServer GS80 UNIX System  
GOLDEN EGGS Visuals, Helsinki

This template is included in the present GOLDEN EGGS Software kit.

**GS80** UNIX



AlphaServer GS80 Tru64 UNIX System, 8xCPU, 16--64GB

Ethernet

FDDI

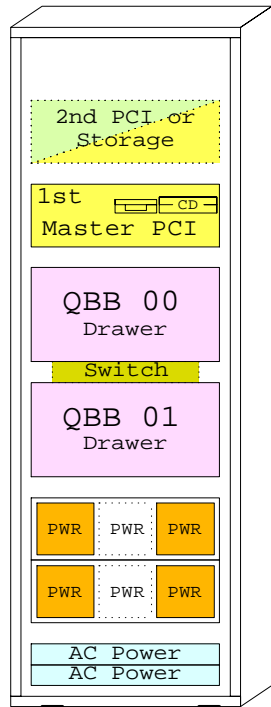
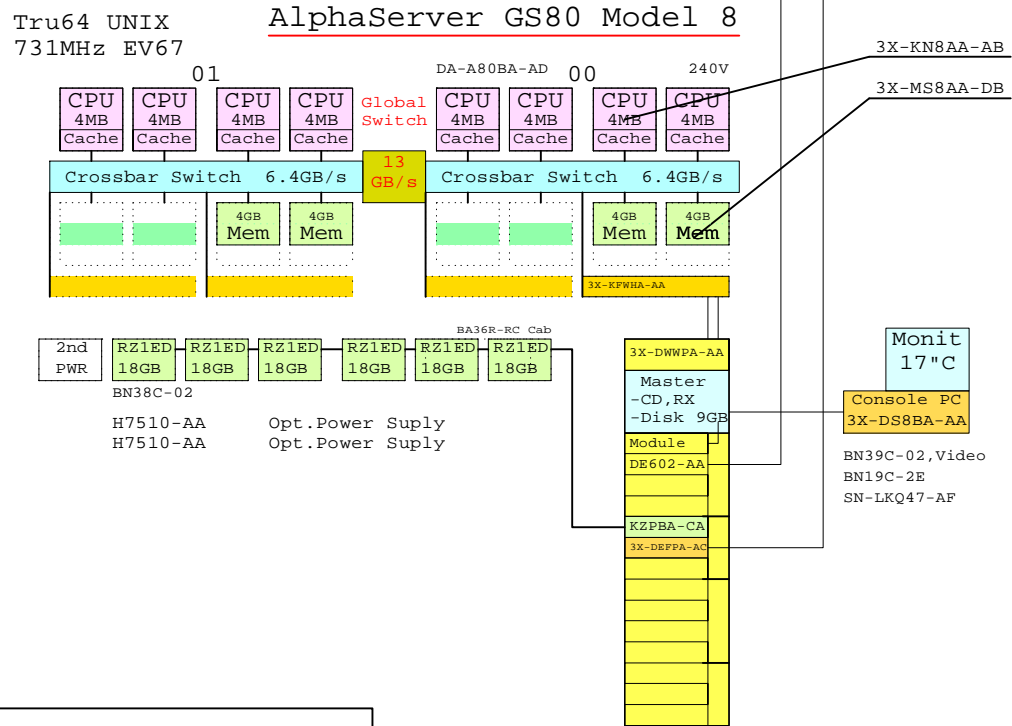

AlphaServer GS80

BOM for this system

	Part Number	Qty	Description
1	DA-A80BA-AD	1	AS GS80 M08 for 08 CPU 240V EU UNIX
1.1	3X-DEPPA-AC	1	PCI to FDDI SAS MMF with SC, Universal
1.2	3X-KN8AA-AB	7	CPU Module GS80 6/731MHz Tru64 UNIX
1.3	3X-MS8AA-DB	4	4GB AlphaServer GS320 Memory module
1.4	BA36R-RC	1	RH ULTRASCSI SHELF CAB SINGLE
1.4.1	CK-BA35X-HH	1	180W Stor.Shelf PWR for AS4x00
1.4.2	DS-RZ1ED-VW	6	18.2GB 10000r UltraSCSI disk
1.5	BN38C-02	1	Ultra Cbl VHDCI - 68HD
1.6	H7510-AA	2	Power Suply for AS GS80 Need: 1 or 2
1.7	KZPBA-CA	1	PCI to UltraSCSI Adapter UWSE
2	3R-VRQP7-24	1	COMPAQ P75 CLR MON,NH,TCO99
3	3X-DS8BA-AA	1	PC-based system console, tower, US
4	BN39C-02	1	1.8 Video Extension Cable ****
5	SN-LKQ47-AF	1	102 KEY KYBD, NON-WIN, Finnish
6	BN19C-2E	1	PowerCable 240V, C-Europe

[www.Compaq.com/golden-eggs](http://www.Compaq.com/golden-eggs)  
Since: Sep-2000

<b>COMPAQ</b>	11-Sep-2000	GTAUGS802
	Matti.Patari@compaq.com	

AlphaServer GS80 UNIX System  
GOLDEN EGGS Visuals, Helsinki

This template is included in the present GOLDEN EGGS Software kit.

GS80 UNIX

AlphaServer GS80 Tru64 UNIX System, 8xCPU, 64GB

Ethernet  
FDDI

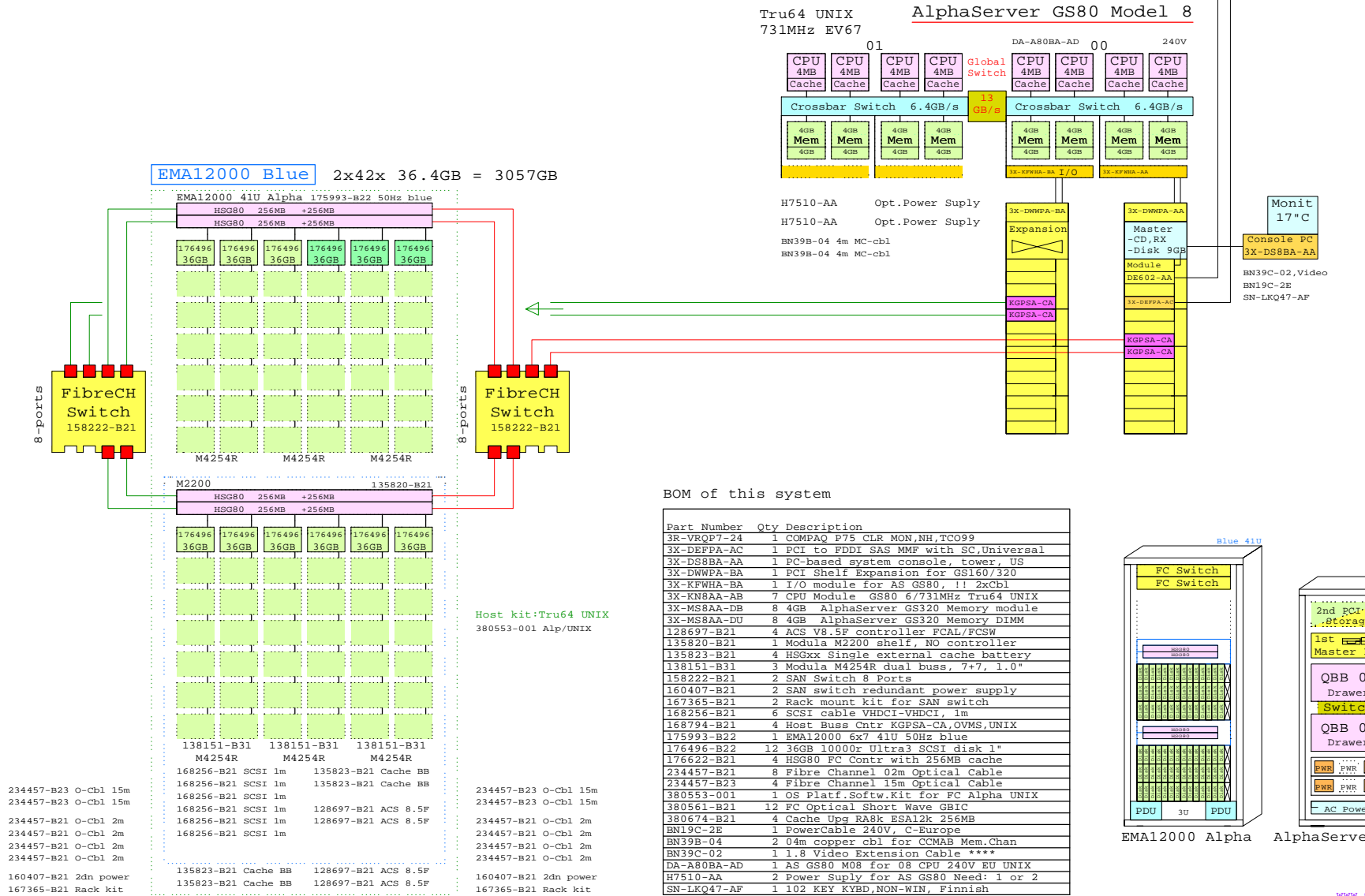

BOM of this system

Part Number	Qty	Description
3R-VROP7-24	1	COMPAQ P75 CLR MON,NH,TC099
3X-DEFFA-AC	1	PCI to FDDI SAS MMF with SC,Universal
3X-DS8BA-AA	1	PC-based system console, tower, US
3X-DWMPA-BA	1	PCI Shelf Expansion for GS160/320
3X-KFWHA-BA	1	I/O module for AS GS80, !! 2xCbl
3X-KNBAA-AB	7	CPU Module GS80 6/731MHz Tru64 UNIX
3X-MSBAA-DB	8	4GB AlphaServer GS320 Memory module
3X-MSBAA-DU	8	4GB AlphaServer GS320 Memory DIMM
128697-B21	4	ACS V8.5F controller FCAL/FCSW
135820-B21	1	Modula M2200 shelf, NO controller
135823-B21	1	HSGxx Single external cache battery
138151-B31	3	Modula M4254R dual buss, 7+7, 1.0"
158222-B21	2	SAN Switch 8 Ports
160407-B21	2	SAN switch redundant power supply
167365-B21	2	Rack mount kit for SAN switch
168256-B21	6	SCSI cable VHDCI-VHDCI, 1m
168794-B21	4	Host Buss Cntr KGPSA-CA,OVMS,UNIX
175993-B22	1	EMA12000 6x7 41U 50Hz blue
176496-B22	12	36GB 10000r Ultra3 SCSI disk 1"
176622-B21	4	HSG80 FC Contr with 256MB cache
234457-B21	8	Fibre Channel 02m Optical Cable
234457-B23	4	Fibre Channel 15m Optical Cable
380553-001	1	OS Platf,Softw,Kit for FC Alpha UNIX
380561-B21	12	FC Optical Short Wave GBIC
380674-B21	4	Cache Upg RA8k ESA12k 256MB
BN19C-2E	1	PowerCable 240V, C-Europe
BN39B-04	2	04m copper cbl for COMAB Mem.Chan
BN39C-02	1	1.8 Video Extension Cable ****
DA-A80BA-AD	1	AS GS80 Mob for 08 CPU 240V EU UNIX
H7510-AA	2	Power Supply for AS GS80 Need: 1 or 2
SN-LKQ47-AF	1	102 KEY KYBD, NON-WIN, Finnish

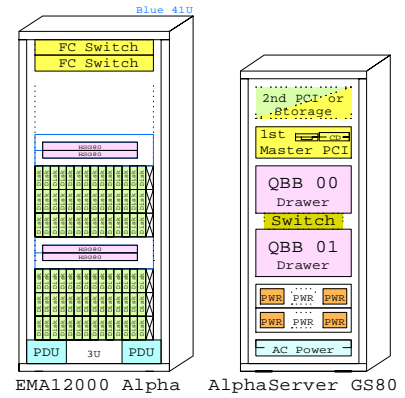

www.Compaq.com/golden-eggs  
Since Sep-2000

**COMPAQ** 14-Sep-2000 GTAUGS803  
Matti.Patari@compaq.com

AlphaServer GS80 UNIX System  
GOLDEN EGGS Visuals, Helsinki

This template is included in the present GOLDEN EGGS Software kit.

GS80 UNIX

# AlphaServer GS80 TruCluster

Tru64 UNIX 731MHz EV67 AlphaServer GS80 Model 8

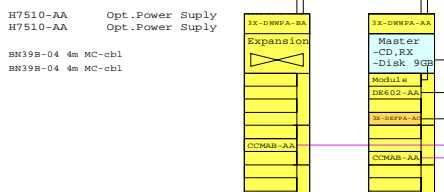
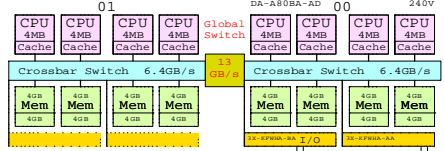

BOM of this GS80 TruCluster

Part Number	Qty	Description
1	1	175990-B21 1 BMA12000 D14 420 50Hz opal
1.1	1	128697-B21 6 ACS V8 SF controller FCAL/FCSW
1.2	1	13523-B21 6 HSBxx Single external cache battery
1.3	1	176496-B22 18 36GB 10000r Ultra3 SCSI disk 1"
1.4	1	176622-B21 1 HS080 FC Contr with 256MB cache
1.4.1	1	380674-B21 1 Cache Upg RASK ESA12K 256MB
1.5	1	176622-B21 1 HS080 FC Contr with 256MB cache
1.5.1	1	380674-B21 1 Cache Upg RASK ESA12K 256MB
1.6	1	176622-B21 1 HS080 FC Contr with 256MB cache
1.6.1	1	380674-B21 1 Cache Upg RASK ESA12K 256MB
1.7	1	176622-B21 1 HS080 FC Contr with 256MB cache
1.7.1	1	380674-B21 1 Cache Upg RASK ESA12K 256MB
1.8	1	176622-B21 1 HS080 FC Contr with 256MB cache
1.8.1	1	380674-B21 1 Cache Upg RASK ESA12K 256MB
1.9	1	176622-B21 1 HS080 FC Contr with 256MB cache
1.9.1	1	380674-B21 1 Cache Upg RASK ESA12K 256MB
2	1	DA-A808A-AD 1 AS GS80 M08 for 08 CPU 240V RU UNIX
2.1	1	168794-B21 1 Host Bus Cntr KGPSA-CA,OVMS,UNIX
2.2	1	3X-DEPPA-AC 1 PCI to FDDI SAS MMF with SC,Universal
2.3	1	3X-DWPA-BA 1 PCI Shelf Expansion for GS160/320
2.3.1	1	168794-B21 1 Host Bus Cntr KGPSA-CA,OVMS,UNIX
2.3.2	1	CCMAB-AA 1 PCI Mem. Channel-2 Cluster entrl
2.4	1	3X-KFPA-BA 1 I/O module for AS GS80, I1 2xCh1
2.5	7	3X-KNSAA-AB 7 CPU Module GS80 6/731MHz Tru64 UNIX
2.6	8	3X-MS8AA-DB 8 4GB AlphaServer GS320 Memory module
2.7	8	3X-MS8AA-DB 8 4GB AlphaServer GS320 Memory DIMM
2.8	2	BN39B-04 2 04m copper cbl for CCMAB Mem.Chan
2.9	1	CCMAB-AA 1 PCI Mem. Channel-2 Cluster entrl
2.10	1	H7510-AA 2 Power Supply for AS GS80 Need: 1 or 2
3	1	DA-A808A-AD 1 AS GS80 M08 for 08 CPU 240V RU UNIX
3.1	1	168794-B21 1 Host Bus Cntr KGPSA-CA,OVMS,UNIX
3.2	1	3X-DEPPA-AC 1 PCI to FDDI SAS MMF with SC,Universal
3.3	1	3X-DWPA-BA 1 PCI Shelf Expansion for GS160/320
3.3.1	1	168794-B21 1 Host Bus Cntr KGPSA-CA,OVMS,UNIX
3.3.2	1	CCMAB-AA 1 PCI Mem. Channel-2 Cluster entrl
3.4	1	3X-KFPA-BA 1 I/O module for AS GS80, I1 2xCh1
3.5	7	3X-KNSAA-AB 7 CPU Module GS80 6/731MHz Tru64 UNIX
3.6	8	3X-MS8AA-DB 8 4GB AlphaServer GS320 Memory module
3.7	8	3X-MS8AA-DB 8 4GB AlphaServer GS320 Memory DIMM
3.8	2	BN39B-04 2 04m copper cbl for CCMAB Mem.Chan
3.9	1	CCMAB-AA 1 PCI Mem. Channel-2 Cluster entrl
3.10	2	H7510-AA 2 Power Supply for AS GS80 Need: 1 or 2
4	1	158222-B21 1 SAN Switch 8 Ports
4.1	1	380561-B21 8 FC Optical Short Wave GBIC
5	1	158222-B21 1 SAN Switch 8 Ports
5.1	1	380561-B21 8 FC Optical Short Wave GBIC
6	1	3R-VR0P7-24 2 COMPAQ P75 CLR MON,NH,TC099
7	1	3X-DS8AA-AA 2 PC-based system console, tower, US
8	1	160407-B21 2 SAN switch redundant power supply
9	1	234457-B23 4 Fibre Channel 15m Optical Cable
10	1	167365-B21 2 Rack mount kit for SAN switch
11	1	234457-B21 12 Fibre Channel 02m Optical Cable
12	1	380553-001 1 OS Platf.Softw.Kit for FC Alpha UNIX
13	2	BN39B-10 2 10m copper cbl for CCMAB Mem.Chan
14	2	BN39C-02 2 1.8 Video Extension Cable ****
15	1	SN-LK047-AF 2 102 KEY KYBD,NON-WIN, Finnish
16	1	BN19C-2E 2 PowerCable 240V, C-Europe

BOM of the shared Storage

Part Number	Qty	Description
128697-B21	6	ACS V8 SF controller FCAL/FCSW
13523-B21	6	HSBxx Single external cache battery
158222-B21	2	SAN Switch 8 Ports
160407-B21	2	SAN switch redundant power supply
167365-B21	2	Rack mount kit for SAN switch
175990-B22	1	BMA12000 D14 420 50Hz opal
176496-B22	18	36GB 10000r Ultra3 SCSI disk 1"
176622-B21	6	HS080 FC Contr with 256MB cache
234457-B21	12	Fibre Channel 02m Optical Cable
234457-B23	4	Fibre Channel 15m Optical Cable
380553-001	1	OS Platf.Softw.Kit for FC Alpha UNIX
380561-B21	16	FC Optical Short Wave GBIC
380674-B21	6	Cache Upg RASK ESA12K 256MB

EMA12000 D14 3x42x 36.4GB = 4586GB

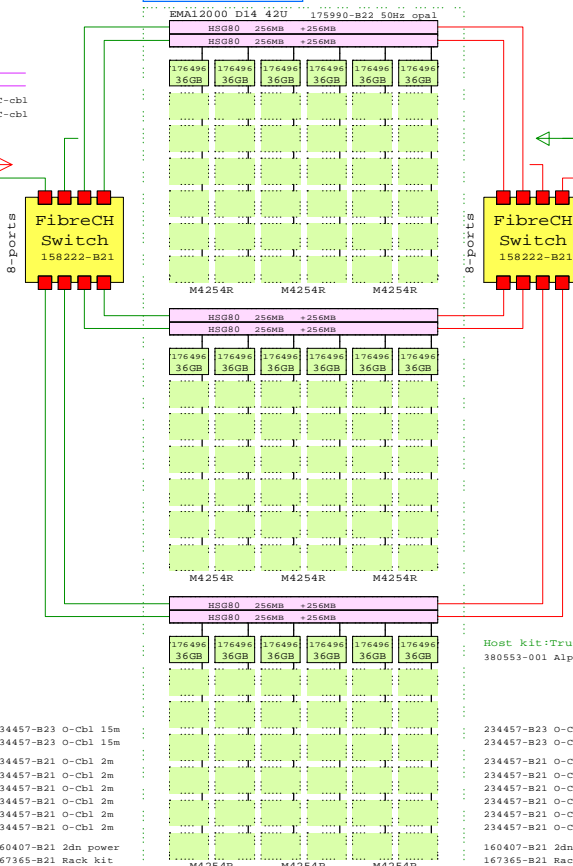

Tru64 UNIX 731MHz EV67 AlphaServer GS80 Model 8

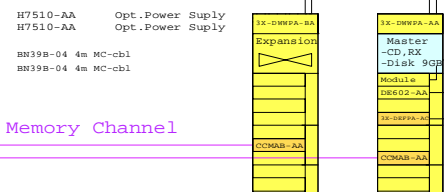
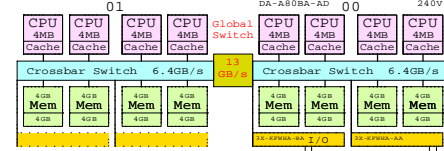

BOM of one Host

Part Number	Qty	Description
168794-B21	2	Host Bus Cntr KGPSA-CA,OVMS,UNIX
3R-VR0P7-24	2	COMPAG P75 CLR MON,NH,TC099
3X-DEPPA-AC	1	PCI to FDDI SAS MMF with SC,Universal
3X-DSBA-AA	1	PC-based system console, tower, US
3X-DWPA-BA	1	PCI Shelf Expansion for GS160/320
3X-KFPA-BA	1	I/O module for AS GS80, I1 2xCh1
3X-KNSAA-AB	7	CPU Module GS80 6/731MHz Tru64 UNIX
3X-MS8AA-DB	8	4GB AlphaServer GS320 Memory module
3X-MS8AA-DB	8	4GB AlphaServer GS320 Memory DIMM
BN19C-2E	1	PowerCable 240V, C-Europe
BN39B-04	2	04m copper cbl for CCMAB Mem.Chan
BN39C-02	1	1.8 Video Extension Cable ****
CCMAB-AA	2	PCI Mem. Channel-2 Cluster entrl
DA-A808A-AD	1	AS GS80 M08 for 08 CPU 240V RU UNIX
H7510-AA	2	Power Supply for AS GS80 Need: 1 or 2
SN-LK047-AF	1	102 KEY KYBD,NON-WIN, Finnish

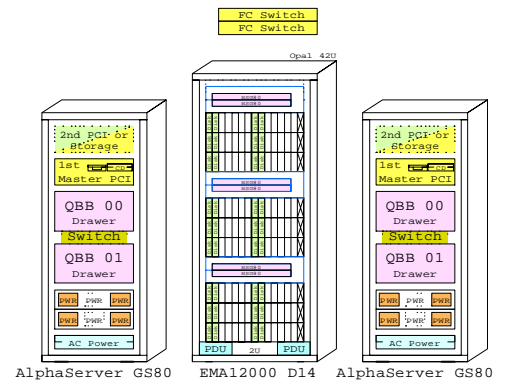

# AlphaServer GS80 OpenVMS System

Ethernet

FDDI

BOM for M04 -> M08 upgrade

Part Number	Qty	Description
DH-A80BB-AD	1	1xQBB AlphaServer GS80 for 5-8 240V EU
H7510-AA	1	Power Supply for AS GS80 Need: 1 or 2

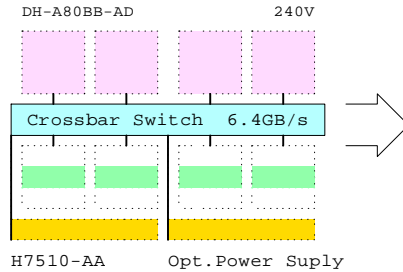

Field upgrade  
second QBB

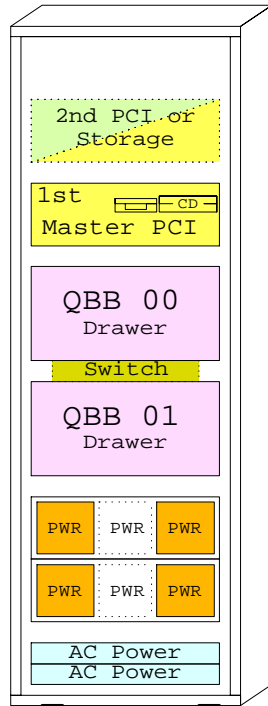

AlphaServer GS80

BOM for this M04 entry system

Part Number	Qty	Description
1	DY-A80AA-AD	1 AS GS80 M04 for 04 CPU 240V EU OVMS
1.1	3X-DEFFA-AC	1 PCI to FDDI SAS MMF with SC,Universal
1.2	3X-KN8AA-AC	1 CPU Module GS80 6/731MHz OpenVMS
1.3	3X-MS8AA-BB	2 1GB AlphaServer GS320 Memory module
1.4	BA36R-RC	1 RH ULTRASCSI SHELF CAB SINGLE
1.4.1	CK-BA35X-HH	1 180W Stor.Shelf PWR for AS4x00
1.4.2	DS-RZ1ED-VW	6 18.2GB 10000r UltraSCSI disk
1.5	BN38C-02	1 Ultra Cbl VHDCI - 68HD
1.6	H7510-AA	1 Power Supply for AS GS80 Need: 1 or 2
1.7	KZPBA-CA	1 PCI to UltraSCSI Adapter UWSE
2	3R-VRQP7-24	1 COMPAQ P75 CLR MON,NH,TCO99
3	3X-DS8BA-AA	1 PC-based system console, tower, US

OpenVMS  
731MHz EV67

## AlphaServer GS80 Model 4

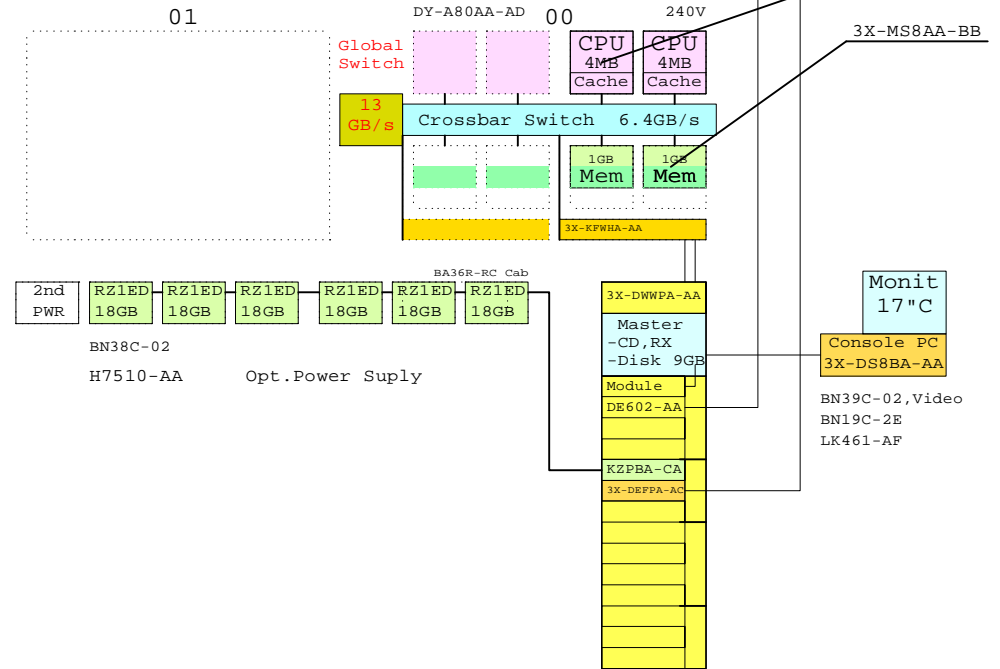

[www.Compaq.com/golden-eggs](http://www.Compaq.com/golden-eggs)  
Since: Sep-2000

<b>COMPAQ</b>	11-Sep-2000	GTA VGS801
	Matti.Patari@compaq.com	

AlphaServer GS80 OVMS System  
GOLDEN EGGS Visuals, Helsinki

AlphaServer GS80 OpenVMS System, 8xCPU, 16--64GB

Ethernet

FDDI

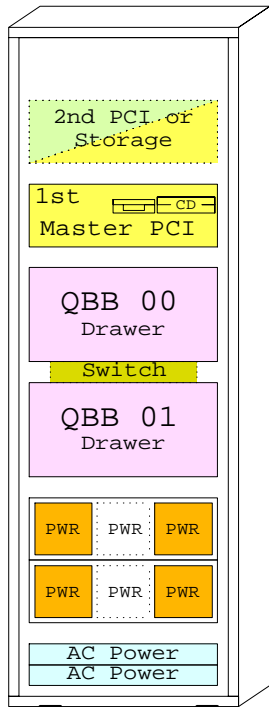
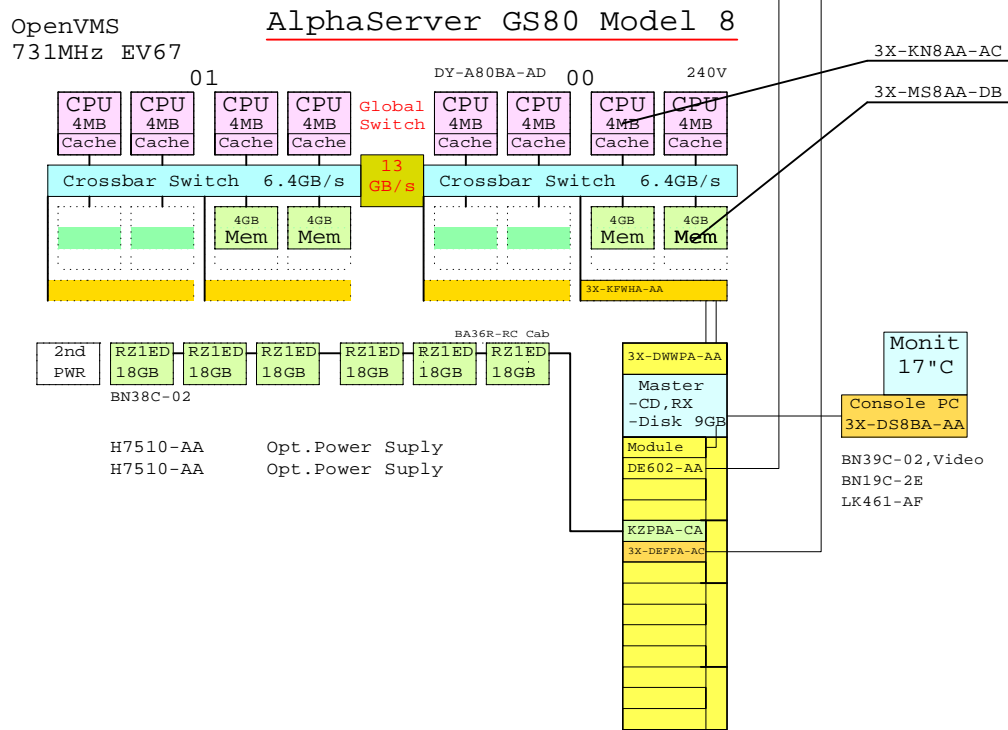

AlphaServer GS80

BOM for this system

	Part Number	Qty	Description
1	DY-A80BA-AD	1	AS GS80 M08 for 08 CPU 240V EU OVMS
1.1	3X-DEFPA-AC	1	PCI to FDDI SAS MMF with SC,Universal
1.2	3X-KN8AA-AC	7	CPU Module GS80 6/731MHz OpenVMS
1.3	3X-MS8AA-DB	4	4GB AlphaServer GS320 Memory module
1.4	BA36R-RC	1	RH ULTRASCASI SHELF CAB SINGLE
1.4.1	CK-BA35X-HH	1	180W Stor.Shelf PWR for AS4x00
1.4.2	DS-RZ1ED-VW	6	18.2GB 10000r UltraSCSI disk
1.5	BN38C-02	1	Ultra Cbl VHDCI - 68HD
1.6	H7510-AA	2	Power Suply for AS GS80 Need: 1 or 2
1.7	KZPBA-CA	1	PCI to UltraSCSI Adapter UWSE
2	3R-VRQP7-24	1	COMPAQ P75 CLR MON,NH,TC099
3	3X-DS8BA-AA	1	PC-based system console, tower, US

www.Compaq.com/golden-eggs  
Since: Sep-2000

<b>COMPAQ</b>	11-Sep-2000	GTAVGS802
	Matti.Patari@compaq.com	

AlphaServer GS80 OVMS System  
GOLDEN EGGS Visuals, Helsinki

This template is included in the present GOLDEN EGGS Software kit.

GS80 OVMS

AlphaServer GS80 OpenVMS System, 8xCPU, 64GB

Ethernet  
FDDI

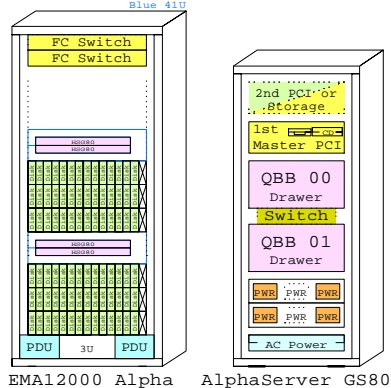
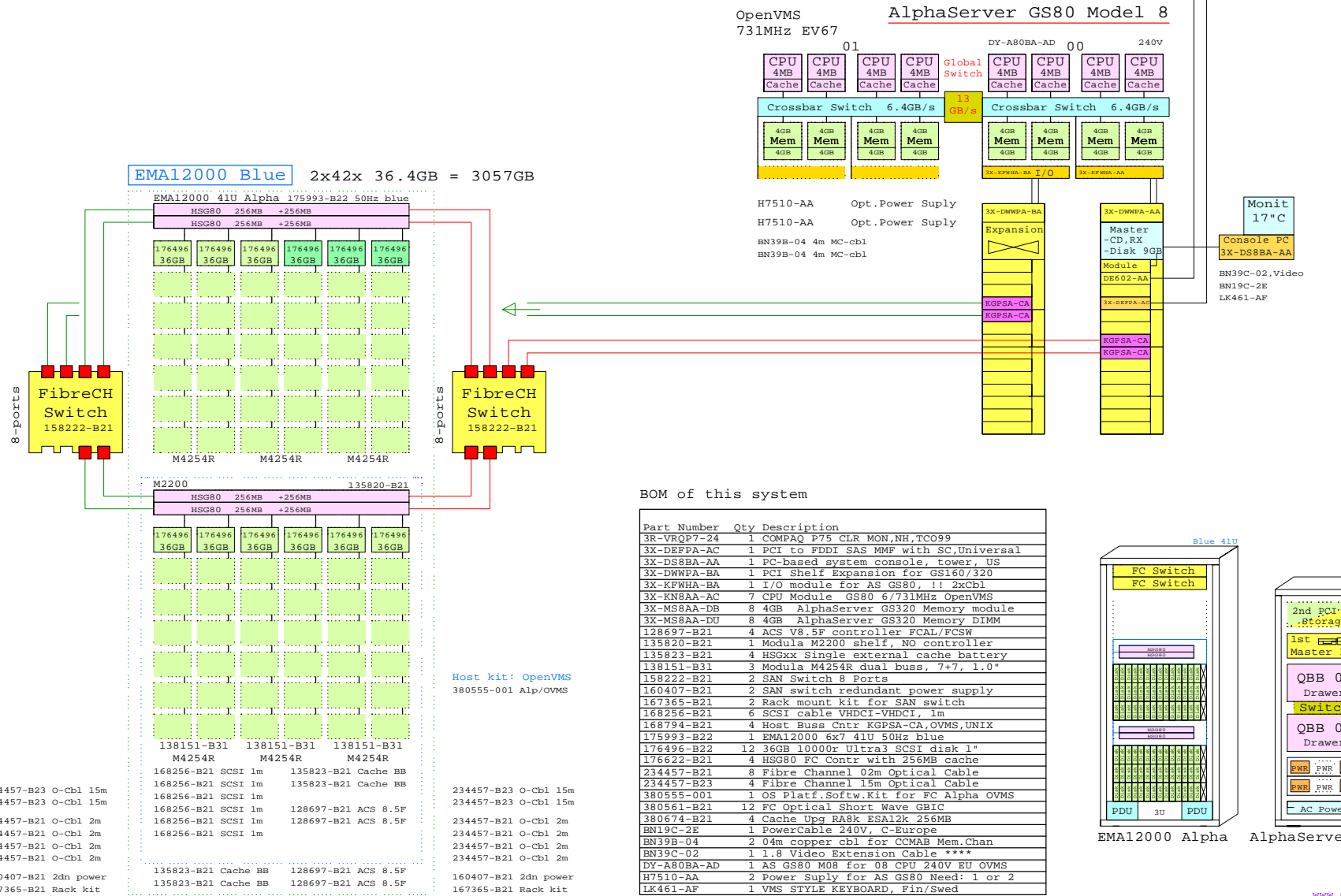

www.Compaq.com/golden-eggs  
Since Sep-2000

**COMPAQ** 14-Sep-2000 GTAVGS803  
Matti.Patari@compaq.com

AlphaServer GS80 OpenVMS System  
GOLDEN EGGS Visuals, Helsinki

Ethernet FDDI Ethernet FDDI

### AlphaServer GS80 OpenVMS Cluster

OpenVMS 731MHz EV67 AlphaServer GS80 Model 8

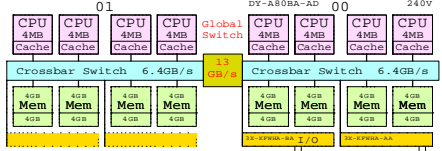

H7510-AA Opt.Power Suply  
H7510-AA Opt.Power Suply

BN39B-04 4m MC-cbl  
BN39B-04 4m MC-cbl

3X-DWPA-AA  
3X-DSBA-AA  
3X-DWPA-AA  
3X-DWPA-AA  
3X-DWPA-AA  
3X-DWPA-AA  
3X-DWPA-AA  
3X-DWPA-AA

Module  
3X-DSBA-AA  
3X-DWPA-AA  
3X-DWPA-AA  
3X-DWPA-AA  
3X-DWPA-AA  
3X-DWPA-AA  
3X-DWPA-AA

CCMAB-AA  
CCMAB-AA  
CCMAB-AA  
CCMAB-AA  
CCMAB-AA  
CCMAB-AA  
CCMAB-AA

KGPSA-CA  
KGPSA-CA  
KGPSA-CA  
KGPSA-CA  
KGPSA-CA  
KGPSA-CA  
KGPSA-CA

BN19C-02, Video  
BN19C-2E  
LK461-AF

BN39B-10 10m MC-cbl  
BN39B-10 10m MC-cbl

#### BOM of the shared Storage

Part Number	Qty	Description
128697-B21	6	ACS V8 SF controller FCAL/FCSM
135823-B21	6	HS80x Single external cache battery
158222-B21	2	SAN Switch 8 Ports
160407-B21	2	SAN switch redundant power supply
167365-B21	2	Rack mount kit for SAN switch
175990-B22	1	EMA12000 D14 42U 50Hz opal
176496-B22	18	36GB 10000r Ultra3 SCSI disk 1"
176622-B21	6	HS800 FC contr with 256MB cache
234457-B21	12	Fibre Channel 02m Optical Cable
234457-B23	4	Fibre Channel 15m Optical Cable
380555-001	1	OS Platf.Softw.Kit for FC Alpha OVMS
380561-B21	16	FC Optical Short Wave GBIC
380674-B21	6	Cache Upg RASK ESAL2K 256MB

EMA12000 D14 3x42x 36.4GB = 4586GB

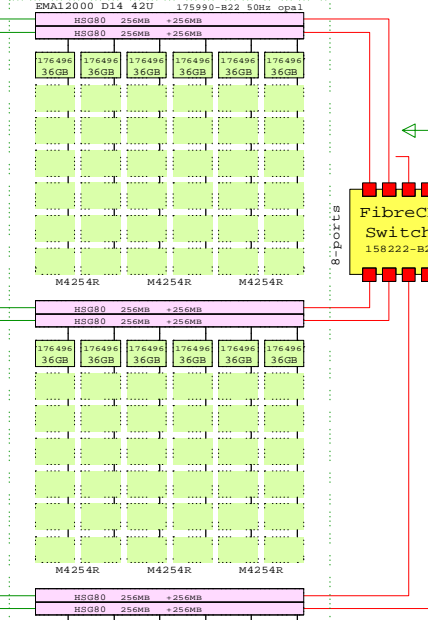

OpenVMS 731MHz EV67 AlphaServer GS80 Model 8

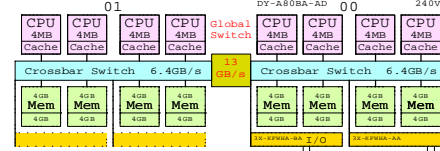

H7510-AA Opt.Power Suply  
H7510-AA Opt.Power Suply

BN39B-04 4m MC-cbl  
BN39B-04 4m MC-cbl

3X-DWPA-AA  
3X-DSBA-AA  
3X-DWPA-AA  
3X-DWPA-AA  
3X-DWPA-AA  
3X-DWPA-AA  
3X-DWPA-AA  
3X-DWPA-AA

Module  
3X-DSBA-AA  
3X-DWPA-AA  
3X-DWPA-AA  
3X-DWPA-AA  
3X-DWPA-AA  
3X-DWPA-AA  
3X-DWPA-AA

CCMAB-AA  
CCMAB-AA  
CCMAB-AA  
CCMAB-AA  
CCMAB-AA  
CCMAB-AA  
CCMAB-AA

KGPSA-CA  
KGPSA-CA  
KGPSA-CA  
KGPSA-CA  
KGPSA-CA  
KGPSA-CA  
KGPSA-CA

BN19C-02, Video  
BN19C-2E  
LK461-AF

BN39B-10 10m MC-cbl  
BN39B-10 10m MC-cbl

Dual Memory Channel

#### BOM of this GS80 OpenVMS Cluster

Part Number	Qty	Description
1	1	175990-B22 1 EMA12000 D14 42U 50Hz opal
1.1	128697-B21	6 ACS V8 SF controller FCAL/FCSM
1.2	135823-B21	6 HS80x Single external cache battery
1.3	176496-B22	18 36GB 10000r Ultra3 SCSI disk 1"
1.4	176622-B21	1 HS800 FC Contr with 256MB cache
1.4.1	380674-B23	1 Cache Upg RASK ESAL2K 256MB
1.5	176622-B21	1 HS800 FC Contr with 256MB cache
1.5.1	380674-B21	1 Cache Upg RASK ESAL2K 256MB
1.6	176622-B21	1 HS800 FC Contr with 256MB cache
1.6.1	380674-B21	1 Cache Upg RASK ESAL2K 256MB
1.7	176622-B21	1 HS800 FC Contr with 256MB cache
1.7.1	380674-B23	1 Cache Upg RASK ESAL2K 256MB
1.8	176622-B21	1 HS800 FC Contr with 256MB cache
1.8.1	380674-B21	1 Cache Upg RASK ESAL2K 256MB
1.9	176622-B21	1 HS800 FC Contr with 256MB cache
1.9.1	380674-B21	1 Cache Upg RASK ESAL2K 256MB
2	DY-A808A-AD	1 AS GS80 M08 for 08 CPU 240V EU OVMS
2.1	168794-B21	1 Host Bus Cntr KGPSA-CA.OVMS.UNIX
2.2	3X-DEPPA-AC	1 PCI to FDDI SAS MMF with SC,Universal
2.3	3X-DWPA-BA	1 PCI Shelf Expansion for GS160/320
2.3.1	168794-B21	1 Host Bus Cntr KGPSA-CA.OVMS.UNIX
2.3.2	CCMAB-AA	1 PCI Mem. Channel-2 Cluster cntrl
2.4	3X-KFWHA-BA	1 I/O module for AS GS80, 11 2xchbl
2.5	3X-KNSAA-AC	7 CPU Module GS80 6771MHz OpenVMS
2.6	3X-MS8AA-DB	8 4GB AlphaServer GS320 Memory module
2.7	3X-MS8AA-DU	8 4GB AlphaServer GS320 Memory DIMM
2.8	BN39B-04	2 04m copper cbl for CCMAB Mem.Chan
2.9	CCMAB-AA	1 PCI Mem. Channel-2 Cluster cntrl
2.10	H7510-AA	2 Power Supply for AS GS80 Need: 1 or 2
3	DY-A808A-AD	1 AS GS80 M08 for 08 CPU 240V EU OVMS
3.1	168794-B21	1 Host Bus Cntr KGPSA-CA.OVMS.UNIX
3.2	3X-DEPPA-AC	1 PCI to FDDI SAS MMF with SC,Universal
3.3	3X-DWPA-BA	1 PCI Shelf Expansion for GS160/320
3.3.1	168794-B21	1 Host Bus Cntr KGPSA-CA.OVMS.UNIX
3.3.2	CCMAB-AA	1 PCI Mem. Channel-2 Cluster cntrl
3.4	3X-KFWHA-BA	1 I/O module for AS GS80, 11 2xchbl
3.5	3X-KNSAA-AC	7 CPU Module GS80 6771MHz OpenVMS
3.6	3X-MS8AA-DB	8 4GB AlphaServer GS320 Memory module
3.7	3X-MS8AA-DU	8 4GB AlphaServer GS320 Memory DIMM
3.8	BN39B-04	2 04m copper cbl for CCMAB Mem.Chan
3.9	CCMAB-AA	1 PCI Mem. Channel-2 Cluster cntrl
3.10	H7510-AA	2 Power Supply for AS GS80 Need: 1 or 2
4	158222-B21	1 SAN Switch 8 Ports
4.1	380561-B21	8 FC Optical Short Wave GBIC
5	158222-B21	1 SAN Switch 8 Ports
5.1	380561-B21	8 FC Optical Short Wave GBIC
6	3R-VR0P7-24	2 COMPAQ P75 CLR MON.NH.TC099
7	3X-DSBA-AB	2 PC-based system console, lower, Europe
8	160407-B21	2 SAN switch redundant power supply
9	234457-B23	4 Fibre Channel 15m Optical cable
10	167365-B21	2 Rack mount kit for SAN switch
11	234457-B21	12 Fibre Channel 02m Optical Cable
12	380555-001	1 OS Platf.Softw.Kit for FC Alpha OVMS
13	BN39B-10	2 10m copper cbl for CCMAB Mem.Chan
14	BN19C-02	2 1.8 Video Extension Cable ***
15	BN19C-2E	2 PowerCable 240V -Europe
16	LK461-AF	2 VMS STYLE KEYBOARD, Fin/Swed

#### BOM of one Host

Part Number	Qty	Description
168794-B21	2	Host Bus Cntr KGPSA-CA.OVMS.UNIX
3R-VR0P7-24	2	COMPAQ P75 CLR MON.NH.TC099
3X-DEPPA-AC	1	PCI to FDDI SAS MMF with SC,Universal
3X-DSBA-AB	1	PC-based system console, lower, Europe
3X-DWPA-BA	1	PCI Shelf Expansion for GS160/320
3X-KFWHA-BA	1	I/O module for AS GS80, 11 2xchbl
3X-KNSAA-AC	7	CPU Module GS80 6771MHz OpenVMS
3X-MS8AA-DB	8	4GB AlphaServer GS320 Memory module
3X-MS8AA-DU	8	4GB AlphaServer GS320 Memory DIMM
BN19C-2E	2	PowerCable 240V -C-Europe
BN39B-04	2	04m copper cbl for CCMAB Mem.Chan
BN19C-02	1	1.8 Video Extension Cable ***
CCMAB-AA	2	PCI Mem. Channel-2 Cluster cntrl
DY-A808A-AD	1	AS GS80 M08 for 08 CPU 240V EU OVMS
H7510-AA	2	Power Supply for AS GS80 Need: 1 or 2
LK461-AF	1	VMS STYLE KEYBOARD, Fin/Swed

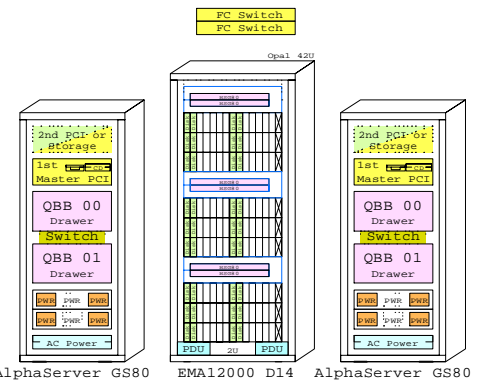

Ethernet  
GigaBitEthernet

AlphaServer GS80 OpenVMS system, 8xCPU, 64GB

Ethernet  
GigaBitEthernet

AlphaServer GS80 OpenVMS system, 8xCPU, 64GB

### OpenVMS AlphaServer GS80 Model 8

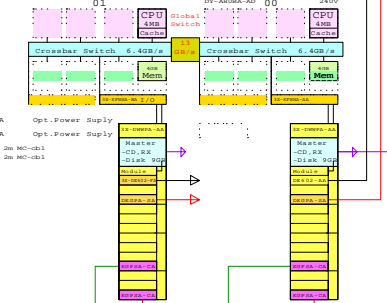

### OpenVMS AlphaServer GS80 Model 8

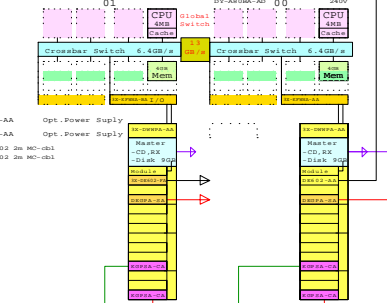

FC < 10km

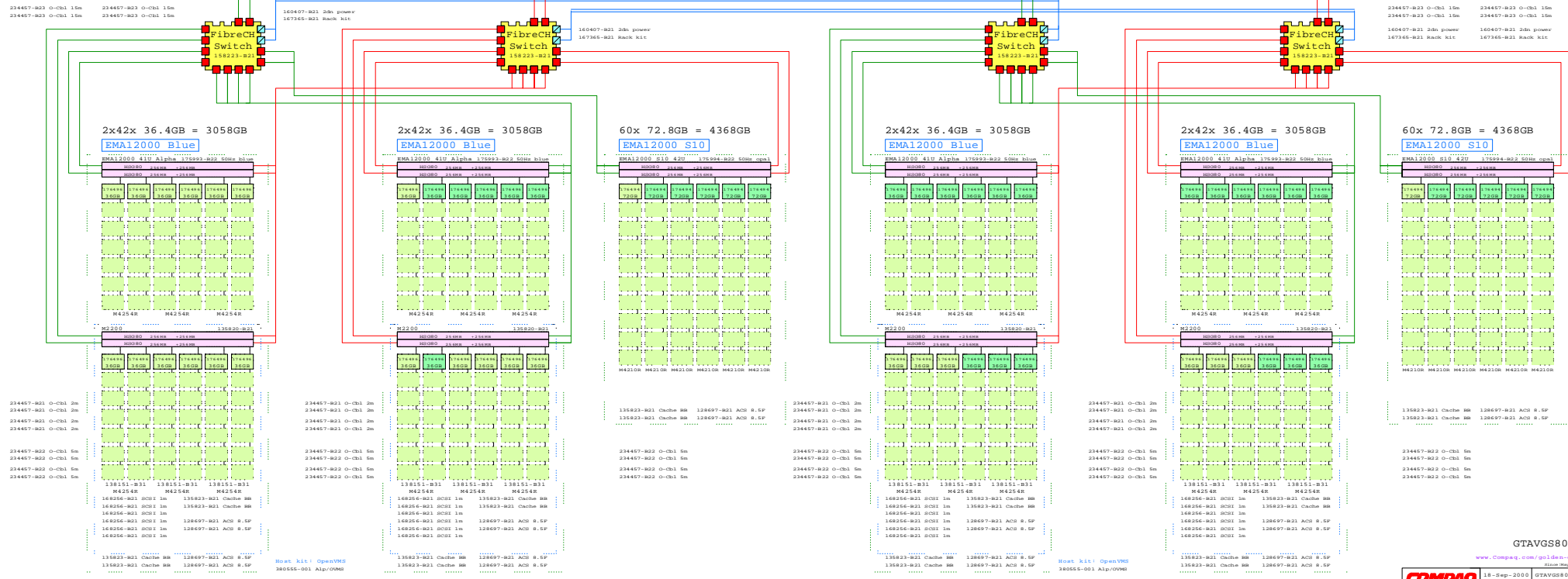

GTAVGS805

www.compaq.com/golden-eggs  
18-Sep-2000 GTAVGS805  
Matt.L.Patai@compaq.com

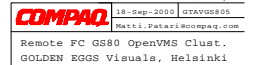

This template is included in the present GOLDEN EGGS Software kit.

GS80 OVM

Remote FC GS80 OpenVMS Clust.  
GOLDEN EGGS Visuals, Helsinki



# AlphaServer GS160 67/731 Systems

Tru64 UNIX or  
OpenVMS  
731MHz EV67

## AlphaServer GS160 Model 8

Upgrade: M8 -> M16

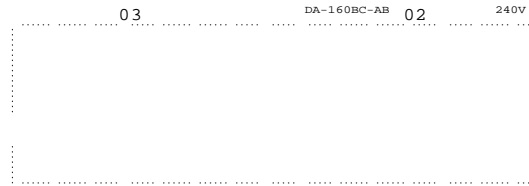
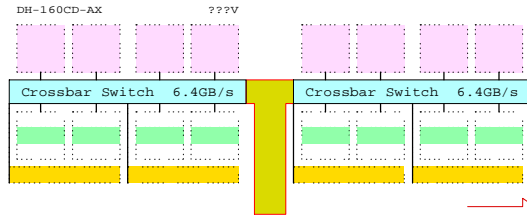

### AlphaServer GS160 Model 8

DA-160BC-AA/AB Model 8 Tru64 UNIX  
DY-160BC-AA/AB Model 8 OpenVMS  
208/416V

Field upgrade 02-03 QBB  
DH-160CD-AX

### AlphaServer GS160 Model 16

DA-160CC-AA/AB Model 16 Tru64 UNIX  
DY-160CC-AA/AB Model 16 OpenVMS  
208/416V

### Storage Shelves, 1-2

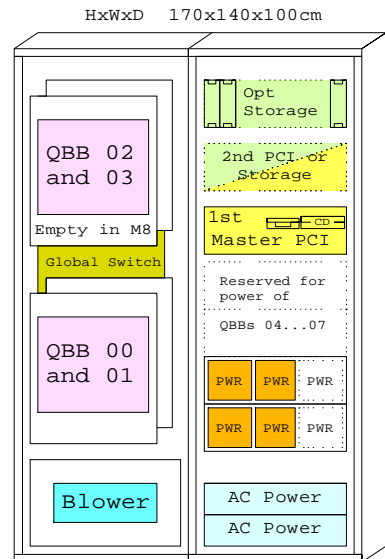
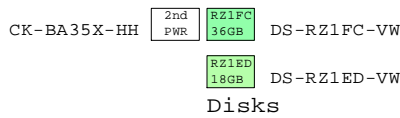
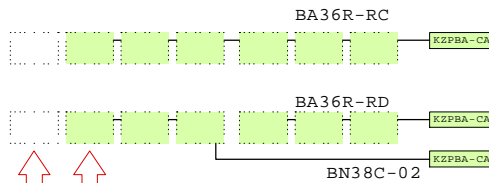

AlphaServer GS160

## GS160

One CPU included

3X-KN8AA-AD UNIX  
CPU 4MB Cache  
3X-KN8AA-AE OpenVMS

Memory Upgrade  
1GB Mem Mem: 1GB

3X-MS8AA-BB 1GB Module  
3X-MS8AA-BU 1GB DIMM

3X-MS8AA-CB 2GB Module  
3X-MS8AA-CU 2GB DIMM

3X-MS8AA-DB 4GB Module  
3X-MS8AA-DU 4GB DIMM

3R-VRQP7-24

3X-DS8BA-AA/AB Hub for 2nd partition  
3X-DS8AA-AA

BN39C-02, Video  
BN19C-2E  
SN-LKQ47-AF

### Licenses included:

- Tru64 UNIX V4.0G, Base license, Unlimited User license, Server Extension license, and Internet Solutions Software license and Netscape's Enterprise Server 3.0.
- OpenVMS V7.2-1H1 Base license and Enterprise Integration Package V3.0.

@731MHz  
SPECint95 -  
SPECfp95 -  
SPECweb96 -  
TPC -

Software Processor Code: Q

<b>COMPAQ</b>	12-Sep-2000	GEAGS1601
	Matti.Patari@compaq.com	

AlphaServer GS160 M16 System  
GOLDEN EGGS Visuals, Helsinki

AlphaServer GS160 Tru64 UNIX System

Ethernet  
FDDI

Tru64 UNIX 731MHz EV67  
AlphaServer GS160 Model 8

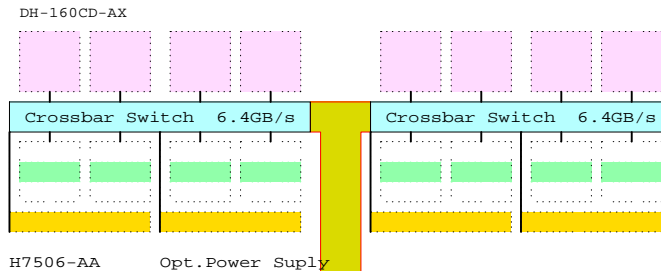

Field upgrade,  
02-03 QBB

BOM for this M08--M16 upgrade

Part Number	Qty	Description
1	1	DH-160CD-AX 2xQBB AlphaServer GS160 upg. 08->16
1.1	1	H7506-AA 1 Power Supply for AS GS160/320 Need: 1-4

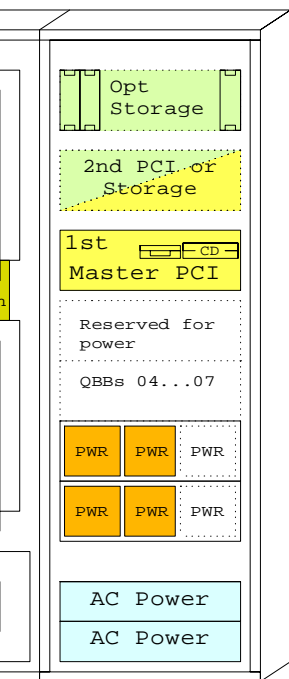
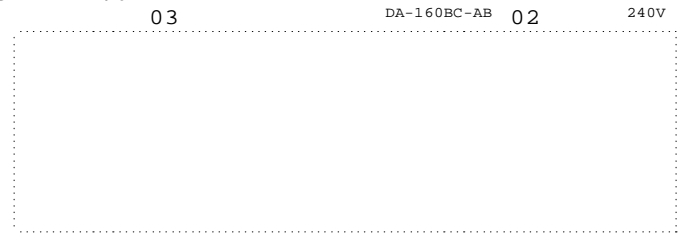

AlphaServer GS160

BOM for this M08 entry system

Part Number	Qty	Description
1	1	DA-160BC-AB 1 AS GS160 M08 for 08 CPU 240V EU UNIX
1.1	1	3X-DEFFA-AC 1 PCI to FDDI SAS MMF with SC,Universal
1.2	3	3X-KN8AA-AD 3 CPU Module GS320/160 6/731MHz Tru64 UNIX
1.3	2	3X-MS8AA-CB 2 2GB AlphaServer GS320 Memory module
1.4	1	BA36R-RC 1 RH ULTRASCSCI SHELF CAB SINGLE
1.4.1	1	CK-BA35X-HH 1 180W Stor.Shelf PWR for AS4x00
1.4.2	6	DS-RZ1FC-VW 6 36GB 10000r UltraSCSCI Disk
1.5	1	BA36R-RC 1 RH ULTRASCSCI SHELF CAB SINGLE
1.5.1	1	CK-BA35X-HH 1 180W Stor.Shelf PWR for AS4x00
1.5.2	6	DS-RZ1ED-VW 6 18.2GB 10000r UltraSCSCI disk
1.6	2	BN38C-02 2 Ultra Cbl VHDCI - 68HD
1.7	1	H7506-AA 1 Power Supply for AS GS160/320 Need: 1-4
1.8	2	KZPBA-CA 2 PCI to UltraSCSCI Adapter UWSE
2	1	3R-VRQP7-24 1 COMPAQ P75 CLR MON,NH,TCO99
3	1	3X-DS8BA-AA 1 PC-based system console, tower, US
4	1	BN39C-02 1 1.8 Video Extension Cable ****
5	1	SN-LKQ47-AF 1 102 KEY KYBD,NON-WIN, Finnish
6	1	BN19C-2E 1 PowerCable 240V, C-Europe

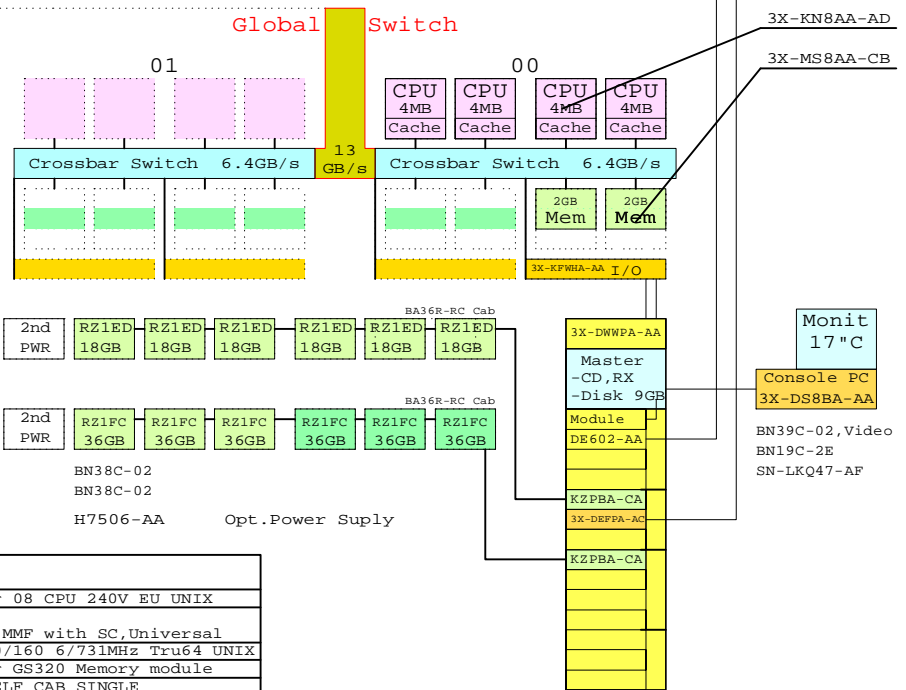

www.Compaq.com/golden-eggs  
Since: May-2000

<b>COMPAQ</b>	11-Sep-2000	GTAUGS1601
	Matti.Patari@compaq.com	

AlphaServer GS160 UNIX System  
GOLDEN EGGS Visuals, Helsinki

This template is included in the present GOLDEN EGGS Software kit.

GS160 UNIX

AlphaServer GS160 Tru64 UNIX System, 16xCPU, 128GB

Ethernet  
FDDI

Tru64 UNIX AlphaServer GS160 Model 16  
731MHz EV67

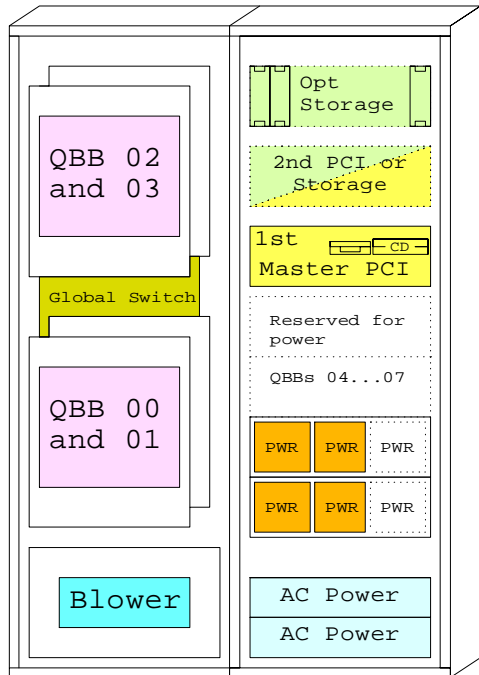
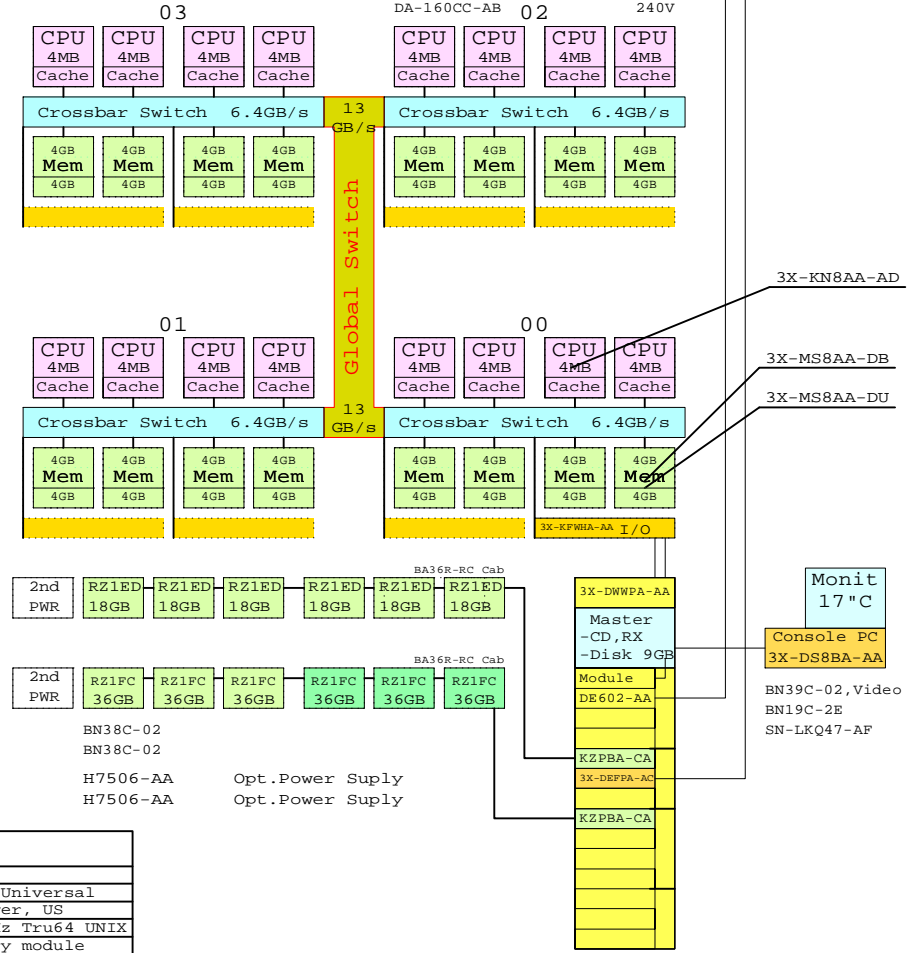

AlphaServer GS160

BOM for this system

Part Number	Qty	Description
3R-VRQP7-24	1	COMPAQ P75 CLR MON,NH,TCO99
3X-DEFFA-AC	1	PCI to FDDI SAS MMF with SC,Universal
3X-DS8BA-AA	1	PC-based system console, tower, US
3X-KN8AA-AD	15	CPU Module GS320/160 6/731MHz Tru64 UNIX
3X-MS8AA-DB	16	4GB AlphaServer GS320 Memory module
3X-MS8AA-DU	16	4GB AlphaServer GS320 Memory DIMM
BA36R-RC	2	RH ULTRASCSI SHELF CAB SINGLE
BN19C-2E	1	PowerCable 240V, C-Europe
BN38C-02	2	Ultra Cbl VHDCI - 68HD
BN39C-02	1	1.8 Video Extension Cable ****
CK-BA35X-HH	2	180W Stor.Shelf PWR for AS4x00
DA-160CC-AB	1	AS GS160 M16 for 16 CPU 240V EU UNIX
DS-RZ1ED-VW	6	18.2GB 10000r UltraSCSI disk
DS-RZ1FC-VW	6	36GB 10000r UltraSCSI Disk
H7506-AA	2	Power Supply for AS GS160/320 Need: 1-4
KZPBA-CA	2	PCI to UltraSCSI Adapter UWSE
SN-LKQ47-AF	1	102 KEY KYBD,NON-WIN, Finnish

This template is included in the present GOLDEN EGGS Software kit.

GS160 UNIX

www.Compaq.com/golden-eggs  
Since May-2000

<b>COMPAQ</b>	11-Sep-2000	GTAUGS1602
	Matti.Patari@compaq.com	

AlphaServer GS160 UNIX System  
GOLDEN EGGS Visuals, Helsinki

Ethernet  
FDDI

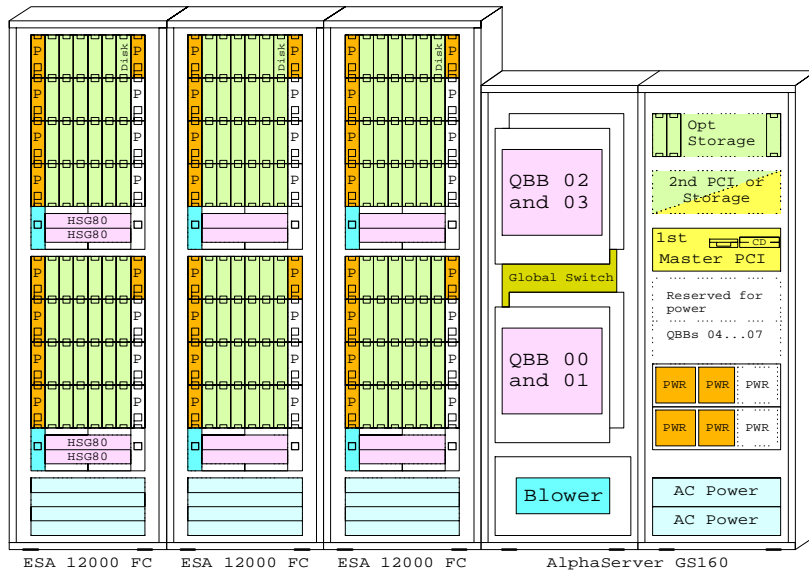

Tru64 UNIX    AlphaServer GS160 Model 16  
731MHz EV67

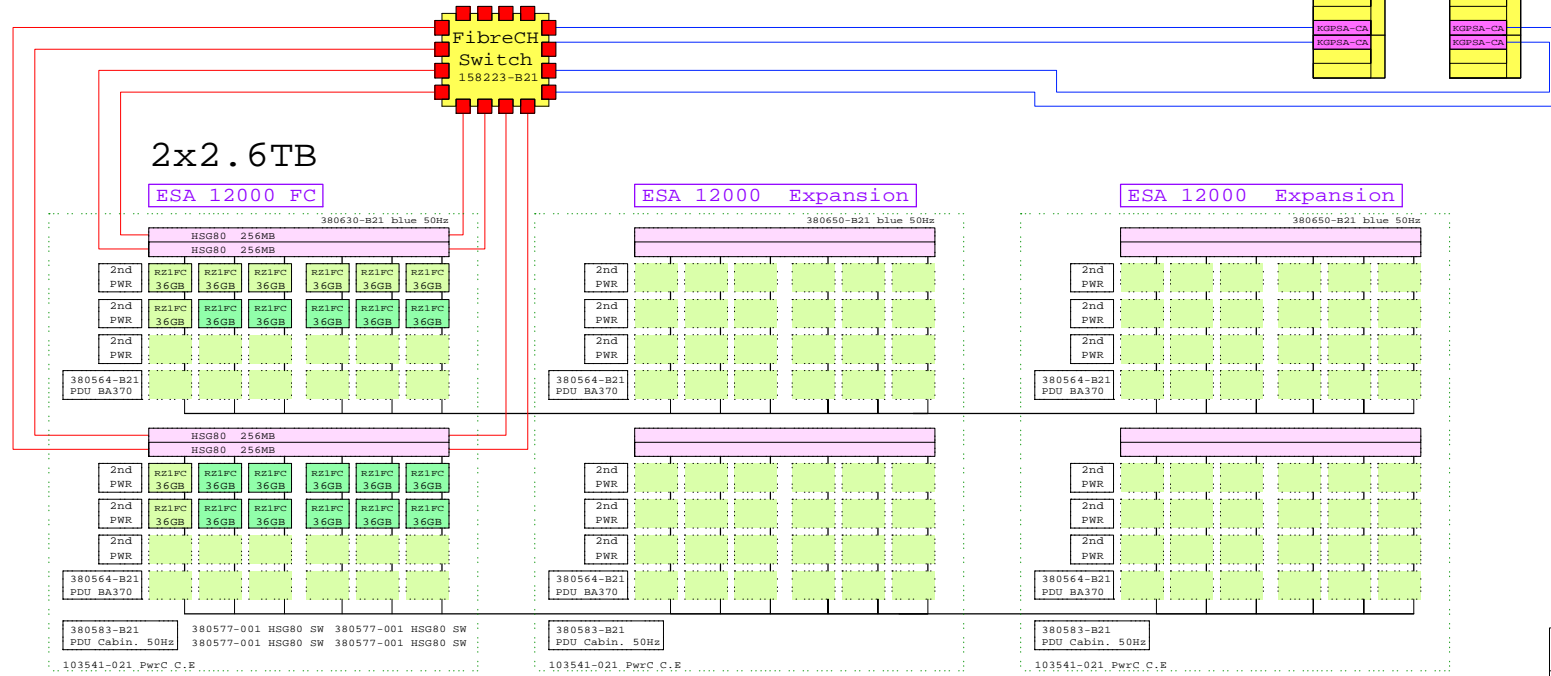
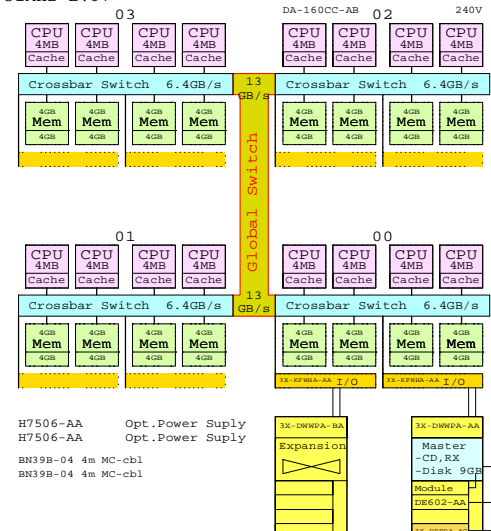

[www.Compaq.com/golden-eggs](http://www.Compaq.com/golden-eggs)  
Since May-2000

**COMPAQ** 12-Sep-2000    GTAUGS1603  
Matti.Patari@compaq.com

Ethernet  
FDDI

AlphaServer GS160 Tru64 UNIX System, 16xCPU, 128GB

AlphaServer GS160 Tru64 UNIX System, 16xCPU, 128GB

Ethernet  
FDDI

Tru64 UNIX AlphaServer GS160 Model 16  
731MHz EV67

Tru64 UNIX AlphaServer GS160 Model 16  
731MHz EV67

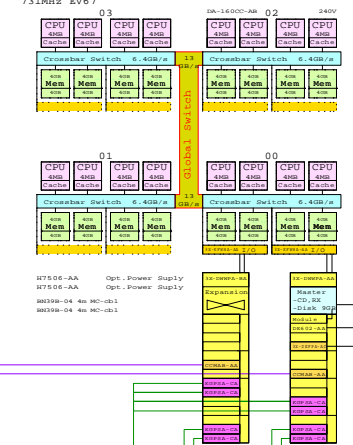
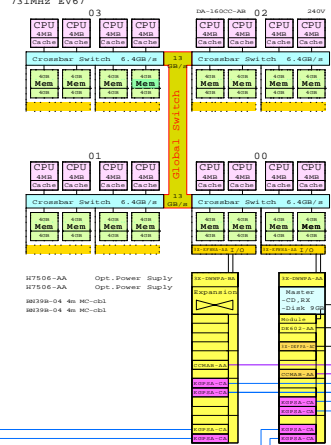

Dual Memory Channel

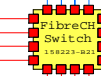

2x2.6TB  
ESA 12000 FC

ESA 12000 Expansion

ESA 12000 Expansion

2x2.6TB  
ESA 12000 FC

ESA 12000 Expansion

ESA 12000 Expansion

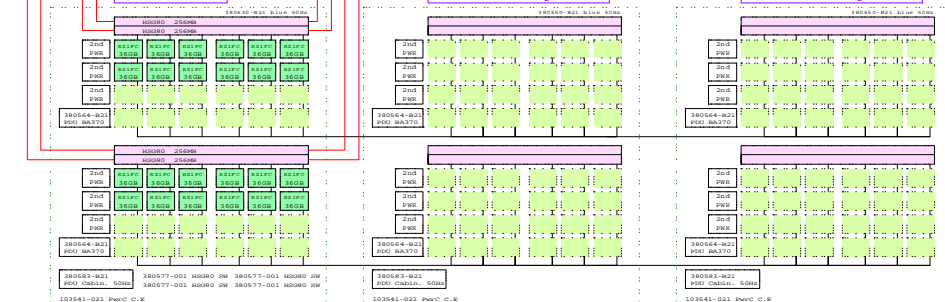
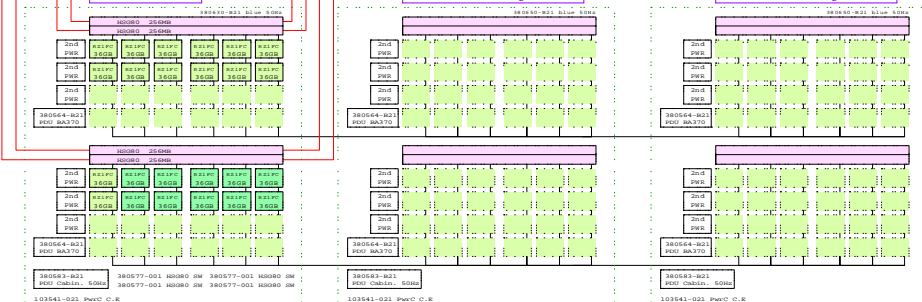

# AlphaServer GS160 OpenVMS System

Ethernet  
FDDI

OpenVMS  
731MHz EV67

AlphaServer GS160 Model 8

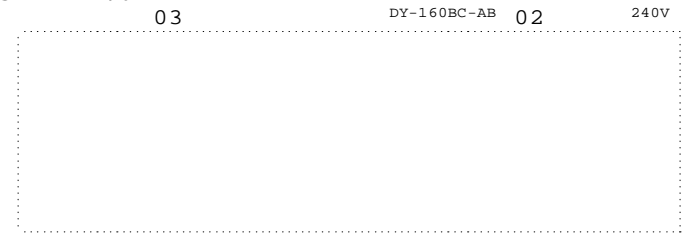
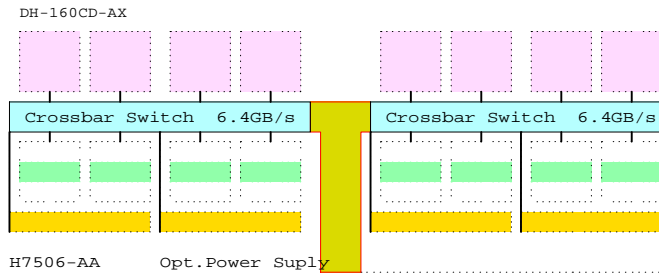

Field upgrade,  
02-03 QBB

BOM for this M08--M16 upgrade

Part Number	Qty	Description
1	1	DH-160CD-AX 2xQBB AlphaServer GS160 upg. 08->16
1.1	1	H7506-AA 1 Power Supply for AS GS160/320 Need: 1-4

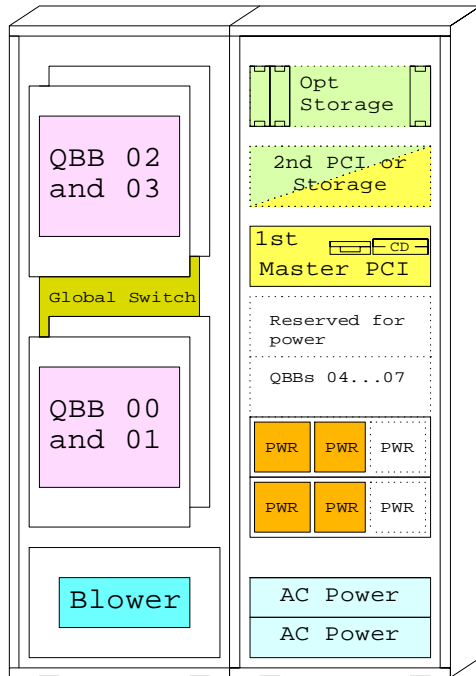

AlphaServer GS160

BOM for this system

Part Number	Qty	Description
1	1	DY-160BC-AB 1 AS GS160 M08 for 08 CPU 240V EU OVMS
1.1	1	3X-DEFFA-AC 1 PCI to FDDI SAS MMF with SC,Universal
1.2	3	3X-KN8AA-AE 3 CPU Module GS320/160 6/731MHz OpenVMS
1.3	2	3X-MS8AA-CB 2 2GB AlphaServer GS320 Memory module
1.4	1	BA36R-RC 1 RH ULTRASCSI SHELF CAB SINGLE
1.4.1	1	CK-BA35X-HH 1 180W Stor.Shelf PWR for AS4x00
1.4.2	6	DS-RZ1FC-VW 6 36GB 10000r UltraSCSI Disk
1.5	1	BA36R-RC 1 RH ULTRASCSI SHELF CAB SINGLE
1.5.1	1	CK-BA35X-HH 1 180W Stor.Shelf PWR for AS4x00
1.5.2	6	DS-RZ1ED-VW 6 18.2GB 10000r UltraSCSI disk
1.6	2	BN38C-02 2 Ultra Cbl VHDCI - 68HD
1.7	1	H7506-AA 1 Power Supply for AS GS160/320 Need: 1-4
1.8	2	KZPBA-CA 2 PCI to UltraSCSI Adapter UWSE
2	1	3R-VRQP7-24 1 COMPAQ P75 CLR MON,NH,TCO99
3	1	3X-DS8BA-AA 1 PC-based system console, tower, US
4	1	BN39C-02 1 1.8 Video Extension Cable ****
5	1	BN19C-2E 1 PowerCable 240V, C-Europe
6	1	LK461-AF 1 VMS STYLE KEYBOARD, Fin/Swed

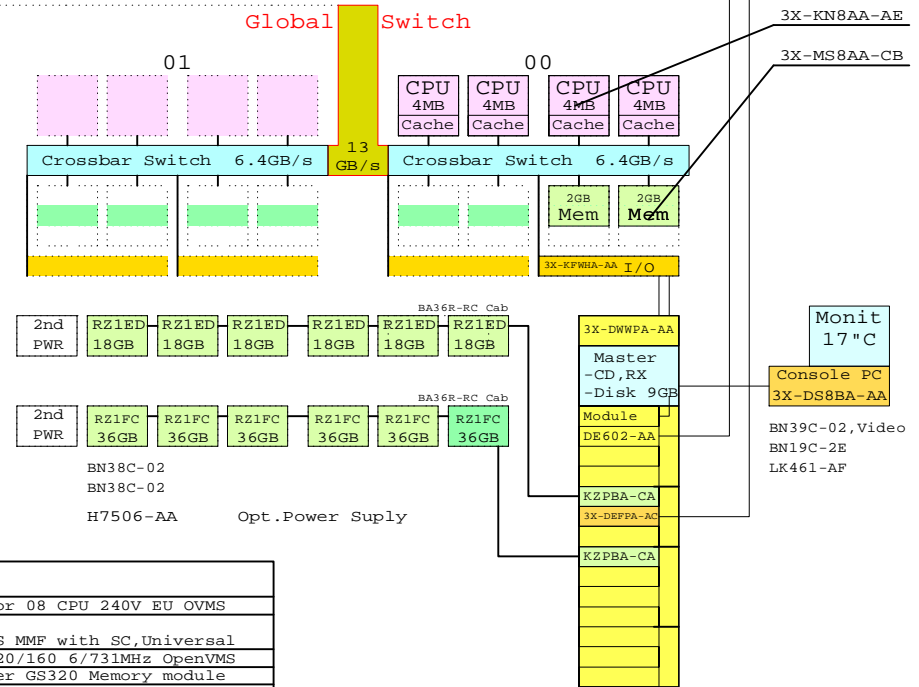

Monit  
17" C  
Console PC  
3X-DS8BA-AA  
BN39C-02, Video  
BN19C-2E  
LK461-AF

www.Compaq.com/golden-eggs  
Since: May-2000

<b>COMPAQ</b>	11-Sep-2000	GTAVGS1601
	Matti.Patari@compaq.com	

AlphaServer GS160 OVMS System  
GOLDEN EGGS Visuals, Helsinki

This template is included in the present GOLDEN EGGS Software kit.

GS160 OVMS

AlphaServer GS160 OpenVMS System, 16xCPU, 128GB

Ethernet

FDDI

OpenVMS AlphaServer GS160 Model 16  
731MHz EV67

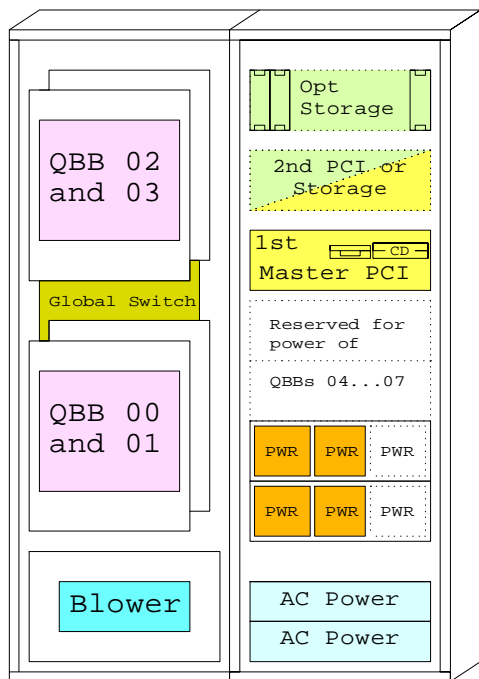
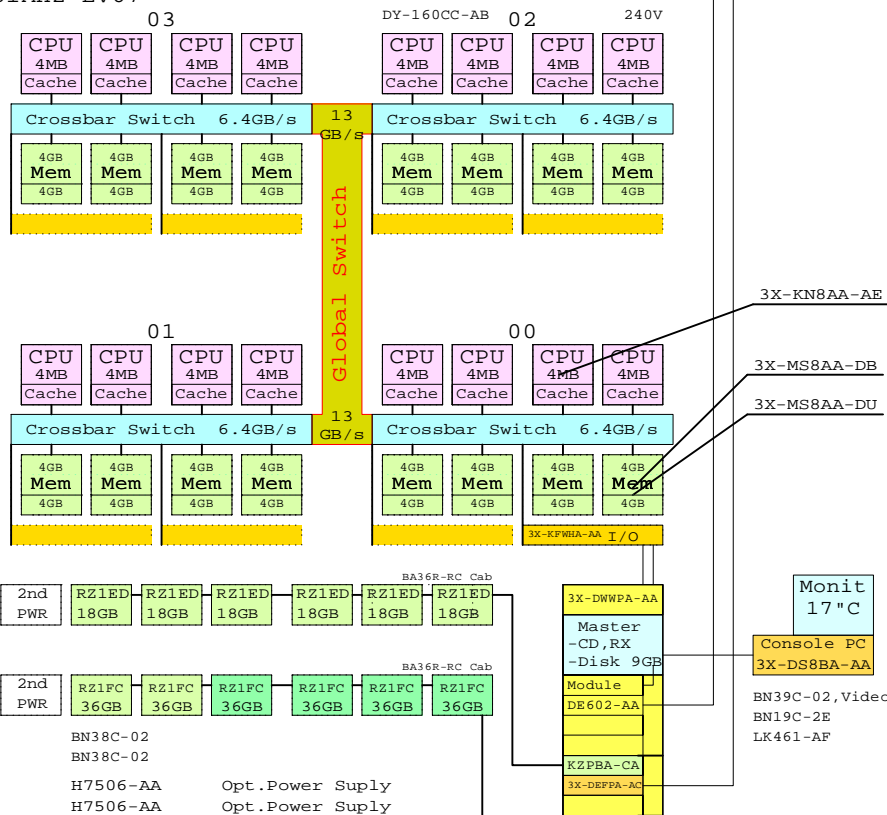

AlphaServer GS160

BOM for this system

Part Number	Qty	Description
3R-VRQP7-24	1	COMPAQ P75 CLR MON,NH,TCO99
3X-DEFFA-AC	1	PCI to FDDI SAS MMF with SC,Universal
3X-DS8BA-AA	1	PC-based system console, tower, US
3X-KN8AA-AE	15	CPU Module GS320/160 6/731MHz OpenVMS
3X-MS8AA-DB	16	4GB AlphaServer GS320 Memory module
3X-MS8AA-DU	16	4GB AlphaServer GS320 Memory DIMM
BA36R-RC	2	RH ULTRASCSTI SHELF CAB SINGLE
BN19C-2E	1	PowerCable 240V, C-Europe
BN38C-02	2	Ultra Cbl VHDCI - 68HD
BN39C-02	1	1.8 Video Extension Cable ****
CK-BA35X-HH	2	180W Stor.Shelf PWR for AS4x00
DS-RZ1ED-VW	6	18.2GB 10000r UltraSCSI disk
DS-RZ1FC-VW	6	36GB 10000r UltraSCSI Disk
DY-160CC-AB	1	AS GS160 M16 for 16 CPU 240V EU OVMS
H7506-AA	2	Power Suply for AS GS160/320 Need: 1-4
KZPBA-CA	2	PCI to UltraSCSI Adapter UWSE
LK461-AF	1	VMS STYLE KEYBOARD, Fin/Swed

This template is included in the present GOLDEN EGGS Software kit.

GS160 OVMS

www.Compaq.com/golden-eggs  
Since: May-2000

**COMPAQ** 11-Sep-2000 GTAVGS1602  
Matti.Patari@compaq.com

AlphaServer GS160 OVMS System  
GOLDEN EGGS Visuals, Helsinki

Ethernet  
FDDI



OpenVMS    AlphaServer GS160 Model 16  
731MHz EV67

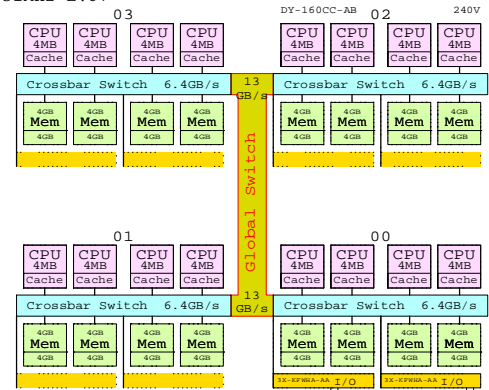

- H7506-AA    Opt.Power Suply
- H7506-AA    Opt.Power Suply
- BN39B-04 4m MC-cbl
- BN39B-04 4m MC-cbl
- 3X-DWPA-AA Expansion
- 3X-DWPA-AA Master -CD, RX -Disk 9Gb
- Module DE602-AA
- 3X-DEPPA-AA
- 3X-KPSA-AA I/O
- 3X-KPSA-AA I/O
- Monit 17°C
- Console PC 3X-DS8BA-AA
- BN39C-02.Video
- BN19C-2E
- LK461-AA

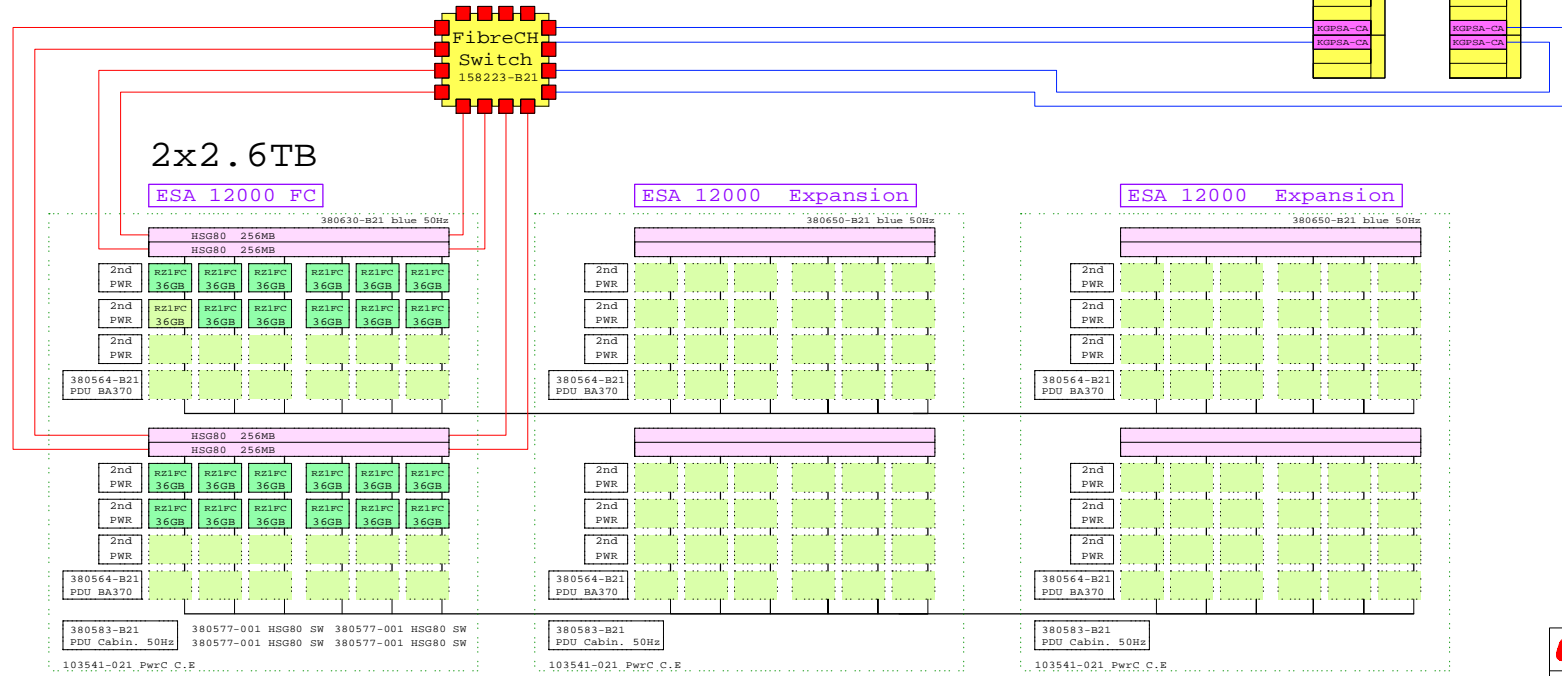

www.Compaq.com/golden-eggs  
Since May-2000

**COMPAQ** 12-Sep-2000 GTAVGS1603  
Matti.Patari@compaq.com



# AlphaServer GS160 OpenVMS Cluster

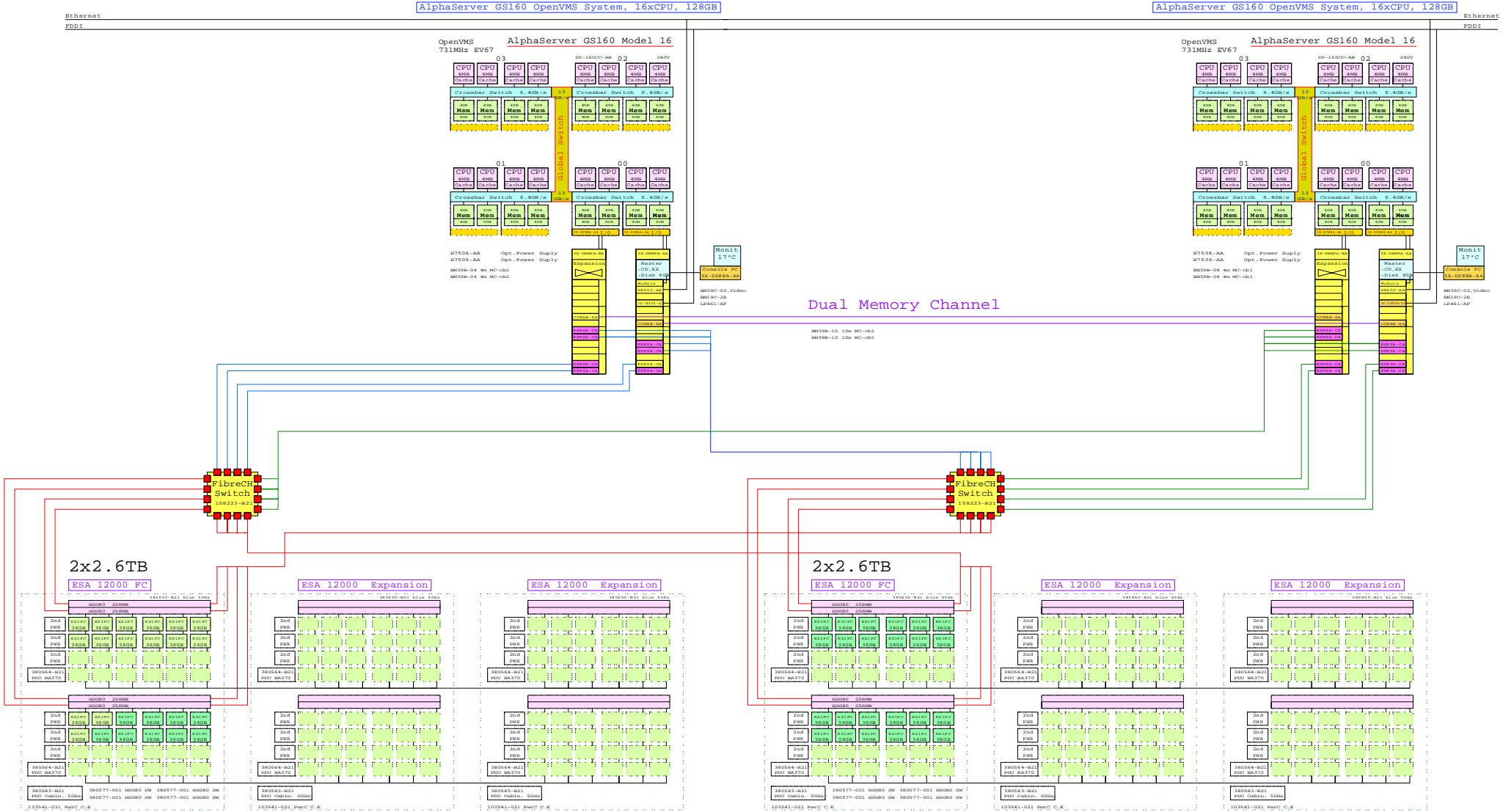

www.Compaq.com/golden-eggs  
© 1999 May 2000

GTAVGS1604



12-Sep-2000 GTAVGS1604  
Matti.Patarin@compaq.com

AlphaServer GS160 OVMs Cluster  
GOLDEN EGGS Visuals, Helsinki

This template is included in the present GOLDEN EGGS Software kit.

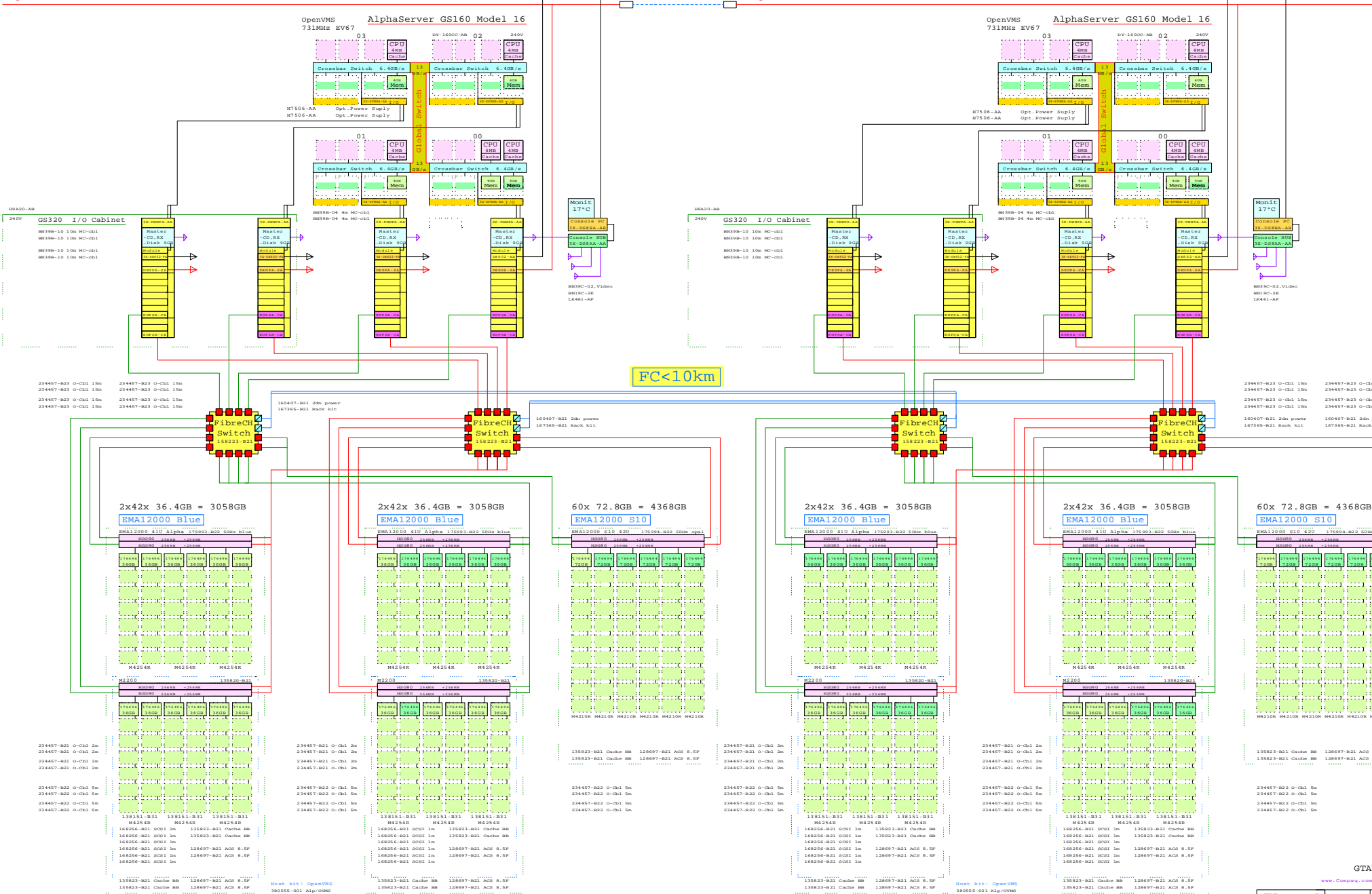

FC<10km

# AlphaServer GS320 67/731 Systems

Upgrade: M24 -> M32

Tru64 UNIX or  
OpenVMS  
731MHz EV67

## AlphaServer GS320 Model 24

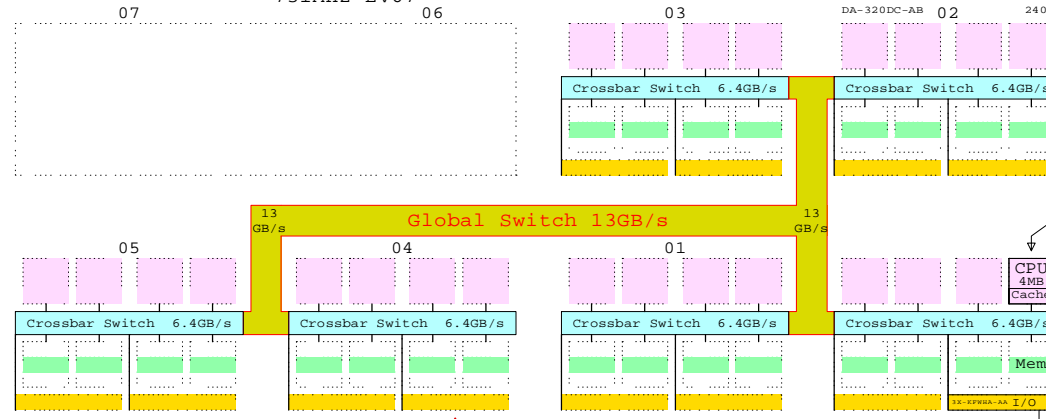
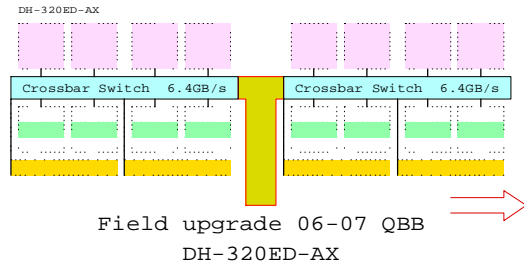

### AlphaServer GS320 Model 24

DA-320DC-AA/AB Model 24 Tru64 UNIX  
DY-320DC-AA/AB Model 24 OpenVMS  
208/416V

### AlphaServer GS320 Model 32

DA-320EC-AA/AB Model 32 Tru64 UNIX  
DY-320EC-AA/AB Model 32 OpenVMS  
208/416V

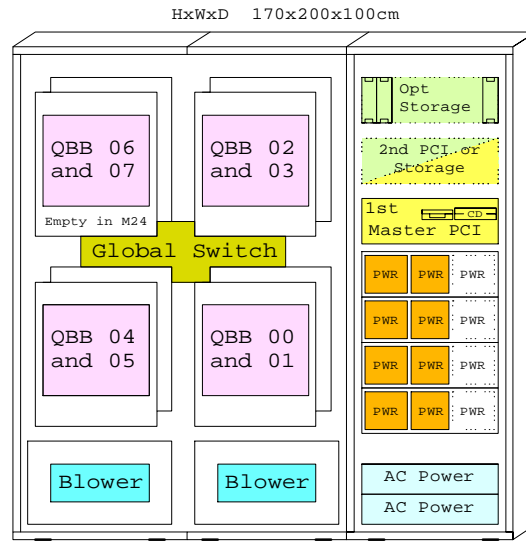

- ← One Storage
- ← Storage / PCI
- ← Standard PCI
- ← H7506-AA 1-4  
Optional power

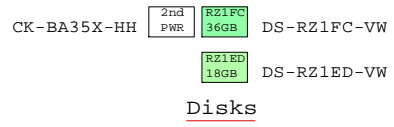
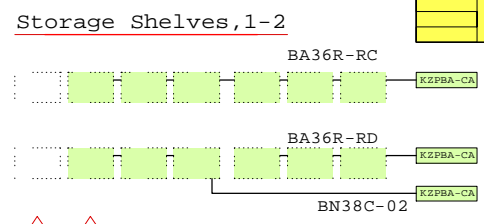
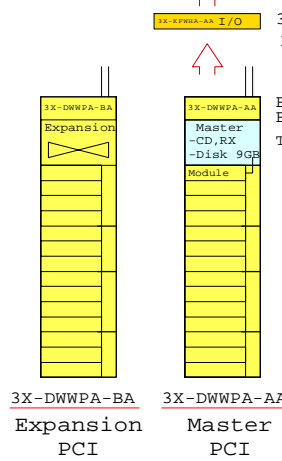

BN25G-07

- One CPU included
- CPU: 3X-KN8AA-AD UNIX, 3X-KN8AA-AE OpenVMS
- Memory: 1GB Mem (Upgrade to 2GB Mem)
- 3X-MS8AA-BB 1GB Module, 3X-MS8AA-BU 1GB DIMM
- 3X-MS8AA-CB 2GB Module, 3X-MS8AA-CU 2GB DIMM
- 3X-MS8AA-DB 4GB Module, 3X-MS8AA-DU 4GB DIMM
- Monit 17" C, 3R-VRQP7-24
- Console PC 3X-DS8BA-AA, 3X-DS8BA-AA/AB
- Console HUB 3X-DS8AA-AA, 3X-DS8AA-AA Hub for 2nd partition
- BN39C-02, Video; BN19C-2E; SN-LK047-AF

- Licenses included:
- Tru64 UNIX V4.0G, Base license, Unlimited User license, Server Extension license, and Internet Solutions Software license and Netscape's Enterprise Server 3.0.
  - OpenVMS V7.2-1H1 Base license and Enterprise Integration Package V3.0.

SPECint95 @731MHz  
SPECfp95 -  
SPECweb96 -  
TPC -  
Software Processor Code: Q

<b>COMPAQ</b>	12-Sep-2000	GEAGS3201
	Matti.Patari@compaq.com	

AlphaServer GS320 M32 System  
GOLDEN EGGS Visuals, Helsinki

Ethernet  
FDDI

AlphaServer GS320 Tru64 UNIX System

Tru64 UNIX AlphaServer GS320 Model 24  
731MHz EV67

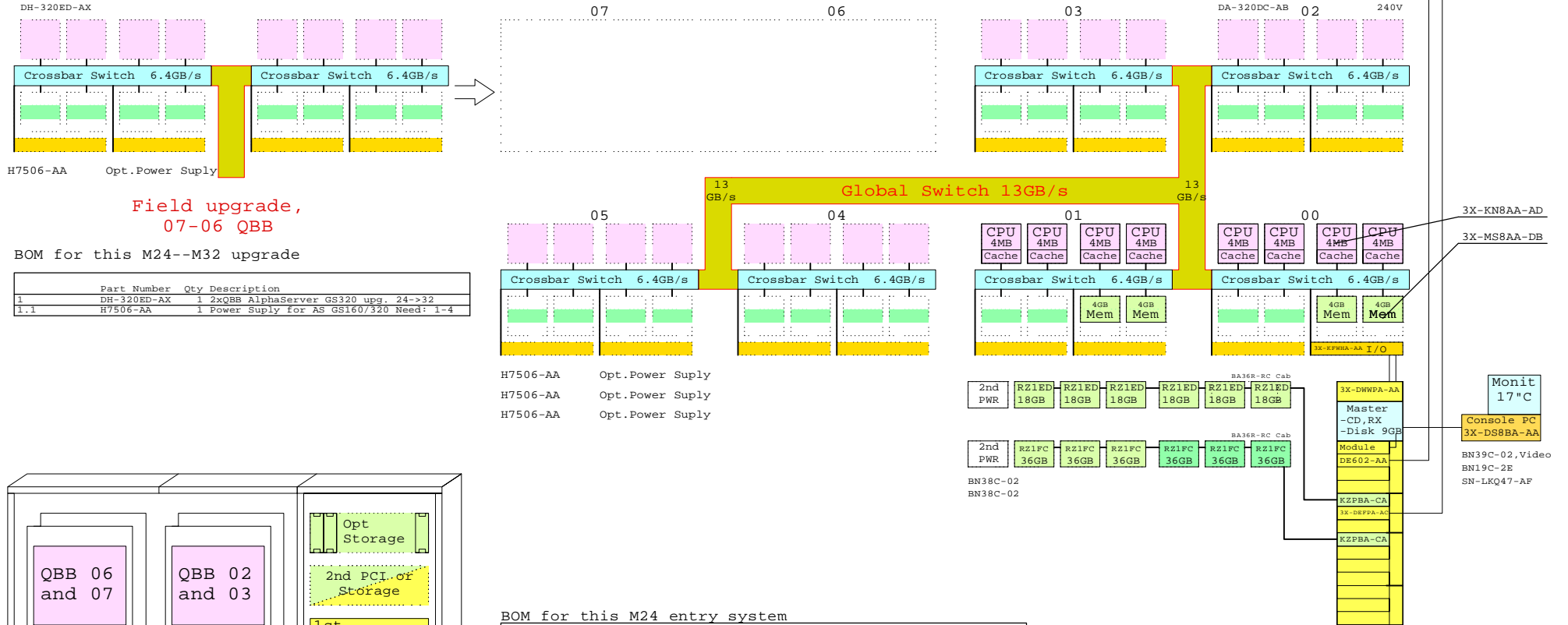

Field upgrade,  
07-06 QBB

BOM for this M24--M32 upgrade

Part Number	Qty	Description
1	1	2xQBB AlphaServer GS320 upg. 24->32
1.1	1	H7506-AA Power Supply for AS GS160/320 Need: 1-4

- H7506-AA Opt.Power Suply
- H7506-AA Opt.Power Suply
- H7506-AA Opt.Power Suply

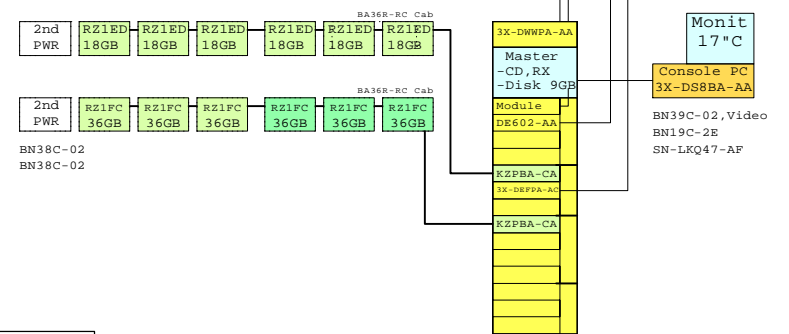

BOM for this M24 entry system

Part Number	Qty	Description
1	1	DA-320DC-AB 1 AS GS320 M24 for 24 CPU 240V EU UNIX
1.1	1	3X-DEPPA-AC 1 PCI to FDDI SAS MMF with SC,Universal
1.2	7	3X-KN8AA-AD 7 CPU Module GS320/160 6/731MHz Tru64 UNIX
1.3	4	3X-MS8AA-DB 4 4GB AlphaServer GS320 Memory module
1.4	1	BA36R-RC 1 RH ULTRASCSI SHELF CAB SINGLE
1.4.1	1	CK-BA35X-HH 1 180W Stor.Shelf PWR for AS4x00
1.4.2	6	DS-RZ1FC-VW 6 36GB 10000r UltraSCSI Disk
1.5	1	BA36R-RC 1 RH ULTRASCSI SHELF CAB SINGLE
1.5.1	1	CK-BA35X-HH 1 180W Stor.Shelf PWR for AS4x00
1.5.2	6	DS-RZ1ED-VW 6 18.2GB 10000r UltraSCSI disk
1.6	2	BN38C-02 2 Ultra Cbl VHDCI - 68HD
1.7	3	H7506-AA 3 Power Suply for AS GS160/320 Need: 1-4
1.8	2	KZPBA-CA 2 PCI to UltraSCSI Adapter UWSE
2	1	3R-VRQP7-24 1 COMPAQ P75 CLR MON,NH,TCO99
3	1	3X-DS8BA-AA 1 PC-based system console, tower, US
4	1	BN39C-02 1 1.8 Video Extension Cable ****
5	1	SN-LKQ47-AF 1 102 KEY KYBD, NON-WIN, Finnish
6	1	BN19C-2E 1 PowerCable 240V, C-Europe

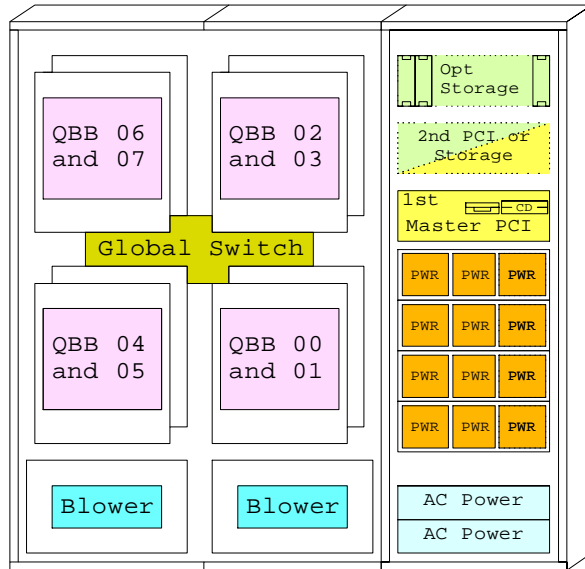

AlphaServer GS320

This template is included in the present GOLDEN EGGS Software kit.

[www.Compaq.com/golden-eggs](http://www.Compaq.com/golden-eggs)  
Since: May-2000

**COMPAQ** 11-Sep-2000 GTAUGS3201  
Matti.Patari@compaq.com

GS320 UNIX AlphaServer GS320 UNIX System  
GOLDEN EGGS Visuals, Helsinki

Ethernet  
FDDI

AlphaServer GS320 Tru64 UNIX System, 32xCPU, 256GB

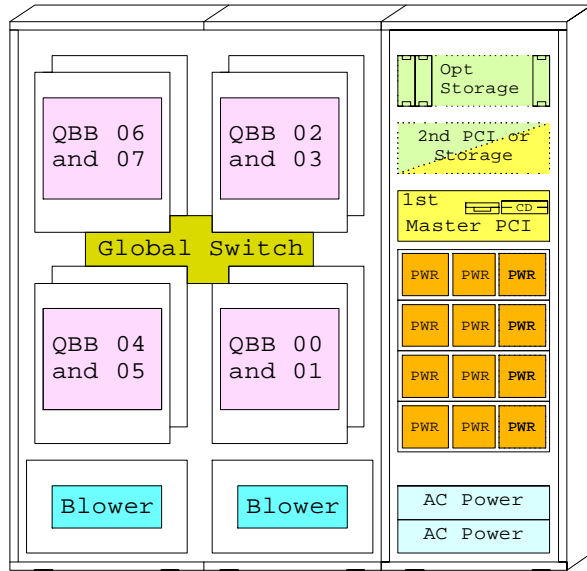
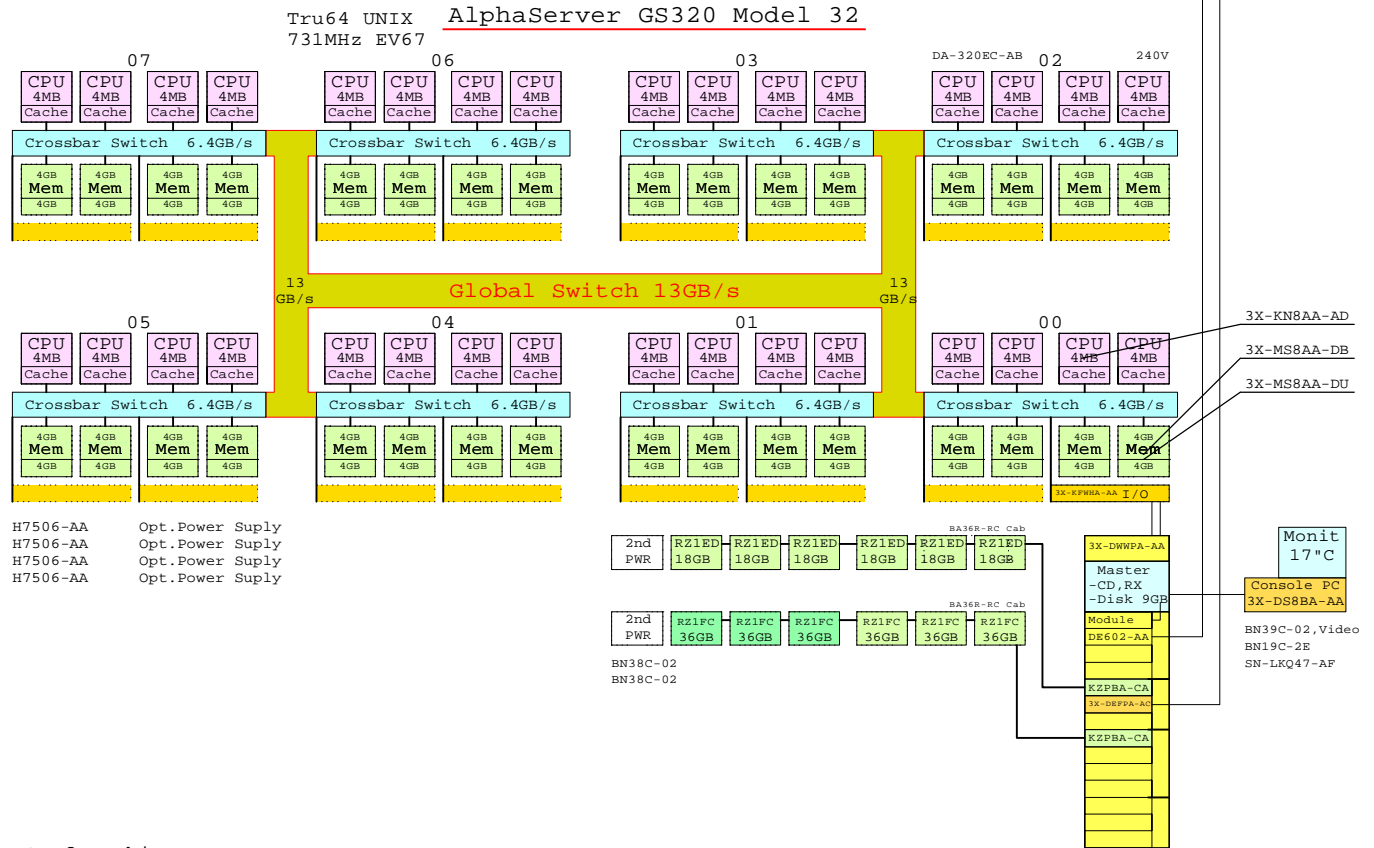

AlphaServer GS320

BOM for this system

Part Number	Qty	Description
3R-VRQF7-24	1	COMPAQ P75 CLR MON,NH,TC099
3X-DEFPA-AC	1	PCI to FDDI SAS MMF with SC,Universal
3X-DS8BA-AA	1	PC-based system console, tower, US
3X-KN8AA-AD	31	CPU Module GS320/160 6/731MHz Tru64 UNIX
3X-MS8AA-DB	32	4GB AlphaServer GS320 Memory module
3X-MS8AA-DU	32	4GB AlphaServer GS320 Memory DIMM
BA36R-RC	2	RH ULTRASCASI SHELF CAB SINGLE
BN19C-2E	1	PowerCable 240V, C-Europe
BN38C-02	2	Ultra Cbl VHDCI - 68HD
BN39C-02	1	1.8 Video Extension Cable ****
CK-BA35X-HH	2	180W Stor.Shelf PWR for AS4x00
DA-320EC-AB	1	AS GS320 M32 for 32 CPU 240V EU UNIX
DS-RZ1ED-VW	6	18.2GB 10000r UltraSCASI disk
DS-RZ1FC-VW	6	36GB 10000r UltraSCASI Disk
H7506-AA	4	Power Suply for AS GS160/320 Need: 1-4
K2PBA-CA	2	PCI to UltraSCASI Adapter UWSE
SN-LKQ47-AF	1	102 KEY KYBD, NON-WIN, Finnish

This template is included in the present GOLDEN EGGS Software kit.

GS320 UNIX



www.Compaq.com/golden-eggs  
Since: May-2000

11-Sep-2000 GTAUGS3202  
Matti.Patari@compaq.com

AlphaServer GS320 UNIX System  
GOLDEN EGGS Visuals, Helsinki

BOM of this Storage

Part Number	Qty	Description
128697-B21	6	ACS V8.5F controller FCAL/FCSW
135823-B21	6	HS08x Single external cache battery
158222-B21	2	SAN Switch 8 Ports
160407-B21	2	SAN switch redundant power supply
167365-B21	2	Rack mount kit for SAN switch
175990-B22	1	EMA12000 D14 42U 50Hz opal
176496-B22	18	36GB 10000r Ultra3 SCSI disk 1"
176622-B21	6	HSGB0 FC Contr with 256MB cache
234457-B21	12	Fibre Channel 02m Optical Cable
234457-B23	4	Fibre Channel 15m Optical Cable
380553-001	1	OS Platf.Softw.Kit for FC Alpha UNIX
380561-B21	16	FC Optical Short Wave GBIC
380674-B21	6	Cache Upg RABK ESA12K 256MB

EMA12000 D14 3x42x 36.4GB = 4586GB

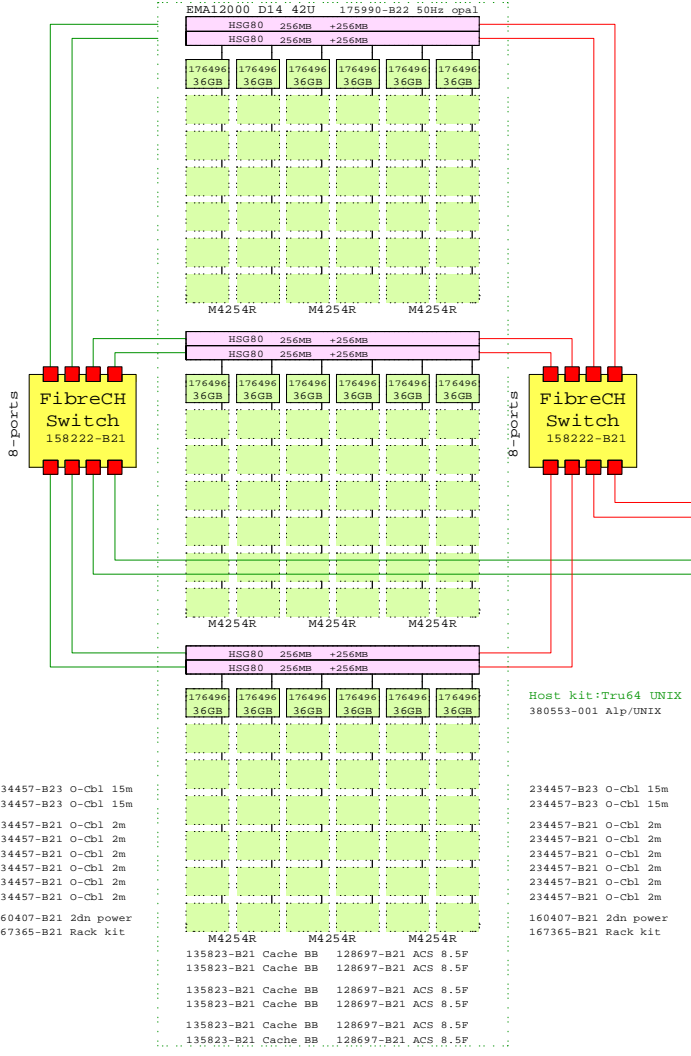

Ethernet  
FDDI

AlphaServer GS320 Tru64 UNIX System, 32xCPU, 256GB

Tru64 UNIX AlphaServer GS320 Model 32  
731MHz EV67

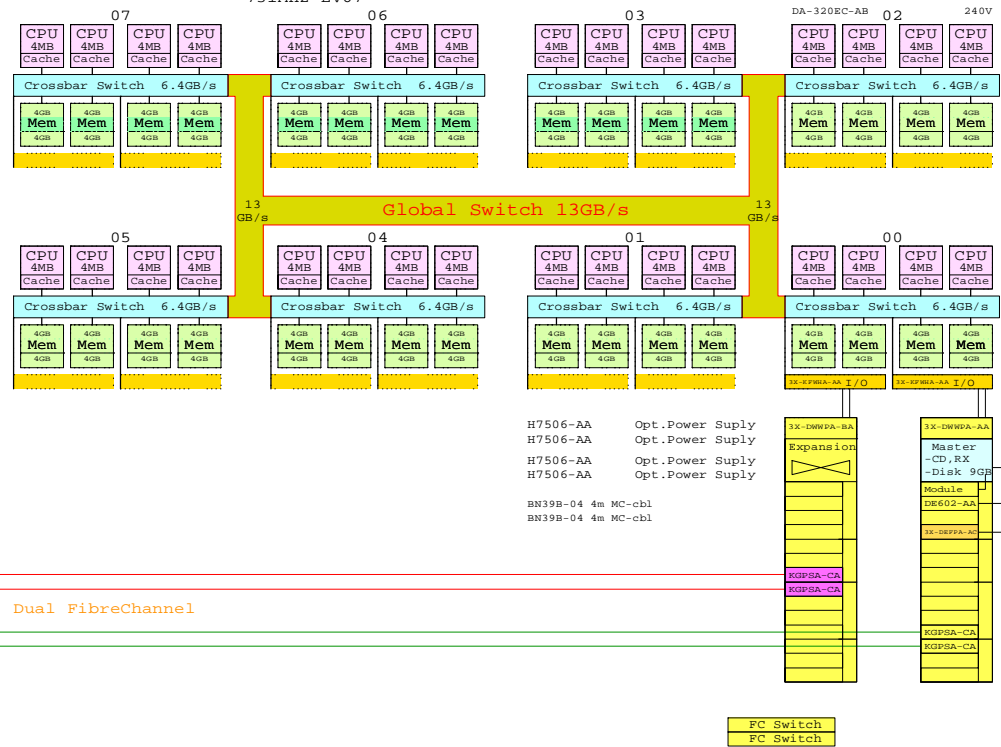

BOM of this Host

Part Number	Qty	Description
168794-B21	4	Host Bus Cntr KGPSA-CA.OVMS,UNIX
3R-VR07-24	1	COMPAQ P75 CLR MON,NH,TC099
3X-DEFFA-AC	1	PCI to FDDI SAS MMF with SC,Universal
3X-DS8BA-AB	1	PC-based system console, Tower, Europe
3X-DWHPA-BA	1	PCI Shelf Expansion for GS160/320
3X-KFWHA-AA	1	I/O module for AS GS160/320, !! 2xCbl
3X-KN8AA-AD	31	CPU Module GS320/160 6/7731MHz Tru64 UNIX
3X-MS8AA-DB	32	4GB AlphaServer GS320 Memory module
3X-MS8AA-DU	32	4GB AlphaServer GS320 Memory DIMM
BN19C-2E	1	PowerCable 240V, C-Europe
BN39B-04	2	04m copper cbl for CCMAB Mem.Chan
BN39C-02	1	1.8 Video Extension Cable ****
DA-320EC-AB	1	AS GS320 M32 for 32 CPU 240V EU UNIX
H7506-AA	4	Power Suply for AS GS160/320 Need: 1-4
SN-LKQ47-AF	1	102 KEY KYBD, NON-WIN, Finish

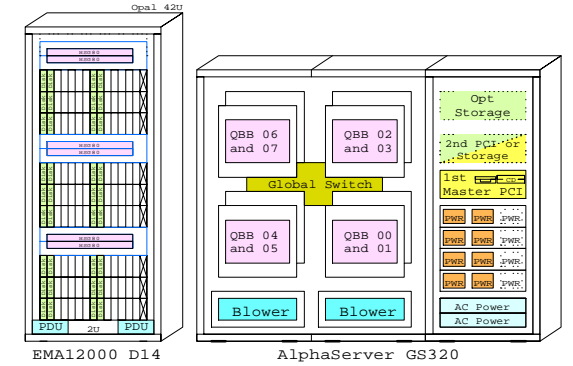

- 234457-B23 0-Cbl 15m
- 234457-B23 0-Cbl 15m
- 234457-B21 0-Cbl 2m
- 234457-B21 0-Cbl 2m
- 234457-B21 0-Cbl 2m
- 234457-B21 0-Cbl 2m
- 234457-B21 0-Cbl 2m
- 234457-B21 0-Cbl 2m
- 234457-B21 0-Cbl 2m
- 160407-B21 2dn power
- 167365-B21 Rack kit

- Host kit:Tru64 UNIX
- 380553-001 Alp/UNIX
- 234457-B23 0-Cbl 15m
- 234457-B23 0-Cbl 15m
- 234457-B21 0-Cbl 2m
- 234457-B21 0-Cbl 2m
- 234457-B21 0-Cbl 2m
- 234457-B21 0-Cbl 2m
- 234457-B21 0-Cbl 2m
- 234457-B21 0-Cbl 2m
- 160407-B21 2dn power
- 167365-B21 Rack kit

M4254R	M4254R	M4254R
135823-B21 Cache BB	128697-B21 ACS 8.5F	
135823-B21 Cache BB	128697-B21 ACS 8.5F	
135823-B21 Cache BB	128697-B21 ACS 8.5F	
135823-B21 Cache BB	128697-B21 ACS 8.5F	
135823-B21 Cache BB	128697-B21 ACS 8.5F	
135823-B21 Cache BB	128697-B21 ACS 8.5F	

www.Compaq.com/golden-eggs

**COMPAQ** 15-Sep-2000 GTAUGS3203  
Matti.Patari@compaq.com

GS320 UNIX

AlphaServer GS320 UNIX System  
GOLDEN EGGS Visuals, Helsinki

# AlphaServer GS320 TruCluster

Ethernet FDDI Ethernet FDDI

AlphaServer GS320 Tru64 UNIX System, 32xCPU, 256GB

AlphaServer GS320 Tru64 UNIX System, 32xCPU, 256GB

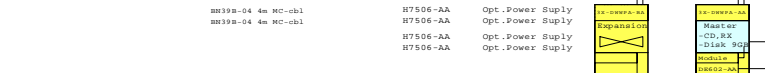
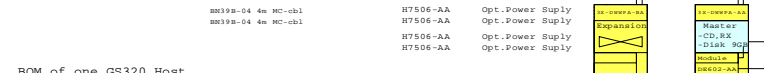
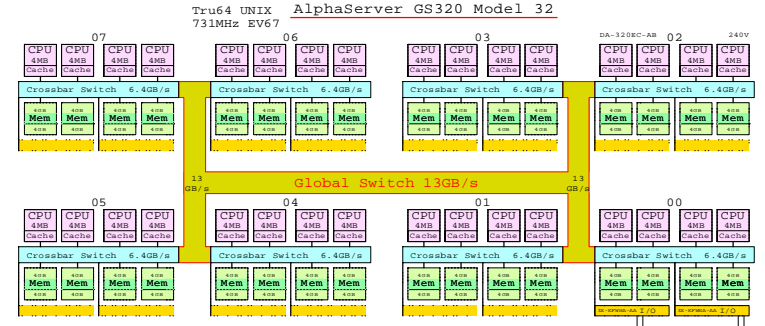
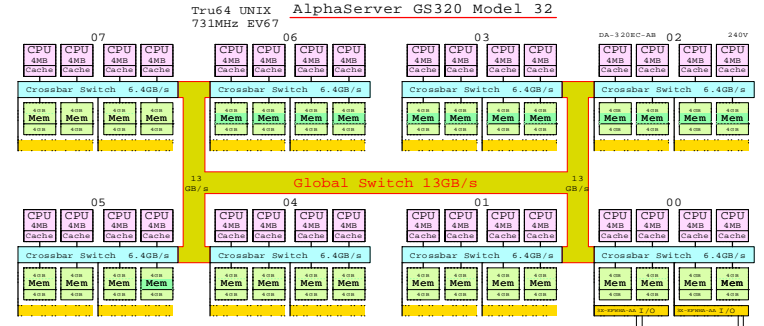

BOM of one GS320 Host

Part Number	Qty	Description
181731-B21	2	8 Pin Base Chk. 800MA-CA 0VMD UNIX
18 VVgp7-24	1	Compaq P73 cls MDR MS 20099
1X-DDBBA-AA	1	PCI to PDS 800 MW with AC Universal
1X-DDBBA-AB	1	PCI-based system console, lower, 800MA
1X-DDBBA-BA	1	PCI Shift Expansion Exp. 02150/120
1X-KYRMA-AA	1	I/O module for AS 02150/120-11-2P/BI
1X-RHAA-AD	11	CPU Module GS320/160 6731MHz Tru64 UNIX
1X-RHAA-AB	12	GBR AlphaServer GS320 Memory Module
1X-RHAA-AD	12	4GB AlphaServer GS320 Memory DIMM
BM39C-02	1	Powerable 240V 0 Storage
BM19B-04	2	04m copper CBI for FCMA Mem Chan
BM19C-02	1	1.8 Video Extension Cable ***
COMAB-AA	2	PCI Mem Channel 2 Cluster opt1
DA-320EC-AB	AS	02150 M32 for 3.0pp 240V 80 0M32
H7506-AA	3	Power Supply for AS 02150/120 Mem-14
DB-LQK47-AF	1	102 KEY EVD, NON-WTR, F10m/1h

Dual Memory Channel

FibreChannel

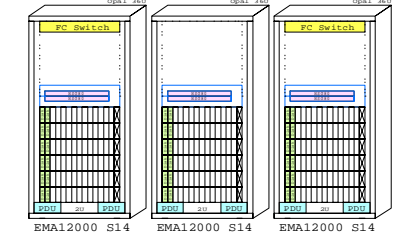
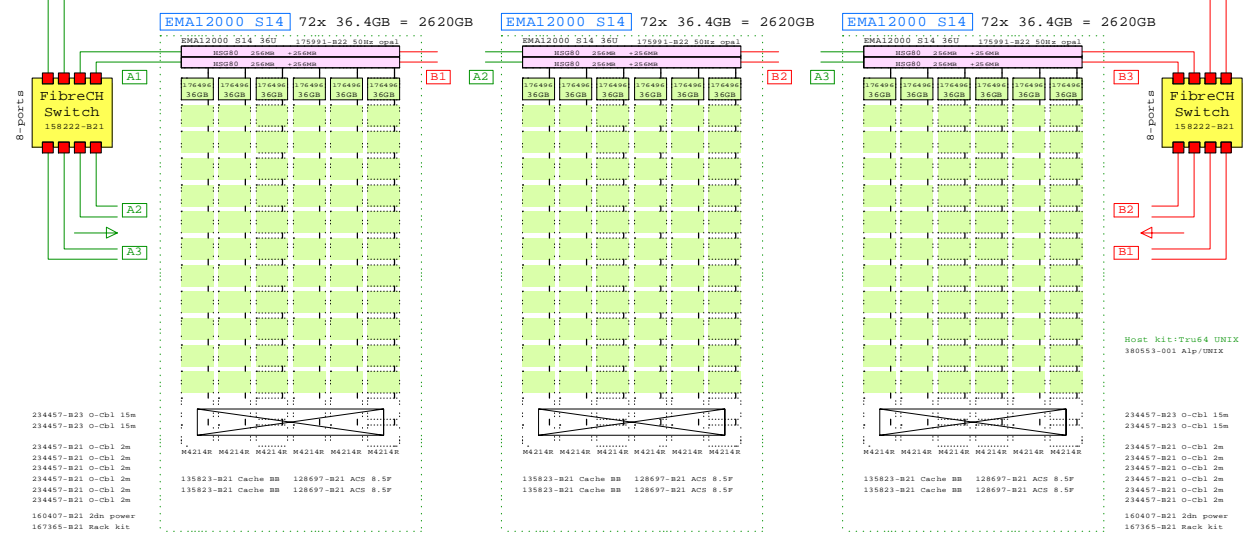
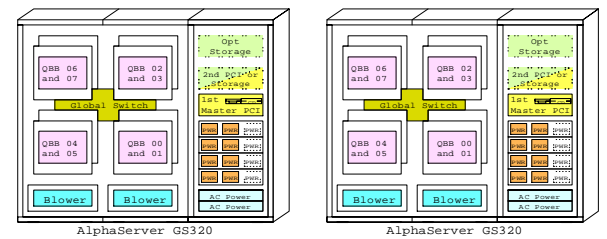

BOM of the shared Storage

Part Number	Qty	Description
131651-B21	6	6.0GB 10K RPM Compaq SCSI PATA FDDI
131821-B21	6	6.0GB Single external cache battery
131222-B21	1	1.8" Switch & Spare
160407-B21	2	2.0kW switch redundant power supply
167165-B21	2	2kW mount kit for SAN switch
170991-B22	3	EMAl2000 S14 160 36GB 3pp
176492-B22	18	16GB 10000 Diskal SCSI Disk 1
176493-B22	6	16GB FC Controller with 250MB cache
214457-B21	12	Fibre Channel 02m Optical Cable
214458-B21	4	Fibre Channel 10m Optical Cable
180551-001	1	OS Plat. Softw. Kit for FC Alpha UNIX
180552-B21	18	FC Module - Mount Base 02m Cable
180574-B21	6	Cache Exp HARK EMAl200 256GB

This template is included in the present GOLDEN EGGS Software kit.

GTAUGS3204

GS320 UNIX

www.Compaq.com/golden-eggs

15-Sep-2000 GTAUGS3204  
Matti.Pataria@compaq.com

**COMPAQ** AlphaServer GS320 UNIX Cluster  
GOLDEN EGGS Visuals, Helsinki

AlphaServer GS320 OpenVMS System

Ethernet  
FDDI

OpenVMS AlphaServer GS320 Model 24  
731MHz EV67

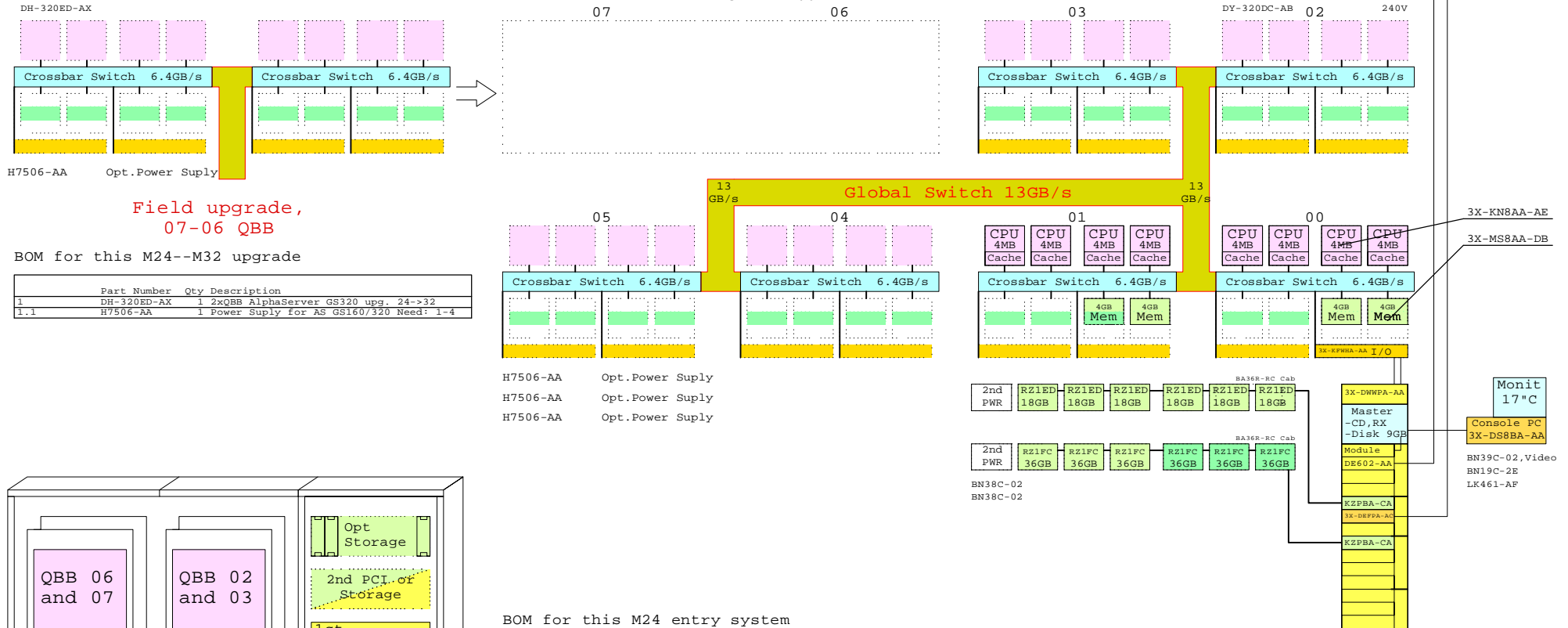

Field upgrade,  
07-06 QBB

BOM for this M24--M32 upgrade

Part Number	Qty	Description
1	1	DH-320ED-AX 2xQBB AlphaServer GS320 upg. 24->32
1.1	1	H7506-AA Power Supply for AS GS160/320 Need: 1-4

BOM for this M24 entry system

Part Number	Qty	Description
1	1	DY-320DC-AB 1 AS GS320 M24 for 24 CPU 240V EU OVMS
1.1	1	3X-DEPFA-AC 1 PCI to FDDI SAS MMF with SC,Universal
1.2	7	3X-KN8AA-AE 7 CPU Module GS320/160 6/731MHz OpenVMS
1.3	4	3X-MS8AA-DB 4 4GB AlphaServer GS320 Memory module
1.4	1	BA36R-RC 1 RH ULTRASCSCI SHELF CAB SINGLE
1.4.1	1	CK-BA35X-HH 1 180W Stor.Shelf PWR for AS4x00
1.4.2	6	DS-RZ1FC-VW 6 36GB 10000r UltraSCSI Disk
1.5	1	BA36R-RC 1 RH ULTRASCSCI SHELF CAB SINGLE
1.5.1	1	CK-BA35X-HH 1 180W Stor.Shelf PWR for AS4x00
1.5.2	6	DS-RZ1ED-VW 6 18.2GB 10000r UltraSCSI disk
1.6	2	BN38C-02 2 Ultra Cbl VHDCl - 68HD
1.7	3	H7506-AA 3 Power Suply for AS GS160/320 Need: 1-4
1.8	2	KZPBA-CA 2 PCI to UltraSCSI Adapter UWSE
2	1	3R-VRQF7-24 1 COMPAQ P75 CLR MON,NH,TCO99
3	1	3X-DS8BA-AA 1 PC-based system console, tower, US
4	1	BN39C-02 1 1.8 Video Extension Cable ****
5	1	BN19C-2E 1 PowerCable 240V, C-Europe
6	1	LK461-AF 1 VMS STYLE KEYBOARD, Fin/Swed

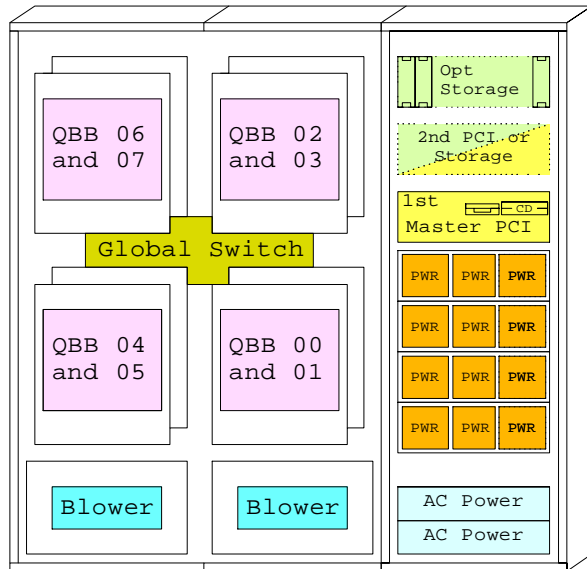

AlphaServer GS320

This template is included in the present GOLDEN EGGS Software kit.

[www.Compaq.com/golden-eggs](http://www.Compaq.com/golden-eggs)  
Since: May-2000

**COMPAQ** 11-Sep-2000 GTAVGS3201  
Matti.Patari@compaq.com

GS320 OVMS

AlphaServer GS320 OVMS System  
GOLDEN EGGS Visuals, Helsinki



Ethernet  
FDDI

AlphaServer GS320 OpenVMS System, 32xCPU, 256GB

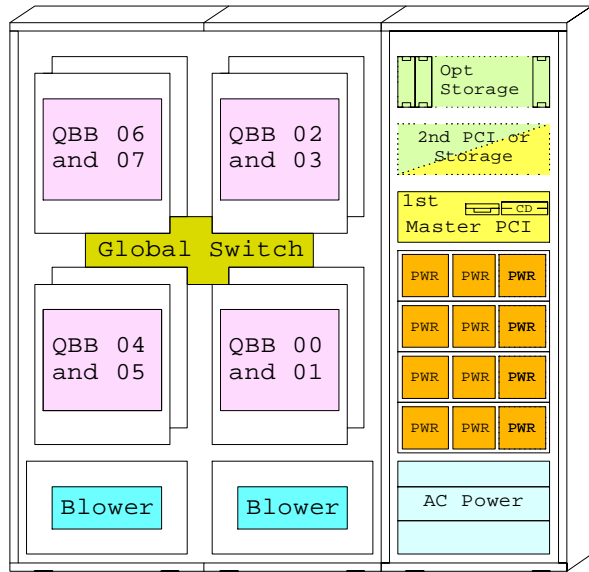
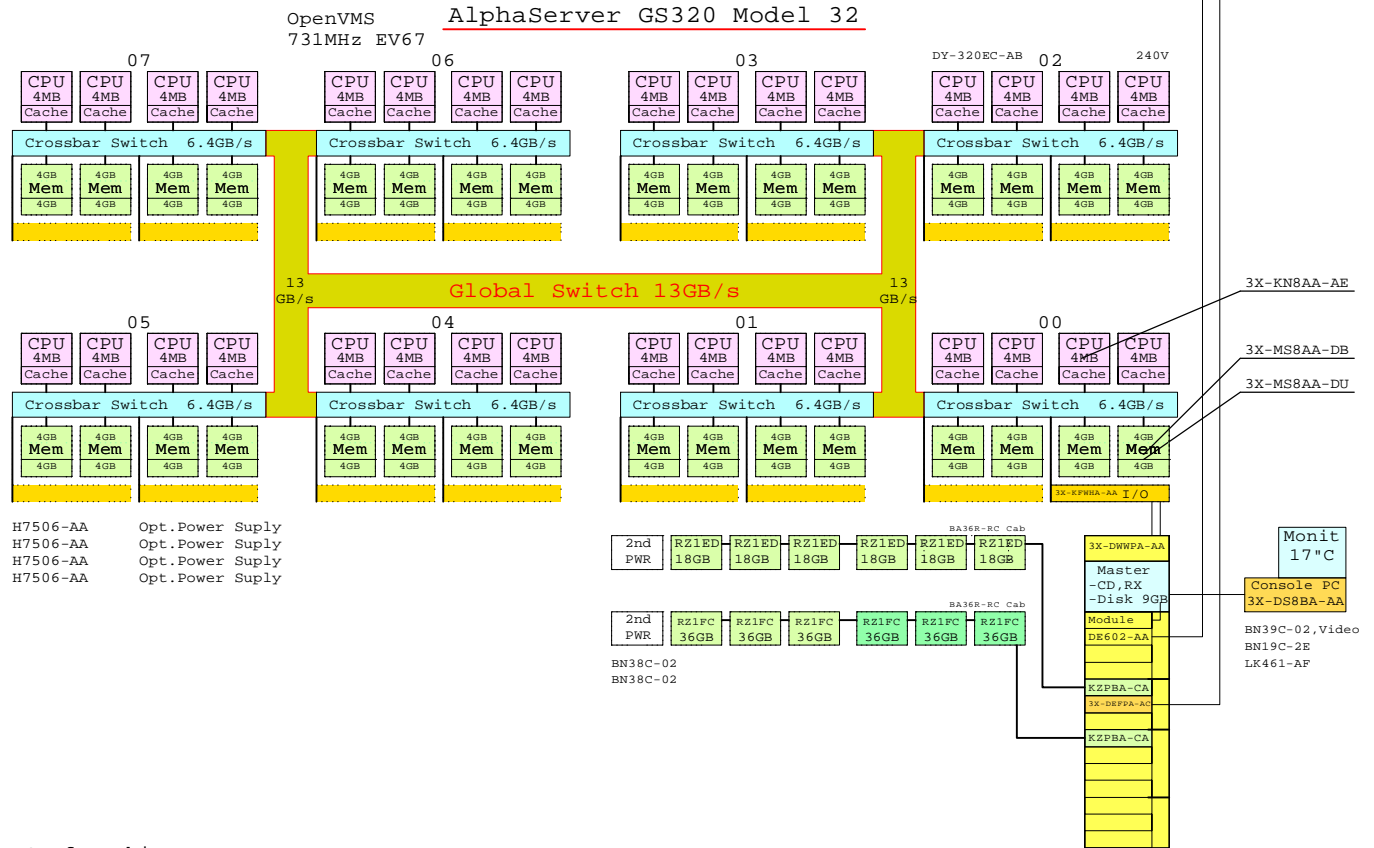

AlphaServer GS320

BOM for this system

Part Number	Qty	Description
3R-VRQP7-24	1	COMPAQ P75 CLR MON,NH,TCO99
3X-DEFPA-AC	1	PCI to FDDI SAS MMF with SC,Universal
3X-DS8BA-AA	1	PC-based system console, tower, US
3X-KN8AA-AE	31	CPU Module GS320/160 6/731MHz OpenVMS
3X-MS8AA-DB	32	4GB AlphaServer GS320 Memory module
3X-MS8AA-DU	32	4GB AlphaServer GS320 Memory DIMM
BA36R-RC	2	RH ULTRASCSI SHELF CAB SINGLE
BN19C-2E	1	PowerCable 240V, C-Europe
BN38C-02	2	Ultra Cbl VHDCl - 68HD
BN39C-02	1	1.8 Video Extension Cable ****
CK-BA35X-HH	2	180W Stor.Shelf PWR for AS4x00
DS-RZ1ED-VW	6	18.2GB 10000r UltraSCSI disk
DS-RZ1FC-VW	6	36GB 10000r UltraSCSI Disk
DY-320EC-AB	1	AS GS320 M32 for 32 CPU 240V EU OVMS
H7506-AA	4	Power Suply for AS GS160/320 Need: 1-4
KZPBA-CA	2	PCI to UltraSCSI Adapter UWSE
LK461-AF	1	VMS STYLE KEYBOARD, Fin/Swed

[www.Compaq.com/golden-eggs](http://www.Compaq.com/golden-eggs)  
Since: May-2000

**COMPAQ** 11-Sep-2000 GTAVGS3202  
Matti.Patari@compaq.com

This template is included in the present GOLDEN EGGS Software kit.

GS320 OVMS

AlphaServer GS320 OVMS System  
GOLDEN EGGS Visuals, Helsinki

BOM of this Storage

Part Number	Qty	Description
128697-B21	6	ACS V8.5F controller FCAL/FCSW
135821-B21	6	HSG8x Single external cache battery
138222-B21	2	SAN Switch 8 Ports
160407-B21	2	SAN switch redundant power supply
167365-B21	2	Rack mount kit for SAN switch
175990-B22	1	EMA12000 D14 42U 50Hz opal
176496-B22	18	36GB 10000r Ultra3 SCSI disk 1"
176622-B21	6	HSG80 FC Contr with 256MB cache
234457-B21	12	Fibre Channel 02m Optical Cable
234457-B23	4	Fibre Channel 15m Optical Cable
380555-001	1	OS Platf.Softw.Kit for FC Alpha OVMS
380561-B21	16	FC Optical Short Wave GBIC
380674-B21	6	Cache Upg RABK ESA12K 256MB

EMA12000 D14 3x42x 36.4GB = 4586GB

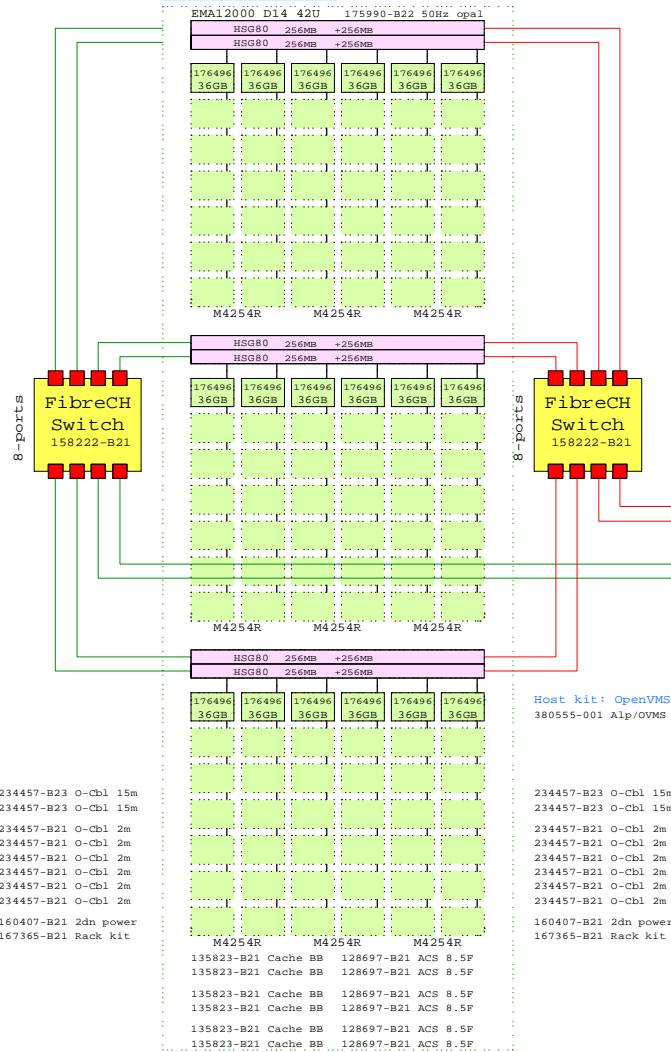

Ethernet  
FDDI

AlphaServer GS320 OpenVMS System, 32xCPU, 256GB

OpenVMS AlphaServer GS320 Model 32  
731MHz EV67

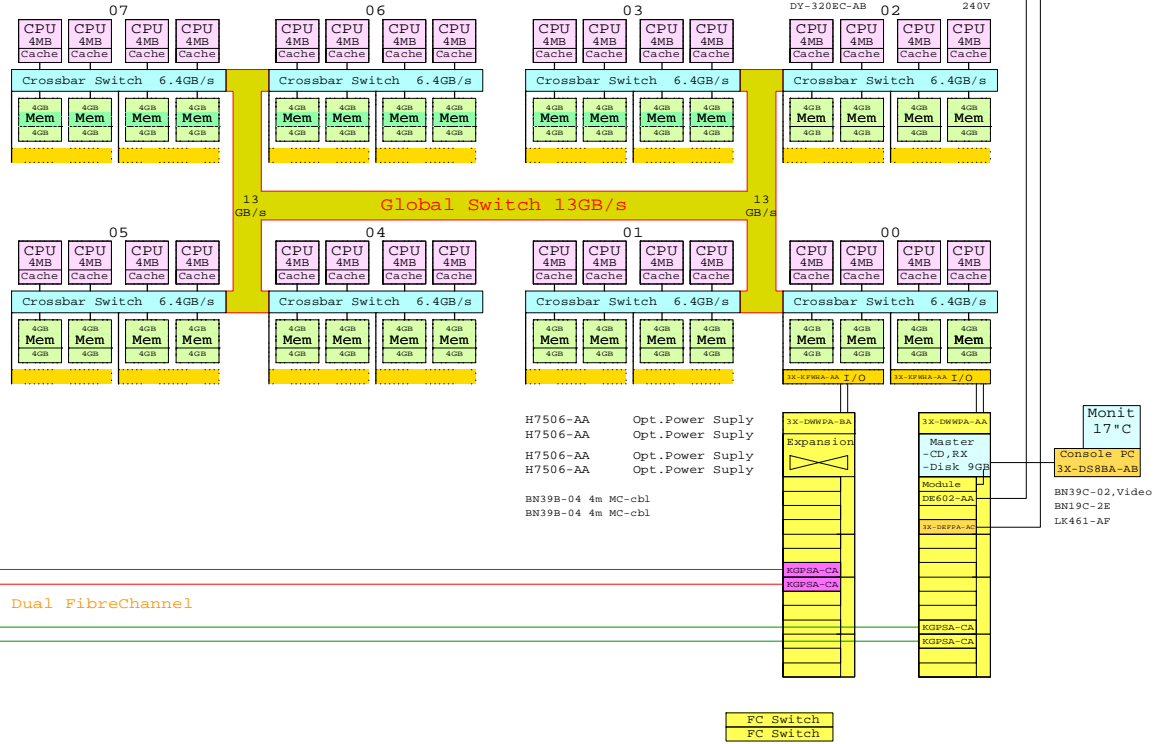

BOM of this Host

Part Number	Qty	Description
168794-B21	4	Host Bus Cntr KGPSA-CA.OVMS,UNIX
3R-VR07-24	1	COMPAQ P75 CLR MON,NH,TC099
3X-DEFFA-AC	1	PCI to FDDI SAS MMF with SC,Universal
3X-DS8BA-AB	1	PC-based system console, Tower, Europe
3X-DWHPA-BA	1	PCI Shelf Expansion for GS160/320
3X-KFWHA-AA	1	I/O module for AS GS160/320, !! 2xCbl
3X-KN8AA-AE	31	CPU Module GS320/160 6/7731MHz OpenVMS
3X-MS8AA-DB	32	4GB AlphaServer GS320 Memory module
3X-MS8AA-DU	32	4GB AlphaServer GS320 Memory DIMM
BN19C-2E	1	PowerCable 240V, C-Europe
BN39B-04	2	04m copper cbl for CCMAB Mem.Chan
BN39C-02	1	1.8 Video Extension Cable ****
DY-320EC-AB	1	AS GS320 M32 for 32 CPU 240V EU OVMS
H7506-AA	4	Power Supply for AS GS160/320 Need: 1-4
LK461-AF	1	VMS STYLE KEYBOARD, Fin/Swed

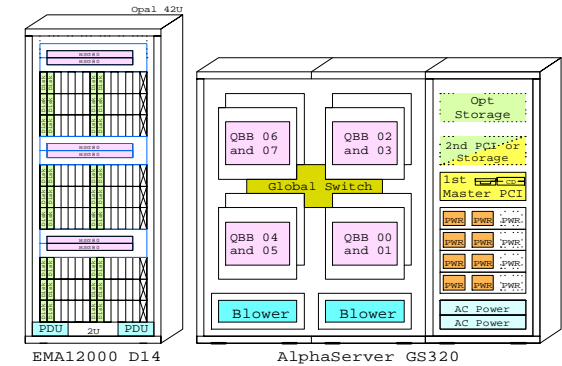

- 234457-B23 0-Cbl 15m
- 234457-B23 0-Cbl 15m
- 234457-B21 0-Cbl 2m
- 234457-B21 0-Cbl 2m
- 234457-B21 0-Cbl 2m
- 234457-B21 0-Cbl 2m
- 234457-B21 0-Cbl 2m
- 234457-B21 0-Cbl 2m
- 160407-B21 2dn power
- 167365-B21 Rack kit

- Host kit: OpenVMS  
380555-001 Alp/OVMS
- 234457-B23 0-Cbl 15m
  - 234457-B23 0-Cbl 15m
  - 234457-B21 0-Cbl 2m
  - 234457-B21 0-Cbl 2m
  - 234457-B21 0-Cbl 2m
  - 234457-B21 0-Cbl 2m
  - 234457-B21 0-Cbl 2m
  - 234457-B21 0-Cbl 2m
  - 160407-B21 2dn power
  - 167365-B21 Rack kit

Part Number	Qty	Description
M4254R	M4254R	M4254R
135823-B21	Cache BB	128697-B21 ACS 8.5F
135823-B21	Cache BB	128697-B21 ACS 8.5F
135823-B21	Cache BB	128697-B21 ACS 8.5F
135823-B21	Cache BB	128697-B21 ACS 8.5F
135823-B21	Cache BB	128697-B21 ACS 8.5F
135823-B21	Cache BB	128697-B21 ACS 8.5F

# AlphaServer GS320 OpenVMS Cluster

Ethernet  
FDDI

AlphaServer GS320 OpenVMS System, 32xCPU, 256GB

AlphaServer GS320 OpenVMS System, 32xCPU, 256GB

Ethernet  
FDDI

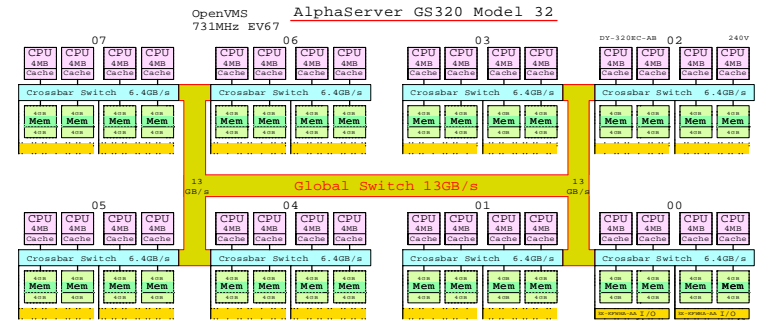
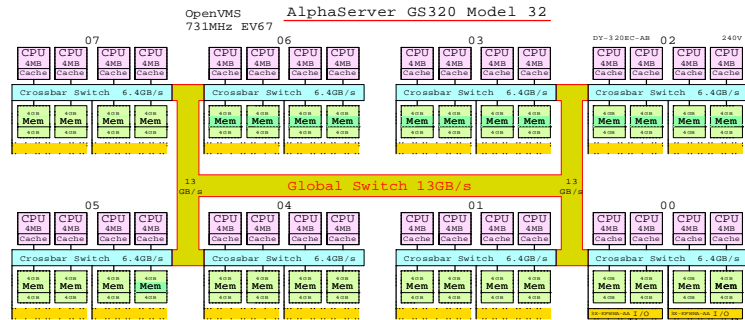

- BM39B-04 4x MC-cbl
- BM39B-04 4x MC-cbl
- H7506-AA Opt.Power Supply
- H7506-AA Opt.Power Supply
- H7506-AA Opt.Power Supply

- BM39B-04 4x MC-cbl
- BM39B-04 4x MC-cbl
- H7506-AA Opt.Power Supply
- H7506-AA Opt.Power Supply
- H7506-AA Opt.Power Supply

**BOM of one GS320 Host**

Part Number	Qty	Description
148774-B21	2	Power Base Unit KSPBA-CA, OVMS UNIX
16_V86P7_24	1	COMPAG P75 CPU MOB AM 200P
1X-REFRAC	1	PC-Backlit Keyboard with 800 Universal
1X-DSBBA-AB	1	PC-Backlit System Control, Power, Europe
1X-DMPD-BA	1	PC-Drive Separation For 02160/320
1X-KFMA-AA	1	I/O module for AS 02160/320 (1.25ch)
1X-EMBA-AB	4	CPU Module GS320/AB 6713MHz OpenVMS
1X-MBAA-DB	12	4MB AlphaServer GS320 Memory Module
1X-MBAA-DB	12	4MB AlphaServer GS320 Memory DIMM
BM39C-2E	1	Power Cable 240V C-Range
BM39B-04	2	4x MC copper cbl for COMB Mem Chan
BM39B-10	1	10x copper cbl for COMB Mem Chan
BM39C-02	1	2 Video Extension Cable ***
COMBAA-AB	2	COMB Mem Channel 1.25 Channel Card
DY-320EC-AB	1	AS GS320 B21 for 32 CPU 240V BT OVMS
BM39B-04	4	Power Supply for 32 CPU 240V BT OVMS
124461-AP	1	VMS STYLE KEYBOARD, PIN/Sw/ed

Dual Memory Channel

FibreChannel

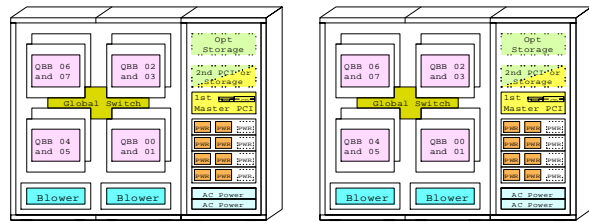

AlphaServer GS320 AlphaServer GS320

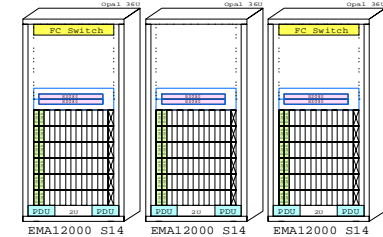

**BOM of the shared Storage**

Part Number	Qty	Description
131651-B21	6	6.0GB 10K RPM Compaq/Alp P044 P046
131821-B21	6	6.0GBx3 Single external cache battery
131222-B21	2	2x Switch & Power
160407-B21	2	2x SAN switch external power supply
167165-B21	2	2 Pack mount kit for SAN switch
170391-B22	3	EMA12000 S14 160 1500 0pm
176492-B22	18	18GB 10000 Rptal SCSI Disk 1"
176493-B21	6	6.0GB PC Controller with 250MB cache
214457-B21	12	Fibre Channel 02m Optical Cable
214457-B21	6	Fibre Channel 15m Optical Cable
180551-001	1	08 Flat Cable Kit for PC Alpha OVMS
180551-001	18	PC Controller Mount with 250MB cache
180574-B21	6	Cache Sup HARK EMA12K 250MB

EMA12000 S14 72x 36.4GB = 2620GB

EMA12000 S14 72x 36.4GB = 2620GB

EMA12000 S14 72x 36.4GB = 2620GB

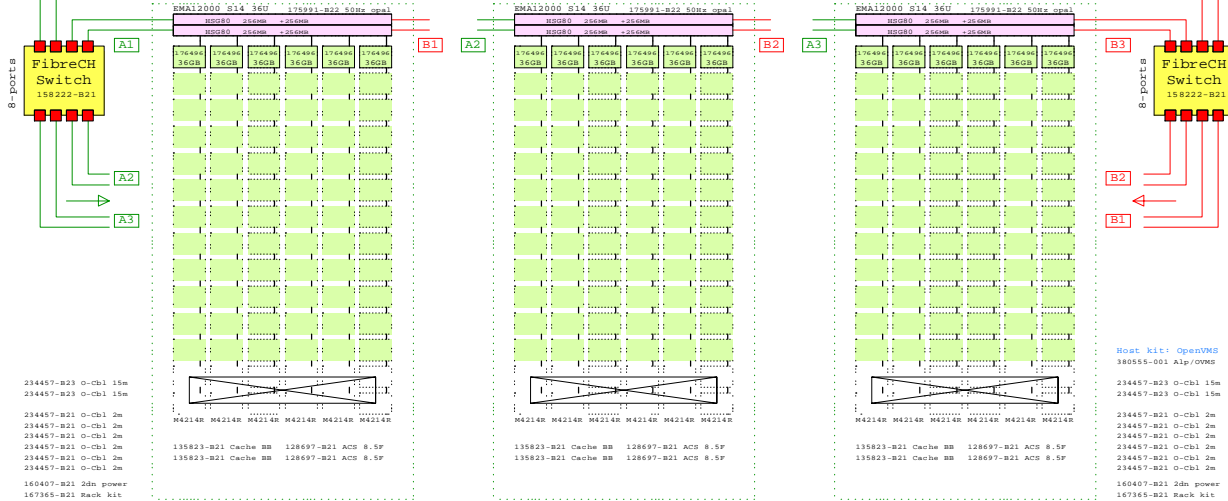

- 234457-B21 0-Cbl 15m
- 234457-B21 0-Cbl 15m
- 234457-B21 0-Cbl 2m
- 234457-B21 0-Cbl 2m
- 234457-B21 0-Cbl 2m
- 234457-B21 0-Cbl 2m
- 234457-B21 0-Cbl 2m
- 160407-B21 2dn power
- 167165-B21 Rack kit

- 131823-B21 Cache BB 128697-B21 ACS 8.5P
- 131823-B21 Cache BB 128697-B21 ACS 8.5P

- 131823-B21 Cache BB 128697-B21 ACS 8.5P
- 131823-B21 Cache BB 128697-B21 ACS 8.5P

- Root kit: OpenVMS
- 380555-001 Alp/OVMS
- 234457-B21 0-Cbl 15m
- 234457-B21 0-Cbl 15m
- 234457-B21 0-Cbl 2m
- 234457-B21 0-Cbl 2m
- 234457-B21 0-Cbl 2m
- 234457-B21 0-Cbl 2m
- 160407-B21 2dn power
- 167165-B21 Rack kit

www.Compaq.com/golden-eggs



AlphaServer GS320 OVMS Cluster GOLDEN EGGS Visuals, Helsinki

This template is included in the present GOLDEN EGGS Software kit.

GTAVGS3204

GS320 OVMS

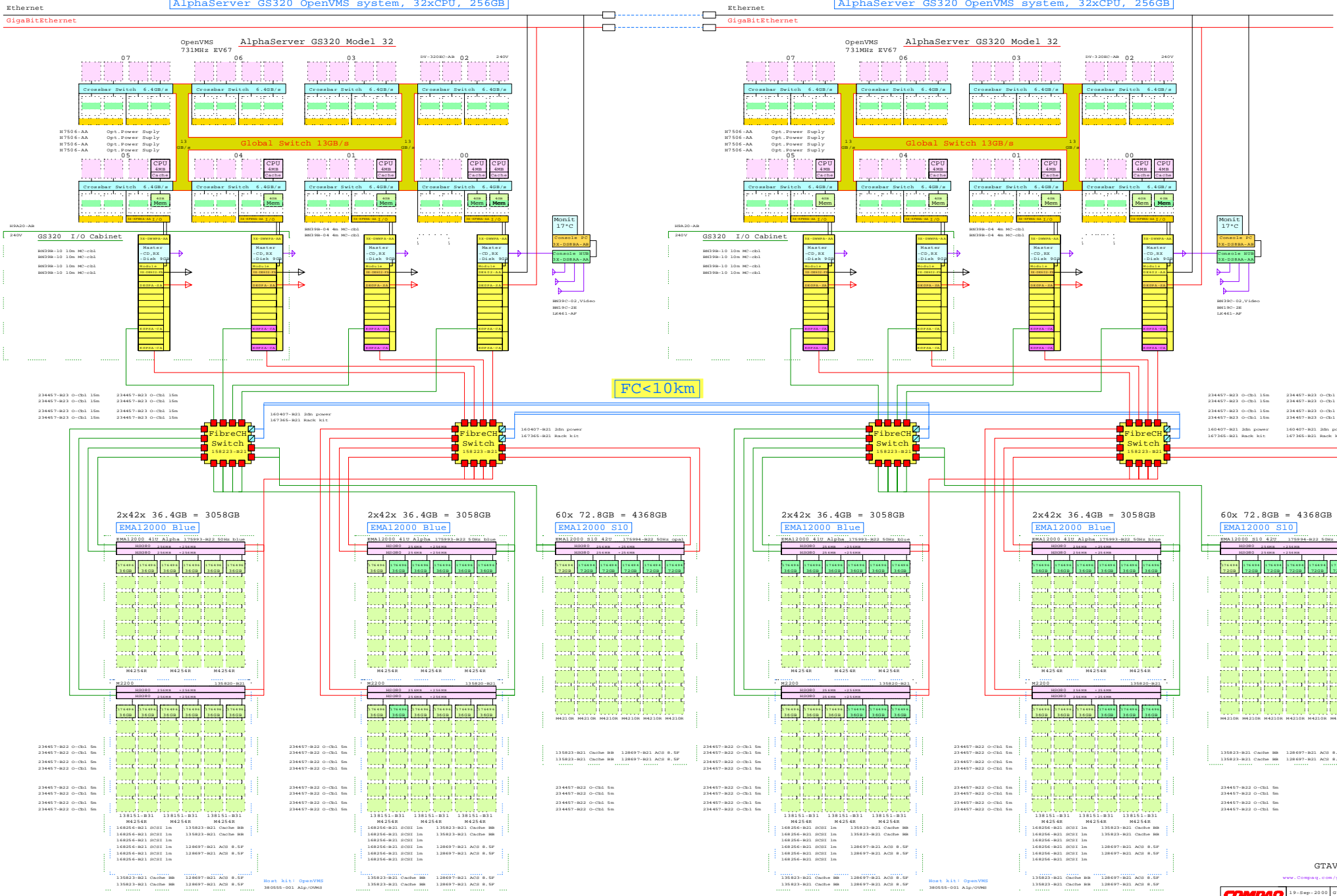

FC<10km

GTAVG3205

www.compaq.com/golden-eggs  
 19-Sep-2000  
 Matt.L.Patall@compaq.com

Remote FC GS320 OpenVMS Clust.  
 GOLDEN EGGS Visuals, Helsinki

This template is included in the present GOLDEN EGGS Software kit.

GS320 OVMS

Packaged cabinets:

Add ins: Disks & Controllers

MA6000

- NO cabinet
- For 1.0" disks

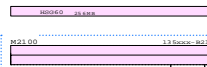

Two (2) channel  
logical  
controller tray,  
-NO cabinet  
-NO controller

M2100

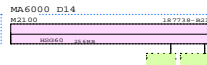

Two (2) channel  
logical  
controller tray,  
-NO cabinet  
-ONE controller  
-ONE disk tray

MA6000 D14

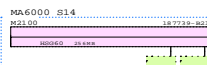

Two (2) channel  
logical  
controller tray,  
-NO cabinet  
-NO controller  
-TWO disk trays

MA6000 S14

EMA12000 D14

- Cabinet 42U
- NO controllers
- For 1.0" disks
- Max 126 disks

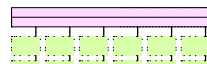
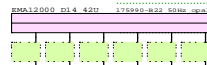

EMA12000 S14

- Cabinet 36U
- NO controllers
- For 1.0" disks
- Max 84 disks

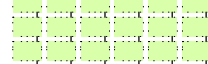

EMA12000 S10

- Cabinet 42U
- NO controllers
- For 1.6" disks
- Max 126 disks

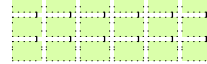
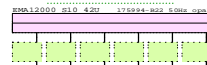

EMA12000 Blue

- Cabinet 41U
- NO controllers
- For 1.0" disks
- Max 84 disks

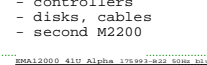

MA8000

- Cabinet 22U
- NO controllers
- For 1.0" disks
- Max 42 disks

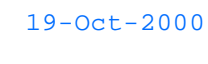
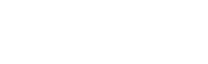

Tray\_Controller

- NO controllers



Six (6) channel  
logical  
controller tray,  
-NO cabinet

M2200

- M2200 tray with controllers
- disk trays
- disks....

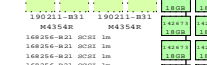

Tray\_Storage

- NO disks

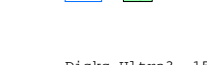
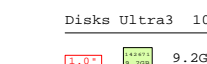
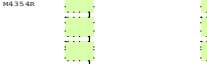

Modula

19-Oct-2000

EMA12000 Blue and

- controllers
- disks, cables
- second M2200

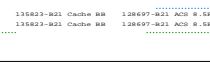
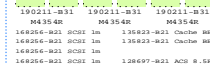

BOM for this EMA12000 Blue + M2200

Part Number	Qty	Description
175993-B22	1	EMA12000 6x7 41U 50Hz blue
1.1	2	ACS V8.5F controller FCAL/PCSW
1.2	1	Modula M2200 shelf, NO controller
1.2.1	2	ACS V8.5F controller FCAL/PCSW
1.2.2	2	HS8xx Single external cache battery
1.2.3	6	SCSI cable VHDCI-VHDCI, 1m
1.2.4	1	HS880 FC Contr with 256MB cache
1.2.4.1	1	Cache Upg RASK ESA12K 256MB
1.2.5	1	HS880 FC Contr with 256MB cache
1.2.5.1	1	Cache Upg RASK ESA12K 256MB
1.2.6	1	Modula M4354R dual buss, 7+7, 1.0"
1.2.6.1	8	18.2GB 10000r Ultra3 SCSI disk 1"
1.2.7	1	Modula M4354R dual buss, 7+7, 1.0"
1.2.7.1	8	18.2GB 10000r Ultra3 SCSI disk 1"
1.2.8	1	Modula M4354R dual buss, 7+7, 1.0"
1.2.8.1	9	18.2GB 10000r Ultra3 SCSI disk 1"
1.3	1	HS8xx Single external cache battery
1.4	28	18.2GB 10000r Ultra3 SCSI disk 1"
1.5	1	HS880 FC Contr with 256MB cache
1.5.1	1	Cache Upg RASK ESA12K 256MB
1.6	1	HS880 FC Contr with 256MB cache
1.6.1	1	Cache Upg RASK ESA12K 256MB

BOM for M2200, controllers and disks

Part Number	Qty	Description
1	1	Modula M2200 shelf, NO controller
1.1	2	ACS V8.5F controller FCAL/PCSW
1.2	6	SCSI cable VHDCI-VHDCI, 1m
1.3	1	HS880 FC Contr with 256MB cache
1.3.1	1	Cache Upg RASK ESA12K 256MB
1.4	1	HS880 FC Contr with 256MB cache
1.4.1	1	Cache Upg RASK ESA12K 256MB
1.5	1	Modula M4314R single buss, 14x 1.0"
1.5.1	10	18.2GB 10000r Ultra3 SCSI disk 1"
1.6	1	Modula M4314R single buss, 14x 1.0"
1.6.1	12	18.2GB 10000r Ultra3 SCSI disk 1"
1.7	1	Modula M4354R dual buss, 7+7, 1.0"
1.7.1	7	18.2GB 10000r Ultra3 SCSI disk 1"
1.8	1	Modula M4354R dual buss, 7+7, 1.0"
1.8.1	9	18.2GB 10000r Ultra3 SCSI disk 1"
2	1	HS8xx Single external cache battery
3	2	Modula M4214R 2nd power supply

Disks Ultra3 10k rpm

- 1.0" 9.2GB
- 1.0" 18.2GB
- 1.0" 36.4GB
- 1.0" 72.8GB

Disks Ultra3 15k rpm

- 1.0" 9.2GB
- 1.0" 18.2GB

Modula

# Enterprise Modular Array EMA12000 D14

Ethernet

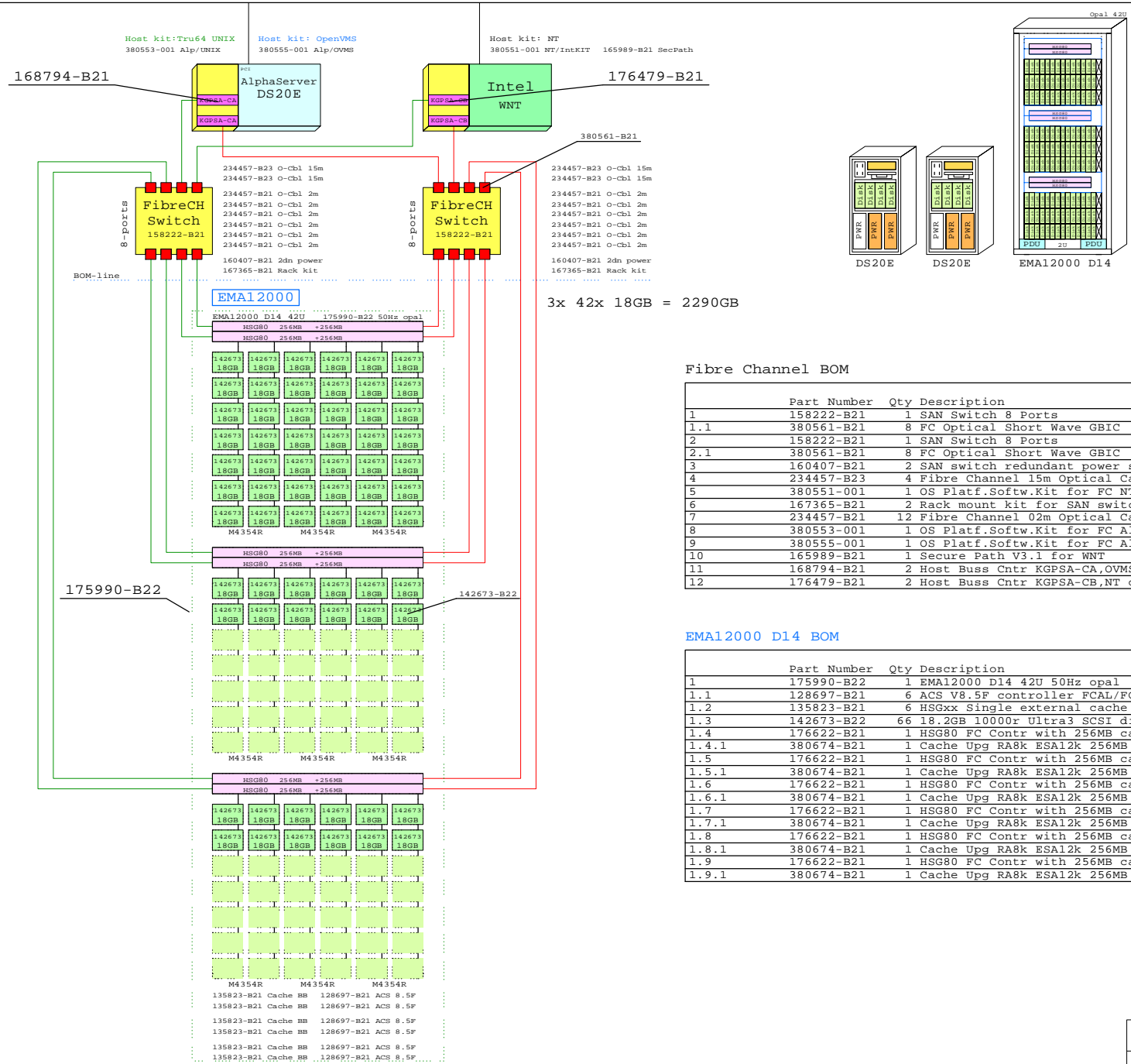

3x 42x 18GB = 2290GB

### Fibre Channel BOM

Part Number	Qty	Description
158222-B21	1	SAN Switch 8 Ports
1.1	380561-B21	8 FC Optical Short Wave GBIC
2	158222-B21	1 SAN Switch 8 Ports
2.1	380561-B21	8 FC Optical Short Wave GBIC
3	160407-B21	2 SAN switch redundant power supply
4	234457-B23	4 Fibre Channel 15m Optical Cable
5	380551-001	1 OS Platf.Softw.Kit for FC NT/Intel
6	167365-B21	2 Rack mount kit for SAN switch
7	234457-B21	12 Fibre Channel 02m Optical Cable
8	380553-001	1 OS Platf.Softw.Kit for FC Alpha UNIX
9	380555-001	1 OS Platf.Softw.Kit for FC Alpha OVMS
10	165989-B21	1 Secure Path V3.1 for WNT
11	168794-B21	2 Host Buss Cntr KGPSA-CA,OVMS,UNIX
12	176479-B21	2 Host Buss Cntr KGPSA-CB,NT only

### EMA12000 D14 BOM

Part Number	Qty	Description
1	175990-B22	1 EMA12000 D14 42U 50Hz opal
1.1	128697-B21	6 ACS V8.5F controller FCAL/FCSW
1.2	135823-B21	6 HSGxx Single external cache battery
1.3	142673-B22	66 18.2GB 10000r Ultra3 SCSI disk 1"
1.4	176622-B21	1 HSG80 FC Contr with 256MB cache
1.4.1	380674-B21	1 Cache Upg RA8k ESA12k 256MB
1.5	176622-B21	1 HSG80 FC Contr with 256MB cache
1.5.1	380674-B21	1 Cache Upg RA8k ESA12k 256MB
1.6	176622-B21	1 HSG80 FC Contr with 256MB cache
1.6.1	380674-B21	1 Cache Upg RA8k ESA12k 256MB
1.7	176622-B21	1 HSG80 FC Contr with 256MB cache
1.7.1	380674-B21	1 Cache Upg RA8k ESA12k 256MB
1.8	176622-B21	1 HSG80 FC Contr with 256MB cache
1.8.1	380674-B21	1 Cache Upg RA8k ESA12k 256MB
1.9	176622-B21	1 HSG80 FC Contr with 256MB cache
1.9.1	380674-B21	1 Cache Upg RA8k ESA12k 256MB

www.Compaq.com/golden-eggs

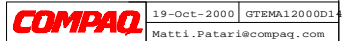

Enterprise Modular Array 12000  
GOLDEN EGGS Visuals, Helsinki

EMA12000 D14

This template is included in the present GOLDEN EGGS Software kit.







# Enterprise Modular Array EMA12000 Blue

Ethernet

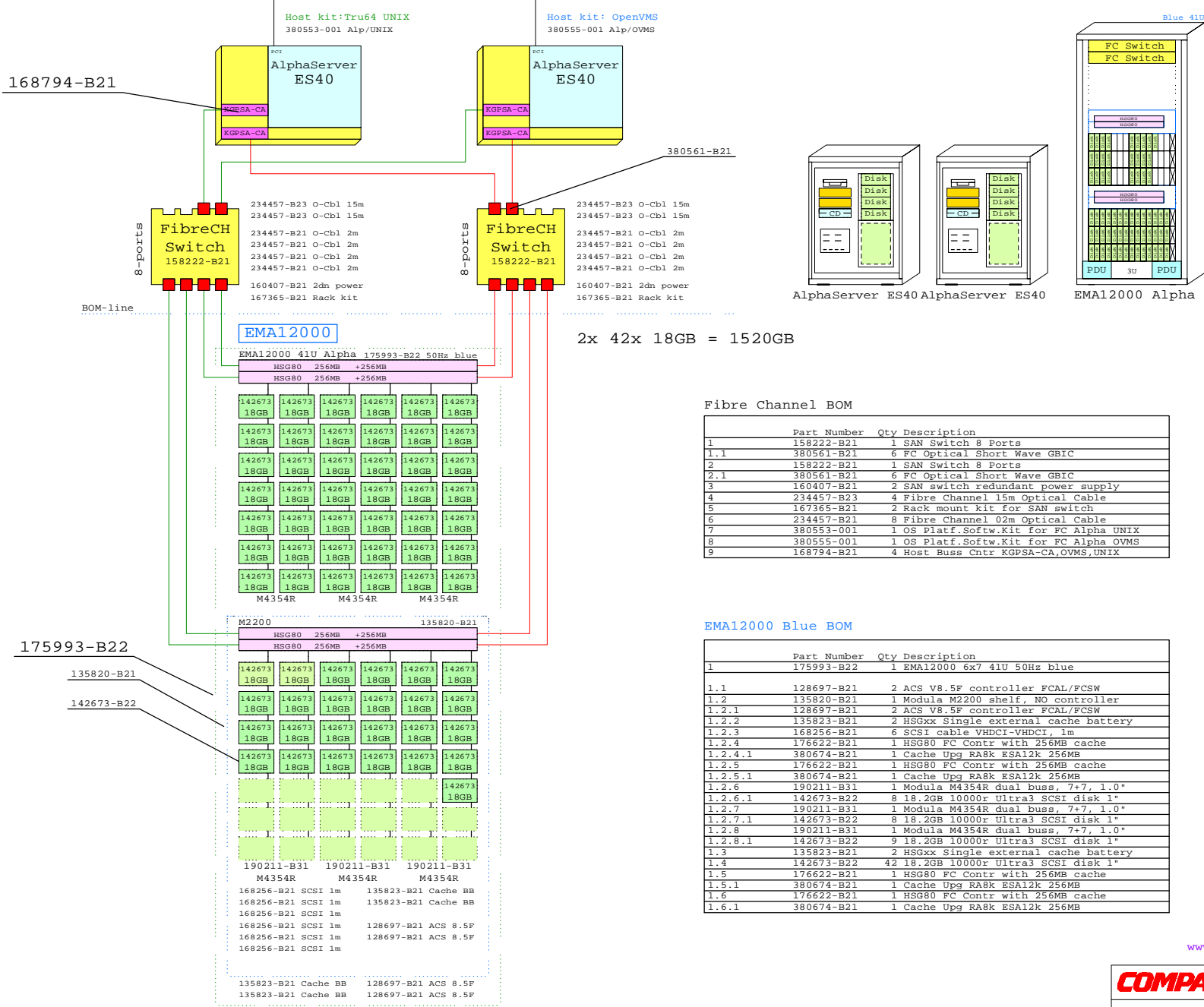

2x 42x 18GB = 1520GB

### Fibre Channel BOM

Part Number	Qty	Description
1	15822-B21	1 SAN Switch 8 Ports
1.1	380561-B21	6 FC Optical Short Wave GBIC
2	15822-B21	1 SAN Switch 8 Ports
2.1	380561-B21	6 FC Optical Short Wave GBIC
3	160407-B21	2 SAN switch redundant power supply
4	234457-B23	4 Fibre Channel 15m Optical Cable
5	167365-B21	2 Rack mount kit for SAN switch
6	234457-B21	8 Fibre Channel 02m Optical Cable
7	380553-001	1 OS Platf.Softw.Kit for FC Alpha UNIX
8	380555-001	1 OS Platf.Softw.Kit for FC Alpha OVMS
9	168794-B21	4 Host Buss Cntr KGPSA-CA,OVMS,UNIX

### EMA12000 Blue BOM

Part Number	Qty	Description
1	175993-B22	1 EMA12000 6x7 41U 50Hz blue
1.1	128697-B21	2 ACS V8.5F controller FCAL/FCSW
1.2	135820-B21	1 Modula M2200 shelf, NO controller
1.2.1	128697-B21	2 ACS V8.5F controller FCAL/FCSW
1.2.2	135823-B21	2 HSGxx Single external cache battery
1.2.3	168256-B21	6 SCSI cable VHDCI-VHDCI, 1m
1.2.4	176622-B21	1 HSG80 FC Contr with 256MB cache
1.2.4.1	380674-B21	1 Cache Upg RA8K ESA12k 256MB
1.2.5	176622-B21	1 HSG80 FC Contr with 256MB cache
1.2.5.1	380674-B21	1 Cache Upg RA8K ESA12k 256MB
1.2.6	190211-B31	1 Modula M4354R dual buss, 7+7, 1.0"
1.2.6.1	142673-B22	8 18.2GB 10000r Ultra3 SCSI disk 1"
1.2.7	190211-B31	1 Modula M4354R dual buss, 7+7, 1.0"
1.2.7.1	142673-B22	8 18.2GB 10000r Ultra3 SCSI disk 1"
1.2.8	190211-B31	1 Modula M4354R dual buss, 7+7, 1.0"
1.2.8.1	142673-B22	9 18.2GB 10000r Ultra3 SCSI disk 1"
1.3	135823-B21	2 HSGxx Single external cache battery
1.4	142673-B22	42 18.2GB 10000r Ultra3 SCSI disk 1"
1.5	176622-B21	1 HSG80 FC Contr with 256MB cache
1.5.1	380674-B21	1 Cache Upg RA8K ESA12k 256MB
1.6	176622-B21	1 HSG80 FC Contr with 256MB cache
1.6.1	380674-B21	1 Cache Upg RA8K ESA12k 256MB

www.Compaq.com/golden-eggs  
Since Jul-2000

**COMPAQ** 19-Oct-2000 GTEMA12000bl  
Matti.Patari@compaq.com

This template is included in the present GOLDEN EGGS Software kit.

EMA12000 Blue

Enterprise Modular Array 12000  
GOLDEN EGGS Visuals, Helsinki

# Enterprise Modular Array EMA12000 CI

1.6" drives

1.0" drives

Ethernet

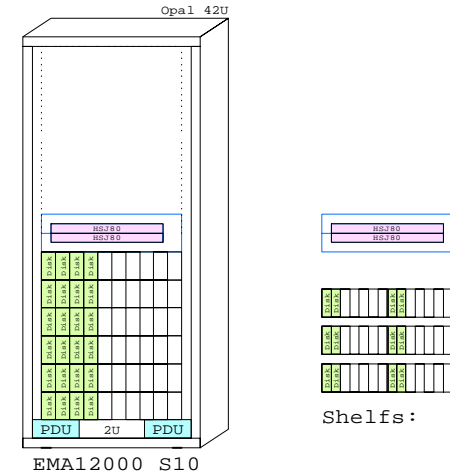
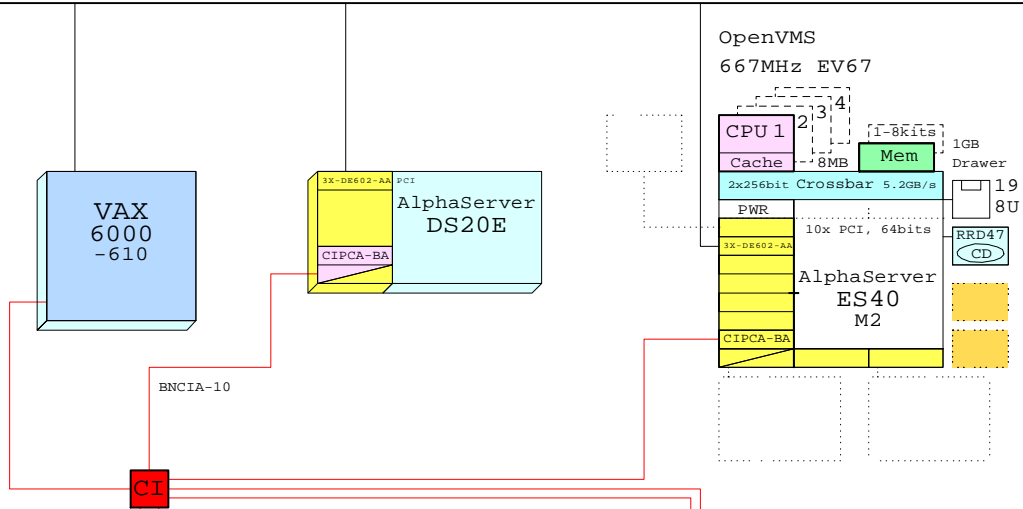

203694-B21 OpenVMS

BOM-line

1.6" drives

1.0" drives

EMA12000

60x 72.8GB = 4368GB

Shelves:M2200+ 3xM4354R

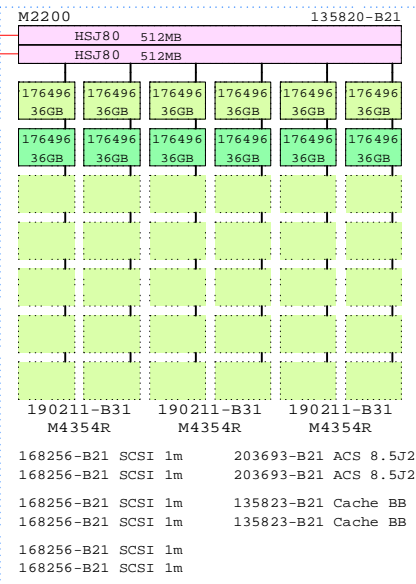
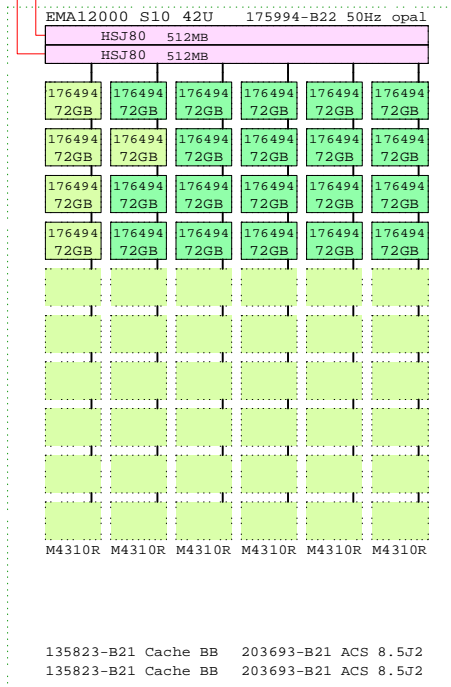

## BOM for EMA12000

	Part Number	Qty	Description
1	175994-B22	1	EMA12000 S10 42U 50Hz opal
1.1	135823-B21	2	HSGxx Single external cache battery
1.2	176494-B21	24	72GB 10000r Ultra3 SCSI disk 1.6"
1.3	203693-B21	2	ACS V8.5J-2 controller CI software
1.4	204305-B21	2	HSJ80 CI Contr 512MB cache
2	203694-B21	1	OS Platf.Softw.Kit for HSJ80 OpenVMS

## BOM for Shelves

	Part Number	Qty	Description
1	135820-B21	1	Modula M2200 shelf, NO controller
1.1	135823-B21	2	HSGxx Single external cache battery
1.2	168256-B21	6	SCSI cable VHDCI-VHDCI, 1m
1.3	190211-B31	1	Modula M4354R dual buss, 7+7, 1.0"
1.3.1	176496-B22	4	36GB 10000r Ultra3 SCSI disk 1"
1.4	190211-B31	1	Modula M4354R dual buss, 7+7, 1.0"
1.4.1	176496-B22	4	36GB 10000r Ultra3 SCSI disk 1"
1.5	190211-B31	1	Modula M4354R dual buss, 7+7, 1.0"
1.5.1	176496-B22	4	36GB 10000r Ultra3 SCSI disk 1"
1.6	203693-B21	2	ACS V8.5J-2 controller CI software
1.7	204305-B21	2	HSJ80 CI Contr 512MB cache
2	203694-B21	1	OS Platf.Softw.Kit for HSJ80 OpenVMS

[www.Compaq.com/golden-eggs](http://www.Compaq.com/golden-eggs)

Since: Oct-2000

<b>COMPAQ</b>	20-Oct-2000	GTEMA12000CI
	Matti.Patari@compaq.com	

EMA12000 for CI  
GOLDEN EGGS Visuals, Helsinki

# Modular Array MA8000

Ethernet

Host kit: Tru64 UNIX  
380553-001 Alp/UNIX

Host kit: OpenVMS  
380555-001 Alp/OVMS

Host kit: NT  
380551-001 NT/IntKIT 165989-B21 SecPath

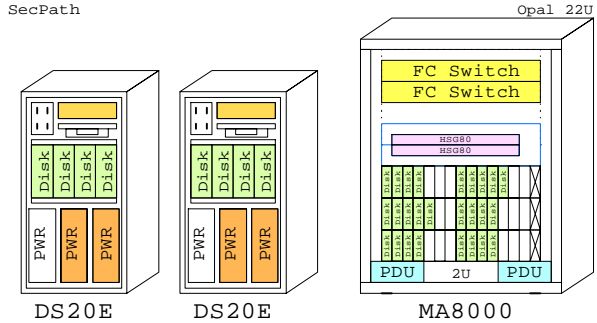
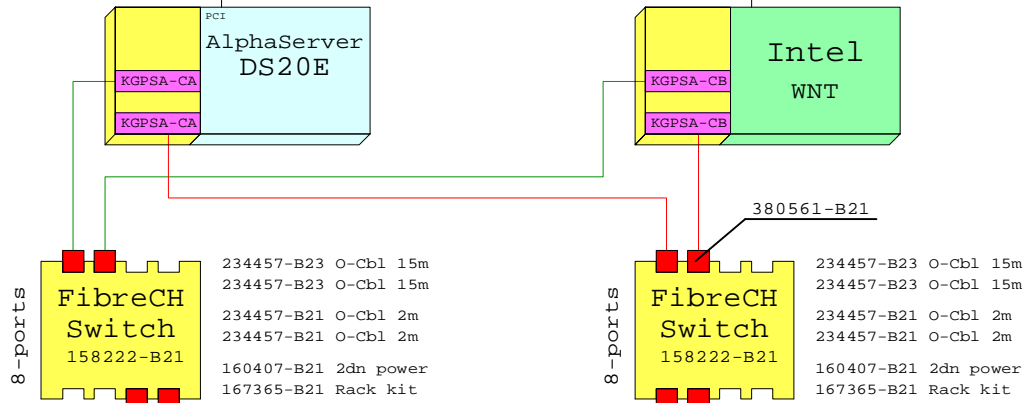

BOM-line

**MA8000** 42x 18GB = 760GB

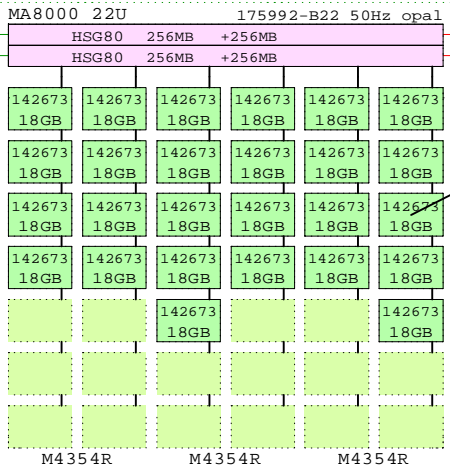

135823-B21 Cache BB 128697-B21 ACS 8.5F  
135823-B21 Cache BB 128697-B21 ACS 8.5F

## Fibre Channel BOM

	Part Number	Qty	Description
1	158222-B21	1	SAN Switch 8 Ports
1.1	380561-B21	4	FC Optical Short Wave GBIC
2	158222-B21	1	SAN Switch 8 Ports
2.1	380561-B21	4	FC Optical Short Wave GBIC
3	160407-B21	2	SAN switch redundant power supply
4	234457-B23	4	Fibre Channel 15m Optical Cable
5	380551-001	1	OS Platf.Softw.Kit for FC NT/Intel
6	167365-B21	2	Rack mount kit for SAN switch
7	234457-B21	4	Fibre Channel 02m Optical Cable
8	380553-001	1	OS Platf.Softw.Kit for FC Alpha UNIX
9	380555-001	1	OS Platf.Softw.Kit for FC Alpha OVMS
10	168794-B21	2	Host Buss Cntr KGPSA-CA,OVMS,UNIX
11	176479-B21	2	Host Buss Cntr KGPSA-CB,NT only

## MA8000 BOM

	Part Number	Qty	Description
1	175992-B22	1	MA8000 6x7 22U 50Hz opal
1.1	128697-B21	2	ACS V8.5F controller FCAL/FCSW
1.2	135823-B21	2	HSGxx Single external cache battery
1.3	142673-B22	26	18.2GB 10000r Ultra3 SCSI disk
1.4	176622-B21	1	HSG80 FC Contr with 256MB cache
1.4.1	380674-B21	1	Cache Upg RA8k ESA12k 256MB
1.5	176622-B21	1	HSG80 FC Contr with 256MB cache
1.5.1	380674-B21	1	Cache Upg RA8k ESA12k 256MB

[www.Compaq.com/golden-eggs](http://www.Compaq.com/golden-eggs)

Since:Jul-2000



19-Oct-2000 GTMA8000a  
Matti.Patari@compaq.com

Modular Array, MA8000  
GOLDEN EGGS Visuals, Helsinki

This template is included in the present GOLDEN EGGS Software kit.

**MA8000**

# Modular Array MA6000 D14

Ethernet

Host kit: Tru64 UNIX  
192211-B21 Tru64

Host kit: OpenVMS  
192217-B21 OpenVMS

Host kit: NT  
192214-B21 NT/IntKIT 165989-B21 SecPath

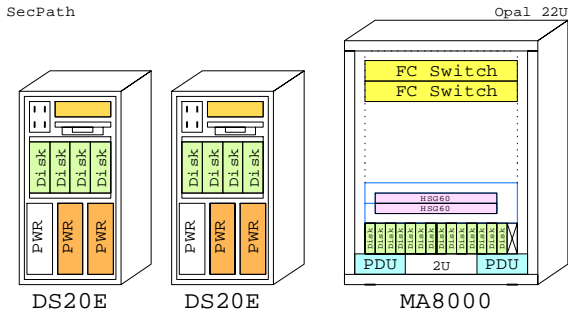
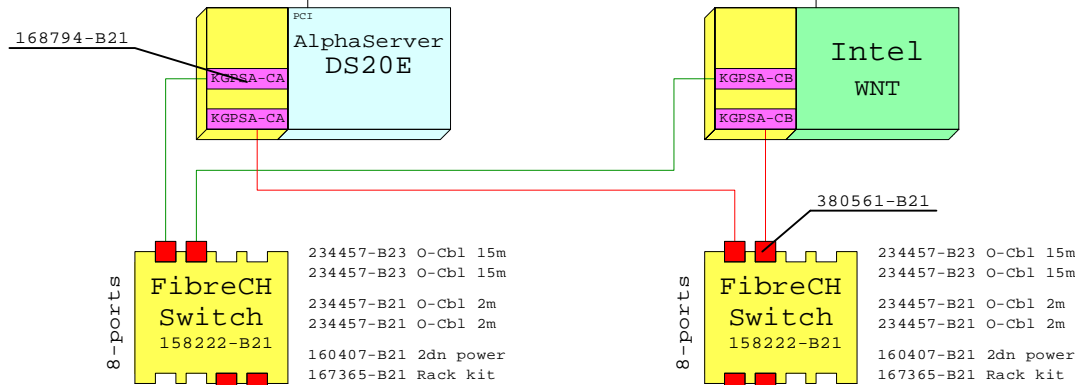

BOM-line

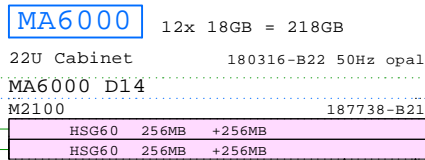

180316-B22

187738-B21

## Fibre Channel BOM

Part Number	Qty	Description
158222-B21	1	SAN Switch 8 Ports
1.1 380561-B21	4	FC Optical Short Wave GBIC
2 158222-B21	1	SAN Switch 8 Ports
2.1 380561-B21	4	FC Optical Short Wave GBIC
3 160407-B21	2	SAN switch redundant power supply
4 192214-B21	1	OS Platf.Softw.Kit for HSG60 NT/Intel
5 234457-B23	4	Fibre Channel 15m Optical Cable
6 167365-B21	2	Rack mount kit for SAN switch
7 234457-B21	4	Fibre Channel 02m Optical Cable
8 192217-B21	1	OS Platf.Softw.Kit for HSG60 OpenVMS
9 192211-B21	1	OS Platf.Softw.Kit for HSG60 Tru64 UNIX
10 168794-B21	2	Host Buss Cntr KGPSA-CA,OVMS,UNIX
11 176479-B21	2	Host Buss Cntr KGPSA-CB,NT only

## MA6000 D14 BOM

Part Number	Qty	Description
1 180316-B22	1	Empty 22U Modula cabinet 50Hz opal
1.1 187738-B21	1	MA6000 D14 1xHSG60 256MB
1.1.1 135823-B21	1	HSGxx Single external cache battery
1.1.2 142673-B22	14	18.2GB 10000r Ultra3 SCSI disk
1.1.3 174134-B21	1	HSG60 FC Contr with 256MB cache
1.1.3.1 380674-B21	1	Cache Upg RA8k ESA12k 256MB
1.1.4 180319-B21	2	ACS V8.5L FC-fab,FC-loop, HSG60
1.1.5 380674-B21	1	Cache Upg RA8k ESA12k 256MB

[www.Compaq.com/golden-eggs](http://www.Compaq.com/golden-eggs)

<b>COMPAQ</b>	07-Sep-2000	GTMA6000a
	Matti.Patari@compaq.com	

Modular Array, MA6000 S14  
GOLDEN EGGS Visuals, Helsinki

This template is included in the present GOLDEN EGGS Software kit.

**MA6000 D14**



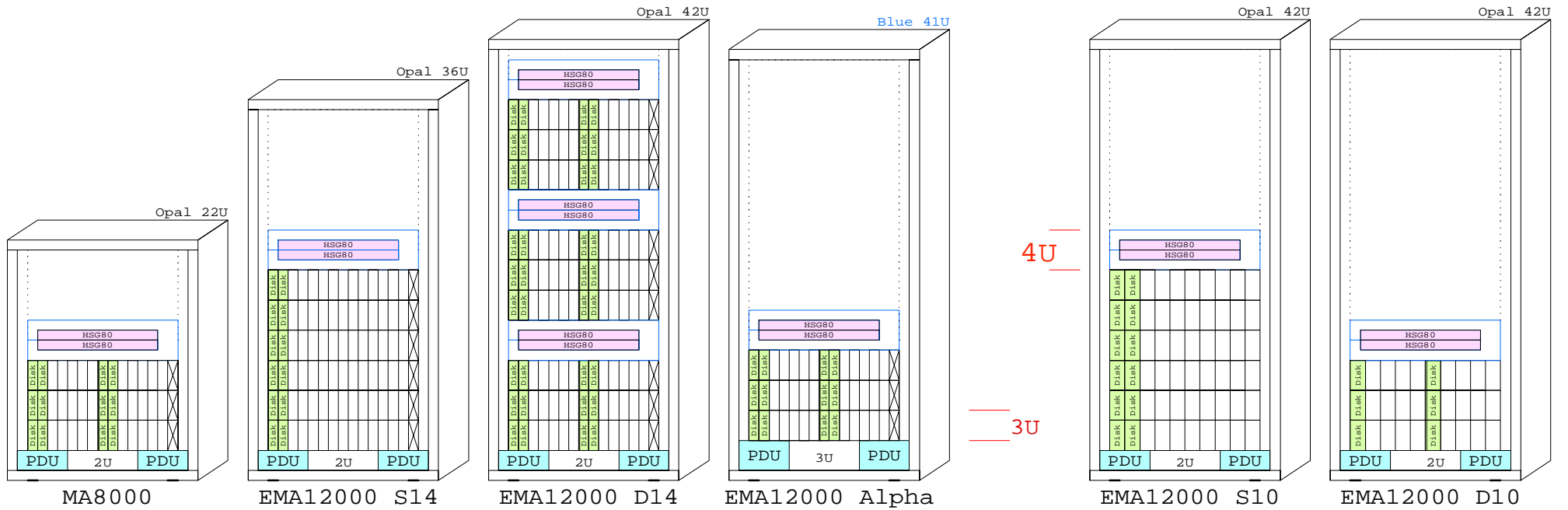

**COMPAQ**

29-Jun-2000 Modula-Cabs

Matti.Patari@compaq.com

Modula Cabinets  
GOLDEN EGGS Visuals, Helsinki

# Enterprise Modular Array EMA16000 D14

Ethernet

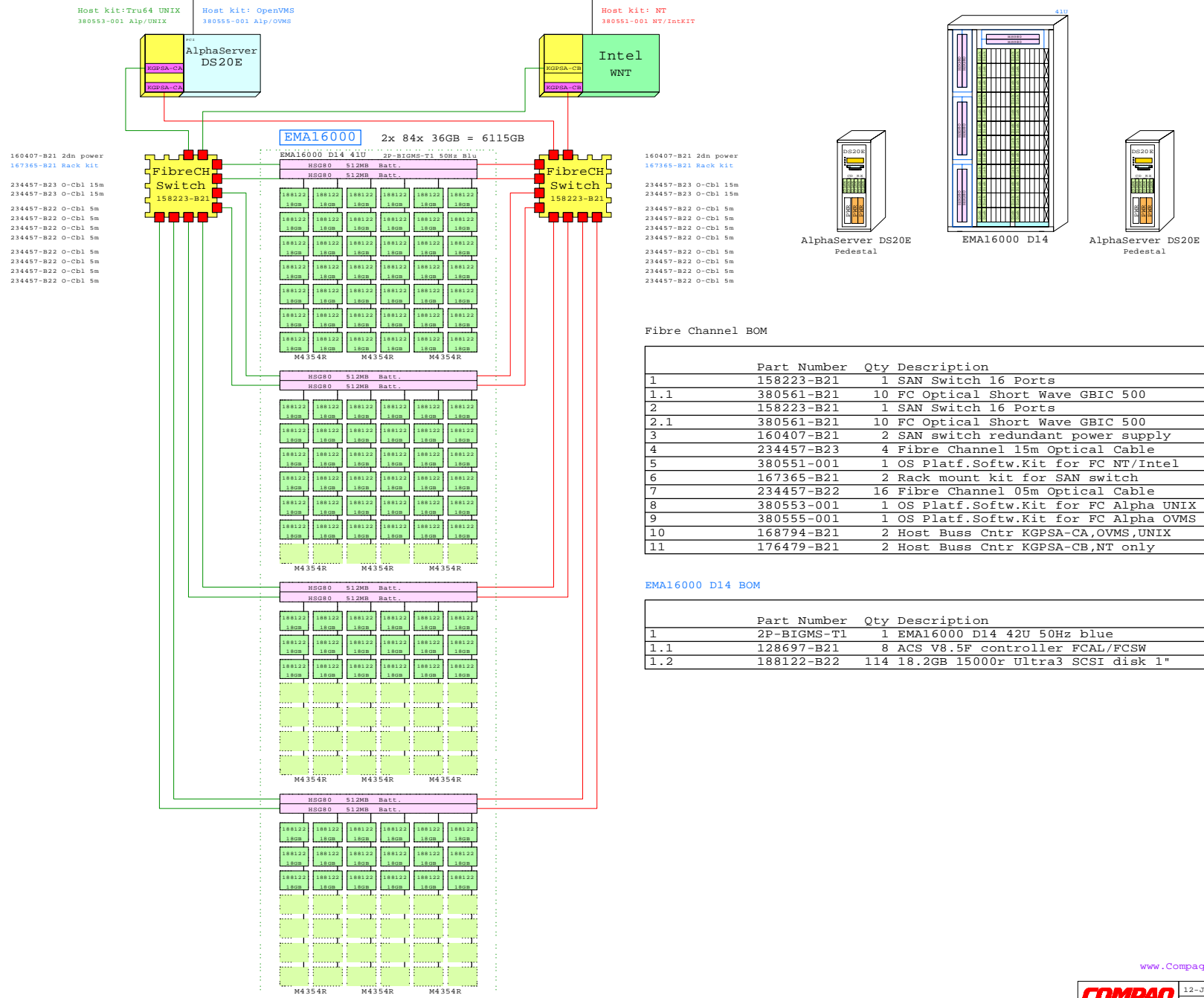

160407-B21 2dn power  
167365-B21 Rack Kit  
234457-B23 O-Cbl 15m  
234457-B23 O-Cbl 15m  
234457-B22 O-Cbl 5m  
234457-B22 O-Cbl 5m  
234457-B22 O-Cbl 5m  
234457-B22 O-Cbl 5m  
234457-B22 O-Cbl 5m  
234457-B22 O-Cbl 5m  
234457-B22 O-Cbl 5m

160407-B21 2dn power  
167365-B21 Rack Kit  
234457-B23 O-Cbl 15m  
234457-B23 O-Cbl 15m  
234457-B22 O-Cbl 5m  
234457-B22 O-Cbl 5m  
234457-B22 O-Cbl 5m  
234457-B22 O-Cbl 5m  
234457-B22 O-Cbl 5m  
234457-B22 O-Cbl 5m  
234457-B22 O-Cbl 5m

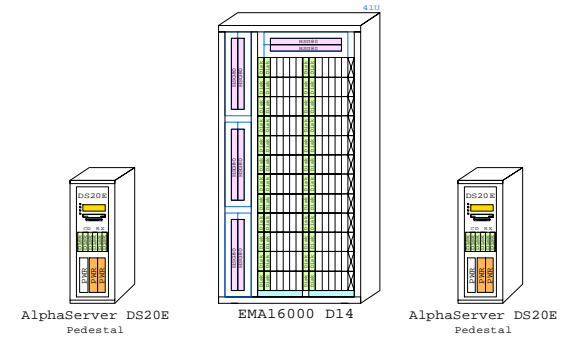

### Fibre Channel BOM

	Part Number	Qty	Description
1	158223-B21	1	SAN Switch 16 Ports
1.1	380561-B21	10	FC Optical Short Wave GBIC 500
2	158223-B21	1	SAN Switch 16 Ports
2.1	380561-B21	10	FC Optical Short Wave GBIC 500
3	160407-B21	2	SAN switch redundant power supply
4	234457-B23	4	Fibre Channel 15m Optical Cable
5	380551-001	1	OS Platf.Softw.Kit for FC NT/Intel
6	167365-B21	2	Rack mount kit for SAN switch
7	234457-B22	16	Fibre Channel 05m Optical Cable
8	380553-001	1	OS Platf.Softw.Kit for FC Alpha UNIX
9	380555-001	1	OS Platf.Softw.Kit for FC Alpha OVMS
10	168794-B21	2	Host Buss Cntr KGPSA-CA,OVMS,UNIX
11	176479-B21	2	Host Buss Cntr KGPSA-CB,NT only

### EMA16000 D14 BOM

	Part Number	Qty	Description
1	2P-BIGMS-T1	1	EMA16000 D14 42U 50Hz blue
1.1	128697-B21	8	ACS V8.5F controller FCAL/FCSW
1.2	188122-B22	114	18.2GB 15000r Ultra3 SCSI disk 1"

128697-B21 ACS 8.5F 128697-B21 ACS 8.5F  
128697-B21 ACS 8.5F 128697-B21 ACS 8.5F  
128697-B21 ACS 8.5F 128697-B21 ACS 8.5F  
128697-B21 ACS 8.5F 128697-B21 ACS 8.5F

[www.Compaq.com/golden-eggs](http://www.Compaq.com/golden-eggs)  
Since Jan 2001

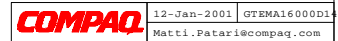

Enterprise Modular Array 16000  
GOLDEN EGGS Visuals, Helsinki

EMA16000 D14

# Enterprise Modular Array EM16000 D14

Ethernet

Host Kit: Tru64 UNIX  
380953-001 ALP/UNIX

Host Kit: OpenVMS  
380955-001 ALP/OVMS

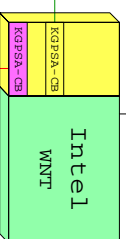
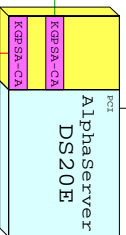

EM16000

2x 84x 36GB = 6115GB

EM16000 D14 4TU 2P-BIGMS-TL 50Hz B1A

HSG80 512MB Batt.

- 160407-B21 24h Power
- 167365-B21 Rack Kit
- 234457-B23 O-Cbl 15m
- 234457-B22 O-Cbl 5m
- 234457-B22 O-Cbl 5m
- 234457-B22 O-Cbl 5m
- 234457-B22 O-Cbl 5m
- 234457-B22 O-Cbl 5m
- 234457-B22 O-Cbl 5m
- 234457-B22 O-Cbl 5m

- 160407-B21 24h Power
- 167365-B21 Rack Kit
- 234457-B23 O-Cbl 15m
- 234457-B22 O-Cbl 5m
- 234457-B22 O-Cbl 5m
- 234457-B22 O-Cbl 5m
- 234457-B22 O-Cbl 5m
- 234457-B22 O-Cbl 5m
- 234457-B22 O-Cbl 5m
- 234457-B22 O-Cbl 5m

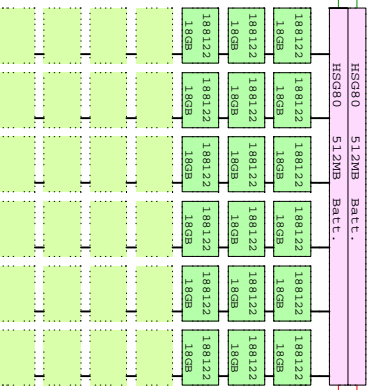
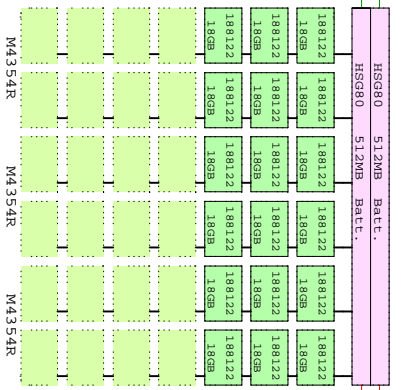
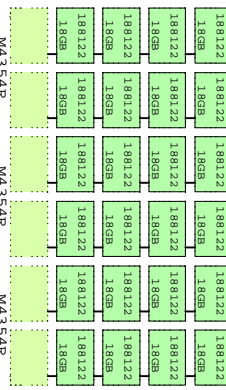
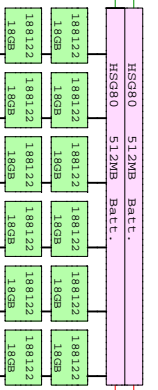
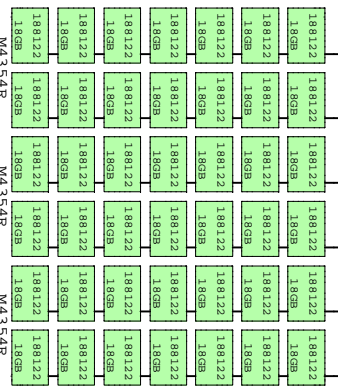
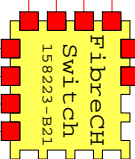
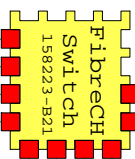

- 128697-B21 ACS 8.5F
- 128697-B21 ACS 8.5F
- 128697-B21 ACS 8.5F
- 128697-B21 ACS 8.5F
- 128697-B21 ACS 8.5F



# Enterprise Modular Array EMA16000 S14

Ethernet

Host kit: Tru64 UNIX  
380553-001 Alp/UNIX

Host kit: OpenVMS  
380555-001 Alp/OVMS

Host kit: NT  
380551-001 NT/tntKIT

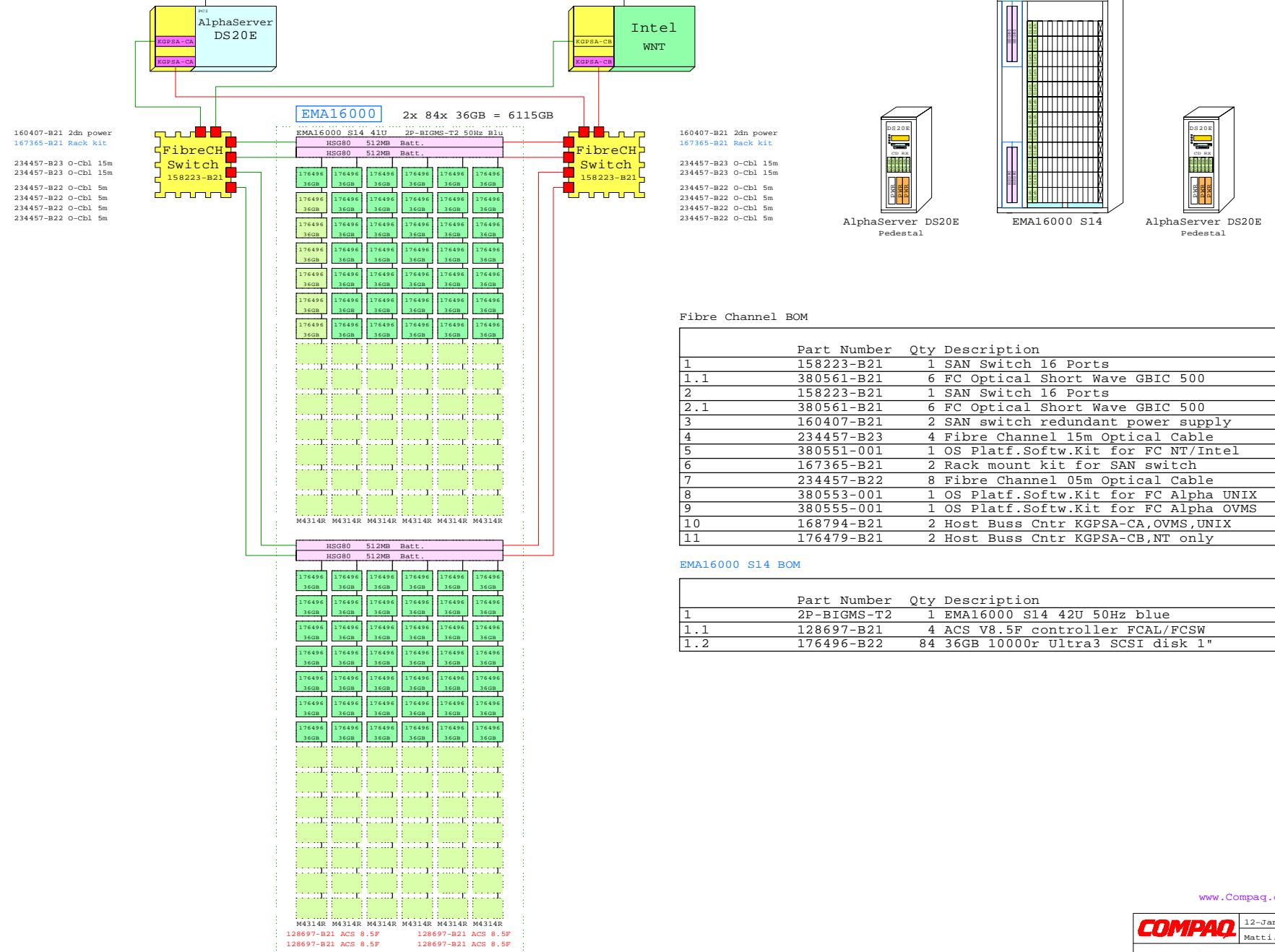

160407-B21 2dn power  
167365-B21 Rack kit  
  
234457-B23 O-Cbl 15m  
234457-B23 O-Cbl 15m  
234457-B22 O-Cbl 5m  
234457-B22 O-Cbl 5m  
234457-B22 O-Cbl 5m  
234457-B22 O-Cbl 5m

160407-B21 2dn power  
167365-B21 Rack kit  
  
234457-B23 O-Cbl 15m  
234457-B23 O-Cbl 15m  
234457-B22 O-Cbl 5m  
234457-B22 O-Cbl 5m  
234457-B22 O-Cbl 5m  
234457-B22 O-Cbl 5m

### Fibre Channel BOM

Part Number	Qty	Description
1	1	158223-B21 SAN Switch 16 Ports
1.1	6	380561-B21 FC Optical Short Wave GBIC 500
2	1	158223-B21 SAN Switch 16 Ports
2.1	6	380561-B21 FC Optical Short Wave GBIC 500
3	2	160407-B21 SAN switch redundant power supply
4	4	234457-B23 Fibre Channel 15m Optical Cable
5	1	380551-001 OS Platf.Softw.Kit for FC NT/Intel
6	2	167365-B21 Rack mount kit for SAN switch
7	8	234457-B22 Fibre Channel 05m Optical Cable
8	1	380553-001 OS Platf.Softw.Kit for FC Alpha UNIX
9	1	380555-001 OS Platf.Softw.Kit for FC Alpha OVMS
10	2	168794-B21 Host Buss Cntr KGPSA-CA,OVMS,UNIX
11	2	176479-B21 Host Buss Cntr KGPSA-CB,NT only

### EMA16000 S14 BOM

Part Number	Qty	Description
1	1	2P-BIGMS-T2 EMA16000 S14 42U 50Hz blue
1.1	4	128697-B21 ACS V8.5F controller FCAL/FCSW
1.2	84	176496-B22 36GB 10000r Ultra3 SCSI disk 1"

This template is included in the present GOLDEN EGGS Software kit.

## EMA16000 S14

[www.Compaq.com/golden-eggs](http://www.Compaq.com/golden-eggs)  
© Since Jan 2001

<b>COMPAQ</b>	12-Jan-2001	GTEMA16000S14
	Matti.Patar@compaq.com	

Enterprise Modular Array 16000  
GOLDEN EGGS Visuals, Helsinki

# Enterprise Modular Array EMA16000 D10

Ethernet

Host kit: Tru64 UNIX  
380553-001 Alp/UNIX

Host kit: OpenVMS  
380555-001 Alp/OVMS

Host kit: NT  
380551-001 NT/IneKIT

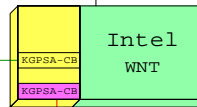
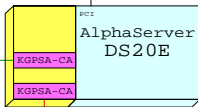

EMA16000 4x 30x 72GB = 8640GB

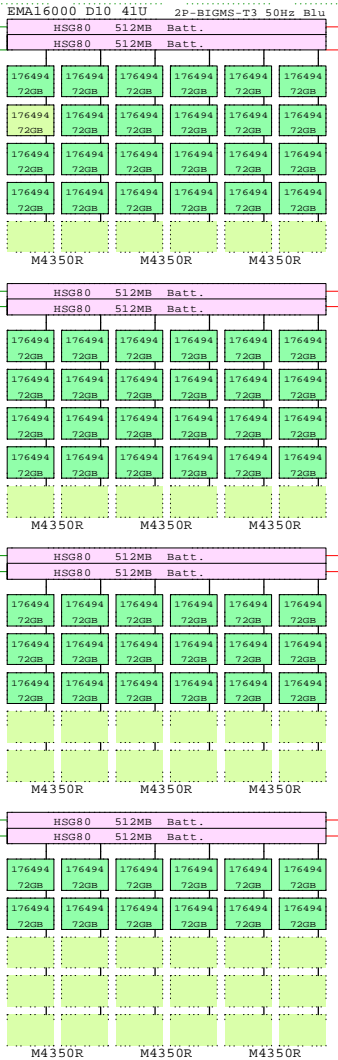
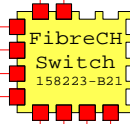
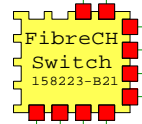

128697-B21 ACS 8.5F 128697-B21 ACS 8.5F  
128697-B21 ACS 8.5F 128697-B21 ACS 8.5F  
128697-B21 ACS 8.5F 128697-B21 ACS 8.5F  
128697-B21 ACS 8.5F 128697-B21 ACS 8.5F

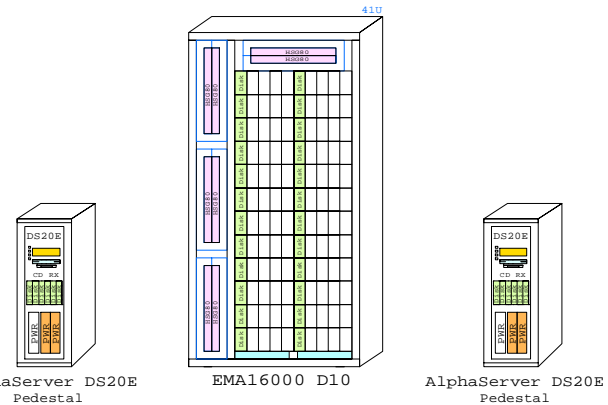

- 160407-B21 2dn power
- 167365-B21 Rack kit
- 234457-B23 O-cbl 15m
- 234457-B23 O-cbl 15m
- 234457-B22 O-cbl 5m
- 234457-B22 O-cbl 5m
- 234457-B22 O-cbl 5m
- 234457-B22 O-cbl 5m
- 234457-B22 O-cbl 5m
- 234457-B22 O-cbl 5m
- 234457-B22 O-cbl 5m
- 234457-B22 O-cbl 5m
- 234457-B22 O-cbl 5m

- 160407-B21 2dn power
- 167365-B21 Rack kit
- 234457-B23 O-cbl 15m
- 234457-B23 O-cbl 15m
- 234457-B22 O-cbl 5m
- 234457-B22 O-cbl 5m
- 234457-B22 O-cbl 5m
- 234457-B22 O-cbl 5m
- 234457-B22 O-cbl 5m
- 234457-B22 O-cbl 5m
- 234457-B22 O-cbl 5m
- 234457-B22 O-cbl 5m
- 234457-B22 O-cbl 5m

### Fibre Channel BOM

	Part Number	Qty	Description
	158223-B21	1	SAN Switch 16 Ports
1	380561-B21	10	FC Optical Short Wave GBIC 500
2	158223-B21	1	SAN Switch 16 Ports
2.1	380561-B21	10	FC Optical Short Wave GBIC 500
3	160407-B21	2	SAN switch redundant power supply
4	234457-B23	4	Fibre Channel 15m Optical Cable
5	380551-001	1	OS Platf.Softw.Kit for FC NT/Intel
6	167365-B21	2	Rack mount kit for SAN switch
7	234457-B22	16	Fibre Channel 05m Optical Cable
8	380553-001	1	OS Platf.Softw.Kit for FC Alpha UNIX
9	380555-001	1	OS Platf.Softw.Kit for FC Alpha OVMS
10	168794-B21	2	Host Buss Cntr KGPSA-CA,OVMS,UNIX
11	176479-B21	2	Host Buss Cntr KGPSA-CB,NT only

### EMA16000 D10 BOM

	Part Number	Qty	Description
1	2P-BIGMS-T3	1	EMA16000 D10 42U 50Hz blue
1.1	128697-B21	8	ACS V8.5F controller FCAL/FCSW
1.2	176494-B21	78	72GB 10000r Ultra3 SCSI disk 1.6"

[www.Compaq.com/golden-eggs](http://www.Compaq.com/golden-eggs)  
Since:Jan 2001

**COMPAQ** 12-Jan-2001 GTEMA16000D10  
Matti.Patari@compaq.com

Enterprise Modular Array 16000  
GOLDEN EGGS Visuals, Helsinki

EMA16000 D10

This template is included in the present GOLDEN EGGS Software kit.

# Enterprise Modular Array EMA16000 S10

Ethernet

Host kit: Tru64 UNIX  
380553-001 Alp/UNIX

Host kit: OpenVMS  
380555-001 Alp/OVMS

Host kit: NT  
380551-001 NT/IntKIT

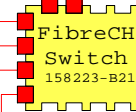
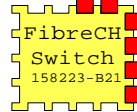
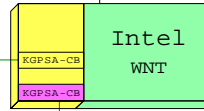
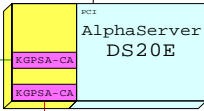

**EMA16000** 2x 60x 72GB = 8640GB

EMA16000 S10 41U 2P-BIGMS-T4 50Hz Blu

HSG80 512MB Batt.  
HSG80 512MB Batt.

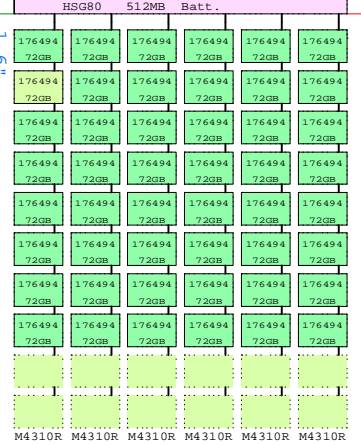

M4310R M4310R M4310R M4310R M4310R M4310R

HSG80 512MB Batt.  
HSG80 512MB Batt.

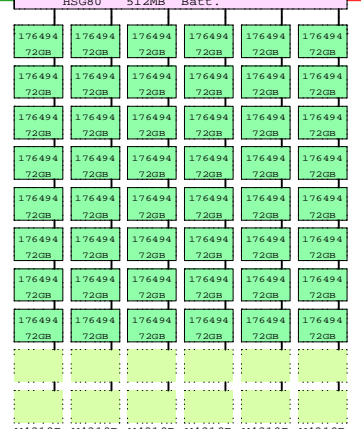

M4310R M4310R M4310R M4310R M4310R M4310R

128697-B21 ACS 8.5F 128697-B21 ACS 8.5F  
128697-B21 ACS 8.5F 128697-B21 ACS 8.5F

160407-B21 2dn power  
167365-B21 Rack kit

234457-B23 O-Cbl 15m  
234457-B23 O-Cbl 15m  
234457-B22 O-Cbl 5m  
234457-B22 O-Cbl 5m  
234457-B22 O-Cbl 5m

160407-B21 2dn power  
167365-B21 Rack kit

234457-B23 O-Cbl 15m  
234457-B23 O-Cbl 15m  
234457-B22 O-Cbl 5m  
234457-B22 O-Cbl 5m  
234457-B22 O-Cbl 5m

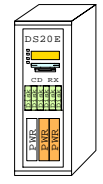

AlphaServer DS20E Pedestal

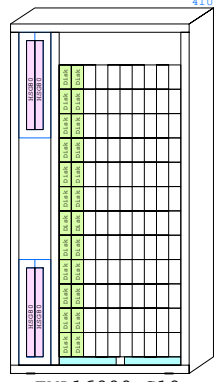

EMA16000 S10

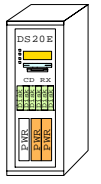

AlphaServer DS20E Pedestal

### Fibre Channel BOM

Part Number	Qty	Description
158223-B21	1	SAN Switch 16 Ports
1.1	380561-B21	6 FC Optical Short Wave GBIC 500
2	158223-B21	1 SAN Switch 16 Ports
2.1	380561-B21	6 FC Optical Short Wave GBIC 500
3	160407-B21	2 SAN switch redundant power supply
4	234457-B23	4 Fibre Channel 15m Optical Cable
5	380551-001	1 OS Platf.Software Kit for FC NT/Intel
6	167365-B21	2 Rack mount kit for SAN switch
7	234457-B22	8 Fibre Channel 05m Optical Cable
8	380553-001	1 OS Platf.Software Kit for FC Alpha UNIX
9	380555-001	1 OS Platf.Software Kit for FC Alpha OVMS
10	168794-B21	2 Host Buss Cntr KGPSA-CA,OVMS,UNIX
11	176479-B21	2 Host Buss Cntr KGPSA-CB,NT only

### EMA16000 S10 BOM

Part Number	Qty	Description
1	2P-BIGMS-T4	1 EMA16000 S10 42U 50Hz blue
1.1	128697-B21	4 ACS V8.5F controller FCAL/FCSW
1.2	176494-B21	96 72GB 10000r Ultra3 SCSI disk 1.6"

[www.Compaq.com/golden-eggs](http://www.Compaq.com/golden-eggs)  
Since Jan 2001

<b>COMPAQ</b>	12-Jan-2001	GTEMA16000S10
	Matti.Patari@compaq.com	

This template is included in the present GOLDEN EGGS Software kit.

## EMA16000 S10

Enterprise Modular Array 16000  
GOLDEN EGGS Visuals, Helsinki

# Key to GOLDEN EGGS

Ethernet

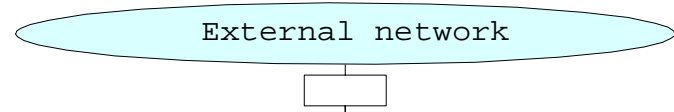

External site

Internal site

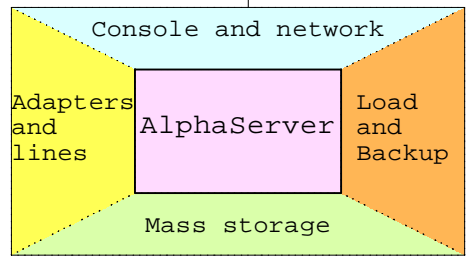
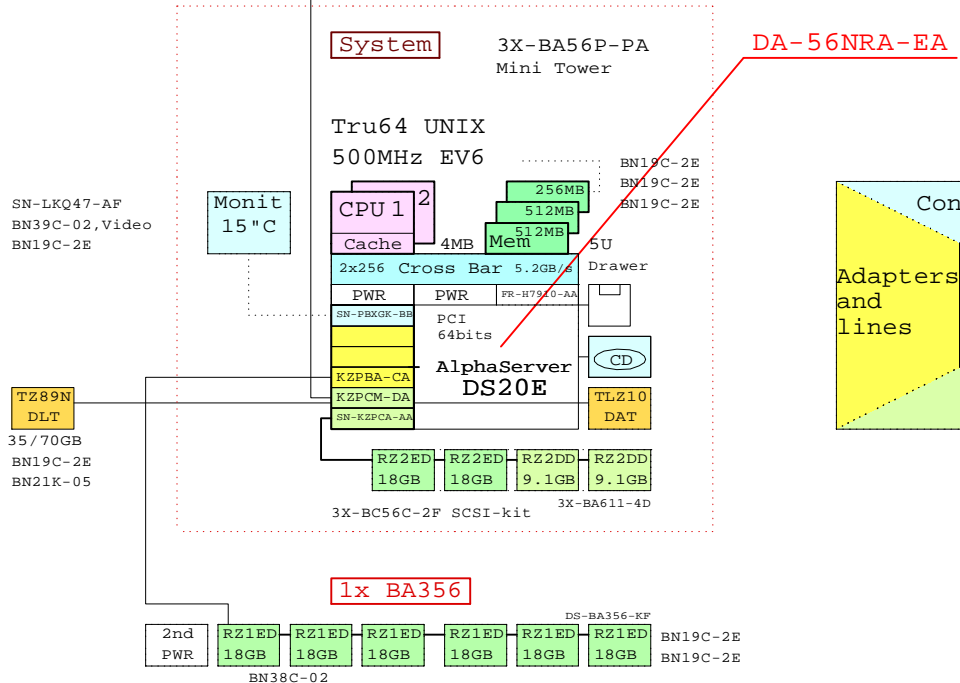

GOLDEN EGGS Segments

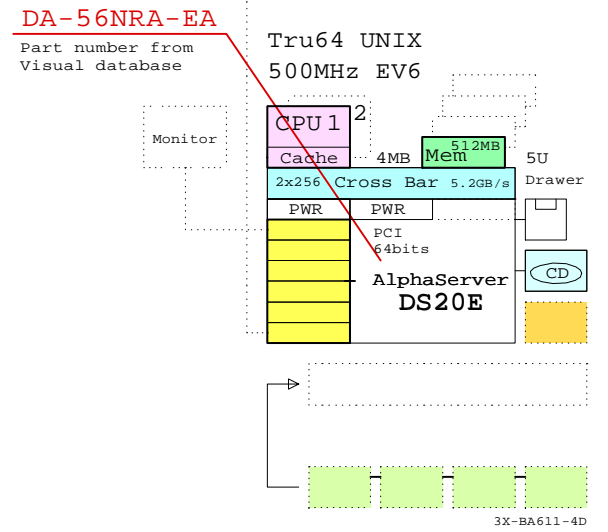

GOLDEN EGGS Presentation

Bill of material, BOM to drawing, to file or Excel

Part Number	Qty	Description
1	1	3X-BA56P-PA 1 DS20E Mini tower pedestal kit
1.1	1	3X-BC56C-2F 1 DS20E SCSI Cable Kit
1.2	3	BN19C-2E 3 PowerCable 240V, C-Europe
1.3	1	DA-56NRA-EA 1 AS DS20E 6/500 512MB,Rack,UNIX
1.3.1	1	3R-VRQV5-24 1 COMPAQ V55 CLR MON,NH,TC095
1.3.2	1	3X-BA611-4D 1 Disk Cage for DS20E, 4x disk
1.3.2.1	2	DS-RZ2DD-16 2 ES40 Disk 9.1GB 10k Ultra2 SCSI
1.3.2.2	2	DS-RZ2ED-16 2 ES40 Disk 18GB 10k Ultra2 SCSI
1.3.3	1	FR-H7910-AA 1 Third power supply for DS20E
1.3.4	1	KN310-BB 1 AS DS20E 6/500 SMP UPG UNIX
1.3.5	1	KZPBA-CA 1 PCI to UltraSCSI Adapter UWSE
1.3.6	1	KZPCM-DA 1 Dual Uscsi with FastEther PCI
1.3.7	1	MS340-CA 1 DS20 256MB SDIMM MEM 4x64MB
1.3.8	1	MS340-DA 1 DS20 512MB SDIMM MEM 4x128MB
1.3.9	1	SN-KZPCA-AA 1 Single channel LVD adapter
1.3.10	1	SN-PBXGK-BB 1 Elsa Gloria Synergy 8M Video Graphics
1.3.11	1	TLZ10-LB 1 12/24GB 4mm DAT 5.25" HH
2	1	DS-BA356-KF 1 Pedestal Storage, UltraW, Single-Bus
2.1	2	BN19C-2E 2 PowerCable 240V, C-Europe
2.2	1	BN38C-02 1 Ultra Cbl VHDCI - 68HD
2.3	1	CK-BA35X-HH 1 180W Stor.Shelf PWR for AS4x00
2.4	6	DS-RZ1ED-VW 6 18.2GB 10000r UltraSCSI disk
3	1	DS-TZ89N-TA 1 35/70GB SE DLT-tape TT FWSE
4	1	BN39C-02 1 1.8 Video Extension Cable ****
5	1	SN-LKQ47-AF 1 102 KEY KYBD, NON-WIN, Finnish
6	2	BN19C-2E 2 PowerCable 240V, C-Europe
7	1	BN21K-05 1 68HD SCSI cable 5m

System kernel

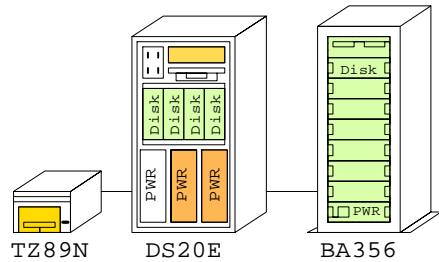

Internet pointer to GE-library

Name of the page  
 - GExxxxx = GOLDEN EGGS page  
 - GTxxxxx = GOLDEN Template  
 Templates are included in GOLDEN EGGS Software kit.

Date of update

[www.Compaq.com/golden-eggs](http://www.Compaq.com/golden-eggs)

Since: Sep-1988

<b>COMPAQ</b>	09-Feb-2001	GEG00B
	Matti.Patari@compaq.com	

**KEY**

To GOLDEN EGGS  
 GOLDEN EGGS Visual Configurations, Helsinki

# GOLDEN EGGS Software

DS10 UNIX System

Shapes for a DS10 UNIX System

Ethernet

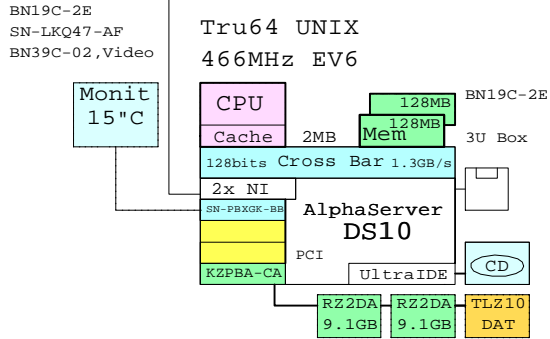

These visuals make this system.

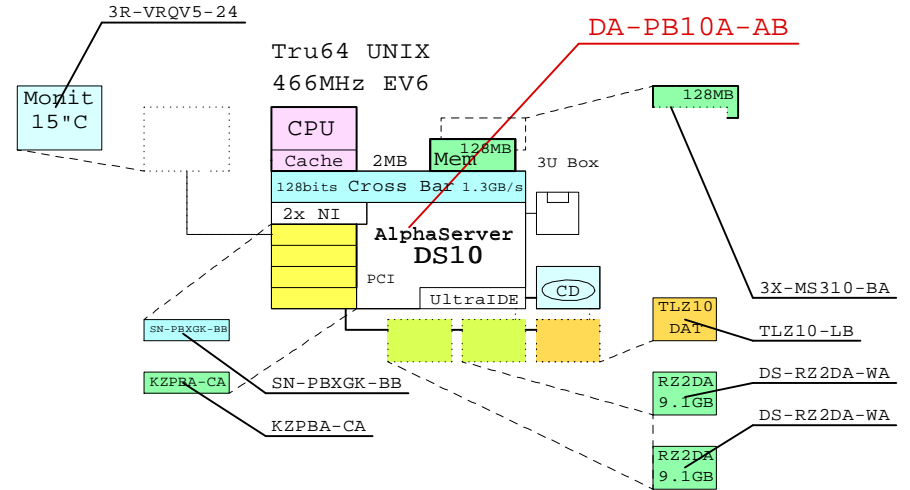

**Bill of Material, no price**

Part Number	Qty	Description
1	1	DA-PB10A-AB 1 AS DS10 6/466 128MB UNIX
1.1	1	3R-VRQV5-24 1 COMPAQ V55 CLR MON,NH,TCO95
1.2	1	3X-MS310-BA 1 DS10 128MB DIMM MEM
1.3	1	BN19C-2E 1 PowerCable 240V, C-Europe
1.4	1	BN39C-02 1 1.8 Video Extension Cable ****
1.5	2	DS-RZ2DA-WA 2 9.1GB 7200RPM UltraSCSI Disk
1.6	1	KZPBA-CA 1 PCI to UltraSCSI Adapter UWSE
1.7	1	SN-PBXGK-BB 1 Elsa Gloria Synergy 8M Video Graphics
1.8	1	TLZ10-LB 1 12/24GB 4mm DAT 5.25" HH
2	1	SN-LKQ47-AF 1 102 KEY KYBD, NON-WIN, Finnish
3	1	BN19C-2E 1 PowerCable 240V, C-Europe

**Bill of Material with local currency, Fimk**

GOLDEN EGGS  
Drawing: p\_GEG00C  
Date: 1999-12-13 10:12:00  
Price file: GEFim071199.Dat

Bill of Material

Part Number	Qty	Description	E/U OEM	Price	Sub.tot
1	1	DA-PB10A-AB 1 AS DS10 6/466 128MB UNIX	X X	34150	34150
1.1	1	3R-VRQV5-24 1 COMPAQ V55 CLR MON,NH,TCO95	N A	2086	2086
1.2	1	3X-MS310-BA 1 DS10 128MB DIMM MEM	X X	4052	4052
1.3	1	BN19C-2E 1 PowerCable 240V, C-Europe	N R	58	58
1.4	1	BN39C-02 1 1.8 Video Extension Cable ****	X X	161	161
1.5	2	DS-RZ2DA-WA 2 9.1GB 7200RPM UltraSCSI Disk	Y M	2800	5600
1.6	1	KZPBA-CA 1 PCI to UltraSCSI Adapter UWSE	Y M	2732	2732
1.7	1	SN-PBXGK-BB 1 Elsa Gloria Synergy 8M Video Graphics	N A	1799	1799
1.8	1	TLZ10-LB 1 12/24GB 4mm DAT 5.25" HH	Y M	8300	8300
2	1	SN-LKQ47-AF 1 102 KEY KYBD, NON-WIN, Finnish	N A	154	154
3	1	BN19C-2E 1 PowerCable 240V, C-Europe	N R	58	58

Grand Total: 59150

Generated with fresh GOLDEN EGGS Software, Rev:09-Feb-2001

System and options have been dragged from GOLDEN EGGS menu.

**GOLDEN EGGS Software:**

- This software runs on a normal office PC or LapTop.
- Tool for Compaq system designer and Sales.
- Rich Compaq product palette for Alpha and StorageWorks.
- Easy to use, just drag and drop.
- One picture talks thousands of words!
- Contains a rich set of ready made system templates.
- Bill of material, BOM, is pulled from the picture.
- Configuration pricing is available in local currency.

**How to get GOLDEN EGGS Software:**

Send your request to:

**Matti.Patari@compaq.comm**

[www.Compaq.com/golden-eggs](http://www.Compaq.com/golden-eggs)  
Since: Sep-1988

<b>COMPAQ</b>	09-Feb-2001	GEG00C
	Matti.Patari@Compaq.com	
GOLDEN EGGS Software, 09-Feb-01		
GOLDEN EGGS Visuals, Helsinki		

**GE-Software**

# GOLDEN EGGS

World Services

Alpha Examples

<http://www.compaq.com/golden-eggs>

# GOLDEN EGGS

World Station

Software kits

<http://www.compaq.com/info/golden-eggs/software>

GOLDEN EGGS in eBusiness since 1988

**COMPAQ**

21-Jun-2000 GE-Internet

Matti.Patari@compaq.com

GOLDEN EGGS Internet Outlets  
GOLDEN EGGS Visuals, Helsinki