











Internal Options:

-  257915-B21
2nd CPU
2800MHz
-  300678-B21
-  300679-B21
-  300680-B21
-  313054-B21
2dn power
-  293048-B21
2nd Fan kit
-  232916-B22
36GB
15k
-  232432-B22
72GB
10k
-  286778-B22
72GB
15k
-  286716-B22
146GB
10k
-  215487-B21
AIT 50G
-  244948-B21
NC7770 Gigabit
PCI-X
-  283551-B21
Smart Array
5304/256
-  245299-B21
FibreChannel HBA
2Gb/s FCA2101

255514-B21 5i BBWC

268290-B21 48VDC power supply,min two

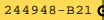
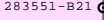
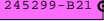
For more detailed configuring, please consult the latest HP QuickSpecs.
Generated with fresh GOLDEN EGGS Software, Rev:25-Nov-2002

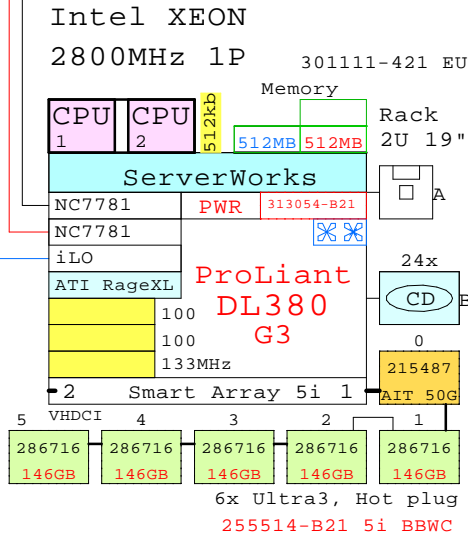

BOM of the 2800MHz-512k 512MB 1P system above

Part Number	Qty	Description
1	301111-421	1 ProLiant DL380 G3 2800MHz 512MB rack 2U
1.1	215487-B21	1 50/100GB Hot plug AIT tape drive
1.2	257915-B21	1 Intel Xeon 2800-512kb processor kit
1.3	286716-B22	5 146.8GB 15000r U320 disk 1"
1.4	293048-B21	1 DL380 G3 hot plug blower kit,3x fans
1.5	300678-B21	1 512MB ECC PC2100 DDR DIMM kit (2x256MB)
1.6	313054-B21	1 DL380 G2/G3 second power supply
2	255514-B21	1 Battery Backed Write Cache Enable kit

Part numbers for 2400MHz-512k 512MB 1P systems

Part Number	Qty	Description
1	257917-421	1 ProLiant DL380 G3 2400MHz 512MB rack 2U
1.1	257913-B21	1 Intel Xeon 2400-512kb processor kit

2800MHz

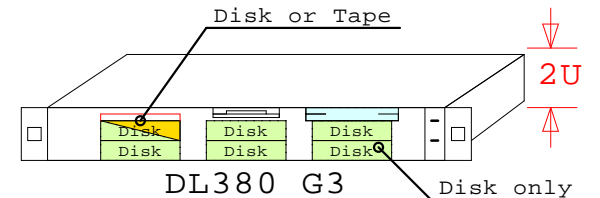
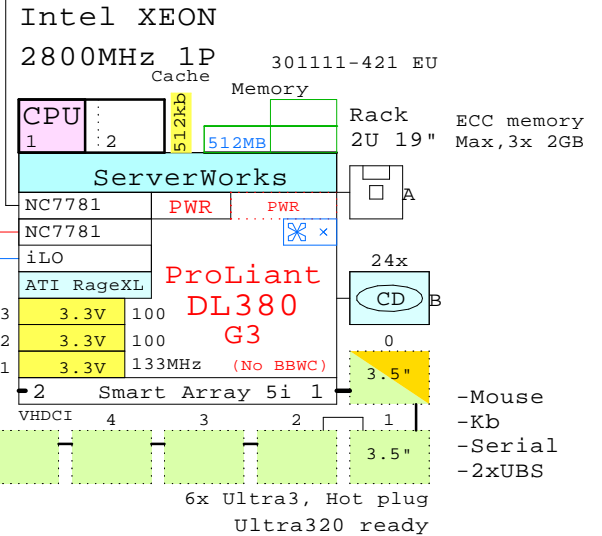

www.Compaq.com/golden-eggs

Since:Nov-2002

	02-Dec-2002	GEIDL380G3a
	Matti.Patari@hp.com	
ProLiant DL380 G3 System 2800MHz GOLDEN EGGS Visuals, Helsinki		

DL380 2P

HP ProLiant DL380 G3, 2400MHz and 2800MHz

2800MHz, 2.5GB

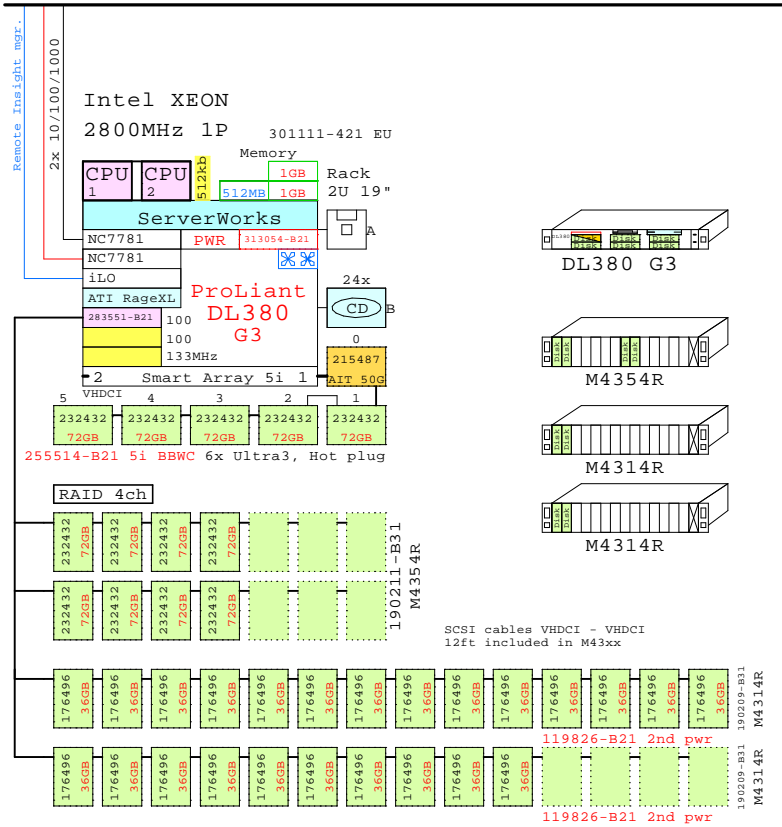

Bill of material for 2800MHz expanded system

Part Number	Qty	Description
301111-421	1	ProLiant DL380 G3 2800MHz 512MB rack 2U
1.1	1	215487-B21 1 50/100GB Hot plug AIT tape drive
1.2	5	232432-B22 5 72.8GB 10000r Ultra3 SCSI disk 1"
1.3	1	255514-B21 1 Battery Backed Write Cache Enable kit
1.4	1	257915-B21 1 Intel Xeon 2800-512kb processor kit
1.5	1	283551-B21 1 Smart Array 5304/256MB, Ultra3 4-chan
1.6	1	293048-B21 1 DL380 G3 hot plug blower kit, 3x fans
1.7	2	300679-B21 2 1GB ECC PC2100 DDR DIMM kit (2x512MB)
1.8	1	313054-B21 1 DL380 G2/G3 second power supply
2	1	190209-B31 1 Modula M4314R single buss, 14x 1.0"
2.1	10	176496-B22 10 36GB 10000r Ultra3 SCSI disk 1"
3	1	190209-B31 1 Modula M4314R single buss, 14x 1.0"
3.1	14	176496-B22 14 36GB 10000r Ultra3 SCSI disk 1"
4	1	190211-B31 1 Modula M4354R dual buss, 7+7, 1.0"
4.1	8	232432-B22 8 72.8GB 10000r Ultra3 SCSI disk 1"
5	2	119826-B21 2 Modula M42/314R 2nd power supply

2400MHz, 1GB

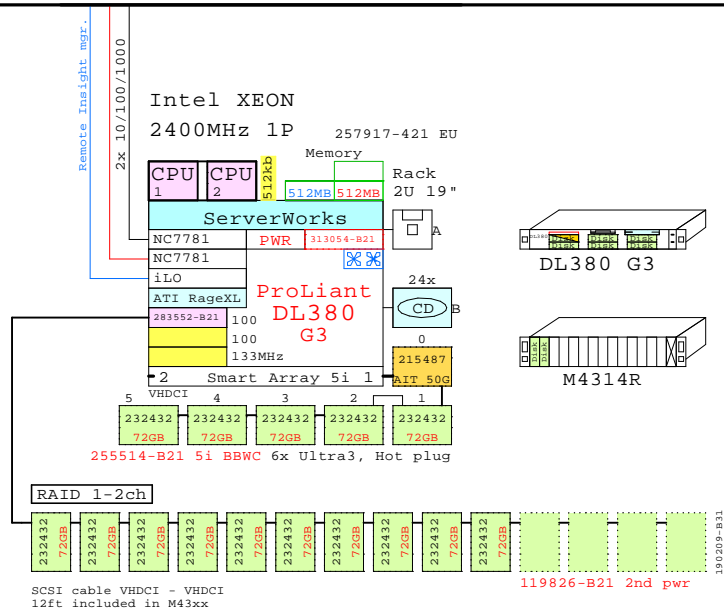

Bill of material for 2400MHz expanded system

Part Number	Qty	Description
257917-421	1	ProLiant DL380 G3 2400MHz 512MB rack 2U
1.1	1	215487-B21 1 50/100GB Hot plug AIT tape drive
1.2	5	232432-B22 5 72.8GB 10000r Ultra3 SCSI disk 1"
1.3	1	255514-B21 1 Battery Backed Write Cache Enable kit
1.4	1	257913-B21 1 Intel Xeon 2400-512kb processor kit
1.5	1	283552-B21 1 Smart Array 5302/128MB, Ultra3 2-chan
1.6	1	293048-B21 1 DL380 G3 hot plug blower kit, 3x fans
1.7	1	300678-B21 1 512MB ECC PC2100 DDR DIMM kit (2x256MB)
1.8	1	313054-B21 1 DL380 G2/G3 second power supply
2	1	190209-B31 1 Modula M4314R single buss, 14x 1.0"
2.1	10	232432-B22 10 72.8GB 10000r Ultra3 SCSI disk 1"
3	1	119826-B21 1 Modula M42/314R 2nd power supply

Bill of material for 2400MHz entry system

Part Number	Qty	Description
257917-421	1	ProLiant DL380 G3 2400MHz 512MB rack 2U
1.1	6	232432-B22 6 72.8GB 10000r Ultra3 SCSI disk 1"
1.2	1	300678-B21 1 512MB ECC PC2100 DDR DIMM kit (2x256MB)

www.Compaq.com/golden-eggs

Since Nov-2002

	28-Nov-2002	GTIDL380G3a
	Matti.Patari@hp.com	
ProLiant DL380 G3 Entry Systems		
GOLDEN EGGS Visuals, Helsinki		

DL380 2P

HP ProLiant DL380 G3, SA-RSO

Remote Insight mgr.

Primary Server

Intel XEON 2800MHz 1P 301111-421 EU

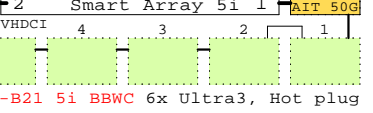
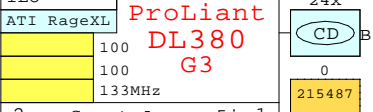
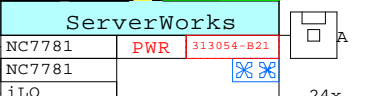
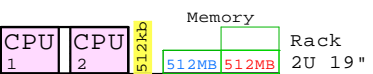

255514-B21 5i BBWC 6x Ultra3, Hot plug
280189-B21 RSO Pack

Boot from shared storage A

Smart Array Cluster Storage

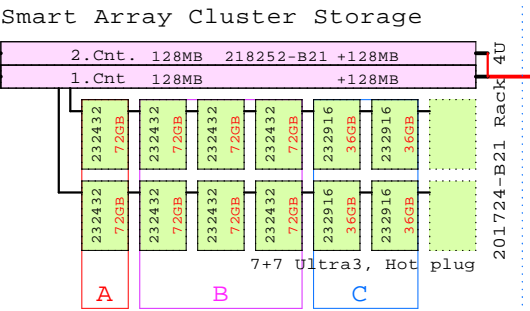

14x72.8= 1019GB

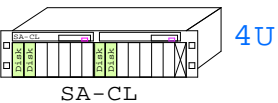

Remote Insight mgr.

Secondary Server

Intel XEON 2800MHz 1P 301111-421 EU

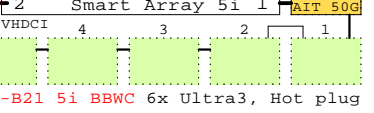
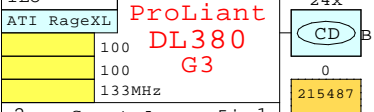
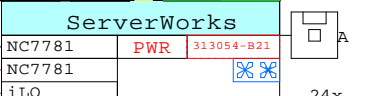
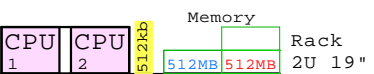

255514-B21 5i BBWC 6x Ultra3, Hot plug

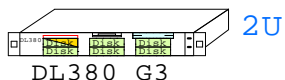
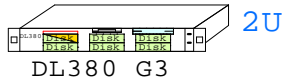

BOM of this SA-RSO System

	Part Number	Qty	Description
1	201724-B21	1	Smart Array Cluster 128MB Rack 4U
1.1	153506-B21	1	128MB Battery Backed Cache Upgrade
1.2	218252-B21	1	Smart Array Cluster Cntrl 2nd 128MB
1.2.1	153506-B21	1	128MB Battery Backed Cache Upgrade
1.3	232432-B22	8	72.8GB 10000r Ultra3 SCSI disk 1"
1.4	232916-B22	4	36GB 15000r Ultra3 SCSI disk 1"
2	301111-421	1	ProLiant DL380 G3 2800MHz 512MB rack 2U
2.1	215487-B21	1	50/100GB Hot plug AIT tape drive
2.2	255514-B21	1	Battery Backed Write Cache Enable kit
2.3	257915-B21	1	Intel Xeon 2800-512kb processor kit
2.4	293048-B21	1	DL380 G3 hot plug blower kit,3x fans
2.5	300678-B21	1	512MB ECC PC2100 DDR DIMM kit (2x256MB)
2.6	313054-B21	1	DL380 G2/G3 second power supply
3	301111-421	1	ProLiant DL380 G3 2800MHz 512MB rack 2U
3.1	215487-B21	1	50/100GB Hot plug AIT tape drive
3.2	255514-B21	1	Battery Backed Write Cache Enable kit
3.3	257915-B21	1	Intel Xeon 2800-512kb processor kit
3.4	293048-B21	1	DL380 G3 hot plug blower kit,3x fans
3.5	300678-B21	1	512MB ECC PC2100 DDR DIMM kit (2x256MB)
3.6	313054-B21	1	DL380 G2/G3 second power supply
4	280189-B21	1	ProLiant Essentials RSO Pack

www.Compaq.com/golden-eggs

Since:Nov-2002

	02-Dec-2002	GTIDL380G3b
	Matti.Patari@hp.com	

ProLiant DL380 G3, SA-RSO 2800MHz
GOLDEN EGGS Visuals, Helsinki

DL380 2P

HP ProLiant DL380 G3, SA-Cluster

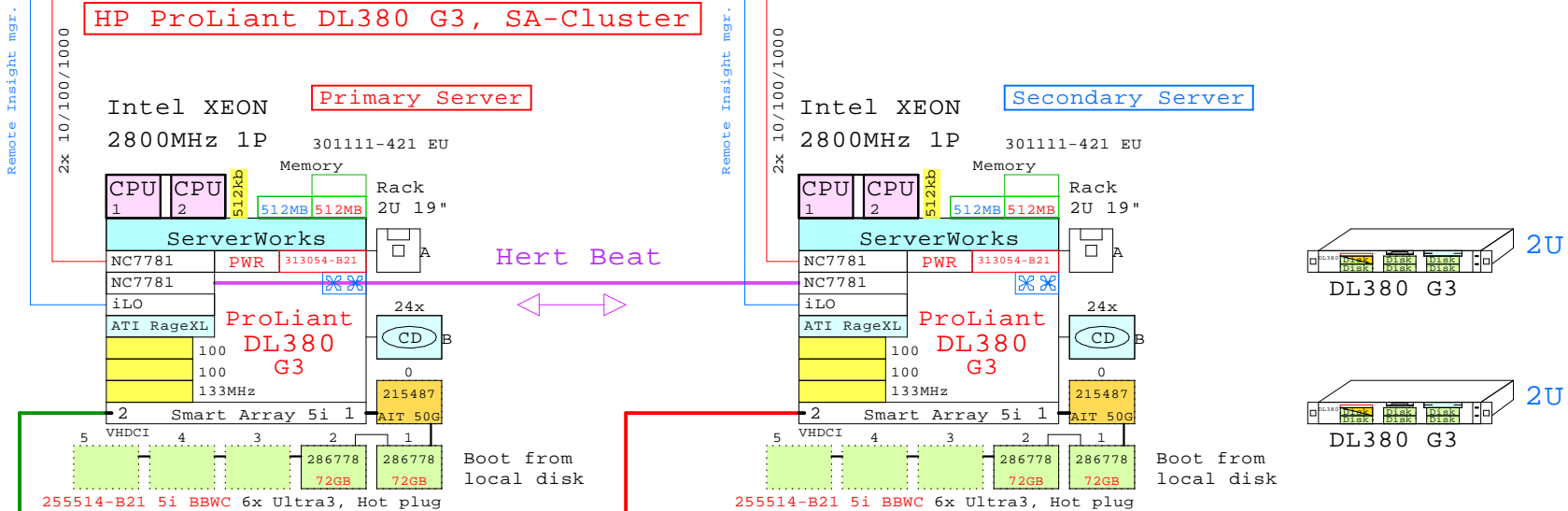

BOM of this SA-Cluster System

Part Number	Qty	Description
1	201724-B21	1 Smart Array Cluster 128MB Rack 4U
1.1	153506-B21	1 128MB Battery Backed Cache Upgrade
1.2	218252-B21	1 Smart Array Cluster Cntrl 2nd 128MB
1.2.1	153506-B21	1 128MB Battery Backed Cache Upgrade
1.3	232432-B22	8 72.8GB 10000r Ultra3 SCSI disk 1"
1.4	232916-B22	4 36GB 15000r Ultra3 SCSI disk 1"
2	301111-421	1 ProLiant DL380 G3 2800MHz 512MB rack 2U
2.1	215487-B21	1 50/100GB Hot plug AIT tape drive
2.2	255514-B21	1 Battery Backed Write Cache Enable kit
2.3	257915-B21	1 Intel Xeon 2800-512kb processor kit
2.4	286778-B22	2 72.8GB 15000r U320 disk 1"
2.5	293048-B21	1 DL380 G3 hot plug blower kit,3x fans
2.6	300678-B21	1 512MB ECC PC2100 DDR DIMM kit (2x256MB)
2.7	313054-B21	1 DL380 G2/G3 second power supply
3	301111-421	1 ProLiant DL380 G3 2800MHz 512MB rack 2U
3.1	215487-B21	1 50/100GB Hot plug AIT tape drive
3.2	255514-B21	1 Battery Backed Write Cache Enable kit
3.3	257915-B21	1 Intel Xeon 2800-512kb processor kit
3.4	286778-B22	2 72.8GB 15000r U320 disk 1"
3.5	293048-B21	1 DL380 G3 hot plug blower kit,3x fans
3.6	300678-B21	1 512MB ECC PC2100 DDR DIMM kit (2x256MB)
3.7	313054-B21	1 DL380 G2/G3 second power supply

www.Compaq.com/golden-eggs

Since:Nov-2002

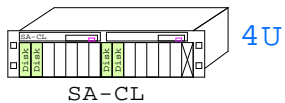

	02-Dec-2002	GTIDL380G3c
	Matti.Patari@hp.com	

ProLiant DL380 G3,SA-Cluster 2800
GOLDEN EGGS Visuals, Helsinki

DL380 2P

Mixed DL380 G3 SAN



Bill of material for this SAN

Part Number	Qty	Description
1	201723-B21	1 MSA1000 RAID Array 128MB Rack 4U
1.1	153506-B21	1 128MB Battery Backed Cache Upgrade
1.2	190209-B31	1 Modula M4314R single buss,14x 1.0"
1.2.1	232432-B22	14 72.8GB 10000r Ultra3 SCSI disk 1"
1.3	190209-B31	1 Modula M4314R single buss,14x 1.0"
1.3.1	232432-B22	14 72.8GB 10000r Ultra3 SCSI disk 1"
1.4	218231-B21	1 MSA1000 Redundant Controller
1.4.1	153506-B21	1 128MB Battery Backed Cache Upgrade
1.5	218232-B21	2 MSA1000 Fabric Switch, 6 port
1.6	221470-B21	1 Opt.Short Wave Transceiver 2Gb/s SFP-SW
1.7	232432-B22	14 72.8GB 10000r Ultra3 SCSI disk 1"
2	257917-421	1 ProLiant DL380 G3 2400MHz 512MB rack 2U
2.1	245299-B21	2 HBA 2Gb/s PCI FCA2101 for WNT/W2k
2.2	255514-B21	1 Battery Backed Write Cache Enable kit
2.3	257913-B21	1 Intel Xeon 2400-512kb processor kit
2.4	286716-B22	6 146.8GB 15000r U320 disk 1"
2.5	293048-B21	1 DL380 G3 hot plug blower kit,3x fans
2.6	300678-B21	1 512MB ECC PC2100 DDR DIMM kit (2x256MB)
2.7	313054-B21	1 DL380 G2/G3 second power supply
3	257917-421	1 ProLiant DL380 G3 2400MHz 512MB rack 2U
3.1	215487-B21	1 50/100GB Hot plug AIT tape drive
3.2	245299-B21	2 HBA 2Gb/s PCI FCA2101 for WNT/W2k
3.3	255514-B21	1 Battery Backed Write Cache Enable kit
3.4	257913-B21	1 Intel Xeon 2400-512kb processor kit
3.5	286716-B22	5 146.8GB 15000r U320 disk 1"
3.6	293048-B21	1 DL380 G3 hot plug blower kit,3x fans
3.7	300678-B21	1 512MB ECC PC2100 DDR DIMM kit (2x256MB)
3.8	313054-B21	1 DL380 G2/G3 second power supply
4	301111-421	1 ProLiant DL380 G3 2800MHz 512MB rack 2U
4.1	245299-B21	2 HBA 2Gb/s PCI FCA2101 for WNT/W2k
4.2	255514-B21	1 Battery Backed Write Cache Enable kit
4.3	257915-B21	1 Intel Xeon 2800-512kb processor kit
4.4	286716-B22	6 146.8GB 15000r U320 disk 1"
4.5	293048-B21	1 DL380 G3 hot plug blower kit,3x fans
4.6	300680-B21	2 2GB ECC PC2100 DDR DIMM kit (2x1GB)
4.7	313054-B21	1 DL380 G2/G3 second power supply
5	301111-421	1 ProLiant DL380 G3 2800MHz 512MB rack 2U
5.1	215487-B21	1 50/100GB Hot plug AIT tape drive
5.2	245299-B21	2 HBA 2Gb/s PCI FCA2101 for WNT/W2k
5.3	255514-B21	1 Battery Backed Write Cache Enable kit
5.4	257915-B21	1 Intel Xeon 2800-512kb processor kit
5.5	286716-B22	5 146.8GB 15000r U320 disk 1"
5.6	293048-B21	1 DL380 G3 hot plug blower kit,3x fans
5.7	300680-B21	2 2GB ECC PC2100 DDR DIMM kit (2x1GB)
5.8	313054-B21	1 DL380 G2/G3 second power supply
6	302512-B22	1 MSL5026SL SDLT Lib.2xDrv,Rack,Grp,LVD
7	280823-B21	1 Netw Stor Rout N1200 FC,2xLVD
8	213076-B22	4 Secure Path V3.1B for Windows W-Group
9	341175-B21	2 VHDCI to VHDCI SCSI Cable 12ft
10	221692-B21	8 FC ShortWave 2m cable LC-LC 2Gb-2Gb
11	119826-B21	2 Modula M42/314R 2nd power supply

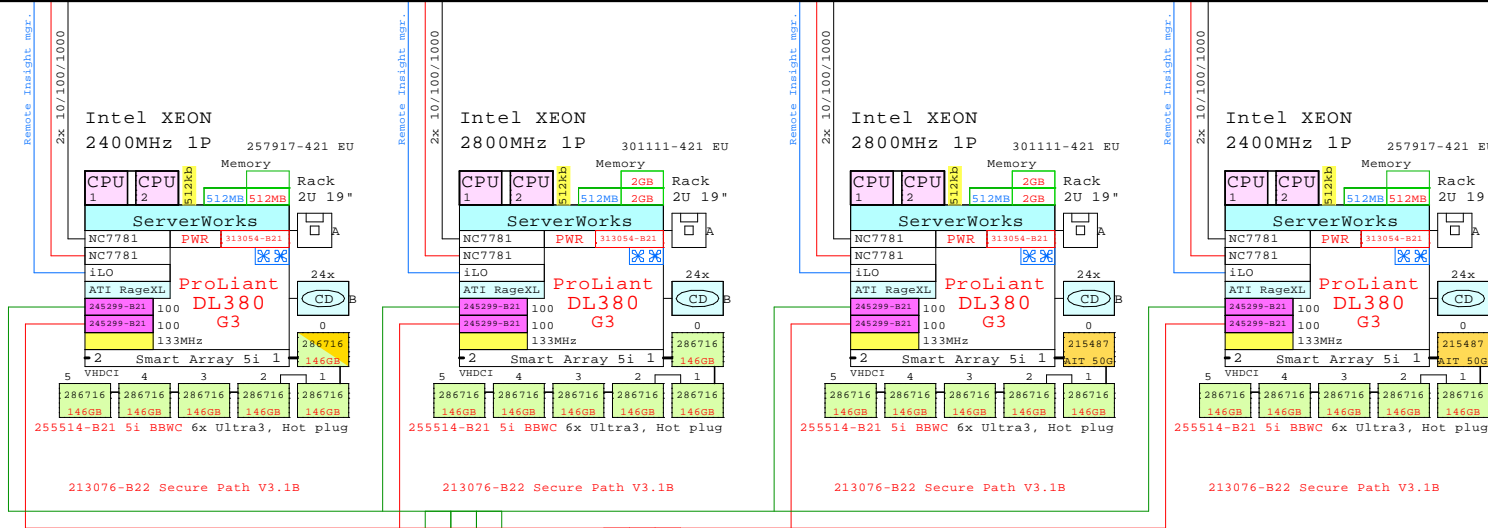

- 221692-B21 LC-LC 2m
- 221692-B21 LC-LC 2m
- 221692-B21 LC-LC 2m
- 221692-B21 LC-LC 2m

- 221692-B21 LC-LC 2m
- 221692-B21 LC-LC 2m
- 221692-B21 LC-LC 2m
- 221692-B21 LC-LC 2m

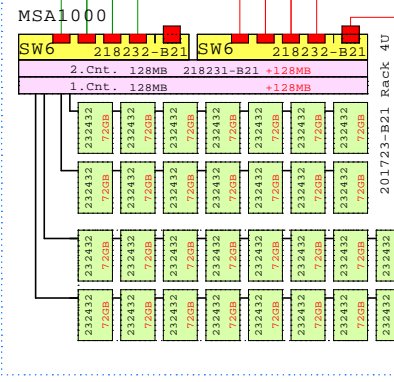
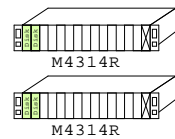
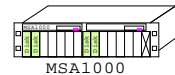

6x7 x72.8GB = 3TB

MSL5026SL SDLT Library Rack

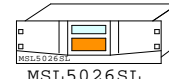
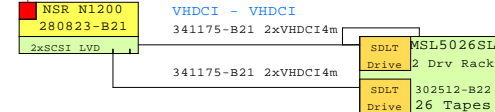

www.Compaq.com/golden-eggs
Since:Nov-2002

	28-Nov-2002	GTIDL380G3d
	Matti.Patari@hp.com	
ProLiant DL380 G3, MSA1000 SAN		
GOLDEN EGGS Visuals, Helsinki		