

Internal Options:

- CPU** 307276-B21
3rd,4th CPU
2000MHz 2MB
- 1GB** 202170-B21
- 2GB** 202171-B21
- 4GB** 202172-B21
- 203320-B21
Memory Expansion board
- 278535-B21** 278535-B21
2nd power for for 1P systems
- 255514-B21** 255514-B21 5i BBWC
BB for WC, for 1P systems
- 232916** 232916-B22
36GB 15k U3
- 232432** 232432-B22
72GB 10k U3
- 286778** 286778-B22
72GB 15k U320
- 286716** 286716-B22
146GB 15k U320
- 244948-B21** 244948-B21
NC7770 Gigabit PCI-X
- 158575-B21** 158575-B21
NC7131 Gigabit 64-bit/66MHz
- 138603-B21** 138603-B21
NC3134 Ethernet, Dual 64-bit/66MHz
- 283551-B21** 283551-B21
Smart Array 5304/256
- 245299-B21** 245299-B21
FibreChannel HBA 2Gb/s FCA2101

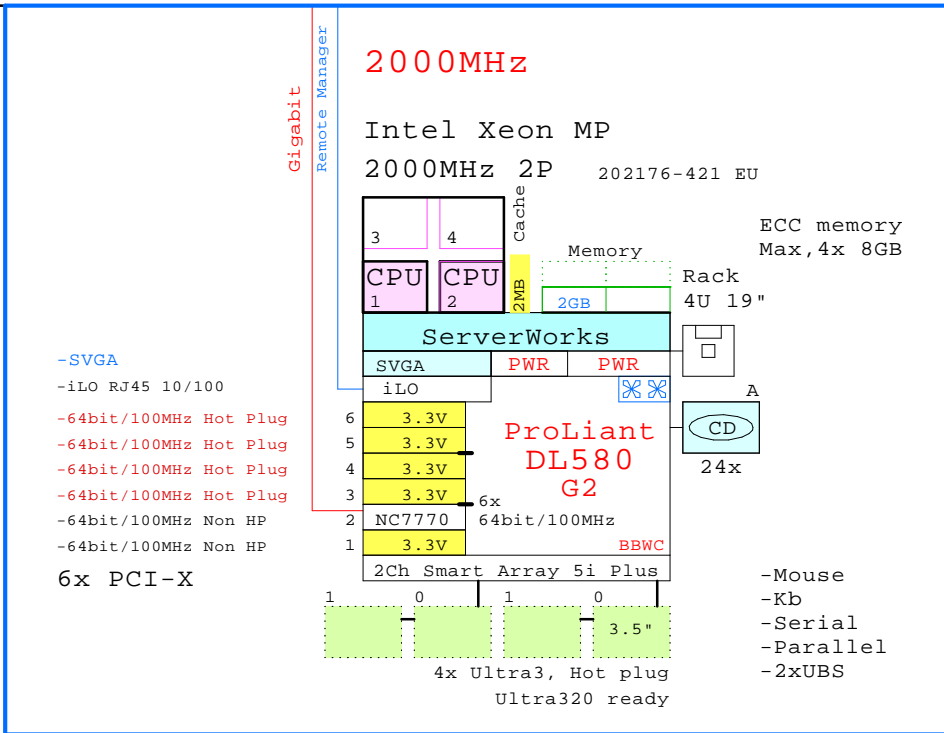
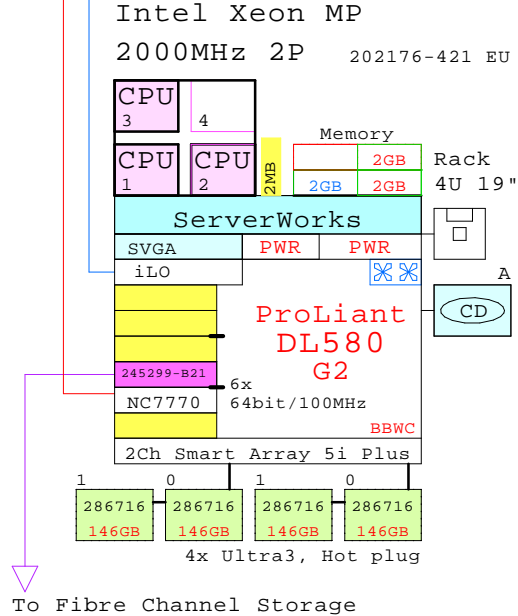

BOM of the 2000MHz-2MB 2GB 2P system above

Part Number	Qty	Description
1	202176-421	1 ProLiant DL580 G2 2P 2000MHz 2MB 2GB 4U
1.1	202171-B21	1 2GB PC1600 Reg. ECC SDRAM (4x512MB)
1.2	203320-B21	1 Hot Plug Memory Expansion Board
1.2.1	202171-B21	1 2GB PC1600 Reg. ECC SDRAM (4x512MB)
1.3	245299-B21	1 HBA 2Gb/s PCI FCA2101 for WNT/W2k
1.4	286716-B22	4 146.8GB 15000r U320 disk 1"
1.5	307276-B21	1 Intel Xeon MP 2000-2MB processor kit

Part numbers for other 2P systems at:1400,1600 and 1900MHz

Part Number	Qty	Description
1	201202-421	1 ProLiant DL580 G2 2P 1400MHz 512k 2GB 4U
1.1	226775-B21	1 Intel Xeon MP 1400-512KB processor kit
2	201203-421	1 ProLiant DL580 G2 2P 1600MHz 1MB 2GB 4U
2.1	226776-B21	1 Intel Xeon MP 1600-1MB processor kit
3	202175-421	1 ProLiant DL580 G2 2P 1900MHz 1MB 2GB 4U
3.1	311228-B21	1 Intel Xeon MP 1900-1MB processor kit

Part numbers for 1500MHz-1MB 1GB 1P system

Part Number	Qty	Description
1	202174-421	1 ProLiant DL580 G2 1P 1500MHz 1MB 1GB 4U
1.1	191220-B21	1 Intel Xeon MP 1500-1MB processor kit

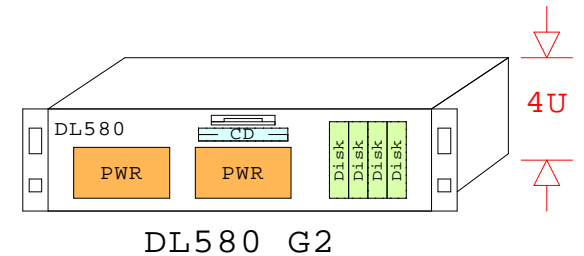

www.Compaq.com/golden-eggs

Since:Nov-2002

	02-Dec-2002	GEIDL580G2a
	Matti.Patari@hp.com	

HP ProLiant DL580 G2, 1400MHz ...2000MHz

DL580 G2, 2000MHz-2MB, 2GB

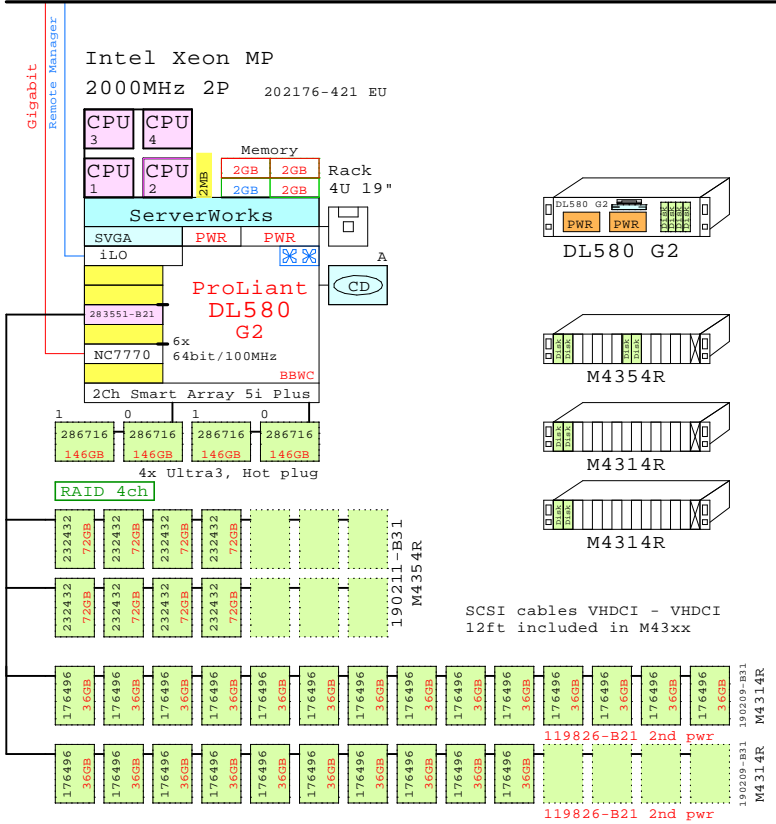

DL580 G2, 1600MHz-1MB, 2GB

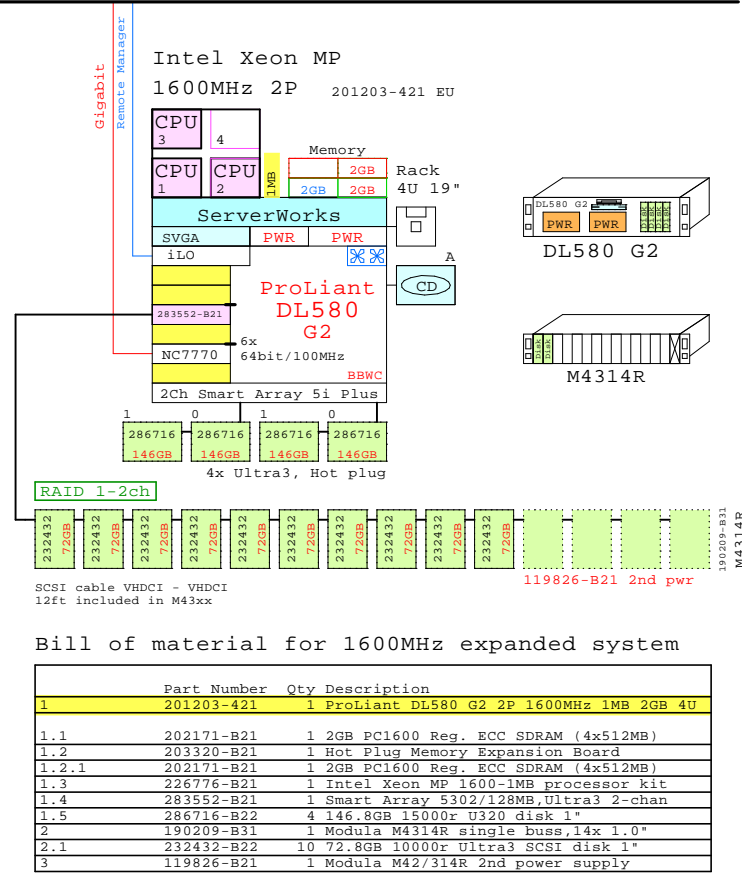

DL580 G2, 1400MHz-512k, 1GB

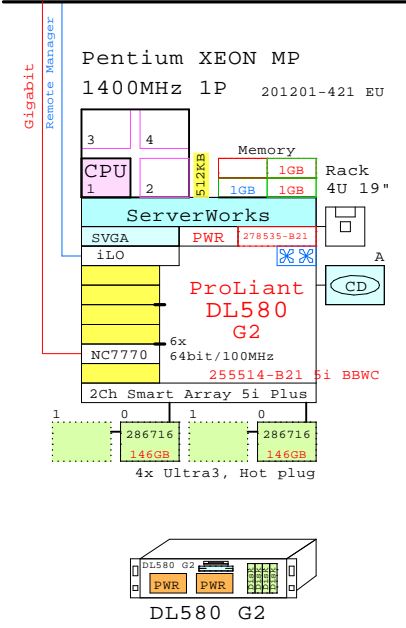

Bill of material for 2000MHz expanded system

Part Number	Qty	Description
1	1	202176-421 1 ProLiant DL580 G2 2P 2000MHz 2MB 2GB 4U
1.1	1	189082-B21 1 2GB PC100 CL2 ECC SDRAM (4x512MB)
1.2	1	203320-B21 1 Hot Plug Memory Expansion Board
1.2.1	2	189082-B21 2 2GB PC100 CL2 ECC SDRAM (4x512MB)
1.3	1	283551-B21 1 Smart Array 5304/256MB, Ultra3 4-chan
1.4	4	286716-B22 4 146.8GB 15000r U320 disk 1"
1.5	2	307276-B21 2 Intel Xeon MP 2000-2MB processor kit
2	1	190209-B31 1 Modula M4314R single buss, 14x 1.0"
2.1	10	176496-B22 10 36GB 10000r Ultra3 SCSI disk 1"
3	1	190209-B31 1 Modula M4314R single buss, 14x 1.0"
3.1	14	176496-B22 14 36GB 10000r Ultra3 SCSI disk 1"
4	1	190211-B31 1 Modula M4354R dual buss, 7+7, 1.0"
4.1	8	232432-B22 8 72.8GB 10000r Ultra3 SCSI disk 1"
5	2	119826-B21 2 Modula M42/314R 2nd power supply

Bill of material for 1400MHz entry system

Part Number	Qty	Description
1	1	201201-421 1 ProLiant DL580 G2 1P 1400MHz 512k 1GB 4U
1.1	1	202170-B21 1 1GB PC1600 Reg. ECC SDRAM (4x256MB)
1.2	1	203320-B21 1 Hot Plug Memory Expansion Board
1.2.1	1	202170-B21 1 1GB PC1600 Reg. ECC SDRAM (4x256MB)
1.3	1	255514-B21 1 Battery Backed Write Cache Enable kit
1.4	1	278535-B21 1 DL580 G2 second power supply
1.5	2	286716-B22 2 146.8GB 15000r U320 disk 1"

www.Cmpaq.com/golden-eggs

Since:Nov-2002

	29-Nov-2002	GTIDL580G2a
	Matti.Patari@hp.com	
ProLiant DL580 G2 Entry Systems		
GOLDEN EGGS Visuals, Helsinki		

HP ProLiant DL580 G2, SA-RSO

Intel Xeon MP Primary Server

2000MHz 2P 202176-421 EU

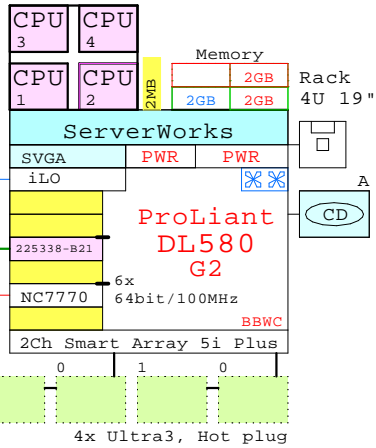

Boot from the shared storage A

280189-B21 RSO Pack

Smart Array Cluster Storage

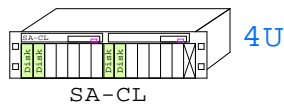
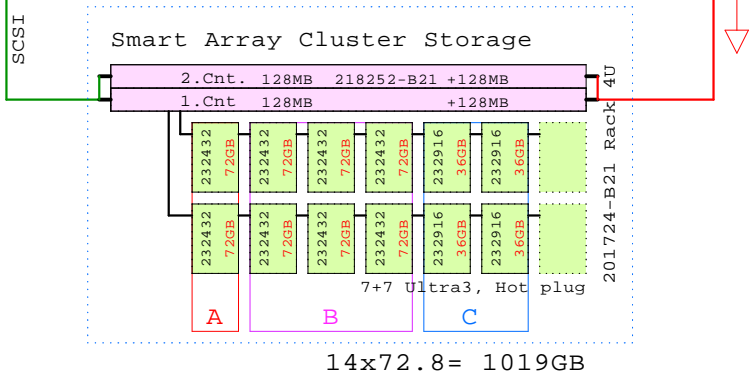

Gigabit Remote Manager

Intel Xeon MP Secondary Server

2000MHz 2P 202176-421 EU

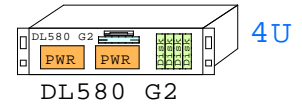
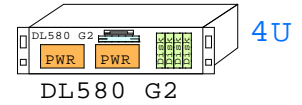
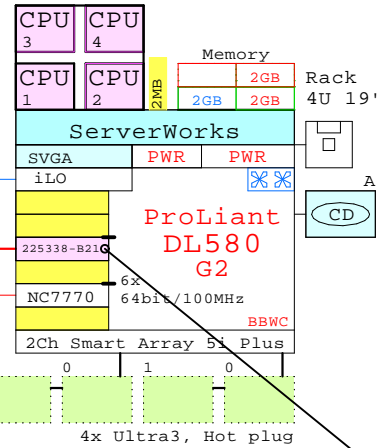

Smart Array 532, RAID Ultra3 2-chan

BOM of this SA-RSO System

	Part Number	Qty	Description
1	202176-421	1	ProLiant DL580 G2 2P 2000MHz 2MB 2GB 4U
1.1	202171-B21	1	2GB PCI1600 Reg. ECC SDRAM (4x512MB)
1.2	203320-B21	1	Hot Plug Memory Expansion Board
1.2.1	202171-B21	1	2GB PCI1600 Reg. ECC SDRAM (4x512MB)
1.3	225338-B21	1	Smart Array 532, RAID Ultra3 2-chan
1.4	307276-B21	2	Intel Xeon MP 2000-2MB processor kit
2	202176-421	1	ProLiant DL580 G2 2P 2000MHz 2MB 2GB 4U
2.1	202171-B21	1	2GB PCI1600 Reg. ECC SDRAM (4x512MB)
2.2	203320-B21	1	Hot Plug Memory Expansion Board
2.2.1	202171-B21	1	2GB PCI1600 Reg. ECC SDRAM (4x512MB)
2.3	225338-B21	1	Smart Array 532, RAID Ultra3 2-chan
2.4	307276-B21	2	Intel Xeon MP 2000-2MB processor kit
3	201724-B21	1	Smart Array Cluster 128MB Rack 4U
3.1	153506-B21	1	128MB Battery Backed Cache Upgrade
3.2	218252-B21	1	Smart Array Cluster Cntrl 2nd 128MB
3.2.1	153506-B21	1	128MB Battery Backed Cache Upgrade
3.3	232432-B22	8	72.8GB 10000r Ultra3 SCSI disk 1"
3.4	232916-B22	4	36GB 15000r Ultra3 SCSI disk 1"
4	280189-B21	1	ProLiant Essentials RSO Pack

	02-Dec-2002	GTIDL580G2b
	Matti.Patari@hp.com	
ProLiant DL580 G2 SA-RSO 2000MHZ GOLDEN EGGS Visuals, Helsinki		

HP ProLiant DL580 G2, SA-Cluster

Intel Xeon MP Primary Server

2000MHz 2P 202176-421 EU

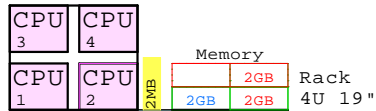

ServerWorks

SVGA PWR PWR

iLO

ProLiant DL580 G2

6x NC7770 64bit/100MHz

2Ch Smart Array Si Plus

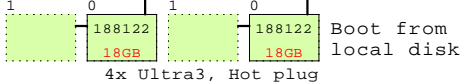

Smart Array Cluster Storage

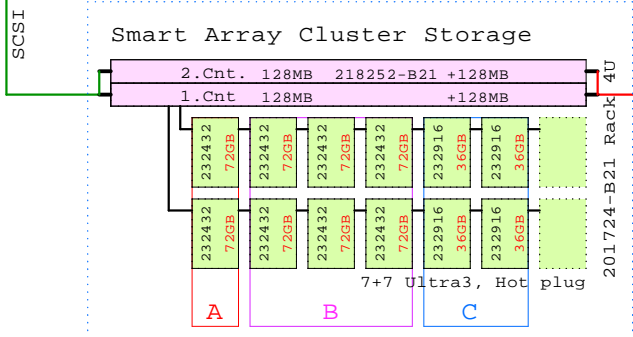

14x72.8= 1019GB

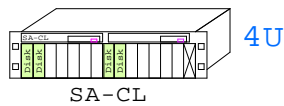

Intel Xeon MP Secondary Server

2000MHz 2P 202176-421 EU

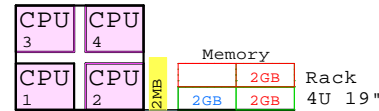

ServerWorks

SVGA PWR PWR

iLO

ProLiant DL580 G2

6x NC7770 64bit/100MHz

2Ch Smart Array Si Plus

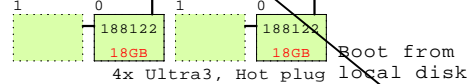

Smart Array 532, RAID Ultra3 2-chan

BOM of this SA-Cluster System

Part Number	Qty	Description
202176-421	1	ProLiant DL580 G2 2P 2000MHz 2MB 2GB 4U
1.1	1	138603-B21 Compaq NC3134 Fast Ethernet Dual port
1.2	2	188122-B22 18.2GB 15000r Ultra3 SCSI disk 1"
1.3	1	202171-B21 2GB PCI1600 Reg. ECC SDRAM (4x512MB)
1.4	1	203320-B21 Hot Plug Memory Expansion Board
1.4.1	1	202171-B21 2GB PCI1600 Reg. ECC SDRAM (4x512MB)
1.5	1	225338-B21 Smart Array 532, RAID Ultra3 2-chan
1.6	2	307276-B21 Intel Xeon MP 2000-2MB processor kit
2	1	202176-421 ProLiant DL580 G2 2P 2000MHz 2MB 2GB 4U
2.1	1	138603-B21 Compaq NC3134 Fast Ethernet Dual port
2.2	2	188122-B22 18.2GB 15000r Ultra3 SCSI disk 1"
2.3	1	202171-B21 2GB PCI1600 Reg. ECC SDRAM (4x512MB)
2.4	1	203320-B21 Hot Plug Memory Expansion Board
2.4.1	1	202171-B21 2GB PCI1600 Reg. ECC SDRAM (4x512MB)
2.5	1	225338-B21 Smart Array 532, RAID Ultra3 2-chan
2.6	2	307276-B21 Intel Xeon MP 2000-2MB processor kit
3	1	201724-B21 Smart Array Cluster 128MB Rack 4U
3.1	1	153506-B21 128MB Battery Backed Cache Upgrade
3.2	1	218252-B21 Smart Array Cluster Cntrl 2nd 128MB
3.2.1	1	153506-B21 128MB Battery Backed Cache Upgrade
3.3	8	232432-B22 72.8GB 10000r Ultra3 SCSI disk 1"
3.4	4	232916-B22 36GB 15000r Ultra3 SCSI disk 1"

www.Compaq.com/golden-eggs

Since:Nov-2002

	02-Dec-2002	GTIDL580G2c
	Matti.Patari@hp.com	
ProLiant DL580 G2 SA-Cluster 2000		
GOLDEN EGGS Visuals, Helsinki		

DL580 4P

Mixed DL580 G2 MSA1000 SAN

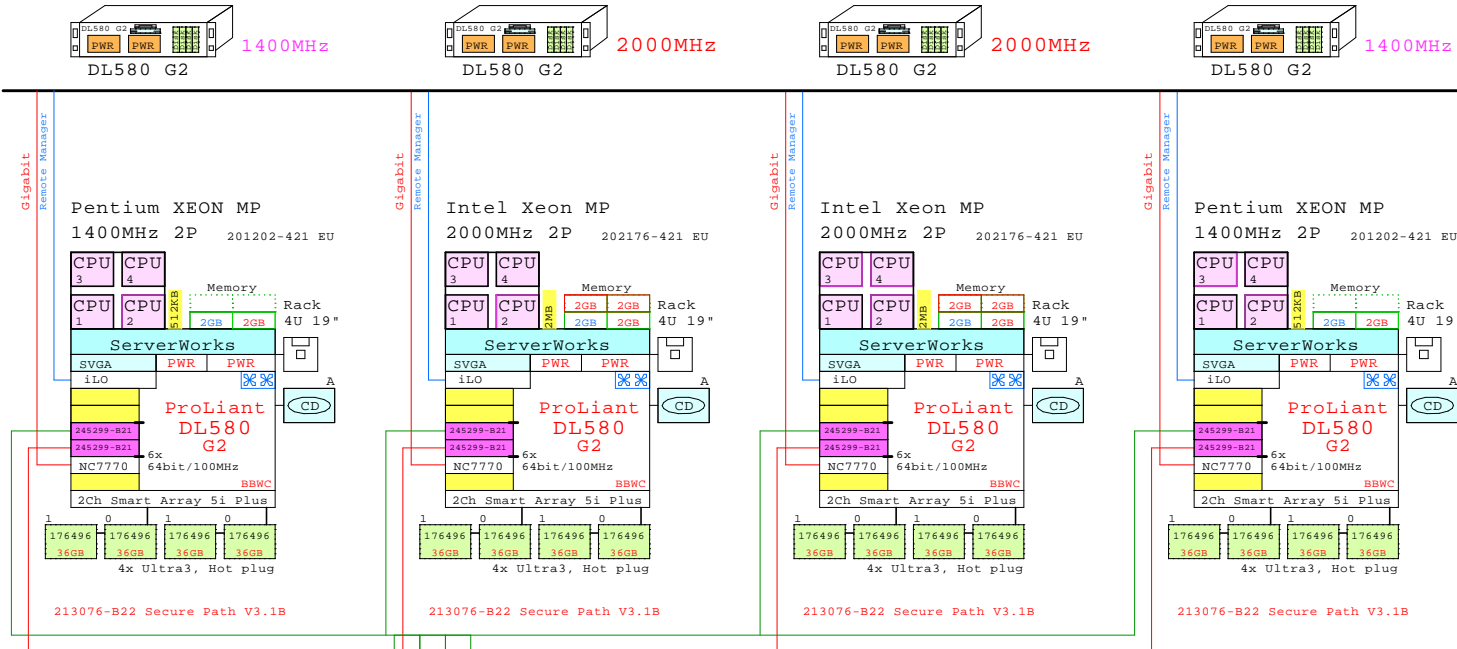

Bill of material for this SAN

Part Number	Qty	Description
201723-B21	1	MSA1000 RAID Array 128MB Rack 4U
1.1	153506-B21	1 128MB Battery Backed Cache Upgrade
1.2	190209-B31	1 Modula M4314R single buss,14x 1.0"
1.2.1	232432-B22	14 72.8GB 10000r Ultra3 SCSI disk 1"
1.3	190209-B31	1 Modula M4314R single buss,14x 1.0"
1.3.1	232432-B22	14 72.8GB 10000r Ultra3 SCSI disk 1"
1.4	218231-B21	1 MSA1000 Redundant Controller
1.4.1	153506-B21	1 128MB Battery Backed Cache Upgrade
1.5	218232-B21	2 MSA1000 Fabric Switch, 6 port
1.6	221470-B21	1 Opt. Short Wave Transceiver 2Gb/s SFP-SW
1.7	232432-B22	14 72.8GB 10000r Ultra3 SCSI disk 1"
2	201202-421	1 ProLiant DL580 G2 2P 1400MHz 512k 2GB 4U
2.1	176496-B22	4 36GB 10000r Ultra3 SCSI disk 1"
2.2	202171-B21	1 2GB PC1600 Reg. ECC SDRAM (4x512MB)
2.3	226775-B21	2 Intel Xeon MP 1400-512KB processor kit
2.4	245299-B21	2 HBA 2Gb/s PCI FCA2101 for WNT/W2k
3	201202-421	1 ProLiant DL580 G2 2P 1400MHz 512k 2GB 4U
3.1	176496-B22	4 36GB 10000r Ultra3 SCSI disk 1"
3.2	202171-B21	1 2GB PC1600 Reg. ECC SDRAM (4x512MB)
3.3	226775-B21	2 Intel Xeon MP 1400-512KB processor kit
3.4	245299-B21	2 HBA 2Gb/s PCI FCA2101 for WNT/W2k
4	202176-421	1 ProLiant DL580 G2 2P 2000MHz 2MB 2GB 4U
4.1	176496-B22	4 36GB 10000r Ultra3 SCSI disk 1"
4.2	202171-B21	1 2GB PC1600 Reg. ECC SDRAM (4x512MB)
4.3	203320-B21	1 Hot Plug Memory Expansion Board
4.3.1	202171-B21	2 2GB PC1600 Reg. ECC SDRAM (4x512MB)
4.4	245299-B21	2 HBA 2Gb/s PCI FCA2101 for WNT/W2k
4.5	307276-B21	2 Intel Xeon MP 2000-2MB processor kit
5	202176-421	1 ProLiant DL580 G2 2P 2000MHz 2MB 2GB 4U
5.1	176496-B22	4 36GB 10000r Ultra3 SCSI disk 1"
5.2	202171-B21	1 2GB PC1600 Reg. ECC SDRAM (4x512MB)
5.3	203320-B21	1 Hot Plug Memory Expansion Board
5.3.1	202171-B21	2 2GB PC1600 Reg. ECC SDRAM (4x512MB)
5.4	245299-B21	2 HBA 2Gb/s PCI FCA2101 for WNT/W2k
5.5	307276-B21	2 Intel Xeon MP 2000-2MB processor kit
6	302512-B22	1 MSL5026SL SDLT Lib. 2xDrv. Rack, Grap. LVD
7	280823-B21	1 Netw Stor Rout N1200 FC, 2xLVD
8	213076-B22	4 Secure Path V3.1B for Windows W-Group
9	341175-B21	2 VHDCI to VHDCI SCSI Cable 12ft
10	221692-B21	8 FC ShortWave 2m cable LC-LC 2Gb-2Gb
11	119826-B21	2 Modula M42/314R 2nd power supply

221692-B21 LC-LC 2m
221692-B21 LC-LC 2m
221692-B21 LC-LC 2m
221692-B21 LC-LC 2m

221692-B21 LC-LC 2m
221692-B21 LC-LC 2m
221692-B21 LC-LC 2m
221692-B21 LC-LC 2m

RAID
MSA1000

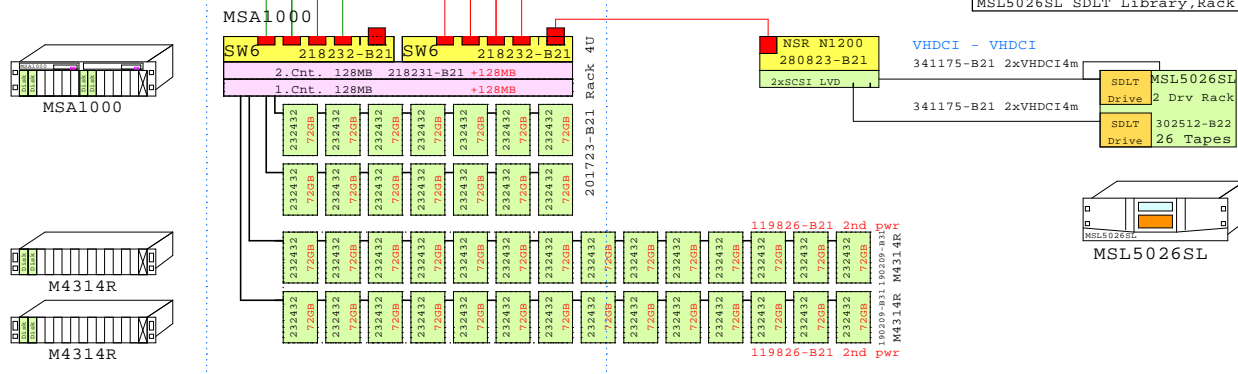

6x7 x72.8GB = 3TB

www.Compaq.com/golden-eggs

Since: Nov-2002