

Pentium III Xeon  
900MHz  
155618-423

**Compaq ProLiant DL580 2P**

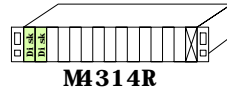

RAID 4ch

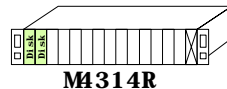
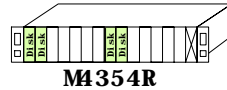
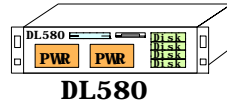
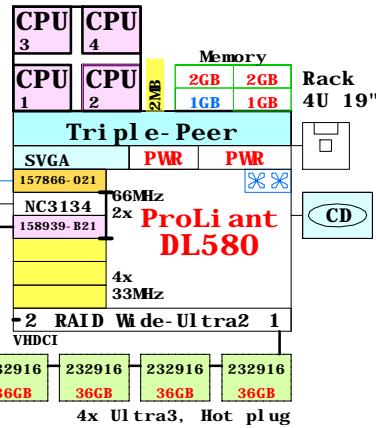
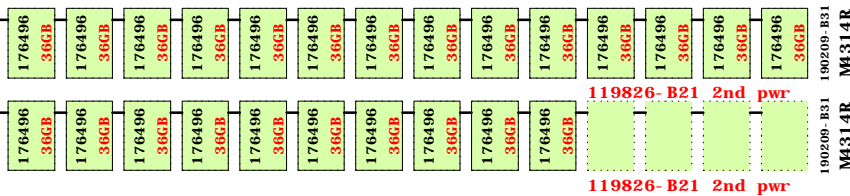
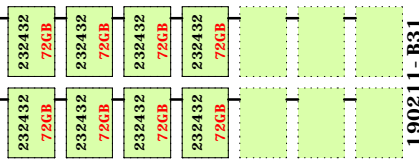

**Bill of material**

Part Number	Qty	Description
1	155618-423	1 ProLiant DL580 2P 900MHz 1GB rack 4U
1.1	157866-021	1 CPQ Remote Insight manager kit
1.2	158939-B21	1 Smart Array 5304/128MB, Ultra3 4-chan
1.3	189081-B21	1 1GB PC100 CL2 ECC SDRAM (4x256MB)
1.4	189082-B21	2 2GB PC100 CL2 ECC SDRAM (4x512MB)
1.5	222627-B21	2 Pentium III Xeon 900-2MB processor kit
1.6	232916-B22	4 36GB 15000r Ultra3 SCSI disk 1"
2	190209-B31	1 Modula M4314R single buss, 14x 1.0"
2.1	176496-B22	10 36GB 10000r Ultra3 SCSI disk 1"
3	190209-B31	1 Modula M4314R single buss, 14x 1.0"
3.1	176496-B22	14 36GB 10000r Ultra3 SCSI disk 1"
4	190211-B31	1 Modula M4354R dual buss, 7+7, 1.0"
4.1	232432-B22	8 72.8GB 10000r Ultra3 SCSI disk 1"
5	119826-B21	2 Modula M42/314R 2nd power supply

Pentium III Xeon  
900MHz  
155618-423

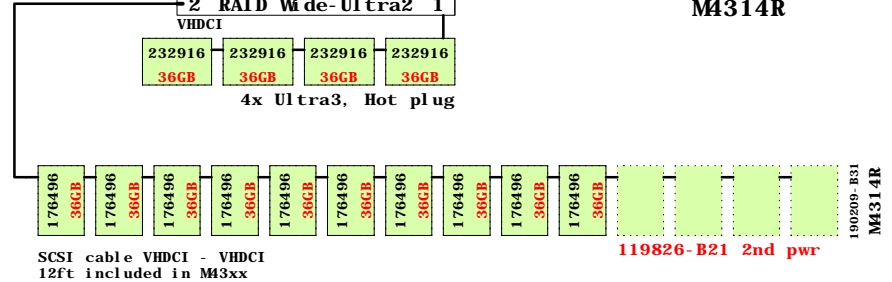
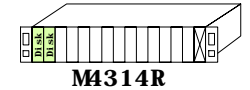
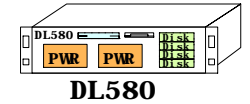
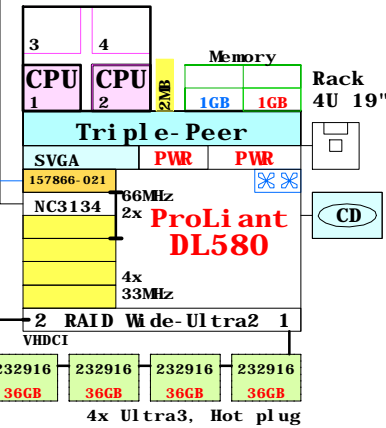

SCSI cable VHDCI - VHDCI  
12ft included in M43xx

**Bill of material**

Part Number	Qty	Description
1	155618-423	1 ProLiant DL580 2P 900MHz 1GB rack 4U
1.1	157866-021	1 CPQ Remote Insight manager kit
1.2	189081-B21	1 1GB PC100 CL2 ECC SDRAM (4x256MB)
1.3	232916-B22	4 36GB 15000r Ultra3 SCSI disk 1"
2	190209-B31	1 Modula M4314R single buss, 14x 1.0"
2.1	176496-B22	10 36GB 10000r Ultra3 SCSI disk 1"
3	119826-B21	2 Modula M42/314R 2nd power supply

[www.compaq.com/golden-eggs](http://www.compaq.com/golden-eggs)

Since: Oct-2001



12-Nov-2001 GTIDL580a  
Matti.Patari@Compaq.com

**DL580 4P**

ProLiant DL580 2P Entry System  
GOLDEN EGGS Visuals, Helsinki