

DECnet SNA Gateway for Channel Transport

Problem Solving (OpenVMS and ULTRIX)

Part Number: AA-LU37E-TE

November 1993

This document explains how to solve problems that could arise in the day-to-day use of the DECnet SNA Gateway for Channel Transport and its related products. This manual is for OpenVMS VAX, OpenVMS AXP, and ULTRIX operating systems. This manual also describes diagnostic tools and explains how to report problems with the DECnet SNA Gateway products.

Revision/Update Information: This is a revised manual.

Operating System and Version: OpenVMS VAX V5.4 or later
OpenVMS AXP V1.5
ULTRIX V4.2

Software Version: DECnet SNA Gateway for Channel
Transport V2.1

November 1993

Information in this document is subject to change without notice and should not be construed as a commitment by Digital Equipment Corporation. Digital Equipment Corporation assumes no responsibility for any errors that may appear in this document.

The software described in this document is furnished under a license and may be used or copied only in accordance with the terms of such a license.

No responsibility is assumed for the use or reliability of software on equipment that is not supplied by Digital Equipment Corporation or its affiliated companies.

Restricted Rights: Use, duplication, or disclosure by the U.S. Government is subject to restrictions as set forth in subparagraph (c)(1)(ii) of the Rights in Technical Data and Computer Software clause at DFARS 252.227-7013.

Copyright ©1988, 1991, 1993 Digital Equipment Corporation
All Rights Reserved

The following are trademarks of Digital Equipment Corporation:

AXP, DEC, DEC/CMS, DEC/MSS, DECnet, DECsystem-10, DECSYSTEM-20, DECUS, DECwriter, DIBOL, EduSystem, IAS, MASSBUS, OpenVMS, PDP, PDT, RSTS, RSX, UNIBUS, VAX, VAXcluster, VMS, VT, and the Digital logo.

IBM is a registered trademark of International Business Machines Corporation.

MS-DOS is a registered trademark of Microsoft Corporation.

PostScript is a registered trademark of Adobe Systems, Inc.

Contents

| | |
|--|-----|
| Preface | v |
| 1 Introducing Problem Solving for OpenVMS and ULTRIX | |
| 1.1 Using This Manual | 1-1 |
| 1.2 Checking the System Before Problem Solving | 1-2 |
| 1.3 Reporting the Problem | 1-2 |
| 2 Solving Gateway-CT Problems (OpenVMS) | |
| 3 Solving Gateway-CT Problems (ULTRIX) | |
| 4 Testing the Network (OpenVMS and ULTRIX) | |
| 4.1 Node-Level Tests | 4-3 |
| 4.1.1 Remote Loopback Test | 4-3 |
| 4.1.2 Local Loopback Test | 4-5 |
| 4.2 Circuit-Level Test | 4-6 |
| 5 Using Trace Utilities to Isolate Gateway-CT Problems (OpenVMS and ULTRIX) | |
| 5.1 Using DECnet SNA Trace Utilities | 5-1 |
| 5.1.1 Channel-Attached Circuit Level Trace | 5-2 |
| 5.1.2 Physical Unit Level Trace | 5-2 |
| 5.1.3 Session Level Trace | 5-2 |
| 5.2 Using IBM Trace Utilities | 5-2 |
| 5.2.1 VTAM Buffer Contents Trace | 5-3 |
| 5.2.2 VTAM I/O Trace | 5-3 |
| 5.2.3 GTF Trace | 5-3 |
| 5.2.4 CP Trace | 5-4 |
| 5.2.5 SDAID Trace | 5-5 |

6 Obtaining Information and Reporting Gateway-CT Problems (OpenVMS and ULTRIX)

| | | |
|-----|---------------------------------|-----|
| 6.1 | Gathering Information | 6-1 |
|-----|---------------------------------|-----|

Index

Figures

| | | |
|-----|--|-----|
| 1 | Gateway-CT Manuals for OpenVMS Users | vi |
| 2 | Gateway-CT Manuals for ULTRIX Users | vii |
| 4-1 | Running NCP Tests | 4-2 |
| 4-2 | Remote Loopback Test | 4-4 |
| 4-3 | Local Loopback Test | 4-5 |

Preface

The DECnet SNA Gateway for Channel Transport (called Gateway-CT) is a system of hardware and software that provides an interface between International Business Machines Corporation SNA networks and Digital Equipment Corporation DECnet™ networks through a channel directly attached to the IBM® host.

Note

Throughout this manual, the hardware server box is generically referred to as a ChannelServer. Where differences occur, distinctions between the DEC ChannelServer and the DEC ChannelServer II are noted.

By handling different communications protocols between these networks, the Gateway-CT enables certain nodes in a Digital network to communicate with one or more hosts in an IBM SNA network.

This manual should be used by network managers and system managers who must solve problems that arise during the day-to-day use of the Gateway-CT software product, managed from either an OpenVMS™ or an ULTRIX™ system. Readers of this manual must have a working knowledge of the Digital and IBM systems they will be using and should use this manual with other Digital and IBM documentation.

Figure 1 and Figure 2 list the Gateway-CT manuals according to major tasks they describe. Arrows suggest the order for using the books according to the needs of OpenVMS or ULTRIX users. For both figures, the highlighted manual refers to this manual.

Figure 1 Gateway-CT Manuals for OpenVMS Users

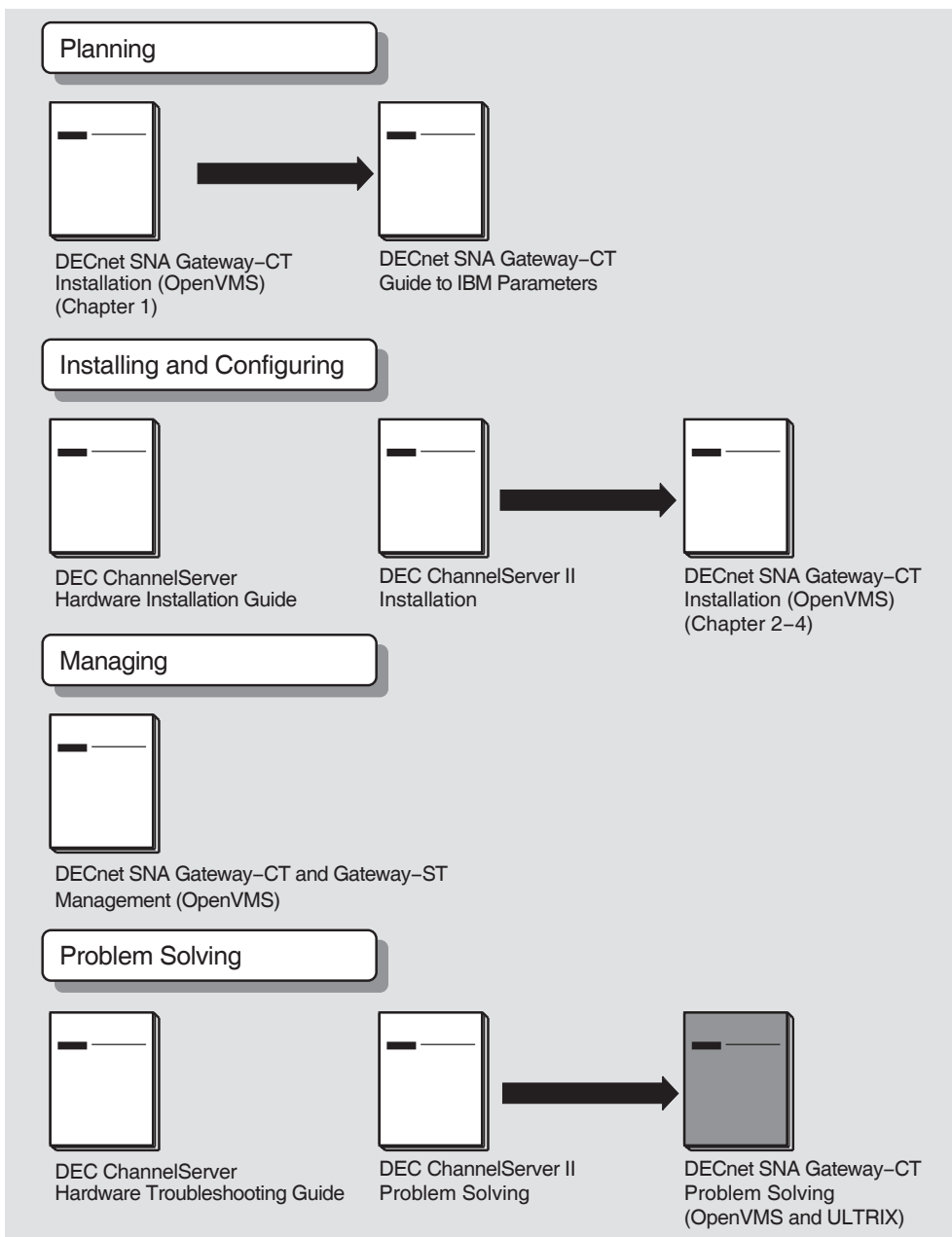
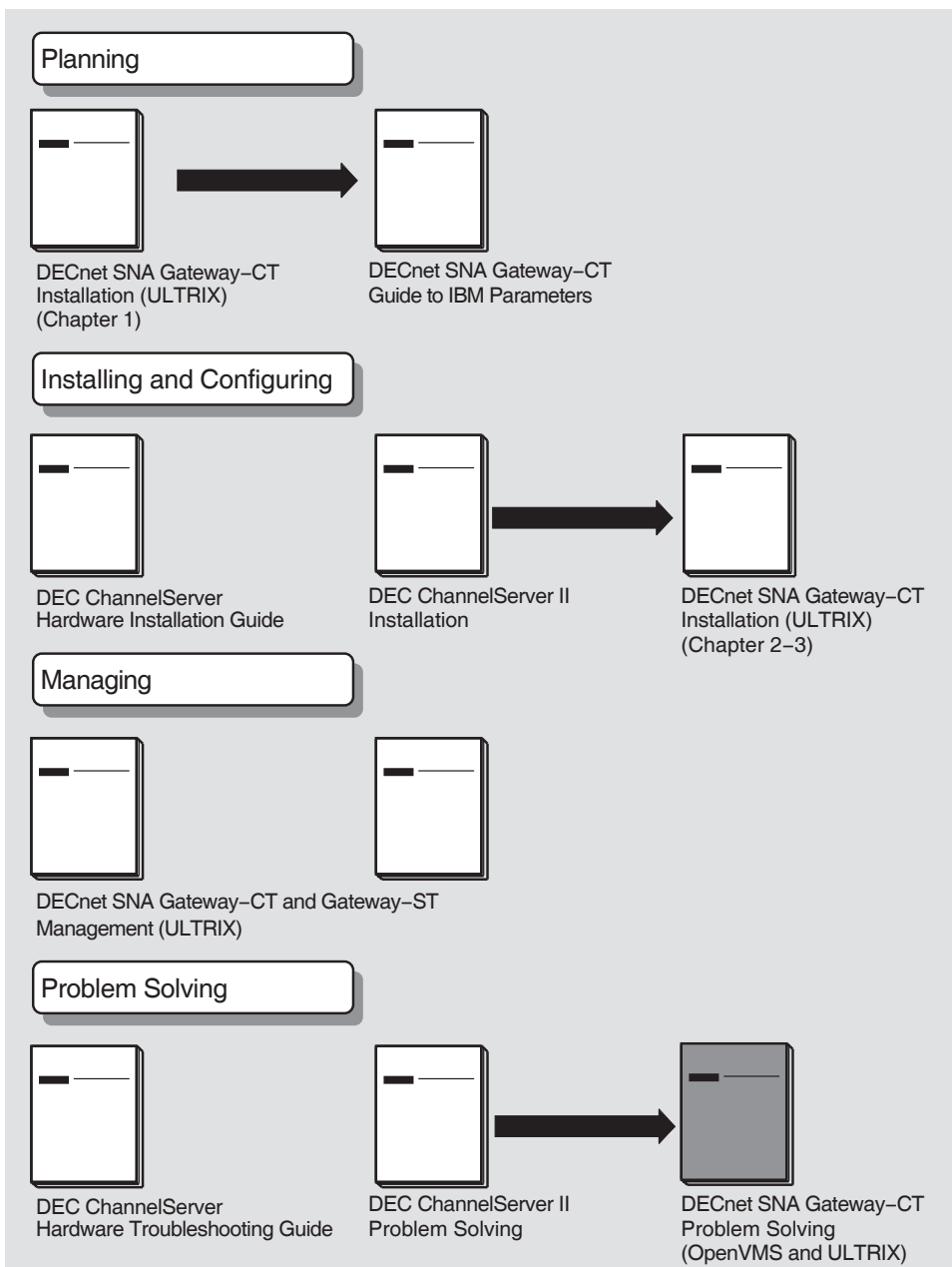

Figure 2 Gateway-CT Manuals for ULTRIX Users



Digital Equipment Corporation provides access routine products that use the Gateway-CT to access IBM systems. See the Software Product Description (SPD) for a list of the DECnet SNA access routines you may use with the Gateway-CT. Each access routine has its own manual or set of manuals.

You may find the following OpenVMS manuals useful:

- *OpenVMS Networking Manual*
- *OpenVMS System Manager's Manual*
- *OpenVMS System Messages and Recovery Procedures*

You may find the following ULTRIX manuals useful:

- *DECnet-ULTRIX DECnet-Internet Gateway Use and Management*
- *DECnet-ULTRIX Installation*
- *DECnet-ULTRIX Network Management*
- *DECnet-ULTRIX NCP Command Reference*
- *DECnet-ULTRIX Programming*
- *DECnet-ULTRIX Use*

Conventions

This manual uses the following conventions:

UPPERCASE

OpenVMS commands, command options, parameters, system calls, subroutines, user names, files names, and directory names appear in uppercase.

SNANCP> SET LINE *line-id*

In command examples, black monospaced type indicates system output and user input.

Uppercase letters represent text to be entered. Lowercase letters in italics represent variables for which you must substitute specific information.

ULTRIX terms

ULTRIX commands, command options, parameters, system calls, subroutines, user names, files names, and directory names appear in the typeface shown.

snanpc> set line *line-id*

In command examples, black monospaced type indicates system output. Red monospaced type indicates user input.

Lowercase letters represent text to be entered. Lowercase letters in italics represent variables for which you must substitute specific information.

Return

Unless otherwise specified, every command line is terminated by pressing the Return key.

Ctrl/x

This symbol indicates that you press and hold down the key labeled Ctrl while simultaneously pressing another key (for example, Ctrl/Z.)

System powered up?

In Chapter 2 and Chapter 3, this symbol refers to the question found in the diagnostic map.

The following conventions are used for the VMS SNANCP and NCP utility commands and for the ULTRIX `snancp` and `ncp` utility commands.

| | |
|---------------------|---|
| <i>circuit-id</i> | <p>A string of characters whose exact syntax is that for a DECnet or SNA circuit identification.</p> <p>On DECnet nodes, circuit identification takes the following form:</p> <p style="text-align: center;"><i>dev-c</i></p> <p>where <i>dev</i> is a device name and <i>c</i> is a decimal number (0 or a positive integer) designating the device's hardware controller.</p> <p>Channel-attached circuits are identified by a string in the form CHAN-<i>n</i>, where <i>n</i> indicates the number of the circuit.</p> <p>On the Gateway node, the Ethernet circuit is identified by the string ETHERNET.</p> |
| <i>date time</i> | <p>The date and time in the formats <i>dd-mmm-yyyy</i> and <i>hh:mm:ss.cc</i>.</p> |
| <i>E-address</i> | <p>A string of 12 hexadecimal digits, represented by 6 bytes separated by hyphens (for example, 08-00-2B-08-CC-B3). The string indicates the Ethernet hardware address.</p> |
| <i>line-id</i> | <p>A string of characters whose exact syntax is that for a DECnet or SNA line identification.</p> <p>On DECnet nodes, line identification takes the following form:</p> <p style="text-align: center;"><i>dev-c</i></p> <p>where <i>dev</i> is a device name and <i>c</i> is a decimal number (0 or a positive integer) designating the device's hardware controller.</p> <p>Channel-attached lines are identified by a string in the form CQ-<i>n</i>, where <i>n</i> indicates the number of the line.</p> <p>On the Gateway node, the Ethernet line is identified by the string ETHERNET.</p> |
| <i>node-address</i> | <p>A numeric value ranging from 1.1 to 63.1023, composed of an area number to the left of the period followed by a node number to the right of the period. If the area number is not supplied, the area number of the executor node is used. The default area number for the executor is 1.</p> |
| <i>gnn</i> | <p>A string of up to 6 alphanumeric characters containing at least 1 alphabetic character and denoting the node name of the Gateway-CT.</p> |
| <i>lhnn</i> | <p>A string of up to 6 alphanumeric characters containing at least 1 alphabetic character and denoting the node name of the load host.</p> |
| <i>node-id</i> | <p>Either a <i>node-name</i> or a <i>node-address</i>.</p> |
| <i>node-name</i> | <p>A string of up to 6 alphanumeric characters containing at least 1 alphabetic character.</p> |

Abbreviations and Acronyms

This manual uses the following abbreviations and acronyms:

| | |
|------------|---|
| API | DECnet SNA Application Programming Interface |
| APPC/LU6.2 | DECnet SNA APPC/LU6.2 Programming Interface for OpenVMS |
| CICS/VS | Customer Information Control System/Virtual Storage (also called CICS) |
| DDXF | DECnet/SNA VMS DISOSS Document Exchange Facility |
| DECnet NCP | Digital's Network Control Program (also called NCP) |
| DHCF | DECnet/SNA VMS Distributed Host Command Facility |
| DSPRINT | MVS/TSO/VTAM Data Set Print Facility |
| DTF | DECnet SNA Data Transfer Facility |
| GTF | Generalized Trace Facility |
| IMS/VS | Information Management System/Virtual Storage (also called IMS) |
| JES2 | Job Entry Subsystem 2 |
| JES3 | Job Entry Subsystem 3 |
| LU | Logical unit |
| MOM | Maintenance Operation Module |
| MVS | Multiple Virtual Storage operating system |
| NCL | Network Control Language |
| NCP | Network Control Program. Can refer to Digital's NCP or IBM's NCP. This manual uses NCP to refer to the Digital product and IBM NCP to refer to the IBM product. |
| PIUs | Path Information Units |
| PrE | DECnet SNA Printer Emulator |
| PU | Physical unit |
| RH | Request/response header |
| RISC | Reduced Instruction Set Computer |
| RJE | DECnet SNA Remote Job Entry |
| RU | Request/response unit |
| SNA | IBM's Systems Network Architecture |
| snaconfig | DECnet SNA Gateway Configuration Program |
| SNANCP | DECnet SNA Gateway Network Control Program |
| SSCP | System services control point |

| | |
|-----------|---|
| SPR | Software Performance Report |
| SVC | Service Call |
| 3270 TE | DECnet SNA 3270 Terminal Emulator |
| 3270 DSPI | DECnet SNA 3270 Data Stream Programming Interface |
| TSO | Time Sharing Option |
| ULTRIX | Digital Equipment Corporation's version of the UNIX operating system. |
| VM | Virtual Machine operating system |
| VSE/SP | Virtual Storage Extended/System Packages |
| VTAM | Virtual Telecommunications Access Method |

1

Introducing Problem Solving for OpenVMS and ULTRIX

This manual contains information to help you solve problems that may occur when you are using the DECnet SNA Gateway-CT and related DECnet SNA access routines, managed from the OpenVMS or ULTRIX operating systems. Use this guide together with the appropriate Digital Equipment Corporation and International Business Machines Corporation documentation to solve as many problems as possible at your level.

1.1 Using This Manual

Gateway and access routine problems can occur for a number of reasons. The diagnostic map in Chapter 2 (for OpenVMS) and in Chapter 3 (for ULTRIX) should help you isolate the problem.

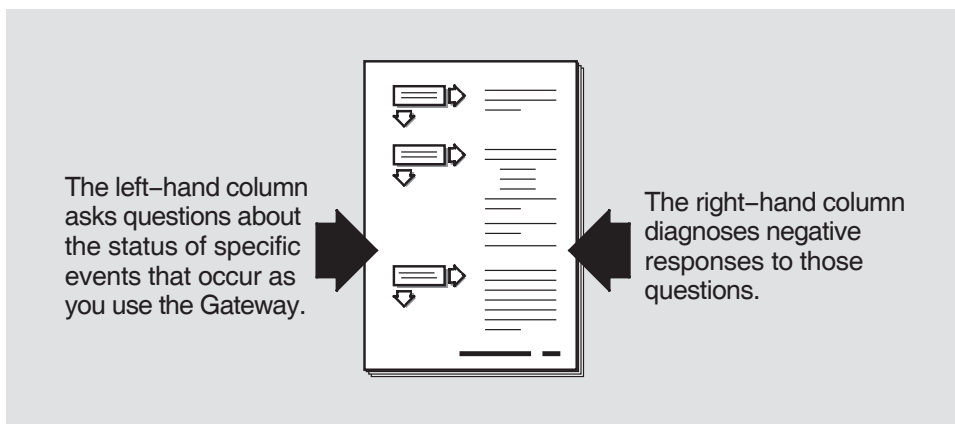

LKG-8276-93R

After you isolate the problem, Chapter 2 (for OpenVMS) and Chapter 3 (for ULTRIX) refer you to other chapters for instructions on using the various problem solving tools and utilities. Chapter 2 (for openVMS) and Chapter 3 (for ULTRIX) also refer you to other manuals for more complete diagnostic information for particular devices and software products.

You could experience problems that are not documented in this manual when you use Gateway-CT with complementary DECnet SNA products. Each access routine has its own manual or set of manuals which may describe other solutions not provided here.

1.2 Checking the System Before Problem Solving

Before you start problem solving, make sure that the communications hardware is ready for use. Verify the following:

- The ChannelServer's physical cable connections (the Ethernet connection, the transceiver connection, and the channel cables) are properly installed. See the documentation for your communications hardware device.
- The person responsible for managing the SNA network is ready for your system to communicate with the IBM host.
- The installation parameters are correct for your line to the IBM host. See *DECnet SNA Gateway-CT Installation (OpenVMS)* or *DECnet SNA Gateway-CT Installation (ULTRIX)*.
- Event logging is enabled in order to monitor the events generated by the Gateway-CT. See ~ or ~ for information about starting event logging and for descriptions of the event messages.

1.3 Reporting the Problem

If you cannot solve the problem by using the diagnostic map and the other problem-solving tools in this manual, report your problem if you have a support service contract. Chapter 6 tells you how to gather documentary evidence and report the problem to Digital.

Solving Gateway-CT Problems (OpenVMS)

This chapter discusses problems that may occur as you manage the Gateway-CT and its related products from an OpenVMS operating system:

- If your Gateway is not operational, start your problem solving effort with at the beginning of the procedure.
- If your Gateway is operational but you are experiencing errors while you are trying to use it, begin with later in this chapter.

If you have trouble solving your problem, check the IBM and Digital documentation for the product you are using. Also check the product release notes for up-to-date information on known problems.

For information about interpreting OpenVMS and DECnet error messages, refer to *OpenVMS System Messages and Recovery Procedures*.

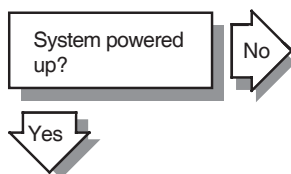

Power up the ChannelServer.

See your DEC ChannelServer or DEC ChannelServer II documentation for additional information.

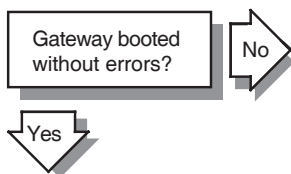

See the solutions for .

If you receive "Aborted service request" event messages and your Gateway-CT is booted, the events are the result of other systems' requests for services from your load host. These messages have no bearing on the Gateway-CT.

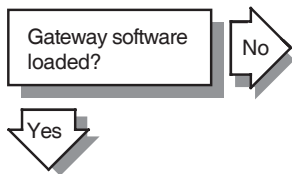

If the Gateway-CT software did not load properly, complete the following steps:

1. Ensure that the load host is running properly. Try to reload the Gateway-CT.
2. Check that each load host has a physical connection to the same Ethernet as the ChannelServer.
3. Verify that each load host has a database entry for the ChannelServer. Identify the load host(s), and then from the load host, perform the following:

- **with NCP:**

Invoke NCP, and then enter:

```
NCP>TELL lhnn SHOW NODE gnn CHARACTERISTICS
```

- **and with NCL:**

Invoke NCL, and then enter:

```
NCL>SHOW MOP CLIENT * ALL
```

If the system displays "No information available," then this particular system has not been set up to load the Gateway. *DECnet SNA Gateway-CT Installation (OpenVMS)* explains how to define the system as a load host.

If this system is a load host, check the following items in the display information:

- DECnet node address
- Service circuit
The service circuit name must match the name of the circuit on the load host to which the Gateway-CT is connected.
- Hardware address
The hardware address (twelve hexadecimal digits) should match the Ethernet address of the ChannelServer. Use one of the following methods to find the ChannelServer's Ethernet address:

- Look at the label on the door of the ChannelServer.
- Remove the door of the ChannelServer. Set the Halt Enable/Disable switch to Enable (dot inside circle), and press the console terminal break key.

The console terminal prompts

```
>>>
```

At the prompt, enter:

```
>>>E/W/P 20001920/N:5
```

The system displays

```
20001920 FF08
20001920 FF00
20001920 FF2B
20001920 FF0F
20001920 FF5B
20001920 FF96
>>>
```

You derive the Ethernet address by taking the last two hexadecimal digits of the lines displayed (08-00-2B-0F-5B-96 in the example).

Set the Halt Enable/Disable switch back to the Disable position (dot outside circle), and replace the door.

- If you have a DEC ChannelServer II, enter the following command at the console prompt:

```
>>>SHOW ETHERNET
```

The system displays

```
Ethernet Adaptor 0 (774440)
-XQA0 (08-00-2B-0F-5B-96)
>>>
```

Note

The SHOW ETHERNET command works only with the DEC ChannelServer II.

- Load file specification
Run the IVP to verify that the Gateway-CT software has been installed correctly on the load host. Check that the software load file (SNACSA021.SYS in SYS\$COMMON:[SNA\$CSV]) has the correct protection code (S:RWED, O:RWED, G, W).
Try to load the Gateway-CT software.

Phase V

Refer to the *DECnet/OSI NCL Reference Manual*, MOP and CSMA-CD modules, for Phase V information relating to steps 4 and 5.

4. Check the state of the line connecting the load host to the Gateway-CT. Invoke NCP and enter:
NCP>SHOW LINE *line-id* STATUS
If the line state is OFF, change the state to ON. Invoke NCP and enter:
NCP>SET LINE *line-id* STATE ON
The value of the *line-id* must be the same as the value of the service circuit previously displayed.
5. Check the state of the circuit that connects the load host to the Gateway-CT. Invoke NCP and enter:
NCP>SHOW CIRCUIT *circuit-id* STATUS
The value of the *circuit-id* must be the same as the value of the service circuit previously displayed.
The state of the service circuit must be ON and service must be enabled.

Note

Setting the circuit state OFF removes the load host from the network. Notify users that the network will be unavailable.

Set the state ON and enable service on the circuit. Invoke NCP and enter:

```
NCP>SET CIRCUIT circuit-id STATE OFF
NCP>SET CIRCUIT circuit-id SERVICE ENABLED
NCP>SET CIRCUIT circuit-id STATE ON
```

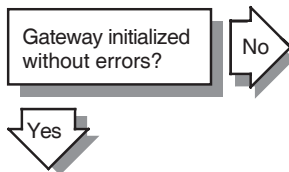

If the Gateway-CT initializes with errors, complete the following steps:

1. Review the event log and look for details of the failure. You should also check the MOM.LOG files in SYS\$MANAGER for error messages from the maintenance operation module (MOM).

Check if the proxy information is correct. Look for the following initialization message in NETSERVER.LOG in SYS\$COMMON:[SNA\$CSV]:

```
-----
Connect request received at date|time
from remote process gnn: "0=SNA$GO"
for object "SYS$COMMON:[SYSEXE]NML.EXE"
-----
```

2. The Gateway-CT may not be configured. If you configured the Gateway-CT, the following files appear in SYS\$COMMON:[SNA\$CSV]:

```
SNAGATEWAY_gnn_SNA.COM
SNAGATEWAY_gnn_DNA.COM
```

If the files do not appear in the directory, run the following procedure to configure the Gateway-CT:

```
$ @SYS$MANAGER:SNACSA$CONFIGURE
```

DECnet SNA Gateway-CT Installation (OpenVMS) provides information about the configuration procedure.

3. When the Gateway-CT was initialized, the SNAINI object did not run. This could be caused by the following:
 - Check to see if the SNAINI object has been defined. To do so **on Phase IV**, invoke NCP and enter:

```
NCP>SHOW OBJECT SNAINI CHARACTERISTICS
```

and **on Phase V**, invoke NCL and enter:

```
NCL>SHOW SESSION CONTROL application
SNAINI ALL
```

The following should display:

```
Object Volatile Characteristics as of date|time
Object = SNAINI
Number      = 39
File id     = SYS$COMMON:[SNA$CSV]SNAINI.COM
Proxy access = incoming
```

If the SNAINI object is not defined, create it by executing `DEFINE_gnn_ON_lhnn.COM`.

If you cannot find this file, execute Part 1 of `SNACSA$CONFIGURE`.

- Check the proxy account created during the Gateway-CT configuration. Invoke the OpenVMS AUTHORIZE utility and enter:

```
UAF>SHOW/PROXY gnn::SNA$GO
```

A message appears saying that the local proxy is SNA\$CSV:

```
Default proxies are flagged with (D)
gnn::SNA$GO
    SNA$CSV (D)
```

If this message does not appear, run Part 1 of the Gateway-CT configuration again.

Check if incoming proxies are enabled. Invoke NCP and enter:

```
NCP>SHOW EXECUTOR CHARACTERISTICS
```

If incoming proxies are not enabled, you should enable them. Invoke NCP and enter:

```
NCP>SET EXECUTOR INCOMING PROXY ENABLE
```

- If event logging reports that the SNAINI object is unknown at the remote node, you may have purged your network object database (by running the DECnet NETCONFIG.COM procedure, for example). Redefine the object by executing:

```
$ @SYS$COMMON:[SNA$CSV] -  
_ $ DEFINE_gnn_ON_lhnn.COM
```

Note

To access the Gateway-CT, you must be licensed to use DECnet. If DECnet is not enabled, you cannot set the lines and circuits to the ON state.

- When the Gateway-CT was initialized, the command procedure encountered errors in the SNA configuration file or could not read it. Event messages from SNAINI tell you where the initialization command procedure met a problem.
4. If the configuration file has become corrupted, rerun the following procedure:

```
$ @SYS$MANAGER:SNACSA$CONFIGURE
```
 5. Reload the ChannelServer.

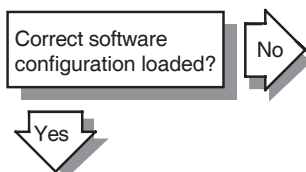

If you suspect that an incorrect software configuration was loaded, complete the following steps:

1. Check for "unknown" load hosts. On **Phase IV**, invoke NCP and enter:

```
NCP>TELL gnn SHOW EXECUTOR CHARACTERISTICS
```

The display shows which node loaded the ChannelServer. If you do not want that node to be a load host, delete the loading information from its DECnet database. Invoke NCP and enter:

```
NCP>CLEAR NODE gmn LOAD FILE
```

Reload the ChannelServer.

2. Log in to the node you think is defined as the load host and perform the following steps:

- Invoke NCP and enter:

```
NCP>SHOW NODE gmn CHARACTERISTICS
```

- Check the following items in the displayed information:

- DECnet node address
 - Service circuit
 - Hardware address
 - Load file specification

- Verify that the information displayed matches your expectations about the configuration. If not, correct any errors that you find and reload the system. See for more information about these items.

On **Phase V**, log in to the node you think is defined as the load host and perform the following steps:

- Invoke NCL and enter:

```
NCL>SHOW MOP CLIENT *** ALL
```

- Check the following items in the displayed information:

- DECnet node address
 - Service circuit
 - Hardware address
 - Load file specification

- Verify that the information displayed matches your expectations about the configuration. If not, correct any errors that you find and reload the system. See `Gateway initialized without errors?` for more information about these items.
3. Although you defined the component (line, circuit, PU, LU, or server) or access name correctly, you may have forgotten to reboot the Gateway-CT after you corrected the definitions. Check NETSERVER.LOG for errors.

Reboot the Gateway-CT. From a load host on **Phase IV**, invoke NCP and enter:

```
NCP>TRIGGER NODE gnn
```

If a service password has been defined for the Gateway-CT, you must specify it in the NCP TRIGGER command. For example,

```
NCP>TRIGGER NODE STAR -
_ SERVICE PASSWORD 1E3C41EAB32D3BCD
```

and for example on **Phase V**, invoke NCL and enter:

```
NCL>BOOT MOP CLIENT STAR -
_ VERIFICATION CD3B2DB3EA413C1E
```

Event messages displayed at load host when Gateway is booted?



If event messages are not displayed at the load host when the Gateway-CT boots, complete the following steps:

1. If you have more than one load host, event messages are sent to the load host that actually loaded the Gateway-CT. Find the host that loaded the Gateway-CT. Invoke NCP and enter:

```
NCP>TELL gnn SHOW EXECUTOR CHARACTERISTICS
```
2. OPCOM, EVL, and SNAEVL may not be running. If event logging is not running, events will not be logged. Check whether OPCOM, EVL, or SNAEVL is running by entering:

\$ SHOW SYSTEM

- If the display does not include EVL or SNAEVL, run the following command procedure:

```
$ @SYS$STARTUP:SNAGM$STARTUP
```

To ensure that Gateway-CT events are logged the next time the host system boots, insert the preceding command in the system startup file. Also verify that the following line in the system startup file is not commented out:

```
$ @SYS$STARTUP:SNAGM$EVL_STARTUP
```

~ provides more information about SNAEVL.

- If OPCOM is not running, start DECnet event logging on your system. Invoke NCP and enter:

```
NCP>SET LOGGING MONITOR STATE ON
```

The *OpenVMS Networking Manual* explains DECnet event logging in greater detail.

3. The logging state may not be enabled. Check the SNAEVL logging state. Invoke SNANCP and enter:

```
SNANCP> SHOW KNOWN LOGGING
```

Check the DECnet logging state. Invoke NCP and enter:

```
NCP>SHOW KNOWN LOGGING
```

If this command shows that some events are being filtered, disable filtering. Invoke NCP and enter:

```
NCP>SET LOGGING MONITOR KNOWN EVENTS
```

If the logging state for both SNAEVL and EVL is ON, you may not have enabled logging on your terminal. To enable logging, enter:

```
$ REPLY/ENABLE=NETWORK
```

If you do not receive event messages, check whether you have set your terminal to NOBROADCAST by entering:

```
$ SHOW TERMINAL
```

If the broadcast characteristics indicate NOBROADCAST, you cannot receive messages. If necessary, set your terminal to broadcast mode by entering:

```
$ SET TERMINAL/BROADCAST
```

If you still do not receive event messages, check whether you have screened out OPCOM messages by entering:

```
$ SHOW BROADCAST
```

If necessary, set broadcasting for OPCOM messages ON by entering:

```
$ SET BROADCAST=OPCOM
```

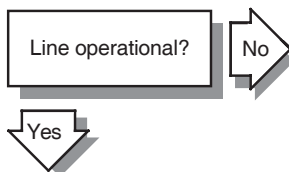

If the Gateway-CT loads, but some lines are not operational, complete the following steps:

1. Show the status of the line. Invoke SNANCP and enter:

```
SNANCP> SHOW LINE line-id
```

If the line was not defined, go to step 2.

If the line has been defined, go to step 3.

Note

It could take several minutes after booting for the Gateway-CT to correctly initialize. An event message indicates when the initialization is complete.

2. Verify that you executed Part 2 of the SNACSA\$CONFIGURE procedure and that SNAGATEWAY_*gnn*_SNA.COM in SYS\$COMMON:[SNA\$CSV] was created. Review the contents of this file, and check the SET LINE command for the line state. ~

explains the syntax of the SNANCP SET LINE command.

3. Check for SNAEVL event messages that indicate a problem with the configuration file.
4. If the SNANCP SHOW command shows that the line state is OFF, set the line state ON. Invoke SNANCP and enter:

```
SNANCP> SET LINE line-id STATE ON
```

To ensure that the Gateway-CT is initialized with the correct line state next time it is loaded, edit the SNA configuration file (SNAGATEWAY_*gnn*_SNA.COM in SYS\$COMMON:[SNA\$CSV]) on the load host.

If the line is in the on-starting state, the Gateway-CT cannot detect the operational-out signal from the channel. This could indicate that:

- The cables from the IBM system to the Gateway-CT are malfunctioning.
- The channel matrix switch is not connecting the Gateway-CT to the IBM system with which you are trying to communicate.
- The channel switch is malfunctioning.
- The channel is not working correctly.
- There are hardware problems in the channel interface.

If the line is in the on-disabled state, remove the door from the cabinet and set the Channel Enable/Disable switch on the ChannelServer to the Enable position.

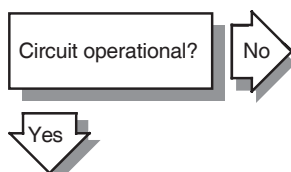

If the Gateway-CT boots, but the circuit is not operational, complete the following steps:

1. Make sure that your lines are operating correctly. See [Line operational?](#) for information about correcting line problems.

2. Show the status of the circuit. Invoke SNANCP and enter:

```
SNANCP> SHOW CIRCUIT circuit-id
```

If the circuit was not defined, go to step 3. If the circuit has been defined, go to step 4.

Note

Depending on the IBM system's load, it can take several minutes for the circuits to become active after you see the "initialization complete" event.

3. Verify that you executed Part 2 of the SNACSA\$CONFIGURE procedure and that SNAGATEWAY_*gnn*_SNA.COM in SYS\$COMMON:[SNA\$CSV] was created.
Review the contents of this file and check the SET CIRCUIT command in the file. ~ explains the syntax of the SNANCP SET CIRCUIT command.
4. Check for SNAEVL event messages that indicate a problem with the configuration file.
5. Ensure that the circuit is assigned to a line. Invoke SNANCP and enter:

```
SNANCP> SHOW CIRCUIT circuit-id CHARACTERISTICS
```

If necessary, assign the circuit to a line. Invoke SNANCP and enter:

```
SNANCP> SET CIRCUIT circuit-id STATE OFF  
SNANCP> SET CIRCUIT circuit-id LINE line-id  
SNANCP> SET CIRCUIT circuit-id STATE ON
```
6. If the circuit state is OFF, set the circuit state ON. Invoke SNANCP and enter:

```
SNANCP> SET CIRCUIT circuit-id STATE ON
```

To ensure that the Gateway-CT is initialized with the correct circuit state next time it is loaded, edit the SNA configuration file (SNAGATEWAY_ *gnn* _SNA.COM in SYS\$COMMON:[SNA\$CSV]) on the load host.

If the circuit is in the on-starting state, check that:

- The channel address is correct.
- The channel address and PU are activated.

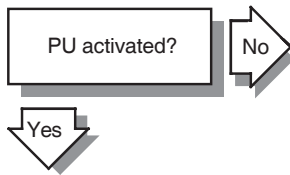

If the PU does not become active, complete the following steps:

1. Check that the circuit is in the on-starting state. See and for more information.

2. Show the status of the PU. Invoke SNANCP and enter:

```
SNANCP> SHOW PU pu-id
```

If the PU was not defined, go to step 3.

If the PU has been defined, go to step 4.

3. Verify that you executed Part 2 of the SNACSA\$CONFIGURE procedure and that SNAGATEWAY_ *gnn* _SNA.COM in SYS\$COMMON:[SNA\$CSV] was created.
Review the contents of this file, and check the SET PU command in the file. ~ explains the syntax of the SNANCP SET PU command.
4. Check for SNAEVL event messages that indicate a problem with the configuration file. Messages are found in NETSERVER.LOG in SYS\$COMMON:[SNA\$CSV].
5. If the SNANCP SHOW command indicates that the PU state is inactive, check the following:
 - The circuit is operational.
See for more information.

- The PU is assigned to a circuit. Invoke SNANCP and enter:

```
SNANCP> SHOW PU pu-id CHARACTERISTICS
```

If the PU is not assigned to a circuit, invoke SNANCP and enter:

```
SNANCP> SET PU pu-id CIRCUIT circuit-id
```

6. Ask the VTAM operator to verify that your channel address and PU have been activated without errors.

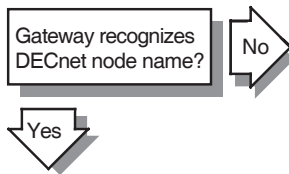

If the Gateway-CT does not recognize the DECnet node name you specify, complete the following steps:

1. If the node address is in the same area as the load host, it should be automatically copied to the Gateway-CT at load time (Phase IV only).
2. If a local node is not defined, the initialization procedure failed. Look for SNAEVL messages that provide more information about the problem.
3. For nodes outside the area, you can modify the Gateway-CT node's DECnet database while the Gateway-CT is running. Invoke NCP and enter:

```
NCP>SET EXECUTOR NODE gnn USER username -  
_ PASSWORD password
```

```
NCP>SET NODE node-address -  
_ NAME DECnet-node-name
```

You must ensure that a node outside the area is defined the next time the Gateway-CT is loaded. To do this on **Phase IV**, edit the node configuration file SNAGATEWAY_*gnn*_DNA.COM in SYS\$COMMON:[SNA\$CSV] on the load host, and on **Phase V**, you must include within the node configuration file SNAGATEWAY_*gnn*_DNA.COM in SYS\$COMMON:[SNA\$CSV], every node you want the gateway to know about.

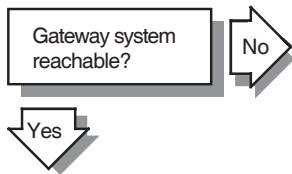

If the Gateway-CT system is not reachable, complete the following steps:

1. Your DECnet network may not be functioning properly. Check with your DECnet system manager.
2. There may be a problem with either your DECnet node or the Gateway-CT node.
 - Try to access your DECnet node from another node in the network. If you cannot access your DECnet node, notify your DECnet system manager.
 - Try to access the Gateway-CT from another node in the network. If you cannot access the Gateway-CT, ensure that the Gateway-CT software is correctly installed and configured. Also verify that the ChannelServer is working properly.
3. Ensure that the Gateway-CT software is installed and configured correctly.
4. Your DECnet network may not be configured correctly. Check that your load host has the Gateway-CT DECnet node address defined correctly. For **Phase IV**, invoke NCP and enter:
NCP>SHOW NODE *gnn*
and for **Phase V**, refer to the *DECnet/OSI Network Management* book for this information.
Check that the node address which is displayed matches the node address in the configuration file `DEFINE_gnn_ON_lhnn.COM` in `SYS$COMMON:[SNA$CSV]`.
If it does not match, execute Part 1 of the `SNACSA$CONFIGURE` procedure again.
5. Run DECnet NCP loopback tests to check the communications hardware and software from the DECnet Management node to the Gateway-CT. See Chapter 4.

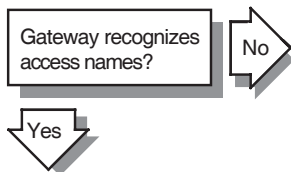

If the Gateway-CT does not recognize the access names you specify, the access names you want to use may not be defined on your Gateway-CT. To obtain a list of access names defined on your Gateway-CT, invoke SNANCP and enter:

```
SNANCP> SHOW KNOWN ACCESS NAMES
```

For full information about access name characteristics, invoke SNANCP and enter:

```
SNANCP> SHOW KNOWN ACCESS NAME CHARACTERISTICS
```

Define the appropriate access names on the Gateway-CT node. Invoke SNANCP and enter:

```
SNANCP> SET ACCESS NAME access-name-id
```

~ explains how to use SNANCP commands to define access names.

To ensure that the Gateway-CT is initialized with the correct access names next time it is loaded, edit the SNA configuration file (SNAGATEWAY_*gnn*_SNA.COM in SYS\$COMMON:[SNA\$CSV]) on the load host.

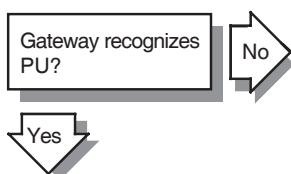

If the Gateway-CT does not recognize the PU you specify, the PU you want to use may not be defined on your Gateway-CT. Use the SNANCP command SHOW KNOWN PUS to determine whether the PU you want to use is defined on the Gateway-CT node and is active.

If the PU name is not defined, define it by invoking SNANCP and entering:

```
SNANCP> SET PU pu-id
```

~ explains how to use SNANCP commands to define PUs.

To ensure that the Gateway-CT is initialized with this PU next time it is loaded, edit the SNA configuration file (SNAGATEWAY_*gnn*_SNA.COM in SYS\$COMMON:[SNA\$CSV]) on the load host.

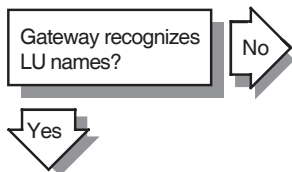

If the Gateway-CT does not recognize the LU names you specify, complete the following steps:

1. Check that the PU name is defined.
See [Gateway recognizes PU?](#) for more information about specifying PU names.
2. The LUs you want to use may not be defined on your Gateway-CT. Use the SNANCP command `SHOW KNOWN LUS` to determine whether the LUs you want to use are defined and are active. If the LUs are not defined, define them on the Gateway-CT by invoking SNANCP and entering:

```
SNANCP> SET PU pu-id LU LIST lu-list
```

~ explains how to use SNANCP commands to define LUs.

To ensure that the Gateway-CT is initialized with these LUs next time it is loaded, edit the SNA configuration file (`SNAGATEWAY_gnn_SNA.COM` in `SYS$COMMON:[SNA$CSV]`) on the load host.

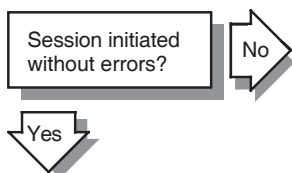

If the system does not respond when you try to initiate a session even after a reasonable wait, complete the following steps:

1. Your process quotas may be inadequate. To check your quotas, use the DCL command `SHOW PROCESS/QUOTAS`.
See [Session progresses without hanging](#) for additional information.
2. There may be a problem with the IBM system. The IBM system may be busy, or there may be an IBM configuration problem either with VTAM or with the application with which you are trying to communicate.

If you receive error messages when you initiate a session, complete the following steps:

1. Check the product documentation for the access routine you are trying to use. Error messages that relate to a particular access routine are

explained in the respective access routine manual.

2. If the error message states that the Gateway-CT node is unknown, verify this by invoking NCP and entering:

```
NCP>SHOW NODE gnn
```

If the Gateway-CT node is unknown, define it by invoking NCP and entering:

```
NCP>SET NODE node-address NAME gnn
```

See for more information.

3. If the error message states that there is no such SNA component (line, circuit, PU, LU, access name, or server), you may have either specified the component name incorrectly or specified an undefined component name.
4. If the error message states that access is rejected due to authorization failure, check the authorized users for the LU specified in the error message. Invoke SNANCP and enter:

```
SNANCP> SHOW LU lu-id KNOWN AUTHORIZATION
```

Modify the authorization entries, if necessary. ~ provides more information on LU security and authorization.
5. If you receive a message indicating that the line or circuit is not active, follow the solutions in and .
6. You may also receive an error message indicating that your session is not active. This message means the Gateway-CT has not received an ACTLU (activate logical unit) request. Check the state of the LU by invoking SNANCP and entering:

```
SNANCP> SHOW LU lu-id
```

If the LU is not active, ask your IBM system programmer to activate it.

7. If an error message containing an IBM sense code appears, it probably indicates a session problem. Verify that your application id and session parameters are correct. (Receiving an IBM sense code indicates that the lines, circuits, PUs, and LUs are functioning normally.)

The IBM manual *Systems Network Architecture Formats* lists the sense codes.

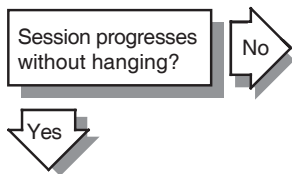

If the session hangs, there are four possible causes:

1. The IBM system may not be reachable from the Gateway-CT.
See for more information.
2. DECnet problems may be occurring between the load host and the Gateway-CT.
See for more information.
3. The IBM host may not be working properly or may be overloaded.
See for more information.
4. Your OpenVMS process quotas may be inadequate.
See your access routine documentation for product-specific information.

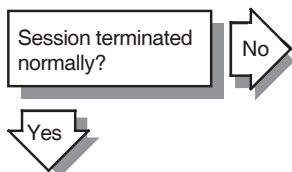

If sessions terminate abnormally, complete the following steps:

1. You may not have used the correct buffer size when you configured the Gateway-CT. Check the circuit counters by invoking SNANCP and entering:

```
SNANCP> SHOW KNOWN CIRCUITS COUNTERS
```

If the display includes the following message, increase the buffer size to a value that exceeds the maximum RU size by at least 9 bytes:

- 1 Process errors, including
Data length error

Use the SNANCP command SET LINE to change the buffer size. ~ explains how to use this command. To ensure that the correct buffer size is used next time the Gateway is loaded, edit the SNA configuration file (SNAGATEWAY_gnn_SNA.COM in SYS\$COMMON:[SNA\$CSV]) on the load host.

2. Ask your VTAM operator if the network was shut down.

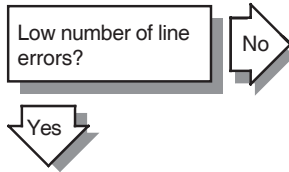

If an excessive number of line errors occur, complete the following steps:

1. A certain number of local buffer errors always occur when the PUs and LUs are activated. Therefore, after the PUs are activated, use the SNANCP command ZERO to set the line counters to zero.

If you notice that the following counter is incremented frequently during normal operation, increase the RECEIVE BUFFERS parameter:

- 573 Local buffer errors, including:
Receive buffer ring empty

2. If the display includes the following messages, check that the Gateway-CT and the IBM system were configured properly:

- 19 Channel errors, including:
System resets
Selective resets
Halt I/Os

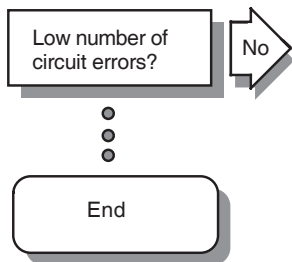

If an excessive number of circuit errors occur, complete the following steps:

1. If the line `BUFFER SIZE` parameter is not large enough to receive all the data written to the channel, the following display appears:
3 Remote process errors, including:
Data length error
Use the `SNANCP` command `SET LINE` to increase the value of the `BUFFER SIZE` parameter. The specified size must exceed the maximum RU size by at least 9 bytes.
2. Verify that the Gateway-CT and the IBM host definitions were configured correctly.

3

Solving Gateway-CT Problems (ULTRIX)

This chapter discusses problems that may occur as you manage the Gateway-CT and its related products from an ULTRIX operating system:

- If your Gateway is not operational, start your problem solving effort with at the beginning of the procedure.
- If your Gateway is operational but you are experiencing errors while you are trying to use it, begin with later in this chapter.

If you have trouble solving your problem, check the IBM and Digital documentation for the product you are using. Also check the product release notes for up-to-date information on known problems.

For information about interpreting DECnet-ULTRIX error messages, refer to DECnet-ULTRIX documentation as listed in the preface of this manual. For information about general ULTRIX errors, see online reference pages: man pages.

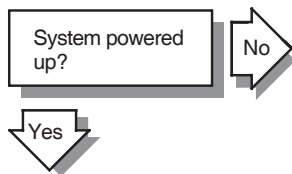

Power up the ChannelServer.

See your DEC ChannelServer or DEC ChannelServer II documentation for additional information.

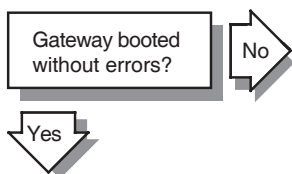

See the solutions for .

If you receive "Aborted service request" event messages and your Gateway-CT is booted, the events are the result of other systems' requests for services from your load host. These messages have no bearing on the Gateway-CT.

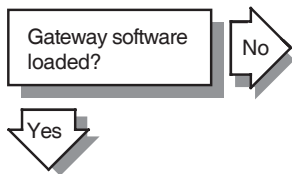

If the Gateway-CT software did not load properly, complete the following steps:

1. Ensure that the load host is running properly. Try to reload the Gateway-CT.
2. Check that each load host has a physical connection to the same Ethernet as the ChannelServer.
3. Verify that each load host has a database entry for the ChannelServer. Identify the load host(s), and then perform the following:

- Invoke `ncp`, and then enter:

```
ncp>tell lhnn show node gnn characteristics
```

If the system displays "No information available," then this particular system has not been set up to load the Gateway. *DECnet SNA Gateway-CT Installation (ULTRIX)* explains how to define the system as a load host.

If this system is a load host, check the following items in the display information:

- DECnet node address
- Service circuit

The service circuit name must match the name of the circuit on the load host to which the Gateway-CT is connected.

- Hardware address

The hardware address (twelve hexadecimal digits) should match the Ethernet address of the ChannelServer. Use one of the following methods to find the ChannelServer's Ethernet address:

- Look at the label on the door of the ChannelServer.
- Remove the door of the ChannelServer. Set the Halt Enable/Disable switch to Enable (dot inside circle), and press the console terminal break key.

The console terminal prompts

```
>>>
```

At the prompt, enter:

```
>>>E/W/P 20001920/N:5
```

The system displays

```
20001920 FF08
20001920 FF00
20001920 FF2B
20001920 FF0F
20001920 FF5B
20001920 FF96
>>>
```

You derive the Ethernet address by taking the last two hexadecimal digits of the lines displayed (08-00-2B-0F-5B-96 in the example).

Set the Halt Enable/Disable switch back to the Disable position (dot outside circle), and replace the door.

- If you have a DEC ChannelServer II, enter the following command at the console prompt:

```
>>>SHOW ETHERNET
```

The system displays

```
Ethernet Adaptor 0 (774440)
-XQA0 (08-00-2B-0F-5B-96)
>>>
```

Note

The show ethernet command works only with the DEC ChannelServer II.

- Load file specification

Check that the software load file snacsa210.sys in /usr/lib/snagwy has the correct protection code: (-rwxr-xr-x).

- The Service parameter must equal Enable.
- Run the IVP to verify that the Gateway-CT software has been installed correctly on the load host.

For example, on a VAX processor, enter:

```
# setld -v CTVBASE210
```

4. Check the state of the line connecting the load host to the Gateway-CT. Invoke `ncp` and enter:

```
ncp>show line line-id status
```

If the line state is OFF, change the state to ON. Invoke `ncp` and enter:

```
ncp>set line line-id state on
```

The value of the *line-id* must be the same as the value of the service circuit previously displayed.
5. Check the state of the circuit that connects the load host to the Gateway-CT. Invoke `ncp` and enter:

```
ncp>show circuit circuit-id status
```

The value of the *circuit-id* must be the same as the value of the service circuit previously displayed.

If the circuit state is OFF, set the state to ON. Invoke `ncp` and enter:

```
ncp>set circuit circuit-id state on
```
6. Check that the `mop_mom` process for down-line load and up-line dump requests on the load host is present.

Issue the following command:

```
% ps -ax | grep mop_mom
```

If the process is not found, log in as superuser and start the process by issuing the command:

```
# /etc/mop_mom
```
7. Try to load the Gateway-CT software.

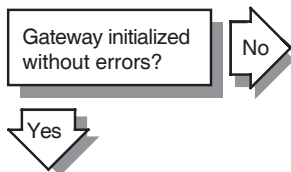

If the Gateway-CT initializes with errors, complete the following steps:

1. Review the event log, which is written to `/dev/console` by default, and look for details of the failure. You should also check the system log which may contain information about failed connects. By default, the log is `/var/spool/mqueue/syslog`. The naming and location of this log file is controlled by the `/etc/syslog.conf` file.

The following example shows a set of error messages that may be generated and written to `syslog` if the `snaini` object is not defined on the ULTRIX host:

```
-----
Jan 7 04:05:03 localhost:3848
dnet_spawner:
Connect from 55.192::SNA$GO for object 39
Jan 7 04:05:03 localhost:3848
dnet_spawner:
Connection rejected - No such object (39)
Jan 7 04:05:03 localhost:56 dnet_spawner:
Process exit (PID 3848), status
EX_UNAVAILABLE
-----
```

2. The Gateway-CT may not be configured. If you configured the Gateway-CT, the following files appear:

```
/var/snagwy/snagateway_gnn_sna
/var/snagwy/snagateway_gnn_dna
```

If the files do not appear in the directory, log in as superuser and run the following utility to configure the Gateway-CT:

```
# /usr/etc/snaconfig
```

DECnet SNA Gateway-CT Installation (ULTRIX) provides information about the configuration procedure.

3. When the Gateway-CT was initialized, the snaini object did not run. This could be caused by the following:

- The snaini object may not be defined. To see if it is defined, invoke ncp and enter:
ncp>show object snaini characteristics

The following should display:

```
Object Volatile Characteristics as of date|time
Object = SNAINI
Number      = 39
File id     = /usr/etc/snaini
Type       = Sequenced Packet
Accept     = Immediate
```

If the snaini object is not defined, create it by executing:

```
# /var/snagwy/define_gnn_on_lhnn
```

If you cannot find this file, execute Part 1 of the snaconfig utility.

- DECnet-ULTRIX controls proxy access through a proxy file: /etc/dnet_proxy

Each line in the file is a proxy and is formatted:

```
source-node::source-login-name
destination-login-name object
```

For example:

```
# ragged::sna$go daemon snaini
```

If there is a problem, the /etc/dnet_proxy file contents should be checked.

- Check that incoming proxies are enabled. Invoke ncp and enter:

```
ncp>show executor characteristics
```

If incoming proxies are not enabled, enable them by entering:

```
ncp>set executor incoming proxy enable
```

- When the Gateway-CT was initialized, the command procedure encountered errors in the SNA configuration file or could not read it. Event messages from snaini tell you where the initialization command procedure met a problem.
4. If the configuration file has become corrupted, log in as superuser and rerun the following procedure:

```
# /usr/etc/snaconfig
```
 5. Reload the ChannelServer.

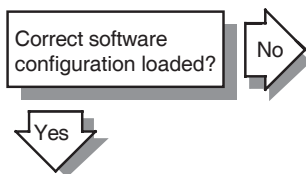

If you suspect that an incorrect software configuration was loaded, complete the following steps:

1. Check for "unknown" load hosts. Invoke ncp and enter:

```
ncp>tell gnn show executor characteristics
```

The display shows which node loaded the ChannelServer. Check the Host parameter in the Executor Volatile Characteristics display. If you do not want that node to be a load host, delete the loading information from its DECnet database. Invoke ncp and enter:

```
ncp>set executor node lhnn/privuser/secret
ncp>clear node gnn load file
```

Reload the ChannelServer.
2. Log in to the node you think is defined as the load host and perform the following steps:
 - Invoke ncp and enter:

```
ncp>show node gnn characteristics
```
 - Check the following items in the displayed information:
 - Remote node
 - Service circuit
 - Hardware address
 - Load file specification

Service
Dump file specification

- Verify that the information displayed matches your expectations about the configuration. If not, correct any errors that you find and reload the system. See `Gateway software loaded?` for more information about these items.

3. Although you may have defined the component (line, circuit, PU, LU, server, or access name) correctly in the configuration file, you may have forgotten to reboot the Gateway-CT after you corrected the definitions.

Reboot the Gateway-CT. From a load host, invoke `ncp` and enter:

```
ncp>trigger node gnn
```

If a service password has been defined for the Gateway-CT, you must specify it in the `ncp trigger` command. For example,

```
% ncp trigger node star \  
service password 1e3c41eab32d3bcd
```

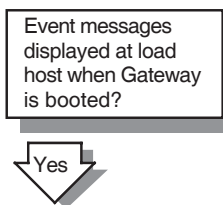

If event messages are not displayed at the load host when the Gateway-CT boots, complete the following steps:

1. If you have more than one load host, event messages are sent to the load host that actually loaded the Gateway-CT. Find the host that loaded the Gateway-CT. Invoke `ncp` and enter:

```
ncp>tell gnn show executor characteristics
```

2. The default event sink for both DECnet and DECnet SNA is `/dev/console`. Enter the following command for information about both `evl` and `snaevl`:

```
% ps -aux | grep evl
```

Note

Because `snaevl` uses the `dnet-spawner`, it is never explicitly started by the user and may not appear when a `ps -aux` command is executed.

`~` provides more information about `snaevl`.
DECnet-ULTRIX Network Management provides more information about `evl`.

3. The logging state may not be enabled. Check the DECnet SNA logging state. Invoke `snanpcp` and enter:

```
snanpcp> show known logging
```

Check the DECnet logging state. Invoke `ncp` and enter:

```
ncp>show known logging
```

If this command shows that some events are being filtered, disable filtering. Invoke `ncp` and enter:

```
ncp>set logging console known events
```

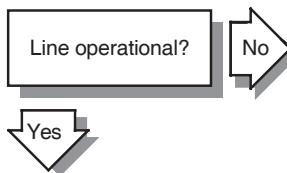

If the Gateway-CT loads, but the line is not operational, complete the following steps:

1. Show the status of the line. Invoke `snanpcp` and enter:

```
snanpcp> show line line-id
```

Note

It could take several minutes after booting for the Gateway-CT to correctly initialize.

An event message indicates when the initialization is complete.

2. Verify that you executed Part 2 of the `snaconfig` procedure and that `snagateway_gnn_sna` in `/var/snagwy` was created.

Review the contents of this file, and check the `set line` command for the line state. `~` explains the syntax of the `snancp set line` command.

3. Check for `snaevl` event messages that indicate a problem with the configuration file.
4. If the `snancp show` command shows that the line state is OFF, set the line state ON. Invoke `snancp` and enter:

```
snancp> set line line-id state on
```

To ensure that the Gateway-CT is initialized with the correct line state next time it is loaded, edit the SNA configuration file `snagateway_gnn_sna` in `/var/snagwy` on the load host.

If the line is in the on-starting state, the Gateway-CT cannot detect the operational-out signal from the channel. This could indicate that:

- The cables from the IBM system to the Gateway-CT are malfunctioning.
- The channel matrix switch is not connecting the Gateway-CT to the IBM system with which you are trying to communicate.
- The channel switch is malfunctioning.
- The channel is not working correctly.
- There are hardware problems in the channel interface.

If the line is in the on-disabled state, remove the door from the cabinet and set the Channel Enable/Disable switch on the ChannelServer to the Enable position.

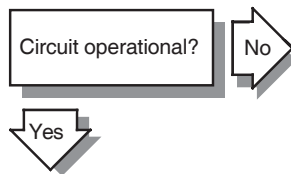

If the Gateway-CT boots, but the circuit is not operational, complete the following steps:

1. Make sure that your lines are operating correctly. See [Line operational?](#) for information about correcting line problems.
2. Show the status of the circuit. Invoke `snanpc` and enter:

```
snanpc> show circuit circuit-id
```

If the circuit was not defined, go to step 3. If the circuit has been defined, go to step 4.

Note

Depending on the IBM system's load, it can take several minutes for the circuits to become active after you see the "initialization complete" event.

3. Verify that you executed Part 2 of the `snaconfig` procedure and that `/var/snagwy/snagateway_gnn_sna` was created.
Review the contents of this file and check the `set circuit` command in the file. `~` explains the syntax of the `snanpc set circuit` command.
4. Check for `snaevl` event messages that indicate a problem with the configuration file.
5. Ensure that the circuit is assigned to a line. Invoke `snanpc` and enter:

```
snanpc> show circuit circuit-id characteristics
```

If necessary, assign the circuit to a line. Invoke `snanpc` and enter:

```
snancp> set circuit circuit-id state off
snancp> set circuit circuit-id line line-id
snancp> set circuit circuit-id state on
```

6. If the circuit state is OFF, set the circuit state ON. Invoke snancp and enter:

```
snancp> set circuit circuit-id state on
```

To ensure that the Gateway-CT is initialized with the correct circuit state next time it is loaded, edit the SNA configuration file `/var/snagwy/snagateway_gnn_sna` on the load host.

If the circuit is in the on-starting state, check that:

- The channel address is correct.
- The channel address and PU are activated.

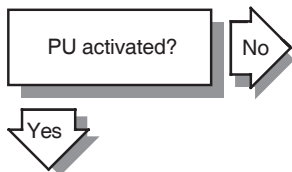

If the PU does not become active, complete the following steps:

1. Check that the circuit is in the on-starting state. See `Line operational?` and `Circuit operational?` for more information.
2. Show the status of the PU. Invoke snancp and enter:

```
snancp> show pu pu-id
```

If the PU was not defined, go to step 3.
If the PU was defined, go to step 4.
3. Verify that you executed Part 2 of the snaconfig procedure and that `/var/snagwy/snagateway_gnn_sna` was created.

Review the contents of this file, and check the `set pu` command in the file. `~` explains the syntax of the snancp `set pu` command.

4. Check for gateway event messages that indicate a problem with the configuration file. Gateway events by default are logged to the `/dev/console` device. Also check the `syslog` file for messages that relate to gateway components. By default, the system log file is written to `/var/spool/mqueue/syslog`.
5. If the `snanpc show` command indicates that the PU state is inactive, check the following:
 - The circuit is operational.
See `Circuit operational?` for more information.
 - The PU is assigned to a circuit. Invoke `snanpc` and enter:

```
snanpc> show pu pu-id characteristics
```

 If the PU is not assigned to a circuit, invoke `snanpc` and enter:

```
snanpc> set pu pu-id circuit circuit-id
```
6. Ask the VTAM operator to verify that your channel address and PU have been activated without errors.

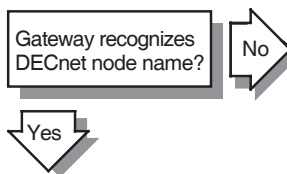

If the Gateway-CT does not recognize the DECnet node name you specify, complete the following steps:

1. If the node address is in the same area as the load host, it should be automatically copied to the Gateway-CT at load time.
2. If a local node is not defined, the initialization procedure failed. Look for `snaevl` messages that provide more information about the problem.
3. For nodes outside the area, you can modify the Gateway-CT node's DECnet database while the Gateway-CT is running. Invoke `ncp` and enter:

```
ncp>set exec node gnn user username password passwd
ncp>set node node-address name DECnet-node-name
```

To ensure that a node outside the area is defined the next time the Gateway-CT is loaded, edit the node configuration file `/var/snagwy/snagateway_gnn_dna` on the load host.

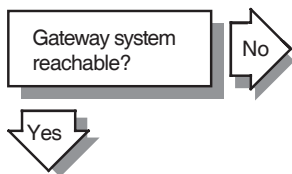

If the Gateway-CT system is not reachable, complete the following steps:

1. Your DECnet network may not be functioning properly. Check with your DECnet system manager.
2. There may be a problem with either your DECnet node or the Gateway-CT node.
 - Try to access your DECnet node from another node in the network. If you cannot access your DECnet node, notify your DECnet system manager.
 - Try to access the Gateway-CT from another node in the network. If you cannot access the Gateway-CT, ensure that the Gateway-CT software is correctly installed and configured. Also verify that the ChannelServer is working properly.
3. Ensure that the Gateway-CT software is installed and configured correctly.
4. Your DECnet network may not be configured correctly. Check that your load host has the Gateway-CT DECnet node address defined correctly. Invoke `ncp` and enter:

```
ncp>show node gnn
```

Check that the node address which is displayed matches the node address in the configuration file `define_gnn_on_lhnn` in `/var/snagwy`.

If it does not match, execute Part 1 of the `snaconfig` procedure again.

5. Run DECnet ncp loopback tests to test the communications hardware and software from the DECnet Management node to the Gateway-CT. See Chapter 4.

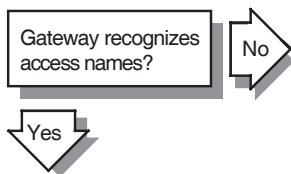

If the Gateway-CT does not recognize the access names you specify, the access names you want to use may not be defined on your Gateway-CT. To obtain a list of access names defined on your Gateway-CT, invoke `snanpcp` and enter:

```
snanpcp> show known access names
```

For full information about access name characteristics, invoke `snanpcp` and enter:

```
snanpcp> show known access name characteristics
```

Define the appropriate access names on the Gateway-CT node. Invoke `snanpcp` and enter:

```
snanpcp> set access name access-name-id
```

~ explains how to use `snanpcp` commands to define access names.

To ensure that the Gateway-CT is initialized with the correct access names next time it is loaded, edit the SNA configuration file `/var/snagwy/snagateway_gnn_sna` on the load host.

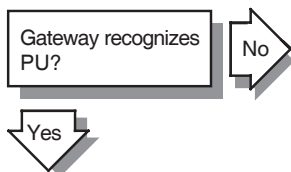

If the Gateway-CT does not recognize the PU you specify, the PU you want to use may not be defined on your Gateway-CT. Use the `snanpcp` command `show known pus` to determine whether the PU you want to use is defined on the Gateway-CT node and is active.

If the PU name is not defined, define it by invoking `snanpcp` and entering:

```
snanpcp> set pu pu-id
```

~ explains how to use `snanpcp` commands to define PUs.

To ensure that the Gateway-CT is initialized with this PU next time it is loaded, edit the SNA configuration file `/var/snagwy/snagateway_gnn_sna` on the load host.

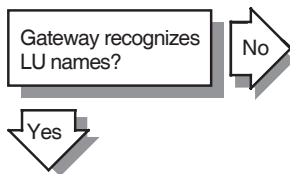

If the Gateway-CT does not recognize the LU names you specify, complete the following steps:

1. Check that the PU name is defined.
See `Gateway recognizes PU?` for more information about specifying PU names.
2. The LUs you want to use may not be defined on your Gateway-CT. Use the `snancp` command `show known lus` to determine whether the LUs you want to use are defined and are active. If the LUs are not defined, define them on the Gateway-CT by invoking `snancp` and entering:

```
snancp> set pu pu-id lu list lu-list
```

~ explains how to use `snancp` commands to define LUs.

To ensure that the Gateway-CT is initialized with these LUs next time it is loaded, edit the SNA configuration file `/var/snagwy/snagateway_gnn_sna` on the load host.

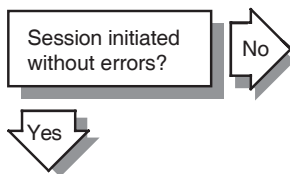

If the system does not respond when you try to initiate a session even after a reasonable wait, consider the following:

- There may be a problem with the IBM system.
- The IBM system may be busy.
- There may be an IBM configuration problem either with VTAM or with the application with which you are trying to communicate.

If you receive error messages when you initiate a session, complete the following steps:

1. Check the product documentation for the access routine you are trying to use. Error messages that relate to a particular access routine are explained in the respective access routine manual.

2. If the error message states that the Gateway-CT node is unknown, verify this by invoking `ncp` and entering:

```
ncp>show node gnn
```

If the Gateway-CT node is unknown, define it by invoking `ncp` and entering:

```
ncp>set node node-address name gnn
```

Then enter:

```
ncp>define node node-address name gnn
```

See for more information.

3. If the error message states that there is no such SNA component (line, circuit, PU, LU, access name, or server), you may have either specified the component name incorrectly or specified an undefined component name.

4. If the error message states that access is rejected due to authorization failure, check the authorized users for the LU specified in the error message. Invoke `snancp` and enter:

```
snancp> show lu lu-id known authorization
```

Modify the authorization entries, if necessary. `~` provides more information on LU security and authorization.

5. If you receive a message indicating that the line or circuit is not active, follow the solutions in and .

6. You may also receive an error message indicating that your session is not active. This message means the Gateway-CT has not received an ACTLU (activate logical unit) request. Check the state of the LU by invoking `snanpc` and entering:

```
snanpc> show lu lu-id
```

If the LU is not active, ask your IBM system programmer to activate it.

7. If an error message containing an IBM sense code appears, it probably indicates a session problem. Verify that your application id and session parameters are correct. (Receiving an IBM sense code indicates that the lines, circuits, PUs, and LUs are functioning normally.)

The IBM manual *Systems Network Architecture Formats* lists the sense codes.

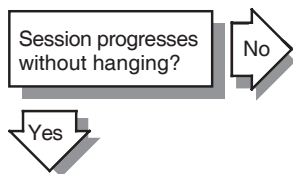

If the session hangs, there are three possible causes:

1. The IBM system may not be reachable from the Gateway-CT.
See for more information.
2. DECnet problems may be occurring between the load host and the Gateway-CT.
See for more information.
3. The IBM host may not be working properly or may be overloaded.
See for more information.

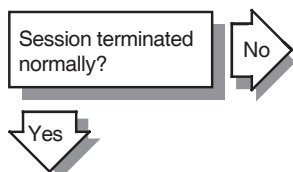

If sessions terminate abnormally, complete the following steps:

1. You may not have used the correct buffer size when you configured the Gateway-CT. Check

the circuit counters by invoking `snanpcp` and entering:

```
snanpcp> show known circuits counters
```

The display may include a message like the following:

- 1 Process errors, including
Data length error

If so, increase the buffer size so that its value exceeds the maximum RU size by at least 9 bytes. Use the `snanpcp` command `set line` to change the buffer size. `~` explains how to use this command. To ensure that the correct buffer size is used next time the Gateway is loaded, edit the SNA configuration file `/var/snagwy/snagateway_gnn_sna` on the load host.

2. Ask your VTAM operator if the network was shut down.

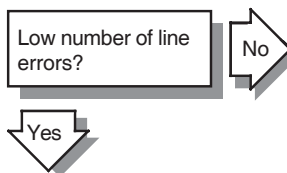

If an excessive number of line errors occur, complete the following steps:

1. A certain number of local buffer errors always occur when the PUs and LUs are activated. Therefore, after the PUs are activated, use the `snanpcp` command `zero` to set the line counters to zero.

If you notice that the following counter is incremented frequently during normal operation, invoke `snanpcp`:

```
show line line-id counters
```

The following is an example display:

```
573 Local buffer errors, including:  
Receive buffer ring empty
```

In this case, increase the receive buffers parameter.

2. The display may include a message like the following:

19 Channel errors, including:

System resets
Selective resets
Halt I/Os

If so, check that the Gateway-CT and the IBM system were configured properly.

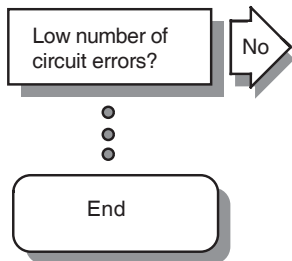

If an excessive number of circuit errors occur, complete the following steps:

1. If the line's buffer size parameter is not large enough to receive all the data written to the channel, invoke `snanpc`:

```
snanpc> show circuit circuit-id counters
```

A display like the following appears:

```
3 Remote process errors, including:  
Data length error
```

Use the `snanpc` command `set line` to increase the value of the buffer size parameter. The specified size must exceed the maximum RU size by at least 9 bytes.

2. Verify that the Gateway-CT and the IBM host definitions were configured correctly.

4

Testing the Network (OpenVMS and ULTRIX)

This chapter contains **Phase IV** information only. Refer to the *DECnet/OSI Network Management* book for **Phase V** information.

The Network Control Program (NCP) provides several kinds of tests to help you determine whether the network is operating properly. These tests allow you to exercise network software and hardware by sending data through various network components and then returning that data to its source. If you have been receiving DECnet error messages, you may want to run these tests.

Before you run these tests, verify that the Gateway-CT node is on the same DECnet network as the node from which you want to run the tests.

For OpenVMS, invoke NCP:

```
$ RUN SYS$SYSTEM:NCP
```

For ULTRIX, invoke ncp:

```
% ncp
```

You can then use these tests to check the software and the hardware between the DECnet node and the Gateway-CT.

The tests fall into two categories: node-level loopback tests and the circuit-level loopback test. Use node-level tests to evaluate the operation of logical links and other network-related software. Use the circuit-level test to evaluate the operation of circuits. You should use node-level tests first, then, if necessary, use the circuit-level test. This chapter describes these tests as they relate to DECnet loopback capabilities and the NCP command LOOP, and provides a practical approach to their use.

Figure 4–1 shows the suggested order in which to run loopback tests to isolate a problem. Run the tests in the order shown unless you know that the problem is in a particular area. Continue testing in the order shown until you find the problem.

Figure 4-1 Running NCP Tests

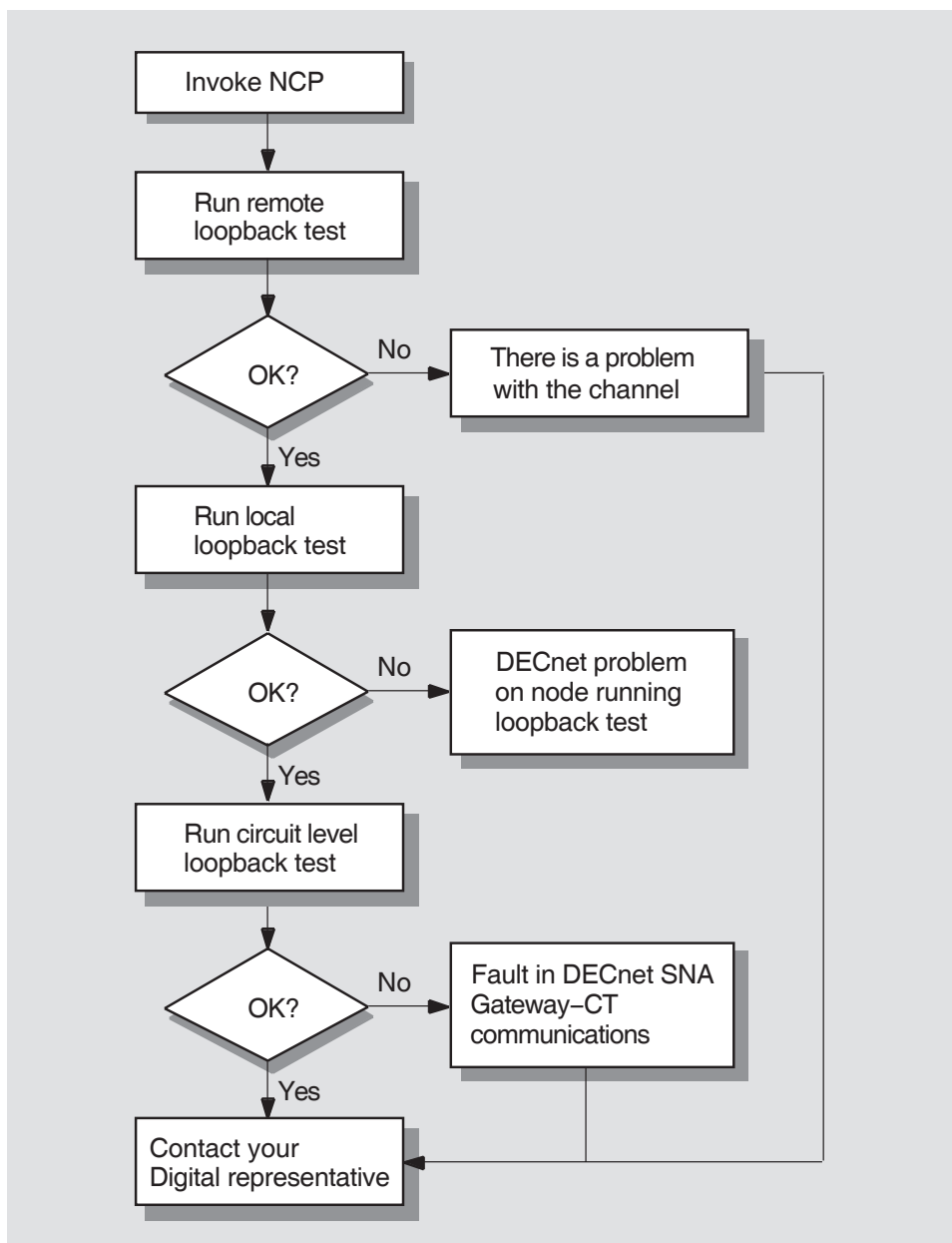

LKG-4884-93R

Regardless of the type of test you choose, use the NCP command LOOP to send test messages. This NCP function uses a cooperating process called the Loopback Mirror to facilitate the transmission and reception of test messages.

If your message returns with an error, the test stops and NCP displays a message that indicates a test failure, specifies the reason for the failure, and provides a count of the messages that were not returned. *OpenVMS System Messages and Recovery Procedures* summarizes the NCP error messages. The *OpenVMS Networking Manual* explains how to use loopback tests in greater detail. ULTRIX users may refer to *DECnet-ULTRIX Network Management* and *DECnet-ULTRIX NCP Command Reference*.

4.1 Node-Level Tests

Node-level tests examine the logical link capabilities of a node by exchanging test data between DECnet processes on two different nodes or between DECnet processes on the same node.

Node-level tests include:

- Remote loopback test
- Local loopback test

The remote loopback test checks the DECnet software and the logical link between the local DECnet node and the Gateway-CT, irrespective of the circuit (see Section 4.1.1). The local loopback test checks the DECnet software in the local node (see Section 4.1.2).

4.1.1 Remote Loopback Test

The remote loopback test checks the ability to create logical links between the local DECnet node and the Gateway-CT regardless of the physical route taken by the test data. Figure 4-2 shows this operation beginning at the load host node.

Figure 4-2 Remote Loopback Test

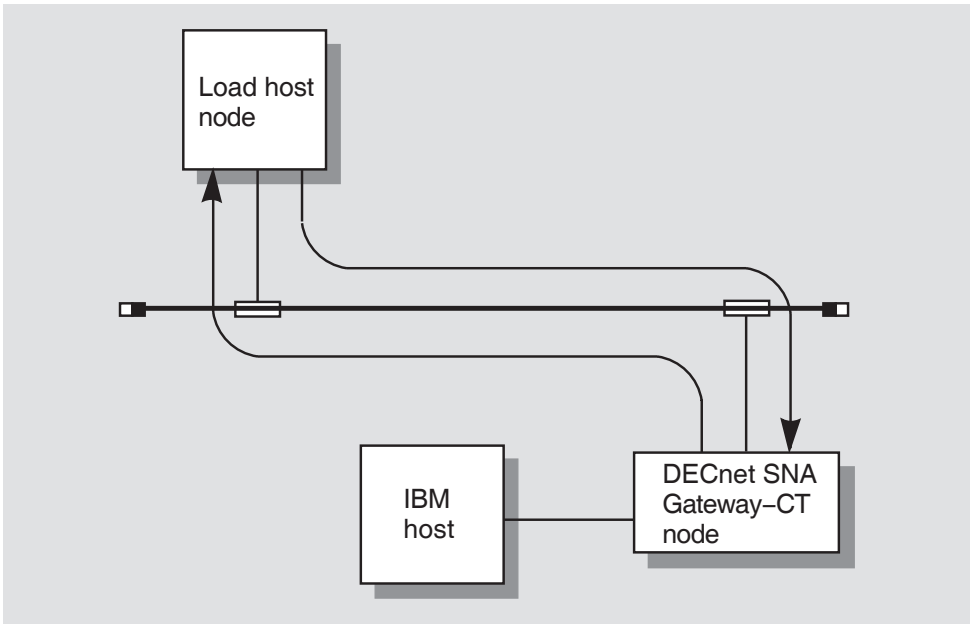

LKG-4885-93R

Start with the remote loopback test if you are unsure of the location of the problem. To run this test, you must know the Gateway-CT privileged username and password. Issue the following command at the NCP prompt:

OpenVMS syntax:

```
NCP>LOOP NODE gnn USER username PASSWORD password [...]
```

OpenVMS example:

```
NCP>LOOP NODE GWY COUNT 10 USER JONES PASSWORD SECRET
```

ULTRIX syntax:

```
ncp>loop node gnn user username password password [...]
```

ULTRIX example:

```
ncp>loop node gwy user jones password secret count 10
```

If this test runs successfully, you can assume it is possible to create logical links between the node initiating the test and the Gateway-CT. It is likely that there is a problem with the channel.

If you get an error with this test, run the local loopback test to further isolate your problem.

4.1.2 Local Loopback Test

The local loopback test checks the DECnet software in the node you are using; it does so by setting up and sending test data through an internal logical link. Figure 4-3 shows this operation.

Figure 4-3 Local Loopback Test

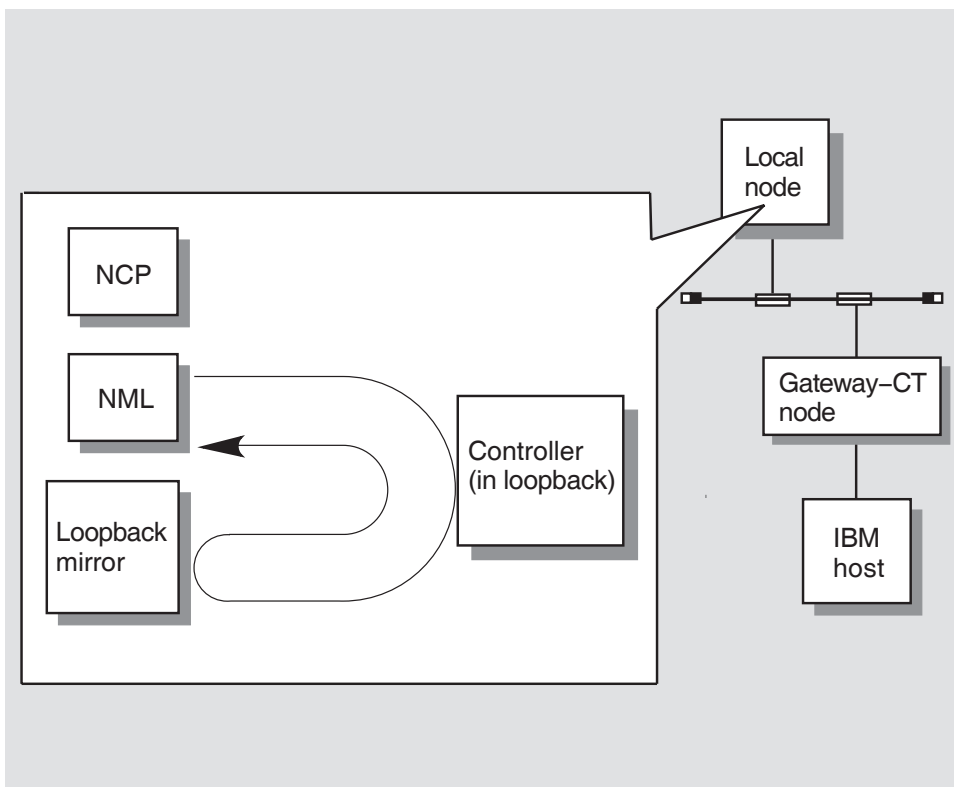

LKG-4886-93R

If this test is successful, the local DECnet software is not causing your problem.

To run the local loopback test, enter the following command at the NCP prompt:

OpenVMS syntax:

```
NCP>LOOP EXECUTOR [parameter] [...]
```

OpenVMS example:

```
NCP>LOOP EXECUTOR
```

ULTRIX syntax:

```
ncp>loop executor [parameter] [...]
```

ULTRIX example:

```
ncp>loop executor
```

If this test fails, there is a problem with the DECnet software in your local node (the default nonprivileged DECnet account on the local node is probably set up incorrectly). Ask the DECnet system manager to verify that DECnet is correctly installed and currently active.

If this test is successful, run the circuit-level loopback test to further isolate your problem.

4.2 Circuit-Level Test

The circuit-level test checks the service circuit and the communications device on the Gateway-CT node. Use this test if you suspect a problem with the communications device on the DECnet side of the Gateway-CT node.

To run the circuit level loopback test, you need OPER privileges as an OpenVMS user and superuser privileges as an ULTRIX user. Service must be enabled on the service circuit. To determine if service on the circuit is enabled, enter the following NCP command:

OpenVMS syntax:

```
NCP>SHOW CIRCUIT circuit-id CHARACTERISTICS
```

If service is not enabled, enter the following commands:

OpenVMS example:

```
NCP>SET CIRCUIT circuit-id OFF
NCP>SET CIRCUIT circuit-id SERVICE ENABLED
NCP>SET CIRCUIT circuit-id ON
```

Note

On the ULTRIX system, the service is generally enabled by default.

If service is enabled, enter the following command:

OpenVMS syntax:

```
NCP>LOOP CIRCUIT circuit-id NODE gnn
```

OpenVMS example:

```
NCP>LOOP CIRCUIT UNA-0 NODE GWY
```

ULTRIX syntax:

```
NCP>loop circuit circuit-id node gnn
```

ULTRIX example:

```
ncp>loop circuit una-0 node gwy
```

If this test fails, ask Digital Customer Service to run diagnostics on the device to ensure that it is properly installed.

Using Trace Utilities to Isolate Gateway-CT Problems (OpenVMS and ULTRIX)

Both DECnet SNA and IBM trace utilities can be used to isolate Gateway-CT problems. Section 5.1 describes DECnet SNA trace utilities; Section 5.2 describes IBM trace utilities. Both sections suggest when to use a particular type of trace and list documents that provide additional information.

5.1 Using DECnet SNA Trace Utilities

For OpenVMS, there are two protocol trace utilities, NETTRACE and SNATRACE, that can be used to isolate problems associated with the Gateway-CT and its access routines. Both utilities show the SNA protocol exchange between a Gateway-CT node and an IBM node. The *DECnet SNA Gateway for Channel Transport and Gateway for Synchronous Transport* management book explains how to use NETTRACE and SNATRACE.

For ULTRIX, there is one protocol trace utility: snatrace. The *DECnet SNA Gateway for Channel Transport and Gateway for Synchronous Transport* management book explains how to use snatrace.

You can use the DECnet SNA trace utilities to isolate problems on the channel-attached circuit, physical unit (PU), and session levels in the DECnet SNA environment. Select the appropriate level for the type of problem you are experiencing. If you do not know which trace level is appropriate, run a channel-attached circuit level trace; it is the lowest level trace and collects the most data.

5.1.1 Channel-Attached Circuit Level Trace

Run a channel-attached circuit level trace if any of these symptoms occur:

- The channel-attached circuit to the IBM does not initialize properly.
- You receive duplicate messages.
- You suspect that messages are being lost.
- You suspect data corruption.

5.1.2 Physical Unit Level Trace

Run a PU level trace if any of the following symptoms occur:

- You cannot establish a connection between the Gateway-CT and the IBM host.
- You can establish a connection between the Gateway-CT and the IBM host, but it fails repeatedly.
- You receive a message indicating a protocol problem on the PU level.
- You are unsure of the specific LU on which you want to run a PU trace.

5.1.3 Session Level Trace

Run a session level trace if you suspect a protocol problem with a particular session. Any of the symptoms listed in previous sections can indicate the need for a session level trace.

5.2 Using IBM Trace Utilities

You may need data from IBM traces to isolate problems in the Gateway-CT environment. You can trace data to show protocol sequences on the line, channel, physical, and logical levels. Ask your IBM systems programmer for the appropriate IBM traces. You can also request a VTAM internal trace and use the results to determine which control blocks VTAM used when it established a session. However, you should only ask for a VTAM internal trace as a last resort.

The following IBM manuals provide detailed information about IBM traces:

- *VTAM Version 3 Release 1 and 1.1 Diagnosis Guide*
- *MVS/Extended Architecture System Programming Library: Service Aids*
- *Virtual Machine/System Product: System Programmer's Guide, Release 4*

The following IBM traces can be used to isolate problems in the DECnet SNA network:

- VTAM buffer contents trace
- VTAM I/O trace
- GTF trace
- CP trace
- SDAID trace

These traces are explained in the following sections. Use the type of trace that is most appropriate for the type of problem you are experiencing.

5.2.1 VTAM Buffer Contents Trace

A VTAM buffer contents trace (TYPE=BUF) records all of the messages that are sent to or received from a VTAM application. This trace shows the contents of inbound and outbound message buffers.

If you suspect a problem in the host (VTAM or an application program) or in the network, you should request a buffer contents trace to trace path information units (PIUs) being sent to and received from a VTAM application program.

5.2.2 VTAM I/O Trace

The VTAM I/O trace (TYPE=RNIO) records the order in which PIUs flow between network nodes and VTAM. The content of the I/O trace is similar to that of the VTAM buffer contents trace except that the I/O trace records less user data. Use the PRDMP (print dump) service aid to edit and print the I/O trace records.

You should use the VTAM I/O trace to check whether the Gateway-CT software receives all the responses that it should and whether VTAM forwards all the requests issued by the Gateway-CT.

5.2.3 GTF Trace

The Generalized Trace Facility (GTF) trace records system and user-defined program events. The GTF output consists of trace records of MVS/XA system events and user events. The PRDMP service aid program is used to print GTF traces.

You should use GTF to trace specific incidences of one type of system event (such as I/O interruptions on a particular device) and any combination of system events (such as all I/O and SVC interruptions).

To use GTF, you select from either system or user events to generate internal and external tracing. The events and associated trace options follow:

- Channel programs and associated data for start subchannel and resume subchannel operations and I/O interruptions
Options: CCW with MVS/370; CCWP with MVS/XA
- All clear subchannel operations
Options: CSCH with MVS/XA
- All halt subchannel operations
Options: HSCH with MVS/XA
- I/O interruptions, including or excluding program-controlled interruptions, from particular devices or from all devices
Options: I/O with MVS/370
- All modify subchannel operations
Options: MSCH with MVS/XA
- All start subchannel and resume subchannel operations, from operations for a particular device or from all devices
Options: SSCHP with MVS/XA; SIO with MVS/370; SIOP with MVS/XA

MVS/Extended Architecture System Programming Library: Service Aids explains how to start the GTF trace.

5.2.4 CP Trace

The Control Program (CP) TRACE allows you to record virtual machine events. By using CP TRACE, you can trace any combination of system events, such as all I/O interruptions, SVC interruptions, program interruptions, and various instructions such as branch and CCW and CSW instructions. You can spool the results of the CP TRACE command to your terminal, real printer, or virtual printer.

Virtual Machine/System Product: System Programmer's Guide, Release 4 explains how to use the CP TRACE command.

5.2.5 SDAID Trace

You can use the following SDAID traces to trace VSE events:

- VTAMBU (VTAM buffer) trace provides a record of events when VTAM uses a buffer in its buffer pool.
- VTAMIO traces SVC interruptions, SIO or SIOF instructions, and I/O interrupts.

IBM Virtual Storage Extended Advanced Functions: Service Aids, Version 2, Release 2 explains how to use the SDAID trace commands.

6

Obtaining Information and Reporting Gateway-CT Problems (OpenVMS and ULTRIX)

If you are unable to solve a critical Gateway-CT problem, you should complete the following:

1. Read the product release notes to see if the problem is known. If it is, follow the solution offered to solve the problem.
2. Determine whether the Gateway-CT products are still under warranty or if your company purchased support services for the Gateway-CT products. Your operations manager can supply you with the necessary information.
3. If either condition in step 2 was met, take one of the following actions:
 - Access the on-line service database, if you have purchased this service, and determine if the problem you are experiencing has already been reported. If it has not, log your problem.
 - Call Digital Customer Service and describe your problem.
4. If you are requested to supply any information pertaining to the problem, gather the necessary information (see Section 6.1) and submit it through the appropriate channel.

6.1 Gathering Information

You may be asked to submit some of the information listed in the sections that follow. This information can help isolate problems to a particular area of the system.

General information:

- Detailed description of the operation or procedure that caused the fatal error
- List of reported error messages
- Description of your system's activity before the fatal error
- Description or map of your DNA network, showing operating system levels

OpenVMS Information from the Gateway-CT:

- Crash dump file image, when applicable
- Listing of the SNAEVL.LOG from SYS\$MANAGER
- PU, channel-attached circuit, or session level traces using NETTRACE or SNATRACE
- Listing of your SNA configuration file (SNAGATEWAY_gnn_SNA.COM) and/or your DECnet configuration file (SNAGATEWAY_gnn_DNA.COM)
- .LOG files from the the job and NETSERVER

Note

For access routine problems, please supply both the Gateway-CT software version number and the access routine version number.

ULTRIX Information from the Gateway-CT:

- Crash dump file image, when applicable
- PU, channel-attached circuit, or session level traces using snatrace
- Listing of your SNA configuration file (/var/snagwy/snagateway_gnn_sna) and/or your DECnet configuration file (/var/snagwy/snagateway_gnn_dna)
- ULTRIX system log (/var/spool/mqueue/syslog)

Note

For access routine problems, please supply both the Gateway-CT software version number and the access routine version number.

Information from the DEC host:

- List of any reported error messages (including Gateway and application error messages)
- Printout of events and errors logged at the DECnet host node

Information from the IBM host:

- List of reported error messages
- Description of your SNA environment
- IBM VTAM buffer contents trace, when applicable
- IBM VTAM I/O trace
- MVS GTF trace
- Listing of VTAM definitions
- Log on mode table for the GROUP/LINE/PU/LU
- Listing of application definitions

You may be asked to include an up-line dump or crash dump file. If a Gateway-CT node crashes, it writes the contents of its memory to a dump file on any available load host. This procedure is called an up-line memory dump or a crash dump.

Note

For OpenVMS, if you need to dump the contents of the system, use the NCP CONNECT command to connect to the remote console and then issue the DUMP command.

For ULTRIX, use the ccr command to connect to the remote console and then issue the dump command.

1. The ChannelServer sends a request to dump the contents of its memory over the Ethernet and waits for the load host node to reply.
2. If the load host node does not respond, the ChannelServer sends a message over the Ethernet requesting any node to receive the memory dump.
3. When a node answers the request, the ChannelServer sends the contents of memory (including the internal error log) to that node.

4. After the dump has been completed (it takes several minutes), the ChannelServer runs its internal test, reboots, and reloads the Gateway-CT software.

If the system "hangs" and you cannot use the remote console terminal DUMP command, you should use the following procedure instead:

1. Remove the door of the ChannelServer.
2. Set the Halt Enable/Disable switch to Enable (dot inside circle).
3. Press the console terminal break key. The console prompts

>>>

4. At the prompt, enter:

```
>>>S FFFFFFFF
```

This command crashes the ChannelServer. The console terminal will display a message indicating that the up-line dump has begun.

5. Set the Halt Enable/Disable switch back to the Disable position (dot outside circle).
6. Replace the door.

Note

If you submit a problem report and used this procedure, indicate that you deliberately crashed the system by following this procedure.

Index

A

Access names (OpenVMS), 2-16
Access names (ULTRIX), 3-15

B

BUFFER SIZE Parameter (OpenVMS)
 inadequate line setting, 2-21
 setting, 2-21
buffer size parameter (ULTRIX)
 inadequate line setting, 3-20
 setting, 3-20

C

Channel errors (OpenVMS), 2-21
 halt I/Os, 2-21
 selective resets, 2-21
 system resets, 2-21
Channel errors (ULTRIX), 3-19
 halt I/Os, 3-19
 selective resets, 3-19
 system resets, 3-19
Channel problems (OpenVMS)
 PU not active, 2-14
Channel problems (ULTRIX)
 PU not active, 3-12
Channel-attached circuit level trace, 5-2
Circuit errors (OpenVMS), 2-21
 data length, 2-21
 inadequate line setting, 2-21
 remote process, 2-21
 setting the BUFFER SIZE parameter,
 2-21

Circuit errors (ULTRIX), 3-20
 data length, 3-20
 inadequate line setting, 3-20
 remote process, 3-20
 setting the buffer size parameter,
 3-20
Circuit problems (OpenVMS), 2-12
Circuit problems (ULTRIX), 3-11
Circuit states (OpenVMS)
 not active, 2-19
 OFF, 2-19
Circuit states (ULTRIX)
 not active, 3-17
 OFF, 3-17
Circuit-level loopback test, 4-6
Circuit-level test, 4-1
CP TRACE, 5-4
Crash dumps, 6-3

D

Data length errors
 See Circuit errors
Data length errors (OpenVMS), 2-21
Data length errors (ULTRIX), 3-20
DECnet configuration database
 DEC ChannelServer II entries for, 2-1
 load host entries for, 2-2
DECnet problems (OpenVMS)
 when Gateway-CT system unreachable,
 2-15
DECnet problems (ULTRIX)
 when Gateway-CT system unreachable,
 3-14

DECnet-ULTRIX configuration database
 DEC ChannelServer II entries for, 3-1,
 3-7
 load host entries for, 3-2
DECnet-VAX configuration database
 DEC ChannelServer II entries for, 2-7
Diagnostic tools
 loopback tests as, 4-1
 trace utilities as, 5-1
 up-line dumps as, 6-3
Diagnostic tools (OpenVMS)
 IBM sense codes as, 2-19
Diagnostic tools (ULTRIX)
 IBM sense codes as, 3-18

E

Errors

See Channel errors

See Circuit errors

See Line errors

Ethernet address, finding (OpenVMS), 2-2

Ethernet address, finding (ULTRIX), 3-2

G

Gateway management trace utilities

 channel-attached circuit level, 5-1

 PU level, 5-1

 session level, 5-1

Gateway-CT problems (OpenVMS)

 cannot be loaded, 2-1

 circuit not active, 2-12

 network object unknown at remote node,
 2-7

 no access name recognition, 2-16

 no DECnet node name recognition, 2-15

 no LU name recognition, 2-17

 no PU name recognition, 2-17

 when system unreachable, 2-15

 wrong software loaded, 2-7

Gateway-CT problems (ULTRIX)

 cannot be loaded, 3-1

 circuit not active, 3-11

Gateway-CT problems (ULTRIX) (cont'd)

 network object unknown at remote node,
 3-6

 no access name recognition, 3-15

 no DECnet node name recognition, 3-13

 no LU name recognition, 3-16

 no PU name recognition, 3-15

 when system unreachable, 3-14

 wrong software loaded, 3-7

GTF trace, 5-3

H

Halt I/Os

See Channel errors

Hardware address (OpenVMS), 2-2

Hardware address (ULTRIX), 3-2

I

IBM sense codes (OpenVMS), 2-19

IBM sense codes (ULTRIX), 3-18

IBM traces

 CP TRACE, 5-4

 GTF trace, 5-3

 SDAID trace, 5-5

 VTAM buffer contents, 5-3

 VTAM I/O, 5-3

Initialization problems (OpenVMS)

 circuits not active, 2-12

 DECnet node name not recognized, 2-15

 Gateway-CT cannot be loaded, 2-1

 Gateway-CT incorrect software loaded,
 2-7

 Gateway-CT initialization process errors,
 2-5

 Gateway-CT loads, but some lines do not
 become active, 2-11

 no event messages, 2-9

 PU does not become active, 2-14

 receive aborted service request events,
 2-1

 SNAEVL not running, 2-9

 wrong software loaded, 2-7

- Initialization problems (ULTRIX)
 - circuits not active, 3-11
 - DECnet node name not recognized, 3-13
 - Gateway-CT cannot be loaded, 3-1
 - Gateway-CT incorrect software loaded, 3-7
 - Gateway-CT initialization process errors, 3-4
 - Gateway-CT loads, but some lines do not become active, 3-9
 - no event messages, 3-8
 - PU does not become active, 3-12
 - receive aborted service request events, 3-1
 - snaevl not running, 3-8
 - wrong software loaded, 3-7

L

- Line errors (OpenVMS)
 - excessive line errors, 2-21
 - inadequate RECEIVE BUFFER parameter setting, 2-21
 - local buffer errors, 2-21
- Line errors (ULTRIX)
 - excessive line errors, 3-19
 - inadequate receive buffer parameter setting, 3-19
 - local buffer errors, 3-19
- Load host problems (OpenVMS)
 - Ethernet connection, 2-2
 - load file, 2-4
 - no event messages, 2-9
- Load host problems (ULTRIX)
 - Ethernet connection, 3-2
 - load file, 3-4
 - no event messages, 3-8
- Local buffer errors
 - See Line errors*
- Local buffer errors (OpenVMS), 2-21
 - RECEIVE BUFFER parameter too small, 2-21
- Local buffer errors (ULTRIX), 3-19
 - receive buffer parameter too small, 3-19

- Local loopback tests, 4-5
- Loopback tests, 4-1
 - circuit-level, 4-6
 - local, 4-5
 - remote, 4-3

N

- NCP loopback tests, 4-1
 - circuit-level, 4-6
 - local, 4-3, 4-5
 - remote, 4-3
- NETTRACE utility, 5-1
- Node-level tests, 4-1, 4-3
 - local loopback, 4-3
 - remote loopback, 4-3

P

- Physical unit (PU) level traces, 5-2
- Problems, reporting, 6-1

R

- receive buffer parameter too small
 - See Line errors*
- RECEIVE BUFFER parameter too small
 - See Line errors*
- Remote console commands
 - DUMP, 6-3
- Remote loopback tests, 4-3
- Remote process errors
 - See Circuit errors*
 - See Errors*
- Remote process errors (OpenVMS), 2-21
- Remote process errors (ULTRIX), 3-20
- RU size (OpenVMS)
 - setting maximum, 2-21
- RU size (ULTRIX)
 - setting maximum, 3-19

S

SDAID trace, 5-5

Selective resets

See Channel errors

Session level traces, 5-2

Session problems (OpenVMS)

access names not recognized, 2-16

data length errors, 2-21

excessive circuit errors, 2-21

excessive line errors, 2-21

local buffer errors, 2-21

LU names not recognized, 2-17

PU names not recognized, 2-17

remote process errors, 2-21

terminating abnormally, 2-20

when channel-attached circuit not available, 2-18

when error messages received, 2-18

when Gateway-CT unreachable, 2-18

when process quotas inadequate, 2-18

Session problems (ULTRIX)

access names not recognized, 3-15

data length errors, 3-19

excessive circuit errors, 3-19

excessive line errors, 3-19

local buffer errors, 3-19

LU names not recognized, 3-16

PU names not recognized, 3-15

remote process errors, 3-20

terminating abnormally, 3-18

when channel-attached circuit not available, 3-16

when error messages received, 3-16

when Gateway-CT unreachable, 3-16

when process quotas inadequate, 3-16

Setting the buffer size parameter

See Circuit errors

Setting the BUFFER SIZE parameter

See Circuit errors

Setting the BUFFER SIZE parameter (OpenVMS), 2-21

Setting the buffer size parameter (ULTRIX), 3-20

SNATRACE utility, 5-1

System messages (OpenVMS)

IBM sense codes, 2-19

System messages (ULTRIX)

IBM sense codes, 3-18

System resets

See Channel errors

T

Tests

circuit-level, 4-1

circuit-level loopback, 4-6

local loopback, 4-5

node-level, 4-1, 4-3

local loopback, 4-3

remote loopback, 4-3

remote loopback, 4-3

Tools

See Diagnostic tools

Trace utilities, 5-1

Gateway Management, 5-1

IBM, 5-2

Traces

channel-attached circuit level, 5-2

CP TRACE, 5-4

GTF trace, 5-3

physical unit (PU) level, 5-2

SDAID trace, 5-5

session level, 5-2

VTAM buffer contents, 5-3

VTAM I/O, 5-3

U

Up-line dumps, 6-3

V

VTAM buffer contents trace, 5-3

VTAM I/O trace, 5-3

