

HP ACMS for OpenVMS

Getting Started

Order Number: AA-EV63J-TE

January 2006

This manual provides introductory information to help you get started with *HP ACMS for OpenVMS*. The manual includes a step-by-step tutorial for developing a simple *HP ACMS for OpenVMS* application. It also provides an overview of the AVERTZ car rental sample application that ships with the *HP ACMS for OpenVMS* software kit.

Revision/Update Information:	This document supersedes the HP ACMS for OpenVMS Getting Started, Version 4.5A.
Operating System:	OpenVMS Alpha Version 8.2 OpenVMS I64 Version 8.2-1
Software Version:	<i>HP ACMS for OpenVMS</i> , Version 5.0

Hewlett-Packard Company
Palo Alto, California

© Copyright 2006 Hewlett-Packard Development Company, L.P.

Confidential computer software. Valid license from HP required for possession, use or copying. Consistent with FAR 12.211 and 12.212, Commercial Computer Software, Computer Software Documentation, and Technical Data for Commercial Items are licensed to the U.S. Government under vendor's standard commercial license.

The information contained herein is subject to change without notice. The only warranties for HP products and services are set forth in the express warranty statements accompanying such products and services. Nothing herein should be construed as constituting an additional warranty. HP shall not be liable for technical or editorial errors, or omissions contained herein.

Motif is a registered trademark of The Open Group.

Oracle is a registered US trademark of Oracle Corporation, Redwood City, California.

Oracle CODASYL DBMS, Oracle CDD/Administrator, Oracle CDD/Repository, Oracle Rdb, Oracle SQL/Services, Oracle Trace, and Oracle Trace Collector are registered US trademarks of Oracle Corporation, Redwood City, California.

Printed in the US

Contents

Preface	ix
----------------------	----

Part I Introduction

1 Product Overview

1.1	Transaction Processing	1-1
1.2	TP and Timesharing	1-2
1.3	ACMS TP Monitor Features	1-3
1.3.1	Configuration Options	1-3
1.3.2	Efficient Use of System Resources	1-4
1.3.3	Easy System Expansion	1-4
1.3.4	Availability	1-5
1.3.5	Queued Tasks	1-5
1.3.6	Modular Applications	1-7
1.3.7	Data and Transaction Integrity	1-7
1.3.8	Security	1-8
1.3.9	Presentation Services	1-9
1.4	OpenVMS Support	1-10
1.4.1	Data Management Products	1-10
1.4.2	CDD Data Dictionary	1-11
1.4.3	Programming Languages and Tools	1-11
1.5	Professional Services and Support	1-12
1.6	Overview of the ACMS Application Development Life Cycle	1-12

2 Developing ACMS Applications

2.1	Mapping Business Functions to Tasks	2-2
2.2	Defining Tasks	2-2
2.2.1	Defining Task Steps	2-4
2.2.1.1	Writing Server Procedures	2-5
2.2.1.2	Using DCL Servers	2-7
2.2.2	Defining Workspaces	2-8
2.3	Defining Resources for Groups of Tasks	2-8
2.4	Defining Run-Time Characteristics for an Application	2-9
2.5	Defining Menus	2-9
2.6	Debugging and Testing	2-10

3 ACMS Run-Time System

3.1	ACMS Processes	3-1
3.1.1	Transaction Processing Processes	3-1
3.1.2	Monitoring and Controlling Processes	3-2
3.2	Run-Time Processing of Tasks	3-3
3.3	Run-Time Processing in a Distributed Environment	3-4

4 Managing ACMS Systems and Applications

4.1	Authorizing Access to ACMS	4-1
4.2	Authorizing ACMS Applications	4-2
4.3	Controlling ACMS Applications	4-2
4.3.1	Displaying System and Application Information	4-2
4.3.2	Receiving ACMS Operational Messages	4-3
4.4	Monitoring ACMS Applications	4-3
4.4.1	Using the Audit Trail Logger	4-3
4.4.2	Using Oracle Trace	4-4
4.4.3	Using the Software Event Logger	4-4
4.5	Tuning the ACMS System	4-5
4.6	Using the ACMS Remote Manager	4-5

5 ACMS Product Kits and Documentation

5.1	ACMS Product Kits	5-1
5.2	ACMS Documentation	5-1
5.2.1	Orientation and Installation	5-2
5.2.2	Planning and Design	5-2
5.2.3	Development and Testing	5-2
5.2.3.1	Reference Information	5-3
5.2.4	Implementation and Management	5-3

Part II Tutorial

6 Introduction

6.1	Before You Begin	6-1
6.2	Application Development Life Cycle	6-2
6.3	ACMS Application Development Concepts	6-2
6.3.1	Writing ACMS Definitions	6-3
6.3.2	Composition of ACMS Definitions	6-4
6.4	ACMS Integration with HP DECforms	6-5
6.4.1	HP DECforms Concepts	6-6
6.4.2	ACMS Interaction with HP DECforms	6-7
6.5	ACMS Integration with Resource Managers	6-8
6.5.1	Accessing a Database or a Master File	6-8
6.5.2	ACMS Interaction with a Resource Manager	6-8
6.6	Defining Fields and Records in CDD	6-9

7 Developing the Data Entry Task

7.1	Defining a CDD Environment	7-1
7.2	Defining a CDD Record	7-3
7.3	Creating a Form Using HP DECforms	7-5
7.3.1	Creating a Basic Form	7-5
7.3.2	Creating a Panel	7-8
7.3.3	Editing the Form IFDL Source File	7-15
7.3.4	Creating the Binary Form File	7-18
7.3.5	Defining Additional CDD Records	7-18
7.4	Defining the Data Entry Task	7-19
7.4.1	Defining the First Exchange Step	7-20
7.4.2	Defining the Processing Step	7-21
7.4.3	Defining the Second Exchange Step	7-22
7.4.4	Defining the Block Step and Workspaces	7-22
7.5	Compiling the Task Definition in ADU	7-23
7.6	Defining a System Logical for Your Tutorial Directory	7-24
7.7	Defining the Data Entry Procedure	7-25
7.7.1	Identification Division	7-27
7.7.2	Environment Division	7-27
7.7.3	Data Division	7-27
7.7.4	Procedure Division	7-28
7.7.5	Compiling the COBOL Procedure	7-28

8 Developing the Inquiry/Update Task

8.1	Defining a HP DECforms Form for Inquiry/Update	8-1
8.2	Defining the Inquiry/Update Task	8-3
8.2.1	Defining the First Exchange Step	8-4
8.2.2	Defining the First Processing Step	8-5
8.2.3	Defining the Second Exchange Step	8-5
8.2.4	Defining the Second Processing Step	8-6
8.2.5	Defining the Third Exchange Step	8-6
8.2.6	Completing the Task Definition	8-7
8.3	Compiling the Task Definition	8-8
8.4	Defining COBOL Procedures	8-8
8.4.1	Defining the Retrieval Procedure	8-8
8.4.2	Compiling the Retrieval Procedure	8-10
8.4.3	Defining the Update Procedure	8-11
8.4.4	Compiling the Update Procedure	8-12

9 Building the Task Group

9.1	Defining Startup and Cleanup Procedures	9-1
9.1.1	Defining the Initialization Procedure	9-1
9.1.2	Defining the Termination Procedure	9-3
9.1.3	Defining the Cancellation Procedure	9-4
9.2	Defining and Building the Task Group	9-6
9.2.1	Naming Forms	9-6
9.2.2	Naming the Tasks in the Task Group	9-6
9.2.3	Naming the Procedure Server and Workspaces	9-7
9.2.4	Compiling the Task Group Definition	9-7
9.2.5	Building the Task Group	9-8
9.3	Linking the Server Image	9-9
9.4	Testing a Task in the ACMS Task Debugger	9-9

10	Defining and Building the Application	
10.1	Defining the Application	10-1
10.1.1	Application Characteristics	10-1
10.1.2	Server Characteristics	10-2
10.1.3	Task Characteristics	10-2
10.2	Compiling the Application Definition	10-2
10.3	Building the Application	10-3
11	Defining and Building the Menu	
11.1	Defining the Menu	11-1
11.2	Compiling the Menu Definition	11-2
11.3	Building the Menu	11-3
12	System Management Requirements for Installing the Tutorial Application	
12.1	System Management Overview	12-1
12.2	Creating the EMPL_SERVER and EMPLOYEE_EXC Accounts	12-1
12.3	Authorizing ACMS Users	12-2
12.4	Authorizing ACMS Terminals	12-4
12.5	Authorizing ACMS Applications	12-5
12.6	Defining the ACMS\$DIRECTORY Logical	12-6
13	Installing and Running the Application	
13.1	Installing the Application	13-1
13.2	Starting the Application	13-2
13.3	Running the Application	13-2
13.4	Stopping the Application and the ACMS System	13-4
Part III AVERTZ Sample Application		
14	Before You Begin	
15	System Manager's View	
15.1	Building the AVERTZ Application and Databases	15-1
15.1.1	Build Options	15-5
15.2	Setting Up the AVERTZ Environment	15-5
15.2.1	Creating AVERTZ Accounts	15-6
15.2.2	Defining System Logical Names	15-7
15.3	Managing the AVERTZ Environment	15-8
15.3.1	Authorizing ACMS Users	15-8
15.3.2	Authorizing ACMS Terminals	15-9
15.4	Starting and Stopping ACMS and AVERTZ	15-10
15.4.1	Starting ACMS and the AVERTZ Application	15-10
15.4.2	Stopping the AVERTZ Application and ACMS	15-11

16 User's View

16.1	Entering AVERTZ	16-1
16.2	Customer Reserves a Car	16-2
16.3	Customer Checks Out a Car (Beginning the Rental)	16-7
16.4	Customer Checks In a Car (Ending the Rental)	16-10

17 Behind the Scenes

17.1	Applications and Procedures	17-1
17.2	Task Definition Language	17-3
17.3	More AVERTZ	17-6

A Utilities for Solving Problems in an ACMS Application

A.1	How ACMS Runs a Task	A-1
A.2	Audit Trail Logger	A-2
A.3	Software Event Logger	A-3
A.4	HP DECforms Trace Facility	A-3
A.5	ACMS Help Facility	A-4

B Source Files Used in the Tutorial

B.1	Source Files	B-1
B.2	Accessing the Source Files	B-2

Glossary

Index

Examples

7-1	COBOL Data Entry Procedure	7-26
8-1	COBOL Retrieval Procedure	8-9
8-2	COBOL Update Procedure	8-11
9-1	COBOL Initialization Procedure	9-2
9-2	COBOL Termination Procedure	9-3
9-3	COBOL Cancellation Procedure	9-5
17-1	Code from the Reservation Task Definition	17-4

Figures

1-1	Traditional Timesharing Environment	1-2
1-2	Transaction Processing System Environment	1-2
1-3	Front-End/Back-End Processing in a Local ACMS System	1-3
1-4	Distributed ACMS System	1-4
1-5	OpenVMS Cluster Configuration in a Distributed ACMS System	1-6
1-6	Sample ACMS Menu	1-9
1-7	Interaction of the Phases of the ACMS Application Development Life Cycle	1-13
2-1	ACMS Application Components	2-1

2-2	Structure of an ACMS Application	2-3
2-3	Simple ACMS Menu	2-3
2-4	Simple Form for a Sales Task	2-5
2-5	Task Steps for an Inventory Update Task	2-6
2-6	Parts of a Procedure Server	2-7
2-7	Retail Transaction Menu with Task and Menu Entries	2-10
3-1	ACMS Run-Time Processes	3-1
3-2	Run-Time Processing with a Separate Front End	3-4
6-1	Execution Flow of an ACMS Task Definition	6-3
6-2	ACMS Application Components	6-4
6-3	Panels and Viewports	6-6
6-4	HP DECforms Interaction with ACMS	6-7
6-5	A Resource Manager Interacting with ACMS	6-9
7-1	DECforms LAYOUT Screen	7-6
7-2	FDE Main Menu	7-7
7-3	Choose/Create Panel Menu	7-9
7-4	Create Panel Screen	7-10
7-5	Sample DECforms Panel	7-11
7-6	Create Field Menu	7-12
7-7	Data Type Character Window	7-13
7-8	Sample Panel with One Data Field Picture	7-14
7-9	Sample Panel with Data Field Pictures	7-15
8-1	Employee Number Panel	8-2
13-1	Selection Menu	13-3
16-1	AVERTZ Rental Menu	16-1
16-2	Reservation Panel	16-2
16-3	Site Selection Panel	16-3
16-4	New Customer Panel	16-4
16-5	Reservation Completed Panel	16-6
16-6	Checkout Panel	16-7
16-7	Checkout Update Panel	16-8
16-8	Car Selection Panel	16-8
16-9	Checkout Completion Panel	16-9
16-10	Checkin Panel	16-10
16-11	Checkin Update Panel	16-11
17-1	Structure of an ACMS Application	17-2
17-2	Example of Execution Flow for an ACMS Task Definition	17-3
A-1	Databases in an ACMS Application	A-2

Tables

15-1	Parameters for the AVERTZ Build Procedure	15-5
17-1	Description of Code Excerpt	17-5

Preface

This manual provides an introduction to *HP ACMS for OpenVMS* (ACMS) concepts. You should be familiar with these concepts when you use the other manuals in the ACMS documentation set. You can use ACMS with related HP products as a development and run-time system for transaction processing (TP) applications.

Intended Audience

Part I of this document is intended for anyone who wants a general understanding of ACMS.

Part II of this document is intended for application programmers who are new to ACMS. You do not need expertise with Oracle CDD/Repository, HP DECforms, or ACMS to perform the tutorial application. However, you should have some familiarity with the OpenVMS operating system.

Part III of this document is intended for systems analysts and program developers who are involved in creating and integrating the components of an ACMS system.

Document Structure

This document has the following structure:

- Part I contains an overview of *HP ACMS for OpenVMS* software and documentation. It contains the following chapters:
 - Chapter 1 describes the TP style of computing, its differences from traditional timesharing computing, and the key features of an ACMS TP system.
 - Chapter 2 provides an overview of the steps required to build an ACMS application.
 - Chapter 3 describes what happens as ACMS executes the series of steps that make up a task.
 - Chapter 4 provides an overview of managing the ACMS system and applications and describes the tools ACMS provides for this work.
 - Chapter 5 outlines the ACMS product packages and describes ACMS documentation.
- Part II contains a step-by-step tutorial for developing a simple ACMS application. It contains the following chapters:
 - Chapter 6 contains a list of prerequisites for performing the tutorial and an overview of ACMS application development concepts.
 - Chapter 7 describes in step-by-step detail how to write the data entry task using ACMS, HP DECforms, and CDD definitions.

- Chapter 8 describes in step-by-step detail how to write the inquiry/update task using ACMS, HP DECforms, and CDD definitions.
- Chapter 9 describes how to combine the data entry task and the inquiry/update task into a task group. It also describes how to write startup and cleanup procedures, how to link the object modules into a server image, and how to test the tasks using the ACMS Task Debugger.
- Chapter 10 describes how to write the application definition and then build this definition into an application database that ACMS uses at run time.
- Chapter 11 describes how to write the menu definition and then build this definition into a menu database that ACMS uses at run time.
- Chapter 12 describes procedures that the system manager follows to prepare for the installation of the tutorial application.
- Chapter 13 describes how to install and run the tutorial application.
- Part III contains an overview of the AVERTZ car rental sample application that ships with the *HP ACMS for OpenVMS* software kit. It contains the following chapters:
 - Chapter 14 describes three perspectives of an ACMS system, the system manager's view, the user's view, and the developer's view.
 - Chapter 15 helps you build, install, and set up the AVERTZ sample application.
 - Chapter 16 presents a fictional conversation and transaction between a reservation clerk working for AVERTZ operations in New England and a customer who needs a rental car.
 - Chapter 17 takes a brief look at some of the work involved in designing and developing an ACMS application.
- Appendix A describes how ACMS runs a task, and introduces some utilities that are available to help you solve problems in running a new ACMS application.
- Appendix B lists the source files created by the tutorial in Part II and describes how to access the online versions of these files.
- The Glossary contains definitions of terms from all books in the ACMS documentation set.

ACMS Help

ACMS and its components provide extensive online help.

- DCL level help

Enter `HELP ACMS` at the DCL prompt for complete help about the ACMS command and qualifiers, and for other elements of ACMS for which independent help systems do not exist. DCL level help also provides brief help messages for elements of ACMS that contain independent help systems (such as the ACMS utilities) and for related products used by ACMS (such as HP DECforms or Oracle CDD/Repository).

- ACMS utilities help

Each of the following ACMS utilities has an online help system:

- ACMS Debugger
- ACMSGEN Utility
- ACMS Remote Manager Configuration Utility (ACMSCFG)
- ACMS Remote Manager Client (ACMSMGR)
- ACMS Remote Manager Data Snapshot Utility (ACMSSNAP)
- ACMS Queue Manager (ACMSQUEMGR)
- Application Definition Utility (ADU)
- Application Authorization Utility (AAU)
- Device Definition Utility (DDU)
- User Definition Utility (UDU)
- Audit Trail Report Utility (ATR)
- Software Event Log Utility Program (SWLUP)

The two ways to get utility-specific help are:

- Run the utility and type HELP at the utility prompt.
- Use the DCL HELP command. At the “Topic?” prompt, type @ followed by the name of the utility. Use the ACMS prefix, even if the utility does not have an ACMS prefix (except for SWLUP). For example:

```
Topic? @ACMSQUEMGR
Topic? @ACMSADU
```

However, do not use the ACMS prefix with SWLUP:

```
Topic? @SWLUP
```

Note that if you run the ACMS Debugger Utility and then type HELP, you must specify a file. If you ask for help from the DCL level with @, you do not need to specify a file.

- ACMSPARAM.COM and ACMEXCPAR.COM help

Help for the command procedures that set parameters and quotas is a subset of the DCL level help. You have access to this help from the DCL prompt, or from within the command procedures.

- LSE help

ACMS provides ACMS-specific help within the LSE templates that assist in the creation of applications, tasks, task groups, and menus. The ACMS-specific LSE help is a subset of the ADU help system. Within the LSE templates, this help is context-sensitive. Type HELP/IND (PF1-PF2) at any placeholder for which you want help.

- Error help

ACMS and each of its utilities provide error message help. Use HELP ACMS ERRORS from the DCL prompt for ACMS error message help. Use HELP ERRORS from the individual utility prompts for error message help for that utility.

- Terminal user help

At each menu within an ACMS application, ACMS provides help about terminal user commands, special key mappings, and general information about menus and how to select tasks from menus.

- Forms help

For complete help for HP DECforms or HP TDMS, use the help systems for these products.

Related Documents

The following table lists the books in the *HP ACMS for OpenVMS* documentation set.

ACMS Information	Description
<i>HP ACMS Version 5.0 for OpenVMS Release Notes</i> †	Information about the latest release of the software
<i>HP ACMS Version 5.0 for OpenVMS Installation Guide</i>	Description of installation requirements, the installation procedure, and postinstallation tasks.
<i>HP ACMS for OpenVMS Getting Started</i>	Overview of ACMS software and documentation. Tutorial for developing a simple ACMS application. Description of the AVERTZ sample application.
<i>HP ACMS for OpenVMS Concepts and Design Guidelines</i>	Description of how to design an ACMS application.
<i>HP ACMS for OpenVMS Writing Applications</i>	Description of how to write task, task group, application, and menu definitions using the Application Definition Utility. Description of how to write and migrate ACMS applications on an OpenVMS Alpha system.
<i>HP ACMS for OpenVMS Writing Server Procedures</i>	Description of how to write programs to use with tasks and how to debug tasks and programs. Description of how ACMS works with the APPC/LU6.2 programming interface to communicate with IBM CICS applications. Description of how ACMS works with third-party database managers, with Oracle used as an example.
<i>HP ACMS for OpenVMS Systems Interface Programming</i>	Description of using Systems Interface (SI) Services to submit tasks to an ACMS system.
<i>HP ACMS for OpenVMS ADU Reference Manual</i>	Reference information about the ADU commands, phrases, and clauses.
<i>HP ACMS for OpenVMS Quick Reference</i>	List of ACMS syntax with brief descriptions.
<i>HP ACMS for OpenVMS Managing Applications</i>	Description of authorizing, running, and managing ACMS applications, and controlling the ACMS system.
<i>HP ACMS for OpenVMS Remote Systems Management Guide</i>	Description of the features of the Remote Manager for managing ACMS systems, how to use the features, and how to manage the Remote Manager.
Online help†	Online help about ACMS and its utilities.

†Available online only.

For additional information on the compatibility of other software products with this version of ACMS, refer to the *HP ACMS for OpenVMS Software Product Description* (SPD 25.50.xx).

For additional information about the Open Systems Software Group (OSSG) products and services, access the following OpenVMS World Wide Web address:

<http://h71000.ww7.hp.com/openvms>

Reader's Comments

HP welcomes your comments on this manual.

Print or edit the online form `SYS$HELP:OPENVMSDOC_COMMENTS.TXT` and send us your comments by:

Internet	openvmsdoc@hp.com
Mail	Hewlett-Packard Company OSSG Documentation Group, ZKO3-4/U08 110 Spit Brook Rd. Nashua, NH 03062-2698

How To Order Additional Documentation

Use the following World Wide Web address for information about how to order additional documentation:

<http://www.hp.com/go/openvms/doc>

To reach the OpenVMS documentation website, click the Documentation link.

If you need help deciding which documentation best meets your needs, call 1-800-ATCOMPA.

Conventions

The following conventions are used in this manual:

<code>Ctrl/x</code>	A sequence such as <code>Ctrl/x</code> indicates that you must press and hold the key labeled <code>Ctrl</code> while you press another key or a pointing device button.
<code>PF1 x</code>	A sequence such as <code>PF1 x</code> indicates that you must first press and release the key labeled <code>PF1</code> and then press and release another key or a pointing device button.
<code>Return</code>	In examples, a key name enclosed in a box indicates that you press a key on the keyboard. (In text, a key name is not enclosed in a box.) In the HTML version of this document, this convention appears as brackets rather than a box.
<code>...</code>	A horizontal ellipsis in examples indicates one of the following possibilities: <ul style="list-style-type: none">• Additional optional arguments in a statement have been omitted.• The preceding item or items can be repeated one or more times.• Additional parameters, values, or other information can be entered.
<code>.</code>	A vertical ellipsis indicates the omission of items from a code example or command format; the items are omitted because they are not important to the topic being discussed.

Monospace text	<p>Monospace type indicates code examples and interactive screen displays.</p> <p>In the C programming language, monospace type in text identifies the following elements: keywords, the names of independently compiled external functions and files, syntax summaries, and references to variables or identifiers introduced in an example.</p> <p>In the HTML version of this document, this text style may appear as italics.</p>
-	<p>A hyphen at the end of a command format description, command line, or code line indicates that the command or statement continues on the following line.</p>
numbers	<p>All numbers in text are assumed to be decimal unless otherwise noted. Nondecimal radices—binary, octal, or hexadecimal—are explicitly indicated.</p>
bold text	<p>Bold text represents the introduction of a new term or the name of an argument, an attribute, or a reason.</p> <p>In the HTML version of this document, this text style may appear as italics.</p>
<i>italic text</i>	<p>Italic text indicates important information, complete titles of manuals, or variables. Variables include information that varies in system output (Internal error <i>number</i>), in command lines (<i>/PRODUCER=name</i>), and in command parameters in text (where <i>dd</i> represents the predefined code for the device type).</p>
UPPERCASE	<p>Uppercase text indicates the name of a routine, the name of a file, the name of a file protection code, or the abbreviation for a system privilege.</p> <p>In command format descriptions, uppercase text is an optional keyword.</p>
<u>UPPERCASE</u>	<p>In command format descriptions, uppercase text that is underlined is required. You must include it in the statement if the clause is used.</p>
lowercase	<p>In command format descriptions, a lowercase word indicates a required element.</p>
<lowercase>	<p>In command format descriptions, lowercase text in angle brackets indicates a required clause or phrase.</p>
()	<p>In command format descriptions, parentheses indicate that you must enclose the options in parentheses if you choose more than one.</p>
[]	<p>In command format descriptions, vertical bars within square brackets indicate that you can choose any combination of the enclosed options, but you can choose each option only once.</p>
{ }	<p>In command format descriptions, vertical bars within braces indicate that you must choose one of the options listed, but you can use each option only once.</p>

References to Products

The ACMS documentation set often refers to products by abbreviated names. The following product abbreviations are used in this documentation set:

Abbreviation	Product
ACMS	HP ACMS for OpenVMS Alpha, and HP ACMS for OpenVMS I64
Ada	HP Ada for OpenVMS Alpha Systems, and HP Ada for OpenVMS I64 Systems
BASIC	HP BASIC for OpenVMS
C	HP C for OpenVMS Alpha Systems, and HP C for OpenVMS I64 Systems
CDD	Oracle CDD/Administrator, and Oracle CDD/Repository
COBOL	HP COBOL for OpenVMS Alpha Systems, and HP COBOL for OpenVMS I64 Systems
DATATRIEVE	HP DATATRIEVE for OpenVMS Alpha, and HP DATATRIEVE for OpenVMS I64
DBMS	Oracle CODASYL DBMS
DECforms	HP DECforms
FORTRAN	HP Fortran for OpenVMS Alpha Systems, and HP Fortran for OpenVMS I64 Systems
OpenVMS	The OpenVMS Alpha operating system, and the OpenVMS I64 operating system
Pascal	HP Pascal for OpenVMS Alpha, and HP Pascal for OpenVMS I64
Rdb	Oracle Rdb
SQL	The SQL interface to Oracle Rdb

Part I

Introduction

This part provides an overview of HP ACMS for OpenVMS software and documentation.

Product Overview

The **ACMS** transaction processing system is a TP monitor that runs on the OpenVMS operating system. It is intended for businesses that require high performance, security, data integrity, and both centralized and distributed processing. Retail, banking, financial services, telecommunications, health, customer service, manufacturing, and insurance are some of the industries that can make use of the ACMS system.

With ACMS, businesses can shrink development time for their applications, streamline application maintenance, and lower the cost per transaction. Applications can be configured for distribution over many systems, providing a flexible response to changes in business conditions. The open-ended OpenVMS architecture and networking allow for growth without disruption of services.

This chapter describes the TP style of computing, its differences from traditional timesharing computing, and the key features of an ACMS TP system.

1.1 Transaction Processing

Transaction processing allows businesses to maintain timely and accurate data about their operations. Many users access the same database or databases to perform a series of steps related to a business function. Each activity represents a transaction. Transactions can occur between a user and a computer, or just among computers.

The applications written for transaction processing usually involve updating a database and notifying the user that the change has taken place as intended. Maintaining up-to-date, accurate databases is an essential function of transaction processing applications.

Examples of typical TP applications include processing a customer's request for withdrawal or deposit of funds, maintaining a retail store's online inventory, and cross-referencing and updating of patients' medical records.

In these cases, many users from different locations want access to the same database, at the same time, for a specific business activity. As a result, high availability, rapid response time, and data integrity are important criteria for a TP system.

Other important requirements of a TP system are:

- Systems must be capable of growing.
- Databases must be available and stay reliable throughout transaction processing.
- The TP system must allow for different levels of technical sophistication for its users.

Product Overview

1.2 TP and Timesharing

1.2 TP and Timesharing

Before transaction processing systems became a reality, first batch processing and then timesharing were the computing styles that handled the large volume of data transactions necessary for business.

In a timesharing system, each user has a separate process, and computer resources are parceled out according to a schedule that makes it appear that each process has the full attention of the central processing unit (CPU). Some processes can interact with a database; others can run word processing, a spreadsheet, or other interactive software. Figure 1–1 shows a typical timesharing system, which has many users using display terminals and interacting with a CPU.

Figure 1–1 Traditional Timesharing Environment

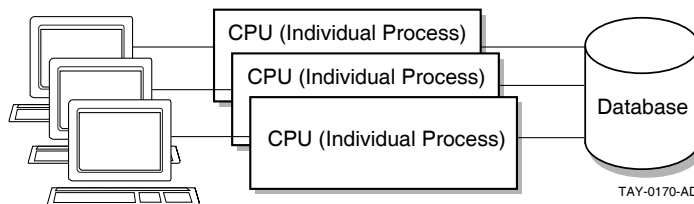

TP applications are typically high-volume, online applications with repetitive operations on data critical to the mission of a business. In a traditional timesharing system, these applications can tax system resources because each user requires a separate process.

Specialized transaction processing systems were developed to make more efficient use of system resources and to provide utilities for managing and controlling these complex applications. Figure 1–2 illustrates a transaction processing system environment.

Figure 1–2 Transaction Processing System Environment

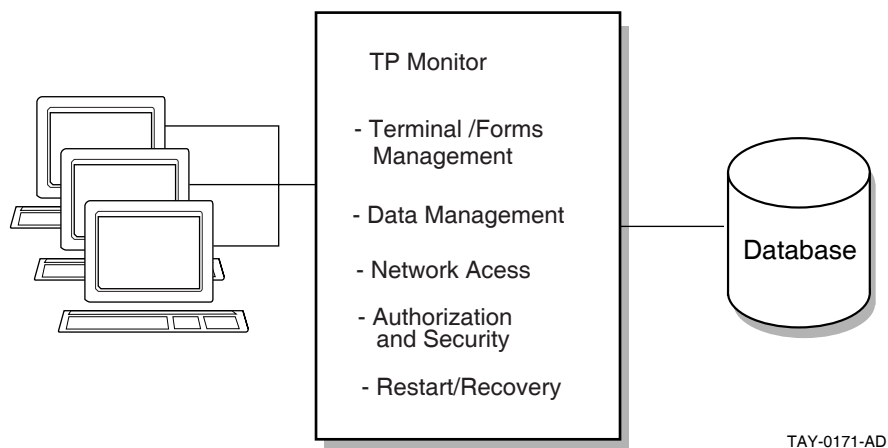

A TP system, like a typical timesharing system, has many users, but they do not each require a separate process. Instead, a **TP monitor** manages access to the CPU, functioning like a specialized operating system within your operating system.

The TP monitor can include facilities for terminal and forms management, data management, network access, authorization and security, and restart/recovery. These facilities allow you to control what users do, how often they do it, and when they do it.

1.3 ACMS TP Monitor Features

ACMS is a TP monitor that provides a development, run-time, and application management system for TP applications. It is designed for a modular, flexible development style and efficient use of system resources in large on-line applications.

ACMS combines a structured, high-level application definition language and utilities to build, manage, and control complex applications. The modular nature of ACMS applications makes them more efficient to develop and run, and easier to maintain than traditional applications programs. ACMS applications can be modified by changing individual components, rather than rewriting the entire application.

ACMS is also part of an integrated application development environment which includes presentation services, transaction and database management, programming languages, and tools.

1.3.1 Configuration Options

Terminal, menu, and other input/output (I/O) functions are separated in ACMS from database or file processing and computational functions. The terminal and menu functions are handled on the **front end** of the transaction processing system, while the data processing and computation are performed on the **back end** of the system. Figure 1-3 illustrates the operation of ACMS front-end and back-end processing.

Figure 1-3 Front-End/Back-End Processing in a Local ACMS System

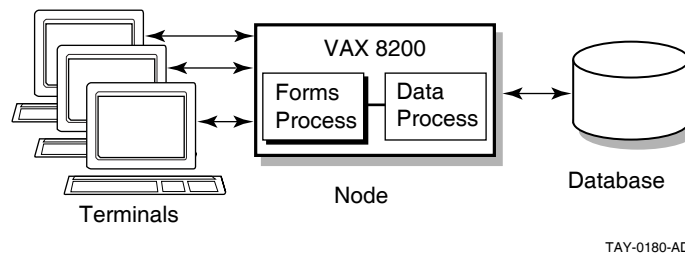

The separation of functions in ACMS makes it possible for you to distribute ACMS applications across a network of computers, installing front-end functions on one or more nodes and back-end functions on another set of nodes in the network. In a **distributed transaction processing** environment, the front end is also called the **submitter** node, because it is the node from which tasks are selected and sent to the back-end node. The back end is also called the **application** node, because it is the node on which the application execution and data processing are performed.

Figure 1-4 illustrates an ACMS system environment distributed across a network.

Product Overview

1.3 ACMS TP Monitor Features

Figure 1-4 Distributed ACMS System

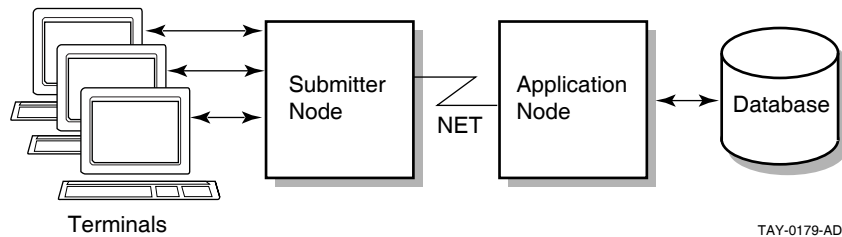

1.3.2 Efficient Use of System Resources

Most TP applications put heavy demands on computer processing power and memory resources. An important requirement for TP applications is that they make efficient use of the resources available. With a traditional TP system, structuring applications to minimize the strain on a system can demand additional design and programming time. ACMS is designed to use computer resources, such as memory and CPU, efficiently to help maximize run-time performance.

ACMS uses dedicated OpenVMS processes to manage terminal I/O, execute processing and data manipulation subroutines, and control the application run-time system.

ACMS has a multithreaded internal design. In a system that uses **multithreaded processes**, a single process can manage more than one user or process at the same time. On the front end of an ACMS system, a single process can display forms and menus for many users rather than have each user need a separate process to do this work. On the back end, a single process can handle the flow control, or the complex coordination of data processing and computations, of each user's work rather than have OpenVMS manage each user's process separately. Also on the back end, rather than each user using a separate process to access the database, a single process can manage paths into the database for many users at one time. To help you manage heavy system use, ACMS allows you to create additional processes on the back end as the need arises.

The separation of functions in ACMS makes it possible to increase the speed and reliability of ACMS transactions by distributing the front-end and back-end functions across a network. You can offload forms processing to a smaller front-end computer, like a MicroVAX, and use more powerful computers, like a VAX 8800 or a VAX 9000, for back-end data processing. You can configure each node in the distributed system for the processing of specific tasks.

1.3.3 Easy System Expansion

It is easy to expand an ACMS system to meet your growing business needs. Without rewriting your application code, you can distribute existing ACMS applications or add nodes to an existing network of distributed ACMS applications.

You can install and run ACMS applications on the full range of VAX and Alpha computers, from the small MicroVAX to the powerful VAX 9000 mainframe.

To accommodate more users, you can add small clusters of VAX and/or Alpha computers as front-end nodes to handle additional terminal and forms processing. To increase application processing capabilities, you can add high-performance VAX and/or Alpha computers as back-end nodes.

1.3.4 Availability

By distributing the forms processing functions of an ACMS application, you can make the system more available in the event of system failures. Using the features of DECnet network software, **OpenVMS Cluster networks**, and volume shadowing, ACMS eliminates single points of system failure and significantly increases the amount of time your applications are available to you.

Figure 1–5 illustrates a configuration in which an ACMS system uses MicroVAX computers in a local area OpenVMS Cluster network as front-end submitter nodes, and uses a back-end OpenVMS Cluster for database or file functions.

The configuration in Figure 1–5 ensures that an application is available under the following circumstances:

- If one node in the local area OpenVMS Cluster becomes unavailable, users are automatically routed to an available front-end node in the OpenVMS Cluster. The front-end terminal I/O is automatically handled by the available node. Using LAT terminals can provide additional failover capabilities on a front end.
- If one back-end node becomes unavailable, ACMS routes transactions to another back-end node. Database or file **recovery** is provided for the failed node, restoring the database or file to its original condition.
- If a single disk becomes unavailable, volume shadowing transparently provides a replacement for it.

For more information on configuring your ACMS system for high availability, see *HP ACMS for OpenVMS Managing Applications*.

1.3.5 Queued Tasks

Some ACMS applications use data that is collected and processed interactively. The application displays a menu or a form on a video terminal through which users enter data. Then the application processes the data and either displays the results of the processing or requests more data.

Other ACMS applications require that data be collected once and then stored in a temporary storage area, or **queue**, for the application to process at another time. For these types of applications, data can be collected using a device other than a terminal, such as a card-punch time clock, and sent to a special ACMS queuing facility. The ACMS **queuing facility** lets you place tasks in a queue and then submit the tasks for processing at another time. Using the queuing facilities provided by ACMS, you can design applications to immediately process in real-time (such as capturing data), and alternatively defer processing of work that does not require real-time processing until later.

Applications that benefit from queuing have the following types of requirements:

- Data capture and deferred processing of data

An example of this type of application is one that processes hundreds of time cards in a very short time during a shift change. In this type of application, processing each data item immediately can affect system performance and be costly in the use of system resources. Employees would have to wait in line while each time card was read into the system and then processed. The ACMS queuing facility lets you capture the data quickly and store it for future processing.

Product Overview

1.3 ACMS TP Monitor Features

Figure 1–5 OpenVMS Cluster Configuration in a Distributed ACMS System

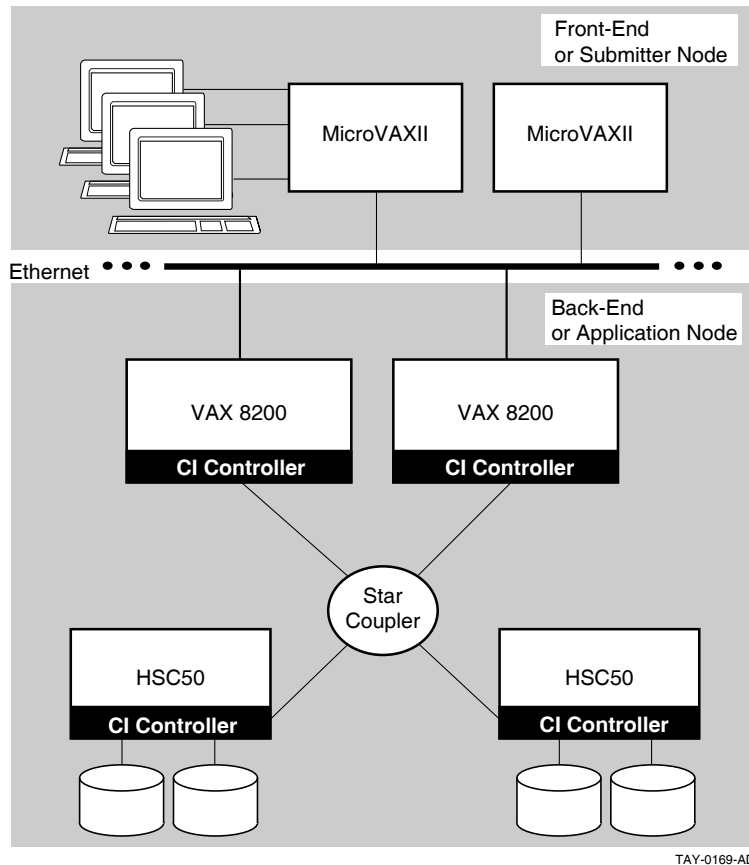

- High application availability
In a distributed environment, if the back-end node becomes unavailable, the front-end node can continue to submit tasks to queues. When the back-end node becomes available, the ACMS queuing facility automatically submits the tasks for processing.
- Data and transaction integrity
If the system becomes unavailable while processing a queued task, the ACMS **Queued Task Initiator (QTI)** continues trying to submit that task. As with all ACMS queued tasks, the dequeue (removal from the queue) and database updates are all tied together as a single transaction, ensuring that database updates will take place once and only once. The changes that the task was making to the database at the time of failure are not made permanent until the task succeeds. This is one way that ACMS can ensure the integrity of your database.

For more information on ACMS queues, see *HP ACMS for OpenVMS Writing Applications*.

1.3.6 Modular Applications

ACMS applications are made up of a set of component definitions that describe and control the work of an application, and a set of subroutines that access databases and files. You use the ACMS **Application Definition Utility (ADU)** for creating and processing the component definitions of an ACMS application. To write application subroutines, called **server procedures**, you can use any third-generation language that conforms to the OpenVMS Calling Standard, such as C or COBOL.

ADU includes a high-level, English-like definitional language. You use the statements and clauses of the language to create definitions for each application component of an ACMS application. In addition, you use ADU commands to process the definitions. When you process a definition, you build a binary file from the definition that is interpreted at run time.

ACMS applications are easier to develop and maintain than traditional applications because modular definitions replace system programming calls. Developing sets of component definitions and application subroutines emphasizes the principles of structured programming. As a result, you can divide responsibilities for developing parts of an application among many programmers.

The modularity of ACMS applications also makes maintenance easier. Terminal I/O is separate from data processing, and application logic is separate from system and application management. To change an application, you make changes to a component's definition, rather than rewrite the entire application.

Chapter 2 provides an introduction to developing ACMS applications. For detailed information on developing applications using ADU, see *HP ACMS for OpenVMS ADU Reference Manual* and *HP ACMS for OpenVMS Writing Applications*.

1.3.7 Data and Transaction Integrity

TP systems must ensure that data remains consistent and work remains intact if the system or database becomes unavailable. Using data management products and the **HP DECdtm Services for OpenVMS** (a collection of OpenVMS services that provide for the management of distributed transactions), ACMS provides full data and transaction integrity and consistency.

A **resource manager** controls shared access to a set of recoverable resources, such as a database. In an application that accesses a single database or set of files, resource managers ensure integrity by providing rollback recovery. Resource managers available to ACMS include RMS, Rdb, and DBMS. When a **database transaction** updates a database, the resource manager **commits** the change when the transaction ends. Committing the change makes it permanent. If the system or database becomes unavailable before the database transaction ends, the resource manager **rolls back** the database, returning it to the state it was in before the transaction started.

For applications that use **distributed transactions**, that is, a single grouping of operations on more than one recoverable resource or resource manager, the HP DECdtm services provide rollback recovery following a two-phase commit protocol. **Two-phase commit protocol** ensures that, when changes are made to data during a distributed transaction, either all resource managers commit the distributed transaction or all work will be rolled back.

Product Overview

1.3 ACMS TP Monitor Features

The two phases of the protocol are:

- Prepare phase, in which each resource manager indicates a willingness to commit
- Commit phase, in which each resource manager is instructed by the controlling transaction manager to either commit and roll forward, or abort and roll back

Typically, you use HP DECdtm services when you design an application that:

- Processes data in more than one database or file on a single node or across a network

If a transaction is prevented from completing anywhere on a network, the entire transaction is rolled back to its starting point, and your work can be recovered.

- Queues tasks and their data

HP DECdtm services guarantee that a queued task is entered on the queue and that the task is not removed from the queue until the data is processed successfully exactly once.

HP DECdtm components include a transaction manager and resource managers. The transaction manager oversees the phases of a two-phase commit for either a database transaction or an ACMS queuing facility operation. Resource managers (such as Rdb, DBMS, and RMS) manage the access to their recovery data and databases.

Each node in the network has its own HP DECdtm transaction manager and one or more of the supported resource managers. For each transaction, a HP DECdtm transaction manager tracks which resource managers are being used to process data. If an event on the system keeps the transaction from completing anywhere on a network, all databases affected by that transaction are rolled back to their original state.

You can also design applications that use the ACMS queuing facility to place tasks in a queue file. The ACMS queuing facility uses HP DECdtm services to ensure that every task on the queue is processed exactly once. In a distributed system, tasks and their data can be entered on the front-end queue. If the back-end node becomes unavailable, the tasks and their data are held in the queue. When the back-end node becomes available again, the tasks are submitted for processing.

1.3.8 Security

ACMS ensures that your data remains secure by giving you control over which users have access to ACMS. Using OpenVMS and ACMS authorization facilities, you can:

- Authorize users to use ACMS
- Control terminals connecting to ACMS
- Limit the applications a user can run

For example, you can give a personnel employee access to a task that updates a confidential file, but ensure that the employee cannot view sensitive information in the file, make unauthorized changes to the file, or gain access to the file outside the context of the task.

For a more detailed introduction to defining access to ACMS and applications, see Chapter 4. For details on managing an ACMS system, see *HP ACMS for OpenVMS Managing Applications*.

1.3.9 Presentation Services

Users select and run ACMS tasks from menus. Figure 1–6 shows a sample ACMS menu.

Figure 1–6 Sample ACMS Menu

```
Personnel Administration System

1  ADD      T      Add employee record
2  UPDATE   T      Display and update employee record

Selection: █
```

VM-0371A-AI

To create menus, ACMS supports **HP DECforms**, a forms product running on the OpenVMS operating system, as its primary presentation service. In addition, ACMS provides support for **VAX Terminal Data Management System (TDMS)**. HP DECforms is the first commercial implementation of the proposed ANSI/ISO standard **Form Interface Management System (FIMS)**, a system for interaction between applications and display devices. Using HP DECforms, you can write a forms application program (which describes the function of a display) separately from the user interface of the display (such as a menu or form).

ACMS uses standard menus in both HP DECforms format and TDMS format. You can easily customize these standard menus. For more information on using HP DECforms or TDMS, see the appropriate product documentation. For an example of using HP DECforms to create standard ACMS menus, see Chapter 11.

ACMS provides support for other presentation service products. Using the ACMS Request Interface and the ACMS Systems Interface, you can create applications that use forms management products, such as FMS, or special devices, such as electronic badge readers.

The **Request Interface** allows you to use presentation services other than HP DECforms or TDMS for I/O functions limited to one user per process. ACMS provides an easy-to-use programming interface with the Request Interface to forms products such as FMS (Forms Management System), SMG (Screen Management Facility), terminal interface products from other vendors, and menus in an ALL-IN-1 office integration system.

Product Overview

1.3 ACMS TP Monitor Features

The **Systems Interface** allows you to use presentation services for single-user or multiple-user I/O functions. The Systems Interface provides a set of software system services that give systems programmers the flexibility to design customized interfaces for complex systems or devices, such as badge or bar code readers.

For more information on using the Request Interface, see *HP ACMS for OpenVMS Writing Applications*. For more information on using the Systems Interface, see *HP ACMS for OpenVMS Systems Interface Programming*.

1.4 OpenVMS Support

ACMS is part of a family of software products designed to help you manage data in all areas of your organization. Layered on the OpenVMS operating system, these products work together with high-level programming languages to provide a total information management system you can tailor to your needs. Depending on your needs, you can choose from a variety of products for front-end I/O functions as well as back-end data management functions.

The following sections introduce some of the products you can use with ACMS to build a transaction processing system.

1.4.1 Data Management Products

HP DECdtm services for OpenVMS, the distributed transaction manager, ensures the integrity of data on back-end nodes in an ACMS application. The application and databases can be installed on a single node or distributed in a HP network. HP DECdtm services support the following **data management systems**, which you can use individually or in combination:

- **Rdb**, a relational database management system
Rdb is a full-function relational database management system for general purpose, multiuser, centralized or distributed TP applications. It is relatively easy to use, yet provides high performance and the ability to restructure data relationships.
Use Rdb if the structure of your database is expected to change significantly over time. You can use the **SQL** data definition and manipulation language with Rdb databases.
- **DBMS**, a CODASYL-compliant network database management system
DBMS is a high-performance database management system for general purpose, multiuser TP applications in which the relationships between different parts of the database are very complex.
Use DBMS for applications that involve complex but relatively stable data relationships and predictable information requests.
- **RMS**, a record management system
RMS is the OpenVMS operating system's default file management system with optional **journaling**. (Journaling is the process of recording information about operations on a file into a recoverable resource.) Access to data stored in RMS files can be either sequential or random, with the random access being either by key (for indexed files) or by record number (for relative files).
- Other database products or file management systems that support the OpenVMS Calling Standard

1.4.2 CDD Data Dictionary

The **CDD data dictionary system** provides a central storage location for data descriptions and definitions shared by ACMS, other related products, and programming languages.

The CDD data dictionary:

- Ensures the integrity of shared metadata and the procedures used to analyze, maintain, manage, and design business metadata
- Provides a centralized repository for information management shops
- Offers a dynamic aid to software application development

1.4.3 Programming Languages and Tools

As a member of a family of layered software products, ACMS makes use of high-level programming languages and tools.

You can write and debug application programs using a variety of high-level programming languages, including COBOL, FORTRAN, and C, and the OpenVMS Debugger. You can use any high-level language that adheres to the OpenVMS Calling Standard.

HP also provides a group of programming productivity tools, called HP DECset, that help you code, test, manage, and maintain applications. HP DECset tools include:

- **HP/Code Management System (CMS)**
CMS is a program source file library for software management and version tracking.
- **HP/Module Management System (MMS)**
MMS is a tool that automates and simplifies the building of software systems.
- **Language-Sensitive Editor (LSE)**
The **Language-Sensitive Editor (LSE)** is a multilanguage editor that helps you quickly and accurately write application programs. Templates for commands and statements in a variety of languages and layered products, including ACMS, SQL, and HP DECforms, are provided with LSE.
- **Source Code Analyzer (SCA)**
SCA is a multilanguage, interactive cross-reference and static analysis tool that can help you understand the complexities of a large software project.
- **Performance and Coverage Analyzer (PCA)**
PCA is a tool that analyzes program test coverage and the run-time behavior of your application.
- **HP/Test Manager (DTM)**
HP/Test Manager is a tool that organizes and automates the performance and evaluation of software tests.

For more information about programming productivity tools, see *A Methodology for Software Development Using OpenVMS Tools*, or the documentation for each individual product.

Oracle Trace is a tool that collects data and creates detailed reports on events that occur when an ACMS application runs. The information you collect with Oracle Trace can help you tune your ACMS system and improve performance.

Product Overview

1.4 OpenVMS Support

For information on using Oracle Trace with ACMS applications, see *HP ACMS for OpenVMS Managing Applications*.

1.5 Professional Services and Support

HP offers services to help with the design and development of ACMS applications, as well as support during the implementation and management of applications during run time. Services include:

- Training for application designers, developers, and system managers
- Training on related OpenVMS layered products
- Design and development consulting services
- Software support and problem-solving
- Software tool kits designed to help in the building of a TP system

For information on available TP system support services, see your HP representative.

1.6 Overview of the ACMS Application Development Life Cycle

The application development life cycle is an approach and process for developing complex software applications in discrete segments, called phases.

The first phase in the life cycle for ACMS applications is the preparation of the design and development environment. This phase involves the installation of ACMS and other related software tools.

The second phase in the life cycle is the planning and design of the forms, databases, and applications. In building the TP system, system designers determine what business functions the application must address, and map those business functions to software and hardware capabilities.

The third phase in the life cycle is the development and testing of the forms, databases, and applications that were designed during the planning and design phase. In addition to developing forms and databases, application developers also define ACMS application components, generally for several different applications.

The fourth phase in the life cycle is the implementation and management of the TP system. System managers set up hardware for users, and move the TP applications into the user environment. Once the applications are in the users environment, the system manager maintains that environment.

Figure 1–7 shows how the phases fit together for a complete transaction processing development system.

The next three chapters describe the development, implementation, and management of ACMS applications.

1.6 Overview of the ACMS Application Development Life Cycle

Figure 1-7 Interaction of the Phases of the ACMS Application Development Life Cycle

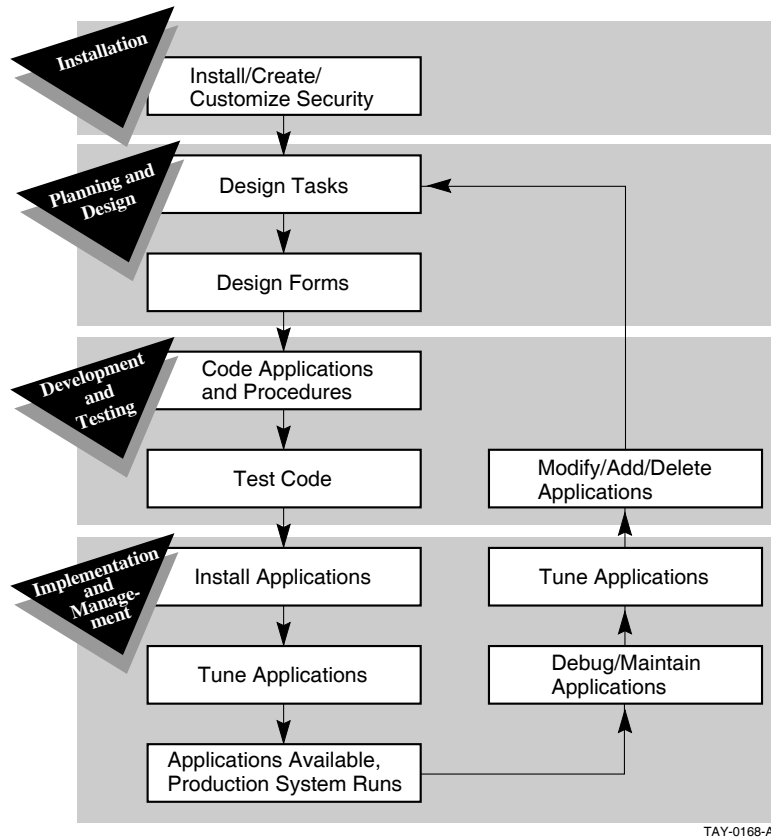

Developing ACMS Applications

With the ACMS software you can develop applications to automate business functions. An ACMS **application** is made up of a set of components and third-generation programming language code.

The components of an ACMS application are:

- **Task definitions** to describe units of work
- **Task group definitions** to describe the resources required by a group of tasks
- **Application definition** to describe the environment and control characteristics of tasks and task groups
- **Menu** to display a list from which terminal users can choose an available task

You use the ACMS **Application Development Utility** (ADU) to develop these components. ADU provides a high-level English-like definitional language that you use to write definitions for each component. After you write the component definitions, you use ADU to create binary versions of the files. These binary files are called database files. Although these binary files are known as database files or databases, they differ from traditional databases in which you can store and access data. For example, after you write a menu definition, you use ADU to build the menu database. At run time, ACMS uses the database files to run and control the application.

Figure 2–1 shows the relationships of the component definitions. One or more tasks make up a task group, and one or more task groups make up an application.

Figure 2–1 ACMS Application Components

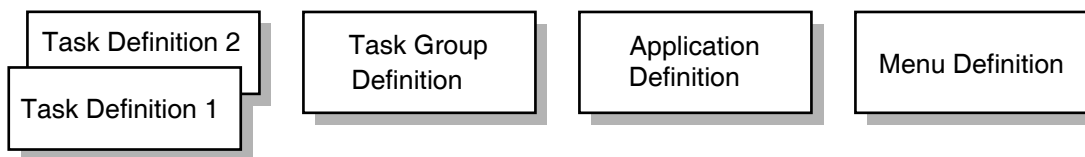

TAY-0217-AD

Because ACMS applications are made up of sets of components, they are more efficient to run and easier to maintain than traditional application programs. ACMS task definitions separate forms processing from data processing. At run time, this separation helps ensure an efficient use of system resources. Maintaining the application is also simplified. Because each application component is a separate definition, you can modify applications by changing individual components, rather than rewriting the entire application.

Developing ACMS Applications

This chapter provides an overview of the steps you take to build an ACMS application:

1. Map business functions to tasks.
2. Define the tasks.
3. Define the resources for groups of tasks.
4. Define the run-time characteristics for an application.
5. Define the forms and menus.
6. Debug and test the application.

2.1 Mapping Business Functions to Tasks

Each application is designed to meet a business need and automate a business function. In ACMS, the functions of a business relate to the tasks in an application. By analyzing the business needs, an application designer can make decisions about how best to map the business functions to ACMS tasks. The application design takes into consideration how users will work with the application as well as how the application will use system resources. When the design is complete, the job of defining ACMS application components and writing programming language code begins.

For more information on ACMS application design decisions, see *HP ACMS for OpenVMS Concepts and Design Guidelines*.

2.2 Defining Tasks

In ACMS, a set of **tasks** in an application relates to a set of business functions. Tasks in a retail sales application might be recording a new sale and updating the inventory database. Each task, in turn, is made up of a series of **steps** that perform the actual work. The user can select one of these tasks from a menu. Figure 2–2 shows the basic structure of an ACMS transaction processing application.

Tasks are the building blocks of an ACMS application. They are the units of work a user selects from an ACMS menu.

From a user's point of view, a task is a single business transaction performed repeatedly during the course of a day, such as recording a sale or updating an inventory database or file. Figure 2–3 shows a simple menu that a sales or inventory clerk using a retail sales application might see. The clerk can choose between tasks for recording a sale or updating inventory records.

Although tasks appear as individual items on the menu, they are typically made up of a series of steps that result in a change to a database or file. To share data among the parts of an application, ACMS provides special buffers called **workspaces**. Workspaces, for example, pass data between steps in the task and between tasks that work together in an application. The steps involved in updating an inventory database or file, for example, might retrieve the current record of an item, enter the updated information, and receive notification that

Figure 2–2 Structure of an ACMS Application

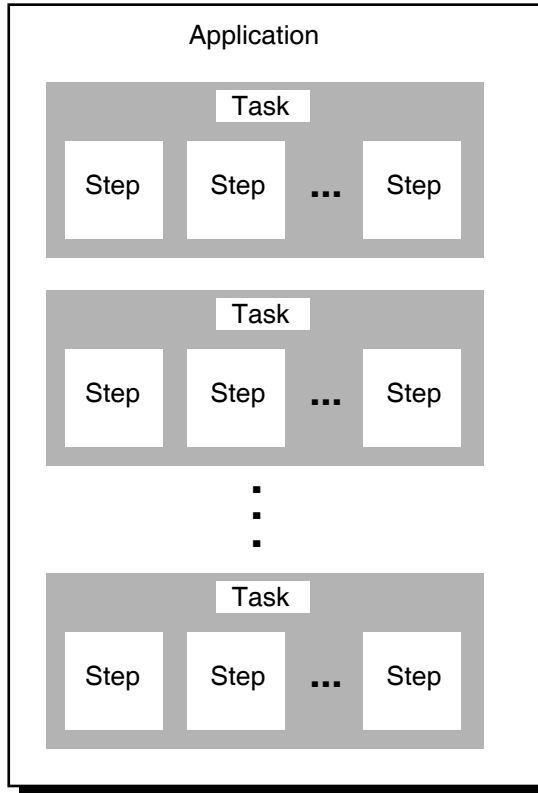

TAY-0172-AD

Figure 2–3 Simple ACMS Menu

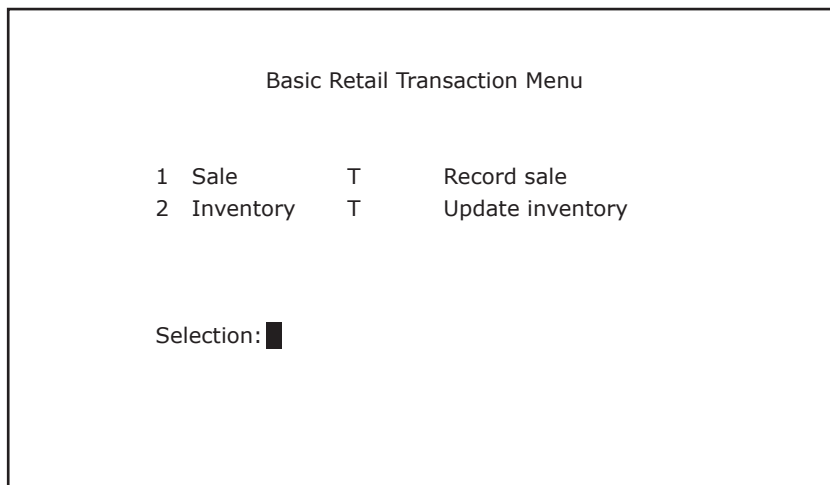

VM-0372A-AI

the change was made correctly. ACMS uses workspaces to pass the updated information and notification.

The following sections provide an introduction to task steps and workspaces.

Developing ACMS Applications

2.2 Defining Tasks

2.2.1 Defining Task Steps

Task steps perform the basic work involved in each of the events that make up a business transaction. You can separate the work to be accomplished by a task into the following types of task steps:

- **Exchange steps** handle data input/output, interacting with HP DECforms or TDMS forms, or with other presentation services and devices using the ACMS Request Interface.
- **Processing steps** handle computation or interaction with databases or files. Processing steps can use either a **procedure** written in a high-level programming language (such as COBOL, FORTRAN, or BASIC), DCL commands, or OpenVMS images.
- **Block steps** collect the task steps (exchange and processing) into functional groups. Grouping task steps makes the structure of the task definition more modular and, therefore, easier to develop and maintain.

You use the ACMS task definition language to define these steps in an ACMS task definition. Task definitions describe the exchange of information between the terminal user and the application, and the processing of that information against the file or database. Typically, you define a task that includes more than one step. For example, you can define a two-step data entry task that consists of:

- An exchange step to display a form that prompts the user to supply information such as a stock number and a description of an inventory item
- A processing step to write the information the user supplies to a database or file

Figure 2–4 shows a form you might see after selecting the Sale task from the menu in Figure 2–3. An exchange step displays the form and prompts the sales clerk to enter a stock number, a description of the item, and whether the sale is cash or charge. A processing step records the sale, subtracts the item from the store's inventory, and prints an invoice for the customer.

Figure 2–4 Simple Form for a Sales Task

Basic Form for Sale Task

Stock number:

Description:

Cash or charge:

VM-0373A-AI

You can define more complex tasks in **multiple-step tasks**, which contain a sequence of exchange and processing steps. For example, a task that displays and updates an inventory record is made up of two exchange steps and two processing steps:

1. An exchange step in which the user supplies information to a form on a terminal, in this case the item whose inventory record is to be updated
2. A processing step in which a procedure reads the item's inventory record from the database or file
3. An exchange step in which the inventory record is displayed in a second form on the terminal and the user updates the record
4. A processing step in which the updated record is written to the database or file

Figure 2–5 shows the sequence of exchange and processing steps for a simple inventory update task a warehouse clerk might select from the menu in Figure 2–3.

After the warehouse clerk selects the inventory update task, an exchange step displays a query form and prompts the clerk to supply the inventory item to be updated, in this case widgets. A processing step calls a procedure that reads the widget inventory record. A second exchange step displays the inventory, in this case 0 widgets, in an update form, and allows the warehouse clerk to update the record to reflect the arrival of 100 widgets. The final processing step calls a procedure that stores the updated record in the inventory database or file.

2.2.1.1 Writing Server Procedures

Processing steps can run **server procedures** written in a high-level programming language. ACMS supports all programming languages that conform to the OpenVMS Calling Standard, such as COBOL, FORTRAN, or C. You use OpenVMS utilities to write, debug, and compile server procedures.

Developing ACMS Applications

2.2 Defining Tasks

Figure 2–5 Task Steps for an Inventory Update Task

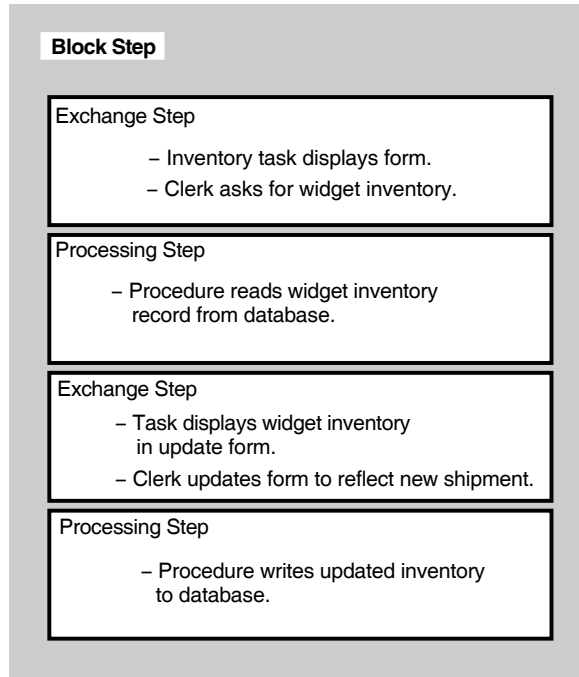

TAY-0017-RA

When all the procedures you need for a task or group of tasks are ready, you link the procedures to create a single **procedure server image**. At run time, ACMS creates at least one special process called a **procedure server process**, and activates and loads the procedure server image. When a user selects a task that uses the procedures, ACMS runs the programs. Figure 2–6 shows the parts of a **procedure server**.

Figure 2–6 Parts of a Procedure Server

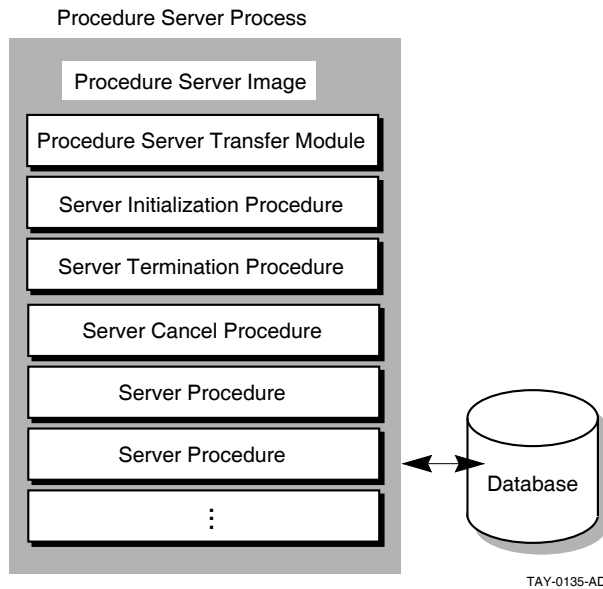

In addition to the **step procedures** that run in processing steps, you can write special procedures to maximize system resources, including:

- **Initialization procedures** to open all the files and to ready any databases needed by a group of tasks
- **Termination procedures** to close at one time all the files and any databases used by a group of tasks
- **Cancel procedures** to clean up context held by a task in a server when the task cancels before completing successfully

When you create a procedure server, you include any initialization, termination, and cancel procedures as part of the procedure server image. These special procedures can help conserve system resources because the work they do is done once for the group of tasks that use the procedure server.

For more information on creating procedure servers, see *HP ACMS for OpenVMS Writing Server Procedures*.

2.2.1.2 Using DCL Servers

Processing steps can run **OpenVMS images**, **DIGITAL Command Language (DCL) commands**, and **DCL command procedures**. Tasks with these types of processing steps require a **DCL server**. You define a DCL server in a task group definition.

DCL servers are useful for running:

- OpenVMS utilities, such as MAIL
- Existing programs you want to run under ACMS without converting immediately into ACMS multiple-step tasks
- Third-party software required by some ACMS application users, such as spreadsheets

For more information on defining servers in task groups, see *HP ACMS for OpenVMS Writing Applications*.

Developing ACMS Applications

2.2 Defining Tasks

2.2.2 Defining Workspaces

Workspaces are temporary storage areas used to pass information in an application. Workspaces can pass data between:

- Steps in tasks
- Tasks in a task group
- Forms and tasks
- Processing steps and databases or files

For example, you use workspaces when you pass data from a form on a terminal to and from a database or file. A workspace can contain data provided by a user at a terminal through an exchange step or a processing step in the same task group. Tasks read information from workspaces and write information to them.

ACMS maintains three **system workspaces** that are available to tasks. Each system workspace has a different purpose:

- When a user selects a task, ACMS stores any text the user supplied in the `ACMS$SELECTION_STRING` system workspace.

For example, when a user selects a task from a menu by entering a number and then text, the text is stored in the `ACMS$SELECTION_STRING` system workspace. The task the user selected can access the string stored in the workspace.

- When a task runs, ACMS stores the status of task steps in the `ACMS$PROCESSING_STATUS` system workspace.

You can use the workspace to check for the status of a task step and take appropriate action.

- ACMS stores information about a user and the user's device in the `ACMS$TASK_INFORMATION` system workspace.

For example, you can define a task that uses information about the user to determine what type of work to perform.

2.3 Defining Resources for Groups of Tasks

All tasks belong to one or more task groups. A **task group** is a collection of one or more related tasks that have similar processing requirements and share resources. A task group definition contains such information as:

- Procedures called by the tasks in the group.
- HP DECforms forms used by the tasks in the group.
- TDMS request libraries used by the tasks in the group.
- Message files used by the tasks in the group.
- Procedure servers available to the task group and any special server attributes, including server name and server image file specification, names of all step procedures handled by the server, and optional initialization, termination, or cancellation procedures.
- Workspaces available to the task group.

See *HP ACMS for OpenVMS Writing Applications* for information on defining task groups.

2.4 Defining Run-Time Characteristics for an Application

The application definition describes the run-time characteristics for an ACMS application, its servers, and its tasks. The run-time characteristics include information about which users can access tasks in the application and whether an audit of the application runs.

Defining the control characteristics of an application separately from its tasks and task groups allows you to use the tasks in different run-time environments.

You create an application definition using ADU. After you create the definition, you use ADU to build the definition into a binary **application database** file. ADU compiles information from the task group database file and the application definition to provide the ACMS run-time system with control information, pointers to task groups, and information required to run tasks.

You can change many of the characteristics of an application while the application is running. The changes remain in effect until the application is stopped. You make the changes permanent by modifying the application definition.

For more detailed information on defining ACMS applications using ADU, see *HP ACMS for OpenVMS Writing Applications* and *HP ACMS for OpenVMS ADU Reference Manual*. For information on changing the characteristics of a running application, see *HP ACMS for OpenVMS Managing Applications*.

2.5 Defining Menus

Users select and run ACMS tasks from menus similar to those shown in Figure 2-3. Menus can include two types of entries: tasks and other menus. Tasks do the work of an application; menus display other tasks and other menus. Because a user can select one menu from another, application programmers can build menu hierarchies or trees. One menu tree can make tasks from many applications available, so users can access many applications from a single menu.

ACMS uses two presentation services, HP DECforms and TDMS, to display menus. The ACMS software kit includes a HP DECforms form and a TDMS form for displaying standard menus. You can easily revise the standard format to customize it to your application. You can also use the ACMS Request Interface to include other menu formats in your applications, such as menus in an ALL-IN-1 office integration system.

You create a **menu definition** for each menu you want to display. The definition describes the characteristics of the menu, including the list of items on the menu and a description of each item.

In the standard HP DECforms and TDMS formats, the only information required in a menu definition is the list of entries that appears on the menu. The menu definition includes an **entry name** for each entry as it appears on the menu, and an **entry type**, which tells ACMS whether the entry is a task or another menu. In Figure 2-7, the entry names are Sale, Inventory, Cancel, Return, and Complaint. The entry type is indicated by the letters T, for task, and M, for menu, following the entry name. You can include additional information in a menu, such as a menu title and text describing the entries.

Developing ACMS Applications

2.5 Defining Menus

Figure 2–7 Retail Transaction Menu with Task and Menu Entries

Retail Transaction Menu			
1	Sale	T	Record sale
2	Inventory	T	Update inventory
3	Cancel	T	Cancel
4	Return	M	Menu for a return
5	Complaint	M	Complaint menu

Selection: █

VM-0374A-AI

A menu can include tasks from more than one application. To execute a task from a menu, you can select a task by:

- Entry number
- Entry name

Depending on the design of your application, you can supply additional information to a selected task following the task name or number in a menu. In Figure 2–7, for example, you can specify the Inventory task followed by an inventory item number at the Selection: prompt.

For more information on ACMS menus, see *HP ACMS for OpenVMS Writing Applications*.

2.6 Debugging and Testing

Before you include a task group in your application, use the ACMS and OpenVMS debugging tools to test and debug the task group, its member tasks, and procedures called by the tasks. The **ACMS Task Debugger** allows you to examine individual tasks and find out how ACMS manages the branching from one task to another. You use the **OpenVMS Debugger** to check whether or not procedures and forms are correct.

The ACMS Task Debugger is the primary tool for debugging tasks because it lets you control tasks while they are running. For example, you can pause at each step in a task. You can look at the values in the task workspaces, change these values if necessary, and resume task execution where you left off.

The ACMS Task Debugger helps you verify:

- Workspace contents at the beginning and end of a step
- Actions taken by task and server cancel procedures
- Recovery operations performed by ACMS

Developing ACMS Applications

2.6 Debugging and Testing

The ACMS Task Debugger uses the OpenVMS Debugger to debug procedures in processing steps. You use the OpenVMS Debugger to check whether or not procedures execute and variables contain the values you expect. For example, you can pause after a procedure reads a record, check the values in a task workspace, and then resume task execution.

ACMS also provides a way to debug running applications. You can debug servers while they are running and obtain server process dumps for servers that stop unexpectedly.

For information on testing and debugging, see *HP ACMS for OpenVMS Writing Server Procedures*. For a step-by-step introduction to developing an ACMS application, see Part II.

ACMS Run-Time System

ACMS applications run under the control of the ACMS run-time system. The run-time system executes tasks according to the control characteristics in the application definition.

This chapter describes what happens as ACMS executes the series of steps that make up a task. Each part of the task is discussed in terms of the OpenVMS and ACMS run-time processes and their functions.

3.1 ACMS Processes

The ACMS run-time system is made up of eight specialized processes. Four processes manage the processing of a transaction; four monitor and control the run-time system. Figure 3–1 shows the processes that make up the ACMS run-time system. The following sections explain these specialized processes.

Figure 3–1 ACMS Run-Time Processes

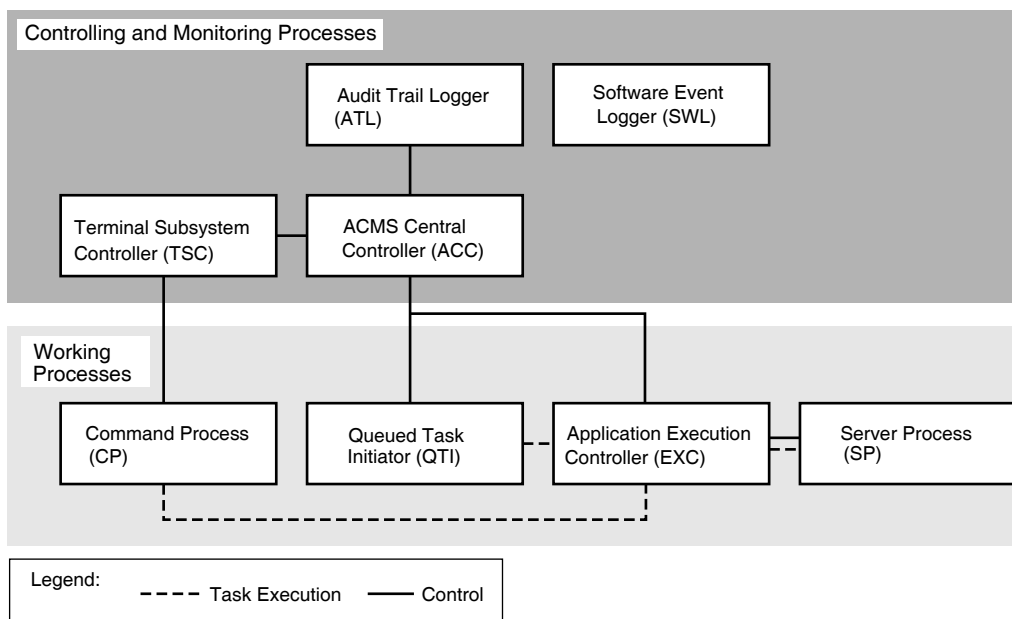

VM-0453A-AI

3.1.1 Transaction Processing Processes

The ACMS processes that manage the work of an ACMS transaction are:

- Command Process (CP)
- Queued Task Initiator (QTI)
- Application Execution Controller (EXC)

ACMS Run-Time System

3.1 ACMS Processes

- Server process (SP)

A **Command Process** (CP) manages logins and interaction between terminals and ACMS. CPs display menus, accept and interpret terminal user commands, and communicate with the Application Execution Controller. An ACMS system can include more than one CP.

A CP separates an application's interactions with the terminal from its processing work. This separation makes it possible to distribute the application, off-loading forms and menus to a front-end, or submitter node, and concentrating computations and data processing on one or more back-end, or application nodes.

The ACMS **Queued Task Initiator** (QTI) dequeues task elements that were placed in a queue by an ACMS programming service, and initiates tasks in an application. For example, you can design a task that places another task in a queue, allowing users and the application to continue working without waiting for the queued task to complete. The QTI later executes the queued task.

The **Application Execution Controller** (EXC) processes the definitions of the tasks in an application, managing all the tasks in an application simultaneously. The EXC is responsible for task security, allocating workspaces, and scheduling, creating, and communicating with servers. The EXC accepts messages from the CP or QTI (which invoke tasks on behalf of the user), passes forms for exchange steps to the CP, creates server processes that call procedures in processing steps, and creates workspaces for sharing data by tasks.

Each application on an ACMS system has its own execution controller. You can run more than one application on a node and have more than one active EXC at a time.

The **server process** (SP) carries out the high-level programming language routines or DCL routines that handle a task's processing work and database or file I/O. The SP calls the appropriate subroutine for a task. The EXC uses the results to determine what to do next and passes the final task results to the CP or QTI. Each application can use more than one server process.

The CP uses the menu database to display menus for a user. The EXC uses the task group database to determine flow control for tasks and which server to call for a particular task. The EXC uses the application database to determine such information as the process characteristics for server process and security through an **access control list** (ACL) for a task. The ACL specifies which users can execute a task.

3.1.2 Monitoring and Controlling Processes

The ACMS processes that monitor and control the run-time system are:

- ACMS Central Controller (ACC)
- Terminal Subsystem Controller (TSC)
- Audit Trail Logger (ATL)
- Software Event Logger (SWL)

The **ACMS Central Controller** (ACC) is the central control point for the ACMS run-time system. It starts and controls the Terminal Subsystem Controller, the QTI, the EXC, and the Audit Trail Logger (ATL).

The **Terminal Subsystem Controller** (TSC) is responsible for creating and controlling the number of active CPs and for assigning terminals to CPs. The TSC starts and stops CPs as needed within limits that you define. It also controls which terminals can access ACMS.

The **Audit Trail Logger** (ATL) is responsible for writing information about a running ACMS system to the audit trail log file. The ATL keeps a record of when the ACMS system starts and stops, when users log in, and when applications and tasks start and stop. The ACC always starts the ATL when the ACMS system is started. With the Audit Trail Report Utility (ATR), you can create summary reports based on information recorded by the ATL.

The **Software Event Logger** (SWL) records all software errors and event messages that occur during the execution of ACMS application programs. The Software Event Log Utility Program (SWLUP) allows you to create reports containing selected information recorded by the SWL.

3.2 Run-Time Processing of Tasks

When users log in to the OpenVMS operating system, OpenVMS starts a process for each of them. However, when users sign in to the ACMS TP monitor, they share a single ACMS Command Process (CP). The CP first confirms that a user is authorized to access ACMS; then it displays the user's menu and accepts task selections.

When a user selects a task, the CP:

1. Determines to which application the task belongs
2. Locates the EXC for that application
3. Passes control to the EXC, which:
 - Confirms that the user has access to the task
 - Determines how the task handles terminal input/output

If a user does not have access to the task, the execution controller passes an error message to the CP for display on the user's terminal.

After determining that a user has access to a task, the EXC:

1. Finds the task definition in the task group database
2. Allocates and initializes workspaces for the task
3. Executes the task

The EXC starts and stops SPs as needed within limits set by the application definition. The task definition and the kind of processing the task does determine when and how long an SP is allocated.

HP ACMS for OpenVMS Writing Applications provides more detailed information on the run-time processing of ACMS tasks.

ACMS Run-Time System

3.3 Run-Time Processing in a Distributed Environment

3.3 Run-Time Processing in a Distributed Environment

With ACMS, you can separate terminal and menu functions from the run-time processing of an application. This separation lets you run applications on a single computer, in an OpenVMS Cluster, or across the nodes of a network. In a distributed environment, the presentation service providing the terminal or device interface resides on a front-end processor, while the application managers and databases reside on a back-end processor.

Separating an ACMS application's functions using a front end that manages terminal functions and a back end that manages data processing has many benefits. For example, you can distribute your work among several applications, each running on its own back-end process and each available to users from a single menu. Users can select tasks and access the applications from a single menu on the front end. By distributing the run-time processing of tasks, you can improve system performance and the use of system resources.

Figure 3-2 shows the run-time processing of an application with terminal I/O shifted to a separate front-end computer or OpenVMS Cluster.

At run time, ACMS handles user logins and task requests for applications running on a network in much the same way it handles them for a single-node application. When a user enters ACMS, the CP controls the user's terminal, managing logins and the display of menus.

For details on applications with separate front-end processing, see *HP ACMS for OpenVMS Managing Applications*, *HP ACMS for OpenVMS Writing Applications*, and *HP ACMS for OpenVMS ADU Reference Manual*.

Figure 3-2 Run-Time Processing with a Separate Front End

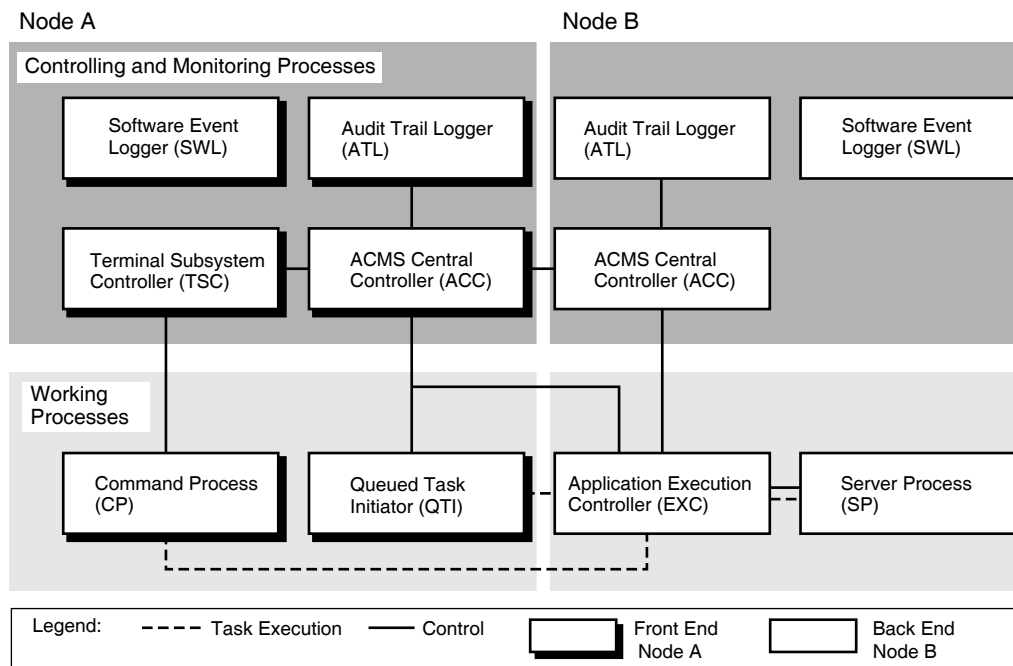

VM-0454A-AI

Managing ACMS Systems and Applications

The ACMS system manager is responsible for the administration, performance, and operation of the ACMS system. After an application is defined and tested, the system manager can make it available to users by:

- Installing the application database in a protected **directory** (an operating system structure that catalogs a set of files stored on a disk or tape)
- Authorizing users and terminals to access ACMS, the application, and tasks in the application
- Starting the ACMS system and application
- Monitoring applications
- Enabling applications to run with terminal I/O shifted to a front-end computer, an OpenVMS Cluster network, or a set of computers
- Tuning the ACMS system by setting quotas, parameters, and privileges so the system runs efficiently

This chapter provides an overview of managing the ACMS system and applications, and describes the tools ACMS provides for this work. For a more detailed explanation of these features, see *HP ACMS for OpenVMS Managing Applications* and *HP ACMS for OpenVMS Remote Systems Management Guide*.

4.1 Authorizing Access to ACMS

When many users share one OpenVMS system, it is important to control the facilities each user can access. For example, some users might need access only to ACMS, while others need access to the OpenVMS operating system as well as to ACMS.

An ACMS system manager uses three tools to control access to the ACMS system:

- The OpenVMS Authorize Utility controls user authorization in general. The Authorize Utility sets up user accounts and assigns OpenVMS privileges and quotas for users. **Privileges** are characteristics assigned to users or programs that determine which operations they can perform. For example, to use most of the ACMS operator commands requires the OpenVMS OPER privilege.
- The **ACMS Device Definition Utility (DDU)** controls which devices on a OpenVMS system have access to ACMS applications, and determines whether a terminal is controlled by the OpenVMS operating system or by ACMS. Authorized ACMS users at terminals controlled by OpenVMS have access to both the OpenVMS operating system and ACMS, while users at terminals controlled by ACMS have access only to ACMS. System managers can also use DDU to allow users to sign in to ACMS automatically.

Managing ACMS Systems and Applications

4.1 Authorizing Access to ACMS

- The **ACMS User Definition Utility (UDU)** controls which authorized **OpenVMS users** can sign in to ACMS and defines characteristics for each user. For example, system managers can use UDU to define ACMS proxies, define which menu a user sees or what a user selects upon entering ACMS.

See *HP ACMS for OpenVMS Managing Applications* for information on how to use DDU and UDU. See your OpenVMS system management documentation for more information about the OpenVMS Authorize Utility.

4.2 Authorizing ACMS Applications

After application definitions are created and application databases are produced with the Application Definition Utility (ADU), the system manager installs the application databases in ACMS\$DIRECTORY (a privileged directory). The system manager defines the location of this directory.

To ensure that only valid application databases are stored in ACMS\$DIRECTORY, the ACMS system manager uses the **ACMS Application Authorization Utility (AAU)** to create an application authorization. This authorization describes characteristics of an application, such as who can install the application database in ACMS\$DIRECTORY and what names are valid for the application.

4.3 Controlling ACMS Applications

The **ACMS operator commands** let you install, start, stop, or modify applications, as well as control which applications are available to which users. Starting and stopping applications individually helps you control the use of resources and the availability of required files and databases.

When you start an application, ACMS allocates the resources the application needs. The tasks in the application are then ready for users to select. When you stop an application, ACMS releases the resources used by the application, and the tasks in the application are no longer available. The following sections explain the types of information you can collect about the ACMS system, applications, and users.

4.3.1 Displaying System and Application Information

Information about the current state of the ACMS system and active applications can be useful when you are controlling the overall operations of an ACMS application. Before you start an application, you can use the ACMS operator commands at DCL level to check whether or not the application is already running, which users are signed in to ACMS, and what tasks are running. With ACMS operator commands, you can display information about:

- One or more applications, including such information as a list of active server processes
- An active application, specifying the intervals at which you want to collect information about the application
- The ACMS system, including a list of active users and applications
- One or more active ACMS users, including the users' names, active tasks, and device names
- One or more active tasks

- One or more active servers
- Task queues that are being processed by the Queued Task Initiator (QTI)

4.3.2 Receiving ACMS Operational Messages

ACMS sends status and other operational messages to terminals that are assigned as ACMS operator terminals.

An operator terminal receives messages from ACMS if an application, the Audit Trail Logger (ATL), or the Terminal Subsystem Controller (TSC) stops unexpectedly. The operational messages are also logged in the software event log (SWL) file. An **ACMS operator**, who is authorized to use ACMS operator commands, can find and correct problems more quickly with an authorized operator terminal than with an error log file only.

4.4 Monitoring ACMS Applications

An important part of managing an ACMS application is keeping track of its activity. For example, you might want to account for the computer resources that an application uses. You might also want to keep track of who uses the applications and what tasks they run. Monitoring an application helps you keep a system running efficiently.

The important tools for monitoring ACMS applications are:

- Audit Trail Logger (ATL), which gathers information about an active ACMS system and writes the information to the audit trail log file
- Oracle Trace™, a product that collects data about events that occur during application run time and writes the information to a data file
- Software Event Logger (SWL), which records all software errors and event messages that occur during the execution of ACMS application programs.

The following sections discuss the ATL, Oracle Trace, and the SWL. For more information about the ATL, Oracle Trace, and the SWL, see *HP ACMS for OpenVMS Managing Applications*.

4.4.1 Using the Audit Trail Logger

The audit log includes information about system and application starts and stops, user sign-ins and sign-outs, processing errors, user task selections, and task completions. You can use this information to determine who is using ACMS, what applications and tasks they are running, and what tasks have been completed or canceled.

The Audit Trail Report Utility (ATR) generates a report containing information recorded by the ATL. The ATR lets you specify the type and extent of information you want in a report, which can be either displayed on a terminal or written to a file. For example, you can produce a report containing a list of all tasks selected and all logins attempted between 9 a.m. and noon. Each record in the report includes:

- Type of information in the record
- Time the record was created
- Description of the recorded event

Managing ACMS Systems and Applications

4.4 Monitoring ACMS Applications

4.4.2 Using Oracle Trace

Oracle Trace reports on events that occur when an application is in use. The data Oracle Trace collects includes process statistics and performance information, such as the working set size at the time an application event occurs. With Oracle Trace, you can collect information about:

- Use of resources
You can check such statistics as response time of an application's data processing and computational functions.
- Ease of use
For example, you can use Oracle Trace to test the design of forms, steps, and tasks by tracing the time it takes to complete a function.
- Users and use of applications
You can collect such information as how many times users complete a form or a task.
- Auditing information
With Oracle Trace, you can collect more detailed auditing information than with ACMS auditing tools. For example, ACMS audit reports can indicate only that a task has started or stopped. With Oracle Trace, you can collect details about the parts of a task.

4.4.3 Using the Software Event Logger

The **Software Event Logger** (SWL), which records all run-time software error and event messages, is another useful tool for tracking errors that occur when an ACMS application is executing.

Each time an error occurs, ACMS writes a message to the SWL log file with information including:

- User information
- Process information
- System time
- Extended error information

The **Software Event Log Utility** (SWLUP) allows you to create reports using information recorded by the SWL.

4.5 Tuning the ACMS System

Once you set your system parameters and quotas, you may have to tune your system occasionally. ACMS provides two command procedures, `ACMSPARAM.COM` and `ACMEXCPAR.COM`, to determine ACMS quotas and parameters after an ACMS installation or upgrade.

Performance of an ACMS application depends mainly on the design of the application and the amount of resource sharing that takes place when the application is executing. In general, using ACMS processes efficiently yields the best performance. When you want to improve system performance:

- Make sure you have adequate hardware resources for your workload
- Examine the design of your application in addition to tuning your operating system

HP ACMS for OpenVMS Concepts and Design Guidelines contains information on how to design your application to avoid performance problems.

See *HP ACMS for OpenVMS Managing Applications* for information on fine tuning your applications. Additional information to help you design your ACMS system and applications to run efficiently appears throughout the ACMS documentation set.

4.6 Using the ACMS Remote Manager

The **ACMS Remote Manager** enables you to control, monitor, and tune your ACMS application environment across a network. As an ACMS system manager, you can communicate with the Remote Manager process over a TCP/IP network using one of the supported interfaces:

- The **SNMP interface** provides network access to ACMS management information using the industry-standard SNMP protocol. This protocol is supported by most leading system management packages (including PATROL from BMC).
- The **RPC interface** provides local or remote access to ACMS management information. This interface is used by the **Remote Manager command-line client** (`ACMSMGR`), the Remote Manager web agent, and user-written programs to access ACMS management information.

`ACMSMGR` provides command line access to management information as well as to the Remote Manager process. This utility can be run from any OpenVMS node that has TCP/IP network connectivity to the ACMS node.

The Remote Manager provides web-based access to management and process information via the Remote Manager Hyper-Media Management Object (`ACMS$MGMT_HMMO`). Integrated into HP's web-based enterprise management (WBEM) architecture, this server-based object communicates with the `WBEM$SERVER` management agent, which handles all communication to and from the client web browser.

The Remote Manager obtains initial configuration information during process startup from a file maintained with the **Remote Manager Configuration Utility** (`ACMSCFG`). Once started, the Remote Manager provides ACMS you with remote access to your ACMS application environment through the selected interface. Using SNMP or RPC commands, you can monitor and manage the system data being collected and operation of the interfaces themselves.

Managing ACMS Systems and Applications

4.6 Using the ACMS Remote Manager

See *HP ACMS for OpenVMS Remote Systems Management Guide* for information on installing, configuring, and using the ACMS Remote Manager in your ACMS application environment.

ACMS Product Kits and Documentation

This chapter outlines the ACMS product kits and describes ACMS documentation. It summarizes the contents and intended audience of each book in the documentation set.

5.1 ACMS Product Kits

ACMS is available in three software kits:

- **ACMS Development System**

The ACMS development system contains all the components you need to create and control ACMS applications. You can define, build, and debug multiple-step tasks and task groups, as well as menus and applications.

You must have the CDD dictionary installed on your system to run the full development kit.

The development system includes both the run-time option and the remote access option software. This manual concentrates on the features of the development system.

- **ACMS Run-Time Option**

The ACMS run-time option lets you run existing ACMS applications or programs and change application attributes (for example, menu definitions). With the run-time option, you can define menus and applications, as well as tasks and task groups that use DCL servers.

The run-time option includes all the facilities of the development software except the ACMS Task Debugger, and the ability to define multiple-step tasks that use server procedures. To modify definitions, you must have installed CDD, which is optional with the run-time option. The run-time option includes the remote access option software.

- **ACMS Remote Access Option**

The ACMS remote access option allows you to access ACMS applications running on other nodes in a DECnet network from nodes that do not necessarily have any ACMS applications running on them. The remote access option software lets you place users and the terminal input/output associated with their tasks on one system (a front-end, or submitter, node) and the data storage files on another (a back-end, or application, node).

5.2 ACMS Documentation

The following sections describe the ACMS documentation set. Each section is based on a phase of the application development life cycle, and describes the appropriate documents for that phase of the life cycle. The life cycle is illustrated in Figure 1-7.

ACMS Product Kits and Documentation

5.2 ACMS Documentation

5.2.1 Orientation and Installation

HP ACMS for OpenVMS, Version 5.0 Release Notes

Audience: All ACMS users

Content: Includes specific information about the current ACMS release and contains material added too late for publication in the ACMS documentation. The release notes are available on line only.

HP ACMS Version 5.0 for OpenVMS Installation Guide

Audience: System managers

Content: Describes how to install ACMS and run the Installation Verification Procedure (IVP).

HP ACMS for OpenVMS Getting Started (this manual)

Audience: Application designers, programmers, system/application managers

Content: Provides an introduction to the basic elements of the ACMS transaction processing system. The book explains the concepts of transactions and transaction processing, describes the ACMS run-time system, and introduces the utilities and tools for creating, controlling, and managing ACMS applications. It also includes a glossary of ACMS terms. Uses a simple application and a step-by-step approach to allow the user to develop a complete ACMS application that uses HP DECforms. Provides an overview of the AVERTZ sample application from the perspectives of designers, developers, users, and system managers.)

5.2.2 Planning and Design

HP ACMS for OpenVMS Concepts and Design Guidelines

Audience: Application designers, programmers

Content: Explains ACMS concepts and provides guidelines for designing an ACMS application.

5.2.3 Development and Testing

HP ACMS for OpenVMS Writing Applications

Audience: Application designers, TP system managers, programmers

Content: Explains how to use the ACMS Application Definition Utility (ADU) to define tasks, task groups, applications, and menus. This book describes how to queue and dequeue tasks, perform exception handling, and define distributed transactions.

Describes how to write ACMS applications to run on OpenVMS Alpha and how to migrate ACMS applications from OpenVMS VAX to OpenVMS Alpha.

HP ACMS for OpenVMS Writing Server Procedures

Audience: Application designers, programmers

Content: Explains how to write, debug, and run procedures for ACMS applications, including step procedures that access Rdb, DBMS, and RMS resource managers; initialization procedures; termination procedures; and cancellation procedures. The book also describes how to create message files and how to debug ACMS applications.

Describes how ACMS works with the APPC/LU6.2 programming interface to communicate with IBM CICS applications.

Describes how ACMS works with third-party database managers, with Oracle used as an example.

HP ACMS for OpenVMS Systems Interface Programming

Audience: System designers, programmers

Content: Describes the ACMS Systems Interface (SI) and explains the interface services to submit tasks to an ACMS system from outside ACMS. This guide also explains how to pass data entered by users between task submitters and their tasks.

5.2.3.1 Reference Information

HP ACMS for OpenVMS ADU Reference Manual

Audience: Application designers, TP system managers, programmers

Content: Provides reference information about the phrases, clauses, and commands of the Application Definition Utility (ADU).

HP ACMS for OpenVMS Quick Reference

Audience: All ACMS users

Content: Lists the syntax for all the ACMS utilities. The book also provides a summary of the steps involved in developing an ACMS application, and includes a table that indicates what additional components must be changed when you make changes to any application component.

5.2.4 Implementation and Management

HP ACMS for OpenVMS Managing Applications

Audience: System/application managers, ACMS operators

Content: Describes how to authorize, install, run, and manage ACMS applications, and how to set up distributed ACMS applications. The book provides information on monitoring and tuning ACMS system performance, including setting OpenVMS and ACMS system parameters and process quotas.

HP ACMS for OpenVMS Remote Systems Management Guide

Audience: System managers, application managers, ACMS operators

Content: Description of the features of the Remote Manager for managing ACMS systems, how to use the features, and how to manage the Remote Manager.

Part II

Tutorial

This part is intended for application programmers who are using ACMS software for the first time. The book contains a step-by-step tutorial for developing a simple ACMS application. This application involves the integration of several products: ACMS, HP DECforms, RMS, and Oracle CDD/Repository software.

This chapter gives introductory material and lists the prerequisites for performing a step-by-step tutorial for developing a simple ACMS application. This chapter also provides an overview of ACMS application development concepts. The tutorial begins in Chapter 7.

6.1 Before You Begin

Before you begin, check the following list of prerequisites to ensure that you have everything you need to perform the tutorial application:

- Make sure that your system is running compatible versions of the following software:
 - OpenVMS Alpha or OpenVMS I64
 - ACMS
 - HP DECforms
 - CDD

See the ACMS Software Product Description (SPD) for information about the compatible software versions.

- Become familiar with the OpenVMS operating system and with a text editor such as the Language-Sensitive Editor (LSE). You use a text editor to create and edit the program source elements in this manual.
- Acquire a personal OpenVMS account on a system that is running ACMS, HP DECforms, and CDD software. Check with your system manager to ensure that your account has the necessary privileges to access these products. To run the ACMS Task Debugger as described in Section 9.4, make sure that your OpenVMS account has a BYTLM quota of 50,000.

All the source code developed in this tutorial is available on line. You can view the source files to compare them with those that you create here, or you can copy the online source files instead of typing them yourself. Appendix B lists these files and describes how to access them.

The procedures in this tutorial are written in COBOL. You can, however, write procedures in any high-level language that adheres to the OpenVMS Calling Standard. Also, it is not necessary to be familiar with COBOL to perform the tutorial.

This tutorial application uses an RMS master file to store and retrieve records. RMS is a file management system that is supplied with the OpenVMS operating system. If you are already running database software such as Rdb, you may wish to convert this tutorial application at some later time to one that accesses an Rdb database. In this case, refer to the appropriate database documentation for creating the database and for writing the statements that access it.

6.2 Application Development Life Cycle

Several phases make up the life cycle of an application. For an overall perspective of application development, it is helpful to know where the development phase fits into this life cycle and what assumptions this tutorial makes about the other phases.

Figure 1–7 identifies the phases of the application development life cycle. Section 5.2 lists the ACMS documentation that is useful for each phase. Note that you may have to revisit the intermediate phases several times during the course of developing a complex application.

During the orientation and installation phase, you install the product and deliver training in the development of applications.

During the planning and design phase, you perform requirements analysis, functional analysis, and prototyping for an application.

For the purpose of this tutorial application, assume that the planning and design phase has already been completed. The designers have decided on a nondistributed environment and a simple ACMS application that meets the needs of their personnel administration system. In this system, a user adds a new employee record to a master file or updates an existing employee record. The designers have determined which fields of data an employee record should contain, how those fields should appear on the data entry form, what error checking the application should contain, and other relevant design criteria.

During the development and testing phase, you write and test the code that implements the design of the application. This manual steps you through the coding process. For this tutorial application, you write CDD definitions, HP DECforms IFDL code, ACMS definitions, and COBOL procedures.

The development phase also includes testing the application. This manual steps you through the process of testing your task definitions in the ACMS Task Debugger prior to completing the application. You then have an opportunity to run and test the application more fully at the conclusion of code development.

During the implementation and management phase, you transfer an application from your development system to a production system and fulfill system management requirements for the application. Chapter 12, describes the steps a system manager performs to authorize an ACMS user and an ACMS application on an OpenVMS system. Until your system manager performs these management functions, you cannot install and run this tutorial application.

6.3 ACMS Application Development Concepts

An ACMS application consists of a set of tasks that relate to the functions of a business. A **task** is the unit of work that a user selects from an ACMS menu. Each task usually comprises a sequence of steps that perform this unit of work. You use the ACMS task definition language to define tasks.

Figure 6–1 illustrates the basic principles of the ACMS task definition language (TDL) used to write a task definition. The task definition specifies an interface to the **presentation service** (forms management system) for communication with a terminal or other device. The task definition also specifies an interface to a **procedure server** for executing procedures (user-written subroutines) that handle database I/O and computational work.

6.3 ACMS Application Development Concepts

The semantics of the ACMS task definition language are based on a call and return model. Task definition steps perform calls to the presentation service in exchange steps, and to the procedure server in processing steps. The presentation service and procedure server perform a function and return control to the task definition. Upon return of control to the task definition, subsequent parts of a step can evaluate the results of the call and, if necessary, handle any error conditions.

Figure 6–1 shows a sample execution flow of a task definition:

1. In the first exchange step, the task definition calls the presentation service to display a form on the terminal screen (for example, a form to add a new employee record to a database). When the terminal user finishes filling in the form, the user presses a specified key (or keys) that allows the task definition to receive the input data.
2. In the processing step, the task definition then calls Procedure 1 in the procedure server to write that input data to the database. Procedure 1 then returns its results (either success or failure). If Procedure 1 fails to write to the database, step 2 then passes control to step 3.

Figure 6–1 Execution Flow of an ACMS Task Definition

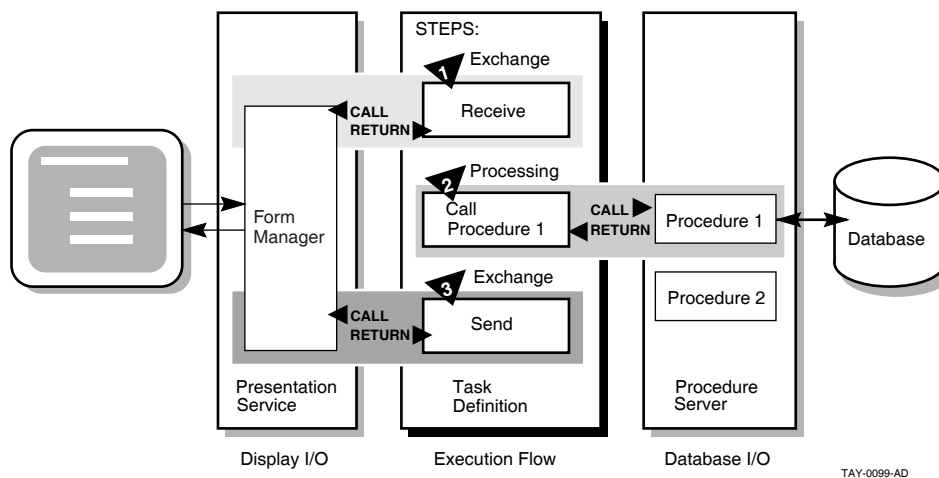

3. In the second exchange step, the task definition calls the presentation service to send an error message to the terminal screen (for example, that the employee number of the new record duplicates an existing employee number). The presentation service then returns control to step 3.

6.3.1 Writing ACMS Definitions

The ACMS task definition language allows you to write an ACMS definition as a series of simple, English-like statements. The four types of ACMS definitions are:

- A **task definition** describes, in steps, the work to be accomplished in the task. For example, a task can collect information from a user and call a procedure to store the information in a file or database.
- A **task group definition** specifies similar tasks for control purposes and defines resources common to all tasks in the group.

Introduction

6.3 ACMS Application Development Concepts

- An **application definition** describes the environment and control characteristics of tasks and task groups.
- A **menu definition** describes how users access one or more applications. Usually this definition allows users to access one or more tasks from an ACMS menu.

You build the task, task group, and application definitions into an application that runs under the control of the ACMS run-time environment. You build a menu definition separately, because it is not necessarily tied to a single application.

Figure 6–2 illustrates the ACMS development components for this tutorial application. This application is a simple personnel system that contains two tasks:

- The first task asks the user to enter employee data. The user can then save this data in a master file.
- The second task displays an employee record from the master file when the user enters an existing employee number. After examining the record, the user can change the information in it and write the changed record back to the file.

Figure 6–2 ACMS Application Components

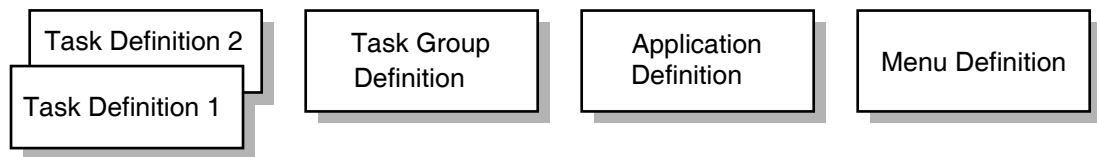

TAY-0217-AD

Figure 6–2 does not show that there can be more than one task group definition specified for a single application. Also, more than one menu definition can specify tasks that point to the same application. Conversely, a single menu definition can specify tasks in different applications.

Because ACMS applications are modular, you develop each part of an application independently. If you need to change a task definition later, the change does not necessarily affect the task group, application, or menu definitions. Many types of changes do not affect other modules.

6.3.2 Composition of ACMS Definitions

A task definition controls the exchange of information with the user, and the processing of that information against the file or database. Each ACMS task definition is made up of one or more steps. ACMS breaks the work to be accomplished by a task into two types of steps:

- **Exchange steps** usually interact with the Form Manager to handle forms I/O (that is, the input and output between the task and the user). An exchange step can interact with HP DECforms or TDMS forms, or interface with other devices using the ACMS Request Interface or the ACMS Systems Interface for communicating with nonstandard devices. Figure 6–1 illustrates an execution flow with two exchange steps.

6.3 ACMS Application Development Concepts

- **Processing steps** call step procedures (user-written subroutines) to handle computations and interactions with databases or files, typically using procedures written in a high-level programming language (any language adhering to the OpenVMS Calling Standard). ACMS uses two types of servers: procedure servers for executing a procedure, and DCL servers for invoking images or DCL commands. Figure 6–1 illustrates an execution flow with one processing step.

A server process may perform an initialization routine of common work when the server is started, rather than each time a task is selected. ACMS manages pools of servers to save on image activation.

Servers are serially reusable (that is, while attached to a task, a server process is not available to other tasks until the task call has completed). A single server process can be called by many different ACMS tasks in a serial fashion. Once the call is complete, the server is then available to be called by another ACMS task.

When ACMS starts a processing step, it allocates a **procedure server process** to a task to execute the procedure in that step. This single-threaded process remains allocated to the task for the duration of one or more processing steps.

In ACMS, a **workspace** is a buffer used to pass data between the task and processing steps, and between the task and exchange steps.

Task group definitions combine similar tasks of an application that need to share common resources such as workspaces, a library of presentation services requests, and procedure servers.

The application definition describes:

- Task groups that belong to an application
- Characteristics that control the tasks, such as security restrictions on which users can select a particular task
- Servers, such as the number of server processes that can be active at the same time
- The application, such as whether application activity is recorded in the audit trail log

Menu definitions list both tasks and additional menus that a user can select from a menu. For example, the tasks on a menu can include adding new employee records, displaying employee information, and entering labor data.

When you write definitions for ACMS tasks, ACMS automatically stores the definitions in a CDD dictionary. At run time, the definitions are represented in binary form in ACMS-defined databases. For example, a task group definition is represented by a task group database that contains a binary representation of the task group definition.

6.4 ACMS Integration with HP DECforms

Although ACMS supports several presentation services, ACMS supports HP DECforms as its primary presentation service. HP DECforms provides such features as FIMS compliance, device-class independence, storage of form context between exchanges, input verification (values, ranges, and types), and escape routines.

Introduction

6.4 ACMS Integration with HP DECforms

6.4.1 HP DECforms Concepts

HP DECforms architecture provides a full separation of form from function. This separation allows you to write an application program (the function) without being concerned with the intricacies of the user interface (the form) for that program.

Normally, the term *form* means a document with blanks for the insertion of information. In HP DECforms, however, the **form** is a specification that may govern the complete user interface to an application program. The form specification completely describes all terminal screen interactions, the data that is transferred to and from the screen, and any display processing that takes place.

A **panel** consists of the information and images that are physically displayed on the user's terminal screen. A panel is composed of such items as fixed background information (literals), fields (blanks for insertion of information), attributes, function key control, and customized help messages.

You can partition the display into rectangular areas called **viewports** by specifying viewport declarations within the form definition. You can adjust the viewport to any size and locate it anywhere on the display (such that viewports overlap one another). For a panel to be visible, it must be associated with a viewport.

Figure 6-3 illustrates the concept of specifying panel declarations and viewport declarations within the HP DECforms form definition. You specify a viewport name within each panel declaration. By doing this, you map each panel to a specific viewport. At run time, each panel appears on the terminal screen within its viewport.

Figure 6-3 Panels and Viewports

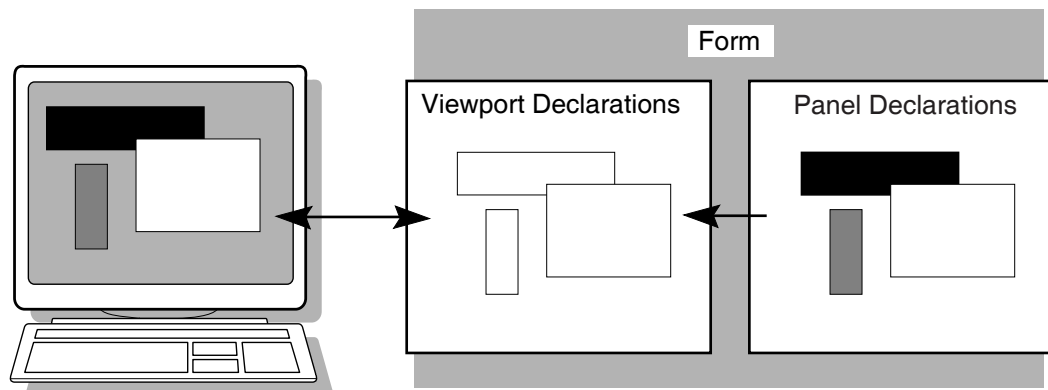

TAY-0212-AD

The HP DECforms **Form Manager** is the run-time component that provides the interface between the terminal display and an ACMS application. The Form Manager controls panel display, user input, and data transfer between the form and ACMS. A HP DECforms form is loaded by the Form Manager at execution time under the direction of an ACMS application program.

ACMS begins a session with HP DECforms when an ACMS application program first references the form. The syntax that references the form is contained in the ACMS task definition.

Note

In normal HP DECforms programming practice, both panels of this tutorial application are defined in a single form. However, the tutorial application defines a separate form for each panel simply to illustrate how ACMS handles multiple forms. For advanced HP DECforms design and programming, see *DECforms Guide to Commands and Utilities*.

6.4.2 ACMS Interaction with HP DECforms

In HP DECforms, the **form record** is a structure that controls data transfer between ACMS and the form. The form record identifies which **form data items** (variables associated with the form) are to be returned to ACMS.

Figure 6–4 shows the interaction between HP DECforms and ACMS when ACMS requests information from HP DECforms.

Figure 6–4 HP DECforms Interaction with ACMS

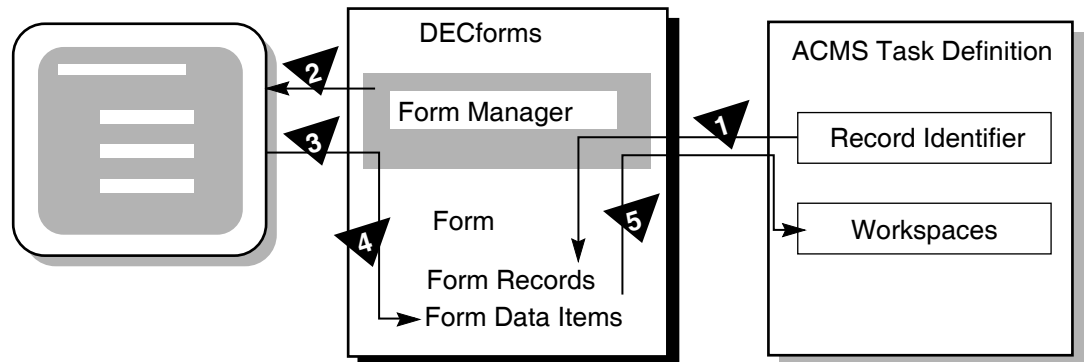

TAY-0101-AD

The following steps are the sequence of events that occur when ACMS requests information from HP DECforms:

1. To request information, ACMS calls the Form Manager with a `RECEIVE` or `TRANSCIVE` call. In that call, ACMS performs the following operations:
 - a. Tells the Form Manager the name of the form needed to collect data.
 - b. Tells the Form Manager the record identifier being received.
 - c. Gives the Form Manager the ACMS workspaces used to transfer data.
2. The Form Manager displays a panel on the user's terminal screen. The displayed panel is specified in the form that ACMS names in its `RECEIVE` or `TRANSCIVE` call to HP DECforms.
3. The Form Manager accepts input from the user's terminal.
4. The Form Manager uses the form record to store the user's input data in the appropriate form data items.
5. The Form Manager completes the request by returning data to the ACMS workspaces.

Introduction

6.5 ACMS Integration with Resource Managers

6.5 ACMS Integration with Resource Managers

Resource managers (RMs) are the software products that store and manage the data accessed by ACMS applications. A resource manager controls shared access to a set of recoverable resources, such as a database.

All HP's resource managers provide access to recoverable data. Step procedures can access the following resource managers either locally or remotely:

- Rdb database management system
- DBMS database management system
- RMS file management system
- ACMS queuing facility

6.5.1 Accessing a Database or a Master File

HP's resource managers are not an integral part of the TP system, but are instead under the control of the operating system (OS). This OS control of resource managers permits database sharing among TP and non-TP applications, decision support systems, and remote nodes requesting data.

ACMS supports Rdb as its primary database management system. For Rdb conceptual information, refer to the Rdb documentation.

For the sake of simplicity, this tutorial application uses an RMS master file to store and retrieve records. RMS is an OpenVMS-supplied file management system that supports sequential, relative, or indexed files. The initialization procedure in this tutorial creates the RMS file (EMPLOYEE.DAT) when you run the application for the first time.

6.5.2 ACMS Interaction with a Resource Manager

To access a database, ACMS interacts with a procedure server process. The procedure server process, in turn, interacts with the resource manager of the database. As shown in Figure 6–5, processing steps call step procedures (user-written subroutines) to handle interactions with the resource managers of databases or files.

ACMS uses a procedure server process for executing a procedure. When starting a processing step, ACMS allocates a procedure server process to execute the procedure in that step. The procedure server process remains allocated to the task for the duration of one or more processing steps in the task.

In an update task, you need at least one exchange step to prompt the user for a key value, and another to display the requested record for modification. You need one processing step to retrieve the record from the database, and another to write the record back to the database with the user's changes. Figure 6–5 shows the interactions among ACMS, the procedure server, and the resource manager to execute a simple update task.

Figure 6–5 A Resource Manager Interacting with ACMS

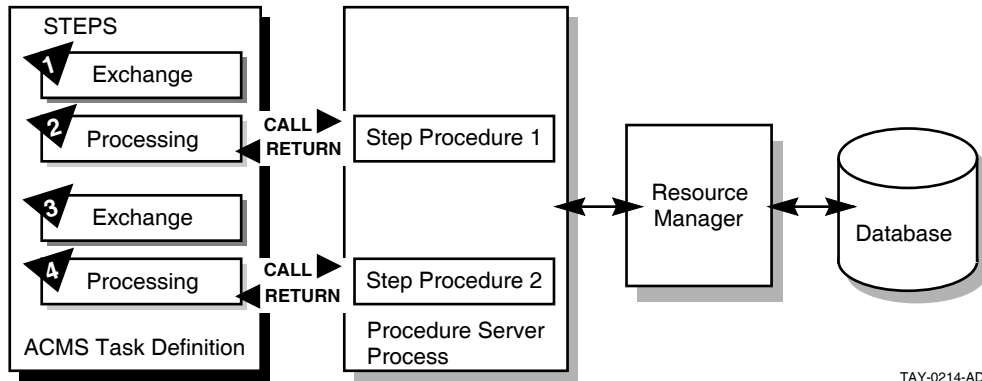

The following steps are the sequence of events that executes the update task:

1. An exchange step calls the Form Manager (not shown) to display a panel on which the user can supply a key value (for example, an employee number).
2. A processing step calls procedure 1, which in turn retrieves an employee record from the database through its resource manager. The record retrieved matches the employee number that the user entered.
3. An exchange step calls the Form Manager to display a panel with the information contained in the employee record. The user can modify this information (for example, change the employee's address).
4. A processing step calls procedure 2, which in turn writes the modified employee record to the database.

For a full picture of the ACMS execution flow that includes the Form Manager's role in exchange steps, refer to Figure 6–1.

6.6 Defining Fields and Records in CDD

The CDD dictionary system provides a central storage repository for shareable data definitions. CDD is an active dictionary system that provides the user interface known as CDO (Common Dictionary Operator).

The dictionary contains metadata (descriptions of data) in the form of dictionary definitions. The most commonly used dictionary definitions are fields, records, and databases.

A **field definition** describes the data that can be stored in a specific field in your application. Field definitions typically include information such as data type and size. The tutorial application defines the following fields: employee number, name, street address, city, state, and zip code.

A **record definition** typically consists of a grouping of field definitions. The tutorial application defines a record named `EMPLOYEE_INFO_RECORD`, which contains a group of field definitions corresponding to the preceding fields.

This tutorial application creates your personal CDD dictionary. It also sets up your default CDD directory so that all your definitions are located there automatically. By setting a default CDD directory, the tutorial application can identify `EMPLOYEE_INFO_RECORD` by its name alone (without having to use its full path name).

Developing the Data Entry Task

This chapter describes in step-by-step detail how to write the Data Entry Task using ACMS, HP DECforms, and CDD definitions. Before you begin, check the prerequisites for this tutorial listed in Section 6.1.

7.1 Defining a CDD Environment

This tutorial application requires you to create a personal CDD directory. You then need to define this directory to be your default CDD directory, so that all your definitions are located there automatically.

Your system manager can help you decide where to locate your CDD directory by choosing one of the following alternatives:

- Create your personal subdirectory under CDD\$COMPATIBILITY (a system logical that on most systems points to the system dictionary directory SYS\$COMMON:[CDDPLUS]).
- Or, define a directory in your own account to be your dictionary (for example, USER\$1:[JONES.CDD]).

The directory used as your CDD dictionary in this tutorial is represented by the placeholder disk:[cdd_directory]. When this specification appears on subsequent pages, you are required to enter the disk name and directory name where your CDD dictionary is located (for example, USER\$1:[JONES.CDD]).

If your system manager determines that you should define a dictionary in your own OpenVMS account, you must first create a subdirectory for this purpose (for example, a subdirectory named CDD in an account such as USER\$1:[JONES]). For example:

```
$ CREATE/DIRECTORY [JONES.CDD]
```

This subdirectory must remain dedicated to your CDD dictionary; CDD stores its files there. Do not store your source files or any other OpenVMS files in this directory.

To set up your personal CDD directory, follow these steps:

1. Enter the CDD Dictionary Operator Utility by issuing the following command:

```
$ DICTIONARY OPERATOR  
CDO>
```

CDD responds by displaying the CDO> prompt.

2. This step is required only if you are creating a CDD dictionary in your own OpenVMS account. (If you are attaching your personal CDD directory to the system dictionary, CDD\$COMPATIBILITY, skip this step). Note that the following command line ends with a period:

Developing the Data Entry Task

7.1 Defining a CDD Environment

```
CDO> DEFINE DICTIONARY disk:[cdd_directory].
CDO>
```

For `cdd_directory`, substitute the name of the directory that you created as your CDD dictionary (for example, `[JONES.CDD]`).

3. Set your default directory to the directory that will be your CDD directory:

```
CDO> SET DEFAULT disk:[cdd_directory]
CDO>
```

Issue the `SHOW DEFAULT` command to verify this:

```
CDO> SHOW DEFAULT
disk:[cdd_directory]
CDO>
```

4. Create a CDD subdirectory to use as your personal directory. Substitute your directory name for `d_name` in this example and elsewhere in this manual (for example `PJ_DICTIONARY`). Note that this command line ends with a period:

```
CDO> DEFINE DIRECTORY disk:[cdd_directory]d_name.
CDO>
```

A dictionary directory is a named section of a dictionary that you use to hold your field and record definitions. Issue the `DIRECTORY` command to check that the subdirectory you created is listed in your anchor directory:

```
CDO> DIRECTORY
```

CDO displays the contents of `disk:[cdd_directory]`; your personal subdirectory (dictionary) is listed as a directory.

```
Directory disk:[cdd_directory]
.
.
.
d_name                                DIRECTORY
CDO>
```

5. Exit from CDO:

```
CDO> EXIT
$
```

6. Using a text editor, edit your login command file to define the logical name `CDD$DEFAULT`. The CDO uses this logical name to set your default CDD directory whenever you invoke CDO. Also, to enter CDO more quickly, define a symbol for the `DICTIONARY OPERATOR` command. Add the following lines to your login command file:

```
$ DEFINE CDD$DEFAULT disk:[cdd_directory]d_name
$ CDO    ::= DICTIONARY OPERATOR
```

Save your login command file and exit the editor.

7. Issue the following commands to execute your edited login command file and to make sure that your default directory is set correctly:

```
$ @LOGIN.COM
$ CDO
CDO> SHOW DEFAULT
CDD$DEFAULT
    = disk:[cdd_directory]d_name
CDO>
```

8. Exit from CDO:

```
CDO> EXIT  
$
```

7.2 Defining a CDD Record

In this chapter, you create your first source files: CDD files, HP DECforms files, ACMS files, and COBOL files. The easiest way to manage these files is to create them all in the same OpenVMS directory.

This manual assumes that you are using your default OpenVMS directory (udisk:[uname]) to hold your source files. In this manual, udisk represents your OpenVMS disk name, and uname represents your OpenVMS directory name (for example, USER\$1:[JONES]). Make sure that you are located in your default OpenVMS directory when you create a source file.

To define fields and records in your CDD dictionary, follow these steps:

1. Using a text editor, create a source file, EMPLOYEE_FIELDS.CDO, in your OpenVMS default directory. (All source files are available on line, if you choose to copy them instead of typing them yourself. See Appendix B for their location.) Type in your field definitions as follows:

```
DEFINE FIELD EMPL_NUMBER  
    DATATYPE TEXT SIZE 10.  
  
DEFINE FIELD EMPL_NAME  
    DATATYPE TEXT SIZE 30.  
  
DEFINE FIELD EMPL_STREET_ADDRESS  
    DATATYPE TEXT SIZE 30.  
  
DEFINE FIELD EMPL_CITY  
    DATATYPE TEXT SIZE 20.  
  
DEFINE FIELD EMPL_STATE  
    DATATYPE TEXT SIZE 2.  
  
DEFINE FIELD EMPL_ZIP_CODE  
    DATATYPE TEXT SIZE 10.
```

Because input records of this format are eventually filled in with alphabetic and numeric data typed at the terminal, the data type of all the fields is TEXT, which can be either alphabetic or numeric. In a more complex application, you would probably use other data types such as NUMERIC. The SIZE information specifies the maximum number of characters that the value of a field can have.

Save this file and exit the editor.

2. Execute the source file to place these field definitions in your dictionary:

```
$ CDO  
CDO> @EMPLOYEE_FIELDS  
CDO>
```

If you do not have the necessary privileges to define an object in CDO, or if you have not turned on your privileges (with the SET PROCESS/PRIV=xxxx command), you receive an "insufficient privileges" message here. If so, see your system manager about required privileges.

Developing the Data Entry Task

7.2 Defining a CDD Record

To check that a field is in your CDD directory, you can issue the **SHOW FIELD** command. For example:

```
CDO> SHOW FIELD EMPL_NUMBER
Definition of field EMPL_NUMBER
| Datatype          text size is 10 characters
CDO>
```

3. Exit from CDO. Create a source file named **EMPLOYEE_INFO_RECORD.CDO**. Type the following lines:

```
DEFINE RECORD EMPLOYEE_INFO_RECORD.
  EMPL_NUMBER.
  EMPL_NAME.
  EMPL_STREET_ADDRESS.
  EMPL_CITY.
  EMPL_STATE.
  EMPL_ZIP_CODE.
END RECORD.
```

Save this file and exit the editor.

4. Execute the source file:

```
$ CDO
CDO> @EMPLOYEE_INFO_RECORD
CDO>
```

Issue the **SHOW RECORD** command to check that your record is accurate:

```
CDO> SHOW RECORD EMPLOYEE_INFO_RECORD
Definition of record EMPLOYEE_INFO_RECORD
| Contains field      EMPL_NUMBER
| Contains field      EMPL_NAME
| Contains field      EMPL_STREET_ADDRESS
| Contains field      EMPL_CITY
| Contains field      EMPL_STATE
| Contains field      EMPL_ZIP_CODE
CDO>
```

You can display the data type and length of each field in the record by using the **/FULL** qualifier after the **SHOW RECORD** command.

To display a list of all fields and records in your default CDD directory, issue the **DIRECTORY** command:

```
CDO> DIRECTORY
Directory disk:[cdd_directory]d_name
EMPLOYEE_INFO_RECORD;1          RECORD
EMPL_CITY;1                     FIELD
EMPL_NAME;1                     FIELD
EMPL_NUMBER;1                   FIELD
EMPL_STATE;1                    FIELD
EMPL_STREET_ADDRESS;1          FIELD
EMPL_ZIP_CODE;1                 FIELD
CDO>
```

5. Exit from CDO. Create a source file named **EMPLOYEE_INFO_WKSP.CDO**. Type the following lines:

```
DEFINE RECORD EMPLOYEE_INFO_WKSP.  
  EMPL_NUMBER.  
  EMPL_NAME.  
  EMPL_STREET_ADDRESS.  
  EMPL_CITY.  
  EMPL_STATE.  
  EMPL_ZIP_CODE.  
END RECORD.
```

Save this file and exit the editor.

6. Enter the EMPLOYEE_INFO_WKSP definition in CDD by executing the source file:

```
$ CDO  
CDO> @EMPLOYEE_INFO_WKSP  
CDO>
```

7. Exit from CDO.

Note

In this tutorial, the record EMPLOYEE_INFO_RECORD is the same as the workspace (EMPLOYEE_INFO_WKSP) that ACMS passes to HP DECforms. In many ACMS applications these records are not identical. You often pass a workspace that contains fewer fields than the record definition. Both the record and the workspace definitions are included in this tutorial as examples of the usual practice in ACMS application definitions.

7.3 Creating a Form Using HP DECforms

The easiest way to design HP DECforms panels in a form is to use the HP DECforms Panel Editor in the Form Development Environment (FDE). The definition of the panel that you create is automatically stored in a form source file with the file type of .IFDL (Independent Form Description Language).

7.3.1 Creating a Basic Form

To enter FDE and create a basic form and source file, follow these steps:

1. Edit your login command file to define a symbol for the FORMS DEVELOP command:

```
$ FDE ::= FORMS DEVELOP
```

Save your login command file and exit the editor.

2. Execute your edited login command file:

```
$ @LOGIN.COM
```

3. Enter the FDE symbol to enter the HP DECforms interactive environment:

```
$ FDE
```

If the HP DECforms system starts successfully, the system prompts you for a file name. However, if HP DECforms does not recognize your device type, the system responds that this operation must be done with a 100, 200, or 300 series terminal. In this case, issue the SET TERMINAL/INQUIRE command at the dollar (\$) prompt and repeat this step.

Developing the Data Entry Task

7.3 Creating a Form Using HP DECforms

4. Type the name `EMPLOYEE_INFO_FORM` at the prompt:

```
_Input_File: EMPLOYEE_INFO_FORM
```

After you enter your form name, HP DECforms displays two messages:

```
Form Development Environment starting...  
Creating a new form file called: UDISK:[UNAME]EMPLOYEE_INFO_FORM.FORM
```

HP DECforms then displays a screen that prompts you to accept a default layout for your panel (see Figure 7-1).

Note

If you copied the online IFDL source files to your default directory before starting this tutorial, HP DECforms translates the existing IFDL file here and loads the resulting FORM file. It displays the Main Menu instead of Figure 7-1. In this case, use the arrow keys to choose the Exit option and press `Select`. Proceed to Section 7.3.4, step 2.

Figure 7-1 DECforms LAYOUT Screen

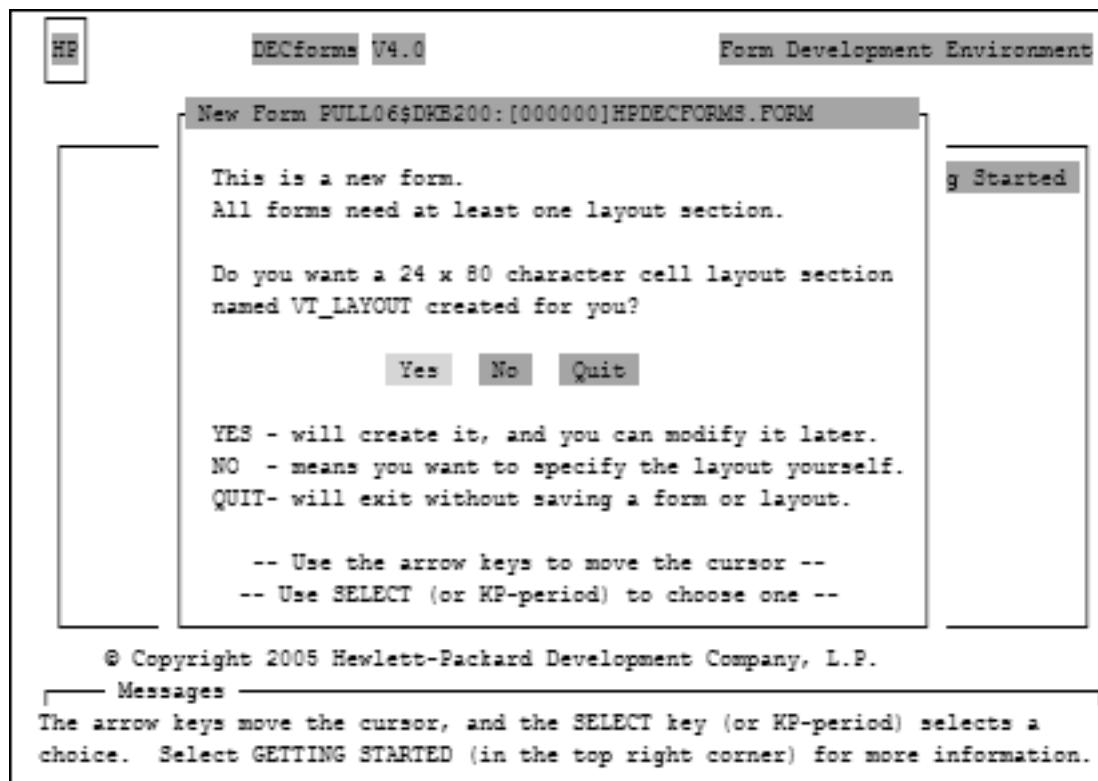

VM-0410A-AI

On HP DECforms screens, use the arrow keys to move the cursor among the options that are displayed. Then press `Select` to register your choice of options.

Developing the Data Entry Task

7.3 Creating a Form Using HP DECforms

5. Press `[Select]` to accept the default of Yes, because the example in this tutorial uses just one layout for all types of terminals and users. HP DECforms next displays the FDE Main Menu, shown in Figure 7–2.

Figure 7–2 FDE Main Menu

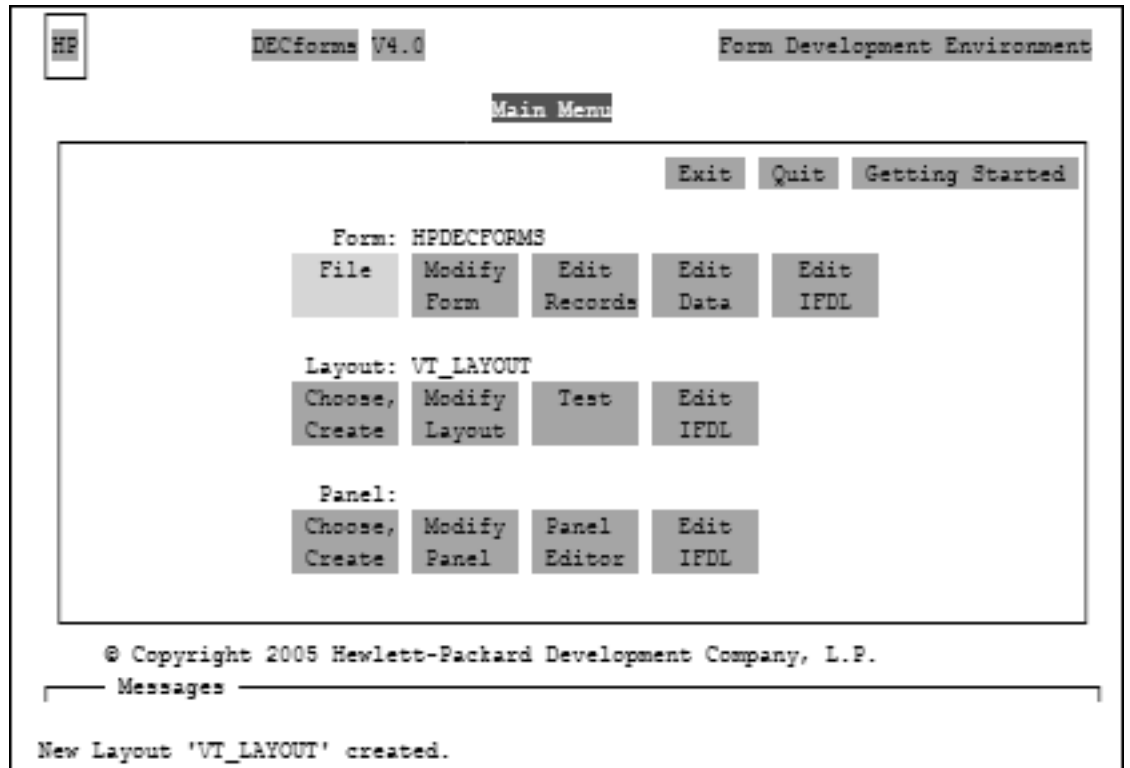

VM-0411A-AI

6. Using the arrow keys, move the cursor to the EXIT option. Then press `[Select]`. HP DECforms saves all the entries you made and then displays the following messages notifying you that your form has been saved in a form source file and in a binary file:

```
IFDL saved in file: UDISK:[UNAME]EMPLOYEE_INFO_FORM.IFDL;1.
Form saved in file: UDISK:[UNAME]EMPLOYEE_INFO_FORM.FORM;1.
```

You have now created a basic form.

7. Enter the TYPE command and your IFDL source file name to display the IFDL source file:

```
$ TYPE EMPLOYEE_INFO_FORM.IFDL
```

In the form source file, HP DECforms places IFDL statements that identify the form and the layout selected. By selecting the default layout, you cause HP DECforms to create the following lines:

Developing the Data Entry Task

7.3 Creating a Form Using HP DECforms

```
Form EMPLOYEE_INFO_FORM
<FF>
  Layout VT_LAYOUT
    Device
      Terminal
        Type %VT100
      End Device
    Size 24 Lines by 80 Columns
  End Layout
End Form
```

To make your form useful, create a panel that produces a display on the terminal screen. The next section contains instructions for doing this.

7.3.2 Creating a Panel

Follow these instructions to access the Panel Editor and design a panel:

1. Reenter FDE by issuing the FDE command and your form name:

```
$ FDE EMPLOYEE_INFO_FORM
```

HP DECforms displays the FDE Main Menu (see Figure 7–2).

2. Press the down-arrow key to move the cursor to the third line (the Panel line), and press **Select** at the first choice: Choose, Create. HP DECforms superimposes another panel on the FDE Main Menu (see Figure 7–3).
3. Press **Select** at the menu choice: Create Panel. HP DECforms displays the Create Panel screen (see Figure 7–4), containing panel attributes and their default values marked by a diamond.

Developing the Data Entry Task 7.3 Creating a Form Using HP DECforms

Figure 7-3 Choose/Create Panel Menu

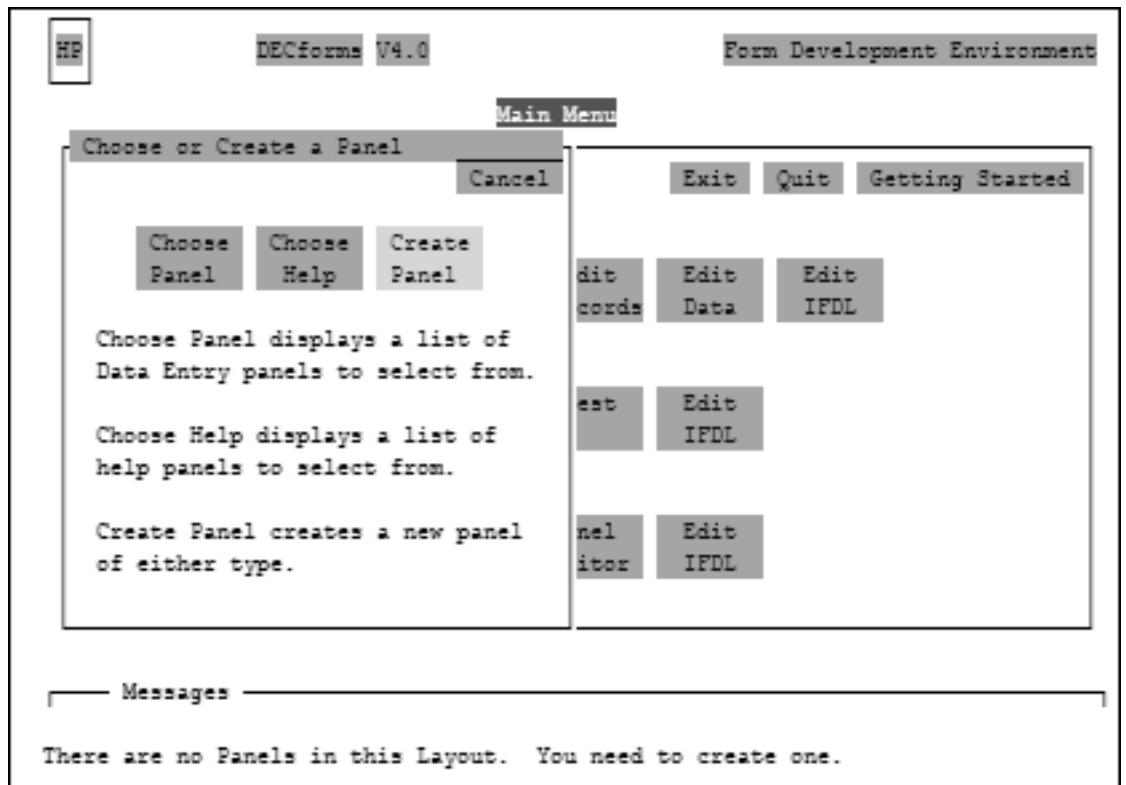

VM-0412A-AI

Developing the Data Entry Task

7.3 Creating a Form Using HP DECforms

Figure 7-4 Create Panel Screen

The screenshot shows the 'Create PANEL' screen in the HP DECforms V4.0 environment. The screen is titled 'Form Development Environment'. At the top, there are three buttons: 'OK', 'Cancel', and 'Help'. The main form has the following fields and options:

- Panel Name:** A text input field with a cursor, currently empty.
- Type:** Radio buttons for '(+) Data Entry' (selected) and '() Help'.
- Viewport Name:** A text input field with '<Default Viewport>'.
- Lines 1 thru 24, Columns 1 thru 80:** Radio buttons for '(+) Screen' (selected) and '() Printing'.
- Help Panel:** A text input field with '<Enter a help message here>'.
- Erase on Exit:** Radio buttons for '() Yes - Remove' and '(+) No -- Retain' (selected).
- Keypad Mode:** Radio buttons for '() UnChanged', '() Application', and '(+) Numeric' (selected).
- Terminal Width:** Radio buttons for '(+) Default [UnCh]' (selected), '() UnChanged', '() 80', and '() 132'.
- Colors:** Text labels for 'Back: [Unspecified]', 'Fore: [Unspecified]', 'Bold: [Unspecified]', and 'Rev : [Unspecified]'.

At the bottom, a 'Messages' section displays the text: 'New Panel created. Specify its name.'

VM-0413A-AI

- The Panel Name field is highlighted on your screen. Type the name of the panel you are creating:
Panel Name: EMPLOYEE_INFO_PANEL
Press **[Return]**. The cursor moves to the Data Entry field. The panel type specifies whether the panel is for entering data or displaying help. The diamond before Data Entry indicates that the panel is a data entry panel.
- Press the down-arrow key to move the cursor to Yes-Remove under Erase on Exit. Press **[Select]**. This has the effect of removing the panel from the screen when the user finishes entering data and exits the panel.
- Press the up-arrow key to move the cursor to the OK option in the top right-hand corner. Press **[Select]**. This means that you accept all the values on the screen, including the default viewport size.

Note

HP DECforms displays a panel within a viewport. To specify a viewport size other than the default 24 X 80 dimension, you must first enter a viewport name on the Create Panel screen and then specify line and column numbers to indicate the size of the viewport in which the panel is to be displayed.

After you select OK, HP DECforms redisplay the FDE Main Menu, shown in Figure 7-2.

Developing the Data Entry Task

7.3 Creating a Form Using HP DECforms

7. Move to the Panel Editor menu choice and press `[Select]`. HP DECforms invokes the Panel Editor and places the cursor in the top left-hand corner of a blank screen. You are now ready to format your panel.

Note

Always use the arrow keys to move the cursor within the panel. Do not use the space bar to position the cursor; the space bar creates literal spaces on the panel.

8. Position the cursor with the arrow keys and type the literals on the screen as shown in Figure 7–5. HP DECforms displays the panel to users exactly as you format it.

Figure 7–5 is an example of a data entry panel composed only of literals. The panel includes a message to users indicating how to navigate between fields (using `[Return]` and `[F12]`), how to save the data (using `[Ctrl/Z]`), and how to quit the screen (using `[PF4]`). You define `[PF4]` later in this chapter. Because `[Return]`, `[F12]`, and `[Ctrl/Z]` are predefined in HP DECforms, you do not need to define them for use in this tutorial application.

Figure 7–5 Sample DECforms Panel

```
EMPLOYEE INFORMATION

Employee number:
Employee name:
Street address:
City:
State:
Zip code:

Press Return key to move cursor to next field; F12 to move backward.
Press Ctrl/Z to save data; PF4 to cancel.

Panel: EMPLOYEE_INFO_PANEL           Right Insert
© Copyright 2005 Hewlett-Packard Development Company, L.P.
```

VM-0414A-AI

You must now create the fields that correspond to the literals. A field is that space following the literal in which the user enters the information. For example, a defined space after the Employee name literal is a field in which to enter the employee name.

9. Use the arrow key to position the cursor two spaces after the Employee number literal, and press `[Dc]`. HP DECforms displays the Command> prompt.
10. Type CREATE FIELD after the Command> prompt and press `[Return]`:

```
Command> CREATE FIELD
```

Developing the Data Entry Task

7.3 Creating a Form Using HP DECforms

HP DECforms then displays the Create Field Menu (see Figure 7–6).

Figure 7–6 Create Field Menu

EMPLOYEE INFORMATION

Create Field Menu

Field Name : _____ Help

Data Type... : _____

Picture : _____

() Date Picture Line: 5 Column 19

OK Cancel

Return, Tab - Next Item
F12, Backspace - Previous Item
Select, KP Period - Choose Option

Press Ctrl/Z to save data; PF4 to cancel

Panel: EMPLOYEE_INFO_PANEL Right Insert

VM-0415A-AI

11. Enter the field name and press **Return**:

Field Name: EMPL_NUMBER

Note

Field names that you specify must correspond to field names that you entered in the CDD record definition. In the menu, the numbers that appear after Line and Column indicate where the cursor was when you began to create the field.

12. Press **Select** at the Data Type prompt (the field is highlighted) to display a list of valid data types: atomic, character, and date/time. In the list of character types, move the cursor to Character and press **Select** to register your choice. HP DECforms then superimposes the Data Type Character window, shown in Figure 7–7, on the menu.

Developing the Data Entry Task 7.3 Creating a Form Using HP DECforms

Figure 7-7 Data Type Character Window

EMPLOYEE INFORMATION

Create Data Type Menu VAX VMS

Atomic Types:	Character Types:	Date/Time Types:
<input type="checkbox"/> Byte Integer	<input checked="" type="checkbox"/> Character...	<input type="checkbox"/> ADT
<input type="checkbox"/> Word Integer	<input type="checkbox"/> Integer...	<input type="checkbox"/> Date
<input type="checkbox"/> Longword Integer	<input type="checkbox"/> Decimal...	<input type="checkbox"/> Time
<input type="checkbox"/> Quadword Integer		<input type="checkbox"/> ADT Current
<input type="checkbox"/> Unsigned Byte		<input type="checkbox"/> Date Current
<input type="checkbox"/> Unsigned Word		<input type="checkbox"/> Time Current
<input type="checkbox"/> Unsigned Longword		<input type="checkbox"/> DateTime...
<input type="checkbox"/> DFloating		
<input type="checkbox"/> FFloating		
<input type="checkbox"/> GFloating		
<input type="checkbox"/> HFloating		
<input type="checkbox"/> Short Float		
<input type="checkbox"/> Long Float		

Data Type Character(a)

Size(a): 0

OK Cancel

Panel: EMPLOYEE_INFO_PANEL Right Insert

VM-0416A-AI

13. Enter the size of the field:

Size(a): 10

Use the arrow keys to move the cursor to OK, and press **Select** to confirm your entry.

HP DECforms again displays the Create Field Menu, shown in Figure 7-6.

14. Enter the field picture:

Picture : X(10)

15. Move the cursor to the OK icon and press **Select**.

HP DECforms returns you to your panel and displays a success message at the bottom of your screen. It also displays Xs to indicate the length of the character picture for that field, as shown in Figure 7-8.

Developing the Data Entry Task

7.3 Creating a Form Using HP DECforms

Figure 7–8 Sample Panel with One Data Field Picture

```
EMPLOYEE INFORMATION

Employee number:  XXXXXXXXXX
Employee name:
Street address:
City:
State:
Zip code:

Press Return key to move cursor to next field; F12 to move backward.
Press Ctrl/Z to save data; PF4 to cancel.

Panel: EMPLOYEE_INFO_PANEL      EMPL_NUMBER      Right Insert
Panel field EMPL_NUMBER created
```

VM-0417A-AI

16. Create character fields of the following lengths and pictures in the same manner as in steps 9 through 15:

```
EMPL_NAME          X(30)
EMPL_STREET_ADDRESS X(30)
EMPL_CITY          X(20)
EMPL_STATE         X(2)
EMPL_ZIP_CODE      X(10)
```

Figure 7–9 shows the results of defining all the fields in the panel.

Note

HP DECforms can validate a field of data as soon as the user exits that field. For example, you can write HP DECforms code that checks whether the user entered a valid zip code and, if not, prompts the user to reenter the zip code. This tutorial application, however, does not perform HP DECforms validation. For advanced HP DECforms design and programming, see *DECforms Guide to Commands and Utilities*.

Developing the Data Entry Task 7.3 Creating a Form Using HP DECforms

Figure 7–9 Sample Panel with Data Field Pictures

```
EMPLOYEE INFORMATION

Employee number:  XXXXXXXXXXXX
Employee name:    XXXXXXXXXXXXXXXXXXXXXXXXXXXXXXXXXXXX
Street address:  XXXXXXXXXXXXXXXXXXXXXXXXXXXXXXXXXXXX
City:            XXXXXXXXXXXXXXXXXXXXXXXXXXXX
State:           XX
Zip code:        XXXXXXXXXX

Press Return key to move cursor to next field; F12 to move backward.
Press Ctrl/Z to save data; PF4 to cancel.

Panel: EMPLOYEE_INFO_PANEL      EMPL_NUMBER      Right  Insert
Panel field EMPL_STATE created
Panel field EMPL_ZIP_CODE created
```

VM-0418A-AI

17. Press **Ctrl/Z** to exit from the Panel Editor when you finish creating the panel. HP DECforms displays the following message:
Panel editing finished.
HP DECforms redisplay the FDE Main Menu, shown in Figure 7–2.
18. Test the form by selecting the Test option on the FDE Main Menu. HP DECforms displays a Testing Menu with three more options.
19. Press **Select** to choose the Test Panel option.
FDE displays the panel and prompts you to enter a value for the Employee number field.
20. Type a sample entry for each field in the panel, pressing **Return** after you complete each one. Press **Ctrl/Z** when you complete the panel.
HP DECforms redisplay the Main Menu, shown in Figure 7–2.
21. Use the arrow keys to move the cursor to the Exit icon. Press **Select**. HP DECforms displays messages indicating that it has saved the IFDL and FORM files containing your panel.

7.3.3 Editing the Form IFDL Source File

You now edit the form IFDL source file to include other definitions and special instructions. Note that HP DECforms automatically added a number of statements to your IFDL file when you exited FDE. For example, the Form Data section and the field descriptions in that file are a result of the data fields that you created interactively with HP DECforms.

To edit the form IFDL source file, follow these steps:

1. Use a text editor to open your IFDL source file named `EMPLOYEE_INFO_FORM.IFDL`. When using the LSE editor, for example, enter the following command:

```
$ LSEEDIT EMPLOYEE_INFO_FORM.IFDL
```

Developing the Data Entry Task

7.3 Creating a Form Using HP DECforms

2. Enter a form record description in the IFDL source file following the declaration of the form data items. Enter the following lines after the line "End Data":

```
Form Record EMPLOYEE_INFO_RECORD
  Copy
    EMPLOYEE_INFO_RECORD From Dictionary
  End Copy
End Record
```

The fields in the form record description here must correspond to the form data items defined above the description in the file. In this tutorial, you create a one-to-one correspondence between the form data items and the fields in `EMPLOYEE_INFO_RECORD`, which you previously entered in CDD. The `COPY...FROM DICTIONARY` clause copies that record from CDD.

This one-to-one correspondence of record fields and data items is not a requirement, however. In more complex applications, the fields in a form record description are usually a subset of the list of form data items.

3. Immediately following this definition, enter another form record definition to correspond to a workspace definition that you enter later in CDD (in Section 7.3.5):

```
Form Record CONTROL_WORKSPACE
  ERROR_STATUS_FIELD Character(4)
  MESSAGEPANEL Character(80)
End Record
```

In the data entry task, you need to inform users if they enter an employee number that already exists. A COBOL procedure called from the task checks for this error condition. If the error occurs, the procedure moves the value `DUPL` into the field `ERROR_STATUS_FIELD` in the record `CONTROL_WORKSPACE`.

In your task, you can test the field `ERROR_STATUS_FIELD` for the `DUPL` value. If this value is in the field, you can place an error message in the `MESSAGEPANEL` field of `CONTROL_WORKSPACE`. (The processing step in the task definition discusses this error handling in more detail; see Section 7.4.2.)

A `MESSAGEPANEL` is a special field in a form record. When you specify a `MESSAGEPANEL` field in a form record, any data associated with this field is automatically displayed in a message panel, which appears on any panel you have created. If you do not create your own message panel (this tutorial does not), HP DECforms uses the default message panel, which is the last line (line 24) on a panel display.

4. Enter the following lines after the line "Size 24 Lines by 80 Columns":

```
Function QUIT_KEY
  Is %PF4
End Function
```

This declares a function named `QUIT_KEY` and binds that name to `PF4`. By declaring a function response for `QUIT_KEY` in the next step, you allow the user to stop the task by pressing `PF4`.

5. A function response describes the action you want to occur when a user presses a function key. Enter the following lines after the line "End Function". (Note that there is a space before the F in `FQUIT`.)

Developing the Data Entry Task

7.3 Creating a Form Using HP DECforms

```
Function Response QUIT_KEY
  Remove All
  Return
    " FQUT"
End Response
```

If a user presses **[PF4]** while entering employee information in the panel, the function response directs HP DECforms to remove all viewports from the screen and return the value " FQUT" to ACMS. Within ACMS, the task definition tests a control-key workspace and performs some action based on receiving that value. The space and the F in " FQUT" conform to a special HP DECforms format required to return a receive-control text string. The QUT in this 5-character string are arbitrary characters.

6. To describe other actions that you want to occur at certain times while the application is running, enter the following response lines in the IFDL source file after the line "End Response" of the QUIT_KEY function response:

```
Disable Response
  Request Exit Response
  Remove All
  End Response
End Response

Receive Response EMPLOYEE_INFO_RECORD
  Reset All
  Display EMPLOYEE_INFO_PANEL
  Activate Panel EMPLOYEE_INFO_PANEL
End Response

Transceive Response EMPLOYEE_INFO_RECORD EMPLOYEE_INFO_RECORD
  Display EMPLOYEE_INFO_PANEL
  Activate Panel EMPLOYEE_INFO_PANEL
  Deactivate Field EMPL_NUMBER on EMPLOYEE_INFO_PANEL
  Position to Field EMPL_NAME on EMPLOYEE_INFO_PANEL
End Response

Send Response CONTROL_WORKSPACE
  Activate Wait
  Signal
End Response
```

The Disable Response removes the current screen display by removing all viewports when the form is disabled. This prevents old data from appearing on the screen during transitions from one form to another.

The Receive Response prepares a HP DECforms panel for user input whenever the data entry task definition (Section 7.4) executes its RECEIVE FORM RECORD EMPLOYEE_INFO_RECORD statement. The Receive Response resets all data fields to spaces (clearing any old data). It then displays the specified panel in its viewport and activates all the data fields on that panel (allowing user input to every field on the panel).

The Transceive Response prepares a HP DECforms panel for user input whenever the Inquiry/Update Task definition (Section 8.2) executes its TRANSCEIVE FORM RECORD EMPLOYEE_INFO_RECORD statement. The Transceive Response displays the specified panel and activates all the data fields on that panel. Because the employee number is the record's key field, it cannot be modified. The Deactivate statement prevents the user from modifying the EMPL_NUMBER field when that record is displayed. The Position statement places the cursor on the first field, EMPL_NAME, that the user is allowed to modify.

Developing the Data Entry Task

7.3 Creating a Form Using HP DECforms

The Send Response causes HP DECforms to wait for the user to press a function key whenever ACMS sends HP DECforms a message via the record CONTROL_WORKSPACE. For example, ACMS sends HP DECforms an error message if the user tries to add an employee number that already exists. HP DECforms displays the message, activates a wait, and produces an audible signal. The user can then press `[PF4]` to cancel the transaction, or `[Ctrl/Z]` to begin again.

7. Your EMPLOYEE_INFO_FORM.IFDL file is now complete. Save the edits made in the IFDL file, and exit from the text editor.

7.3.4 Creating the Binary Form File

Whenever you edit your IFDL source file, you must translate that file into an updated binary form file to reflect the edits made in the IFDL file. HP DECforms stores a form internally in a binary form file (with file type .FORM).

You also need to create an object module and a shareable image of the form to use in your ACMS application.

To create a new binary form file, an object module, and a shareable image of your form, follow these steps:

1. Issue the following command to create a new binary form file:

```
$ FORMS TRANSLATE EMPLOYEE_INFO_FORM.IFDL
$
```

When you issue this command, HP DECforms uses the most recent version of your IFDL file to create a new binary file.

2. Issue the EXTRACT OBJECT command as the first step in creating a shareable image of a form:

```
$ FORMS EXTRACT OBJECT EMPLOYEE_INFO_FORM.FORM
$
```

This command creates a form object module, or .OBJ file.

3. Issue the LINK/SHARE command to link the form object module into a shareable image:

```
$ LINK/SHARE EMPLOYEE_INFO_FORM.OBJ
$
```

The result of the LINK/SHARE command is an image (.EXE) of the file that can be shared by multiple users.

7.3.5 Defining Additional CDD Records

You must now define the additional fields and records for a control workspace and a quit workspace. The following steps explain how to create the source files and how to enter these definitions in your CDD dictionary.

1. Using a text editor, create a source file called EMPLOYEE_CONTROL_FIELDS.CDO and enter the following lines. Then exit the file:

```
DEFINE FIELD ERROR_STATUS_FIELD
  DATATYPE TEXT SIZE 4
  INITIAL_VALUE IS " ".
DEFINE FIELD MESSAGEPANEL
  DATATYPE TEXT SIZE 80.
```

Developing the Data Entry Task

7.3 Creating a Form Using HP DECforms

2. Create a source file called EMPLOYEE_CONTROL_WKSP.CDO, enter the following lines, and exit the file:

```
DEFINE RECORD CONTROL_WORKSPACE.  
    ERROR_STATUS_FIELD.  
    MESSAGEPANEL.  
END RECORD.
```

3. Create a source file called EMPLOYEE_QUIT_FIELD.CDO, enter the following lines, and exit the file:

```
DEFINE FIELD QUIT_KEY  
    DATATYPE TEXT SIZE 5  
    INITIAL_VALUE IS "    " .
```

4. Create a source file called EMPLOYEE_QUIT_WKSP.CDO, enter the following lines, and exit the file:

```
DEFINE RECORD QUIT_WORKSPACE.  
    QUIT_KEY.  
END RECORD.
```

5. Execute these four source files by issuing the following commands at the CDO> prompt:

```
$ CDO  
CDO> @EMPLOYEE_CONTROL_FIELDS  
CDO> @EMPLOYEE_CONTROL_WKSP  
CDO> @EMPLOYEE_QUIT_FIELD  
CDO> @EMPLOYEE_QUIT_WKSP  
CDO>
```

6. Exit from CDO.

7.4 Defining the Data Entry Task

The data entry task definition in this tutorial contains three kinds of steps:

- Exchange steps, during which information is exchanged between the terminal user and the ACMS application.
- A processing step that calls a COBOL procedure to handle the I/O interactions between the application and the database (in this case, an RMS master file). The procedures that you call from processing steps are subroutines that you write and link together with a main program module supplied by ACMS.
- A block step, which groups the exchange steps and processing steps into a unit.

The first exchange step displays a form where the user enters new data. The processing step adds a new record to the RMS file with the information the user supplied in the first exchange step. The second exchange step displays a message, if an error is encountered in the processing step.

To define a task, you use commands and clauses of the ACMS Application Definition Utility (ADU). The easiest way to use ADU is to create a source file of ADU commands with a text editor such as LSE. Then submit the file as a command file to ADU, which compiles the task definition.

Developing the Data Entry Task

7.4 Defining the Data Entry Task

7.4.1 Defining the First Exchange Step

You begin an exchange step by identifying it with the ADU keyword `EXCHANGE`. Following the keyword, you use a `SEND`, `RECEIVE`, or `TRANSCEIVE` call to HP DECforms, identifying the direction of exchange:

- `SEND` indicates that you want to send information from the ACMS application *to* the form.
- `RECEIVE` indicates that you want to receive information in the ACMS application *from* the form.
- `TRANSCEIVE` indicates that you want both to send information *to* the form and receive information *from* the form, in that order.

To define the first exchange step in the data entry task definition, follow these steps:

1. Using an editor such as LSE, create a source file for your task definition. Name the source file `EMPLOYEE_INFO_ADD_TASK.TDF`.

```
$ LSEEDIT EMPLOYEE_INFO_ADD_TASK.TDF
```

2. In this file, enter the following lines of this exchange step:

```
GET_EMPL_INFO:
  EXCHANGE
  RECEIVE FORM RECORD EMPLOYEE_INFO_RECORD
  RECEIVING EMPLOYEE_INFO_WKSP
  WITH RECEIVE CONTROL QUIT_WORKSPACE;
```

Use label names (such as `GET_EMPL_INFO`) to mark exchange and processing steps in a task. During debugging, you can then reference each step by its label name rather than by line number.

The purpose of the first exchange step in the data entry task is to obtain user input—users enter data in response to prompts displayed on the terminal screen. In this case, the ACMS application needs to receive information from the form.

A form record name or form record list name must appear after a `SEND`, `RECEIVE`, or `TRANSCEIVE` call to HP DECforms. That name must correspond to a form record defined in the form source IFDL. This tutorial application, for example, uses `EMPLOYEE_INFO_RECORD` here and in your form source file.

You must also include one or more workspace names after the keyword `RECEIVING`. HP DECforms uses these workspaces to pass user-entered data to ACMS.

The `WITH RECEIVE CONTROL` clause specifies the record containing the name of the function key defined in the form source file. In this tutorial, the function `QUIT_KEY` is a field in the record `QUIT_WORKSPACE`.

3. Next, enter a `CONTROL FIELD` statement:

```
CONTROL FIELD IS QUIT_WORKSPACE.QUIT_KEY
  " FQUT" : EXIT TASK;
END CONTROL FIELD;
```

The `CONTROL FIELD` clause tests the contents of a workspace field. Here it tests the value of the `QUIT_KEY` field in the record `QUIT_WORKSPACE`. The clause lists a value that this field can have: `FQUT`. If the value is `FQUT`, the action taken is `EXIT TASK`, which is the ADU clause that ends the current task.

7.4.2 Defining the Processing Step

You begin a processing step by identifying it with the keyword `PROCESSING`. This processing step calls a procedure that adds information to an RMS file.

The processing step is located after the exchange step. Add the processing step as follows:

1. Add these clauses as the first part of your processing step:

```
PROCESS_EMPL_INFO:  
  PROCESSING  
    CALL ADD_EMPL_INFO IN EMPL_SERVER  
      USING EMPLOYEE_INFO_WKSP, CONTROL_WORKSPACE;
```

As mentioned previously, when ACMS starts a processing step, it allocates a server process to handle the procedure in that step. A server process is a specialized OpenVMS process with a user name, privileges, and quotas, just like your own OpenVMS process. (This manual often refers to a server process simply as a **server**.)

In the `CALL` clause, you specify the procedure name and the name of the server in which the procedure executes. The server process (named `EMPL_SERVER` here) can have any name you choose. The procedure (named `ADD_EMPL_INFO` here) must correspond to the `PROGRAM-ID` name that you specify in the COBOL procedure later in this chapter.

The `CALL` clause also includes a `USING` phrase that names the two workspaces that this procedure uses: `EMPLOYEE_INFO_WKSP`, which stores the user input to be passed to the procedure for processing; and `CONTROL_WORKSPACE`, which holds status values and error messages.

2. Add these clauses to your processing step to handle duplicate employee number errors:

```
IF (CONTROL_WORKSPACE.ERROR_STATUS_FIELD EQ "DUPL")  
  THEN  
    MOVE "Employee number already exists. Ctrl/Z to repeat, PF4 to quit."  
      TO CONTROL_WORKSPACE.MESSAGEPANEL;  
  ELSE  
    EXIT TASK;  
END IF;
```

In the data entry task, you need to include a method for reporting any errors that can occur when the processing step attempts to write the new information to the RMS file. When the `ADD_EMPL_INFO` procedure finishes executing, it returns a status value that indicates whether or not the procedure completed successfully.

A common error in a data entry task occurs when the user tries to enter information for a primary key that already exists. For example, in this tutorial application, every employee is uniquely identified by an employee number (the `EMPL_NUMBER` field of `EMPLOYEE_INFO_WKSP`). If a user tries to write a new record to the RMS file with an employee number that already exists, the user receives an error message on the terminal screen.

The `ADD_EMPL_INFO` procedure tests the return status value of the write operation. If the status value corresponds to the COBOL code for the duplicate primary key error, the procedure stores the value `DUPL` in a workspace field.

Developing the Data Entry Task

7.4 Defining the Data Entry Task

The processing step in this task tests the field `ERROR_STATUS_FIELD`, using an `IF` clause. If that field contains `DUPL`, the processing step directs `ACMS` to move an error message to the field `MESSAGEPANEL`, and the task continues to a second exchange step to display the message. Otherwise, if the `DUPL` value is not in the workspace field, control passes to the `ELSE` statement, and the task ends successfully.

7.4.3 Defining the Second Exchange Step

The purpose of the second exchange step is to display an error message if the user tries to enter an employee number that already exists in the `RMS` file (`DUPL` error). Add the second exchange step as follows:

1. The `SEND` statement specifies the name of the form record (`CONTROL_WORKSPACE`):

```
DISPLAY_ERROR_MESSAGE:
  EXCHANGE
    SEND FORM RECORD CONTROL_WORKSPACE
```

2. The `SENDING` statement specifies the name of the workspace that `ACMS` uses to pass the error message to the form. The `RECEIVE CONTROL` clause specifies the name of the record that contains the `QUIT_KEY` field:

```
SENDING CONTROL_WORKSPACE
WITH RECEIVE CONTROL QUIT_WORKSPACE;
```

The record `CONTROL_WORKSPACE` contains the field `MESSAGEPANEL`, which stores the error message corresponding to the `DUPL` error. `HP DECforms` receives the message from `ACMS`, displays the message in its default message panel, and waits for the user to take some action.

3. Enter the following `ACTION` clause to complete the exchange step:

```
ACTION IS
  IF (QUIT_WORKSPACE.QUIT_KEY EQ " FQUT")
  THEN EXIT TASK;
  ELSE REPEAT TASK;
  END IF;
```

The `IF` clause tests the value of the field `QUIT_KEY`. If the value is `FQUT` (that is, if the user presses `PF4`), the action is to exit the task. Otherwise, if the user executes the transmit function (presses `Ctrl/Z`), the action is to repeat the task, sending control back to the first exchange step. In this way, the user can read the error message and choose one of two actions: to end the task or to repeat it.

7.4.4 Defining the Block Step and Workspaces

After defining the exchange and processing steps of a task, you use a block step to place those steps in a group. A block step can have three parts:

- Attributes, an optional part of the block that describes the characteristics of the steps in a block
- Work, a required part of the block that comprises the exchange and processing steps of the task
- Actions, an optional part of the block that describes the action to be taken after the work is done

Developing the Data Entry Task

7.4 Defining the Data Entry Task

To define the block step and the remaining elements of this task definition, you need to add some lines at the beginning of your file and at the end of your file.

1. Enter the following lines at the beginning of your file:

```
REPLACE TASK EMPLOYEE_INFO_ADD_TASK
DEFAULT FORM IS EMPLOYEE_INFO_LABEL;
USE WORKSPACES
  EMPLOYEE_INFO_WKSP,
  QUIT_WORKSPACE,
  CONTROL_WORKSPACE;

BLOCK WORK WITH FORM I/O
```

REPLACE is an ADU command that stores a new task definition in CDD (creating a new definition or replacing an old one). Placing this command inside the task definition allows you to run this task definition (**EMPLOYEE_INFO_ADD_TASK**) as a command file in ADU (see Section 7.5).

The **DEFAULT FORM** clause is an option that specifies a label name used within ACMS to refer to a HP DECforms form. **EMPLOYEE_INFO_LABEL** is mapped to the actual form name (**EMPLOYEE_INFO_FORM**) through the **FORMS** clause in the task group definition. This label name can be identical to the form name. If you do not enter the **DEFAULT FORM** clause at the beginning of a task definition, you need to include the form label name as part of each **SEND**, **RECEIVE**, and **TRANCEIVE** clause in the task definition. For example, **RECEIVE FORM RECORD EMPLOYEE_INFO_RECORD IN EMPLOYEE_INFO_LABEL**.

Those steps that you include in the block step share some characteristics such as the list of the workspaces used in the task to pass information between the task and exchange steps, and between the task and processing steps.

The **BLOCK WORK** clause marks the beginning of the work that takes place within the block step. Because the task communicates with HP DECforms for terminal I/O operations, include the words **WITH FORM I/O**.

2. Enter the following lines at the end of your file:

```
END BLOCK WORK;
END DEFINITION;
```

The **END BLOCK WORK** clause ends the work done within the block step.

3. Your task definition for the Data Entry Task, **EMPLOYEE_INFO_ADD_TASK.TDF**, is now complete. Save your file and exit the editor.

7.5 Compiling the Task Definition in ADU

Compiling the task definition in ADU allows ADU to check for syntax errors in the source file **EMPLOYEE_INFO_ADD_TASK.TDF**. If there are no errors, ADU inserts your task definition into CDD. To do this, perform the following steps:

1. Edit your login command file to define ADU as a global symbol. Then exit the editor and reinitialize your edited login command file:

```
$ ADU := $ACMSADU
$ @LOGIN.COM
```

2. Invoke ADU:

```
$ ADU
```

Developing the Data Entry Task

7.5 Compiling the Task Definition in ADU

3. Type the SET LOG and SET VERIFY commands at the ADU> prompt:

```
ADU> SET LOG
ADU> SET VERIFY
```

SET LOG causes ADU to write the task definition to the ADULOG.LOG file as ADU compiles it, including any error messages. Each time you issue an ADU command, ADU appends log information to this file.

SET VERIFY causes ADU to display the task definition on your terminal screen as ADU compiles it. If your task definition compiles successfully (no error messages), ADU inserts it into your default CDD directory. If there are errors, messages appear in the text of the definition as ADU displays it on your terminal screen.

4. Submit the file EMPLOYEE_INFO_ADD_TASK.TDF, as follows:

```
ADU> @EMPLOYEE_INFO_ADD_TASK.TDF
```

If ADU detects syntax errors in your task definition, exit ADU and edit the source file to correct the errors. Then reenter ADU and resubmit the file. Repeat editing the source file and resubmitting it to ADU until the file processes without errors. If you get error messages, make sure you typed the definition exactly as shown. In particular, check that you used the appropriate punctuation.

5. Exit from ADU:

```
ADU> EXIT
$
```

6. Check that your task definition is now located in your default CDD directory. (In Section 7.1, step 6, you defined CDD\$DEFAULT in your login command file.) Enter CDO and issue the CDO DIRECTORY command:

```
$ CDO
CDO> DIRECTORY

Directory disk:[cdd_directory]d_name
.
.
.
EMPLOYEE_INFO_ADD_TASK;1          ACMS$TASK
CDO>
```

7.6 Defining a System Logical for Your Tutorial Directory

To complete the data entry task, you need to create a procedure that writes a new record to an RMS master file. In this tutorial, the name of this RMS file is EMPLOYEE.DAT.

So that ACMS can find this file, your COBOL procedures need to specify where EMPLOYEE.DAT is located. The easiest way to do this is to define a system logical that points to its location (your OpenVMS directory of source files). Your system logical must be unique so that it does not conflict with logicals used by others who may be entering this same tutorial on your system.

Define the system logical as follows, substituting your initials or other unique characters for xxx. (Remember that udisk and uname represent the disk and user-name directory where your application files are located.)

```
$ DEFINE/SYSTEM xxx_FILES udisk:[uname]
```

Developing the Data Entry Task

7.6 Defining a System Logical for Your Tutorial Directory

If you do not have the necessary privileges to define a system logical, you receive an "insufficient privileges" message here. If so, see your system manager about defining your system logical.

If your account is on an OpenVMS Cluster system, you can be logged in to any of several nodes. In this case, define your logical on each node in the cluster.

You can verify your system logical by issuing the following command:

```
$ SHOW LOGICAL xxx_FILES
```

By defining the system logical `xxx_FILES`, you can use it whenever your procedures and definitions refer to the location of `EMPLOYEE.DAT` and other files used in this tutorial application (substituting your unique logical wherever `xxx_FILES` occurs). For example, in your COBOL procedures:

```
ASSIGN TO "xxx_FILES:EMPLOYEE.DAT" .
```

Note

If you copied the online source files to your default directory before starting this tutorial, edit each file that contains the logical `xxx_FILES` and substitute your unique logical. Section B.2 lists those files that contain the term `xxx_FILES`.

7.7 Defining the Data Entry Procedure

This section describes how to define the COBOL procedure that, when called by the data entry task, writes a new record to the RMS master file.

Create the Data Entry COBOL procedure as follows:

1. Example 7–1 contains the COBOL procedure. Create a source file named `EMPLOYEE_INFO_ADD.COB` and type in the procedure as shown in this example.

Note

If you copied this file from the online source files, edit the file and substitute your unique logical for the `xxx_FILES` logical in the file. Section B.2 lists other files that contain the logical `xxx_FILES`.

2. Save the file and exit the editor.

Developing the Data Entry Task

7.7 Defining the Data Entry Procedure

Example 7–1 COBOL Data Entry Procedure

```
IDENTIFICATION DIVISION.
PROGRAM-ID. ADD_EMPL_INFO.

ENVIRONMENT DIVISION.
CONFIGURATION SECTION.
SOURCE-COMPUTER. VAX-11.
OBJECT-COMPUTER. VAX-11.
INPUT-OUTPUT SECTION.
FILE-CONTROL.
SELECT EMPLOYEE-FILE
        ORGANIZATION INDEXED
        ACCESS RANDOM
        FILE STATUS IS FILE-STAT
        ASSIGN TO "xxx_FILES:EMPLOYEE.DAT".
I-O-CONTROL.
        APPLY LOCK-HOLDING ON EMPLOYEE-FILE.

DATA DIVISION.
FILE SECTION.
FD EMPLOYEE-FILE EXTERNAL
   DATA RECORD IS EMPLOYEE_INFO_WKSP
   RECORD KEY EMPL_NUMBER OF EMPLOYEE_INFO_WKSP.

COPY "EMPLOYEE_INFO_WKSP" FROM DICTIONARY.

WORKING-STORAGE SECTION.
01 FILE-STAT PIC XX IS EXTERNAL.
   88 OK VALUE "00".
   88 DUPL-PRIMARY VALUE "22".
   88 REC-LOCK VALUE "92".

LINKAGE SECTION.
COPY "EMPLOYEE_INFO_WKSP" FROM DICTIONARY REPLACING
   ==EMPLOYEE_INFO_WKSP. == BY ==EMPLOYEE_INFO_LINKAGE_WKSP. ==.
COPY "CONTROL_WORKSPACE" FROM DICTIONARY.

PROCEDURE DIVISION USING EMPLOYEE_INFO_LINKAGE_WKSP, CONTROL_WORKSPACE.
DECLARATIVES.
EMPLOYEE-USE SECTION.
   USE AFTER STANDARD ERROR PROCEDURE ON EMPLOYEE-FILE.
EMPLOYEE-CHECKING.
   EVALUATE TRUE
     WHEN DUPL-PRIMARY
       MOVE "DUPL" TO ERROR_STATUS_FIELD
     WHEN OTHER
       CALL "ACMS$RAISE_NONREC_EXCEPTION" USING
         BY REFERENCE RMS-STS OF EMPLOYEE-FILE
   END-EVALUATE.
END DECLARATIVES.

MAIN SECTION.
000-SET-STATUS.
   MOVE SPACES TO ERROR_STATUS_FIELD.

010-WRITE-RECORD.
   WRITE EMPLOYEE_INFO_WKSP FROM EMPLOYEE_INFO_LINKAGE_WKSP
     ALLOWING NO OTHERS.

100-EXIT-PROGRAM.
   UNLOCK EMPLOYEE-FILE.
   EXIT PROGRAM.
```

The following sections discuss various elements in this COBOL program. For complete reference information on VAX COBOL, see *VAX COBOL Reference Manual*.

7.7.1 Identification Division

In the Identification Division of this program, you give the COBOL procedure a name to complete the PROGRAM-ID statement. This name must be unique among all the procedures that run in the same server, and it must be the same name that you specified previously in your task definition's CALL statement to this procedure.

In this tutorial, the name of the COBOL procedure is ADD_EMPL_INFO.

7.7.2 Environment Division

The Environment Division defines the RMS file named EMPLOYEE.DAT and specifies its location. EMPLOYEE-FILE is the procedure's internal name for referencing the external file EMPLOYEE.DAT, where the procedure stores the information that the user enters. (The file EMPLOYEE.DAT is created by the COBOL initialization procedure defined in Chapter 9.)

You use the SELECT clause to assign the internal name to the RMS file, describe the organization and access of the file, provide a FILE STATUS buffer, and assign the OpenVMS file specification for the RMS file.

The FILE STATUS clause identifies the FILE-STAT data item, where the status value of the write operation is stored. In the I-O-CONTROL section, the APPLY statement enables record locking for EMPLOYEE-FILE.

7.7.3 Data Division

In the Data Division, you define the personnel records that make up the RMS file, naming one field as the primary key. An RMS file in an ACMS application contains records whose definitions reside in CDD. Therefore, the Data Division need not list every field in the record, but can instead include a COPY ... FROM DICTIONARY clause for the record definition.

This procedure identifies EMPLOYEE-FILE as EXTERNAL because the file is accessed externally. The RECORD KEY clause establishes the employee number field, EMPL_NUMBER, as the primary key of the record. The COPY statement directs the procedure to find the definition of EMPLOYEE_INFO_WKSP in the CDD dictionary when you compile this COBOL program.

The Data Division also sets up condition values for you to use in error handling. A user might try to add a new record to the file using an employee number that already exists. The COBOL condition code for the duplicate key error is 22. In the Data Division, you declare the FILE-STAT data item and associate it with the names of the condition values (DUPL_PRIMARY, for example) that your procedure tests during its execution.

Another possible error is when a second user tries to access the record while the procedure is processing the record for the first user. Because the procedure locks the record during I/O processing, the second user encounters a locked-record condition. The COBOL condition code for the locked-record error is 92. You must also associate FILE-STAT with the REC-LOCK condition.

The Linkage Section of this procedure lists the workspaces passed between the task and the procedure. COPY statements describe which CDD record definitions correspond to the workspaces you need. Because the linkage record and the file record must have different names, the COPY statement for EMPLOYEE_INFO_WKSP must use a REPLACING clause to assign a different name to the workspace. This new name is used only in the Procedure Division of the procedure.

Developing the Data Entry Task

7.7 Defining the Data Entry Procedure

7.7.4 Procedure Division

The main action of the Procedure Division is to write a new record to the RMS file. ACMS passes the user input to the procedure in the `EMPLOYEE_INFO_WKSP` workspace, renamed to `EMPLOYEE_INFO_LINKAGE_WKSP` in the Linkage Section. The procedure uses `CONTROL_WORKSPACE` to report any errors. As required, the `USING` clause lists both workspaces in the same order as the `CALL` clause listed them in the task definition.

The Declaratives Section handles any errors in the procedure. If a duplicate primary key error occurs when the procedure tries to write a new record to the file, `FILE-STAT` is assigned the condition value `DUPL-PRIMARY`. The `EVALUATE` statement tests whether the `DUPL-PRIMARY` condition is true. If true, the value `DUPL` is moved to the field `ERROR_STATUS_FIELD` in the record `CONTROL_WORKSPACE`, and the ACMS task definition takes some action (sends an error message) based on finding the `DUPL` value. If any other error condition is true, the procedure cancels the task with the `ACMS$RAISE_NONREC_EXCEPTION` service. See *HP ACMS for OpenVMS Writing Applications* for information about recoverable and nonrecoverable exceptions.

The Main Section of this procedure performs these simple actions:

- Initializes the field `ERROR_STATUS_FIELD` to spaces (some value other than `DUPL`)
- Writes the new record to the file, locking it to prevent any access by other users while the write action is occurring
- Unlocks the record before exiting the program

This procedure does not create the RMS file, nor does it open the file once it exists. A separate initialization procedure (described in Chapter 9) performs these operations. Also, this procedure does not handle the user's interactions with the terminal; HP DECforms does this.

7.7.5 Compiling the COBOL Procedure

Use the COBOL command to compile this procedure. By appending the `/DEBUG` qualifier to this command, you create the capability to debug the procedure later with the OpenVMS Debugger. By appending the `/LIST` qualifier, you generate a listing of your program showing any errors. (The listing file has the file type `.LIS`.)

Compile the source file `EMPLOYEE_INFO_ADD.COB` as follows:

```
$ COBOL/DEBUG/LIST EMPLOYEE_INFO_ADD
```

If the source file contains syntax errors, you must edit the file and recompile it until the COBOL compiler signifies that the program compiles successfully by returning to the `$` prompt without any error messages. If you get error messages, make sure you typed the definition exactly as shown in Example 7-1. In particular, check that you used the appropriate punctuation.

See the COBOL documentation for information on compiling COBOL programs and interpreting COBOL error messages.

Developing the Inquiry/Update Task

This chapter describes in step-by-step detail how to write the inquiry/update task using ACMS, HP DECforms, and CDD definitions.

8.1 Defining a HP DECforms Form for Inquiry/Update

In the inquiry portion of the task, the user needs to see a panel that prompts for the employee number. In the update portion of the task, the user sees the same panel developed for the data entry task. (In the update task, the fields are already filled in with employee data when the panel appears.)

Use the same steps as in Section 7.3 to create a form and panel for the inquiry portion of this task. This panel prompts the user to enter an employee number. Abbreviated versions of these steps are as follows:

1. Enter FDE and type the name of your new form:

```
$ FDE
_Input_File: EMPLOYEE_INFO_PROMPT_FORM
```

Note

If you copied the online IFDL source files to your default directory before starting this tutorial, HP DECforms translates the existing IFDL file here and loads the resulting FORM file. It displays the Main Menu instead of Figure 7-1. In this case, use the arrow keys to choose the Exit option and press . Proceed to step 10.

2. Select Yes to accept the default layout; select the panel option Choose, Create; select the option Create Panel; enter the name of your panel as show below; select Yes-Remove; and then select OK.

```
Panel Name: EMPLOYEE_PROMPT_PANEL
```

3. Select the Panel Editor menu choice. Format your panel as shown in Figure 8-1 (remembering to use the arrow keys to position the cursor).

Developing the Inquiry/Update Task

8.1 Defining a HP DECforms Form for Inquiry/Update

Figure 8–1 Employee Number Panel

EMPLOYEE INQUIRY

Employee Number of Record to Update:

Press Ctrl/Z to transmit employee number; PF4 to cancel. ■

Panel: EMPLOYEE_PROMPT_PANEL Right Insert

© Copyright 2005 Hewlett-Packard Development Company, L.P.

VM-0419A-AI

4. Position the cursor after "Employee Number of Record to Update:" on the panel. Press `[Do]` and issue the CREATE FIELD command to create a field there:

```
Command> CREATE FIELD
```
5. Enter the field name on the Create Field Menu and press `[Return]`.

```
Field Name      : EMPL_NUMBER
```

As before, press `[Select]` at the Data Type prompt, select the Character data type, and enter a size of 10. Select OK. Enter X(10) for the field picture and then select OK to leave the Create Field Menu.
6. Press `[Ctrl/Z]` to exit from the Panel Editor, test this panel through the Test option on the FDE Main Menu, press `[Ctrl/Z]` to exit the test, and then exit from FDE by selecting Exit.
7. Use a text editor to edit the IFDL source file created by HP DECforms. This file is named EMPLOYEE_INFO_PROMPT_FORM.IFDL.
Enter a form record description. Add the following lines after the line, "End Data":

```
Form Record EMPLOYEE_INFO_RECORD
  Copy
    EMPLOYEE_INFO_RECORD From Dictionary
  End Copy
End Record
```

Enter a function key declaration, a function response, and, to perform cleanup activities, a disable response. Add the following lines after the line, "Size 24 Lines by 80 Columns":

Developing the Inquiry/Update Task

8.1 Defining a HP DECforms Form for Inquiry/Update

```
Function QUIT_KEY
  Is %PF4
End Function

Function Response QUIT_KEY
  Remove All
  Return
  " FQUT"
End Response

Disable Response
  Request Exit Response
  Remove All
  End Response
End Response
```

Add the following lines under "Field EMPL_NUMBER" after the line specifying "Column ...":

```
Entry Response
  Reset EMPL_NUMBER
End Response
```

The Reset clause deletes old data that may be in the EMPL_NUMBER field.

8. Your `EMPLOYEE_INFO_PROMPT_FORM.IFDL` is now complete. Save the edits made in the IFDL file and exit from the text editor.
9. Create a new binary form file to match your IFDL source file by issuing the following command:

```
$ FORMS TRANSLATE EMPLOYEE_INFO_PROMPT_FORM.IFDL
$
```

10. Enter the HP DECforms `EXTRACT OBJECT` command to create a form object module, or `.OBJ` file:

```
$ FORMS EXTRACT OBJECT EMPLOYEE_INFO_PROMPT_FORM.FORM
$
```

11. Enter the `LINK/SHARE` command to link the form object module into a shareable image:

```
$ LINK/SHARE EMPLOYEE_INFO_PROMPT_FORM.OBJ
$
```

The result of the `LINK/SHARE` command is an image (`.EXE`) of the form that can be shared by multiple users.

8.2 Defining the Inquiry/Update Task

The inquiry/update task allows a user to display an employee record from the RMS master file `EMPLOYEE.DAT`. The user can then modify the contents of that record (for example, changing the employee's address) and write the revised record back to the RMS master file. This task first displays a panel to prompt the user for the employee number, then displays the employee record for that number, and then writes the modified record to the RMS file.

The inquiry/update task contains three exchange steps and two processing steps:

- The first exchange step collects the employee number of the record to be updated.
- The first processing step calls a COBOL procedure that retrieves the specified employee record from the RMS file.

Developing the Inquiry/Update Task

8.2 Defining the Inquiry/Update Task

- The second exchange step collects the modified employee data from the user.
- The second processing step calls a COBOL procedure that replaces the original employee record with the modified record.
- The third exchange step sends error messages, if any, back to the form, where they are displayed to users.

The inquiry/update task does not cover all possible error conditions. For illustration purposes, this task contains error handling for a condition in which two users are modifying the same record at approximately the same time. The task informs one of the users that another user has changed that record and gives the notified user a chance to repeat the task with the most recent version of the record.

8.2.1 Defining the First Exchange Step

The first exchange step directs HP DECforms to display a panel that prompts the user for the employee number of the record to be updated. This employee number is passed to the first processing step, which retrieves the specified record from the RMS file and displays it to the user.

To define the first exchange step:

1. Use a text editor to create a source file for the inquiry/update task definition. Name the source file `EMPLOYEE_INFO_UPDATE_TASK.TDF`.
2. Enter the first exchange step in your task definition file:

```
GET_EMPL_NUMBER:
EXCHANGE
  RECEIVE FORM RECORD EMPLOYEE_INFO_RECORD
  IN EMPLOYEE_INFO_PROMPT_LABEL
  RECEIVING EMPLOYEE_INFO_WKSP
  WITH RECEIVE CONTROL QUIT_WORKSPACE;
```

Unlike the data entry task, this exchange step explicitly states the name of the form (`EMPLOYEE_INFO_PROMPT_LABEL`) used to enter the employee number. Otherwise, ACMS displays the data entry form, which you specify as the default form later in the task group definition. Specifying a form here overrides the default form.

As in the data entry task, the `RECEIVE CONTROL` statement names the ACMS workspace (`QUIT_WORKSPACE`) to which HP DECforms returns the value `FQUT` when the user presses `[PF4]`.

3. Add the following lines to your task definition:

```
CONTROL FIELD IS QUIT_WORKSPACE.QUIT_KEY
  " FQUT" : EXIT TASK;
END CONTROL FIELD;
```

The `CONTROL FIELD` statement associates the value `FQUT` with the ACMS command `EXIT TASK`. Because you have already defined the field `QUIT_KEY` and the record `QUIT_WORKSPACE` in CDD for the data entry task, you do not need to define them again for the inquiry/update task.

8.2.2 Defining the First Processing Step

The first processing step calls a COBOL procedure that retrieves an employee record from the RMS master file. The retrieved record corresponds to the employee number that the user entered. The user then has an opportunity to modify employee information on the panel that displays this record.

Add the following processing step next as the second step in your task definition file. To simplify referencing this step in the task, begin the step with the label `RETRIEVE_UPDATE_INFO`:

```
RETRIEVE_UPDATE_INFO:  
PROCESSING  
  CALL GET_EMPL_INFO IN EMPL_SERVER  
    USING EMPLOYEE_INFO_WKSP, EMPLOYEE_INFO_COMPARE_WKSP,  
    CONTROL_WORKSPACE;
```

`GET_EMPL_INFO` is the name of the COBOL procedure that retrieves a record from the RMS file. It runs in the server `EMPL_SERVER` and uses three workspaces. The procedure and these workspaces are discussed later in the chapter.

8.2.3 Defining the Second Exchange Step

The second exchange step directs HP DECforms to display the retrieved employee record on a panel. The user can then modify that information. When the user finishes modifying employee information, this exchange step then directs HP DECforms to return the updated information to ACMS.

Next, add the second exchange step to your task definition file. To simplify referencing this step in the task, begin the step with the label `GET_UPDATE_INFO_FROM_USER`:

```
GET_UPDATE_INFO_FROM_USER:  
EXCHANGE  
  TRANSCEIVE FORM RECORD EMPLOYEE_INFO_RECORD, EMPLOYEE_INFO_RECORD  
    IN EMPLOYEE_INFO_LABEL  
  SENDING EMPLOYEE_INFO_WKSP  
  RECEIVING EMPLOYEE_INFO_WKSP  
  WITH RECEIVE CONTROL QUIT_WORKSPACE;  
  
  CONTROL FIELD IS QUIT_WORKSPACE.QUIT_KEY  
    " FOUT"      : EXIT TASK;  
  END CONTROL FIELD;
```

The second exchange step begins with a `TRANSCEIVE FORM RECORD` call to HP DECforms naming the `SEND` record and the `RECEIVE` record involved in the `TRANSCEIVE` operation (in both cases here, `EMPLOYEE_INFO_RECORD`). The name `EMPLOYEE_INFO_LABEL` specifies which form to use.

The `SENDING` clause names the workspace sent to the form: `EMPLOYEE_INFO_WKSP`. The `RECEIVING` clause names the workspace received from the form: also `EMPLOYEE_INFO_WKSP`. The latter workspace contains any modifications that a user makes to the data items displayed on the form.

As you did for the first exchange step, include a `CONTROL FIELD` clause in your task definition so that the user can press a key to exit from the task without saving any entries.

Developing the Inquiry/Update Task

8.2 Defining the Inquiry/Update Task

8.2.4 Defining the Second Processing Step

The second processing step calls a COBOL procedure that processes the update information and places it in the RMS file.

Next, add the second processing step to your task definition file. To simplify referencing this step in the task, begin the step with the label `PROCESS_UPDATE_INFO`:

```
PROCESS_UPDATE_INFO:
PROCESSING
  CALL PUT_EMPL_INFO IN EMPL_SERVER
    USING EMPLOYEE_INFO_WKSP, EMPLOYEE_INFO_COMPARE_WKSP,
      CONTROL_WORKSPACE;
  IF (CONTROL_WORKSPACE.ERROR_STATUS_FIELD EQ "CHNG")
    THEN
      MOVE "Changed by another user. Ctrl/Z to repeat, PF4 to quit." TO
        CONTROL_WORKSPACE.MESSAGEPANEL;
    ELSE
      EXIT TASK;
  END IF;
```

`PUT_EMPL_INFO` is the name of the COBOL procedure that writes a changed record to the RMS file. It runs in `EMPL_SERVER` and uses the same workspaces as the retrieval procedure. The procedure and these workspaces are discussed later in the chapter.

The procedure `PUT_EMPL_INFO` reads this record from the RMS file and locks it. The procedure then compares this record to a copy of the original record stored in a workspace.

If the two records do not match, the record in the RMS file has been changed since the user first saw it. In that case, the user is attempting to modify an outdated version of the record. The user is notified (by means of the "changed" message) and given the opportunity to repeat (with the current version of the record) or quit (cancel the task).

If the records do match, the procedure writes the modified record to the RMS file.

The `IF THEN ELSE` clause tests for the `CHNG` value in the field `ERROR_STATUS_FIELD`. If the value is present, a message is stored in the `MESSAGEPANEL` field, and the task moves on to the third exchange step to display the message. Otherwise, if the `CHNG` value is not in the workspace field, control passes to the `ELSE` statement and ends the task successfully.

8.2.5 Defining the Third Exchange Step

The third exchange step is nearly the same as the second exchange step in the data entry task discussed in Chapter 7. The purpose of this step is to display an error message, if the user tries to modify a record that another user just changed.

Add the following lines to your source file. To simplify referencing this step in the task, begin with the label `DISPLAY_ERROR_MESSAGE`:

```
DISPLAY_ERROR_MESSAGE:
EXCHANGE
  SEND FORM RECORD CONTROL_WORKSPACE IN EMPLOYEE_INFO_LABEL
  SENDING CONTROL_WORKSPACE
  WITH RECEIVE CONTROL QUIT_WORKSPACE;
ACTION IS
  IF (QUIT_WORKSPACE.QUIT_KEY EQ " FQUT")
  THEN EXIT TASK;
  ELSE REPEAT TASK;
  END IF;
```

8.2.6 Completing the Task Definition

To complete the inquiry/update task definition, you need to add some lines at the beginning of your file and at the end of your file. These lines define the block step and the remaining elements of the definition. As described in Section 7.4.4, the block step consists of the exchange and processing steps, which constitute the block work.

1. Add these lines at the beginning of your file:

```
REPLACE TASK EMPLOYEE_INFO_UPDATE_TASK
USE WORKSPACES
  EMPLOYEE_INFO_WKSP,
  EMPLOYEE_INFO_COMPARE_WKSP,
  QUIT_WORKSPACE,
  CONTROL_WORKSPACE;

BLOCK WORK WITH FORM I/O
```

REPLACE is an ADU command that stores a new task definition in CDD (creating a new definition or replacing an old one). Placing this command inside the task definition allows you to run this task definition (**EMPLOYEE_INFO_UPDATE_TASK**) as a command file in ADU (see Section 8.3).

The **WORKSPACES** clause names the workspaces used in the task. In the processing steps, you use **EMPLOYEE_INFO_COMPARE_WKSP** as the workspace that stores a copy of the displayed record.

The **BLOCK WORK** clause marks the beginning of the work that takes place within the block step.

2. Add these lines at the end of your file:

```
END BLOCK WORK;
END DEFINITION;
```

The **END BLOCK WORK** clause ends the work done within the block step.

3. Your definition for the inquiry/update task, **EMPLOYEE_INFO_UPDATE_TASK.TDF**, is now complete. Save your file and exit the editor.

Developing the Inquiry/Update Task

8.3 Compiling the Task Definition

8.3 Compiling the Task Definition

Compiling the task definition in ADU allows ADU to check for syntax errors in the source file `EMPLOYEE_INFO_UPDATE_TASK.TDF`. If there are no errors, ADU inserts your task definition into CDD. To do this, perform the following steps:

1. Invoke ADU:

```
$ ADU
```

2. When you issue the `SET LOG` and `SET VERIFY` commands, ADU simultaneously writes its output to the terminal screen and to the `ADULOG.LOG` file. Enter the `SET LOG` and `SET VERIFY` commands:

```
ADU> SET LOG
ADU> SET VERIFY
```

3. Submit the task definition file to ADU:

```
ADU> @EMPLOYEE_INFO_UPDATE_TASK.TDF
```

If ADU detects syntax errors in your task definition, exit ADU and edit the source file to correct the errors. Then reenter ADU and resubmit the file. Repeat editing the source file and resubmitting it to ADU until the file processes without errors. If you get error messages, make sure you typed the definition exactly as shown. In particular, check that you used the appropriate punctuation.

4. Exit from ADU.

8.4 Defining COBOL Procedures

The procedures used in the inquiry/update task are similar in many respects to the COBOL procedure `EMPLOYEE_INFO_ADD.COB`, which is called from the data entry task discussed in Chapter 7. Consequently, this section does not discuss the basic details again. This section concentrates instead on the processing and error handling in the Procedure Division of each program.

The first processing step in the inquiry/update task calls a COBOL procedure that retrieves a record from an RMS file. (You must retrieve the record before calling HP DECforms to display it.) This COBOL procedure is called `EMPLOYEE_INFO_UPDATE_GET.COB`.

The second processing step calls a COBOL procedure that writes the updated record to the RMS file. This COBOL procedure is called `EMPLOYEE_INFO_UPDATE_PUT.COB`. The following sections explain these two procedures.

8.4.1 Defining the Retrieval Procedure

The Identification Division, the Environment Division, and the File Section of the Data Division for the retrieval procedure are almost identical to those for the data entry procedure (see Example 7–1). The only difference is the `PROGRAM-ID`, which for the retrieval procedure is `GET_EMPL_INFO`. Because the data entry and retrieval procedures use the same RMS file, they must define the file identically in the `SELECT` and `FD` statements.

Create the COBOL retrieval procedure as follows:

1. Example 8–1 contains the COBOL retrieval procedure. Create a source file named `EMPLOYEE_INFO_UPDATE_GET.COB` and type in the procedure as shown in this example.

Developing the Inquiry/Update Task 8.4 Defining COBOL Procedures

2. Save the file and exit the editor.

Example 8-1 COBOL Retrieval Procedure

```
*****
IDENTIFICATION DIVISION.
PROGRAM-ID. GET_EMPL_INFO.
*****
ENVIRONMENT DIVISION.
CONFIGURATION SECTION.
SOURCE-COMPUTER.      VAX-11.
OBJECT-COMPUTER.     VAX-11.

INPUT-OUTPUT SECTION.
FILE-CONTROL.
SELECT EMPLOYEE-FILE
        ORGANIZATION INDEXED
        ACCESS RANDOM
        FILE STATUS IS FILE-STAT
        ASSIGN TO "xxx_FILES:EMPLOYEE.DAT".
I-O-CONTROL.
        APPLY LOCK-HOLDING ON EMPLOYEE-FILE.
*****
DATA DIVISION.
FILE SECTION.
FD EMPLOYEE-FILE EXTERNAL
   DATA RECORD IS EMPLOYEE_INFO_WKSP
   RECORD KEY EMPL_NUMBER OF EMPLOYEE_INFO_WKSP.
COPY "EMPLOYEE_INFO_WKSP" FROM DICTIONARY.

WORKING-STORAGE SECTION.
01 FILE-STAT   PIC XX IS EXTERNAL.
   88 OK       VALUE "00".
   88 REC-LOCK VALUE "92".

LINKAGE SECTION.
COPY "EMPLOYEE_INFO_WKSP" FROM DICTIONARY REPLACING
   ==EMPLOYEE_INFO_WKSP. == BY ==EMPLOYEE_INFO_LINKAGE_WKSP. ==.
COPY "EMPLOYEE_INFO_WKSP" FROM DICTIONARY REPLACING
   ==EMPLOYEE_INFO_WKSP. == BY ==EMPLOYEE_INFO_COMPARE_WKSP. ==.
COPY "CONTROL_WORKSPACE" FROM DICTIONARY.
*****
PROCEDURE DIVISION USING EMPLOYEE_INFO_LINKAGE_WKSP,
   EMPLOYEE_INFO_COMPARE_WKSP, CONTROL_WORKSPACE.
DECLARATIVES.
EMPLOYEE-USE SECTION.
   USE AFTER STANDARD ERROR PROCEDURE ON EMPLOYEE-FILE.
EMPLOYEE-CHECKING.
   EVALUATE TRUE
       WHEN REC-LOCK
           MOVE "LOCK" TO ERROR_STATUS_FIELD
       END-EVALUATE.
END DECLARATIVES.

MAIN SECTION.
000-SET-STATUS.
   MOVE SPACES TO ERROR_STATUS_FIELD.
```

(continued on next page)

Developing the Inquiry/Update Task

8.4 Defining COBOL Procedures

Example 8–1 (Cont.) COBOL Retrieval Procedure

```
010-GET-RECORD.  
    MOVE EMPL_NUMBER OF EMPLOYEE_INFO_LINKAGE_WKSP TO EMPL_NUMBER OF  
      EMPLOYEE_INFO_WKSP.  
    READ EMPLOYEE-FILE INTO EMPLOYEE_INFO_LINKAGE_WKSP  
      ALLOWING NO OTHERS.  
    MOVE EMPLOYEE_INFO_WKSP TO EMPLOYEE_INFO_COMPARE_WKSP.  
  
100-EXIT-PROGRAM.  
    UNLOCK EMPLOYEE-FILE.  
    EXIT PROGRAM.
```

Recall that the Linkage Section lists the workspaces that ACMS passes to the procedure. The linkage workspace and the file workspace must have different names; therefore, the COPY statement includes the REPLACING clause to assign a different name to the EMPLOYEE_INFO_WKSP workspace. Like the data entry procedure, the retrieval procedure also uses CONTROL_WORKSPACE for error handling and reporting.

In the retrieval procedure, you make a copy of the record displayed to the user and store it in another workspace. The copied record is called EMPLOYEE_INFO_COMPARE_WKSP, and ACMS passes it to the update procedure to be compared with the corresponding record in the RMS file. If the the record in the RMS file has changed since this task began, ACMS notifies the user that the displayed record is no longer current.

In the Main Section of the Procedure Division, the retrieval procedure performs the following actions:

- Initializes ERROR_STATUS_FIELD with spaces
- Reads the record from the RMS file, locks it, and stores it in EMPLOYEE_INFO_WKSP, which is passed to HP DECforms and displayed on the screen
- Copies the contents of EMPLOYEE_INFO_WKSP into another workspace, EMPLOYEE_INFO_COMPARE_WKSP, so that the update procedure can later compare the record that the user saw to the record currently in the RMS file
- Unlocks the record before exiting the program

8.4.2 Compiling the Retrieval Procedure

Use the COBOL command to compile the retrieval procedure. By appending the /DEBUG qualifier to this command, you create the capability to debug the procedure later with the OpenVMS Debugger. By appending the /LIST qualifier, you generate a listing of your program showing any errors. (The listing file has the file type .LIS.)

Compile the source file EMPLOYEE_INFO_UPDATE_GET.COB as follows:

```
$ COBOL/DEBUG/LIST EMPLOYEE_INFO_UPDATE_GET  
$
```

If the source file contains syntax errors, continue to edit the source file and recompile it until the program compiles successfully.

8.4.3 Defining the Update Procedure

Except for the PROGRAM-ID, the update procedure is identical to the retrieval procedure until the Main Section of the Procedure Division.

Create the update procedure as follows:

1. Example 8–2 contains the update procedure. Create a source file named EMPLOYEE_INFO_UPDATE_PUT.COB and type in the procedure as shown in this example.
2. Save the file and exit the editor.

Example 8–2 COBOL Update Procedure

```
IDENTIFICATION DIVISION.
PROGRAM-ID. PUT_EMPL_INFO.

ENVIRONMENT DIVISION.
CONFIGURATION SECTION.
SOURCE-COMPUTER. VAX-11.
OBJECT-COMPUTER. VAX-11.
INPUT-OUTPUT SECTION.
FILE-CONTROL.
SELECT EMPLOYEE-FILE
        ORGANIZATION INDEXED
        ACCESS RANDOM
        FILE STATUS IS FILE-STAT
        ASSIGN TO "xxx_FILES:EMPLOYEE.DAT".
I-O-CONTROL.
        APPLY LOCK-HOLDING ON EMPLOYEE-FILE.

DATA DIVISION.
FILE SECTION.
FD EMPLOYEE-FILE EXTERNAL
   DATA RECORD IS EMPLOYEE_INFO_WKSP
   RECORD KEY EMPL_NUMBER OF EMPLOYEE_INFO_WKSP.

   COPY "EMPLOYEE_INFO_WKSP" FROM DICTIONARY.

WORKING-STORAGE SECTION.
01 FILE-STAT                                PIC XX IS EXTERNAL.
   88 OK                                    VALUE "00".
   88 REC-LOCK                              VALUE "92".

LINKAGE SECTION.
COPY "EMPLOYEE_INFO_WKSP" FROM DICTIONARY REPLACING
   ==EMPLOYEE_INFO_WKSP. == BY ==EMPLOYEE_INFO_LINKAGE_WKSP. ==.
COPY "EMPLOYEE_INFO_WKSP" FROM DICTIONARY REPLACING
   ==EMPLOYEE_INFO_WKSP. == BY ==EMPLOYEE_INFO_COMPARE_WKSP. ==.
COPY "CONTROL_WORKSPACE" FROM DICTIONARY.

PROCEDURE DIVISION USING EMPLOYEE_INFO_LINKAGE_WKSP,
   EMPLOYEE_INFO_COMPARE_WKSP, CONTROL_WORKSPACE.
DECLARATIVES.
EMPLOYEE-USE SECTION.
   USE AFTER STANDARD ERROR PROCEDURE ON EMPLOYEE-FILE.
EMPLOYEE-CHECKING.
   EVALUATE TRUE
     WHEN REC-LOCK
       MOVE "LOCK" TO ERROR_STATUS_FIELD
   END-EVALUATE.
END DECLARATIVES.
```

(continued on next page)

Developing the Inquiry/Update Task

8.4 Defining COBOL Procedures

Example 8–2 (Cont.) COBOL Update Procedure

```
MAIN SECTION.
000-SET-STATUS.
    MOVE SPACES TO ERROR_STATUS_FIELD.

010-GET-RECORD.
    MOVE EMPL_NUMBER OF EMPLOYEE_INFO_LINKAGE_WKSP TO EMPL_NUMBER OF
    EMPLOYEE_INFO_WKSP.
    READ EMPLOYEE-FILE ALLOWING NO OTHERS.
    IF ERROR-STATUS_FIELD EQUAL "LOCK"
    THEN
        GO TO 100-EXIT-PROGRAM.

020-CHECK-FOR-CHANGES.
    PERFORM 070-CHECK-RECORD.
    IF ERROR-STATUS_FIELD EQUAL "CHNG"
    THEN
        MOVE EMPLOYEE_INFO_WKSP TO EMPLOYEE_INFO_LINKAGE_WKSP
        MOVE EMPLOYEE_INFO_WKSP TO EMPLOYEE_INFO_COMPARE_WKSP
        GO TO 100-EXIT-PROGRAM.

030-REWRITE-RECORD.
    REWRITE EMPLOYEE_INFO_WKSP FROM EMPLOYEE_INFO_LINKAGE_WKSP
    ALLOWING NO OTHERS.
    GO TO 100-EXIT-PROGRAM.

070-CHECK-RECORD.
    EVALUATE
        EMPLOYEE_INFO_WKSP EQUAL EMPLOYEE_INFO_COMPARE_WKSP
        WHEN FALSE MOVE "CHNG" TO ERROR_STATUS_FIELD
    END-EVALUATE.

100-EXIT-PROGRAM.
    UNLOCK EMPLOYEE-FILE.
    EXIT PROGRAM.
```

In the Procedure Division, the update procedure performs the following actions:

- Initializes `ERROR_STATUS_FIELD` with spaces.
- Retrieves and locks the modified record. If the record is already locked, the procedure stores an error value in `ERROR_STATUS_FIELD` and exits from the program.
- Checks the contents of the record in the RMS file against the record displayed to the user, a copy of which was stored in `EMPLOYEE_INFO_COMPARE_WKSP` by the retrieval procedure. If the two records do not match, the procedure stores an error value in `ERROR_STATUS_FIELD` and exits from the program.
- Writes the modified record back to the RMS file.
- Unlocks the record before exiting the program.

8.4.4 Compiling the Update Procedure

Use the COBOL command to compile the update procedure. By appending the `/DEBUG` qualifier to this command, you create the capability to debug the procedure later with the OpenVMS Debugger. By appending the `/LIST` qualifier, you generate a listing of your program showing any errors. (The listing file has the file type `.LIS`.)

Developing the Inquiry/Update Task

8.4 Defining COBOL Procedures

Compile the source file `EMPLOYEE_INFO_UPDATE_PUT.COB` as follows:

```
$ COBOL/DEBUG/LIST EMPLOYEE_INFO_UPDATE_PUT  
$
```

If the source file contains syntax errors, continue to edit the source file and recompile it until the COBOL compiler completes successfully.

Building the Task Group

This chapter describes how to combine the data entry task and the inquiry/update task into a task group. It also describes how to write startup and cleanup procedures, how to link the object modules into a server image, and how to test the tasks using the ACMS Task Debugger.

9.1 Defining Startup and Cleanup Procedures

Because ACMS can use one server process to handle several procedures, any startup and cleanup operations can be done just once during the lifetime of the process rather than at every processing step. The following sections have you define the initialization, termination, and cancellation procedures that perform startup and cleanup for the tasks.

9.1.1 Defining the Initialization Procedure

The initialization procedure in this tutorial performs any work that must be done before the data entry, retrieval, and update procedures in the server process can execute. For example, this initialization procedure opens an RMS file and leaves it open until the process stops. This is more efficient than opening and closing the file every time a task calls one of the three processing procedures.

Therefore, the processing procedures in this tutorial do not open and close the RMS file; instead, the file is opened in the initialization procedure and closed in the termination procedure. The initialization procedure tests the status of the open operation and stops the server process if the file was not opened successfully.

In this tutorial application, the RMS file is created the first time you use the application. Because the file being opened does not exist yet, the `SELECT OPTIONAL` statement in COBOL creates it.

Create the COBOL initialization procedure as follows:

1. Example 9–1 contains the COBOL initialization procedure. Create a source file named `EMPLOYEE_INFO_INIT.COB` and type in the procedure as shown in this example.
2. Save the file and exit the editor.

Building the Task Group

9.1 Defining Startup and Cleanup Procedures

Example 9-1 COBOL Initialization Procedure

```
*****
IDENTIFICATION DIVISION.
PROGRAM-ID.  INIT_EMPL_INFO.

*****
ENVIRONMENT DIVISION.
CONFIGURATION SECTION.
SOURCE-COMPUTER.  VAX-11.
OBJECT-COMPUTER.  VAX-11.

INPUT-OUTPUT SECTION.
FILE-CONTROL.
SELECT  OPTIONAL EMPLOYEE-FILE
        ORGANIZATION INDEXED
        ACCESS RANDOM
        FILE STATUS IS FILE-STAT
        ASSIGN TO "xxx_FILES:EMPLOYEE.DAT" .
I-O-CONTROL.
        APPLY LOCK-HOLDING ON EMPLOYEE-FILE.

*****
DATA DIVISION.
FILE SECTION.
FD  EMPLOYEE-FILE EXTERNAL
   DATA RECORD IS EMPLOYEE_INFO_WKSP
   RECORD KEY EMPL_NUMBER OF EMPLOYEE_INFO_WKSP.

COPY "EMPLOYEE_INFO_WKSP" FROM DICTIONARY.

WORKING-STORAGE SECTION.
01  STATUS-RESULT          PIC S9(9) COMP.
01  FILE-STAT              PIC XX IS EXTERNAL.

*****
PROCEDURE DIVISION GIVING STATUS-RESULT.
DECLARATIVES.
PERS-USE SECTION.
    USE AFTER STANDARD ERROR PROCEDURE ON EMPLOYEE-FILE.
PERS-CHECKING.
    MOVE RMS-STS OF EMPLOYEE-FILE TO STATUS-RESULT.
END DECLARATIVES.

MAIN SECTION.
000-SET-STATUS.
    SET STATUS-RESULT TO SUCCESS.

010-OPEN-FILES.
    OPEN I-O EMPLOYEE-FILE ALLOWING ALL.

100-EXIT-PROGRAM.
    EXIT PROGRAM.
```

Use the COBOL command to compile this procedure. By appending the /DEBUG qualifier to this command, you create the capability to debug the procedure later with the OpenVMS Debugger. By appending the /LIST qualifier, you generate a listing of your program showing any errors. (The listing file has the file type .LIS.)

Compile the source file EMPLOYEE_INFO_INIT.COB as follows:

```
$ COBOL/DEBUG/LIST EMPLOYEE_INFO_INIT
$
```

If the source file contains syntax errors, continue to edit the source file and recompile it until the program compiles successfully.

9.1.2 Defining the Termination Procedure

The termination procedure performs any work that must be done when the server process stops. (ACMS stops a server process when you stop an application that uses the server.) For example, closing an RMS file in a termination procedure is more efficient than opening and closing the file every time the task calls one of the three processing procedures.

Note

If the server runs down because a cancel occurs, ACMS does not execute the termination procedure unless you include the statement **ALWAYS EXECUTE TERMINATION PROCEDURE** in the server clause of the task group definition (see Section 9.2.3).

Create the COBOL termination procedure as follows:

1. Example 9–2 contains the COBOL termination procedure. Create a source file named **EMPLOYEE_INFO_TERM.COB** and type in the procedure as shown in this example.
2. Save the file and exit the editor.

Example 9–2 COBOL Termination Procedure

```
*****
IDENTIFICATION DIVISION.
PROGRAM-ID.    TERM_EMPL_INFO.

*****
ENVIRONMENT DIVISION.
CONFIGURATION SECTION.
SOURCE-COMPUTER.    VAX-11.
OBJECT-COMPUTER.    VAX-11.

INPUT-OUTPUT SECTION.
FILE-CONTROL.
SELECT  EMPLOYEE-FILE
        ORGANIZATION INDEXED
        ACCESS RANDOM
        FILE STATUS IS FILE-STAT
        ASSIGN TO "xxx_FILES:EMPLOYEE.DAT".
I-O-CONTROL.
        APPLY LOCK-HOLDING ON EMPLOYEE-FILE.

*****
DATA DIVISION.
FILE SECTION.
FD  EMPLOYEE-FILE EXTERNAL
   DATA RECORD IS EMPLOYEE_INFO_WKSP
   RECORD KEY EMPL_NUMBER OF EMPLOYEE_INFO_WKSP.

COPY "EMPLOYEE_INFO_WKSP" FROM DICTIONARY.

WORKING-STORAGE SECTION.
01  STATUS-RESULT          PIC S9(9) COMP.
01  FILE-STAT              PIC XX IS EXTERNAL.
```

(continued on next page)

Building the Task Group

9.1 Defining Startup and Cleanup Procedures

Example 9–2 (Cont.) COBOL Termination Procedure

```
*****  
PROCEDURE DIVISION GIVING STATUS-RESULT.  
DECLARATIVES.  
PERS-USE SECTION.  
    USE AFTER STANDARD ERROR PROCEDURE ON EMPLOYEE-FILE.  
PERS-CHECKING.  
    MOVE RMS-STS OF EMPLOYEE-FILE TO STATUS-RESULT.  
END DECLARATIVES.  
  
MAIN SECTION.  
000-SET-STATUS.  
    SET STATUS-RESULT TO SUCCESS.  
  
010-CLOSE-FILES.  
    CLOSE EMPLOYEE-FILE.  
  
100-EXIT-PROGRAM.  
    EXIT PROGRAM.
```

Use the COBOL command to compile this procedure. By appending the /DEBUG qualifier to this command, you create the capability to debug the procedure later with the OpenVMS Debugger. By appending the /LIST qualifier, you generate a listing of your program showing any errors. (The listing file has the file type .LIS.)

Compile the source file EMPLOYEE_INFO_TERM.COB as follows:

```
$ COBOL/DEBUG/LIST EMPLOYEE_INFO_TERM  
$
```

If the source file contains syntax errors, continue to edit the source file and recompile it until the program compiles successfully.

9.1.3 Defining the Cancellation Procedure

The cancellation procedure performs any work that must be done if a cancel occurs while the server process is active. For example, the processing procedures lock a record to process it. If a cancel occurs (for example, if the user presses **Ctrl/C**) while the record is locked, the record remains locked until the server process stops unless you unlock it in a cancellation procedure. By unlocking the record quickly with a cancellation procedure, you avoid delays to other users trying to access the record.

Note

Often a cancellation procedure is not recommended in more complex applications, either for design reasons, or because you can accomplish any necessary server cleanup activity in your termination procedure.

Create the COBOL cancellation procedure as follows:

1. Example 9–3 contains the COBOL cancellation procedure. Create a source file named EMPLOYEE_INFO_CANCEL.COB and type in the procedure as shown in this example.

Building the Task Group 9.1 Defining Startup and Cleanup Procedures

2. Save the file and exit the editor.

Example 9-3 COBOL Cancellation Procedure

```
*****
IDENTIFICATION DIVISION.
PROGRAM-ID. CANCEL_EMPL_INFO.

*****
ENVIRONMENT DIVISION.
CONFIGURATION SECTION.
SOURCE-COMPUTER. VAX-11.
OBJECT-COMPUTER. VAX-11.

INPUT-OUTPUT SECTION.
FILE-CONTROL.
SELECT EMPLOYEE-FILE
        ORGANIZATION INDEXED
        ACCESS RANDOM
        FILE STATUS IS FILE-STAT
        ASSIGN TO "xxx_FILES:EMPLOYEE.DAT".
I-O-CONTROL.
        APPLY LOCK-HOLDING ON EMPLOYEE-FILE.

*****
DATA DIVISION.
FILE SECTION.
FD EMPLOYEE-FILE EXTERNAL
   DATA RECORD IS EMPLOYEE-INFO_WKSP
   RECORD KEY EMPL_NUMBER OF EMPLOYEE_INFO_WKSP.

COPY "EMPLOYEE_INFO_WKSP" FROM DICTIONARY.

WORKING-STORAGE SECTION.
01 STATUS-RESULT PIC S9(9) COMP.
01 FILE-STAT PIC XX IS EXTERNAL.

*****
PROCEDURE DIVISION GIVING STATUS-RESULT.
DECLARATIVES.
PERS-USE SECTION.
    USE AFTER STANDARD ERROR PROCEDURE ON EMPLOYEE-FILE.
PERS-CHECKING.
    MOVE RMS-STS OF EMPLOYEE-FILE TO STATUS-RESULT.
END DECLARATIVES.

MAIN SECTION.
000-SET-STATUS.
    SET STATUS-RESULT TO SUCCESS.

010-UNLOCK-FILES.
    UNLOCK EMPLOYEE-FILE.

100-EXIT-PROGRAM.
    EXIT PROGRAM.
```

Use the COBOL command to compile this procedure. By appending the /DEBUG qualifier to this command, you create the capability to debug the procedure later with the OpenVMS Debugger. By appending the /LIST qualifier, you generate a listing of your program showing any errors. (The listing file has the file type .LIS.)

Compile the source file EMPLOYEE_INFO_CANCEL.COB as follows:

```
$ COBOL/DEBUG/LIST EMPLOYEE_INFO_CANCEL
$
```

Building the Task Group

9.1 Defining Startup and Cleanup Procedures

If the source file contains syntax errors, continue to edit the source file and recompile it until the program compiles successfully.

9.2 Defining and Building the Task Group

To define the task group in this tutorial, you specify the tasks that belong to the group, the server in which the tasks run, and the workspaces that the tasks use. Because the application uses DECforms to get information from the terminal user, you must also specify the form file name, form file specification, and form file label of the forms used in the task group definition.

You define a task group with commands and clauses of the Application Definition Utility (ADU) in the same manner that you created the two task definitions earlier.

9.2.1 Naming Forms

To begin defining the task group definition, follow these steps:

1. Use a text editor to create a source file for the task group definition. Name the source file `EMPLOYEE_INFO_TASK_GROUP.GDF`.
2. Begin your file by entering the following lines:

```
REPLACE GROUP EMPLOYEE_INFO_TASK_GROUP
FORM IS EMPLOYEE_INFO_FORM IN "xxx_FILES:EMPLOYEE_INFO_FORM"
  WITH NAME EMPLOYEE_INFO_LABEL;
FORM IS EMPLOYEE_INFO_PROMPT_FORM
  IN "xxx_FILES:EMPLOYEE_INFO_PROMPT_FORM"
  WITH NAME EMPLOYEE_INFO_PROMPT_LABEL;
```

The task group definition lists the OpenVMS file specifications of DECforms form files used in the task group. These are `EMPLOYEE_INFO_FORM` and `EMPLOYEE_INFO_PROMPT_FORM`, created in Chapter 7 and Chapter 8, and stored in the directory specified by your logical `xxx_FILES`.

The `WITH NAME` phrase specifies the form label name for each form. These names were used earlier within the ACMS task definitions to refer to the form.

9.2.2 Naming the Tasks in the Task Group

You can now add the following `TASKS ARE` clause to the source file:

```
TASKS ARE
  EMPLOYEE_INFO_ADD_TASK : TASK IS EMPLOYEE_INFO_ADD_TASK;
  EMPLOYEE_INFO_UPDATE_TASK : TASK IS EMPLOYEE_INFO_UPDATE_TASK;
END TASKS;
```

The task name on the right hand side of the colon is as you defined it in CDD. The task name on the left hand side of the colon can be any unique name you create to identify the task and does not need to match the task name on the right hand side, but using different names is more often confusing than useful. You use the task names on the left hand side later in the application definition to assign different characteristics to individual tasks.

9.2.3 Naming the Procedure Server and Workspaces

All the COBOL procedures run in the same procedure server, which you define by adding a `SERVER IS` clause to your source file.

1. Add the following lines to your file:

```
SERVER IS
  EMPL_SERVER:
    DEFAULT OBJECT FILE IS EMPL_SERVER;
    PROCEDURE SERVER IMAGE IS "xxx_FILES:EMPL_SERVER";
    INITIALIZATION PROCEDURE IS INIT_EMPL_INFO;
    TERMINATION PROCEDURE IS TERM_EMPL_INFO;
    CANCEL PROCEDURE IS CANCEL_EMPL_INFO;
    PROCEDURES ARE
      ADD_EMPL_INFO,
      GET_EMPL_INFO,
      PUT_EMPL_INFO;
END SERVER;

WORKSPACES ARE
  EMPLOYEE_INFO_WKSP,
  EMPLOYEE_INFO_WKSP WITH NAME EMPLOYEE_INFO_COMPARE_WKSP,
  QUIT_WORKSPACE,
  CONTROL_WORKSPACE;

END DEFINITION;
```

The `SERVER IS` clause identifies the procedure server for the task group and lists all procedures that run in the server. You list each procedure by its `PROGRAM-ID` (for example, `ADD_EMPLOYEE_INFO`), including any initialization, termination, and cancellation procedures you have written.

The `DEFAULT OBJECT FILE` statement names the procedure server object module (`.OBJ`), while the `PROCEDURE SERVER IMAGE` statement names the executable image (`.EXE`). In this tutorial, the server object module and the executable image are both called `EMPL_SERVER`. The system logical `xxx_FILES` specifies the directory in which to place the procedure server image.

The `WORKSPACES` clause defines the workspaces used in the tasks. In the inquiry/update task, both `EMPLOYEE_INFO_WKSP` and `EMPLOYEE_INFO_COMPARE_WKSP` need to use the `EMPLOYEE_INFO_WKSP` definition. However, ACMS requires that workspace names be unique; therefore, you use the `WITH NAME` keywords in the `WORKSPACES` clause to rename one of the `EMPLOYEE_INFO_WKSP` definitions.

2. Your definition for the task group definition, `EMPLOYEE_INFO_TASK_GROUP.GDF`, is now complete. Save your file and exit the editor.

9.2.4 Compiling the Task Group Definition

Compiling the task group definition allows ADU to check for syntax errors in the source file `EMPLOYEE_INFO_TASK_GROUP.GDF`. If there are no errors, ADU inserts your task group definition into CDD. To do this, perform the following steps:

1. Invoke ADU:

```
$ ADU
```

Building the Task Group

9.2 Defining and Building the Task Group

- When you use the SET LOG and SET VERIFY commands, ADU simultaneously writes its output to the terminal screen and to the ADU.LOG file. Enter the SET LOG and SET VERIFY commands:

```
ADU> SET LOG
ADU> SET VERIFY
```

- Submit the task group definition file to ADU:

```
ADU> @EMPLOYEE_INFO_TASK_GROUP.GDF
```

If ADU detects syntax errors in your task definition, exit ADU and edit the source file to correct the errors; then reenter ADU and resubmit the file. Repeat editing the source file and resubmitting it to ADU until the file processes without errors. If you get error messages, make sure that you typed the definition exactly as shown. In particular, check that you used the appropriate punctuation.

- Exit from ADU.

Your default CDD directory now contains the task group definition, the task definitions created for the data entry and inquiry/update tasks, and the record definitions for these tasks. You can use the CDO DIRECTORY command to verify that these definitions exist (a partial directory listing is as follows).

```
$ CDO
CDO> DIRECTORY
CONTROL_WORKSPACE;1                RECORD
EMPLOYEE_INFO_ADD_TASK;1           ACMS$TASK
EMPLOYEE_INFO_TASK_GROUP;1         ACMS$TASK_GROUP
EMPLOYEE_INFO_UPDATE_TASK;1       ACMS$TASK
EMPLOYEE_INFO_WKSP;1              RECORD
.
.
.
CDO>
```

The DIRECTORY command displays the names of items in CDD and indicates the type of each item: CDD record or field, ACMS task or task group.

9.2.5 Building the Task Group

You can now build the task group with the ADU BUILD command. This command produces two new files: a task group database file and a procedure server object module. The task group database is an RMS file that contains binary versions of the tasks and information about how to process them. At run time, ACMS executes the tasks in their binary form rather than as ADU source commands. The procedure server object module controls the procedures that run in the same server.

To build the task group, use the BUILD command with the GROUP keyword. Include the /DEBUG qualifier to test the task group in the ACMS Task Debugger (described at the end of this chapter). Build the task group as follows:

```
$ ADU
ADU> BUILD GROUP EMPLOYEE_INFO_TASK_GROUP/DEBUG
ADU>
```

If the BUILD command succeeds, ADU displays a "Writing TDB...object module created" sequence of messages. When ADU processes this command, it creates the task group database file EMPLOYEE_INFO_TASK_GROUP.TDB. It also creates a procedure server transfer module called EMPL_SERVER.OBJ. In

Building the Task Group

9.2 Defining and Building the Task Group

the following section, you link this object module with all the procedure object modules to produce the procedure server image.

If the BUILD command fails, ADU issues error messages and redisplay the ADU> prompt. Correct the errors and resubmit the task group definition to ADU, repeating this sequence until the definition processes without errors.

Exit from ADU.

9.3 Linking the Server Image

You can now link the procedure server object module with the object modules of all the procedures in the task group. Use the DCL LINK command. Include the /DEBUG qualifier to test the task group in the ACMS Task Debugger (described at the end of this chapter):

```
$ LINK/DEBUG EMPL_SERVER, EMPLOYEE_INFO_ADD, EMPLOYEE_INFO_INIT, -
_$ EMPLOYEE_INFO_TERM, EMPLOYEE_INFO_CANCEL, EMPLOYEE_INFO_UPDATE_GET, -
_$ EMPLOYEE_INFO_UPDATE_PUT
$
```

If your LINK command succeeds, DCL returns the \$ prompt without any error messages.

The Linker automatically uses the first object module listed after the LINK command as the name of the server image. The tutorial lists the EMPL_SERVER object module first, so that the server image has the same name as the procedure server. This produces a server image named EMPL_SERVER.EXE.

(Notice that you use the DCL file names for the COBOL procedures in the LINK command.)

9.4 Testing a Task in the ACMS Task Debugger

With the ACMS Task Debugger you can simulate how a task runs as part of an application, even though you have not yet defined the application and its menus. You run one task at a time and, in this way, test how an individual task works. The ACMS Task Debugger uses the task group database (.TDB) file and the server image (.EXE) file to run the tasks in a task group.

Note

The ACMS Task Debugger works within your OpenVMS process. To accommodate the Task Debugger, your OpenVMS account needs a minimum BYTLM quota of 50,000. Otherwise, you receive an EXBYTLM error in step 2.

If you want to create a DECforms trace file that records form processing whenever an ACMS task calls a DECforms request, turn on tracing here before entering the Task Debugger (see Section A.4).

To use the ACMS Task Debugger, follow these steps:

1. To start the Task Debugger, issue the ACMS/DEBUG command followed by the name of the task group. To examine the contents of workspaces while stepping through a task, include the /WORKSPACE qualifier:

```
$ ACMS/DEBUG EMPLOYEE_INFO_TASK_GROUP /WORKSPACE
ACMSDBG>
```

Building the Task Group

9.4 Testing a Task in the ACMS Task Debugger

2. Issue the **START** command to start **EMPL_SERVER**. The Task Debugger returns several messages and the **DBG>** prompt:

```
ACMSDBG> START EMPL_SERVER
Terminal is in SERVER EMPL_SERVER

          I64 DEBUG Version ...

%DEBUG-I-INITIAL, language is COBOL, module set to EMPL_SERVER
DBG>
```

3. Issue the **GO** command to run the initialization procedure, **EMPLOYEE_INFO_INIT.COB**:

```
DBG> GO
Server EMPL_SERVER has been started
ACMSDBG>
```

To verify that **EMPL_SERVER** is active as you are testing, you can enter the **SHOW SERVERS** command:

```
ACMSDBG> SHOW SERVERS
EMPL_SERVER
ACMSDBG>
```

4. (Optional) Set breakpoints for **EMPLOYEE_INFO_ADD_TASK** at the **GET_EMPL_INFO** and **PROCESS_EMPL_INFO** lines in the task, using the **\$ACTION** symbol. Breakpoints stop a task at a specified line so that you can examine the contents of a field in one of the workspaces:

```
ACMSDBG> SET BREAK EMPLOYEE_INFO_ADD_TASK\GET_EMPL_INFO\ACTION
ACMSDBG> SET BREAK EMPLOYEE_INFO_ADD_TASK\PROCESS_EMPL_INFO\ACTION
ACMSDBG>
```

5. (Optional) Issue the **SHOW BREAK** command to check the breakpoints you have set:

```
ACMSDBG> SHOW BREAK

task breakpoint at EMPLOYEE_INFO_ADD_TASK\GET_EMPL_INFO\ACTION
task breakpoint at EMPLOYEE_INFO_ADD_TASK\PROCESS_EMPL_INFO\ACTION

ACMSDBG>
```

6. Enter the **SELECT** command with the name of the task that you want to start:

```
ACMSDBG> SELECT EMPLOYEE_INFO_ADD_TASK
Task is in the task debugger
```

This command begins the task. The **EMPLOYEE_INFO_FORM** appears on your screen.

7. Enter data in all the fields on the form. (Make note of the employee number that you enter here to test the inquiry/update task next.) Then press **Ctrl/Z**. If you set breakpoints, the system returns this message:

```
Task breakpoint at EMPLOYEE_INFO_ADD_TASK\GET_EMPL_INFO\ACTION
```

(If you did not set breakpoints, the message is "Task ended," and you can proceed to step 11.)

8. Issue the **EXAMINE** command to check that the information you entered on the form was transmitted to the workspace **EMPLOYEE_INFO_WKSP**:

```
ACMSDBG> EXAMINE EMPLOYEE_INFO_WKSP
```

Building the Task Group

9.4 Testing a Task in the ACMS Task Debugger

The Task Debugger displays the employee data as it appears in the workspace.

9. Enter GO to continue to your second breakpoint:

```
ACMSDBG> GO

Task is in SERVER EMPL_SERVER
Task is in the task debugger
Task breakpoint at EMPLOYEE_INFO_ADD_TASK\PROCESS_EMPL_INFO\$_ACTION

ACMSDBG>
```

The Task Debugger now stops at the second breakpoint (PROCESS_EMPL_INFO) in your task.

10. Enter GO to complete the task:

```
ACMSDBG> GO
Task ended
```

11. If you wish to test EMPLOYEE_INFO_UPDATE_TASK, you can use the employee number that you just entered during the data entry test above. (If you wish to set breakpoints for this task, do so before selecting the task.) Enter the SELECT command with the name of the task:

```
ACMSDBG> SELECT EMPLOYEE_INFO_UPDATE_TASK
Task is in the task debugger
```

This command begins the task. The EMPLOYEE_INFO_PROMPT_FORM appears on your screen. Type in the employee number and press **[Ctrl/Z]**. The employee data that you entered in the data entry test should appear on your screen. You can now modify that data and save it by pressing **[Ctrl/Z]**.

12. When you are finished testing your tasks ("Task ended"), issue the STOP command to stop EMPL_SERVER:

```
ACMSDBG> STOP /ALL
Terminal is in SERVER EMPL_SERVER
Server EMPL_SERVER stopped
ACMSDBG>
```

13. Exit from the ACMS Task Debugger:

```
ACMSDBG> EXIT
$
```

For more information on testing and debugging tasks, see *HP ACMS for OpenVMS Writing Server Procedures*. For information on using the OpenVMS Debugger, consult the *OpenVMS Debugger Manual*.

Defining and Building the Application

In this chapter, you learn how to write the application definition. You then build this definition into an application database that ACMS uses at run time.

10.1 Defining the Application

An ACMS application controls one or more task groups, each of which contains related tasks that may share servers. In the application definition, you describe characteristics that control the tasks, the servers, and the application. ACMS provides defaults for most of the control characteristics that an application requires.

You create the application definition as a source file of ADU commands in the same manner that you created the task and task group definitions earlier.

10.1.1 Application Characteristics

To begin writing the application definition, follow these steps:

1. Use a text editor to create a source file for the application definition. Name the file `EMPLOYEE_INFO_APPL_xxx.ADF`, filling in your initials or other unique characters for the `xxx` part of the name. Creating a unique application name avoids conflicts with the applications of others who may be entering this tutorial on your system. (If you copy the file `EMPLOYEE_INFO_APPL_xxx.ADF` from the online source files, rename it to substitute your initials for `xxx`. Also, edit this file to make the same name change in the first line of the file.)
2. Begin your file by entering the following lines:

```
REPLACE APPLICATION EMPLOYEE_INFO_APPL_xxx
  AUDIT;
  APPLICATION USERNAME IS EMPLOYEE_EXC;
```

The `AUDIT` clause directs ACMS to collect audit trail information for the application. This information is useful for determining how an ACMS system and its tasks and applications are being used. The ACMS Audit Trail Logger gathers statistics about an active ACMS system and records them in the audit trail log file. This file, which is named `SYS$ERRORLOG:ACMSAUDIT.LOG` by default, records such information as task selections, task cancellations, user logins and logouts, and application starts and stops.

At run time, ACMS uses an OpenVMS process called an Application Execution Controller (EXC) for each application. The EXC executes the task and performs task flow control. The `APPLICATION USERNAME` clause specifies the user name `EMPLOYEE_EXC` for the Application Execution Controller. Chapter 12 describes how your system manager creates the account `EMPLOYEE_EXC`.

Defining and Building the Application

10.1 Defining the Application

10.1.2 Server Characteristics

Every server in an application has an OpenVMS user name. By default, a server uses the application user name as its OpenVMS user name. For most applications, however, use a different OpenVMS account for the server, because the server usually requires fewer privileges and lower quotas than an application. The application definition specifies the name `EMPL_SERVER`. Chapter 12 describes how your system manager creates the account `EMPL_SERVER`.

Add the following lines to your source file:

```
SERVER DEFAULTS ARE
  AUDIT;
  USERNAME IS EMPL_SERVER;
  MINIMUM SERVER PROCESSES IS 1;
  MAXIMUM SERVER PROCESSES IS 1;
END SERVER DEFAULTS;
```

The `AUDIT` clause generates audit trail information for the server. The `USERNAME` clause names `EMPL_SERVER` as the account in which the server runs.

ACMS lets you control both the minimum and maximum number of server processes used for your application. Servers are serially reusable, so they can be created once and used several times by the application. The `MINIMUM SERVER PROCESSES` and `MAXIMUM SERVER PROCESSES` clauses specify that only one server process be created for the application. Specifying the same number for the minimum and the maximum can greatly improve the performance of your application, provided that the number of processes is adequate for the number of users.

10.1.3 Task Characteristics

The only required task characteristic is the name of every task group in the application. Optional task characteristics specify which users can run which tasks and whether audit trail information is recorded for the tasks. This tutorial application is simple enough that all users can be allowed access to all tasks.

1. Add these lines to your source file:

```
TASK DEFAULTS ARE
  AUDIT;
END TASK DEFAULTS;

TASK GROUPS ARE
  EMPLOYEE_INFO_TASK_GROUP:
    TASK GROUP FILE IS "xxx_FILES:EMPLOYEE_INFO_TASK_GROUP.TDB";
END TASK GROUPS;
END DEFINITION;
```

2. Your definition for the application definition, `EMPLOYEE_INFO_APPL_xxx.ADF`, is now complete. Save your file and exit the editor.

10.2 Compiling the Application Definition

Compile your source file after exiting the editor. Invoke `ADU` and submit the file `EMPLOYEE_INFO_APPL_xxx.ADF` as follows:

```
$ ADU
ADU> SET LOG
ADU> SET VERIFY
ADU> @EMPLOYEE_INFO_APPL_xxx.ADF
```

Defining and Building the Application

10.2 Compiling the Application Definition

If ADU detects syntax errors in your application definition, you must exit ADU and edit the source file to correct the errors. Then reenter ADU and resubmit the file. Repeat this sequence until the file processes without errors. If you get error messages, make sure that you typed the definition exactly as shown. In particular, check that you used the appropriate punctuation.

10.3 Building the Application

Next, build the application with the ADU BUILD command and the APPLICATION keyword:

```
ADU> BUILD APPLICATION EMPLOYEE_INFO_APPL_XXX
```

This command produces an application database file in your default OpenVMS directory. This file is sometimes called the ADB file because .ADB is the default file type (in this case, your EMPLOYEE_INFO_APPL_XXX.ADB file).

If the BUILD command succeeds, ADU displays a "Writing ADB" message.

If the BUILD command fails, ADU issues error messages and redisplay the ADU> prompt. Continue to correct the errors and resubmit the application to ADU until the application processes without errors.

Exit from ADU.

Defining and Building the Menu

This chapter describes how to write the menu definition. You then build this definition into a menu database that ACMS uses at run time.

11.1 Defining the Menu

In the menu definition, you describe the contents of the top-level menu displayed to users. You now define the ACMS menu from which terminal users can select either the data entry task or the inquiry/update task. ACMS provides a standard menu format.

To define a menu, specify a name for each entry and the name of the task (and application) to which the entry corresponds. A menu entry can also be the name of another menu, which allows you to create a hierarchy of menus for an application. However, this tutorial uses only one menu.

Create the menu definition as a source file of ADU commands in the same manner that you created previous ACMS definitions.

To begin writing the menu definition, follow these steps:

1. Use a text editor to create a source file for the menu definition. Name the source file `EMPLOYEE_INFO_MENU.MDF`.

Note

If you copied this file from the online source files, edit the file to change two occurrences of `EMPLOYEE_INFO_APPL_xxx` to your unique application name.

2. Begin your file by entering the following lines:

```
REPLACE MENU EMPLOYEE_INFO_MENU
  HEADER IS      "          Personnel Administration System";
```

In the `HEADER` clause, you specify a one- or two-line title, enclosed in quotation marks, for the top of the menu. When ACMS displays the menu, the title, `Personnel Administration System`, preceded by the given number of spaces, appears at the top. Note that you must use spaces to center a menu title; you cannot use tabs.

3. Add the following lines to your source file:

```
ENTRIES ARE
  "ADD"      : TASK IS EMPLOYEE_INFO_ADD_TASK IN EMPLOYEE_INFO_APPL_xxx;
              TEXT IS "Add new employee record";
  "UPDATE"   : TASK IS EMPLOYEE_INFO_UPDATE_TASK IN EMPLOYEE_INFO_APPL_xxx;
              TEXT IS "Display or update employee record";
END ENTRIES;
```

Defining and Building the Menu

11.1 Defining the Menu

You use the ENTRIES clause to specify the entries on the menu, the type of entry, and any explanatory text. Each entry you specify is either a task or another menu. If it is a task, ACMS runs the specified task from the specified application when the user selects that entry. In the ENTRIES clause here, you give each entry a name such as ADD, specifying each entry's type (TASK), its name in the application database, and the name of the application (the menu definition can point to tasks from different applications).

4. To end the menu definition, enter the following line at the end of the file:

```
END DEFINITION;
```

5. Your source file for the menu definition, EMPLOYEE_INFO_MENU.MDF, is now complete. Save your file and exit the editor.

11.2 Compiling the Menu Definition

Compile your source file after exiting the editor. Invoke ADU and submit the file EMPLOYEE_INFO_MENU.MDF as follows:

```
$ ADU
ADU> SET LOG
ADU> SET VERIFY
ADU> @EMPLOYEE_INFO_MENU.MDF
```

If ADU detects syntax errors in your menu definition, you must edit the source file to correct the errors and resubmit it. Repeat this sequence until the file processes without errors. If you receive error messages, make sure that you typed the definition exactly as shown. In particular, check that you used the appropriate punctuation.

Exit from ADU.

At this point, your default CDD directory contains the definitions for the application, the menu, the task group, the data entry task, and the inquiry/update task. Use the CDO DIRECTORY command to verify that these definitions exist:

```
$ CDO
CDO> DIRECTORY
CONTROL_WORKSPACE;1          RECORD
EMPLOYEE_INFO_ADD_TASK;1     ACMS$TASK
EMPLOYEE_INFO_APPL_XXX;1     ACMS$APPLICATION
EMPLOYEE_INFO_MENU;1         CDD$MENU
EMPLOYEE_INFO_RECORD;1       RECORD
EMPLOYEE_INFO_TASK_GROUP;1   ACMS$TASK_GROUP
EMPLOYEE_INFO_UPDATE_TASK;1  ACMS$TASK
EMPLOYEE_INFO_WKSP;1         RECORD
EMPL_CITY;1                  FIELD
EMPL_NAME;1                  FIELD
EMPL_NUMBER;1                FIELD
EMPL_STATE;1                 FIELD
EMPL_STREET_ADDRESS;1       FIELD
EMPL_ZIP_CODE;1              FIELD
ERROR_STATUS_FIELD;          FIELD
MESSAGEPANEL;                FIELD
QUIT_KEY;1                   FIELD
QUIT_WORKSPACE;1            RECORD

CDO>
```

To look at the contents of a field or a record, you can use the SHOW FIELD or SHOW RECORD command, followed by the name of the record or field.

11.3 Building the Menu

Build the menu with the ADU BUILD command and the MENU keyword:

```
$ ADU  
ADU> BUILD MENU EMPLOYEE_INFO_MENU
```

This command produces a menu database file in your default OpenVMS directory. The file is named EMPLOYEE_INFO_MENU.MDB.

If the BUILD command succeeds, ADU displays a "Writing MDB" message.

If the BUILD command fails, ADU issues error messages and redisplay the ADU> prompt. You must correct the errors and resubmit the menu to ADU, repeating this sequence until the menu processes without errors.

Exit from ADU.

System Management Requirements for Installing the Tutorial Application

This chapter describes procedures that your system manager follows to prepare for the installation of your tutorial application. Once these procedures are completed, you can install your application and run its tasks as described in Chapter 13.

Note

If you do not have the privileges (SYSPRV) necessary to perform the steps in this chapter, your system manager must perform these steps for you.

To perform these steps, your system manager needs to know the name of your application (represented here by `EMPLOYEE_INFO_APPL_xxx`) and the logical for your default directory (represented here by `xxx_FILES`).

12.1 System Management Overview

The system manager performs the steps in this chapter to prepare for the installation of the tutorial application. Specifically, the system manager does the following:

- Creates two OpenVMS user accounts named `EMPL_SERVER` and `EMPLOYEE_EXC`. These accounts are created using the OpenVMS Authorize Utility.
- Defines which users can sign in to ACMS and which menu is displayed to them when they sign in. ACMS provides the User Definition Utility (UDU) for this purpose.
- Defines which terminals can be used to sign in to ACMS. ACMS provides the Device Definition Utility (DDU) for this purpose.
- Defines which users can install the application in a protected directory. ACMS provides an optional utility, the Application Authorization Utility (AAU), to make it easier to protect the application.

12.2 Creating the `EMPL_SERVER` and `EMPLOYEE_EXC` Accounts

To set up OpenVMS user accounts, your system manager uses the OpenVMS Authorize Utility. Here the system manager uses the OpenVMS Authorize Utility to set up the user accounts of the server and the Application Execution Controller. In the tutorial application, the server's user name is `EMPL_SERVER`, and the controller's user name is `EMPLOYEE_EXC`.

System Management Requirements for Installing the Tutorial Application

12.2 Creating the EMPL_SERVER and EMPLOYEE_EXC Accounts

If you are not the first person at your site to use this tutorial, it is possible that the EMPLOYEE_EXC and EMPL_SERVER user names already exist in the OpenVMS User Authorization File (UAF). In that case, the system manager can check to see if the quotas are correct and can modify any that are not.

If the EMPL_SERVER account does not exist yet, create it using the following quotas and privileges:

```

Maxjobs:      0  Fillm:      200  Byt1m:      50000
Maxacctjobs:  0  Shrfillm:    0  Pbyt1m:     0
Maxdetach:    0  BIOLm:      100  JTquota:    1024
Prclm:        2  DIOLm:      22  WSdef:      512
Prio:         4  AST1m:      100  WSquo:      1024
Queprio:      0  TQELm:      100  WSextent:   4096
CPU:          (none)  Enqlm:      2000  Pgflquo:    60000
Authorized Privileges:
  GRPNAM GROUP SETPRV TMPMBX OPER NETMBX BYPASS
Default Privileges:
  GRPNAM GROUP TMPMBX OPER NETMBX BYPASS

```

If the EMPLOYEE_EXC account does not exist yet, create it using the following quotas and privileges:

```

Maxjobs:      0  Fillm:      200  Byt1m:      50000
Maxacctjobs:  0  Shrfillm:    0  Pbyt1m:     0
Maxdetach:    0  BIOLm:      100  JTquota:    1024
Prclm:        2  DIOLm:      22  WSdef:      512
Prio:         4  AST1m:      100  WSquo:      1024
Queprio:      0  TQELm:      100  WSextent:   4096
CPU:          (none)  Enqlm:      2000  Pgflquo:    60000
Authorized Privileges:
  GRPNAM GROUP SETPRV TMPMBX NETMBX
Default Privileges:
  GRPNAM GROUP TMPMBX NETMBX

```

For the EMPL_SERVER and EMPLOYEE_EXC user accounts, your system manager might need to increase some of the SYSGEN parameters. Your system manager should check the values of the following parameters whose names have the PQL_ prefix — in particular, the PQL_MENQLM parameter:

PQL_DASTLM	PQL_DBIOLM	PQL_DBYTLM	PQL_DCPULM
PQL_DDIOLM	PQL_DENQLM	PQL_DFILLM	PQL_DJTQUOTA
PQL_DPGFLQUOTA	PQL_DPRCLM	PQL_DTQELM	PQL_DWSDEFAULT
PQL_DWSEXTENT	PQL_DWSQUOTA	PQL_MASTLM	PQL_MBIOLM
PQL_MBYTLM	PQL_MCPULM	PQL_MDIOLM	PQL_MENQLM
PQL_MFILLM	PQL_MJTQUOTA	PQL_MPGFLQUOTA	PQL_MPRCLM
PQL_MTQELM	PQL_MWSDEFAULT	PQL_MWSEXTENT	PQL_MWSQUOTA

12.3 Authorizing ACMS Users

Authorized OpenVMS users cannot sign in to ACMS until the system manager has also authorized them as ACMS users. The User Definition Utility (UDU) provides the capability to do this. Using the UDU, the system manager creates an ACMS database named ACMSUDF.DAT, located in the SYS\$SYSTEM directory. When adding a user to the database, the system manager also specifies the default menu the user sees upon signing in to ACMS.

System Management Requirements for Installing the Tutorial Application

12.3 Authorizing ACMS Users

To add a new user to the ACMS database, perform the following steps:

1. Define UDU as a global symbol in your login command file. Then initialize the symbol by executing your login command file:

```
$ UDU := $ACMSUDU
```

```
$ @LOGIN.COM
```

2. Set the default directory to SYS\$SYSTEM:

```
$ SET DEFAULT SYS$SYSTEM  
$
```

3. Invoke UDU:

```
$ UDU  
UDU>
```

4. Add an OpenVMS user name (the tutorial user's uname) to the ACMS database by entering the ADD command:

```
UDU> ADD uname /MDB=xxx_FILES:EMPLOYEE_INFO_MENU  
UDU>
```

Include the MDB qualifier to specify the default menu displayed to this user when entering ACMS. Although the menu database is often located in ACMS\$DIRECTORY for security reasons, this tutorial places it in the tutorial user's default directory (represented by uname's system logical xxx_FILES) to avoid conflicts with others entering this tutorial on the same system. Substitute uname's logical for xxx_FILES.

5. Enter the SHOW command to verify this entry in the ACMSUDF.DAT database:

```
UDU> SHOW uname  
User name:      UNAME          DISPLAY MENU  
Default menu:  
Default MDB:   XXX_FILES:EMPLOYEE_INFO_MENU  
.  
.  
.  
UDU>
```

An entry under the tutorial user's uname indicates that the uname is authorized to sign in to ACMS. The default characteristic DISPLAY MENU causes ACMS to display the top menu in uname's EMPLOYEE_INFO_MENU.MDB database.

6. Enter the SHOW SYSTEM command to determine if user name SYSTEM has been added to the ACMS database (it may not, if this is the first ACMS access). If you receive a "user does not exist" message, then add SYSTEM as follows:

```
UDU> ADD SYSTEM /AGENT  
UDU>
```

Although ACMS assigns the user name SYSTEM to the Command Process (CP) when you install ACMS, it does not automatically authorize the Command Process as an agent. Without this authorization, ACMS cannot sign in any users. The /AGENT qualifier enables an agent to submit a task that has a user name different from the user name of the agent process.

7. Exit from UDU.

System Management Requirements for Installing the Tutorial Application

12.3 Authorizing ACMS Users

Other UDU commands let the system manager tailor definitions for individual users, change and remove user definitions, and change user names. See *HP ACMS for OpenVMS Managing Applications* for more information about UDU.

12.4 Authorizing ACMS Terminals

Authorized ACMS users must sign in from terminals that have been authorized for access to ACMS. With the Device Definition Utility (DDU), the system manager creates a database named ACMSDDF.DAT that contains a list of authorized ACMS devices. In the simplest case, the system manager can use one DDU definition to authorize all terminals on your system, both local and remote, to use ACMS.

To use DDU to authorize terminals for users, follow these steps:

1. Define DDU as a global symbol in your login command file. Then initialize the symbol by executing your login command file:

```
$ DDU := $ACMSDDU
$ @LOGIN.COM
```

2. Set the default directory to SYS\$SYSTEM:

```
$ SET DEFAULT SYS$SYSTEM
$
```

3. Invoke DDU:

```
$ DDU
DDU>
```

4. Use the ADD command to authorize a LAT terminal on your system for ACMS use. The device name LT authorizes all LAT terminals.

```
DDU> ADD LT
DDU>
```

If the ADD LT command has been performed before for a previous tutorial user, you receive the message, "device name already exists in the data base." In this case, you can exit from DDU and proceed to the next section.

5. Use the SHOW command to display information about the LT entry:

```
DDU> SHOW LT
Device name:      LT                NOT CONTROLLED
No Autologin
Printfile
DDU>
```

When the system manager creates a new ACMSDDF.DAT database, DDU creates a DEFAULT definition that assigns all terminals the NOT CONTROLLED characteristic. From a CONTROLLED terminal, the user signs in directly to ACMS; from a NOT CONTROLLED terminal, the user first logs in to the OpenVMS operating system and then signs in to ACMS from DCL command level.

6. Exit from DDU.

Other DDU commands let the system manager tailor definitions for individual terminals, change and remove device definitions, and change device names. See *HP ACMS for OpenVMS Managing Applications* for more information about DDU.

12.5 Authorizing ACMS Applications

ACMS requires that the application database (.ADB) file reside in the directory associated with the logical name ACMS\$DIRECTORY. Because this directory can be protected from unauthorized use, all application databases in ACMS\$DIRECTORY remain secure.

Your application, EMPLOYEE_INFO_APPL_XXX.ADB, is currently located in your default OpenVMS directory. However, ACMS cannot find it there. You must install your application in ACMS\$DIRECTORY after your system manager uses the Application Authorization Utility (AAU) to authorize both you and your application.

To use AAU to authorize tutorial users to install their applications in ACMS\$DIRECTORY, follow these steps:

1. Define AAU as a global symbol in your login command file. Then initialize the symbol by executing your login command file:

```
$ AAU := $ACMSAAU
$ @LOGIN.COM
```

2. Set the default directory to SYS\$SYSTEM:

```
$ SET DEFAULT SYS$SYSTEM
$
```

3. Invoke AAU:

```
$ AAU
AAU>
```

If an ACMSAAF.DAT file does not exist yet in the SYS\$SYSTEM directory (that is, this is the first time invoking AAU), AAU displays a message stating that it is unable to open ACMSAAF.DAT and prompting the system manager to create a new file. If the file does exist already, AAU returns the AAU> prompt.

Creating this database is the first step of a two-step process. The system manager first uses the Application Authorization Utility (AAU) to create the database ACMSAAF.DAT in the SYS\$SYSTEM directory. The system manager then adds to this file a list of applications and users who are authorized to install them.

4. By authorizing users to install applications, system managers can free themselves from having to install all applications and from having to give those users privileged access to ACMS\$DIRECTORY. When the system manager creates a new ACMSAAF.DAT database, AAU creates a DEFAULT authorization with an empty access control list; that is, by default no users are authorized to install applications in ACMS\$DIRECTORY.

Enter the ADD command with an /ACL qualifier to authorize the application and the user who can install it:

```
AAU> ADD EMPLOYEE_INFO_APPL_XXX /ACL=(ID=[uname],ACCESS=CONTROL)
%ACMSAAU-S-APPLADD, Appl name EMPLOYEE_INFO_APPL_XXX has been added
to the database
AAU>
```

System Management Requirements for Installing the Tutorial Application

12.5 Authorizing ACMS Applications

This command authorizes application EMPLOYEE_INFO_APPL_XXX and authorizes user UNAME to install it. The /ACL qualifier overrides the default access control list. Remember that UNAME is the tutorial user's OpenVMS account name, and EMPLOYEE_INFO_APPL_XXX represents this user's application name (check with the tutorial user for the exact name).

5. Enter the SHOW command to verify the user's application name in the ACMSAAF.DAT database:

```
AAU> SHOW EMPLOYEE_INFO_APPL_XXX

=====
Appl name:      EMPLOYEE_INFO_APPL_XXX
Appl Username:  *
Server Usernames:
                *
Access Control List:
  (IDENTIFIER=[ACMS,UNAME],ACCESS=CONTROL)
=====
AAU>
```

This display verifies that user UNAME is authorized to install the application database file EMPLOYEE_INFO_APPL_XXX.ADB. The asterisks in the application and server user name fields mean that the user names in the .ADB file are the only user names allowed for the application and the server.

6. Exit from AAU.

Other AAU commands let the system manager specify more characteristics of individual applications, authorize all applications with the \$ALL keyword, remove authorizations, and change authorization names. See *HP ACMS for OpenVMS Managing Applications* for more information about AAU.

12.6 Defining the ACMS\$DIRECTORY Logical

The system manager needs to verify that the ACMS\$DIRECTORY logical is associated with the device and directory where ACMS applications are to be stored. In the case of a new ACMS installation, the system manager may not yet have set up a protected directory for storing ACMS applications. If not, the system manager must first set up such a directory before defining the logical that points to it. Defining the ACMS\$DIRECTORY logical must be done before the tutorial user can install the tutorial application.

If other ACMS applications are already on the tutorial user's system, the ACMS\$DIRECTORY logical has been defined already. To verify the logical and define it, perform the following steps:

1. Enter the SHOW LOGICAL command to see whether ACMS\$DIRECTORY has been defined on the tutorial user's system:

```
$ SHOW LOGICAL ACMS$DIRECTORY
```

If the logical is defined, the subsequent display shows the disk and directory location that the logical points to. If the display states that the logical is undefined, then proceed to the next step and define it.

2. Set your default directory to SYS\$MANAGER and run the ACMS_POST_INSTALL.COM command procedure located there:

```
$ SET DEFAULT SYS$MANAGER
$ @ACMS_POST_INSTALL.COM
```

System Management Requirements for Installing the Tutorial Application

12.6 Defining the ACMS\$DIRECTORY Logical

This command procedure defines all the standard ACMS logicals.

With the successful completion of this step, the tutorial user can proceed to install the application and run it.

Installing and Running the Application

This chapter describes how to install and run your tutorial application. Before running the application, you perform steps to start the ACMS system (if not running) and to start your specific application. After running your application, you perform steps to stop your application and stop the ACMS system (if no one else is using it).

13.1 Installing the Application

When you install an application, ACMS checks the ACMSAAF.DAT database to determine whether you are authorized to install that application. If so, ACMS copies the database to ACMS\$DIRECTORY, deletes any earlier versions, and changes the user identification code (UIC) of the .ADB file to [1,4].

If you are not authorized to install the application, ACMS returns an error message indicating that you are not authorized. (Your system manager must have authorized you and your application with the AAU, as explained in Section 12.5.)

You install your application database file in ACMS\$DIRECTORY by executing the ACMS/INSTALL command at DCL command level.

To install your application in ACMS\$DIRECTORY, follow these steps:

1. Make sure that your system manager has defined the system logical ACMS\$DIRECTORY to be associated with the device and directory where ACMS applications are to be stored. Enter the SHOW LOGICAL command to see whether ACMS\$DIRECTORY has been defined on your system:

```
$ SHOW LOGICAL ACMS$DIRECTORY
```

If you receive a message stating that ACMS\$DIRECTORY is undefined, ask your system manager to define it before trying to install your application.

2. To perform INSTALL, you must be in the directory where your application (EMPLOYEE_INFO_APPL_xxx.ADB) is located. If you are not, then set the default directory to the directory where your application files are located:

```
$ SET DEFAULT udisk:[uname]
```

3. Issue the ACMS/INSTALL command to install your application:

```
$ ACMS/INSTALL EMPLOYEE_INFO_APPL_xxx
```

```
%ACMSINS-S-ADBINS, Application UDISK:[UNAME]EMPLOYEE_INFO_APPL_XXX
has been installed to ACMS$DIRECTORY
$
```

The message indicates that you have successfully installed your EMPLOYEE_INFO_APPL_xxx.ADB application database file in ACMS\$DIRECTORY.

Installing and Running the Application

13.2 Starting the Application

13.2 Starting the Application

Once all authorizations and installations are complete, you can start the ACMS system and start your application. To start and stop the ACMS system automatically with the OpenVMS system, you can include the ACMS/START and ACMS/STOP operator commands in your system startup and shutdown command files. However, in this tutorial, you start and stop ACMS interactively.

Any account from which the ACMS/START and ACMS/STOP commands are issued must have OpenVMS OPER privilege to execute these commands.

To start the ACMS system (if it is currently stopped), and to start your tutorial application, perform the following steps:

1. Issue the SHOW SYSTEM command to determine if another user has already started ACMS:

```
$ ACMS/SHOW SYSTEM
```

If the subsequent display states that "current system state" is STOPPED, proceed to the next step and start the ACMS system. However, if the display states that the current system state is STARTED, proceed to step 3.

2. Issue the START SYSTEM command to start the ACMS system:

```
$ ACMS/START SYSTEM
```

If the ACMS system starts successfully, the dollar (\$) prompt returns with no intervening error messages.

3. Before you can invoke a command that runs the application, you need to start the application. Issue the START APPLICATION command with the name of your tutorial application:

```
$ ACMS/START APPLICATION EMPLOYEE_INFO_APPL_xxx
```

If the ACMS system starts successfully, the \$ prompt returns with no intervening error messages. However, if your system logical xxx_FILES is not defined on this system, you receive an error message that states, in part, "Error opening TDB file XXX_FILES:[EMPLOYEE_EXC]..." See Section 7.6 for information about defining your system logical.

If you receive an "invalid login attempt" message, your system manager may not have authorized the ACMS Command Process (CP) to run as an agent (described in Section 12.3). Without this authorization, ACMS cannot sign in any users.

The audit trail log (ATL) keeps a record of when the ACMS system starts and stops, when users sign in, when applications and tasks start and stop, and what errors occur. To display this log, you can run the Audit Trail Report Utility (ATR) (see Section A.2).

13.3 Running the Application

If your system manager has authorized you to use ACMS, and has authorized your terminal, you can run your tutorial application by issuing the ACMS/ENTER command. When you enter this command, ACMS checks the authorization files to determine whether you and your terminal are authorized.

If you pass the authorization check, ACMS displays your default menu and waits for you to select a task. When you do, ACMS finds that task in the .TDB file and runs the task.

Installing and Running the Application

13.3 Running the Application

To run your tutorial application, perform the following steps:

1. Issue the ENTER command to enter your application and display your default menu:

```
$ ACMS/ENTER
```

If this command is successful, ACMS displays your default menu. Figure 13–1 shows the selection menu displayed for this tutorial application.

Figure 13–1 Selection Menu

```
Personnel Administration System

1  ADD          T  Add new employee record
2  UPDATE       T  Display or update employee record

Selection: █
```

2. Choose an entry from the selection menu either by name or by number. For example, to select the ADD task, type either ADD or 1 at the Selection prompt and then press **Return**.

When you select a task, the form for that task appears on your screen. For example, when you select the ADD task, the form for filling in employee information appears. When you finish filling in the form, press **Ctrl/Z** to save the information in your RMS master file. To leave the form without saving the information, press **PF4**.

After you complete a task (by pressing **Ctrl/Z** or **PF4**), ACMS redisplay the selection menu and waits for you to select another task or exit from ACMS.

Before exiting from ACMS, you may wish to try several ADD tasks and several UPDATE tasks. You may also wish to try adding an employee number that already exists in your RMS master file so that you can see how the application responds to a duplicate-record error. Also, if you create two OpenVMS processes and run this application in each of them, you can test how the application responds when two users try to update the same employee record at the same time. (The last user to save the modifications receives a message that the record has been changed since he or she began updating it.)

3. To exit from ACMS, type EXIT at the Selection prompt and press **Return**.

You have now run your application and seen the results of choosing either the data entry task or the inquiry/update task. It is often helpful, especially in problem-solving, to know the various steps that ACMS takes to run one of these tasks. This information is available in Appendix A.

Installing and Running the Application

13.3 Running the Application

Appendix A also describes how to access various utilities that can help you solve problems that may occur when you run an ACMS application. These utilities include:

- Audit Trail Report (ATR), for a record of when applications start and stop
- Software Event Log (SWL), for a record of internal software errors
- HP DECforms trace facility, for a record of the form processing that occurs when the ACMS application calls a HP DECforms request
- ACMS Help, for information about ACMS error messages

13.4 Stopping the Application and the ACMS System

You can stop your application and the ACMS system with the ACMS/STOP command. Before you stop the system, however, issue the SHOW SYSTEM command to see if another person is using the ACMS system:

```
$ ACMS/SHOW SYSTEM
```

The system displays the names of any active applications and any active users. If no other applications or users are active, issue both ACMS/STOP commands. Otherwise, issue only the STOP APPLICATION command, specifying the name of your application:

```
$ ACMS/STOP APPLICATION EMPLOYEE_INFO_APPL_xxx
$ ACMS/STOP SYSTEM
$
```

ACMS waits until all active tasks have finished executing before it stops the application and the system.

Other ACMS operator commands allow you to display information about your ACMS system and perform application management functions. *HP ACMS for OpenVMS Managing Applications* contains a detailed discussion of ACMS operator commands.

Part III

AVERTZ Sample Application

This part provides an overview of the AVERTZ car rental sample application that ships with the HP ACMS for OpenVMS software kit.

Before You Begin

The AVERTZ car company is a fictional car rental company created to illustrate how transaction processing (TP) can solve a business problem. With AVERTZ, the business problem is how data entry personnel can quickly and efficiently create, access, and update car rental information.

As you walk through Part III and through the AVERTZ application, you can see different perspectives of a single TP system. This document contains the following three chapters, and is organized so that you can get AVERTZ up and running quickly:

- *System Manager's View*

The system manager is concerned with the implementation and management of a TP application in a production environment (real use, as opposed to testing). For AVERTZ, the system manager must build the database and application, set up the AVERTZ environment, and manage users and devices.

- *User's View*

The user is concerned with the business transaction that is taking place: namely, the rental of cars. The user could be a clerk who is taking a reservation from a customer, or tallying up the bill for a customer returning a rental; the user could also be a site manager who is responsible for the operations of a particular field unit.

- *Behind the Scenes*

Application designers and developers work behind the scenes to create and modify running transaction processing applications. The designer is concerned with computerizing manual business transactions, or upgrading existing transaction processing systems. The developer is concerned with developing and testing the transaction processing application outlined by the designer.

System Manager's View

Since the AVERTZ application is already designed and developed, the first step you should take is to set up the application so that you can try it out. This chapter helps you build, install, and set up AVERTZ.

Note

You cannot build the AVERTZ application under multiversion Rdb.

Before you follow the instructions in this chapter, check to make sure that the ACMS\$DIRECTORY logical name is defined. Check this by typing the following command at your DCL prompt:

```
$ SHOW LOGICAL ACMS$DIRECTORY
```

If the logical name is defined, you can proceed with the instructions in this chapter. If the logical name is not defined, you receive the following error message:

```
%SHOW-S-NOTRAN, no translation for logical name ACMS$DIRECTORY
```

If you receive this error message, then *before* proceeding with the instructions in this document, you must follow the postinstallation instructions in *HP ACMS Version 5.0 for OpenVMS Installation Guide*.

Before you try to run the AVERTZ application, you must create a transaction log for HP DECdtm services. See *HP ACMS Version 5.0 for OpenVMS Installation Guide* for a description of how to do this.

15.1 Building the AVERTZ Application and Databases

The AVERTZ environment consists of the following directories:

- Source code
- Data dictionary
- AVERTZ databases (VEHICLE_RENTALS and VEHICLE_HISTORY)
- AVERTZ images

Before you can run the AVERTZ application, you must build the databases and application. To build the databases and application, log in to an OpenVMS account that has SYSPRV privileges, and enter the following command:

```
$ SET PROCESS/PRIVILEGE=SYSPRV
```

If SYSPRV is not enabled for the account you use, ask your system manager to enable that privilege using the OpenVMS Authorize Utility.

System Manager's View

15.1 Building the AVERTZ Application and Databases

Once your account has SYSPRV enabled, enter the following command to use the directory that contains the AVERTZ sources:

```
$ SET DEFAULT ACMS$EXAMPLES
```

To build the AVERTZ application, use the AVERTZ_BLD.COM command procedure, which is in the ACMS\$EXAMPLES directory. The AVERTZ_BLD.COM procedure:

- Creates the data dictionary and database directories
- Defines the fields and records in the data dictionary
- Compiles the tasks, form, server procedures, message file, menu, and application definition
- Builds the application (task group, application, servers, message file, and form)
- Installs the AVERTZ application (named VR_APPL) in the ACMS\$DIRECTORY directory
- Builds the VEHICLE_RENTALS and VEHICLE_HISTORY databases

The AVERTZ_BLD.COM procedure requires additional files for successful execution. These files ship with the AVERTZ application, and are located in the ACMS\$EXAMPLES directory:

- BUILD_APPLICATION.COM
- BUILD_FORM.COM
- BUILD_MENU.COM
- BUILD_MESSAGE_FILE.COM
- BUILD_TASK_GROUP.COM
- COMPILE_SERVER_PROC.COM
- COMPILE_TASKS.COM
- DEFINE_CDD_ENTITIES.COM
- LINK_SERVERS.COM
- COMPILE_SERVER_PROC.COM

When you run AVERTZ_BLD.COM, you are prompted to enter a directory location for the source code, the data dictionary, the databases, and the images.

The following example shows a sample walkthrough of AVERTZ_BLD.COM. You can follow the instructions by entering the commands and responses that are printed in red.

1. To start the build procedure, enter the following at the DCL prompt:

```
$ @AVERTZ_BLD.COM
```

AVERTZ_BLD.COM displays the default directory and then prompts you for the source directory:

```
Enter name of the source directory for AVERTZ - e.g. disk1:[x.y]:
```

2. Enter the following:

```
SYS$COMMON: [SYSHLP.EXAMPLES.ACMS]
```

System Manager's View

15.1 Building the AVERTZ Application and Databases

AVERTZ_BLD.COM prompts you for the data dictionary directory:

Enter name of the directory for AVERTZ CDD dictionary - e.g. disk1:[x.y]:

3. Enter the following:

```
SYS$COMMON: [SYSHLP.EXAMPLES.ACMS.DICTIONARY]
```

AVERTZ_BLD.COM prompts you for the database directory:

Enter name of the database directory for AVERTZ - e.g. disk1:[x.y]:

4. Enter the following:

```
SYS$COMMON: [SYSHLP.EXAMPLES.ACMS.DATABASE]
```

AVERTZ_BLD.COM asks you if you want the object and image files in the source directory.

Place object and image files in the source directory? [Y]/N:

5. Enter the following if you want the object and image files in the same directory as the source files:

Y

AVERTZ_BLD.COM then displays the directory specifications and asks you if they are correct.

Are these directory names correct? - Y/[N]:

6. If the names are correct, enter Y:

Y

You are then asked if the CDD dictionary has been created. If this is your first time building the AVERTZ application, enter N.

Have the CDD dictionary and its sub-directories been created?:

7. Enter the following if this is your first time running AVERTZ_BLD.COM:

N

AVERTZ_BLD.COM proceeds to create the directory structure for the data dictionary. Some informational messages are displayed and you are asked if you want to define the fields and records in the data dictionary.

Define fields and records in CDD? - Y/[N]:

8. Enter the following:

Y

After you enter Y, AVERTZ_BLD.COM defines the fields and records and then asks you if you want to build the message file.

Build message file? - Y/[N]:

9. Enter the following:

Y

AVERTZ_BLD.COM builds the message file and then asks you if you want to compile the tasks.

Compile tasks? - Y/[N]:

System Manager's View

15.1 Building the AVERTZ Application and Databases

10. Enter the following:

Y

AVERTZ_BLD.COM compiles the tasks, displaying informational messages, and then asks you if you want to build the task group.

Build task group? - Y/[N]:

11. Enter the following:

Y

AVERTZ_BLD.COM builds the task group, displaying informational messages, and then asks if you want to build the menu.

Build menu? - Y/[N]:

12. Enter the following:

Y

AVERTZ_BLD.COM builds the menu, displaying informational messages, and then asks you if you want to build the application.

Build application? - Y/[N]:

13. Enter the following:

Y

AVERTZ_BLD.COM builds the application and installs it in the ACMS\$DIRECTORY directory. The procedure then asks if you want to build the form.

Build form? - Y/[N]:

14. Enter the following:

Y

AVERTZ_BLD.COM compiles the form and then asks if you want to compile the server procedures.

Compile server procedures? - Y/[N]:

15. Enter the following:

Y

AVERTZ_BLD.COM then displays a message stating that in order for the server procedures to compile successfully, the VEHICLE_RENTALS and VEHICLE_HISTORY databases have to be built. You are asked if they have been built.

Have the VEHICLE_RENTALS and VEHICLE_HISTORY databases been built?:

16. Enter the following if this is your first time building the AVERTZ application:

N

AVERTZ_BLD.COM builds the two databases, and loads data into the VEHICLE_RENTALS database and compiles the server procedures. You are asked if you want to link the server procedures.

Link servers? - Y/[N]:

17. Enter the following:

Y

AVERTZ_BLD.COM links the server procedures.

15.1.1 Build Options

This section is mainly for future reference, after you install and run AVERTZ. The information in this section allows you to change components of AVERTZ and incorporate those new components into AVERTZ.

Once you become familiar with the AVERTZ application, you might want to modify some of the source files for learning purposes. When you modify a source file, you must run the AVERTZ_BLD.COM procedure again to include the modified sources into the running application.

The AVERTZ_BLD.COM procedure takes either one parameter or no parameter. The parameters that the AVERTZ_BLD.COM accepts are listed in Table 15–1.

Table 15–1 Parameters for the AVERTZ Build Procedure

Parameter	Effect
COMPLETE	Executes the entire command procedure
CDD	Defines the fields and records in the data dictionary
MSG	Compiles and builds the message file
TASK	Compiles the task definitions
GROUP	Compiles and builds the task group
MENU	Builds the AVERTZ menu
APPL	Compiles and builds the application definition
FORM	Compiles and builds the form
PROC	Compiles the server procedures
LINK	Links the server procedures

If you specify COMPLETE as a parameter, AVERTZ recompiles the entire application. The other parameters allow you to selectively choose the components of the application that are recompiled and built into the running application. If you change a task definition, for example, you can run AVERTZ_BLD.COM with the TASK parameter by entering the following command:

```
$ @AVERTZ_BLD.COM TASK
```

The command procedure compiles only the task definitions, and includes the new task definitions with the running application.

15.2 Setting Up the AVERTZ Environment

Before you can begin running the AVERTZ application, there is some "one time only" work that needs to be done. You must:

- Create AVERTZ accounts
- Define AVERTZ logical names

The next two sections describe how to do this work.

System Manager's View

15.2 Setting Up the AVERTZ Environment

15.2.1 Creating AVERTZ Accounts

The system manager typically creates user accounts for the Application Execution Controller (a component of ACMS that coordinates task execution), and each of the servers (accounts that handle processing work). These accounts are created using the Authorize utility. The name of the Application Execution Controller for AVERTZ is AVERTZ_EXC; the names of the servers for AVERTZ are AVERTZ_LOG, AVERTZ_READ, and AVERTZ_UPD.

Your system manager should create the AVERTZ_EXC account with the following quotas and privileges:

```
Maxjobs:      0  Fillm:      200  Byt1m:      50000
Maxacctjobs:  0  Shrfillm:    0  Pbyt1m:     0
Maxdetach:    0  BI01m:      190  JTquota:    1024
Prclm:        2  DI01m:      45  WSdef:      756
Prio:         4  AST1m:      392  WSquo:     1024
Queprio:      0  TQElm:      221  WSextent:   4096
CPU:          (none) Enqlm:    2000  Pgflquo:   50000
```

Authorized Privileges:

```
GROUP GRPNAM NETMBX SETPRV TMPMBX
```

Default Privileges:

```
GROUP GRPNAM NETMBX TMPMBX
```

Your system manager should create the AVERTZ_LOG account with the following quotas and privileges:

```
Maxjobs:      0  Fillm:      200  Byt1m:      50000
Maxacctjobs:  0  Shrfillm:    0  Pbyt1m:     0
Maxdetach:    0  BI01m:      190  JTquota:    1024
Prclm:        4  DI01m:      45  WSdef:      756
Prio:         4  AST1m:     1000  WSquo:     1024
Queprio:      0  TQElm:      221  WSextent:   4096
CPU:          (none) Enqlm:    2000  Pgflquo:   60000
```

Authorized Privileges:

```
GROUP GRPNAM NETMBX SETPRV TMPMBX
```

Default Privileges:

```
GROUP GRPNAM NETMBX TMPMBX
```

Your system manager should create the AVERTZ_READ account with the following quotas and privileges:

```
Maxjobs:      0  Fillm:      200  Byt1m:      50000
Maxacctjobs:  0  Shrfillm:    0  Pbyt1m:     0
Maxdetach:    0  BI01m:      190  JTquota:    1024
Prclm:        2  DI01m:      45  WSdef:      756
Prio:         4  AST1m:      392  WSquo:     1024
Queprio:      0  TQElm:      221  WSextent:   4096
CPU:          (none) Enqlm:    2000  Pgflquo:   50000
```

Authorized Privileges:

```
GROUP GRPNAM NETMBX SETPRV TMPMBX
```

Default Privileges:

```
GROUP GRPNAM NETMBX TMPMBX
```

System Manager's View 15.2 Setting Up the AVERTZ Environment

Your system manager should create the AVERTZ_UPD account with the following quotas and privileges:

```
Maxjobs:      0  Fillm:      200  Byt1m:      50000
Maxacctjobs:  0  Shrfillm:   0    Pbyt1m:     0
Maxdetach:   0  BI01m:     190  JTquota:    1024
Prclm:       7  DI01m:     45   WSdef:      756
Prio:        4  AST1m:     392  WSquo:     1024
Queprio:     0  TQElm:    221  WSextent:   4096
CPU:         (none) Enqlm:    2000  Pgflquo:    50000
```

Authorized Privileges:
GROUP GRPNAM NETMBX SETPRV TMPMBX

Default Privileges:
GROUP GRPNAM NETMBX TMPMBX

For the AVERTZ_EXC, AVERTZ_LOG, AVERTZ_READ, and AVERTZ_UPD user accounts, your system manager might need to increase some of the SYSGEN parameters. Your system manager should check the values of the following parameters whose names have the PQL_ prefix — in particular, the PQL_MENQLM parameter:

PQL_DASTLM	PQL_DBIOLM	PQL_DBYTLM	PQL_DCPULM
PQL_DDIOLM	PQL_DENQLM	PQL_DFILLM	PQL_DJTQUOTA
PQL_DPGFLQUOTA	PQL_DPRCLM	PQL_DTQELM	PQL_DWSDEFAULT
PQL_DWSEXTENT	PQL_DWSQUOTA	PQL_MASTLM	PQL_MBIOLM
PQL_MBYTLM	PQL_MCPULM	PQL_MDIOLM	PQL_MENQLM
PQL_MFILLM	PQL_MJTQUOTA	PQL_MPGFLQUOTA	PQL_MPRCLM
PQL_MTQELM	PQL_MWSDEFAULT	PQL_MWSEXTENT	PQL_MWSQUOTA

15.2.2 Defining System Logical Names

The AVERTZ_DEFAULT and AVERTZ_DATABASE logical names are required in order for you to run the AVERTZ application.

The AVERTZ_DEFAULT logical name must point to the directory that contains the AVERTZ source files. Since the ACMS installation places the source files in SYS\$COMMON:[SYSHLP.EXAMPLES.ACMS], enter the following command:

```
$ DEFINE/SYSTEM AVERTZ_DEFAULT SYS$COMMON:[SYSHLP.EXAMPLES.ACMS]
```

The AVERTZ_DATABASE logical name must point to the directory that contains the databases. Since the ACMS installation places the databases in SYS\$COMMON:[SYSHLP.EXAMPLES.ACMS.DATABASE], enter the following command:

```
$ DEFINE/SYSTEM AVERTZ_DATABASE SYS$COMMON:[SYSHLP.EXAMPLES.ACMS.DATABASE]
```

To ensure that these logical names are defined when your system reboots, you can also add these lines to your system startup command procedure. The default startup command procedure for OpenVMS VAX Version 5.x is SYS\$MANAGER:SYSTARTUP_V5.COM. The default startup command procedure for OpenVMS VAX starting with Version 6.x and for OpenVMS Alpha and OpenVMS I64 systems is SYS\$MANAGER:SYSTARTUP_VMS.COM.

System Manager's View

15.3 Managing the AVERTZ Environment

15.3 Managing the AVERTZ Environment

Once the AVERTZ accounts and logical names are set up, you can begin to authorize specific users and devices for AVERTZ. You must:

- Authorize users for ACMS
- Authorize terminals for ACMS

The next two sections describe how to do this work. You can refer to these instructions as you continue to add authorized users and terminals for AVERTZ.

15.3.1 Authorizing ACMS Users

Authorized OpenVMS users cannot sign in to ACMS until the system manager has also authorized them as ACMS users. The User Definition Utility (UDU) provides the capability to do this. Using the UDU, the system manager creates an ACMS database named ACMSUDF.DAT, located in the SYS\$SYSTEM directory. When adding a user to the database, the system manager also specifies the default menu the user sees upon signing in to ACMS.

To add a new user to the ACMS database, perform the following steps:

1. Define UDU as a global symbol in your login command file. Then initialize the symbol by executing your login command file:

```
$ UDU := $ACMSUDU
$ @LOGIN.COM
$
```

2. Set the default directory to SYS\$SYSTEM:

```
$ SET DEFAULT SYS$SYSTEM
$
```

3. Invoke UDU:

```
$ UDU
UDU>
```

4. Add an OpenVMS user name to the ACMS database by entering the ADD command:

```
UDU> ADD uname /MDB=AVERTZ_DEFAULT:VR_MENU
UDU>
```

Include the MDB qualifier to specify the default menu displayed to this user when entering ACMS.

5. Enter the SHOW command to verify this entry in the ACMSUDF.DAT database:

```
UDU> SHOW uname
User name:      UNAME          DISPLAY MENU
Default menu:
Default MDB:    AVERTZ_DEFAULT:VR_MENU
.
.
.
UDU>
```

An entry under uname indicates that the uname is authorized to sign in to ACMS. The default characteristic DISPLAY MENU causes ACMS to display the top menu in uname's VR_MENU database.

System Manager's View

15.3 Managing the AVERTZ Environment

6. Enter the SHOW SYSTEM command to determine if user name SYSTEM has been added to the ACMS database (it may not, if this is the first ACMS access). If you receive a "user does not exist" message, then add SYSTEM as follows:

```
UDU> ADD SYSTEM /AGENT
UDU>
```

Although ACMS assigns the user name SYSTEM to the Command Process (CP) when you install ACMS, it does not automatically authorize the Command Process as an agent. Without this authorization, ACMS cannot sign in any users. The /AGENT qualifier enables an agent to submit a task that has a user name different from the user name of the agent process.

7. Exit from UDU.

15.3.2 Authorizing ACMS Terminals

Authorized ACMS users must sign in from terminals that have been authorized for access to ACMS. With the Device Definition Utility (DDU), the system manager creates a database named ACMSDDF.DAT that contains a list of authorized ACMS devices. In the simplest case, the system manager can use one DDU definition to authorize all terminals on your system, both local and remote, to use ACMS.

To use DDU to authorize terminals for users, follow these steps:

1. Define DDU as a global symbol in your login command file. Then initialize the symbol by executing your login command file:

```
$ DDU := $ACMSDDU
$ @LOGIN.COM
$
```

2. Set the default directory to SYS\$SYSTEM:

```
$ SET DEFAULT SYS$SYSTEM
$
```

3. Invoke DDU:

```
$ DDU
DDU>
```

4. Use the ADD command to authorize a LAT terminal on your system for ACMS use. The device name LT authorizes all LAT terminals.

```
DDU> ADD LT
DDU>
```

If the ADD LT command has been performed before, you receive the message, "device name already exists in the data base." In this case, you can exit from DDU and proceed to the next section.

5. Use the SHOW command to display information about the LT entry:

```
DDU> SHOW LT
Device name:      LT                NOT CONTROLLED
No Autologin
Printfile
DDU>
```

System Manager's View

15.3 Managing the AVERTZ Environment

When the system manager creates a new ACMSDDF.DAT database, DDU creates a DEFAULT definition that assigns all terminals the NOT CONTROLLED characteristic. From a CONTROLLED terminal, the user signs in directly to ACMS; from a NOT CONTROLLED terminal, the user first logs in to the OpenVMS operating system and then signs in to ACMS from DCL command level.

6. Exit from DDU.

15.4 Starting and Stopping ACMS and AVERTZ

Both the ACMS system and the AVERTZ application must be started before users can sign in. You can also stop your ACMS system or AVERTZ application at any time. The next two sections describe how to:

- Start ACMS and AVERTZ
- Stop ACMS and AVERTZ

15.4.1 Starting ACMS and the AVERTZ Application

Any account from which the ACMS/START and ACMS/STOP commands are issued must have OpenVMS OPER privilege to execute these commands.

To start the ACMS system (if it is currently stopped), and to start the AVERTZ application, perform the following steps:

1. Issue the SHOW SYSTEM command to determine if another user has already started ACMS:

```
$ ACMS/SHOW SYSTEM
```

If the subsequent display states that "current system state" is STOPPED, proceed to the next step and start the ACMS system. However, if the display states that the current system state is STARTED, proceed to step 3.

2. Issue the START SYSTEM command to start the ACMS system:

```
$ ACMS/START SYSTEM
```

If the ACMS system starts successfully, the \$ prompt returns with no intervening error messages.

3. Before you can invoke a command that runs the application, you need to start the application. Issue the START APPLICATION command with the name of the AVERTZ application:

```
$ ACMS/START APPLICATION VR_APPL
```

If the ACMS system starts successfully, the \$ prompt returns with no intervening error messages. However, if your system logical AVERTZ_DEFAULT is not defined on this system, you receive an error message that states, in part, "Error opening TDB file AVERTZ_DEFAULT:[SYSHLP.EXAMPLES.ACMS]..." See Section 15.2.2 for information about defining your system logical.

If you receive an "invalid login attempt" message, your system manager may not have authorized the ACMS Command Process (CP) to run as an agent (described in Section 15.3.1). Without this authorization, ACMS cannot sign in any users.

15.4.2 Stopping the AVERTZ Application and ACMS

You can stop your application and the ACMS system with the ACMS/STOP command. Before you stop the system, however, issue the SHOW SYSTEM command to see if another person is using the ACMS system:

```
$ ACMS/SHOW SYSTEM
```

The system displays the names of any active applications and any active users. If no other applications or users are active, issue both ACMS/STOP commands. Otherwise, issue only the STOP APPLICATION command, specifying the name of your application:

```
$ ACMS/STOP APPLICATION VR_APPL  
$ ACMS/STOP SYSTEM  
$
```

ACMS waits until all active tasks have finished executing before it stops the application and the system.

To understand how the AVERTZ application looks to the user, imagine the conversation between a reservation clerk working for AVERTZ operations in New England and a customer who needs a rental car.

16.1 Entering AVERTZ

After his morning cup of coffee, Sparky Hartshorn, a reservation clerk at AVERTZ, enters the AVERTZ application from his OpenVMS account:

```
$ ACMS/ENTER VR_APPL 
```

AVERTZ displays the AVERTZ Rental Menu shown in Figure 16–1.

Figure 16–1 AVERTZ Rental Menu

AVERTZ RENTAL MENU			
1	RESERVE	T	Make a vehicle reservation
2	CHECKOUT	T	Checkout a vehicle
3	CHECKIN	T	Return a vehicle

Selection:

VM-0375A-AI

To select an option, the clerk types the option number and presses . For example, to reserve a car, the clerk types:

```
Selection:1
```

If the clerk needs online help while using AVERTZ, he can display help for any field by pressing when the cursor is on that field.

The next three sections describe a sample dialog between a customer and the clerk at AVERTZ for the following transactions:

- Reserving a car
- Checking out a car (beginning the rental)
- Checking in a car (ending the rental)

User's View

16.2 Customer Reserves a Car

16.2 Customer Reserves a Car

Bertram Simpson needs a car. The following telephone conversation between Bertram and the AVERTZ clerk, on April 19, shows how the reservation option is used in a real business situation. Integrated with the conversation are the steps the clerk must take to enter the car reservation in AVERTZ:

Clerk: "Hello, AVERTZ Car Rental . . . can I help you?"
Customer: "Oh, hi. My name is Bertram Simpson and I need to rent a car for this weekend."
Clerk: "OK, Mr. Simpson. Let me just ask you a few questions."
The clerk enters the following at the AVERTZ Rental Menu:

Selection: 1[Return]

AVERTZ displays the reservation panel shown in Figure 16–2.

Figure 16–2 Reservation Panel

19-Apr-91		AVERTZ VEHICLE RENTALS		RESERVE
Customer ID:	0	First Name:	Initial:	Last Name:
Site ID:	City:			
Checkout Date:	19-Apr-1991	Return Date:	19-Apr-1991	Car Type Code:
RETURN to continue, PF1 Q to quit, TAB to go forward, B5 or F12 to move back HELP for help filling in the field, HELP HELP for general help PF1 M to clear message line				

VM-0376A-AI

Clerk: "Have you rented a vehicle with us before?"
The clerk asks this question because, if Mr. Simpson is an existing customer, the clerk can enter his customer ID number instead of his name.
Customer: "No, I haven't."
Clerk: "OK, can you give me your full last name, first name, and middle initial, please?"
Customer: "Sure. Simpson, Bertram H."

Clerk: To move to the name field and enter the customer's name, the clerk enters the following:

"OK, Mr. Simpson. And from what AVERTZ location would you like to pick up your vehicle?"

Customer: "I'm not sure. I'll be meeting a friend in Manchester, New Hampshire. Where is the closest AVERTZ location to Manchester?"

Clerk: "Let me get a list of the sites."

The clerk enters the following to display a list of sites:

AVERTZ displays the site selection panel shown in Figure 16–3.

Figure 16–3 Site Selection Panel

19-Apr-91	AVERTZ VEHICLE RENTALS			RESERVE
Select A Site From The List Below-use up/down arrows to navigate:				
ID	Site Name	City	Region	Country
1	AVERTZ AIRPORT RENTALS	MANCHESTER	NH	USA
2	AVERTZ NASHUA DEPOT	NASHUA	NH	USA
3	AVERTZ RIVER STREET	CONCORD	NH	USA
4	AVERTZ DOWNTOWN RENTALS	BOSTON	NH	USA
5	AVERTZ LOGAN AIRPORT	BOSTON	NH	USA

VM-0377A-AI

Clerk: "Sir, we have three sites in New Hampshire: one at the Manchester Airport, one at the Nashua Depot, and one in Concord. Is the Manchester Airport location OK with you?"

Customer: "Great, that's perfect!"

Clerk: The clerk enters the following:

Because the site selected is the first site on the list, the clerk does not need to move the cursor. If, however, the clerk did need to move the cursor, he could press the up-arrow key or the down-arrow key to select different sites.

"OK. What day would you like to start your rental?"

Customer: "I need the car for the weekend, beginning later today."

Clerk: "OK, you want to pick up the car today, and return it on April 22. Correct?"

User's View

16.2 Customer Reserves a Car

Customer: "Right."

Clerk: The clerk enters the following:

19-APR-1991 22-APR-1991

"And would you like a compact, mid-size, or full-size car, Mr. Simpson?"

The clerk enters the following to display the car type codes:

Help

AVERTZ displays a message listing the car types available. The following table lists the valid car type codes for this field:

Code	Car Type
1	Compact
2	Mid-Size
3	Full-Size

Customer: "There will just be two people using the vehicle, so compact should be fine."

Clerk: The clerk enters the following:

1 Return

Because Mr. Simpson is a new customer, AVERTZ displays the new customer panel shown in Figure 16-4.

Figure 16-4 New Customer Panel

19-Apr-91		AVERTZ VEHICLE RENTALS		RESERVE
			Daily Rate:	10.00
			Weekly Rate:	50.88
			Monthly Rate:	160.45
Site ID:	1	Name: AVERTZ AIRPORT RENTALS		
Address: TERMINAL BUILDING 1				
MANCHESTER AIRPORT				
MANCHESTER		NH	USA	
Customer ID:	0			
Last Name:	SIMPSON	First Name:	BERTRAM	Initial: H
Address Line 1:		Line 2:		
City:		State/Region:		
Country:		Postal Code:		
Phone:				
Credit Type:		Credit Card Number:		
Driver License:		Lic. State/Region:		
		Lic. Country:		
Enter new customer information				

VM-0378A-AI

Clerk: If Mr. Simpson were an existing customer, the new customer panel would display information for each field, based on the data in Mr. Simpson's database record.

User's View 16.2 Customer Reserves a Car

"OK, Mr. Simpson. Because you are a new customer, we would like to collect a few more pieces of information about where you live and how you will pay for the vehicle. First, what is your address?"

Customer: "901 Maple Drive, Apartment 12, Nashua, New Hampshire."

Clerk: Based on the address the customer provided, the clerk completes the panel up to the Postal Code field by entering the following:

901 Maple Drive Apt. 12 Nashua NH USA

"And what is your zip code, sir?"

Customer: "03060."

Clerk: The clerk enters the following:

03060

"And your phone number?"

Customer: "603-555-9966."

Clerk: The clerk enters the following:

603-555-9966

"Will you be paying with cash or charge?"

The clerk enters the following to display the credit type codes:

AVERTZ displays a message listing the credit types available. The following table lists the valid credit type codes for this field:

Code	Credit Type
0	Cash
1	Globetrotter
2	Viceroy
3	PlasticMoney
4	Gourmet Gold

Customer: "Cash."

Clerk: Because 0 is the code for cash, the clerk enters the following:

0

"Your driver's license number, please?"

Customer: "555-33-0000."

Clerk: The clerk enters the following:

555-33-0000

"And that license is for the state of New Hampshire?"

User's View

16.2 Customer Reserves a Car

Customer: "Actually, no. I just moved to New Hampshire a short while ago. It is a Massachusetts license."

Clerk: The clerk enters the following:

MA USA

AVERTZ processes the reservation. Since the reservation is being made on the same day as the requested checkout, AVERTZ prompts to see if the clerk wants to check out the car now (see Figure 16-5) .

Figure 16-5 Reservation Completed Panel

19-Apr-91		AVERTZ VEHICLE RENTALS		RESERVE
Reservation Number:	2	Daily Rate:	10.00	
Vehicle No:		Weekly Rate:	50.88	
Plate No:		Monthly Rate:	160.45	
State/Region:	NH			
Year/Model:	-	Type:	1	RENTALS
Address: TERMINAL BUILDING 1 MANCHESTER AIRPORT MANCHESTER NH USA				
Customer ID:	7	First Name:	BERTRAM	Initial: H
Last Name:	SIMPSON	Line 2:	APT 12	
Address Line 1:	901 MAPLE DRIVE	State/Region:	NH	
City:	NASHUA	Postal Code:	03060	
Country:	USA			
Phone:	603-555-9966	Credit Card Number:		
Credit Type:	Cash	Lic. State/Region:	MA	<input type="button" value="Y"/>
Driver License:	555-33-0000	Lic. Country:	USA	<input type="button" value="N"/>
Reservation completed - Do you wish to check the car out now?				

VM-0379A-AI

Clerk: "Mr. Simpson, your reservation for a compact car rental from April 19, 1991, to April 22, 1991, is confirmed, with a reservation confirmation number of 2. Please stop by our Manchester office later today to check out the car. Thank you for calling AVERTZ! Bye . . . "

Because Mr. Simpson phoned in his reservation, the clerk knows that he is not ready to check out the car. The clerk enters the following:

AVERTZ returns to the AVERTZ Rental Menu.

16.3 Customer Checks Out a Car (Beginning the Rental)

16.3 Customer Checks Out a Car (Beginning the Rental)

Bertram Simpson now has a reservation for a compact vehicle rental from April 19, 1991, until April 22, 1991. He shows up at the reservations counter at AVERTZ later in the day on April 19, after having made his reservation earlier that day. The following dialog takes place while Bertram Simpson checks out the car to begin the rental period:

Clerk: "Hi, can I help you?"

Customer: "Yes, my name is Bertram Simpson and I have a reservation for a compact car for today."

Clerk: "OK, Mr. Simpson, let me call up your reservation."
The clerk enters the following at the AVERTZ Rental Menu (Figure 16-1 shows the AVERTZ Rental Menu):

Selection: 2

AVERTZ displays the checkout panel shown in Figure 16-6.

Figure 16-6 Checkout Panel

19-Apr-91	AVERTZ VEHICLE RENTALS	CHECKOUT
Enter one of the following identification #s:		
Reservation #:	<input type="text" value="0"/>	
Customer #:	<input type="text" value="0"/>	
RETURN to continue, PF1 Q to quit, TAB to go forward, B5 or F12 to move back HELP for help filling in the field, HELP HELP for general help PF1 C to cancel reservation (valid for CHECKOUT task only) PF1 M to clear message line		

VM-0380A-AI

Clerk: "OK, Mr. Simpson, could I have your reservation number?"

Customer: "Sure, I have reservation number 2."

Clerk: "Thank you."
The clerk enters the following:

2

AVERTZ displays the checkout update panel shown in Figure 16-7, with the cursor positioned at the Credit Type field.

User's View

16.3 Customer Checks Out a Car (Beginning the Rental)

Figure 16–7 Checkout Update Panel

19-Apr-91		AVERTZ VEHICLE RENTALS		CHECKOUT		
Reservation Number:	2					
Vehicle Number:						
Plate No:						
State/Region:	NH					
Year/Model:	-		Type:	1		
Chkout Date:	19-Apr-1991	Mileage out:	0	Adjustment:	0.00	
Return Date:	22-Apr-1991	Mileage in:		Total Rental:	0.00	
Customer ID:	7					
Last Name:	SIMPSON		First Name:	BERTRAM	Initial:	H
Address Line 1:	901 MAPLE DRIVE		Line 2:	APT 12		
City:	NASHUA		State/Region:	NH		
Country:	USA		Postal Code:	03060		
Phone:	603-555-9966					
Credit Type:	0		Credit Card Number:			
Driver Licenses:	555-33-0000		Lic. State/Region:	MA		
			Lic. Country:	USA		
Update customer information						

VM-0381A-AI

Clerk: "Are you still planning on paying with cash, Mr. Simpson?"

Customer: "Yes, I am."

Clerk: "Great."

The clerk enters the following:

AVERTZ displays a list of available vehicles, as shown in Figure 16–8.

Figure 16–8 Car Selection Panel

19-Apr-91		AVERTZ VEHICLE RENTALS		CHECKOUT	
Select a vehicle from the list (max 5 listed) below-use up/down arrows to navigate:					
Class	Manuf	Yr	Clr	Site	Options
1	Ford	89	01	1	00
2	Chevrol.	89	02	1	02
3	Mercury	89	06	1	02
Vehicle(s) found in class requested, choose one					

VM-0382A-AI

16.3 Customer Checks Out a Car (Beginning the Rental)

Clerk: "Do you have any options that you want with your vehicle?"
 The clerk uses the following table to determine what each option code means:

Code	Option
00	Standard transmission
01	Cruise control
02	Tape deck
03	Sunroof
04	4-wheel drive
05	Roof rack
06	Bulletproof glass and body

Customer: "Well, I have a bit of a drive into the mountains, so if you have a car with a tape deck, that would be great."

Clerk: The clerk presses the down-arrow key and the Select key to select the first available vehicle with option 2.
 AVERTZ now displays the checkout completion panel, as shown in Figure 16–9.

Figure 16–9 Checkout Completion Panel

19-Apr-91		AVERTZ VEHICLE RENTALS		CHECKOUT	
Reservation Number:	2	Daily Rate:	0.00	Weekly Rate:	0.00
Vehicle Number:	4	Monthly Rate:	0.00		
Plate No:	899BHV				
State/Region:	NH				
Year/Model:	89-Chevrol. Type:				
Chkout Date:	19-Apr-1991	Mileage out:	0	Adjustment:	0.00
Return Date:	22-Apr-1991	Mileage in:		Total Rental:	0.00
Customer ID:	7				
Last Name:	SIMPSON	First Name:	BERTRAM	Initial:	H
Address Line 1:	901 MAPLE DRIVE	Line 2:	APT 12		
City:	NASHUA	State/Region:	NH		
Country:	USA	Postal Code:	03060		
Phone:	603-555-9966				
Credit Type:	Cash	Credit Card Number:			
Driver Licenses:	555-33-0000	Lic. State/Region:	MA		
		Lic. Country:	USA		

Enter<DO> to continue, or <PF1 C> to cancel reservation or <PF1 Q> to quit.

VM-0383A-AI

Clerk: The clerk enters the following to complete the checkout:

Do

AVERTZ displays a message indicating that the checkout is completed, and then prompts the clerk to press **Return** to continue.

"OK, Mr. Simpson, you're all set. Here are the keys to a Chevrolet, NH license plate 899BHV. The vehicle does have a tape deck, and is located in the parking area just to the left of our front door. When you return the car, please record the odometer reading before you check the car back in. Do you have any questions?"

User's View

16.3 Customer Checks Out a Car (Beginning the Rental)

Customer: "No, that's great. Thank you very much."

Clerk: "You're welcome. Have a good weekend and see you on Monday."

The clerk enters the following to return to the AVERTZ Rental Menu:

AVERTZ returns to the AVERTZ Rental Menu.

16.4 Customer Checks In a Car (Ending the Rental)

Bertram Simpson had a great weekend and is now ready to return the car to AVERTZ. He shows up at the reservations counter at AVERTZ on April 22. The following dialog takes place while Bertram Simpson checks in the car to end the rental period:

Clerk: "Hi, can I help you?"

Customer: "Yes, my name is Bertram Simpson and I'm returning a car that I rented over the weekend."

Clerk: "OK, Mr. Simpson. Let me call up your reservation."

The clerk enters the following at the AVERTZ Rental Menu (Figure 16–1 shows the AVERTZ Rental Menu):

Selection: 3

AVERTZ displays the checkin panel shown in Figure 16–10.

Figure 16–10 Checkin Panel

19-Apr-91 AVERTZ VEHICLE RENTALS CHECKIN

Enter one of the following identification #s:

Reservation #:

Customer #:

RETURN to continue, PF1 Q to quit, TAB to go forward, B5 or F12 to move back
HELP for help filling in the field, HELP HELP for general help
PF1 C to cancel reservation (valid for CHECKOUT task only)
PF1 M to clear message line

VM-0384A-AI

16.4 Customer Checks In a Car (Ending the Rental)

Clerk: "OK, Mr. Simpson. Could I have your reservation number?"

Customer: "Sure, I have reservation number 2."

Clerk: "Thank you."

The clerk enters the following:

2

AVERTZ displays the checkin update panel shown in Figure 16–11, with the cursor positioned at the Credit Type field.

Figure 16–11 Checkin Update Panel

19-Apr-91		AVERTZ VEHICLE RENTALS		CHECKIN	
Reservation Number:	2	Daily Rate:	10.00	Weekly Rate:	50.88
Vehicle No:	4	Monthly Rate:	160.45		
Plate No:	899BHV				
State/Region:	NH				
Year/Model:	89-Chevol. Type:				
Chkout Date:	19-Apr-1991	Mileage out:	0	Adjustment:	0.00
Return Date:	22-Apr-1991	Mileage in:		Total Rental:	0.00
Customer ID:	7				
Last Name:	SIMPSON	First Name:	BERTRAM	Initial:	H
Address Line 1:	901 MAPLE DRIVE	Line 2:	APT 12		
City:	NASHUA	State/Region:	NH		
Country:	USA	Postal Code:	03060		
Phone:	603-555-9966				
Credit Type:	Cash	Credit Card Number:			
Driver License:	555-33-0000	Lic. State/Region:	MA		
		Lic. Country:	USA		

VM-0385A-AI

Clerk: "Are you still planning to pay with cash, Mr. Simpson?"

Customer: "Yes, I am."

Clerk: "OK."

The clerk enters the following:

AVERTZ moves the cursor to the Return Date field. Because that field displays the current date (22-Apr-1991), the clerk enters the following to move to the Mileage In field:

"Can you tell me what the return odometer reading was, Mr. Simpson?"

Customer: "Yes, it was 357."

User's View

16.4 Customer Checks In a Car (Ending the Rental)

Clerk: The clerk enters the following:

357

The Adjustment field allows for adjustments to the bill due to special circumstances (such as charges when customers return cars without the gas tank filled). Entering a negative amount increases the bill; a positive amount decreases the bill. There are no special circumstances associated with this rental, so the clerk enters the following to process the checkin:

AVERTZ flashes the total cost of the rental.

"Mr. Simpson, the total cost is \$30 dollars."

Customer: "Here's the \$30 and the keys. Thanks."

Clerk: "You're welcome. And thank you for renting with AVERTZ!"

The clerk enters the following to return to the AVERTZ Rental Menu:

AVERTZ returns to the AVERTZ Rental Menu.

Behind the Scenes

You have seen the AVERTZ application from the system manager's and user's points of view. This chapter takes a brief look at some of the work involved in designing and developing an ACMS application from the system designer's and application developer's views. The design and development details of AVERTZ are discussed extensively throughout the ACMS documentation set.

Before designing a transaction processing application, you must begin by analyzing the business problem. For AVERTZ, the business problem is how data entry personnel can quickly and efficiently create, access, and update car rental information.

Each business problem has separate business areas that must be addressed. For AVERTZ, business areas might include reservation processing, site management, car information, and customer accounts. The AVERTZ sample application focuses on the business area of reservation processing.

In turn, each business area consists of business functions that support the business area. There are three different business functions that support the reservation processing business area:

- Reserve a car
- Check out a car
- Check in a car

Once the business problem has been categorized into areas and then into functions, you can begin solving the business problem with ACMS.

17.1 Applications and Procedures

An ACMS application consists of a set of tasks that relate to the functions of a business and can be selected for processing by either a terminal user or another task. Figure 17–1 shows the basic structure of an ACMS application.

Behind the Scenes

17.1 Applications and Procedures

Figure 17–1 Structure of an ACMS Application

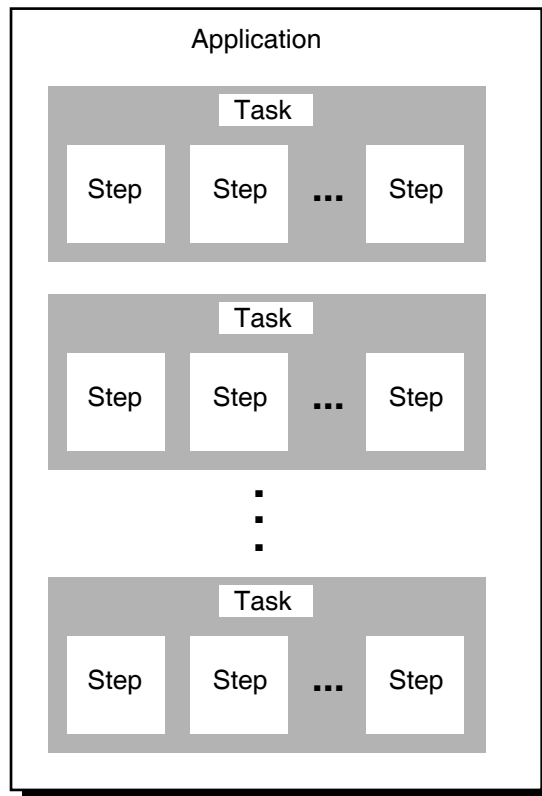

TAY-0172-AD

The AVERTZ application is made up of three menu choices: RESERVE, CHECKOUT, and CHECKIN. Each of these menu choices selects a corresponding task. The AVERTZ application also contains two tasks that are called by tasks not visible to the clerk:

- A task that checks reservation and customer information for both the CHECKOUT and CHECKIN tasks
- A task that completes or cancels a reservation for both the RESERVE and CHECKOUT tasks

The ability of tasks to call other tasks means that it is easy for you to design applications to share common code.

Just as each application is made up of one or more tasks, each task is made up of one or more steps that coordinate the work for that task. There are three types of steps within ACMS:

- **Exchange steps** coordinate I/O with a presentation service (such as a form).
- **Processing steps** coordinate I/O with a procedure (a user-written subroutine that handles database input, output, and computations).
- **Block steps** group exchange and processing steps into logical groups.

A considerable amount of control must take place to manage an application like AVERTZ. ACMS is designed to make such complex coordination and control easy to manage. Figure 17–2 illustrates how ACMS tasks coordinate the flow between forms that collect input from users and databases that store information.

Figure 17–2 Example of Execution Flow for an ACMS Task Definition

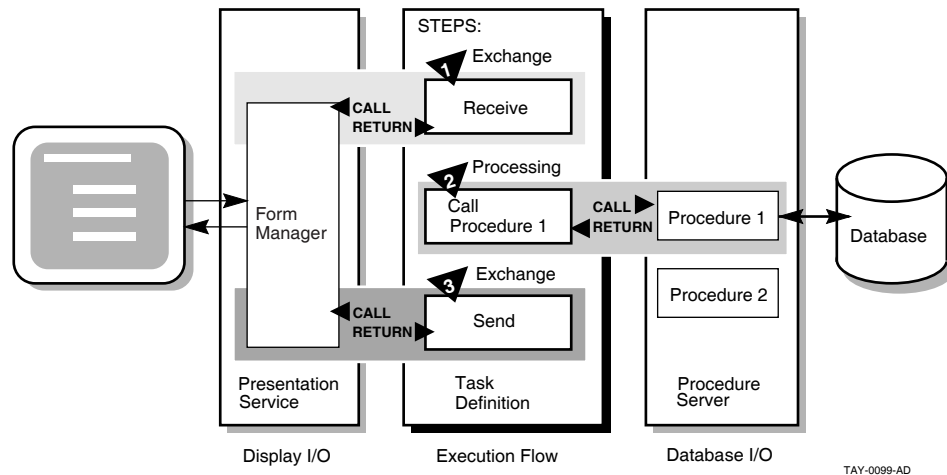

ACMS tasks are written using the ACMS Task Definition Language (TDL), which is based on a call and return model. Task definition steps perform calls to the presentation service in exchange steps, and to step procedures in processing steps. The presentation service and procedures perform their work and then return control to the task definition. Upon return to the task definition, subsequent parts of a step can evaluate the results of the call and, if necessary, handle any error conditions.

17.2 Task Definition Language

Example 17–1 shows portions of the code that are part of the reservation task in AVERTZ. Table 17–1 includes a description of each portion of code, based on the callout numbers in the example.

Behind the Scenes

17.2 Task Definition Language

Example 17–1 Code from the Reservation Task Definition

```

REPLACE TASK avertz_cdd_task:vr_reserve_task                                1
USE WORKSPACES  vr_control_wksp,                                         2
                vr_customers_shadow_wksp,
                vr_customers_wksp,
                vr_rental_classes_wksp,
.
.
.
DEFAULT FORM IS vr_form;                                               3
.
.
get_car_now:                                                            4
BLOCK WITH TRANSACTION                                                5
.
.
.
    PROCESSING                                                            6
        CALL PROCEDURE  vr_store_cu_proc
        IN              vr_cu_update_server
        USING           vr_control_wksp,
                    vr_customers_wksp,
                    vr_trans_wksp;

    ACTION IS                                                            7
        IF (ACMS$T_STATUS_TYPE = "B") THEN
            GET MESSAGE INTO vr_control_wksp.messagepanel;
            RAISE EXCEPTION vr_update_error;
        END IF ;

!+
! If want to check car out now (=GTCAR) then call
! vr_complete_checkout_task to do that.
!-
    PROCESSING                                                            8
        CALL TASK        vr_complete_checkout_task
        USING            vr_sendctrl_wksp,
                    vr_control_wksp,
                    vr_reservations_wksp,
                    vr_trans_wksp,
                    vr_vehicles_wksp;

END BLOCK;                                                                9

    ACTION IS                                                            10
        MOVE "          " TO vr_control_wksp.ctrl_key,
        "ACTWT" TO vr_sendctrl_wksp.sendctrl_key;
        COMMIT TRANSACTION;
        GOTO STEP disp_stat;

!+
! If the vr_store_cu_proc has an error because of constraint violation
! goto fix customer info exchange. If the transaction failed Retry the
! distributed transaction 5 times before canceling task. The retry_count
! is incremented in vr_store_cu_proc.
!-
    EXCEPTION HANDLER                                                    11

```

(continued on next page)

Example 17–1 (Cont.) Code from the Reservation Task Definition

```

SELECT FIRST TRUE OF
  ( ACMS$L_STATUS = vr_update_error ):
  MOVE "TRAGN" TO vr_sendctrl_wksp.sendctrl_key;
  GOTO STEP fix_cust_info;
  ( (ACMS$L_STATUS = ACMS$TRANSTIMEDOUT AND
    vr_control_wksp.retry_count < 5) ):
  REPEAT STEP;
NOMATCH:
  GET MESSAGE INTO vr_control_wksp.messagepanel;
  MOVE "ACTWT" TO vr_sendctrl_wksp.sendctrl_key,
    "      " TO vr_control_wksp.ctrl_key;
  GOTO STEP disp_stat;
END SELECT;
.
.
.
END DEFINITION;

```

Table 17–1 Description of Code Excerpt

Callout	Description
1	The REPLACE command is the first command in a task definition. It replaces an old dictionary definition with the current task definition or creates a new definition if one does not already exist.
2	The USE WORKSPACES clause names one or more workspaces to which the task needs access. Workspaces are buffers used to pass data between steps in a task, between a task and a procedure, between a task and a form, and between tasks. As you see in 6, some of the workspaces are used to pass information to a step procedure.
3	The DEFAULT FORM clause names the HP DECforms form used by the exchange steps within the task.
4	The get_car_now: label is used to identify the section of code that begins with the BLOCK clause. Labels allow for the transfer of control to different parts of the task.
5	The BLOCK clause groups multiple steps as a logical unit. TRANSACTION is a block phrase that marks the start of a distributed transaction (a distributed transaction makes more than one database update as a single "all or nothing" transaction). This example of the BLOCK clause consists of multiple processing steps (6 8). The processing steps include ACTION (7 10), and EXCEPTION HANDLER (11) clauses, which are part of the processing steps.
6	The PROCESSING clause identifies work that is part of a processing step. In this example, the PROCESSING clause calls the COBOL procedure named VR_STORE_CU_PROC, which resides in a server named VR_CU_UPDATE_SERVER. Procedures perform all computation and database work. (The VR_STORE_CU_PROC procedure stores a customer record in the database, for example). Note that the USING keyword identifies workspaces that are passed to the procedure as parameters.

(continued on next page)

Behind the Scenes

17.2 Task Definition Language

Table 17–1 (Cont.) Description of Code Excerpt

Callout	Description
7	The ACTION clause defines actions you want ACMS to take at the end of an exchange step, processing step, or block step. In this example, the ACTION clause tests the return status from the procedure. If the procedure fails for some reason (STATUS_TYPE=B), the ACTION clause uses the RAISE EXCEPTION clause to send control to the exception handler (11).
8	This PROCESSING clause calls another task, VR_COMPLETE_CHECKOUT_TASK, to check out the vehicle. Note that again workspaces are identified as parameters.
9	This END BLOCK clause ends the entire block step, which consists of the two processing steps, the action parts, and the exception handler part.
10	This ACTION clause performs some workspace work and then commits the transaction. The COMMIT clause signals the end of the current distributed transaction and makes permanent any changes made since the start of the distributed transaction.
11	By default, if ACMS encounters an error that prevents it from executing a task, ACMS cancels the task. The EXCEPTION HANDLER clause lets you handle the error and continue task execution. In this example, if the exception was a transaction timeout, it retries the transaction five times before cancelling the task. If the exception was an update error, control goes to a step labelled fix_cust_info, which allows the user to correct the data.

17.3 More AVERTZ . . .

The AVERTZ sample application demonstrates an ACMS transaction processing application from many perspectives. As you learn more about ACMS, you can modify the AVERTZ application to test what you have learned. Furthermore, you can use the design model for AVERTZ as a starting point for how to approach designing your own ACMS application.

For more detailed information on the design and coding aspects of AVERTZ, consult the following ACMS documentation:

- *HP ACMS for OpenVMS Concepts and Design Guidelines*
Explains ACMS concepts and provides guidelines for designing an ACMS application.
- *HP ACMS for OpenVMS Writing Applications*
Explains how to use the ACMS Application Definition Utility (ADU) to define tasks, task groups, applications, and menus.
- *HP ACMS for OpenVMS Writing Server Procedures*
Explains how to write, debug, and run procedures for ACMS applications.
- *HP ACMS for OpenVMS Systems Interface Programming*
Describes how to write ACMS code that allows nonterminal devices (such as bar-code readers and Automatic Teller Machines) to be integrated into an ACMS system.

All these documents make extensive use of AVERTZ code examples to illustrate ACMS concepts and features.

A

Utilities for Solving Problems in an ACMS Application

This appendix describes how ACMS runs a task and introduces some utilities that are available to help you solve problems in running a new ACMS application.

A.1 How ACMS Runs a Task

It is often helpful, especially in problem-solving, to know the various steps that ACMS takes to run a task. Figure A-1 illustrates how ACMS responds to the ACMS/ENTER command:

1. Checks ACMSDDF.DAT, the terminal authorization file, to verify that your terminal is authorized for use with ACMS.
2. Checks ACMSUDF.DAT, the user authorization file, to verify that you have been authorized to use ACMS, and to determine which menu database (.MDB) file has been assigned as your default.
3. Displays your default selection menu (if you and your terminal passed the authorization checks) and waits for you to select a task.
4. Consults the .MDB file to find out which application database (.ADB) file contains the task you selected.
5. Consults the .ADB file to find out which task group database (.TDB) file contains the task.
6. Finds the task in the .TDB file and runs it. The .TDB file also contains the file specification of the procedure server image and the entry points of the procedures in the image, as well as workspace definitions.
7. Returns to step 3 when the task has finished executing.

Utilities for Solving Problems in an ACMS Application

A.1 How ACMS Runs a Task

Figure A-1 Databases in an ACMS Application

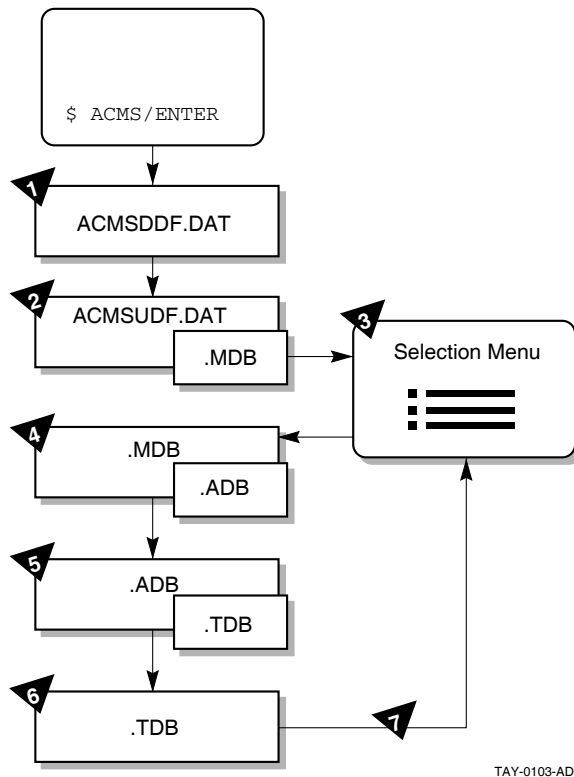

A.2 Audit Trail Logger

The Audit Trail Logger (ATL) keeps a record of when the ACMS system starts and stops, when users log in, when applications and tasks start and stop, errors signaled by processing steps, and so forth. To display this log, run the Audit Trail Report (ATR) Utility from the SYS\$SYSTEM directory.

Issue either of the following commands to run ATR:

```
$ RUN SYS$SYSTEM:ACMSATR
ATR>
```

or:

```
$ MCR ACMSATR
ATR>
```

At the ATR> prompt, issue the LIST command with the /SINCE qualifier to see today's log of your application:

```
ATR> LIST/APPLICATION=EMPLOYEE_INFO_APPL_XXX/SINCE=TODAY
```

For detailed information about the Audit Trail Logger and the ATR Utility, refer to *HP ACMS for OpenVMS Managing Applications*.

A.3 Software Event Logger

The Software Event Logger (SWL) records all software errors and event messages that occur during the execution of ACMS application programs. Each time an error occurs, ACMS writes a message to the SWL log file with information such as user name, process name, condition code, and extended error descriptions.

The Software Event Log Utility Program (SWLUP) generates reports containing information recorded by the SWL. To read information in the SWL log file, you use SWLUP commands.

Issue either of the following commands to run SWLUP:

```
$ RUN SYS$SYSTEM:SWLUP
SWLUP>
```

or:

```
$ MCR SWLUP
SWLUP>
```

At the SWLUP> prompt, issue the LIST command with the /SINCE qualifier to display today's log of events for user JONES:

```
SWLUP> LIST/USER=JONES/SINCE=TODAY
```

To write the log of all events for user JONES to an output file instead of to the terminal, issue the LIST command as follows:

```
SWLUP> LIST/USER=JONES/OUTPUT=MY_EVENTS.LIS
```

For detailed information about the Software Event Log and the SWLUP Utility, refer to *HP ACMS for OpenVMS Managing Applications*.

A.4 HP DECforms Trace Facility

The HP DECforms trace facility logs form-processing information at run time to help you debug your application program and your form. The trace facility is useful because much of the form processing occurs each time you call a HP DECforms request from your ACMS application program.

You can turn tracing on before running a task in the ACMS Task Debugger (see Section 9.4). In this way, you can debug logic problems, debug data mismatches and other run-time errors, and observe how a user works through a series of panels.

You turn tracing on by defining the logical FORMS\$TRACE as a character string value that begins with any of the following characters: T, t, Y, y, or 1. For example:

```
$ DEFINE FORMS$TRACE YES
```

Turning on the trace facility produces a trace file with the same name as your form followed by the TRACE extension (by default), for example, EMPLOYEE_INFO_FORM.TRACE. For a name other than the default, define the logical FORMS\$TRACE_FILE to your own trace file specification.

The trace facility is turned off when you define the FORMS\$TRACE logical as a character string value that begins with any character except those that turn tracing on. Tracing also ends when you log out (the process logical FORMS\$TRACE becomes undefined then). It is advisable to turn off the trace facility when you are finished testing to avoid having your trace file become exceedingly large.

Utilities for Solving Problems in an ACMS Application

A.4 HP DECforms Trace Facility

For detailed information about the HP DECforms trace facility, refer to *DECforms Programmer's Reference Manual*.

A.5 ACMS Help Facility

The ACMS Help facility contains a menu of ACMS error codes, from which you can choose to view information about a specific ACMS error. For help with ACMS error messages, issue the following command:

```
$ HELP ACMS ERRORS
```

The ACMS Help facility also contains information about many other ACMS topics. For a Help menu of ACMS topics, issue the following command:

```
$ HELP ACMS
```

Source Files Used in the Tutorial

This appendix lists the source files created in the tutorial application in Part II and describes how to access the online versions of these files. You can view the online source files to verify those that you create in the tutorial, or you can copy the online source files instead of typing them yourself.

B.1 Source Files

The following list contains the names of each source file created in the tutorial. The files are listed in the order that they appear in the manual.

- EMPLOYEE_FIELDS.CDO
- EMPLOYEE_INFO_RECORD.CDO
- EMPLOYEE_INFO_WKSP.CDO
- EMPLOYEE_INFO_FORM.IFDL
- EMPLOYEE_CONTROL_FIELDS.CDO
- EMPLOYEE_CONTROL_WKSP.CDO
- EMPLOYEE_QUIT_FIELD.CDO
- EMPLOYEE_QUIT_WKSP.CDO
- EMPLOYEE_INFO_ADD_TASK.TDF
- EMPLOYEE_INFO_ADD.COB
- EMPLOYEE_INFO_PROMPT_FORM.IFDL
- EMPLOYEE_INFO_UPDATE_TASK.TDF
- EMPLOYEE_INFO_UPDATE_GET.COB
- EMPLOYEE_INFO_UPDATE_PUT.COB
- EMPLOYEE_INFO_INIT.COB
- EMPLOYEE_INFO_TERM.COB
- EMPLOYEE_INFO_CANCEL.COB
- EMPLOYEE_INFO_TASK_GROUP.GDF
- EMPLOYEE_INFO_APPL_XXX.ADF
- EMPLOYEE_INFO_MENU.MDF

Source Files Used in the Tutorial

B.2 Accessing the Source Files

B.2 Accessing the Source Files

The source files are installed by the ACMS installation procedure if your system manager chooses to install the ACMS samples. These files are located in `ACMS$EXAMPLES`, a logical that points to the actual directory. The following command displays the contents of that directory:

```
$ DIRECTORY ACMS$EXAMPLES
```

The following command displays the file named `EMPLOYEE_FIELDS.CDO`:

```
$ TYPE ACMS$EXAMPLES:EMPLOYEE_FIELDS.CDO
```

You may wish to copy these files to your default directory instead of typing them yourself. Copying the source code files saves time in performing the tutorial, but you may gain more by typing them in progressive steps while reading about what the code does. Moreover, copying the two HP DECforms IFDL files means that your forms and panels are already created, nullifying the portion of the tutorial that illustrates how to create them interactively within the HP DECforms environment.

You can copy single files using the normal method. However, if you want to copy all the source files, you can perform a wildcard copy with one command. Use the following commands to locate yourself in your default directory (filling in your disk and user name) and to copy all the tutorial source files to this directory:

```
$ SET DEFAULT udisk:[uname]
$ COPY ACMS$EXAMPLES:EMPLOYEE*. * *.*
```

If you copy the online source files, rename the application definition file `EMPLOYEE_INFO_APPL_xxx.ADF`, filling in your initials or other unique characters for the `xxx` part of the name. Using a unique application name avoids conflicts with applications created by others who may be entering this tutorial on your system. When you rename this file, you must also edit this file to make the same name change in the first line of the file (see Section 10.1.1); you must also edit the file `EMPLOYEE_INFO_MENU.MDF` to make the same name change there (two occurrences).

If you copy the online source files, you must edit the files that contain the logical `xxx_FILES` and replace that logical with the one that you defined for your directory in Section 7.6. Those files that contain the `xxx_FILES` logical are the six `.COB` files (one occurrence each), `EMPLOYEE_INFO_TASK_GROUP.GDF` (three occurrences), and `EMPLOYEE_INFO_APPL_XXX.ADF` (one occurrence).

Glossary

This glossary contains terms from all books in the ACMS documentation set.

AAU

See Application Authorization Utility.

ACC

See ACMS Central Controller.

access control list (ACL)

A table that lists the users allowed access to an object and indicates the kind of access they are allowed. For example, you can use ACLs on ACMS tasks to control user access to that task.

See also privilege.

ACID

An acronym for the four properties of legal database transactions and distributed transactions. The four properties are atomicity, consistency, isolation, and durability.

ACL

See access control list.

ACMS

ACMS software, a transaction processing monitor that is layered on the OpenVMS operating system, defines, runs, and controls transaction processing applications. You can use ACMS to control existing applications and applications developed with ACMS. It provides a task implementation method that uses high-level definitions to replace complex application code. These definitions reduce the programming time and maintenance costs of traditional application programs that do comparable work. ACMS supports offloaded terminal processing, which allows the execution of ACMS tasks on remote nodes.

See also distributed transaction processing *and* transaction processing.

ACMS Central Controller (ACC)

The ACMS process that serves as the central control point for the ACMS run-time system.

ACMSCFG

See ACMS Remote Manager Configuration Utility.

ACMSDBG

See ACMS Task Debugger.

ACMSGEN Utility

An ACMS utility that lets system managers change ACMS system parameters, such as the number of users who can log in, the user names under which ACMS processes run, and the priorities of these processes. This utility is similar to the OpenVMS SYSGEN Utility.

ACMSMGR

See ACMS Remote Manager.

ACMS operator

An ACMS user authorized to use the ACMS operator commands to control the daily operations of ACMS system software and applications.

ACMS operator command

One of a number of DCL commands provided by ACMS to control the operations of the ACMS system software and applications. Many ACMS operator commands require the OpenVMS OPER privilege.

ACMSQUEMGR

See Queue Manager Utility.

ACMS Remote Manager

An ACMS process that enables system managers to monitor and tune ACMS systems remotely. ACMSMGR is the DCL command-line interface to this process.

ACMS Remote Manager Configuration Utility (ACMSCFG)

A utility that enables system managers to configure the initial startup values for the Remote Manager process.

ACMS Task Debugger (ACMSDBG)

An ACMS debugging tool that allows you to move through a task to examine how a task branches from one task step to the next. The Task Debugger uses task group databases and procedure server images; it does not require application definitions, menu definitions, or a running ACMS system.

See also multiple-step task *and* procedure server.

action

See step action.

ADB

See application database.

ADU

See Application Definition Utility.

agent

An OpenVMS process through which one or more ACMS task submitters access the ACMS run-time system. All ACMS users access tasks through an agent. ACMS provides the Command Process (CP) as an agent for terminal users.

An ACMS request interface agent allows users to write and use terminal interfaces other than HP DECforms to access ACMS. An ACMS systems interface agent allows users to write and use nonterminal interfaces such as badge or barcode readers to access ACMS.

See also Command Process (CP).

agent program

A program that invokes a task that executes in an ACMS application.

ANSI (American National Standards Institute)

The American industry-wide standards committee responsible for proposing standards. ANSI proposes software standards for programming languages, databases, and other software products.

See also CODASYL and ISO.

application

In ACMS, a set of tasks that are related by the business activity they support and that are controlled as a single unit. An ACMS application is defined with the ACMS Application Definition Utility (ADU) and runs under the control of the ACMS run-time system. An application definition specifies operational characteristics for the tasks and servers of the task groups that make up the application.

application authorization file

A file, ACMSAAF.DAT, created by and maintained with the Application Authorization Utility (AAU). This file contains a list of applications authorized for installation, and definitions describing what characteristics are allowed for those applications and who is authorized to install them.

Application Authorization Utility (AAU)

An ACMS utility that allows a system manager to define which applications can be installed, what characteristics the applications can have, and who can install them.

application database (ADB)

In ACMS, a binary file accessed at run time that describes the operational characteristics of all tasks and servers in an application. You generate an application database by building an application definition with ADU. The ACMS run-time system uses application databases to determine which processes to start, when to start them, and which users have access to which tasks.

See also application definition.

application definition

In ACMS, the specification of the run-time characteristics for an ACMS application and its servers and tasks. You write an application definition using the ADU. After creating the definition, you use ADU to build the application database, which is the binary version of the definition file.

See also application database.

Application Definition Utility (ADU)

The primary tool for creating ACMS applications. The Application Definition Utility provides the commands and clauses for defining tasks, task groups, applications, and menus.

Application Execution Controller (EXC)

The ACMS component that controls task execution for all the tasks in an application. Each application has its own Application Execution Controller. Application Execution Controllers start up and control the server processes needed to handle processing work for tasks. They also handle exchange steps, step actions, and the sequencing of steps for tasks defined with ACMS. Application Execution Controllers reference application databases, task databases, form files, request libraries, and message files.

application node

The back end of a distributed transaction processing system, on which data manipulation and computation are handled. The application resides on the application node. Resource managers that perform data processing can also reside on the application node, or may reside on other remote nodes.

See also back end, front end, *and* submitter node.

application specification

A specification for an ACMS application that can consist of an application name, a logical name, a node name and file name, or a logical name and file name. Use application specifications in ADU clauses to identify applications on single-node or multiple-node ACMS systems.

See also Application Definition Utility (ADU).

atomicity

A characteristic of database transactions and distributed transactions. If an atomic transaction fails, any changes made to a database, file, or ACMS queue are rolled back to their original state.

See also database transaction, distributed transaction, *and* recovery unit.

Audit Trail Logger (ATL)

In ACMS, a monitoring tool that has a recording facility and a utility for generating reports. The recording facility gathers information about a running ACMS system, including information about system and application starts and stops, user sign-ins and sign-outs, processing errors, user task selections, task completions, and task cancellations. The report utility (ATR) generates summary reports of this information.

back end

The data and computational processes in a transaction processing system in which terminal and menu functions are handled by separate processes. The back-end processes include the EXC and server processes.

Front-end processes can be shifted to a separate computer, OpenVMS Cluster network, or Local Area OpenVMS Cluster network to increase system performance.

See also front end.

block conditional clause

One of four statements of a task definition language. You can use a block conditional clause in an ACMS task to make initial exchange and processing work dependent on the values of workspace fields.

block step

One of three kinds of steps used to define the work of a multiple-step task. A block step definition has three parts: attributes, work, and action.

See also exchange step *and* processing step.

called task

A task that is invoked, or called by, another ACMS task. The task that calls the called task is known as a parent task.

See also parent task.

cancel action

A procedure or image called by an ACMS task when the task is canceled. The cancel action does cleanup work for the task, such as recovering from incomplete operations. It does not release locks or perform other work specific to a server.

cancel procedure

A procedure called by ACMS to clean up any context held by a task in a server. The cancel procedure does cleanup work for the server process, such as releasing record locks, so that the process can be used again without being restarted. When a cancel procedure is called, it runs in the server process allocated to the task, whether or not the task is using the server process at the time of the cancellation.

CDD (Common Data Dictionary)

See CDD data dictionary system.

CDD data dictionary system

A data dictionary system consisting of a hierarchy of directories that contain definitions used by VAX and Alpha transaction processing products. The CDD dictionary contains descriptions of data, not the data itself. CDD objects are stored hierarchically and accessed by reference to dictionary path names.

centralized transaction processing

A TP system in which all TP components run on the same computer.

cluster

See OpenVMS Cluster network.

CODASYL (Conference on Data Systems Language)

The industry-wide standards committee responsible for proposing standard data definition and data manipulation languages for databases conforming to the network model. The CODASYL committee is also responsible for proposing the Form Interface Management System (FIMS) standard.

See also ANSI, Form Interface Management System, *and* ISO.

Command Process (CP)

The ACMS process that handles user logins and the interaction between terminals and ACMS.

See also agent.

commit

To make permanent changes to a resource during a database or distributed transaction.

composable task

A task written in such a way that it can be called to participate in a distributed transaction started by a parent task or an agent.

See also distributed transaction *and* parent task.

concurrency

The method of controlling conflicts and contention when simultaneous updates to a database occur.

conditional clause

One of four statements of the task definition language. You can use conditional clauses in an ACMS task to make exchange, processing, or action clauses dependent on the values of workspace fields.

consistency

A characteristic of a transaction. A transaction has consistency if it successfully modifies the system and the database from one valid state to another.

CP

See Command Process.

database management system

A system for creating, maintaining, and accessing a collection of interrelated data records that can be processed by one or more applications without regard to physical storage. Data is described independently of application programs, providing ease in application development, data security, and data visibility.

Note that the acronym DBMS is often used to mean database management system. Do not confuse this generic use of the term DBMS with references to the specific Oracle CODASYL DBMS software product. a CODASYL-compliant database management system.

database manager

See resource manager.

database transaction

A set of updates to recoverable resources, such as files and databases. Database transactions have the properties of atomicity, consistency, isolation, and durability.

See also atomicity, distributed transaction, recovery unit, *and* resource manager.

data resource

A collection of data items that represent business information.

DBMS

A CODASYL-compliant database management product. You can use DBMS to access and administer databases ranging in complexity from simple hierarchies to complex networks with multilevel relationships.

Note that the acronym DBMS is often used to mean database management system. Do not confuse this generic use of the term DBMS with references to the specific Oracle CODASYL DBMS software product.

See also database management system.

DCL

See DIGITAL Command Language.

DCL command procedure

A sequence of DIGITAL Command Language (DCL) commands stored in a file; sometimes referred to as a DCL procedure.

DCL server

One of two types of servers used to handle processing work for ACMS tasks. A DCL server handles images, DCL commands, and command procedures.

See also DCL server image, procedure server, *and* server image.

DCL server image

The image provided by ACMS that is loaded into a DCL server process when the process is started by the EXC. The DCL server image lets you use images, DCL commands, and procedures to implement processing for tasks.

See also Application Execution Controller (EXC) *and* procedure server image.

DCL server process

See server process.

DDU

See Device Definition Utility.

deadlock

A situation in which two or more processes request the same set of resources and there is no method for resolving the conflict, except to reject all but one of the processes. For example, if process A has record 1 locked and requests record 2, while process B has record 2 locked and is requesting record 1, a deadlock occurs between processes A and B.

HP DECdtm services for OpenVMS

A collection of OpenVMS services providing management of distributed transactions. HP DECdtm services implement a two-phase commit protocol. ACMS uses HP DECdtm services as its transaction manager.

See also distributed transaction *and* two-phase commit (2PC) protocol.

HP DECforms

A forms product running on the OpenVMS operating system that integrates text and graphics into forms and menus, and displays them on a terminal screen. HP DECforms also provides extensive facilities for specifying full control of the user interface from within the form rather than in the application program.

DECnet/VAX

The HP software facility that implements the DIGITAL Network Architecture (DNA) to let a user access information on a remote computer through telecommunications lines. DECnet/VAX enables an OpenVMS system to function as a network node.

See also DIGITAL Network Architecture (DNA).

default

The value of an argument, field, or part of a command line assumed by a program if the specific value is not supplied by the user.

default directory

The directory from which the OpenVMS system reads and to which it writes all files that you create unless you explicitly name a directory.

See also directory.

device definition file

A file, created and maintained with the ACMS Device Definition Utility (DDU), that contains a list of terminals from which users can access ACMS, and information specifying whether the terminals can access both ACMS and OpenVMS, or only ACMS.

Device Definition Utility (DDU)

The ACMS tool for defining which terminals have access to ACMS and what characteristics those terminals have.

dictionary object

A data definition stored in a CDD dictionary.

See also CDD data dictionary system.

DIGITAL Command Language (DCL)

A command interpreter for the OpenVMS system.

DIGITAL Network Architecture (DNA)

A description of network structure, operation control, and protocols (rules) developed by Digital Equipment Corporation.

directory

A file that catalogs a set of files stored on disk or tape. The directory includes the name, type, and version number of each file in the set.

See also default directory.

directory anchor

In CDD, the specification of the OpenVMS directory where the CDD hierarchy is stored. The anchor is followed by the dictionary path. The specification DISK1:[CDDPLUS] is an example of a directory anchor.

distributed application

An application that uses a network for remote access to a database or another application.

distributed transaction

The grouping of operations on files and databases into a single transaction. Distributed transactions have the properties of atomicity, consistency, isolation, and durability and can include more than one type of resource manager.

See also atomicity, database transaction, recovery unit, *and* resource manager.

distributed transaction processing

The processing of ACMS tasks on two separate nodes: a front end for offloading terminal or device I/O, and a back end for processing against the database. An ACMS user or task submitter signed in to an ACMS system on one node can select tasks in an application on an ACMS system on another node. ACMS uses DECnet to communicate transparently among nodes without rewriting applications or tasks, and can distribute processing between nodes in an OpenVMS Cluster network, a local area network, a wide area network, or any combination of the three.

See also ACMS, DECnet/VAX, transaction processing, *and* OpenVMS Cluster network.

durability

A characteristic of a transaction. A transaction has durability if all the changes that it makes to the database become permanent when the transaction is committed.

escape unit

In HP DECforms, a subroutine that you can call to perform actions outside the form, such as data validation or database lookup. HP DECforms escape units provide only a synchronous interface.

EXC

See Application Execution Controller.

exception

An event or an error condition that interrupts the normal flow of an executing task.

exception handler

An optional part of an exchange, processing, or block step that lets you control task execution when an exception is raised in the work or action part of the step.

exception handler action

The part of a step definition that tells ACMS what to do if an exception occurs during the step. These instructions can consist of a single unconditional action or a series of conditional actions based on one or more conditions, such as the value of a field in a workspace.

exchange step

One of three kinds of steps that define the work of an ACMS multiple-step task. An exchange step handles input and output between the task and the task submitter.

See also block step *and* processing step.

execution controller

See Application Execution Controller.

external request

A service in HP DECforms that can be called from outside a form. The ACMS interface to HP DECforms consists of six calls to corresponding external requests: ENABLE, DISABLE, CANCEL, SEND, RECEIVE, and TRANSCEIVE.

field definition

A CDD dictionary definition that describes the data that can be stored in a specific field of an application. Field definitions typically include information such as data type and size.

file name

The name you choose to identify a file. The file name can be from 1 to 39 characters in length, selected from the letters A through Z, the numbers 0 through 9, the underscore (_), and the dollar sign (\$).

file specification

A name that uniquely identifies a file. A full file specification identifies the node, device, directory name, file name, file type, and version number under which a file is stored.

file type

The part of a file specification that describes the nature or class of file. The file type follows the file name in a specification and is separated from the file name by a period. A file type can be from 1 to 39 characters. The OpenVMS operating system and software products developed by Hewlett-Packard Company recognize many default file types used for special purposes. For example, .ADB is the default file type for an ACMS application database.

FIMS

See Form Interface Management System.

form

In HP DECforms, a set of instructions that govern the user interface to an ACMS application. The form describes all the screen interactions with the data that is transferred between the form and the application.

form data items

Variables associated with a HP DECforms form.

Form Interface Management System

A system for interaction between applications and display devices proposed by the CODASYL Form Interface Management System Committee.

See also CODASYL *and* HP DECforms.

form manager

A run-time component of a presentation service that provides the interface between the terminal display and an ACMS application. The form manager controls the terminal display, user input, and transfer of data between the terminal and ACMS.

form record

A structure that controls how data is transferred between ACMS and a HP DECforms form.

front end

The processes controlling terminal and menu functions in a transaction processing system in which data manipulation and computation are handled by separate processes. The front-end processes include the CP and the Queued Task Initiator (QTI).

Front-end processes can be shifted to a separate computer, OpenVMS Cluster network, or Local Area OpenVMS Cluster network to increase system performance.

See also back end.

function key

In HP DECforms, a key that you can define to perform a specific function. You define function keys in the layout part of a HP DECforms IFDL source file.

For example, you might define the PF4 key for HP DECforms to instruct ACMS to cancel the current task when the terminal operator presses PF4.

function response

In HP DECforms, a statement in the IFDL source file that instructs the Form Manager how to process a form when the user presses a function key.

See also function key.

given name

The name assigned to a CDD dictionary directory, subdictionary, or object. A given name can be from 1 to 31 characters in length selected from the letters A through Z, the numbers 0 through 9, the underscore (_), and the dollar sign (\$). The first character must be a letter, and the last character cannot be an underscore or a dollar sign. If you are using a VT200- or VT300-series terminal, you can use 8-bit alphabetic characters.

To refer to a CDD object, specify a dictionary anchor and a path name. An anchor specifies the OpenVMS directory in which the CDD hierarchy is stored. The given name of a dictionary directory, subdirectory, or object is separated from the name of its parent by a period.

group workspace

A workspace that holds information needed by tasks in an ACMS task group. A group workspace is made available when a terminal user selects the first task in a group that uses that workspace. Once allocated, a group workspace remains available to all tasks in the group until the application stops.

See also task workspace *and* user workspace.

image

A file consisting of procedures and data that have been bound together by the linker. There are three types of OpenVMS images: executable, shareable, and system. When not otherwise stated, image refers to an executable image.

initialization procedure

In ACMS, a procedure that runs when a procedure server process starts and that opens files or readies a database for the server process.

interactive transaction

A transaction that contains one or more exchange steps within the bounds of the transaction.

ISO (International Standards Organization)

The international, industry-wide standards committee responsible for proposing standards. ISO proposes software standards for programming languages, databases, and other software products.

See also ANSI *and* CODASYL.

isolation

A characteristic of a transaction. A transaction has isolation if it behaves the same running serially or concurrently. If a transaction is processed concurrently with other transactions, it behaves as if it were the only transaction executing in the system.

journaling

The process of recording information about operations on a database or file onto a recoverable resource. The type of information recorded depends on the type of journal being created.

keyword

A word reserved for use in certain specified syntax formats, usually in a command or a statement.

Language-Sensitive Editor (LSE)

A multilanguage editor designed for software development. LSE assists you in developing definitions or programs with its text editor by providing templates. LSE support is available for ACMS, HP DECforms, other software products developed by Hewlett-Packard Development Company, and CDD DMU dictionaries.

linker

A program that creates an executable program, called an image, from one or more object modules produced by a language compiler or assembler. Programs must be linked before they can be executed.

literal

A value expression that represents a constant. A literal is either a character string enclosed in quotation marks or a number.

logical name

A specified name for any portion or all of a file specification. Logical name assignments are user-specified and are maintained in logical name tables for each OpenVMS process, each group, each job, and the OpenVMS system.

LSE

See Language-Sensitive Editor.

MDB

See menu database.

menu

A list of entries, from which a user selects one for processing. A menu entry can direct a user to a task or another menu.

In ACMS, you define the list of items on a menu and other menu characteristics using the ADU.

menu database (MDB)

In ACMS, a binary file containing information derived from menu definitions. ACMS uses the information in the menu database for displaying menus. ADU creates the menu database when it builds menu definitions. The menu database has the file type .MDB.

menu definition

In ACMS, the specification of the characteristics of an ACMS menu, including the list of items on the menu and the description of each item. You write a menu definition using ADU. After creating the definition, you use ADU to build the menu database, which is the binary version of the definition file.

message file

A file that contains a table of message symbols and their associated text.

multiple-step task

An ACMS task defined in terms of a block step. The task contains one or more exchange and processing steps.

See also block step, exchange step, processing step, *and* step action.

multithreaded process

A single process that handles many simultaneous users.

object module

The binary output of a language processor, such as an assembler or compiler. The linker accepts object modules as input.

See also linker.

OpenVMS Cluster network

A highly integrated organization of OpenVMS systems that communicate over a high-speed communications path. OpenVMS Cluster networks have all the functions of single-node OpenVMS systems, plus the ability to share CPU resources, queues, and disk storage. Like a single-node system, the OpenVMS Cluster organization provides a single security and management environment. Member nodes can share the same operating environment or serve specialized needs.

OpenVMS Debugger

An OpenVMS debugging tool for debugging procedures called by ACMS processing steps.

OpenVMS image

See image.

OpenVMS process

See process.

OpenVMS user

A person or account authorized by an OpenVMS system manager to access an OpenVMS system. The user is assigned a user name, a password, a UIC, a default OpenVMS directory, a default command language, quotas, limits, and privileges.

operator command

See ACMS operator command.

Oracle Trace

A programmer productivity tool used with ACMS to collect and create detailed reports on events that occur when an ACMS application runs.

nested block step

A block step contained within another block step.

See also block step.

nonrecoverable exception

An error from which the task cannot recover.

panel

A HP DECforms element consisting of the information and images that are displayed on the user's terminal screen. A panel is composed of such items as fixed background information (literals), fields, attributes, function key control, and customized help messages.

parent block step

A block step that contains one or more nested block steps.

See also block step *and* nested block step.

parent task

A task that includes a call to another task. A task can be both a parent task and a called task.

See also called task.

path name

A unique CDD designation that identifies:

- Dictionary directories
- Subdictionaries
- Object

The full path name combines the given names of directories and an object. Full path names begin with CDD\$TOP or the anchor, and end with the given name of the object or directory you want to specify (including the given names of the intermediate subdictionaries and directories). The names of the directories and objects are separated by periods. The specification DISK1:[CDDPLUS]APPLA.RECORDS.AFIELD is an example of a path name.

See also given name.

phase

In HP DECforms, one of several steps the Form Manager follows when it processes an external request.

presentation service

Forms management software such as HP DECforms, which handles the gathering of input from the user.

privilege

A characteristic assigned to a user or program that determines what operations that user or program can perform.

See also access control list (ACL).

procedure

A general purpose routine, entered by means of a call instruction, that uses an argument list passed by a calling program and uses only local variables for data storage. A procedure is entered from and returns control to the calling program.

See also DCL command procedure, initialization procedure, step procedure, termination procedure, *and* cancel procedure.

procedure object library

A collection of object modules for procedures.

See also linker *and* object module.

procedure server

In ACMS, a set of user-written procedures, the procedure server image created when the procedures are linked, and the procedure server process that ACMS creates to execute the procedure server image.

See also procedure server image *and* server process.

procedure server definition

In ACMS, the part of a task group definition that describes the server procedures and the server image included in a procedure server.

procedure server image

The image that is loaded into a server process when the process is started by the ACMS Application Execution Controller. The procedure server image is created when the procedures handled by the server are linked together with the procedure server transfer module for that server.

See also Application Execution Controller (EXC), DCL server image, *and* procedure server transfer module.

procedure server process

See server process.

procedure server transfer module

The object module created for a procedure server as a result of building an ACMS task group definition. When a task group is built, the ADU produces a procedure server transfer module for each procedure server defined in the task group. The procedure server transfer module is linked together with all the procedures handled by the server to produce the procedure server image.

process

The entity scheduled by the OpenVMS system software that provides the context in which an image runs. A process consists of an address space and both hardware and software context.

process context

See server context.

processing step

One of three kinds of steps that define the work of an ACMS task. The work of a processing step is handled by a server and can consist of computations, data modification, or file and database access.

See also block step *and* exchange step.

QTI

See Queued Task Initiator.

qualifier

A portion of a command string that modifies a command verb or command parameter. A qualifier follows the command verb or parameter to which it applies and has the following format:

/qualifier[=option]

queue

See task queue.

queued task

A task executed by the queuing facility. Queued tasks cannot perform exchange steps to collect input data, but they are otherwise the same as any other ACMS tasks.

queued task element

A data element in a task queue. A queued task element includes the task name, application name, and workspaces associated with a transaction. A queued task element is placed in a task queue by the ACMS\$QUEUE_TASK programming service and removed from the queue by the ACMS QTI.

See also Queued Task Initiator *and* queued task services.

Queued Task Initiator (QTI)

The component of the ACMS queuing facility that dequeues task elements from a task queue and initiates their execution in a specified application.

queued task services

The component of the ACMS queuing facility that provides the ACMS\$QUEUE_TASK and ACMS\$DEQUEUE_TASK programming services for queuing and dequeuing task elements and their data to and from task queues. You can call these services either from a procedure server in an ACMS task or from a user-written program.

See also procedure server.

Queue Manager Utility (ACMSQUEMGR)

The component of the ACMS queuing facility that you use to create and manage task queues.

queuing facility

The ACMS utility, programming services, and run-time process that allow you to design applications that can place transactions in a temporary storage area for deferred processing of data. The queuing facility includes the Queue Manager Utility (ACMSQUEMGR), ACMS\$QUEUE_TASK and ACMS\$DEQUEUE_TASK programming services, and QTI.

See also application, Queued Task Initiator, queued task services, Queue Manager Utility, *and* transaction.

Rdb

A relational database management system for creating, maintaining, and accessing a collection of interrelated data records that can be processed by one or more applications without regard to physical storage. Rdb is based on the relational database model as defined by the Digital Standard Relational Interface (DSRI).

See database management system.

record definition

A CDD dictionary definition that typically consists of a grouping of field definitions.

Record Management System (RMS)

A set of OpenVMS operating system procedures that programs can call to process files and records within files. RMS lets programs issue GET and PUT requests at the record level (record I/O), as well as read and write blocks (block I/O). RMS is an integral part of the OpenVMS system software and is used by high-level languages, such as COBOL and BASIC, to implement their input and output statements.

recovery

In Rdb, DBMS, and RMS resource managers, the process of restoring a database to a known condition after a system or program failure.

In ACMS, you can define recovery as a characteristic for a multiple-step task that uses Rdb, DBMS, or RMS.

See also journaling *and* transaction.

recovery unit

A series of operations that exchange information with a database or file and are treated as a group; either all of them are completed at once, or none of them is completed. A recovery unit is equivalent to a transaction.

Relational Database Management System (Rdb)

See Rdb.

remote server

The part of ACMS, DBMS, Rdb, and VIDA that lets you access data on other computers on your DECnet network.

request

In ACMS, a set of instructions used by ACMS tasks to display TDMS forms on a terminal and gather information from a terminal user.

Request Interface (RI)

A method that allows you to use interfaces other than HP DECforms or TDMS for I/O functions that do not require more than one user per process. ACMS provides the means, with the Request Interface, to use forms products such as FMS (Forms Management System), SMG (Screen Management Facility), terminal interface products from other vendors, and menus in an ALL-IN-1 office integration system.

request library file (RLB)

An OpenVMS file that contains TDMS requests and the form and record information necessary to execute those requests. When you use the TDMS Request Definition Utility (RDU) to build a request library file, RDU reads the definitions in CDD and puts information in the request library file so that the program can execute the requests. A request library file that contains the request named in a TDMS call must be opened before a program can use a request. Request library files have the default file type .RLB.

resource manager

An operating system service or layered product software that controls shared access to a set of recoverable resources (Rdb, DBMS, and RMS all include resource managers). A single distributed ACMS transaction can use more than one resource manager.

response

In HP DECforms, an optional part of the IFDL source code with which you can define how the Form Manager works with the terminal operator, the form, and the ACMS application.

RLB

See request library file.

RMS

See Record Management System.

rollback

A process that cancels any changes made to a resource during a database or distributed transaction.

root block

The outermost block step in a task definition. A task can include only one root block.

See also block step *and* nested block step.

root processing step

The processing step in a single-step task.

See also single-step task.

server context

In ACMS, information local to a server process, such as record locks and file pointers. Server context can be retained from one step to another in a block step, but cannot be passed between servers or tasks.

server image

An OpenVMS image that the ACMS run-time system loads into a server process. The two types of server images are procedure server images and DCL server images.

server procedure

In ACMS, programs or subroutines that are written in a programming language that conforms to the OpenVMS Calling Standard. There are two types of server procedures:

- Step procedures
- Cancel procedures, initialization procedures, and termination procedures

See also cancel procedure, initialization procedure, step procedure, *and* termination procedure.

server process (SP)

An OpenVMS process created according to the characteristics defined for a server in an ACMS application and task group definition. Server processes are started and stopped as needed by Application Execution Controllers.

See also Application Execution Controller (EXC) *and* task group database (TDB).

shadow workspace

A workspace that you can use in exchange steps that use HP DECforms. There are two types of shadow workspaces: SEND shadow workspace and RECEIVE shadow workspace. The SEND shadow workspace can contain an indicator that instructs the Form Manager whether to update last-known values of form data items. The RECEIVE shadow workspace contains indicators about which fields in the receive workspace have changed as a result of the exchange with the form.

single-step task

An ACMS task that has only a single processing step. Single-step tasks can be defined in a task group or a separate task definition.

See also multiple-step task, root processing step, *and* task group.

Software Event Logger (SWL)

The process that records ACMS software events that occur during the running of an application program. To see the events logged by the SWL, you must use the Software Event Log Utility Program (SWLUP).

See also Software Event Log Utility Program (SWLUP).

Software Event Log Utility Program (SWLUP)

The ACMS utility you use to list selected ACMS events that are logged by the SWL.

SQL

See Structured Query Language.

step

A part of an ACMS task definition that identifies one or more operations to be performed. Task definitions can have three kinds of steps: block steps, processing steps, and exchange steps. Each step contains clauses that describe the work to be done in that step, the action that follows the work, and the exception handler action that is performed if an exception occurs in the step.

See also block step, exchange step, processing step, step action, step attributes, step exception, step label, step procedure, *and* step work.

step action

In a task definition, the part of a step that tells ACMS what to do after completing the work for that step. These instructions can consist of a single unconditional action or a series of conditional actions based on one or more conditions, such as the value of a field in a workspace.

step attributes

In a task definition, the part of the step that tells ACMS the attributes of the step, such as the type of I/O to use.

step exception

An error that you can handle in the exception part of the step on which the exception occurs or in an exception handler on an outer block step.

step label

A name assigned to a step in a multiple-step ACMS task.

See also multiple-step task.

step procedure

A type of procedure called in a processing step of an ACMS task. Step procedures handle computations, data modification, and file and database access for processing steps that use procedure servers. Normally, step procedures do not handle input from or output to a terminal.

step work

The part of an ACMS step definition that describes terminal interactions, processing, or both.

stream

In ACMS, data passed between an agent program and an EXC. A stream allows communication between a terminal or nonterminal task submitter and ACMS.

See also Systems Interface (SI).

Structured Query Language (SQL)

A structured language for accessing and manipulating records stored in a relational database.

submitter node

In a distributed transaction processing system, the front end of a transaction processing system, from which users can select tasks that are submitted over the network to a back-end system for data manipulation and computation.

See also application node, back end, *and* front end.

SWL

See Software Event Logger.

SWLUP

See Software Event Log Utility Program.

Systems Interface (SI)

The ACMS Systems Interface is a group of system services that enable a programmer to interface a wide range of external devices and systems (such as ATMs and bar-code readers) with the ACMS run-time environment.

system workspace

A task workspace whose record definition is provided by ACMS. ACMS provides three system workspaces. At run time, ACMS fills in the contents of the system workspaces for each selected task. These workspaces, like other task workspaces, last only for the duration of a task instance.

See also group workspace, task instance, task workspace, user workspace, *and* workspace.

table

In a relational database, a collection of rows (records) and columns (fields). Also called a relation.

task

In ACMS, a unit of work that performs a specific function and can be selected for processing by a terminal user or another task. Every task belongs to a task group. Some tasks are defined in the task group they belong to; other tasks have separate task definitions. In either case, they are defined with ADU. The work of a task can be defined as a single processing step or a block step, which consists of a series of exchange and processing steps.

See also exchange step, multiple-step task, processing step, single-step task, *and* task group.

task attributes

The part of a task definition that tells ACMS the characteristics for the task as a whole, such as what workspaces to use.

task definition

In ACMS, the specification of the steps involved in the exchange of data between a user and the application, and in the processing of data against a database or file. You write a task definition using the task definition language.

task element

See queued task element.

task group

One or more ACMS tasks that have similar processing requirements and that are gathered together so they can share resources. A task group definition, created with ADU, defines the servers used by the tasks that belong to the group. It also defines other characteristics and requirements for the tasks in the group, such as workspaces, request libraries, and message files.

See also task group database (TDB) *and* task group definition.

task group database (TDB)

In ACMS, a binary file containing information derived from task and task group definitions. The Task Debugger uses the TDB when debugging tasks; ADU uses the TDB when building an application database. ACMS also uses the TDB to execute a task.

The TDB is created as a result of building a task group definition with ADU. Task group database files have the default file type .TDB.

task group definition

In ACMS, specifies the processing requirements and application resources shared by a group of tasks. The task group definition can include information about shared procedures, workspaces, servers, and messages. You write a task group definition using ADU. After creating the definition, you use ADU to build the task group database, which is the binary version of the definition file.

task instance

In ACMS, the occurrence of the processing of a task. Each selection of a task is a task instance. Every task instance is given a unique identifier by the ACMS run-time system.

See also task.

task I/O

In ACMS, the communication between a task submitter and a task instance. This communication can consist of OpenVMS terminal I/O, HP DECforms requests, TDMS requests, stream I/O, or I/O with other terminal or nonterminal interfaces using the Request Interface or Systems Interface.

See also request, Request Interface, Systems Interface, *and* task instance.

task queue

An area of storage where transactions can be placed as queued task elements for deferred processing. A task queue is created and managed using the ACMS Queue Manager Utility. Queued task elements are placed in the queue using the ACMS\$QUEUE_TASK programming service and removed from the queue by the ACMS Queued Task Initiator.

See also queued task element, Queued Task Initiator, queued task services, queuing facility, *and* Queue Manager Utility.

task selection string

In ACMS, the string of characters a terminal user types, in addition to or in place of a selection keyword or number, when making a selection from a menu.

task step

See step.

task submitter

Any authorized ACMS user who selects tasks for processing, provides input for that processing, and receives the results of that processing. Task submitters must also be authorized OpenVMS users.

task workspace

A workspace used mainly to pass information between steps in an ACMS multiple-step task. A task workspace is allocated when a terminal user starts a task, and keeps its contents only for the duration of the task instance.

See also multiple-step task *and* task instance.

TDB

See task group database.

TDMS

See Terminal Data Management System.

Terminal Data Management System (TDMS)

A transaction processing product that uses forms to collect and display information on the terminal. TDMS provides data independence by allowing data used in an application to be separated from the application program. ACMS multiple-step tasks use TDMS services to manage terminal input and output.

See also multiple-step task.

Terminal Subsystem Controller (TSC)

The process that controls which terminals have access to ACMS, controls the creation/deletion of Command Processes, and assigns terminals to Command Processes.

termination procedure

A procedure that closes files and releases databases. Termination procedures run when a server process is run down.

TP monitor

See transaction processing monitor.

transaction

See database transaction *and* distributed transaction.

transaction exception

An error that causes a distributed transaction to fail.

transaction manager

In a distributed transaction, the HP DECdtm transaction coordinator that communicates with the resource managers and implements the two-phase commit protocol.

transaction processing (TP)

An environment that addresses large, corporate-level applications that support many users for critical business functions. In a transaction processing application, many users simultaneously perform predefined (query and update) functions on a collection of shared data, generally a database. Results are usually expected immediately (real time).

transaction processing (TP) monitor

The component of a transaction processing system that manages access to the CPU, functioning like a specialized operating system within your operating system. A TP monitor can include utilities for terminal and forms management, data management, network access, authorization and security, and transaction restart/recovery. ACMS is a TP monitor.

TSC

See Terminal Subsystem Controller.

two-phase commit (2PC) protocol

A protocol used to synchronize the commit actions of multiple, independent resource managers. The protocol has a prepare phase, in which each resource manager indicates its willingness to commit; and a commit phase, in which resource managers, when instructed by the transaction manager, either commit and roll forward, or abort and roll back.

In a two-phase commit, either all resource managers commit the distributed transaction or all roll it back; the distributed transaction cannot be committed by some participants and rolled back by others.

UDU

See User Definition Utility.

UIC

See user identification code.

unique name

A designation assigned to a component, such as a task, that is used to identify that component within and across definitions.

user definition file

A file, created and maintained with the ACMS User Definition Utility (UDU), that contains a list of users authorized to access ACMS.

User Definition Utility (UDU)

The ACMS tool for authorizing ACMS users and defining characteristics of those users.

user identification code (UIC)

A code identifying an OpenVMS user by a group number or name and a member number or name separated by a comma and enclosed in brackets.

user interface

In a transaction processing system, the data input element. The user interface usually includes a presentation service, such as HP DECforms.

user name

A designation assigned to an OpenVMS user to identify that user. Also the name a terminal user enters to log in to OpenVMS and sign in to ACMS.

user request procedure (URP)

A procedure that replaces a TDMS request in an exchange step and performs I/O to the user's device. The ACMS Request Interface (RI) executes URPs.

See also Request Interface.

user workspace

In ACMS, a workspace, defined as an attribute of a task group, that holds information about a terminal user. A user workspace is created the first time a terminal user starts a task that refers to it. ACMS keeps a separate copy of a user workspace for each user, and saves the contents of the workspace until the user exits from ACMS.

See also group workspace, task group, *and* workspace.

viewports

User-defined rectangular areas of a HP DECforms display. For a panel to be visible, it must be associated with a viewport.

workspace

In ACMS, a buffer used to save variable context between steps and tasks. Workspace descriptions are stored in a CDD dictionary. A workspace can also hold application parameters and status information. Workspaces are passed to step procedures and tasks as parameters.

See also group workspace, system workspace, task workspace, *and* user workspace.

A

AAU

See Application Authorization Utility

ACC

See ACMS Central Controller

Access

privileges

for applications, 1–8

for terminals, 1–8

for users, 1–8

utilities, 4–1

Access Control List, 3–2

ACMS

See ACMS system

ACMS\$DIRECTORY

defining as a logical name, 13–1

installing applications in, 13–1

storing application databases in, 12–5

ACMS\$PROCESSING_STATUS, 2–8

ACMS\$SELECTION_STRING, 2–8

ACMS\$TASK_INFORMATION, 2–8

ACMS Central Controller, 3–2

ACMS status messages, 4–3

ACMS system, 1–4f

advantages, 1–1

Application Definition Utility, 7–19

definition, 1–1

development system, 5–1

documentation set, 5–1

entering, A–1

markets, 1–1

operator commands

run-time processing of, 3–2

product kits, 5–1

queuing facility, 1–5

remote access option, 5–1

resources

managing in transaction processing

applications, 1–4

scheduling, 3–2

run-time option, 5–1

support, 1–12

training, 1–12

workspaces

See also Workspaces, 2–8

ACMS Task Debugger

See Task Debugger

ADU

See Application Definition Utility

ALL-IN-1, 1–9, 2–9

ANSI/ISO proposed forms standards conformance,
1–9

Application, 2–9

attributes, 2–9

availability, 1–5, 1–6

building databases for, 10–3

controlling, 2–1, 4–2, 10–1, 11–1

defining, 2–1, 2–9, 10–1

definitions

defining application characteristics in,
10–1

defining server characteristics in, 10–2

defining task characteristics in, 10–2

storing in CDD, 10–2

displaying information about, 4–2

implementing, 10–1, 11–1

installing, 13–1

maintenance of, 1–7

modularity of, 1–7

monitoring, 4–3

node

defined, 1–3

running tasks in, A–1

starting, 4–2, 13–2

stopping, 4–2, 13–4

testing, 2–11

Application Authorization Utility, 4–2

using, 12–5

Application database

at run time, 3–2

authorizing, 4–2

building, 10–3

installing in ACMS\$DIRECTORY, 4–2

storing in ACMS\$DIRECTORY, 12–5

Application Definition Utility, 1–7

building application databases with, 10–3

building menu databases with, 11–3

defining applications with, 10–1

defining menus with, 11–1

defining task groups with, 9–6

defining tasks with, 7–19

exiting from, 7–24

Application Execution Controller, 3-2, 10-1
 run-time processing, 3-3
 starting and stopping server processes, 3-3

ATL

See Audit Trail Logger

Audit trail

 specifying for applications, 10-1
 specifying for tasks, 10-2

Audit Trail Logger, 3-3, 4-3, A-2

Audit Trail Report Utility, 4-3

 creating reports with, 4-3

Authorization

 of ACMS users, 12-1

 of applications, 4-2

 of OpenVMS users, 12-1

 of terminals for ACMS, 4-2, 12-4, 15-9

 of users, 4-1

 of users to install applications, 12-5

AUTHORIZE Utility (OpenVMS), 4-2

B

Back-end processing, 1-4

 and application availability, 1-6

 at run time, 3-4

 functions, 1-3

 run-time performance with, 3-4

 run-time processes, 1-3

 using VAX mainframes, 1-4

Badge readers, 1-9

Bar code readers, 1-9

BASIC, 2-4

Block steps, 2-4

 defining, 7-23, 8-7

 defining step, 7-22

 parts of, 7-22

 work for data entry tasks, 7-23

Building

 databases

 application, 10-3

 task group, 9-8, 9-9

 menu databases, 11-3

C

C, 1-11, 2-4

Calls

 to HP DECforms, 7-20

Canceling

 tasks, 7-28, 8-10

Cancellation procedures, 9-4

Cancel procedures, 2-7

CDD, 1-11

 application definitions in, 10-2

 copying definitions in procedures, 7-27, 8-10

 default directories, 7-1

 task definitions in, 7-23

CMS

See Code Management System

COBOL, 1-11, 2-4

 writing data entry procedures in, 7-27

 writing inquiry/update procedures in, 8-8

CODASYL databases, 1-10

Code Management System

 application development tool, 1-11

Command files

 submitting menu definitions as, 11-1

 submitting task definitions as, 7-24

 submitting task group definitions as, 9-6

Command Process, 3-2

 run-time processing, 3-3

Compiling

 procedures, 7-28, 9-2, 9-4

Control characteristics

 defining, 2-1

Control fields

 in inquiry/update tasks, 8-4

Controlling

 data access

See Data access

COPY FROM DICTIONARY

 HP DECforms IFDL clause, 7-16

CP

See Command Process

D

Data access, 1-8

Database management systems

See DBMS

See Rdb

Databases

 application, 10-3

 I/O

 at run time, 3-2

 menu, 11-3

 task group, 9-8

Data dictionary, 1-11

Data Division (COBOL)

 in data entry procedures, 7-27

 in inquiry/update procedures, 8-8

Data entry tasks

 handling errors in, 7-21

 procedures for, 7-24, 7-28

 storing definitions in CDD, 7-23

 submitting definitions to ADU, 7-24

 task definitions for, 7-19

DBMS

 using with ACMS, 1-10

DCL servers

See Servers

DDU

See Device Definition Utility

Debugging
 tasks, 9–9
Debugging tasks, 2–10
DECforms
 TRANSCEIVE call, 7–20
Default
 directory
 for CDD, 7–1
Designing applications, 2–2
Device Definition Utility, 4–2, 12–4, 15–9
Directories
 default CDD, 7–1
Disable response, 7–17
Distributed application
 with ACMS, 1–4
Documentation set, 5–1
DTM
 See HP/Test Manager

E

Environment Division (COBOL)
 in data entry procedures, 7–27
 in inquiry/update procedures, 8–8
Errors
 handling
 in data entry tasks, 7–21
 messages
 ACMS, A–4
 recording, 4–5
 recording messages, 4–5
 returned from procedures, 7–27
EXC
 See Application Execution Controller
Exchange steps, 2–4
 calls to HP DECforms in, 7–20
 defining, 7–22
 for data entry tasks, 7–20
 for inquiry/update tasks, 8–5
 definition of, 7–19
 displaying error messages in, 7–21, 8–5
 in data entry task, 7–20
 listing workspaces in, 7–20, 8–5
 repeating, 8–5
.EXE file
 in HP DECforms, 7–18

F

Fields
 creating in HP DECforms, 7–13
Files
 adding records to, 7–28
 defining for procedures, 7–27
 HP DECforms
 object module, 7–18
 shareable image (.EXE), 7–18
 retrieving records from, 8–10

Files (cont'd)
 types
 default for application databases, 10–3
 default for COBOL programs, 7–27
 default for menu databases, 11–3
 default for task group databases, 9–8
 updating records in, 8–12

FIMS
 See Form Interface Management System

FMS
 See Forms Management System

Form files
 naming in task group definitions, 9–6

Form Interface Management System
 ACMS conformance, 1–9

Forms
 See also HP DECforms
 ACMS support, 1–9
 declaring, 2–8
 definitions
 for inquiry/update tasks, 8–1

Forms Management System, 1–9

FORTTRAN, 1–11, 2–4

FQUT
 in HP DECforms, 7–16

Front-end processing, 1–4
 and application availability, 1–6
 at run time, 3–2, 3–4
 functions, 1–3
 run-time performance with, 3–4
 run-time processes, 1–3
 using MicroVAX, 1–4

Function
 keys
 in HP DECforms, 7–16
 in inquiry/update tasks, 8–4
 responses
 in HP DECforms, 7–17
 in inquiry/update tasks, 8–4

G

Growth
 expanding an ACMS system, 1–4

H

HELP
 command, A–4
HP/Code Management System
 See Code Management System
HP/Module Management System
 See Module Management System
HP/Test Manager, 1–11
HP DECdtm services, 1–10

HP DECforms, 1–9
 creating a form, 7–5
 creating fields in, 7–13
 disable response, 7–17
 editing form source file, 7–15
 error status field, 7–16
 executable image, .EXE files, 7–18
 extracting object, 7–18
 FDE, 7–5
 .FORM file, 7–5
 form name, 7–5
 form record
 example, 7–16
 function key, 7–16
 function response, 7–16, 7–17
 .IFDL file, 7–5
 layout, 7–6
 message panel, 7–16
 naming form, 7–6
 object module, .OBJ files, 7–18
 panel, 7–8
 Panel Editor, 7–5
 PF4 key, 7–16
 QUIT_KEY, 7–16
 RECEIVE call, 7–20
 receive response, 7–17
 SEND call, 7–20
 send response, 7–17
 shareable image files, 7–18
 testing form, 7–15
 transceive response, 7–17
 translating form, 7–18
 using with ACMS, 2–9
 viewport, 7–10
HP DECforms trace facility
 for debugging, A–3
HP DECset tools, 1–11

I

Identification Division (COBOL)
 in data entry procedures, 7–27
 in inquiry/update procedures, 8–8
Initialization procedures, 2–7, 9–1
 compiling, 9–2
Inquiry tasks
 RMS
 control fields in, 8–4
 form definitions for, 8–1
 function keys in, 8–4
 function responses in, 8–4
 procedures for, 8–8
 task definitions for, 8–3, 8–8
Installation
 of application databases, 4–2
 of applications, 13–1

L

Labels
 step
 assigned in task definitions, 7–20
Language-Sensitive Editor, 1–11
Layout
 HP DECforms, 7–6
Linkage Section (COBOL)
 in data entry procedures, 7–27
Linking
 server images, 9–9
LSE
 See Language-Sensitive Editor

M

Menu, 2–9
 assigning to users, 12–2, 15–8
 building databases for, 11–3
 databases
 at run time, 3–2
 defining, 11–1, 11–2
 definitions, 2–1
 purpose of, 2–9
 required parts of, 2–9
 submitting to ADU, 11–2
 display
 at run time, 3–2
 entries, 2–9
 hierarchy, 2–9
 selecting tasks from, A–1
Message files, 2–8
MESSAGEPANEL
 description of, 7–16
MMS
 See Module Management System
Module Management System
 application development tool, 1–11
Monitoring
 ACMS systems, 4–3
Multiple-step tasks, 2–5
Multithreaded processes, 1–4

N

Networks, 3–4
Node
 submitter and application, 1–3

O

.OBJ file
 in HP DECforms, 7–18
Office integration systems
 See ALL-IN-1

OpenVMS

See also OpenVMS Debugger

Calling Standard, 1–11

operating system, 1–10

Parameters

adjusting SYSGEN PQL_ for tutorial user accounts, 12–2

privileges for ACMS operator commands, 4–2

OpenVMS Cluster networks, 1–5f

OpenVMS Debugger, 2–10

OpenVMS system

failure

continuing work after, 1–5

OPER

privilege, 4–2

Operational messages, 4–3

Operator

terminal, 4–3

Oracle Trace, 1–11

for auditing parts applications, 4–4

P

Panel

creating HP DECforms, 7–8

Parameters

SYSGEN

adjusting PQL_ for tutorial user accounts, 12–2

PCA

See Performance and Coverage Analyzer

Performance

See Transaction Processing system, performance

Performance and Coverage Analyzer, 1–11

PQL_MEMQLM

OpenVMS SYSGEN parameter

adjusting for tutorial user accounts, 12–2

PQL_ OpenVMS SYSGEN parameters

adjusting for tutorial user accounts, 12–2

Procedure Division (COBOL)

for update procedures, 8–12

in data entry procedures, 7–28

Procedures, 2–7

See also Servers, procedure

calling in processing steps, 7–21, 8–5

cancel, 9–4

compiling, 7–28, 9–2, 9–4

copying CDD definitions in, 7–27

for data entry tasks, 7–24, 7–28

for inquiry/update tasks, 8–8, 8–13

handling errors in data entry, 7–27

initialization, 9–1

linking in the server image, 9–9

passing workspaces to, 7–21

termination, 9–3

Procedure servers

naming in task group definitions, 9–7

Process

See also ACMS Central Controller

See also Application Execution Controller

See also Audit Trail Logger

See also Command Process

See also Queued Task Initiator

See also Run-time system

See also Servers

See also Software Event Logger

See also Terminal Subsystem Controller

ACMS usage, 1–4

at run time, 3–3f

in a timesharing system, 1–2

in a TP system, 1–2

multithreaded, 1–4

server, 1–4

terminal I/O, 1–4

Processing steps, 2–4

at run time, 3–2

handling errors in, 7–21

in data entry task, 7–21

passing workspaces to, 7–21

Programming languages

at run time, 3–2

BASIC, 2–4

C, 1–11, 2–4

COBOL, 1–11, 2–4

FORTRAN, 1–11, 2–4

for writing server procedures, 2–5

using with ACMS, 2–4

Q

QTI

See Queued Task Initiator

Queued Task Initiator, 3–2

Queue Manager Utility

programming services, 3–2

run-time processing, 3–2

Queuing tasks

See Task queue

QUIT_KEY

in HP DECforms, 7–16

R

Rdb

using with ACMS, 1–10

RECEIVE

call to HP DECforms, 7–20

Receive response, 7–17

Record Management System

See RMS

Records

- adding to RMS file, 7-28
- copying CDD definitions in procedures, 7-27
- defining in step procedures, 7-27
- primary keys of, 7-21
- retrieving from RMS file, 8-10
- storing
 - definitions in CDD, 7-4
- updating in RMS file, 8-12

Recovery

- database, 1-5
- file, 1-5

Relational Database Management System

See Rdb

Relational databases, 1-10

Remote access option

See ACMS system, remote access option

Remote Manager, 4-5

Request Interface, 1-9, 2-9

using in exchange steps, 2-4

Request libraries, 2-8

Resource manager

defined, 1-7

Responses

in HP DECforms, 7-17

Retail transaction menu, 2-9f

RMS

using with ACMS, 1-10

Run-time option

See ACMS system, run-time option

Run-time processing

- ACMS components, 3-1
- ACMS processes, 3-1
- task execution, 3-3
- task selection, 3-3
- terminal allocation, 3-3
- with a separate front end, 3-4f

Run-time system, 3-1

- ACMS Central Controller, 3-2
- Application Execution Controller, 3-2
- Audit Trail Logger, 3-3
- Command Process, 3-2
- components, 3-1
- control and monitoring processes, 3-2
- design of, 3-4
- processes, 3-1, 3-2, 3-3f
 - work processes, 3-1
- Queued Task Initiator, 3-2
- server process, 3-2
- Software Event Logger, 3-3
- Terminal Subsystem Controller, 3-2

S

SCA

See Source Code Analyzer

Screen Management Facility, 1-9

Security

protecting authorization files, 4-2

Selecting tasks, 2-10

at run time, 3-3

SEND

call to HP DECforms, 7-20

Send response, 7-17

Servers

DCL, 2-7, 9-7

defining

characteristics of, 10-2

images, 9-9

naming, 9-9

linking images for, 9-9

naming

in task group definitions, 9-7

object modules for, 9-8

procedure, 2-5, 2-8, 9-7

processes, 3-2, 7-21

controlling number of, 10-2

run-time processing, 3-3

starting and stopping, 3-3

SMG

See Screen Management Facility

Software Event Logger, 3-3, 4-5, A-3

Software events

recording, 4-5

Source Code Analyzer, 1-11

Source files

accessing on line, B-1

compiling with the COBOL compiler, 7-28

defining

menus in, 11-1

task groups in, 9-6

tasks in, 7-19

editing IFDL, 7-15

for COBOL step procedures, 7-27

submitting to ADU, 7-24

SP

See Servers, processes

SQL

using with ACMS, 1-10

Starting

applications, 4-2

Status

values

errors indicated by, 7-21, 8-5

returned by data entry procedures, 7-27

testing in procedures, 7-21

- Status messages
 - receiving, 4-3
- Steps
 - block, 2-4, 7-22
 - exchange, 2-4, 7-19
 - processing, 2-4, 7-19, 7-21
- Stopping
 - applications, 4-2
- Storing
 - data in dictionary, 1-11
- Submitter
 - node
 - defined, 1-3
- SWL
 - See* Software Event Logger
- System
 - See also* ACMS system
 - See also* OpenVMS system
 - performance
 - at run time, 3-3, 3-4
 - front-end processing, 3-4
 - in a network, 3-4
 - tuning, 4-5
 - resources
 - See* System, performance
- Systems Interface
 - overview, 1-9
 - using
 - in exchange steps, 2-4
- System workspaces
 - See* Workspaces

T

- Task Debugger, 2-10, 9-9
- Task groups, 2-8
 - building databases for, 9-8, 9-9
 - cancel procedures for, 9-4
 - databases, 2-9, 9-8
 - at run time, 2-9, 3-2
 - building, 9-9
 - naming, 9-8
 - debugging tasks in, 9-9
 - defining, 2-1
 - definitions, 2-8, 9-6, 9-8
 - naming
 - form files in, 9-6
 - servers in, 9-7
 - tasks in, 9-6
 - submitting to ADU, 9-8
 - execution, 3-1
 - initialization procedures for, 9-1
 - listing in application definitions, 10-2
 - purpose of, 2-8
 - termination procedures for, 9-3

- Task queue
 - queuing tasks, 1-5
 - Run-time processing of, 3-2
 - usage of, 1-5
- Tasks
 - as business transactions, 2-2
 - canceling, 7-28, 8-10
 - controlling availability of, 4-2
 - debugging, 9-9
 - defined, 2-2
 - defining, 2-4
 - characteristics for, 10-2
 - data entry, 7-19
 - definitions
 - exchange step, 7-22
 - for data entry tasks, 7-19
 - for inquiry/update tasks, 8-3, 8-8
 - steps in, 7-19
 - storing in CDD, 7-23
 - execution, 3-1
 - group databases
 - building, 9-8
 - handling errors in, 7-21
 - inquiry/update
 - defining, 8-3, 8-8
 - multiple-step, 2-5
 - naming
 - in task group definitions, 9-6
 - procedures
 - for data entry, 7-24, 7-28
 - for inquiry/update, 8-8, 8-13
 - security of, 3-2
 - selecting from menus, A-1
 - steps, 2-4
 - block, 2-4
 - defining, 2-4
 - exchange, 2-4
 - for an inventory update task, 2-5f
 - processing, 2-4
 - storing definitions in CDD, 7-23
 - using workspaces in, 2-8
 - workspaces
 - used in, 7-23, 8-7
- TDMS
 - See* Terminal Data Management System
- Terminal
 - See also* Device Definition Utility
 - authorizing ACMS, 4-2
 - controlled
 - and noncontrolled, 12-4, 15-10
 - interfaces, 1-9
 - other vendors, 1-9
- Terminal Data Management System, 1-9
 - using with ACMS, 2-9
- Terminal I/O, 2-4
 - at run time, 3-2, 3-3
 - using Request Interface, 2-4

- Terminal Subsystem Controller, 3-2
- Termination procedures, 2-7, 9-3
 - compiling, 9-4
- Terminology (ACMS), 1-1, 2-1
- Testing
 - See also* Debugging tasks
 - applications, 2-11
 - HP DECforms forms, 7-15
- Timesharing, 1-2f
- Tools
 - layered products, 1-10
- TP applications
 - See* Transaction processing, applications
- TP monitor
 - See* Transaction processing monitor
- TP system
 - See* ACMS system
 - See* Transaction processing, system
- Tracing
 - HP DECforms, A-3
- Transaction processing
 - applications
 - controlling, 1-1
 - developing, 1-1
 - running, 1-1
 - back-end, 1-4
 - defined, 1-1
 - environment, 1-1, 1-2f
 - front-end, 1-4
 - in a network, 1-4
 - monitor
 - functions of a, 1-2
 - system
 - advantages of, 1-2
 - characteristics, 1-1
 - criteria, 1-1
 - development of, 1-2
- Transaction processing applications
 - deferred processing, 1-5
 - functions of, 1-3
 - high priority work, 1-5
 - maintenance of, 1-7
 - modularity of, 1-7
 - real-time work, 1-5
 - using queuing in, 1-5
- Transaction processing monitor, 1-2
 - ACMS, 1-3
 - characteristics, 1-3
 - facilities, 1-3
- Transaction processing system
 - availability, 1-5
 - performance, 1-3, 1-4
- Transactions
 - definition, 1-1

- TRANSCIVE
 - call to HP DECforms, 7-20
- Transceive response, 7-17
- Translating
 - HP DECforms forms, 7-18
- TSC
 - See* Terminal Subsystem Controller

U

- UDU
 - See* User Definition Utility
- User
 - authorizing access to ACMS, 4-1
- User Definition Utility, 4-2
 - using, 12-1
- User names
 - assigning
 - with the Authorize Utility, 4-2

V

- VAX COBOL
 - See* COBOL
- Volume shadowing, 1-5

W

- Workspaces, 2-8
 - defining
 - for inquiry/update tasks, 8-5
 - in task definition, 7-23
 - listing
 - in exchange step, 8-5
 - in task definitions, 8-7
 - passing
 - between requests and procedures, 7-27, 8-10
 - to procedures, 7-21
 - storing
 - definitions in CDD, 7-20
 - status values in, 7-21
 - system
 - ACMS\$PROCESSING_STATUS, 2-8
 - ACMS\$SELECTION_STRING, 2-8
 - ACMS\$TASK_INFORMATION, 2-8