

HP C

Run-Time Library Reference Manual for OpenVMS Systems

Order Number: BA554-90014

June 2010

This manual describes the functions and macros in the HP C Run-Time Library for OpenVMS systems.

Revision/Update Information: This manual supersedes the *HP C Run-Time Library Reference Manual for OpenVMS Systems*, Version 8.3

Software Version: OpenVMS Version 8.4 for Integrity servers
OpenVMS Alpha Version 8.4

Hewlett-Packard Company
Palo Alto, California

© Copyright 2010 Hewlett-Packard Development Company, L.P.

Confidential computer software. Valid license from HP required for possession, use or copying. Consistent with FAR 12.211 and 12.212, Commercial Computer Software, Computer Software Documentation, and Technical Data for Commercial Items are licensed to the U.S. Government under vendor's standard commercial license.

The information contained herein is subject to change without notice. The only warranties for HP products and services are set forth in the express warranty statements accompanying such products and services. Nothing herein should be construed as constituting an additional warranty. HP shall not be liable for technical or editorial errors or omissions contained herein.

UNIX is a registered trademark of The Open Group.

X/Open is a registered trademark of X/Open Company Ltd. in the UK and other countries.

Intel and Itanium are trademarks or registered trademarks of Intel Corporation or its subsidiaries in the United States and other countries.

Microsoft and Windows are US registered trademarks of Microsoft Corporation.

Printed in the US

ZK5763

The HP OpenVMS documentation set is available on CD-ROM.

This document was prepared using DECdocument, Version 3.3-1b.

Portions of the HP C Run-Time Library have been implemented using source copyrighted by the University of California, Berkley and its contributors.

Copyright (c) 1981 Regents of the University of California.

All rights reserved.

Redistribution and use in source and binary forms, with or without modification, are permitted provided that the following conditions are met:

1. Redistributions of source code must retain the above copyright notice, this list of conditions and the following disclaimer.
2. Redistributions in binary form must reproduce the above copyright notice, this list of conditions and the following disclaimer in the documentation and/or other materials provided with the distribution.
3. All advertising materials mentioning features or use of this software must display the following acknowledgement: This product includes software developed by the University of California, Berkeley and its contributors.
4. Neither the name of the University nor the names of its contributors may be used to endorse or promote products derived from this software without specific prior written permission.

THIS SOFTWARE IS PROVIDED BY THE REGENTS AND CONTRIBUTORS "AS IS" AND ANY EXPRESS OR IMPLIED WARRANTIES, INCLUDING, BUT NOT LIMITED TO, THE IMPLIED WARRANTIES OF MERCHANTABILITY AND FITNESS FOR A PARTICULAR PURPOSE ARE DISCLAIMED. IN NO EVENT SHALL THE REGENTS OR CONTRIBUTORS BE LIABLE FOR ANY DIRECT, INDIRECT, INCIDENTAL, SPECIAL, EXEMPLARY, OR CONSEQUENTIAL DAMAGES (INCLUDING, BUT NOT LIMITED TO, PROCUREMENT OF SUBSTITUTE GOODS OR SERVICES; LOSS OF USE, DATA, OR PROFITS; OR BUSINESS INTERRUPTION) HOWEVER CAUSED AND ON ANY THEORY OF LIABILITY, WHETHER IN CONTRACT, STRICT LIABILITY, OR TORT (INCLUDING NEGLIGENCE OR OTHERWISE) ARISING IN ANY WAY OUT OF THE USE OF THIS SOFTWARE, EVEN IF ADVISED OF THE POSSIBILITY OF SUCH DAMAGE.

Contents

Preface	xxv
1 Introduction	
1.1 Using the HP C Run-Time Library	1-2
1.2 RTL Linking Options	1-3
1.2.1 Linking with the Shareable Image	1-3
1.2.2 Linking with the Object Libraries (<i>Alpha only</i>)	1-3
1.2.3 Examples	1-5
1.2.4 DECC\$SHRP.EXE Image	1-6
1.3 HP C RTL Function Prototypes and Syntax	1-6
1.3.1 Function Prototypes	1-6
1.3.2 Syntax Conventions for Function Prototypes	1-7
1.3.3 UNIX Style File Specifications	1-7
1.3.4 Extended File Specifications	1-10
1.3.5 Symbolic Links and POSIX Pathnames	1-10
1.4 Feature-Test Macros for Header-File Control	1-10
1.4.1 Standards Macros	1-10
1.4.2 Selecting a Standard	1-11
1.4.3 Interactions with the /STANDARD Qualifier	1-13
1.4.4 Multiple-Version-Support Macro	1-15
1.4.5 Compatibility Modes	1-15
1.4.6 Curses and Socket Compatibility Macros	1-16
1.4.7 2 GB File Size Macro	1-17
1.4.8 32-Bit UID and GID Macro (<i>Integrity servers, Alpha</i>)	1-17
1.4.9 Standard-Compliant stat Structure (<i>Integrity servers, Alpha</i>)	1-18
1.4.10 Using Legacy <code>_toupper</code> and <code>_tolower</code> Behavior (<i>Integrity servers, Alpha</i>)	1-18
1.4.11 Using Faster, Inlined Put and Get Functions (<i>Integrity servers, Alpha</i>)	1-18
1.4.12 POSIX Style <code>exit</code> (<i>Integrity servers, Alpha</i>)	1-18
1.5 Enabling C RTL Features Using Feature Logical Names	1-19
1.6 32-Bit UIDs/GIDs and POSIX Style Identifiers	1-38
1.7 Input and Output on OpenVMS Systems	1-39
1.7.1 RMS Record and File Formats	1-41
1.7.2 Access to RMS Files	1-42
1.7.2.1 Accessing RMS Files in Stream Mode	1-43
1.7.2.2 Accessing RMS Record Files in Record Mode	1-43
1.7.2.2.1 Accessing Variable-Length or VFC Record Files in Record Mode	1-45
1.7.2.2.2 Accessing Fixed-Length Record Files in Record Mode	1-46
1.7.2.3 Example—Difference Between Stream Mode and Record Mode	1-46
1.8 Specific Portability Concerns	1-48
1.8.1 Reentrancy	1-50
1.8.2 Multithread Restrictions	1-52
1.9 64-Bit Pointer Support (<i>Integrity servers, Alpha</i>)	1-53

1.9.1	Using the HP C Run-Time Library	1-53
1.9.2	Obtaining 64-Bit Pointers to Memory	1-54
1.9.3	HP C Header Files	1-54
1.9.4	Functions Affected	1-55
1.9.4.1	No Pointer-Size Impact	1-55
1.9.4.2	Functions Accepting Both Pointer Sizes	1-56
1.9.4.3	Functions with Two Implementations	1-56
1.9.4.4	Socket Transfers Greater than 64 KB	1-57
1.9.4.5	Functions Requiring Explicit use of 64-Bit Structures	1-58
1.9.4.6	Functions Restricted to 32-Bit Pointers	1-60
1.9.5	Reading Header Files	1-60
2	Understanding Input and Output	
2.1	Using RMS from RTL Routines	2-4
2.2	UNIX I/O and Standard I/O	2-5
2.3	Wide-Character Versus Byte I/O Functions	2-6
2.4	Conversion Specifications	2-7
2.4.1	Converting Input Information	2-7
2.4.2	Converting Output Information	2-13
2.5	Terminal I/O	2-19
2.6	Program Examples	2-20
3	Character, String, and Argument-List Functions	
3.1	Character-Classification Functions	3-4
3.2	Character-Conversion Functions	3-7
3.3	String and Argument-List Functions	3-9
3.4	Program Examples	3-10
4	Error and Signal Handling	
4.1	Error Handling	4-2
4.2	Signal Handling	4-5
4.2.1	OpenVMS Versus UNIX Terminology	4-5
4.2.2	UNIX Signals and the HP C RTL	4-6
4.2.3	Signal-Handling Concepts	4-8
4.2.4	Signal Actions	4-8
4.2.5	Signal Handling and OpenVMS Exception Handling	4-9
4.3	Program Example	4-13
5	Subprocess Functions	
5.1	Implementing Child Processes in HP C	5-2
5.2	The exec Functions	5-3
5.2.1	exec Processing	5-4
5.2.2	exec Error Conditions	5-5
5.3	Synchronizing Processes	5-5
5.4	Interprocess Communication	5-5
5.5	Program Examples	5-5

6 Curses Screen Management Functions and Macros

6.1	Using the BSD-Based Curses Package (<i>Alpha only</i>)	6-1
6.2	Curses Overview	6-2
6.3	Curses Terminology	6-4
6.3.1	Predefined Windows (<code>stdscr</code> and <code>curscr</code>)	6-5
6.3.2	User-Defined Windows	6-5
6.4	Getting Started with Curses	6-7
6.5	Predefined Variables and Constants	6-9
6.6	Cursor Movement	6-10
6.7	Program Example	6-11

7 Math Functions

7.1	Math Function Variants—float, long double (<i>Integrity servers, Alpha</i>)	7-4
7.2	Error Detection	7-4
7.3	The <code><fp.h></code> Header File	7-5
7.4	Example	7-5

8 Memory Allocation Functions

8.1	Program Example	8-2
-----	-----------------	-----

9 System Functions

10 Developing International Software

10.1	Internationalization Support	10-1
10.1.1	Installation	10-1
10.1.2	Unicode Support	10-1
10.2	Features of International Software	10-2
10.3	Developing International Software Using HP C	10-3
10.4	Locales	10-3
10.5	Using the <code>setlocale</code> Function to Set Up an International Environment	10-4
10.6	Using Message Catalogs	10-5
10.7	Handling Different Character Sets	10-6
10.7.1	Charmap File	10-6
10.7.2	Converter Functions	10-6
10.7.3	Using Codeset Converter Files	10-6
10.8	Handling Culture-Specific Information	10-7
10.8.1	Extracting Cultural Information From a Locale	10-8
10.8.2	Date and Time Formatting Functions	10-8
10.8.3	Monetary Formatting Function	10-8
10.8.4	Numeric Formatting	10-8
10.9	Functions for Handling Wide Characters	10-9
10.9.1	Character Classification Functions	10-9
10.9.2	Case Conversion Functions	10-9
10.9.3	Functions for Input and Output of Wide Characters	10-10
10.9.4	Functions for Converting Multibyte and Wide Characters	10-10
10.9.5	Functions for Manipulating Wide-Character Strings and Arrays	10-11
10.10	Collating Functions	10-11

11 Date/Time Functions

11.1	Date/Time Support Models	11-1
11.2	Overview of Date/Time Functions	11-2
11.3	HP C RTL Date/Time Computations—UTC and Local Time	11-3
11.4	Time-Zone Conversion Rule Files	11-4
11.5	Sample Date/Time Scenario	11-5

12 Symbolic Links and POSIX Pathname Support

12.1	POSIX Pathnames and Filenames	12-2
12.1.1	POSIX Pathname Interpretation	12-2
12.1.1.1	The POSIX Root Directory	12-2
12.1.1.2	Symbolic Links	12-2
12.1.1.3	Mount Points	12-2
12.1.1.4	Reserved Filenames . and	12-3
12.1.1.5	Character Special Files	12-3
12.1.2	Using POSIX Pathnames with OpenVMS Interfaces	12-3
12.1.2.1	Special Considerations with POSIX Filenames	12-4
12.1.2.2	Special Considerations with OpenVMS Filenames	12-5
12.2	Using Symbolic Links	12-5
12.2.1	Creating and Using Symbolic Links with DCL	12-5
12.2.2	Using Symbolic Links through GNV POSIX and DCL Commands	12-6
12.3	C RTL Support	12-8
12.3.1	DECC\$POSIX_COMPLIANT_PATHNAMES Feature Logical	12-8
12.3.2	decc\$to_vms, decc\$from_vms, and decc\$translate_vms	12-9
12.3.3	Symbolic Link Functions	12-10
12.3.4	Modifications to Existing Functions	12-10
12.3.5	Non POSIX-Compliant Behavior	12-10
12.3.5.1	Multiple Versions of Files	12-10
12.3.5.2	Ambiguous Filenames	12-11
12.3.5.3	POSIX Security Behavior for File Deletion	12-11
12.4	RMS Interface	12-11
12.4.1	RMS Input/Output of POSIX Pathnames	12-11
12.4.2	Application Control of RMS Symbolic Link Processing	12-12
12.5	Defining the POSIX Root	12-13
12.5.1	Suggested Placement of the POSIX Root	12-13
12.5.2	The SET ROOT Command	12-14
12.5.3	The SHOW ROOT Command	12-14
12.6	Current Working Directory	12-15
12.7	Establishing Mount Points	12-15
12.8	NFS	12-15
12.9	DCL	12-16
12.10	GNV	12-18
12.11	Restrictions	12-18

Reference Section

a64l (<i>Integrity servers, Alpha</i>)	REF-3
abort	REF-5
abs	REF-6
access	REF-7
acos	REF-9
acosh (<i>Integrity servers, Alpha</i>)	REF-10

[w]addch	REF-11
[w]addstr	REF-12
alarm	REF-13
asctime, asctime_r	REF-14
asin	REF-16
asinh (<i>Integrity servers, Alpha</i>)	REF-17
assert	REF-18
atan	REF-19
atan2	REF-20
atanh (<i>Integrity servers, Alpha</i>)	REF-21
atexit	REF-22
atof	REF-23
atoi, atol	REF-24
atoq, atoll (<i>Integrity servers, Alpha</i>)	REF-25
basename	REF-26
bcmp	REF-27
bcopy	REF-28
box	REF-29
brk	REF-30
bsearch	REF-31
btowc	REF-33
bzero	REF-34
cabs	REF-35
acos (<i>Integrity servers, Alpha</i>)	REF-36
acosh (<i>Integrity servers, Alpha</i>)	REF-37
calloc	REF-38
carg (<i>Integrity servers, Alpha</i>)	REF-39
casin (<i>Integrity servers, Alpha</i>)	REF-40
casinh (<i>Integrity servers, Alpha</i>)	REF-41
catan (<i>Integrity servers, Alpha</i>)	REF-42
catanh (<i>Integrity servers, Alpha</i>)	REF-43
catclose	REF-44
catgets	REF-45
catopen	REF-48
cbrt (<i>Integrity servers, Alpha</i>)	REF-51
ccos (<i>Integrity servers, Alpha</i>)	REF-52
ccosh (<i>Integrity servers, Alpha</i>)	REF-53
ceil	REF-54
cexp (<i>Integrity servers, Alpha</i>)	REF-55
cfree	REF-56
chdir	REF-57
chmod	REF-58
chown	REF-59
cimag (<i>Integrity servers, Alpha</i>)	REF-60
[w]clear	REF-61
clearerr	REF-62
clearerr_unlocked (<i>Integrity servers, Alpha</i>)	REF-63

clearok	REF-64
clock	REF-65
clock_getres <i>(Integrity servers, Alpha)</i>	REF-66
clock_gettime <i>(Integrity servers, Alpha)</i>	REF-67
clock_settime <i>(Integrity servers, Alpha)</i>	REF-68
clog <i>(Integrity servers, Alpha)</i>	REF-70
close	REF-71
closedir	REF-72
[w]clrattr	REF-74
[w]clrtobot	REF-75
[w]clrtoeol	REF-76
confstr	REF-77
conj <i>(Integrity servers, Alpha)</i>	REF-79
copysign <i>(Integrity servers, Alpha)</i>	REF-80
cos	REF-81
cosh	REF-82
cot	REF-83
cpow <i>(Integrity servers, Alpha)</i>	REF-84
cproj <i>(Integrity servers, Alpha)</i>	REF-85
creal <i>(Integrity servers, Alpha)</i>	REF-86
creat	REF-87
[no]crmode	REF-93
crypt	REF-94
csin <i>(Integrity servers, Alpha)</i>	REF-95
csinh <i>(Integrity servers, Alpha)</i>	REF-96
csqrt <i>(Integrity servers, Alpha)</i>	REF-97
ctan <i>(Integrity servers, Alpha)</i>	REF-98
ctanh <i>(Integrity servers, Alpha)</i>	REF-99
ctermid	REF-100
ctime, ctime_r	REF-101
cuserid	REF-103
DECC\$CRTL_INIT	REF-104
decc\$feature_get	REF-105
decc\$feature_get_index	REF-106
decc\$feature_get_name	REF-107
decc\$feature_get_value	REF-108
decc\$feature_set	REF-109
decc\$feature_set_value	REF-110
decc\$feature_show	REF-111
decc\$feature_show_all	REF-112
decc\$fix_time	REF-113
decc\$from_vms	REF-114
decc\$match_wild	REF-116
decc\$record_read	REF-117
decc\$record_write	REF-118
decc\$set_child_default_dir <i>(Integrity servers, Alpha)</i>	REF-119
decc\$set_child_standard_streams	REF-120

decc\$set_reentrancy	REF-124
decc\$to_vms	REF-126
decc\$translate_vms	REF-128
decc\$validate_wchar	REF-130
decc\$write_eof_to_mbx	REF-131
[w]delch	REF-134
delete	REF-135
[w]deleteln	REF-136
delwin	REF-137
difftime	REF-138
dirname	REF-139
div	REF-141
dlclose	REF-142
dlerror	REF-143
dlopen	REF-144
dlsym	REF-145
drand48	REF-146
dup, dup2	REF-147
[no]echo	REF-148
ecvt	REF-149
encrypt	REF-151
endgrent (<i>Integrity servers, Alpha</i>)	REF-152
endpwent	REF-153
endwin	REF-154
erand48	REF-155
[w]erase	REF-156
erf	REF-157
execl	REF-158
execle	REF-160
execlp	REF-161
execv	REF-162
execve	REF-163
execvp	REF-164
exit, _exit	REF-165
exp	REF-167
exp2 (<i>Integrity servers, Alpha</i>)	REF-168
fabs	REF-169
fchmod	REF-170
fchown	REF-171
fclose	REF-172
fcntl	REF-173
fcvt	REF-179
fdim (<i>Integrity servers, Alpha</i>)	REF-181
fdopen	REF-182
feof	REF-183
feof_unlocked (<i>Integrity servers, Alpha</i>)	REF-184
ferror	REF-185

<code>ferror_unlocked</code> (<i>Integrity servers, Alpha</i>)	REF-186
<code>fflush</code>	REF-187
<code>ffs</code>	REF-188
<code>fgetc</code>	REF-189
<code>fgetc_unlocked</code> (<i>Integrity servers, Alpha</i>)	REF-190
<code>fgetname</code>	REF-191
<code>fgetpos</code>	REF-192
<code>fgets</code>	REF-194
<code>fgetwc</code>	REF-196
<code>fgetws</code>	REF-197
<code>fileno</code>	REF-199
<code>finite</code> (<i>Integrity servers, Alpha</i>)	REF-200
<code>flockfile</code> (<i>Integrity servers, Alpha</i>)	REF-201
<code>floor</code>	REF-202
<code>fma</code> (<i>Integrity servers, Alpha</i>)	REF-203
<code>fmax</code> (<i>Integrity servers, Alpha</i>)	REF-204
<code>fmin</code> (<i>Integrity servers, Alpha</i>)	REF-205
<code>fmod</code>	REF-206
<code>fopen</code>	REF-207
<code>fp_class</code> (<i>Integrity servers, Alpha</i>)	REF-209
<code>fpathconf</code>	REF-210
<code>fprintf</code>	REF-212
<code>fputc</code>	REF-214
<code>fputc_unlocked</code> (<i>Integrity servers, Alpha</i>)	REF-215
<code>fputs</code>	REF-216
<code>fputwc</code>	REF-217
<code>fputws</code>	REF-219
<code>fread</code>	REF-220
<code>free</code>	REF-221
<code>freopen</code>	REF-222
<code>frexp</code>	REF-223
<code>fscanf</code>	REF-225
<code>fseek</code>	REF-227
<code>fseeko</code>	REF-229
<code>fsetpos</code>	REF-230
<code>fstat</code>	REF-231
<code>fstatvfs</code> (<i>Integrity servers, Alpha</i>)	REF-234
<code>fsync</code>	REF-236
<code>ftell</code>	REF-237
<code>ftello</code>	REF-238
<code>ftime</code>	REF-239
<code>ftok</code> (<i>Integrity servers, Alpha</i>)	REF-240
<code>ftruncate</code>	REF-241
<code>ftrylockfile</code> (<i>Integrity servers, Alpha</i>)	REF-242
<code>ftw</code>	REF-243
<code>funlockfile</code> (<i>Integrity servers, Alpha</i>)	REF-246
<code>fwait</code>	REF-247

fwide	REF-248
fwprintf	REF-249
fwrite	REF-251
fwscanf	REF-252
gcvt	REF-254
getc	REF-256
getc_unlocked (<i>Integrity servers, Alpha</i>)	REF-257
[w]getch	REF-258
getchar	REF-259
getchar_unlocked (<i>Integrity servers, Alpha</i>)	REF-260
getclock	REF-261
getcwd	REF-262
getdtablesize	REF-263
getegid	REF-264
getenv	REF-265
geteuid	REF-267
getgid	REF-268
getgrent (<i>Integrity servers, Alpha</i>)	REF-269
getgrgid (<i>Integrity servers, Alpha</i>)	REF-270
getgrgid_r (<i>Integrity servers, Alpha</i>)	REF-271
getgrnam (<i>Integrity servers, Alpha</i>)	REF-273
getgrnam_r (<i>Integrity servers, Alpha</i>)	REF-274
getgroups	REF-276
getitimer	REF-277
getlogin	REF-279
getname	REF-280
getopt	REF-281
getpagesize	REF-284
getpgid (<i>Integrity servers, Alpha</i>)	REF-285
getpgrp (<i>Integrity servers, Alpha</i>)	REF-286
getpid	REF-287
getppid	REF-288
getpwent	REF-289
getpwnam, getpwnam_r	REF-291
getpwuid, getpwuid_r (<i>Integrity servers, Alpha</i>)	REF-295
gets	REF-298
getsid (<i>Integrity servers, Alpha</i>)	REF-299
[w]getstr	REF-300
gettimeofday	REF-301
getuid	REF-302
getw	REF-303
getwc	REF-304
getwchar	REF-305
getyx	REF-306
glob (<i>Integrity servers, Alpha</i>)	REF-307
globfree	REF-311
gmtime, gmtime_r	REF-312

gsignal	REF-314
hypot	REF-316
iconv	REF-317
iconv_close	REF-319
iconv_open	REF-320
ilogb <i>(Integrity servers, Alpha)</i>	REF-322
[w]inch	REF-323
index	REF-324
initscr	REF-325
initstate	REF-326
[w]insch	REF-328
[w]insertln	REF-329
[w]insstr	REF-330
isalnum	REF-331
isalpha	REF-332
isapipe	REF-333
isascii	REF-334
isatty	REF-335
isctrl	REF-336
isdigit	REF-337
isgraph	REF-338
islower	REF-339
isnan <i>(Integrity servers, Alpha)</i>	REF-340
isprint	REF-341
ispunct	REF-342
isspace	REF-343
isupper	REF-344
iswalnum	REF-345
iswalpha	REF-346
iswcntrl	REF-347
iswctype	REF-348
iswdigit	REF-350
iswgraph	REF-351
iswlower	REF-352
iswprint	REF-353
iswpunct	REF-354
iswspace	REF-355
iswupper	REF-356
iswxdigit	REF-357
isxdigit	REF-358
j0, j1, jn <i>(Integrity servers, Alpha)</i>	REF-359
rand48	REF-360
kill	REF-361
l64a <i>(Integrity servers, Alpha)</i>	REF-362
labs	REF-363
lchown	REF-364
lcong48	REF-365

ldexp	REF-366
ldiv	REF-367
leaveok	REF-368
lgamma <i>(Integrity servers, Alpha)</i>	REF-369
link	REF-370
localeconv	REF-371
localtime, localtime_r	REF-375
log, log2, log10	REF-377
log1p <i>(Integrity servers, Alpha)</i>	REF-378
logb <i>(Integrity servers, Alpha)</i>	REF-379
longjmp	REF-380
longname	REF-382
rand48	REF-383
lrint <i>(Integrity servers, Alpha)</i>	REF-384
lround <i>(Integrity servers, Alpha)</i>	REF-385
lseek	REF-386
lstat <i>(Integrity servers, Alpha)</i>	REF-388
lwait	REF-389
malloc	REF-390
mblen	REF-392
mbrlen	REF-393
mbrtowc	REF-394
mbstowcs	REF-396
mbtowc	REF-397
mbsinit	REF-398
mbsrtowcs	REF-399
memccpy	REF-401
memchr	REF-402
memcmp	REF-403
memcpy	REF-404
memmove	REF-405
memset	REF-406
mkdir	REF-407
mkstemp	REF-410
mktemp	REF-411
mktime	REF-412
mmap	REF-414
modf	REF-419
[w]move	REF-420
mprotect	REF-421
rand48	REF-423
msync	REF-424
munmap	REF-426
mv[w]addch	REF-427
mv[w]addstr	REF-428
mvcur	REF-429
mv[w]delch	REF-430

mv[w]getch	REF-431
mv[w]getstr	REF-432
mv[w]inch	REF-433
mv[w]insch	REF-434
mv[w]insstr	REF-435
mvwin	REF-436
nanosleep (<i>Integrity servers, Alpha</i>)	REF-437
newwin	REF-439
nextafter (<i>Integrity servers, Alpha</i>)	REF-440
nexttoward (<i>Integrity servers, Alpha</i>)	REF-441
nice	REF-442
nint (<i>Integrity servers, Alpha</i>)	REF-443
[no]nl	REF-444
nl_langinfo	REF-445
nrnd48	REF-449
open	REF-450
opendir	REF-453
overlay	REF-455
overwrite	REF-456
pathconf	REF-457
pause	REF-459
pclose	REF-460
perror	REF-461
pipe	REF-462
poll (<i>Integrity servers, Alpha</i>)	REF-466
popen	REF-469
pow	REF-471
pread (<i>Integrity servers, Alpha</i>)	REF-472
printf	REF-473
[w]printw	REF-474
putc	REF-475
putc_unlocked (<i>Integrity servers, Alpha</i>)	REF-476
putchar	REF-477
putchar_unlocked (<i>Integrity servers, Alpha</i>)	REF-478
putenv	REF-479
puts	REF-481
putw	REF-482
putwc	REF-483
putwchar	REF-484
pwrite (<i>Integrity servers, Alpha</i>)	REF-485
qabs, llabs (<i>Integrity servers, Alpha</i>)	REF-486
qdiv, lldiv (<i>Integrity servers, Alpha</i>)	REF-487
qsort	REF-488
raise	REF-489
rand, rand_r	REF-490
random	REF-491
[no]raw	REF-492

read	REF-494
readdir, readdir_r	REF-496
readlink (<i>Integrity servers, Alpha</i>)	REF-498
readv (<i>Integrity servers, Alpha</i>)	REF-499
realloc	REF-501
realpath	REF-503
[w]refresh	REF-504
remainder (<i>Integrity servers, Alpha</i>)	REF-505
remquo (<i>Integrity servers, Alpha</i>)	REF-506
remove	REF-507
rename	REF-508
rewind	REF-510
rewinddir	REF-511
rindex	REF-512
rint (<i>Integrity servers, Alpha</i>)	REF-513
rmdir	REF-514
sbrk	REF-515
scalb (<i>Integrity servers, Alpha</i>)	REF-516
scanf	REF-517
[w]scanw	REF-518
scroll	REF-519
scrollok	REF-520
seed48	REF-521
seekdir	REF-522
sem_close (<i>Integrity servers, Alpha</i>)	REF-523
semctl (<i>Integrity servers, Alpha</i>)	REF-524
sem_destroy (<i>Integrity servers, Alpha</i>)	REF-527
semget (<i>Integrity servers, Alpha</i>)	REF-528
sem_getvalue (<i>Integrity servers, Alpha</i>)	REF-530
sem_init (<i>Integrity servers, Alpha</i>)	REF-531
sem_open (<i>Integrity servers, Alpha</i>)	REF-533
semop (<i>Integrity servers, Alpha</i>)	REF-535
sem_post (<i>Integrity servers, Alpha</i>)	REF-538
sem_timedwait (<i>Integrity servers, Alpha</i>)	REF-539
sem_trywait (<i>Integrity servers, Alpha</i>)	REF-540
sem_unlink (<i>Integrity servers, Alpha</i>)	REF-541
sem_wait (<i>Integrity servers, Alpha</i>)	REF-542
[w]setattr	REF-543
setbuf	REF-544
setenv	REF-545
seteuid (<i>Integrity servers, Alpha</i>)	REF-547
setgid	REF-548
setgrent (<i>Integrity servers, Alpha</i>)	REF-549
setitimer	REF-550
setjmp	REF-552
setkey	REF-554
setlocale	REF-555

setpgid (<i>Integrity servers, Alpha</i>)	REF-559
setpgrp (<i>Integrity servers, Alpha</i>)	REF-561
setpwent	REF-562
setregid (<i>Integrity servers, Alpha</i>)	REF-563
setreuid (<i>Integrity servers, Alpha</i>)	REF-564
setsid (<i>Integrity servers, Alpha</i>)	REF-565
setstate	REF-566
setuid	REF-567
setvbuf	REF-568
shm_open (<i>Integrity servers, Alpha</i>)	REF-570
shm_unlink (<i>Integrity servers, Alpha</i>)	REF-572
sigaction	REF-573
sigaddset	REF-576
sigblock	REF-577
sigdelset	REF-578
sigemptyset	REF-579
sigfillset	REF-580
sighold (<i>Integrity servers, Alpha</i>)	REF-581
sigignore (<i>Integrity servers, Alpha</i>)	REF-582
sigismember	REF-583
siglongjmp	REF-584
sigmask	REF-585
signal	REF-586
sigpause	REF-587
sigpending	REF-588
sigprocmask	REF-589
sigrelse (<i>Integrity servers, Alpha</i>)	REF-591
sigsetjmp	REF-592
sigsetmask	REF-594
sigsuspend	REF-595
sigtimedwait (<i>Integrity servers, Alpha</i>)	REF-596
sigvec	REF-597
sigwait (<i>Integrity servers, Alpha</i>)	REF-598
sigwaitinfo (<i>Integrity servers, Alpha</i>)	REF-599
sin	REF-600
sinh	REF-601
sleep	REF-602
snprintf	REF-603
sprintf	REF-605
sqrt	REF-607
rand	REF-608
rand48	REF-609
random	REF-610
sscanf	REF-611
ssignal	REF-613
[w]standend	REF-614
[w]standout	REF-615

stat	REF-616
statvfs (<i>Integrity servers, Alpha</i>)	REF-621
strcasemp	REF-623
strcat	REF-624
strchr	REF-626
strcmp	REF-628
strcoll	REF-629
strcpy	REF-630
strcspn	REF-631
strdup	REF-632
strerror	REF-633
strfmon	REF-635
strftime	REF-639
strlen	REF-645
strncasemp	REF-646
strncat	REF-647
strncmp	REF-648
strncpy	REF-650
strnlen	REF-651
strpbrk	REF-652
strptime	REF-653
strrchr	REF-658
strsep	REF-659
strspn	REF-660
strstr	REF-661
strtod	REF-663
strtok, strtok_r	REF-665
strtol	REF-668
strtouq, strtoll (<i>Integrity servers, Alpha</i>)	REF-670
strtoul	REF-672
strtouq, strtoull (<i>Integrity servers, Alpha</i>)	REF-673
strxfrm	REF-674
subwin	REF-677
swab	REF-678
swprintf	REF-679
swscanf	REF-680
symlink (<i>Integrity servers, Alpha</i>)	REF-681
sysconf	REF-683
system	REF-690
tan	REF-692
tanh	REF-693
telldir	REF-694
tempnam	REF-695
tgamma (<i>Integrity servers, Alpha</i>)	REF-697
time	REF-698
times	REF-699
tmpfile	REF-700

tmpnam	REF-701
toascii	REF-702
tolower	REF-703
_tolower	REF-704
touchwin	REF-705
toupper	REF-706
_toupper	REF-707
towctrans	REF-708
towlower	REF-709
towupper	REF-710
trunc (<i>Integrity servers, Alpha</i>)	REF-711
truncate	REF-712
ttyname, ttyname_r	REF-713
tzset	REF-715
ualarm	REF-719
umask	REF-720
uname	REF-721
ungetc	REF-722
ungetwc	REF-723
unlink (<i>Integrity servers, Alpha</i>)	REF-724
unordered (<i>Integrity servers, Alpha</i>)	REF-725
unsetenv	REF-726
usleep	REF-727
utime	REF-728
utimes	REF-731
VAXC\$CRTL_INIT	REF-734
VAXC\$ESTABLISH	REF-735
va_arg	REF-736
va_count	REF-737
va_end	REF-738
va_start, va_start_1	REF-739
vfork	REF-741
vfprintf	REF-743
vfscanf	REF-744
vfwprintf	REF-746
fwscanf	REF-748
vprintf	REF-749
vscanf	REF-750
vsnprintf (<i>Integrity servers, Alpha</i>)	REF-751
vsprintf	REF-752
vsscanf	REF-753
vswprintf	REF-754
vswscanf	REF-756
vwprintf	REF-757
vwscanf	REF-758
wait	REF-759
wait3	REF-760

wait4	REF-763
waitpid	REF-766
wcrtomb	REF-770
wscat	REF-771
wcschr	REF-773
wscmp	REF-775
wscoll	REF-776
wcscpy	REF-777
wscspn	REF-778
wcsftime	REF-780
wcslen	REF-786
wcsncat	REF-787
wcsncmp	REF-789
wcsncpy	REF-790
wcspbrk	REF-791
wcsrchr	REF-792
wcsrtombs	REF-794
wcsspn	REF-796
wcsstr	REF-798
wcstod	REF-799
wcstok	REF-801
wcstol	REF-804
wcstombs	REF-806
wcstoul	REF-807
wcswcs	REF-810
wcswidth	REF-812
wcsxfrm	REF-813
wctob	REF-816
wctomb	REF-817
wctrans	REF-818
wctype	REF-819
wcwidth	REF-822
wmemchr	REF-823
wmemcmp	REF-824
wmemcpy	REF-825
wmemmove	REF-826
wmemset	REF-827
wprintf	REF-828
wrapok	REF-830
write	REF-831
writev	REF-832
wscanf	REF-834
y0, y1, yn (<i>Integrity servers, Alpha</i>)	REF-835

A Version-Dependency Tables

A.1	Functions Available on all OpenVMS VAX, Alpha, and Integrity servers Versions	A-1
A.2	Functions Available on OpenVMS Version 6.2 and Higher	A-3
A.3	Functions Available on OpenVMS Version 7.0 and Higher	A-4
A.4	Functions Available on OpenVMS Alpha Version 7.0 and Higher	A-5
A.5	Functions Available on OpenVMS Version 7.2 and Higher	A-6
A.6	Functions Available on OpenVMS Version 7.3 and Higher	A-6
A.7	Functions Available on OpenVMS Version 7.3-1 and Higher	A-6
A.8	Functions Available on OpenVMS Version 7.3-2 and Higher	A-7
A.9	Functions Available on OpenVMS Version 8.2 and Higher	A-7
A.10	Functions Available on OpenVMS Version 8.3 and Higher	A-7
A.11	Functions Available on OpenVMS Version 8.4 and Higher	A-8

B Prototypes Duplicated to Nonstandard Headers

Index

Examples

1-1	Differences Between Stream Mode and Record Mode Access	1-46
2-1	Output of the Conversion Specifications	2-20
2-2	Using the Standard I/O Functions	2-22
2-3	Using Wide Character I/O Functions	2-23
2-4	I/O Using File Descriptors and Pointers	2-24
3-1	Character-Classification Functions	3-7
3-2	Converting Double Values to an ASCII String	3-8
3-3	Changing Characters to and from Uppercase Letters	3-8
3-4	Concatenating Two Strings	3-10
3-5	Four Arguments to the strcspn Function	3-10
3-6	Using the <stdarg.h> Functions and Definitions	3-11
4-1	Suspending and Resuming Programs	4-13
5-1	Creating the Child Process	5-5
5-2	Passing Arguments to the Child Process	5-7
5-3	Checking the Status of Child Processes	5-8
5-4	Communicating Through a Pipe	5-9
6-1	A Curses Program	6-7
6-2	Manipulating Windows	6-8
6-3	Refreshing the Terminal Screen	6-9
6-4	Curses Predefined Variables	6-10
6-5	The Cursor Movement Functions	6-11
6-6	stdscr and Occluding Windows	6-11
7-1	Calculating and Verifying a Tangent Value	7-5
8-1	Allocating and Deallocating Memory for Structures	8-2
9-1	Accessing the User Name	9-3
9-2	Accessing Terminal Information	9-4
9-3	Manipulating the Default Directory	9-4
9-4	Printing the Date and Time	9-5

Figures

1-1	Linking with the HP C RTL on OpenVMS Alpha and Integrity server Systems	1-6
1-2	Unicode Example	1-29
1-3	I/O Interface from C Programs	1-39
1-4	Mapping Standard I/O and UNIX I/O to RMS	1-41
5-1	Communications Links Between Parent and Child Processes	5-2
6-1	An Example of the stdscr Window	6-5
6-2	Displaying Windows and Subwindows	6-6
6-3	Updating the Terminal Screen	6-7
6-4	An Example of the getch Macro	6-13
12-1	POSIX Root Placement	12-14
REF-1	Reading and Writing to a Pipe	REF-465

Tables

1-1	UNIX and OpenVMS File Specification Delimiters	1-8
1-2	Valid and Invalid UNIX and OpenVMS File Specifications	1-8
1-3	Feature Test Macros - Standards	1-11
1-4	C RTL Feature Logical Names	1-20
1-5	Functions with Dual Implementations	1-57
1-6	Socket Routines with Dual Implementations	1-57
1-7	Functions Restricted to 32-Bit Pointers	1-60
1-8	Callbacks that Pass Only 32-Bit Pointers	1-60
2-1	I/O Functions and Macros	2-1
2-2	Optional Characters Between % (or %n\$) and the Input Conversion Specifier	2-8
2-3	Conversion Specifiers for Formatted Input	2-9
2-4	Optional Characters Between % (or %n\$) and the Output Conversion Specifier	2-14
2-5	Conversion Specifiers for Formatted Output	2-16
3-1	Character, String, and Argument-List Functions	3-1
3-2	Character-Classification Functions	3-4
3-3	ASCII Characters and the Character-Classification Functions	3-5
4-1	Error- and Signal-Handling Functions	4-1
4-2	The Error Code Symbolic Values	4-3
4-3	HP C RTL Signals	4-6
4-4	HP C RTL Signals and Corresponding OpenVMS Alpha Exceptions (<i>Alpha only</i>)	4-10
4-5	HP C RTL Signals and Corresponding OpenVMS Integrity server system Exceptions (<i>Integrity servers only</i>)	4-12
5-1	Subprocess Functions	5-1
6-1	Curses Functions and Macros	6-2
6-2	Curses Predefined Variables and #define Constants	6-9
7-1	Math Functions	7-1
8-1	Memory Allocation Functions	8-1
9-1	System Functions	9-1

10-1	Locale Categories	10-3
11-1	Date/Time Functions	11-1
11-2	Time-zone Filename Acronyms	11-4
12-1	Symbolic Link Functions	12-10
REF-1	Interpretation of the mode Argument	REF-7
REF-2	File Protection Values and Their Meanings	REF-58
REF-3	RMS Valid Keywords and Values	REF-88
REF-4	tm Structure	REF-375
REF-5	Optional Characters in strfmon Conversion Specifications	REF-636
REF-6	strfmon Conversion Specifiers	REF-637
REF-7	Optional Elements of strftime Conversion Specifications	REF-640
REF-8	strftime Conversion Specifiers	REF-640
REF-9	strftime Conversion Specifications	REF-654
REF-10	sysconf Argument and Return Values	REF-683
REF-11	Time-Zone Initialization Rules	REF-716
REF-12	The vfork and fork Functions	REF-741
REF-13	Optional Elements of wcsftime Conversion Specifications	REF-781
REF-14	wcsftime Conversion Specifiers	REF-781
A-1	Functions Available on All OpenVMS Systems	A-1
A-2	Functions Added in OpenVMS Version 6.2	A-3
A-3	Functions Added in OpenVMS Version 7.0	A-4
A-4	Functions Added in OpenVMS Alpha Version 7.0	A-5
A-5	Functions Added in OpenVMS Version 7.2	A-6
A-6	Functions Added in OpenVMS Version 7.3	A-6
A-7	Functions Added in OpenVMS Version 7.3-1	A-6
A-8	Functions Added in OpenVMS Version 7.3-2	A-7
A-9	Functions Added in OpenVMS Version 8.2	A-7
A-10	Functions Added in OpenVMS Version 8.3	A-8
A-11	Functions Added in OpenVMS Version 8.4	A-8
B-1	Duplicated Prototypes	B-1

Preface

This manual describes the HP C Run-Time Library (RTL) for the OpenVMS operating system on Integrity servers and Alpha. HP OpenVMS Industry Standard 64 for Integrity servers is the full product name of the OpenVMS operating system on Intel Itanium processors.

This manual provides reference information about the C RTL functions and macros that perform input/output (I/O) operations, character and string manipulation, mathematical operations, error detection, subprocess creation, system access, screen management, and emulation of selected UNIX features. It also notes portability concerns between operating systems, where applicable.

The HP C RTL contains XPG4-compliant internationalization support, providing functions to help you develop software that can run in different languages and cultures.

The complete HP C Run-Time Library (C RTL) needed for use with the HP C and C++ compilers is distributed with the OpenVMS Alpha and OpenVMS Integrity server operating systems in both shared image and object module library form.

This manual no longer documents the socket routines used for writing Internet application programs for the TCP/IP Services protocol. For help on the socket routines, use the following:

```
$ HELP TCPIP_Services Programming_Interfaces Sockets_API
```

Also see the *HP TCP/IP Services for OpenVMS* product documentation.

Intended Audience

This manual is intended for experienced and novice programmers who need reference information on the functions and macros found in the HP C RTL.

Document Structure

This manual has the following chapters, reference section, and appendixes:

- Chapter 1 provides an overview of the HP C RTL.
- Chapter 2 discusses the Standard I/O, Terminal I/O, and UNIX I/O functions.
- Chapter 3 describes the character, string, and argument-list functions.
- Chapter 4 describes the error-handling and signal-handling functions.
- Chapter 5 explains the functions used to create subprocesses.
- Chapter 6 describes the Curses Screen Management functions.
- Chapter 7 discusses the math functions.
- Chapter 8 explains the memory allocation functions.
- Chapter 9 describes the functions used to interact with the operating system.

- Chapter 10 gives an introduction to the facilities provided in the HP C environment on OpenVMS systems for developing international software.
- Chapter 11 describes the date/time functions.
- Chapter 12 describes symbolic links and POSIX pathname support.
- The Reference Section describes all the functions in the HP C RTL.
- Appendix A contains version-dependency tables that list the HP C RTL functions supported on different OpenVMS versions.
- Appendix B lists the function prototypes that are duplicated in more than one header file.

Related Documents

The following documents may be useful when programming in HP C for OpenVMS Systems:

- *HP C User's Guide for OpenVMS Systems*—For C programmers who need information on using HP C for OpenVMS Systems.
- *HP C Language Reference Manual*—Provides language reference information for HP C on HP systems.
- *VAX C to HP C Migration Guide*—To help OpenVMS VAX application programmers migrate from VAX C to HP C.
- *HP C Installation Guide for OpenVMS VAX Systems*—For OpenVMS system programmers who install the HP C software on VAX systems.
- *HP C Installation Guide for OpenVMS Alpha Systems*—For OpenVMS system programmers who install the HP C software on Alpha systems.
- *OpenVMS Master Index*—For programmers who need to work with the VAX and Alpha machine architectures or the OpenVMS system services. This index lists manuals that cover the individual topics concerning access to the OpenVMS operating system.
- *HP TCP/IP Services for OpenVMS Sockets API and System Services Programming*—For information on the socket routines used for writing Internet application programs for the HP TCP/IP Services for OpenVMS product or other implementations of the TCP/IP protocol.
- *HP TCP/IP Services for OpenVMS Guide to IPv6*—For information on HP TCP/IP Services for OpenVMS IPv6 features, how to install and configure IPv6 on your system, changes in the socket application programming interface (API), and how to port your applications to run in an IPv6 environment.
- *X/Open Portability Guide, Issue 3*—Documents what is commonly known as the XPG3 specification.
- *X/Open CAE Specification System Interfaces and Headers, Issue 4*—Documents what is commonly known as the XPG4 specification.
- *X/Open CAE Specification, System Interfaces and Headers, Issue 4, Version 2*—Documents what is commonly known as XPG4 V2.
- *X/Open CAE Specification, System Interfaces and Headers, Issue 5*—Documents what is commonly known as the XPG5 specification.

- *Technical Standard. System Interfaces, Issue 6*—Combined Open Group Technical Standard and IEEE standard. IEEE Std 1003.1-2001, sometimes known as XPG6.
- *Standard for Information Technology - Portable Operating System Interface (POSIX) - Part 1: System Application Program Interface (API)—Amendment 2: Threads Extension [C Language]*—Documents what is also known as POSIX 1003.1c-1995.
- *ISO/IEC 9945-2:1993 - Information Technology - Portable Operating System Interface (POSIX) - Part 2: Shell and Utilities*—Documents what is also known as ISO POSIX-2.
- *ISO/IEC 9945-1:1990 - Information Technology - Portable Operating System Interface (POSIX) - Part 1: System Application Programming Interface (API) (C Language)*—Documents what is also known as ISO POSIX-1.
- *ANSI/ISO/IEC 9899:1999 - Programming Languages - C*—The C99 standard, published by ISO in December, 1999 and adopted as an ANSI standard in April, 2000.
- *ISO/IEC 9899:1990-1994 - Programming Languages - C, Amendment 1: Integrity*—Documents what is also known as ISO C, Amendment 1.
- *ISO/IEC 9899:1990[1992] - Programming Languages - C*—Documents what is also known as ISO C. The normative part is the same as X3.159-1989, *American National Standard for Information Systems - Programming Language C*, also known as ANSI C.

For more information about HP OpenVMS products and services, see:

<http://www.hp.com/go/openvms>

Reader's Comments

HP welcomes your comments on this manual. Please send your comments or suggestions to:

openvmsdoc@hp.com

How to Order Additional Documentation

For information about how to order additional documentation, see:

<http://www.hp.com/go/openvms/doc/order>

Conventions Used in this Document

Convention	Meaning
OpenVMS Integrity servers	The variant of the OpenVMS operating system that runs on the Intel Itanium architecture.
OpenVMS systems	Refers to the OpenVMS operating system on all supported platforms, unless otherwise specified.
<code>Return</code>	The symbol <code>Return</code> represents a single stroke of the Return key on a terminal.

Convention	Meaning
Ctrl/X	The symbol Ctrl/X, where letter X represents a terminal control character, is generated by holding down the Ctrl key while pressing the key of the specified terminal character.
switch statement int data type fprintf function <stdio.h> header file	Monospace type identifies language keywords and the names of HP C functions and header files. Monospace type is also used when referring to a specific variable name used in an example.
<i>arg1</i>	Italic type indicates a placeholder, such as an argument or parameter name, and the introduction of new terms.
\$ RUN CPROG Return	Interactive examples show user input in boldface type.
float x; . . . x = 5; option, . . .	A vertical ellipsis indicates that not all of the text of a program or program output is illustrated. Only relevant material is shown in the example.
[output-source, . . .]	A horizontal ellipsis indicates that additional parameters, options, or values can be entered. A comma that precedes the ellipsis indicates that successive items must be separated by commas.
sc-specifier ::= auto static extern register	Square brackets, in function synopses and a few other contexts, indicate that a syntactic element is optional. Square brackets are not optional, however, when used to delimit a directory name in an OpenVMS file specification or when used to delimit the dimensions of a multidimensional array in HP C source code.
[a b]	In syntax definitions, items appearing on separate lines are mutually exclusive alternatives.
△	Brackets surrounding two or more items separated by a vertical bar () indicate a choice; you must choose one of the two syntactic elements.
	A delta symbol is used in some contexts to indicate a single ASCII space character.

Platform Labels

A *platform* is a combination of operating system and hardware that provides a distinct environment. This manual contains information applicable to the OpenVMS operating system running on VAX, Alpha, and Itanium processors.

The information in this manual applies to all of these processors, except when specifically labeled as follows:

Label	Explanation
<i>(Alpha only)</i>	Specific to an Alpha processor.
<i>(Integrity servers only)</i>	Specific to an Intel Itanium processor running the OpenVMS operating system. On this platform, the product name of the operating system is OpenVMS Integrity servers.

Label	Explanation
<i>(Integrity servers, Alpha)</i>	Specific to Integrity servers and Alpha processors.

New and Changed Features - OpenVMS Version 8.4

The following sections describe the C Run-Time Library (C RTL) enhancements included in OpenVMS Version 8.4. These enhancements provide improved UNIX portability, standards compliance, and the flexibility of additional user-controlled feature selections. New C RTL functions are also included.

Unicode Support

The C RTL now supports Unicode, UTF-8 encoding for filenames given in UNIX style. For example, the following filename is now allowed:

```
/disk/mydir/^U65E5^U672C^U8A9E.txt filename
```

This greatly enhances the UNIX portability of International software that uses UTF-8 encoded filenames.

A new logical, DECC\$FILENAME_ENCODING_UTF8, is provided to enable this feature.

With this logical undefined, the default behavior is to accept filenames as ASCII and Latin-1 format.

This feature works only on ODS-5 disks. To ENABLE this feature ensure that you must define both the DECC\$FILENAME_ENCODING_UTF8 and DECC\$EFS_CHARSET logicals.

Semaphore Support

C RTL supports the following Open Group semaphore control operations in the C RTL:

System V semaphore routines supported:

```
semctl()
semget()
semop()
ftok()
```

POSIX semaphore routines supported:

```
sem_close()
sem_destroy()
sem_getvalue()
sem_init()
sem_open()
sem_post()
sem_timedwait()
sem_trywait()
sem_unlink()
sem_wait()
```

Note

Applicable to all semaphore routines

When the semaphore APIs, `semget` and `sem_open` returns an error status value of 28, which indicates 'no space left on device', you may want to increase the GBLSECTIONS SYSGEN parameter. Semaphores internally use global sections and having huge number of semaphore sets on a

system may result in exhaustion of GBLSECTIONS. As a result, the SYSGEN parameter needs to be increased.

Limitations in System V Semaphores

Following are the limitations in System V semaphores:

- Maximum number of System V semaphore sets allowed in a system is 1024
- Maximum number of System V semaphores allowed within a semaphore set is 1024
- Maximum value of a semaphore is 32767
- Maximum number of System V SEM_UNDO operations allowed in a process is 1024

DECC\$PRINTF_USES_VAX_ROUND Feature Switch

A new feature switch, DECC\$PRINTF_USES_VAX_ROUND, has been added to the C RTL.

With this switch set, the F and E format specifiers of printf use VAX rounding rules for programs compiled with IEEE float.

Symbolic Link and POSIX-Compliant Pathname Support Enhancements

OpenVMS Version 8.3

Enhancements have been made to the Open Group-compliant symbolic-link support and POSIX-compliant pathname support provided in OpenVMS Version 8.3.

These enhancements include:

- Support of logical names in POSIX filenames and symlinks
- Loop detection in RMS directory wildcarding
- Following symlinks in RMS directory wildcard searches
- Redesign of on-disk symlink representation
- Miscellaneous bug fixes

Introduction

The ISO/ANSI C standard defines a library of functions, as well as related types and macros, to be provided with any implementation of ANSI C. The *HP C Language Reference Manual* describes the ANSI-conformant library features common to all HP C platforms. The *HP C Run-Time Library Reference Manual for OpenVMS Systems* provides a more detailed description of these routines and their use in the OpenVMS environment. It also documents additional header files, functions, types, and macros that are available on the OpenVMS system.

All library functions are declared in a *header file*. To make the contents of a header file available to your program, include the header file with an `#include` preprocessor directive. For example:

```
#include <stdlib.h>
```

Each header file contains function prototypes for a set of related functions, and defines any types and macros needed for their use.

To list the header files on OpenVMS Alpha or Integrity server systems, use the following commands:

```
$ LIBRARY/LIST SYS$LIBRARY:SYS$STARLET C.TLB
$ LIBRARY/LIST SYS$LIBRARY:DECC$RTLDEF.TLB
$ DIR SYS$COMMON:[DECC$LIB.REFERENCE.DECC$RTLDEF]*.H;
$ DIR SYS$LIBRARY:*.H;
```

The first command lists the text module form of the header files for the OpenVMS system interfaces. The second lists the text module form of the header files for the HP C language interface. The third lists *.H header files for the HP C language interfaces. The fourth lists *.H header files for layered products and other applications.

Note

The `SYS$COMMON:[DECC$LIB.REFERENCE.DECC$RTLDEF]` directory is only a reference area for your viewing. The compiler still looks in the *.TLB files for `#include` file searches.

However, duplicate files (such as `<stdio.h>`) found in `SYS$LIBRARY` probably support the VAX C Version 3.2 environment and should not be used with HP C.

Function definitions themselves are not included in the header files, but are contained in the HP C Run-Time Library (RTL) shipped with the OpenVMS operating system. Before using the HP C RTL, you must be familiar with the following topics:

- The linking process
- The macro substitution process

- The difference between function definitions and function calls
- The format of valid file specifications
- The OpenVMS-specific methods of input and output (I/O)
- The HP C for OpenVMS extensions and nonstandard features

A knowledge of all these topics is necessary to effectively use the HP C RTL. This chapter shows the connections between these topics and the HP C RTL. Read this chapter before any of the other chapters in this manual.

The primary purpose of the HP C RTL is to provide a means for C programs to perform I/O operations; the C language itself has no facilities for reading and writing information. In addition to I/O support, the HP C RTL also provides a means to perform many other tasks.

Chapters 2 through 11 describe the various tasks supported by the HP C RTL. The Reference Section alphabetically lists and describes all the functions and macros available to perform these tasks.

1.1 Using the HP C Run-Time Library

When working with the HP C RTL, you must be aware of some implementation specifics.

First, if you plan to use HP C RTL functions in your C programs, make sure that a function named `main` or a function that uses the `main_program` option exists in your program. For more information, see the *HP C Language Reference Manual* or the *HP C User's Guide for OpenVMS Systems*.

Second, the HP C RTL functions are executed at run time, but references to these functions are resolved at link time. When you link your program, the OpenVMS linker resolves all references to HP C RTL functions by searching any shareable code libraries or object code libraries specified on the LINK command line.

You can use the HP C RTL as a shareable image or you can use the HP C RTL object libraries.

When you use the HP C RTL as a shareable image, the code for the RTL resides in an image file in `SYS$SHARE` and is shared by all HP C programs. After execution, control returns to your program. This process has a number of advantages:

- You reduce the size of a program's executable image.
- The program's image takes up less disk space.
- The program swaps in and out of memory faster due to decreased size.
- With HP C and HP C++, you no longer need to define an options file when linking your program against the shareable image. Linking against the RTL shareable image is now much simpler than it was with VAX C. In fact, it is the default method of linking to the HP C RTL.

When linking to the HP C RTL, you do not need to define any `LNK$LIBRARY` logicals. In fact, you should deassign `LNK$LIBRARY` because linking with the shareable image is more convenient than linking with the HP C RTL object libraries.

See your OpenVMS, HP C, or HP C++ release notes for any supplemental information about linking with the HP C RTL.

1.2 RTL Linking Options

The following sections describe several ways of linking HP C and HP C++ programs with the HP C RTL on OpenVMS Alpha and Integrity server systems.

1.2.1 Linking with the Shareable Image

Most linking needs should be satisfied by using the HP C RTL shareable image DECC\$SHR.EXE in the ALPHA\$LIBRARY (*Alpha only*) or IA64\$LIBRARY (*Integrity servers only*) directory.

The shareable images VAXCRTL.EXE and VAXCRTLG.EXE do not exist on OpenVMS Alpha and Integrity server systems. The only C RTL shareable image is ALPHA\$LIBRARY:DECC\$SHR.EXE (*Alpha only*) or IA64\$LIBRARY:DECC\$SHR.EXE (*Integrity servers only*), which the linker automatically finds through IMAGELIB.OLB.

The fact that VAXCRTL*.EXE does not exist on Alpha and Integrity server systems has the following ramifications:

- You must change any existing VAX C link procedures to eliminate any references to the VAXCRTL*.EXE images. An explicit reference to DECC\$SHR.EXE is unnecessary because IMAGELIB.OLB is searched automatically by the linker (see the *HP OpenVMS Linker Utility Manual*).
- Because DECC\$SHR.EXE exports only prefixed universal symbols (ones that begin with DECC\$), to successfully link against it make sure you cause prefixing to occur for all HP C RTL entry points that you use.

If you use only the HP C RTL functions defined in the ANSI C Standard, all entry points will be prefixed.

If you use HP C RTL functions not defined in the ANSI C Standard, you must compile in one of two ways to ensure prefixing:

- Compile with the /PREFIX_LIBRARY_ENTRIES=ALL_ENTRIES qualifier.
- Compile with the /STANDARD=VAXC or /STANDARD=COMMON qualifier; you get /PREFIX_LIBRARY_ENTRIES=ALL_ENTRIES as the default.

To link against the shareable image, use the LINK command. For example:

```
§ LINK PROG1
```

The linker automatically searches IMAGELIB.OLB to find DECC\$SHR.EXE, and resolves all C RTL references.

1.2.2 Linking with the Object Libraries (*Alpha only*)

The HP C RTL object libraries on OpenVMS Alpha systems are used solely for linking programs compiled without /PREFIX=ALL. Please note that these object libraries do not exist on OpenVMS Integrity server systems.

On OpenVMS Alpha systems, the HP C RTL provides the following object libraries in the ALPHA\$LIBRARY directory:

- VAXCCURSE.OLB
- VAXCRTLD.OLB
- VAXCRTLT.OLB
- VAXCRTL.OLB

- VAXCRTLX.OLB
- VAXCRTLDX.OLB
- VAXCRTLTX.OLB

The object library VAXCCURSE.OLB, which provides access to the Curses functions, contains unprefixd entry points that vector to the appropriate prefixed entry points.

The object libraries VAXCRTL.OLB, VAXCRTLD.OLB, VAXCRTLTL.OLB, VAXCRTLX.OLB, VAXCRTLDX.OLB, and VAXCRTLTX.OLB also contain unprefixd entry points that vector to the appropriate prefixed entry points, depending on the floating-point type specified by the object library used:

- VAXCRTL.OLB contains all HP C RTL routine name entry points as well as VAX G-floating double-precision, floating-point entry points.
- VAXCRTLD.OLB contains a limited support of VAX D-floating double-precision, floating-point entry points.
- VAXCRTLTL.OLB contains IEEE T-floating double-precision, floating-point entry points.
- VAXCRTLX.OLB contains G_floating support and support for the /L_DOUBLE_SIZE=128 compiler qualifier.
- VAXCRTLDX.OLB contains D_floating support and support for the /L_DOUBLE_SIZE=128 compiler qualifier.
- VAXCRTLTX.OLB contains IEEE T_floating support and support for the /L_DOUBLE_SIZE=128 compiler qualifier.

/L_DOUBLE_SIZE=128 is the default.

On the LINK command, specify only one of the VAXCRTL*.OLB libraries and, if needed, the VAXCCURSE.OLB library.

In the default mode of the compiler (/STANDARD=RELAXED_ANSI89) and also in strict ANSI C mode, all calls to ANSI C standard library routines are automatically prefixed with DECC\$. With the /[NO]PREFIX_LIBRARY_ENTRIES qualifier, you can change this to prefix all HP C RTL names with DECC\$, or to not prefix any HP C RTL names. Other options are also available for this qualifier. See the /[NO]PREFIX_LIBRARY_ENTRIES qualifier in this chapter for more information.

When linking with /NOSYSSHR, if calls to the HP C RTL routines are prefixed with DECC\$, then the modules in STARLET.OLB are the only ones you need to link against. Since STARLET.OLB is automatically searched by the linker (unless the link qualifier /NOSYSLIB is used), all prefixed RTL external names are automatically resolved.

If any calls to the HP C RTL routines are not prefixed, then you need to explicitly link against VAXCRTL.OLB, VAXCRTLD.OLB, VAXCRTLTL.OLB (or VAXCRTLX.OLB, VAXCRTLDX.OLB, or VAXCRTLTX.OLB), or VAXCCURSE.OLB, depending on which floating-point types you need, or if you want Curses functions. If you are linking with /NOSYSSHR, prefixed HP C RTL entry points are resolved in STARLET.OLB. If you are linking with /SYSSHR (the default), prefixed HP C RTL entry points are resolved in DECC\$SHR.EXE.

1.2.3 Examples

The following examples show several different ways you might want to link with the HP C RTL. See Figure 1–1 for a graphical summary of these examples.

1. Most of the time, you just want to link against the shareable image:

```
$ CC/PREFIX_LIBRARY_ENTRIES=ALL_ENTRIES PROG1
$ LINK PROG1
```

The linker automatically searches IMAGELIB.OLB to find DECC\$SHR.EXE.

2. If you want to use just object libraries (to write privileged code or for ease of distribution, for example), use the /NOSYSSHR qualifier of the LINK command:

```
$ CC/PREFIX_LIBRARY_ENTRIES=ALL_ENTRIES PROG1
$ LINK/NOSYSSHR PROG1
```

Prefixed RTL symbol references in the user program are resolved in the HP C RTL object library contained in STARLET.OLB.

Notes

- When linking HP C programs against the HP C RTL object libraries using the /NOSYSSHR qualifier, applications that previously linked without undefined globals may result in undefined globals for the CMA\$TIS symbols. To resolve these undefined globals, add the following line to your link options file:

```
SYS$LIBRARY:STARLET.OLB/LIBRARY/INCLUDE=CMA$TIS
```

- If a program linked with the /NOSYSSHR qualifier makes a call to a routine that resides in a dynamically activated image, and the routine returns a value indicating an unsuccessful status, errno is set to ENOSYS, and vaxc\$errno is set to C\$_NOSYSSHR. The error message corresponding to C\$_NOSYSSHR is "Linking /NOSYSSHR disables dynamic image activation." An example of this situation is a program linked with /NOSYSSHR that makes a call to a socket routine.

-
3. (*Alpha only*). On OpenVMS Alpha systems, when compiling with prefixing disabled, in order to use object libraries that provide alternate implementations of C RTL functions, you need to use the VAXC*.OLB object libraries. In this case, compile and link as follows:

```
$ CC/NOPREFIX_LIBRARY_ENTRIES PROG1
$ LINK PROG1, MYLIB/LIBRARY, ALPHA$LIBRARY:VAXCTRLX.OLB/LIBRARY
```

Unprefixed HP C RTL symbol references in the user program are resolved in MYLIB and in VAXCTRLX.OLB.

Prefixed HP C RTL symbol references in VAXCTRLX.OLB are resolved in DECC\$SHR.EXE through IMAGELIB.OLB.

In this same example, to get IEEE T-floating double-precision floating-point support, you might use the following compile and link commands:

```
$ CC/NOPREFIX_LIBRARY_ENTRIES/FLOAT=IEEE_FLOAT PROG1
$ LINK PROG1, MYLIB/LIBRARY, ALPHA$LIBRARY:VAXCTRLX.OLB/LIBRARY
```

4. (*Alpha only*). Combining examples 2 and 3, you might want to use just the object libraries (for writing privileged code or for ease of distribution) and use an object library that provides C RTL functions. In this case, compile and link as follows:

```

$ CC/NOPREFIX LIBRARY ENTRIES PROG1
$ LINK/NOSYSSHR PROG1, MYLIB/LIBRARY, ALPHA$LIBRARY:VAXCTRLX.OLB/LIBRARY

```

Prefixed HP C RTL symbol references in VAXCTRLX.OLB are resolved in STARLET.OLB.

Figure 1–1 Linking with the HP C RTL on OpenVMS Alpha and Integrity server Systems

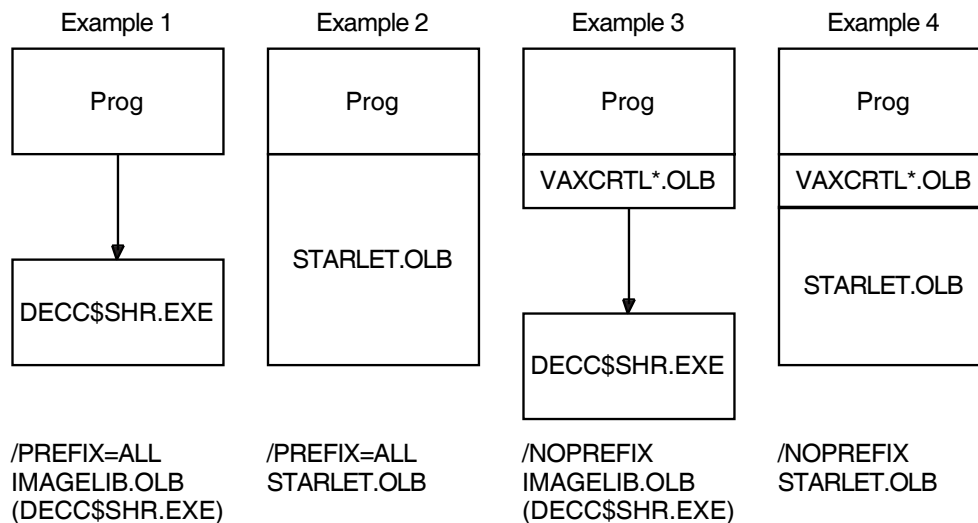

ZK-6045A-GE

1.2.4 DECC\$SHR.EXE Image

OpenVMS installs a new shareable image DECC\$SHR.EXE to implement C RTL functions requiring protected mode. This shareable image is installed on all Alpha and Integrity server processors and is invoked from either the DECC\$SHR.EXE or DECC\$SHR_EV56.EXE shareable image.

1.3 HP C RTL Function Prototypes and Syntax

After learning how to link object modules and include header files, you must learn how to reference HP C functions in your program. The remaining chapters in this manual provide detailed descriptions of the HP C RTL functions.

1.3.1 Function Prototypes

In all chapters, the syntax describing each function follows the standard convention for defining a function. This syntax is called a *function prototype* (or just *prototype*). The prototype is a compact representation of the order of a function's arguments (if any), the types of the arguments, and the type of the value returned by a function. We recommend the use of prototypes.

If the return value of the function cannot be easily represented by a C data-type keyword, look for a description of the return values in the explanatory text. The prototype descriptions provide insight into the functionality of the function. These descriptions may not describe how to call the function in your source code.

For example, consider the prototype for the feof function:

```
#include <stdio.h>
int feof(FILE *file_ptr);
```

This syntax shows the following information:

- The feof prototype resides in the <stdio.h> header file. To use feof, you must include this header file. (Declaring HP C RTL functions yourself is not recommended.)
- The feof function returns a value of data type int.
- There is one argument, *file_ptr*, that is of type "pointer to FILE". FILE is defined in the <stdio.h> header file.

To use feof in a program, include <stdio.h> anywhere before the function call to feof, as in the following example:

```
#include <stdio.h>                /* Include Standard I/O    */
main()
{
    FILE *infile;                /* Define a file pointer */
    .
    .
    while ( ! feof(infile) )     /* Call the function feof */
    {                             /* Until EOF reached      */
        {                         /* Perform file operations */
            .
            .
        }
    }
}
```

1.3.2 Syntax Conventions for Function Prototypes

Since some library functions take a varying number of parameters, syntax descriptions for function prototypes adhere to the following conventions:

- Ellipses (. . .) are used to indicate a varying number of parameters.
- In cases where the type of a parameter may vary, its type is not shown in the syntax.

Consider the printf syntax description:

```
#include <stdio.h>
int printf(const char *format_specification, . . . );
```

The syntax description for printf shows that you can specify one or more optional parameters. The remaining information about printf parameters is in the description of the function.

1.3.3 UNIX Style File Specifications

The HP C RTL functions and macros often manipulate files. One of the major portability problems is the different file specifications used on various systems. Since many C applications are ported to and from UNIX systems, it is convenient for all compilers to be able to read and understand UNIX system file specifications.

The following file specification conversion functions are included in the HP C RTL to assist in porting C programs from UNIX systems to OpenVMS systems:

- decc\$match_wild
- decc\$translate_vms
- decc\$fix_time
- decc\$to_vms
- decc\$from_vms

The advantage of including these file specification conversion functions in the HP C RTL is that you do not have to rewrite C programs containing UNIX system file specifications. HP C can translate most valid UNIX system file specifications to OpenVMS file specifications.

Please note the differences between the UNIX system and OpenVMS file specifications, as well as the method used by the RTL to access files. For example, the RTL accepts a valid OpenVMS specification and most valid UNIX file specifications, but the RTL cannot accept a combination of both. Table 1–1 shows the differences between UNIX system and OpenVMS system file specification delimiters.

Table 1–1 UNIX and OpenVMS File Specification Delimiters

Description	OpenVMS System	UNIX System
Node delimiter	::	!/
Device delimiter	:	/
Directory path delimiter	[]	/
Subdirectory delimiter	[.]	/
File extension delimiter	.	.
File version delimiter	;	Not applicable

For example, Table 1–2 shows the formats of two valid specifications and one invalid specification.

Table 1–2 Valid and Invalid UNIX and OpenVMS File Specifications

System	File Specification	Valid/Invalid
OpenVMS	BEATLE::DBA0:[MCCARTNEY]SONGS.LIS	Valid
UNIX	beatle!/usr1/mccartney/songs.lis	Valid
—	BEATLE::DBA0:[MCCARTNEY.C]/songs.lis	Invalid

When HP C translates file specifications, it looks for both OpenVMS and UNIX system file specifications. Consequently, there may be differences between how HP C translates UNIX system file specifications and how UNIX systems translate the same UNIX file specification.

For example, if the two methods of file specification are combined, as in Table 1–2, HP C RTL can interpret [MCCARTNEY.C]/songs.lis as either [MCCARTNEY]songs.lis or [C]songs.lis. Therefore, when HP C encounters a mixed file specification, an error occurs.

UNIX systems use the same delimiter for the device name, the directory names, and the filename. Due to the ambiguity of UNIX file specifications, HP C may not translate a valid UNIX system file specification according to your expectations.

For instance, the OpenVMS system equivalent of /bin/today can be either [BIN]TODAY or [BIN.TODAY]. HP C can make the correct interpretation only from the files present. If a file specification conforms to UNIX system filename syntax for a single file or directory, it is converted to the equivalent OpenVMS filename if one of the following conditions is true:

- If the specification corresponds to an existing OpenVMS directory, it is converted to that directory name. For example, /dev/dir/sub is converted to DEV:[DIR.SUB] if DEV:[DIR.SUB] exists.
- If the specification corresponds to an existing OpenVMS filename, it is converted to that filename. For example, /dev/dir/file is converted to DEV:[DIR]FILE if DEV:[DIR]FILE exists.
- If the specification corresponds to a nonexistent OpenVMS filename, but the given device and directory exist, it is converted to a filename. For example, /dev/dir/file is converted to DEV:[DIR]FILE if DEV:[DIR] exists.

Note

Beginning with OpenVMS Version 7.3, you can instruct the HP C RTL to interpret the leading part of a UNIX style file specification as either a subdirectory name or a device name.

As with previous releases, the default translation of foo/bar (UNIX style name) is FOO:BAR (OpenVMS style device name).

To request translation of foo/bar (UNIX style name) to [FOO]BAR (OpenVMS style subdirectory name), define the logical name DECC\$DISABLE_TO_VMS_LOGNAME_TRANSLATION to ENABLE. DECC\$DISABLE_TO_VMS_LOGNAME_TRANSLATION is checked only once per image activation, not on a file-by-file basis. Defining this logical affects not only the decc\$to_vms function, but all HP C RTL functions that accept both UNIX style and OpenVMS style filenames as an argument.

In the UNIX system environment, you reference files with a numeric file descriptor. Some file descriptors reference Standard I/O devices; some descriptors reference actual files. If the file descriptor belongs to an unopened file, the HP C RTL opens the file. HP C equates file descriptors with the following OpenVMS logical names:

File Descriptor	OpenVMS Logical	Meaning
0	SYS\$INPUT	Standard input
1	SYS\$OUTPUT	Standard output

File Descriptor	OpenVMS Logical	Meaning
2	SYS\$ERROR	Standard error

1.3.4 Extended File Specifications

The ODS-5 volume structure provides enhanced support for mixed UNIX and OpenVMS style filenames. It supports long filenames, allows the use of a wider range of characters within filenames, and preserves case within filenames. With OpenVMS Alpha Version 7.3-1, the C RTL has greatly improved support of ODS-5 characters, with 250 of the 256 characters supported, as opposed to only 214 supported previously. Also, filenames without file types can now be accessed.

To enable the new support, you must define one or more C RTL feature logical names. These names include the following:

```

DECC$EFS_CHARSET
DECC$DISABLE_TO_VMS_LOGNAME_TRANSLATION
DECC$FILENAME_UNIX_NO_VERSION
DECC$FILENAME_UNIX_REPORT
DECC$READDIR_DROPDOTNOTYPE
DECC$RENAME_NO_INHERIT

```

See Section 1.5 for more information on these and other feature logical names.

1.3.5 Symbolic Links and POSIX Pathnames

OpenVMS provides support for Open Group compliant symbolic links and POSIX pathname processing. See Chapter 12 for more information.

1.4 Feature-Test Macros for Header-File Control

Feature-test macros provide a means for writing portable programs. They ensure that the HP C RTL symbolic names used by a program do not clash with the symbolic names supplied by the implementation.

The HP C RTL header files are coded to support the use of a number of feature-test macros. When an application defines a feature-test macro, the HP C RTL header files supply the symbols and prototypes defined by that feature-test macro and nothing else. If a program does not define such a macro, the HP C RTL header files define symbols without restriction.

The feature-test macros supported by the HP C RTL fall into the following broad categories for controlling the visibility of symbols in header files according to the following:

- Standards
- Multiple-version support
- Compatibility

1.4.1 Standards Macros

The HP C RTL implements parts of the following standards:

- X/Open CAE Specification, System Interfaces and Headers, Issue 4, Version 2, also known as XPG4 V2.
- X/Open CAE Specification, System Interfaces and Headers, Issue 4, also known as XPG4.

- Standard for Information Technology - Portable Operating System Interface (POSIX) - Part 1: System Application Program Interface (API)—Amendment 2: Threads Extension [C Language], also known as POSIX 1003.1c-1995 or IEEE 1003.1c-1995.
- ISO/IEC 9945-2:1993 - Information Technology - Portable Operating System Interface (POSIX) - Part 2: Shell and Utilities, also known as ISO POSIX-2.
- ISO/IEC 9945-1:1990 - Information Technology - Portable Operating System Interface (POSIX) - Part 1: System Application Programming Interface (API) (C Language), also known as ISO POSIX-1.
- ANSI/ISO/IEC 9899:1999 - The C99 standard, published by ISO in December, 1999 and adopted as an ANSI standard in April, 2000.
- ISO/IEC 9899:1990-1994 - Programming Languages - C, Amendment 1: Integrity, also known as ISO C, Amendment 1.
- ISO/IEC 9899:1990 - Programming Languages - C, also known as ISO C. The normative part is the same as X3.159-1989, American National Standard for Information Systems - Programming Language C, also known as ANSI C.

1.4.2 Selecting a Standard

You can define a feature-test macro to select each standard. You can do this either with a `#define` preprocessor directive in your C source before the inclusion of any header file, or with the `/DEFINE` qualifier on the `CC` command line.

Table 1–3 lists and describes the HP C RTL feature-test macros that control standards support.

Table 1–3 Feature Test Macros - Standards

Macro Name	Standard Selected	Other Standards Implied	Description
<code>_XOPEN_SOURCE_EXTENDED</code>	XPG4 V2	XPG4, ISO POSIX-2, ISO POSIX-1, ANSI C	Makes visible XPG4-extended features, including traditional UNIX based interfaces not previously adopted by X/Open.
<code>_XOPEN_SOURCE</code>	XPG4 (X/Open Issue 4)	ISO POSIX-2, ISO POSIX-1, ANSI C	Makes visible XPG4 standard symbols and causes <code>_POSIX_C_SOURCE</code> to be set to 2 if it is not already defined with a value greater than 2. ^{1 2}
<code>_XOPEN_SOURCE=500</code>	X/Open Issue 5	ISO POSIX-2, ISO POSIX-1, ANSI C	Makes visible X/Open Issue 5 standard symbols and causes <code>_POSIX_C_SOURCE</code> to be set to 2 if it is not already defined with a value greater than 2. ^{1 2}

¹Where the ISO C Amendment 1 includes symbols not specified by XPG4, defining `_STDC_VERSION_ == 199409` and `_XOPEN_SOURCE` (or `_XOPEN_SOURCE_EXTENDED`) selects both ISO C and XPG4 APIs. Conflicts that arise when compiling with both XPG4 and ISO C Amendment 1 resolve in favor of ISO C Amendment 1.

²Where XPG4 extends the ISO C Amendment 1, defining `_XOPEN_SOURCE` or `_XOPEN_SOURCE_EXTENDED` selects ISO C APIs as well as the XPG4 extensions available in the header file. This mode of compilation makes XPG4 extensions visible.

(continued on next page)

Table 1–3 (Cont.) Feature Test Macros - Standards

Macro Name	Standard Selected	Other Standards Implied	Description
<code>_XOPEN_SOURCE=600</code>	X/Open Issue 6	ISO POSIX-2, ISO POSIX-1, ANSI C	Makes visible X/Open Issue 6 standard symbols and causes <code>_POSIX_C_SOURCE</code> to be set to 2 if it is not already defined with a value greater than 2. ^{1 2}
<code>_POSIX_C_SOURCE==199506</code>	IEEE 1003.1c-1995	ISO POSIX-2, ISO POSIX-1, ANSI C	Header files defined by ANSI C make visible those symbols required by IEEE 1003.1c-1995.
<code>_POSIX_C_SOURCE==2</code>	ISO POSIX-2	ISO POSIX-1, ANSI C	Header files defined by ANSI C make visible those symbols required by ISO POSIX-2 plus those required by ISO POSIX-1.
<code>_POSIX_C_SOURCE==1</code>	ISO POSIX-1	ANSI C	Header files defined by ANSI C make visible those symbols required by ISO POSIX-1.
<code>__STDC_VERSION__==199409</code>	ISO C amdt 1	ANSI C	Makes ISO C Amendment 1 symbols visible.
<code>_ANSI_C_SOURCE</code>	ANSI C	—	Makes ANSI C standard symbols visible.
<code>__HIDE_FORBIDDEN_NAMES</code>			<p>When defined to the value 1, causes the C RTL headers that are named in the C standard to be configured such that they define only those identifiers that are specified as being defined by those headers under the version of the C standard in effect for the compilation, unless additional features are explicitly requested by other configuration macros (<code>_XOPEN_SOURCE</code>, for example).</p> <p>The C and C++ compilers will predefine this macro when certain language standard conformance features are selected, but the user can override any such predefinition by specifying <code>/UNDEFINE=__HIDE_FORBIDDEN_NAMES</code> on the command line (or using <code>#undef</code> before including any headers). Conversely, the user can explicitly define the macro before including any headers, regardless of the language standard selected for the compiler.</p>

¹Where the ISO C Amendment 1 includes symbols not specified by XPG4, defining `__STDC_VERSION__==199409` and `_XOPEN_SOURCE` (or `_XOPEN_SOURCE_EXTENDED`) selects both ISO C and XPG4 APIs. Conflicts that arise when compiling with both XPG4 and ISO C Amendment 1 resolve in favor of ISO C Amendment 1.

²Where XPG4 extends the ISO C Amendment 1, defining `_XOPEN_SOURCE` or `_XOPEN_SOURCE_EXTENDED` selects ISO C APIs as well as the XPG4 extensions available in the header file. This mode of compilation makes XPG4 extensions visible.

Features not defined by one of the previously named standards are considered HP C extensions and are selected by not defining any standards-related, feature-test macros.

If you do not explicitly define feature test macros to control header file definitions, you implicitly include all defined symbols as well as HP C extensions.

1.4.3 Interactions with the /STANDARD Qualifier

The /STANDARD qualifier selects the dialect of the C language supported.

With the exception of /STANDARD=ANSI89 and /STANDARD=ISOC94, the selection of C dialect and the selection of HP C RTL APIs to use are independent choices. All other values for /STANDARD cause the entire set of APIs to be available, including extensions.

Specifying /STANDARD=ANSI89 restricts the default API set to the ANSI C set. In this case, to select a broader set of APIs, you must also specify the appropriate feature-test macro. To select the ANSI C dialect and all APIs, including extensions, undefine `__HIDE_FORBIDDEN_NAMES` before including any header file.

Compiling with /STANDARD=ISOC94 sets `__STDC_VERSION__` to 199409. Conflicts that arise when compiling with both XPG4 and ISO C Amendment 1 resolve in favor of ISO C Amendment 1. XPG4 extensions to ISO C Amendment 1 are selected by defining `_XOPEN_SOURCE`.

The following examples help clarify these rules:

- The `fdopen` function is an ISO POSIX-1 extension to `<stdio.h>`. Therefore, `<stdio.h>` defines `fdopen` only if one or more of the following is true:
 - The program including it is not compiled in strict ANSI C mode (/STANDARD=ANSI89).
 - `_POSIX_C_SOURCE` is defined as 1 or greater.
 - `_XOPEN_SOURCE` is defined.
 - `_XOPEN_SOURCE_EXTENDED` is defined.
- The `popen` function is an ISO POSIX-2 extension to `<stdio.h>`. Therefore, `<stdio.h>` defines `popen` only if one or more of the following is true:
 - The program including it is not compiled in strict ANSI C mode (/STANDARD=ANSI89).
 - `_POSIX_C_SOURCE` is defined as 2 or greater.
 - `_XOPEN_SOURCE` is defined.
 - `_XOPEN_SOURCE_EXTENDED` is defined.
- The `getw` function is an X/Open extension to `<stdio.h>`. Therefore, `<stdio.h>` defines `getw` only if one or more of the following is true:
 - The program is not compiled in strict ANSI C mode (/STANDARD=ANSI89).
 - `_XOPEN_SOURCE` is defined.
 - `_XOPEN_SOURCE_EXTENDED` is defined.
- The X/Open Extended symbolic constants `_SC_PAGESIZE`, `_SC_PAGE_SIZE`, `_SC_ATEXIT_MAX`, and `_SC_IOV_MAX` were added to `<unistd.h>` to support the `sysconf` function. However, these constants are not defined by `_POSIX_C_SOURCE`.

The `<unistd.h>` header file defines these constants only if a program does not define `_POSIX_C_SOURCE` and does define `_XOPEN_SOURCE_EXTENDED`. If `_POSIX_C_SOURCE` is defined, these constants are not visible in `<unistd.h>`. Note that `_POSIX_C_SOURCE` is defined only for programs compiled in strict ANSI C mode.

- The `fgetname` function is a HP C RTL extension to `<stdio.h>`. Therefore, `<stdio.h>` defines `fgetname` only if the program is not compiled in strict ANSI C mode (`/STANDARD=ANSI89`).
- The macro `_PTHREAD_KEYS_MAX` is defined by POSIX 1003.1c-1995. This macro is made visible in `<limits.h>` when compiling for this standard with `_POSIX_C_SOURCE == 199506` defined, or by default when compiling without any standards-defining, feature-test macros.
- The macro `WCHAR_MAX` defined in `<wchar.h>` is required by ISO C Amendment 1 but not by XPG4. Therefore:
 - Compiling for ISO C Amendment 1 makes this symbol visible, but compiling for XPG4 compliance does not.
 - Compiling for both ISO C Amendment 1 and XPG4 makes this symbol visible.

Similarly, the functions `wcsftime` and `wcstok` in `<wchar.h>` are defined slightly differently by the ISO C Amendment 1 and XPG4:

- Compiling for ISO C Amendment 1 makes the ISO C Amendment 1 prototypes visible.
- Compiling for XPG4 compliance makes the XPG4 prototypes visible.
- Compiling for both ISO C Amendment 1 and XPG4 selects the ISO C prototypes because conflicts resulting from this mode of compilation resolve in favor of ISO C.
- Compiling without any standard selecting feature test macros makes ISO C Amendment 1 features visible.

In this example, compiling with no standard-selecting feature-test macros makes `WCHAR_MAX` and the ISO C Amendment 1 prototypes for `wcsftime` and `wcstok` visible.

- The `wcswidth` and `wcwidth` functions are XPG4 extensions to ISO C Amendment 1. Their prototypes are in `<wchar.h>`.

These symbols are visible if:

- Compiling for XPG4 compliance by defining `_XOPEN_SOURCE` or `_XOPEN_SOURCE_EXTENDED`.
- Compiling for DEC C Version 4.0 compatibility or on pre-OpenVMS Version 7.0 systems.
- Compiling with no standard-selecting feature-test macros.
- Compiling for both ISO C Amendment 1 and XPG4 compliance because these symbols are XPG4 extensions to ISO C Amendment 1.

Compiling for strict ISO C Amendment 1 does not make them visible.

1.4.4 Multiple-Version-Support Macro

By default, the header files enable APIs in the HP C RTL provided by the version of the operating system on which the compilation occurs. This is accomplished by the predefined setting of the `__VMS_VER` macro, as described in the *HP C User's Guide for OpenVMS Systems*. For example, compiling on OpenVMS Version 6.2 causes only HP C RTL APIs from Version 6.2 and earlier to be made available.

Another example of the use of the `__VMS_VER` macro is support for the 64-bit versions of HP C RTL functions available with OpenVMS Alpha Version 7.0 and higher. In all header files, functions that provide 64-bit support are conditionalized so that they are visible only if `__VMS_VER` indicates a version of OpenVMS that is greater than or equal to 7.0.

To target an older version of the operating system, do the following:

1. Define a logical `DECC$SHR` to point to the old version of `DECC$SHR`. The compiler uses a table from `DECC$SHR` to perform routine name prefixing.
2. Define `__VMS_VER` appropriately, either with the `/DEFINE` qualifier or with a combination of the `#undef` and `#define` preprocessor directives. With `/DEFINE`, you may need to disable the warning regarding redefinition of a predefined macro.

Targeting a newer version of the operating system might not always be possible. For some versions, you can expect that the new `DECC$SHR.EXE` will require new features of the operating system that are not present. For such versions, the defining if the logical `DECC$SHR` in Step 1 would cause the compilation to fail.

To override the value of `__VMS_VER`, define `__VMS_VER_OVERRIDE` on the compiler command line. Defining `__VMS_VER_OVERRIDE` without a value sets `__VMS_VER` to the maximum value.

1.4.5 Compatibility Modes

The following predefined macros are used to select header-file compatibility with previous versions of DEC C) or the OpenVMS operating system:

- `_DECC_V4_SOURCE`
- `_VMS_V6_SOURCE`

There are two types of incompatibilities that can be controlled in the header files:

- To conform to standards, some changes are source-code incompatible but binary compatible. To select DEC C Version 4.0 source compatibility, use the `_DECC_V4_SOURCE` macro.
- Other changes to conform to standards introduce a binary or run-time incompatibility.

In general, programs that recompile get new behaviors. In these cases, use the `_VMS_V6_SOURCE` feature test macro to retain previous behaviors.

However, for the `exit`, `kill`, and `wait` functions, the OpenVMS Version 7.0 changes to make these routines ISO POSIX-1 compliant were considered too incompatible to become the default. Therefore, in these cases the default behavior is the same as on pre-OpenVMS Version 7.0 systems. To access the versions of these routines that comply with ISO POSIX-1, use the `_POSIX_EXIT` feature test macro.

The following examples help clarify the use of these macros:

- To conform to the ISO POSIX-1 standard, typedefs for the following have been added to `<types.h>`:

```
dev_t      off_t
gid_t      pid_t
ino_t      size_t
mode_t     ssize_t
nlink_t    uid_t
```

Previous development environments using a version of DEC C earlier than Version 5.2 may have compensated for the lack of these typedefs in `<types.h>` by adding them to another module. If this is the case on your system, then compiling with the `<types.h>` provided with DEC C Version 5.2 might cause compilation errors.

To maintain your current environment and include the DEC C Version 5.2 `<types.h>`, compile with `_DECC_V4_SOURCE` defined. This will omit incompatible references from the DEC C Version 5.2 headers. In `<types.h>`, for example, the previously listed typedefs will not be visible.

- As of OpenVMS Version 7.0, the HP C RTL `getuid` and `geteuid` functions are defined to return an OpenVMS UIC (user identification code) that contains both the group and member portions of the UIC. In previous versions of the DEC C RTL, these functions returned only the member number from the UIC code.

Note that the prototypes for `getuid` and `geteuid` in `<unistd.h>` (as required by the ISO POSIX-1 standard) and in `<unixlib.h>` (for HP C RTL compatibility) have not changed. By default, newly compiled programs that call `getuid` and `geteuid` get the new definitions. That is, these functions will return an OpenVMS UIC.

To let programs retain the pre-OpenVMS Version 7.0 behavior of `getuid` and `geteuid`, compile with the `_VMS_V6_SOURCE` feature-test macro defined.

- As of OpenVMS Version 7.0, the HP C RTL `exit` function is defined with ISO POSIX-1 semantics. As a result, the input status argument to `exit` takes a number between 0 and 255. (Prior to this, `exit` could take an OpenVMS condition code in its status parameter.)

By default, the behavior for `exit` on OpenVMS systems is the same as before: `exit` accepts an OpenVMS condition code. To enable the ISO POSIX-1 compatible `exit` function, compile with the `_POSIX_EXIT` feature-test macro defined.

1.4.6 Curses and Socket Compatibility Macros

The following feature-test macros are used to control the Curses and Socket subsets of the HP C RTL library:

- `_BSD44_CURSES`
This macro selects the Curses package from the 4.4BSD Berkeley Software Distribution.
- `_VMS_CURSES`
This macro selects a Curses package based on the VAX C compiler. This is the default Curses package.
- `_SOCKADDR_LEN`

This macro is used to select 4.4BSD-compatible and XPG4 V2-compatible socket interfaces. These interfaces require support in your underlying TCP/IP software. Contact your TCP/IP vendor to inquire if the version of TCP/IP software you run supports 4.4BSD sockets.

Strict XPG4 V2 compliance requires the 4.4BSD-compatible socket interface. Therefore, if `_XOPEN_SOURCE_EXTENDED` is defined on OpenVMS Version 7.0 or higher, `_SOCKADDR_LEN` is defined to be 1.

The following examples help clarify the use of these macros:

- Symbolic constants like `AE`, `AL`, `AS`, `AM`, `BC`, which represent pointers to termcap fields used by the BSD Curses package, are only visible in `<curses.h>` if `_BSD44_CURSES` is defined.
- The `<socket.h>` header file defines a 4.4BSD `sockaddr` structure only if `_SOCKADDR_LEN` or `_XOPEN_SOURCE_EXTENDED` is defined. Otherwise, `<socket.h>` defines a pre-4.4BSD `sockaddr` structure. If `_SOCKADDR_LEN` is defined and `_XOPEN_SOURCE_EXTENDED` is not defined, the `<socket.h>` header file also defines an `osockaddr` structure, which is a 4.3BSD `sockaddr` structure to be used for compatibility purposes. Since XPG4 V2 does not define an `osockaddr` structure, it is not visible in `_XOPEN_SOURCE_EXTENDED` mode.

1.4.7 2 GB File Size Macro

The C RTL provides support for compiling applications to use file sizes and offsets that are 2 GB and larger. This is accomplished by allowing file offsets of 64-bit integers.

The `fseeko` and `ftello` functions, which have the same behavior as `fseek` and `ftell`, accept or return values of type `off_t`, which allows for a 64-bit variant of `off_t` to be used.

C RTL functions `lseek`, `mmap`, `ftuncate`, `truncate`, `stat`, `fstat`, and `ftw` can also accommodate a 64-bit file offset.

The new 64-bit interfaces can be selected at compile time by defining the `_LARGEFILE` feature macro.

1.4.8 32-Bit UID and GID Macro *(Integrity servers, Alpha)*

The C RTL supports 32-bit User Identification (UID) and Group Identification (GID). When an application is compiled to use 32-bit UID/GID, the UID and GID are derived from the UIC as in previous versions of the operating system.

To compile an application for 16-bit UID/GID support on systems that by default use 32-bit UIDs/GIDs, define the `_DECC_SHORT_GID_T` macro to 1.

Not specifying `_DECC_SHORT_GID_T` provides long (32-bit) UID/GID.

Compiling on older OpenVMS systems where long UID/GID is not supported, or compiling for legacy compatibility (`_DECC_V4_SOURCE` for HP C Version 4 or `_VMS_V6_SOURCE` for OpenVMS Version 6), forces use of short (16-bit) UID/GID.

1.4.9 Standard-Compliant stat Structure *(Integrity servers, Alpha)*

The C RTL supports an X/Open standard-compliant definition of the stat structure and associated definitions. To use these new definitions, applications must compile with the `_USE_STD_STAT` feature-test macro defined. Use of `_USE_STD_STAT` specifies long (32-bit) GIDs.

When compiled with `_USE_STD_STAT`, the stat structure includes these changes:

- Type `ino_t` is defined as an unsigned quadword int. Without `_USE_STD_STAT`, it is an unsigned short.
- Type `dev_t` is defined as a 64-bit integer. Without `_USE_STD_STAT`, it is a 32-bit character pointer.
- Type `off_t` is defined as a 64-bit integer, as if the `_LARGEFILE` macro has been defined. Without `_USE_STD_STAT`, `off_t` is a 32-bit integer.
- Fields `st_dev` and `st_rdev` will have unique values per device. Without `_USE_STD_STAT`, uniqueness is not assured.
- Fields `st_blksize` and `st_blocks` are added. Without `_USE_STD_STAT`, these fields do not exist.

1.4.10 Using Legacy `_toupper` and `_tolower` Behavior *(Integrity servers, Alpha)*

As of OpenVMS Version 8.3, to comply with the C99 ANSI standard and X/Open Specification, the `_tolower` and `_toupper` macros by default do not evaluate their parameter more than once. They simply call their respective `tolower` or `toupper` function. This avoids side effects (such as `++` or function calls) where the user can tell how many times an expression is evaluated.

To retain the older, optimized behavior of the `_tolower` and `_toupper` macros, compile with `/DEFINE=_FAST_TOUPPER`. Then, as in previous releases, these macros optimize the call to avoid the overhead of a runtime call. However, the macro's parameter is evaluated more than once to determine how to calculate the result, possibly creating unwanted side effects.

1.4.11 Using Faster, Inlined Put and Get Functions *(Integrity servers, Alpha)*

Compiling with the `__UNIX_PUTC` macro defined enables an optimization that sets the following I/O functions to use faster, inlined functions:

```
fgetc
fputc
putc
putchar
fgetc_unlocked
fputc_unlocked
putc_unlocked
putchar_unlocked
```

1.4.12 POSIX Style `exit` *(Integrity servers, Alpha)*

The HP C and C++ Version 7.1 and higher compilers have a `/MAIN=POSIX_EXIT` qualifier that defines the `_POSIX_EXIT` macro and causes the main program to call `__posix_exit` instead of `exit` when returning from the main program.

This qualifier should be used with programs ported from UNIX that do not explicitly call `exit` and do not use OpenVMS specific exit codes.

For older compilers, the following sample code can be used to force the existing main module to have a different name so that a simple main program will call it but force the exit status to be through the `__posix_exit` call.

The replacement main function can be in a different module, so that `/DEFINE="main=real_main"` is all that is needed for modifying the build of the existing main function.

```
#define _POSIX_EXIT 1
#include <stdlib.h>
int real_main(int argc, char **argv);
/* Make sure POSIXized exit is used */
int main(int argc, char **argv)
{
    int ret_status;
    ret_status = real_main(argc, argv);
    exit (ret_status);
}
#define main real_main
```

Unless your C program is intentionally using OpenVMS status codes for exit values, it is strongly recommended that both the `_POSIX_EXIT` macro be defined and, if needed, the `/MAIN=POSIX_EXIT` or the alternative main replacement be used so that DCL, BASH, and the accounting file get usable exit values.

1.5 Enabling C RTL Features Using Feature Logical Names

The C RTL provides an extensive list of feature switches that can be set using DECC\$ logical names. These switches affect the behavior of a C application at run time.

The feature switches introduce new behaviors and also preserve old behaviors that have been deprecated.

You enable most features by setting a logical name to `ENABLE` and disable a feature by setting the logical name to `DISABLE`:

```
$ DEFINE DECC$feature ENABLE
$ DEFINE DECC$feature DISABLE
```

Some feature logical names can be set to a numeric value. For example:

```
$ DEFINE DECC$PIPE_BUFFER_SIZE 32768
```

Notes

- Do not set C RTL feature logical names for the system. Set them only for the applications that need them, because other applications including OpenVMS components depend on the default behavior of these logical names.
- Older feature logicals from earlier releases of the C Run-Time Library were documented as supplying "any equivalence string" to enable a feature. While this was true at one time, we now strongly recommend that you use `ENABLE` for setting these feature logicals and `DISABLE` for disabling them. Failure to do so may produce unexpected results.

The reason for this is twofold:

- In previous versions of the C RTL, *any* equivalence string, even `DISABLE`, may have enabled a feature logical.

- In subsequent and current versions of the C RTL, the following equivalence strings will *disable* a feature logical. Do not use them to *enable* a feature logical.

DISABLE
 0 (zero)
 F
 FALSE
 N
 NO

Any other string not on this list will enable a feature logical. The unintentionally misspelled string "DSABLE", for example, will enable a feature logical.

The C RTL also provides several functions to manage feature logicals within your applications:

```

decc$feature_get
decc$feature_get_value
decc$feature_get_index
decc$feature_get_name
decc$feature_set
decc$feature_set_value
decc$feature_show
decc$feature_show_all
  
```

See the reference section for more information on these functions.

Table 1–4 lists the C RTL feature logical names, grouped by the type of features they control.

Table 1–4 C RTL Feature Logical Names

Feature Logical Name	Default
Performance Optimizations	
DECC\$ENABLE_GETENV_CACHE	DISABLE
DECC\$LOCALE_CACHE_SIZE	0
DECC\$TZ_CACHE_SIZE	2
Legacy Behaviors	
DECC\$ALLOW_UNPRIVILEGED_NICE	DISABLE
DECC\$NO_ROOTED_SEARCH_LISTS	DISABLE
DECC\$PRINTF_USES_VAX_ROUND	DISABLE
DECC\$THREAD_DATA_AST_SAFE	DISABLE
DECC\$V62_RECORD_GENERATION	DISABLE
DECC\$WRITE_SHORT_RECORDS	DISABLE
DECC\$XPG4_STRPTIME	DISABLE

(continued on next page)

Table 1–4 (Cont.) C RTL Feature Logical Names

Feature Logical Name	Default
File Attributes	
DECC\$DEFAULT_LRL	32767
DECC\$DEFAULT_UDF_RECORD	DISABLE
DECC\$FIXED_LENGTH_SEEK_TO_EOF	DISABLE
DECC\$ACL_ACCESS_CHECK	DISABLE
Mailboxes	
DECC\$MAILBOX_CTX_STM	DISABLE
Changes for UNIX Conformance	
DECC\$SELECT_IGNORES_INVALID_FD	DISABLE
DECC\$STRTOL_ERANGE	DISABLE
DECC\$VALIDATE_SIGNAL_IN_KILL	DISABLE
General UNIX Enhancements	
DECC\$UNIX_LEVEL	DISABLE
DECC\$ARGV_PARSE_STYLE	DISABLE
DECC\$PIPE_BUFFER_SIZE	512
DECC\$PIPE_BUFFER_QUOTA	512
DECC\$STREAM_PIPE	DISABLE
DECC\$POPEN_NO_CRLF_REC_ATTR	DISABLE
DECC\$STDIO_CTX_EOL	DISABLE
DECC\$USE_RAB64	DISABLE
DECC\$GLOB_UNIX_STYLE	DISABLE
Enhancements for UNIX Style Filenames	
DECC\$DISABLE_TO_VMS_LOGNAME_TRANSLATION	DISABLE
DECC\$EFS_CHARSET	DISABLE
DECC\$ENABLE_TO_VMS_LOGNAME_CACHE	ENABLE
DECC\$FILENAME_ENCODING_UTF8	DISABLE
DECC\$FILENAME_UNIX_NO_VERSION	DISABLE
DECC\$FILENAME_UNIX_REPORT	DISABLE
DECC\$READDIR_DROPDOTNOTYPE	DISABLE
DECC\$RENAME_NO_INHERIT	DISABLE
DECC\$RENAME_ALLOW_DIR	DISABLE

(continued on next page)

Table 1–4 (Cont.) C RTL Feature Logical Names

Feature Logical Name	Default
Enhancements for UNIX Style File Attributes	
DECC\$EFS_FILE_TIMESTAMPS	DISABLE
DECC\$EXEC_FILEATTR_INHERITANCE	DISABLE
DECC\$FILE_OWNER_UNIX	DISABLE
DECC\$FILE_PERMISSION_UNIX	DISABLE
DECC\$FILE_SHARING	DISABLE
UNIX Compliance Mode	
DECC\$DETACHED_CHILD_PROCESS	DISABLE
DECC\$FILENAME_UNIX_ONLY	DISABLE
DECC\$POSIX_STYLE_UID	DISABLE
DECC\$USE_JPI\$_CREATOR	DISABLE
New Behaviors for POSIX Conformance	
DECC\$ALLOW_REMOVE_OPEN_FILES	DISABLE
DECC\$POSIX_SEEK_STREAM_FILE	DISABLE
DECC\$UMASK	RMS default
File-Name Handling	
DECC\$POSIX_COMPLIANT_PATHNAMES	DISABLE
DECC\$DISABLE_POSIX_ROOT	ENABLE
DECC\$EFS_CASE_PRESERVE	DISABLE
DECC\$EFS_CASE_SPECIAL	DISABLE
DECC\$EFS_NO_DOTS_IN_DIRNAME	DISABLE
DECC\$READDIR_KEEPPDOTDIR	DISABLE
DECC\$UNIX_PATH_BEFORE_LOGNAME	DISABLE

An alphabetic listing and description of the C RTL feature logical names follows. Unless otherwise stated, the feature logicals are enabled with **ENABLE** and disabled with **DISABLE**.

DECC\$ACL_ACCESS_CHECK

The **DECC\$ACL_ACCESS_CHECK** feature logical controls the behavior of the access function.

With **DECC\$ACL_ACCESS_CHECK** enabled, the access function checks both UIC protection and OpenVMS Access Control Lists (ACLs).

With **DECC\$ACL_ACCESS_CHECK** disabled, the access function checks only UIC protection.

DECC\$ALLOW_REMOVE_OPEN_FILES

The **DECC\$ALLOW_REMOVE_OPEN_FILES** feature logical controls the behavior of the remove function on open files. Ordinarily, the operation fails. However, POSIX conformance dictates that the operation succeed.

With `DECC$ALLOW_REMOVE_OPEN_FILES` enabled, this POSIX conformant behavior is achieved.

DECC\$ALLOW_UNPRIVILEGED_NICE

With `DECC$ALLOW_UNPRIVILEGED_NICE` enabled, the `nice` function exhibits its legacy behavior of not checking the privilege of the calling process (that is, any user may lower the nice value to increase process priorities). Also, when the caller sets a priority above `MAX_PRIORITY`, the nice value is set to the base priority.

With `DECC$ALLOW_UNPRIVILEGED_NICE` disabled, the `nice` function conforms to the X/Open standard of checking the privilege of the calling process (only users with `ALTPRI` privilege can lower the nice value to increase process priorities), and when the caller sets a priority above `MAX_PRIORITY`, the nice value is set to `MAX_PRIORITY`.

DECC\$ARGV_PARSE_STYLE

With `DECC$ARGV_PARSE_STYLE` enabled, case is preserved in command-line arguments when the process has been set up for extended DCL parsing using `SET PROCESS/PARSE_STYLE=EXTENDED`.

`DECC$ARGV_PARSE_STYLE` must be defined externally as a logical name or set in a function called using the `LIB$INITIALIZE` mechanism because it is evaluated before function `main` is called.

DECC\$DEFAULT_LRL

`DECC$DEFAULT_LRL` specifies the default value for the RMS attribute for the longest record length. The default value 32767 is the largest record size supported by RMS.

Default: 32767

Maximum: 32767

DECC\$DEFAULT_UDF_RECORD

With `DECC$DEFAULT_UDF_RECORD` enabled, file access mode defaults to `RECORD` instead of `STREAM` mode for all files except `STREAMLF`.

DECC\$DETACHED_CHILD_PROCESS

With `DECC$DETACHED_CHILD_PROCESS` enabled, child processes created using `vfork` and `exec` are created as detached processes instead of subprocesses.

This feature has only limited support. In some cases the console cannot be shared between the parent process and the detached process, which can cause `exec` to fail.

DECC\$DISABLE_POSIX_ROOT

With `DECC$DISABLE_POSIX_ROOT` enabled, support for the POSIX root directory defined by `SYS$POSIX_ROOT` is disabled.

With `DECC$DISABLE_POSIX_ROOT` disabled, the `SYS$POSIX_ROOT` logical name is interpreted as the equivalent of the file path `"/`". If a UNIX path starting with a slash (`/`) is given and the value after the leading slash cannot be translated as a logical name, `SYS$POSIX_ROOT` is used as the parent directory for the specified UNIX file path.

The C RTL supports a UNIX style root that behaves like a real directory. This allows such actions as:

```
% cd /
% mkdir /dirname
% tar -xvf tarfile.tar /dirname
% ls /
```

Previously, the C RTL did not recognize "/" as a directory name. The normal processing for a file path starting with "/" was to interpret the first element as a logical name or device name. If this failed, there was special processing for the name /dev/null and names starting with /bin and /tmp:

```
/dev/null      NLA0:
/bin           SYS$SYSTEM:
/tmp          SYS$SCRATCH:
```

These behaviors are retained for compatibility purposes. In addition, support has been added to the C RTL for the logical name SYS\$POSIX_ROOT as an equivalent to "/".

To enable this feature for use by the C RTL, define SYS\$POSIX_ROOT as a concealed logical name. For example:

```
$ DEFINE/TRANSLATION=(CONCEALED,TERMINAL) SYS$POSIX_ROOT "$1$DKA0:[SYS0.abc.]"
```

To disable this feature:

```
$ DEFINE DECC$DISABLE_POSIX_ROOT DISABLE
```

Enabling SYS\$POSIX_ROOT results in the following behavior:

- If the existing translation of a UNIX path starting with "/" fails and SYS\$POSIX_ROOT is defined, the name is interpreted as if it starts with /sys\$posix_root.
- When converting from an OpenVMS to a UNIX style filename, and the OpenVMS name starts with "SYS\$POSIX_ROOT:", then the "SYS\$POSIX_ROOT:" is removed. For example, SYS\$POSIX_ROOT:[dirname] becomes /dirname. If the resulting name could be interpreted as a logical name or one of the special cases previously listed, the result is ./dirname instead of /dirname.

DECC\$DISABLE_TO_VMS_LOGNAME_TRANSLATION

With DECC\$DISABLE_TO_VMS_LOGNAME_TRANSLATION enabled, the conversion routine decc\$to_vms will only treat the first element of a UNIX style name as a logical name if there is a leading slash (/).

DECC\$EFS_CASE_PRESERVE

With DECC\$EFS_CASE_PRESERVE enabled, case is preserved for filenames on ODS-5 disks.

With DECC\$EFS_CASE_PRESERVE disabled, UNIX style filenames are always reported in lowercase.

However, note that enabling DECC\$EFS_CASE_SPECIAL overrides the setting for DECC\$EFS_CASE_PRESERVE.

DECC\$EFS_CASE_SPECIAL

With DECC\$EFS_CASE_SPECIAL enabled, case is preserved only for filenames containing lowercase. If an element of a filename contains all uppercase letters, it is reported in all lowercase in UNIX style.

When enabled, `DECC$EFS_CASE_SPECIAL` overrides the value of `DECC$EFS_CASE_PRESERVE`.

DECC\$EFS_CHARSET

With `DECC$EFS_CHARSET` enabled, UNIX names can contain ODS-5 extended characters. Support includes multiple dots and all ASCII characters in the range 0 to 255, except the following:

```
<NUL>
/      *
"      ?
```

Unless `DECC$FILENAME_UNIX_ONLY` is enabled, some characters can be interpreted as OpenVMS characters depending on context. They are:

```
:      ^
[      ;
<
```

`DECC$EFS_CHARSET` might be necessary for existing applications that make assumptions about filenames based on the presence of certain characters, because the following nonstandard and undocumented C RTL extensions do not work when EFS extended character-set support is enabled:

- `$HOME` is interpreted as the user's login directory
With `DECC$EFS_CHARSET` enabled, `$HOME` is treated literally and may be in an OpenVMS or UNIX style filename.
- `~name` is interpreted as the login directory for user name
With `DECC$EFS_CHARSET` enabled, `~name` is treated literally and can be in an OpenVMS or UNIX style filename.
- Wild card regular expressions in the form `[a-z]`
With `DECC$EFS_CHARSET` enabled, square brackets are acceptable in OpenVMS and UNIX style filenames. For instance, in a function such as `open, abc[a-z]ef.txt` is interpreted as a UNIX style name equivalent to the OpenVMS style name `abc^[a-z^]ef.txt`, and `[a-z]bc` is interpreted as an OpenVMS style name equivalent to the UNIX style name `/sys$disk/a-z/bc`.

With `DECC$EFS_CHARSET` enabled, the following encoding for EFS extended characters is supported when converting from an OpenVMS style filename to a UNIX style filename:

- All ODS-2 compatible names
- All encoding for 8-bit characters, either as single byte or using two-digit hexadecimal form `^ab`. In a UNIX path these are always represented as a single byte.
- Encoding for DEL (`^7F`)
- The following characters when preceded by a caret:
space ! , _ & ' () + @ { } ; # [] % ^ = \$ - ~ .
- The following characters when not preceded by a caret:
\$ - ~ .

- The implementation supports the conversion from OpenVMS to UNIX needed for functions `readdir`, `ftw`, `getname`, `fgetname`, `getcwd`, and others.

Note

There are some special cases in C RTL filename processing. For example:

- Pathnames ending in `^.dir` are treated as directories, and when translated, these characters are truncated from the string.
- Pathnames beginning with `^/` treat the next token as a logical name or a directory from the root.

The following sample program shows these nuances:

```
#include <stdio.h>
#include <dirent.h>
#include <unixlib.h>
#include <string.h>
main()
{
    char adir[80];
    DIR *dir;
    struct dirent *dp;
    int decc_feature_efs_charset_index = 0;
    int decc_feature_efs_charset_default_val = 0;

    if (
        ( (decc_feature_efs_charset_index =
          decc$feature_get_index("DECC$EFS_CHARSET")) == -1 )
        ||
        ( (decc_feature_efs_charset_default_val =
          decc$feature_get_value(decc_feature_efs_charset_index, 0)) == -1 )
        ||
        ( (decc$feature_set_value(decc_feature_efs_charset_index, 1, TRUE) == -1) )
    )
    {
        printf("Error setting up DECC$EFS_CHARSET macro\n");
    }

    strcpy(adir, "SYS$SYSDEVICE:[SSHTEST.TEST.a^,test^.dir^;22]");
    printf("\n\nFor %s\n", adir);
    mrb: dir = opendir(adir);
    if(dir)
    {
        do
        {
            dp = readdir(dir);
            if(dp->d_name) printf("%s\n", dp->d_name);
        } while (dp);
    }

    closedir(dir);

    strcpy(adir, "SYS$SYSDEVICE:[SSHTEST.TEST.a^,test^.dir]");
    printf("\n\nFor %s\n", adir);
    dir = opendir(adir);
    if(dir)
    {
        do
        {
            dp = readdir(dir);
            if(dp->d_name) printf("%s\n", dp->d_name);
        } while (dp);
    }

    closedir(dir);
}
```



```

strcpy(adir, "SYS$SYSDEVICE:[SSHTEST.TEST.a^\\test]");
printf("\n\nFor %s\n", adir);
dir = opendir(adir);
if(dir)
{
do
{
dp = readdir(dir);
if(dp->d_name) printf("%s\n", dp->d_name);
} while (dp);
}

strcpy(adir, "SYS$SYSDEVICE:[SSHTEST.TEST.copies]");
printf("\n\nFor %s\n", adir);
dir = opendir(adir);
if(dir)
{
do
{
dp = readdir(dir);
if(dp->d_name) printf("%s\n", dp->d_name);
} while (dp);
}

closedir(dir);

strcpy(adir, "/SYS$SYSDEVICE/SSHTEST/TEST/copies");
printf("\n\nFor %s\n", adir);
dir = opendir(adir);
if(dir)
{
do
{
dp = readdir(dir);
if(dp->d_name) printf("%s\n", dp->d_name);
} while (dp);
}

closedir(dir);
}

```

DECC\$EFS_FILE_TIMESTAMPS

With DECC\$EFS_FILE_TIMESTAMPS enabled, stat and fstat report new ODS-5 access time (st_atime), attribute revision time (st_ctime) and modification time (st_mtime) for files on ODS-5 volumes that have the extended file times enabled using SET VOLUME/VOLUME=ACCESS_DATES.

If DECC\$EFS_FILE_TIMESTAMPS is disabled, or the volume is not ODS-5, or the volume does not have support for these additional times enabled, st_ctime continues to be the file creation time and st_atime the same as the st_mtime.

The utime and utimes functions support these ODS-5 times in the same way as stat.

DECC\$EFS_NO_DOTS_IN_DIRNAME

With support for extended characters in filenames for ODS-5, a name such as NAME.EXT can be interpreted as NAME.EXT.DIR. Determining if directory [.name^.ext] exists adds overhead to UNIX name translation when support for extended character support in UNIX filenames is enabled.

Enabling the `DECC$EFS_NO_DOTS_IN_DIRNAME` feature logical suppresses the interpretation of a filename containing dots as a directory name. With this logical enabled, `NAME.EXT` is assumed to be a filename; no check is made for directory `[.name^.ext]`.

DECC\$ENABLE_GETENV_CACHE

The C RTL supplements the list of environment variables in the `environ` table with all logical names and DCL symbols available to the process.

By default, whenever `getenv` is called for a name not in the `environ` table, an attempt is made to resolve this as a logical name and, if this fails, as a DCL symbol.

With `DECC$ENABLE_GETENV_CACHE` enabled, once a logical name or DCL name has been successfully translated, its value is stored in a cache. When the same name is requested in a future call to `getenv`, the value is returned from the cache instead of reevaluating the logical name or DCL symbol.

DECC\$ENABLE_TO_VMS_LOGNAME_CACHE

Use the `DECC$ENABLE_TO_VMS_LOGNAME_CACHE` to improve the performance of UNIX name translation. The value is the life of each cache entry in seconds. The equivalence string `ENABLE` is evaluated as 1 second.

Define `DECC$ENABLE_TO_VMS_LOGNAME_CACHE` to 1 to enable the cache with a 1-second life for each entry.

Define `DECC$ENABLE_TO_VMS_LOGNAME_CACHE` to 2 to enable the cache with a 2-second life for each entry.

Define `DECC$ENABLE_TO_VMS_LOGNAME_CACHE` to -1 to enable the cache without a cache entry expiration.

DECC\$EXEC_FILEATTR_INHERITANCE

The `DECC$EXEC_FILEATTR_INHERITANCE` feature logical affects child processes that are C programs.

For versions of OpenVMS before Version 7.3-2, `DECC$EXEC_FILEATTR_INHERITANCE` is either enabled or disabled:

- With `DECC$EXEC_FILEATTR_INHERITANCE` enabled, the current file pointer and the file open mode is passed to the child process in `exec` calls.
- With this logical name disabled, the child process does not inherit append mode or the file position.

For OpenVMS Version 7.3-2 and higher, `DECC$EXEC_FILEATTR_INHERITANCE` can be defined to 1 or 2, or be disabled:

- With `DECC$EXEC_FILEATTR_INHERITANCE` defined to 1, a child process inherits file positioning for all file access modes except `append`.
- With `DECC$EXEC_FILEATTR_INHERITANCE` defined to 2, a child process inherits file positioning for all file access modes including `append`.
- With `DECC$EXEC_FILEATTR_INHERITANCE` disabled, a child process does not inherit the file position for any access modes.

DECC\$FILENAME_ENCODING_UTF8

C RTL routines that deal with filenames now support filenames in UTF-8 encoding when given in UNIX style.

For example, on an ODS-5 disk the OpenVMS DIRECTORY command supports a filename with the following characters:

```
disk:[mydir]^U65E5^U672C^U8A9E.txt
```

This filename contains three UCS-2 characters (call them xxx, yyy, and zzz for typographical purposes) meaning "day", "origin", and "language", respectively.

With UTF-8 support enabled, a C program can now read the filename from the VMS directory and use that filename as an UTF-8 encoded string.

For example, opendir("/disk/mydir") followed by a readdir will place the following into the *d_name* field of the supplied dirent structure:

```
"\xE6\x97\xA5\xE6\x9C\xAC\xE8\xAA\x9E.txt"
```

One of the following calls can then open this file:

```
open("/disk/mydir/\xE6\x97\xA5\xE6\x9C\xAC\xE8\xAA\x9E.txt", O_RDWR, 0)
open("/disk/mydir/xxxxxyzzz.txt", O_RDWR, 0)
```

The "\xE6\x97\xA5" above is the byte stream E697A5, which represents the xxx character in UTF-8 encoding. See the following example, where the actual characters comprising the filename are shown:

Figure 1–2 Unicode Example

```
$ DIR $1$DKA100:[ENCODE].TXT
Directory $1$DKA100:[ENCODE]

UTF8.TXT;1 ^U65E5^U672C^U8A9A.TXT;1

Total of 2 files.
$ MCR JSYS$CONTROL SET RMS/FILE=SDEC
$ DIR $1$DKA100:[ENCODE].TXT

Directory $1$DKA100:[ENCODE]

UTF8.TXT;1 日本語.TXT;1

Total of 2 files
$
```

This feature enhances the UNIX portability of international software that uses UTF-8 encoded filenames.

The DECC\$FILENAME_ENCODING_UTF8 feature logical controls whether or not the C RTL allows and correctly interprets Unicode UTF-8 encoding for filenames given in UNIX style.

This logical is undefined by default, and the C RTL behavior is to accept filenames as ASCII and Latin-1 format.

This feature works only on ODS-5 disks. Therefore, to enable Unicode UTF-8 encoding, you must define both the DECC\$FILENAME_ENCODING_UTF8 and DECC\$EFS_CHARSET logicals to ENABLE.

DECC\$FILENAME_UNIX_ONLY

With DECC\$FILENAME_UNIX_ONLY enabled, filenames are never interpreted as OpenVMS style names. This prevents any interpretation of the following as OpenVMS special characters:

```
: [ ^
```

DECC\$FILENAME_UNIX_NO_VERSION

With DECC\$FILENAME_UNIX_NO_VERSION enabled, OpenVMS version numbers are not supported in UNIX style filenames.

With DECC\$FILENAME_UNIX_NO_VERSION disabled, in UNIX style names, version numbers are reported preceded by a period (.).

DECC\$FILENAME_UNIX_REPORT

With DECC\$FILENAME_UNIX_REPORT enabled, all filenames are reported in UNIX style unless the caller specifically selects OpenVMS style. This applies to getpwnam, getpwuid, argv[0], getname, fgetname, and tempnam.

With DECC\$FILENAME_UNIX_REPORT disabled, unless specified in the function call, filenames are reported in OpenVMS style.

DECC\$FILE_PERMISSION_UNIX

With DECC\$FILE_PERMISSION_UNIX enabled, the file permissions for new files and directories are set according to the file creation mode and umask. This includes mode 0777. When an earlier version of the file exists, the file permissions for the new file are inherited from the earlier version. This mode sets DELETE permission for a new directory when WRITE permission is enabled.

With DECC\$FILE_PERMISSION_UNIX disabled, modes 0 and 0777 indicate using RMS default protection or protection from the previous version of the file. Permissions for new directories also follow OpenVMS rules, including disabling DELETE permissions.

DECC\$FILE_SHARING

With DECC\$FILE_SHARING enabled, all files are opened with full sharing enabled (FAB\$M_DEL | FAB\$M_GET | FAB\$M_PUT | FAB\$M_UPD). This is set as a logical OR with any sharing mode specified by the caller.

DECC\$FIXED_LENGTH_SEEK_TO_EOF

With DECC\$FIXED_LENGTH_SEEK_TO_EOF enabled, lseek, fseeko, and fseek with the *direction* parameter set to SEEK_END will position relative to the last byte in the file for files with fixed-length records.

With DECC\$FIXED_LENGTH_SEEK_TO_EOF disabled, lseek, fseek, and fseeko when called with SEEK_EOF on files with fixed-length records, will position relative to the end of the last record in the file.

DECC\$GLOB_UNIX_STYLE

Enabling DECC\$GLOB_UNIX_STYLE selects the UNIX mode of the glob function, which uses UNIX style filenames and wildcards instead of OpenVMS style filenames and wildcards.

DECC\$LOCALE_CACHE_SIZE

DECC\$LOCALE_CACHE_SIZE defines how much memory, in bytes, to allocate for caching locale data. The default value is 0, which disables the locale cache.

Default: 0

Maximum: 2147483647

DECC\$MAILBOX_CTX_STM

By default, an open on a local mailbox that is not a pipe treats mailbox records as having a record attribute of FAB\$M_CR.

With `DECC$MAILBOX_CTX_STM` enabled, the record attribute `FAB$M_CR` is not set.

DECC\$NO_ROOTED_SEARCH_LISTS

When the `decc$to_vms` function evaluates a UNIX style path string, if it determines the first element to be a logical name, then:

- For rooted logicals or devices, it appends `":[000000]"` to the logical name.
For example, if `log1` is a rooted logical (`$DEFINE LOG1 [DIR_NAME.]`) then `/log1/filename.ext` translates to `LOG1:[000000]FILENAME.EXT`.
- For nonrooted logicals, it appends just a colon (`:`) to the logical name.
For example, if `log2` is a nonrooted logical (`$ DEFINE LOG2 [DIR_NAME]`), then `/log2/filename.ext` translates to `LOG2:FILENAME.EXT`.
- If the first element is a search-list logical, the translation proceeds by evaluating the first element in the search list, and translating the path as previously described.

The preceding three cases lead to predictable, expected results.

In the case where the first element is a search list that consists of a mixture of rooted and nonrooted logicals, translating paths as described previously can lead to different behavior from that of older versions of OpenVMS (before OpenVMS Version 7.3-1):

- Before OpenVMS Version 7.3-1, regardless of the contents of the logical, the `decc$to_vms` function appended only a colon (`:`). For search lists that consisted of a mixture of rooted and nonrooted logicals, this resulted in certain expected behaviors.
- For OpenVMS Version 7.3-1 and later, if the first element of the mixed search list is a rooted logical, then `decc$to_vms` appends `":[000000]"` to the logical name, resulting in different behavior from that of OpenVMS releases prior to Version 7.3-1.

`DECC$NO_ROOTED_SEARCH_LISTS` controls how the `decc$to_vms` function resolves search-list logicals and provides a means to restore the OpenVMS behavior prior to Version 7.3-1.

With `DECC$NO_ROOTED_SEARCH_LISTS` enabled:

- If a logical is detected in a file specification, and it is a search list, then a colon (`:`) is appended when forming the OpenVMS file specification.
- If it is not a search list, the behavior is the same as with `DECC$NO_ROOTED_SEARCH_LISTS` disabled.

Enabling this feature logical provides the pre-Version 7.3-1 behavior for search list logicals.

With `DECC$NO_ROOTED_SEARCH_LISTS` disabled:

- If a logical is detected in a file specification, and it is a rooted logical (or a search list whose first element is a rooted logical), then `":[000000]"` is appended when forming the OpenVMS file specification.
- If it is a nonrooted logical (or a search list whose first element is a nonrooted logical), then just a colon (`:`) is appended.

Disabling this feature logical provides the behavior for OpenVMS Version 7.3-1 and later.

DECC\$PIPE_BUFFER_QUOTA

OpenVMS Version 7.3-2 adds an optional fourth argument of type `int` to the pipe function to specify the buffer quota of the pipe's mailbox. In previous OpenVMS versions, the buffer quota was equal to the buffer size.

`DECC$PIPE_BUFFER_QUOTA` lets you specify a buffer quota to use for the pipe function if the optional fourth argument of that function is omitted.

If the optional pipe fourth argument is omitted and `DECC$PIPE_BUFFER_QUOTA` is not defined, then the buffer quota defaults to the buffer size, as before.

Default: 512

Minimum: 512

Maximum: 2147483647

DECC\$PIPE_BUFFER_SIZE

The system default buffer size of 512 bytes for pipe write operations can limit performance and generate extra line feeds when handling messages longer than 512 bytes.

`DECC$PIPE_BUFFER_SIZE` allows a larger buffer size to be used for pipe functions such as `pipe` and `popen`. A value of 512 to 65535 bytes can be specified.

If `DECC$PIPE_BUFFER_SIZE` is not specified, the default buffer size 512 is used.

Default: 512

Minimum: 512

Maximum: 65535

DECC\$POPEN_NO_CRLF_REC_ATTR

With `DECC$POPEN_NO_CRLF_REC_ATTR` disabled, a pipe opened with the `popen` function has its record attributes set to CR/LF carriage control (`fab$b_rat` | = `FAB$M_CR`). This is the default behavior.

With `DECC$POPEN_NO_CRLF_REC_ATTR` enabled, CR/LF carriage control is prevented from being added to the pipe records. This is compatible with UNIX behavior, but be aware that enabling this feature might result in undesired behavior from other functions, such as `gets`, that rely on the carriage-return character.

DECC\$POSIX_COMPLIANT_PATHNAMES

With `DECC$POSIX_COMPLIANT_PATHNAMES` enabled, an application is allowed to present POSIX-compliant pathnames to any C RTL function that accepts a pathname.

By default `DECC$POSIX_COMPLIANT_PATHNAMES` is disabled, and the usual C RTL behavior prevails. This disabled mode includes interpretation of pathnames as UNIX style specifications and uses rules that are different and unrelated to POSIX-compliant pathname processing.

To enable `DECC$POSIX_COMPLIANT_PATHNAMES`, set it to one of the following values:

- 1 All pathnames are designated as POSIX style.

- 2 Pathnames that end in ":" or contain any of the bracket characters "[]<>", and that can be successfully parsed by the SYS\$FILESCAN service, are designated as OpenVMS style. Otherwise, they are designated as POSIX style.
- 3 The pathnames "." and "..", or pathnames that contain "/" are designated as POSIX style. Otherwise, they are designated as OpenVMS style.
- 4 All pathnames are designated as OpenVMS style.

See Section 12.3.1 for more information.

DECC\$POSIX_SEEK_STREAM_FILE

With DECC\$POSIX_SEEK_STREAM_FILE enabled, positioning beyond end-of-file on STREAM files does not write to the file until the next write. If the write is beyond the current end-of-file, this positions beyond the old end-of-file, and the start position for the write is filled with zeros.

With DECC\$POSIX_SEEK_STREAM_FILE disabled, positioning beyond end-of-file will immediately write zeros to the file from the current end-of-file to the new position.

DECC\$POSIX_STYLE_UID

With DECC\$POSIX_STYLE_UID enabled, 32-bit UIDs and GIDs are interpreted as POSIX style identifiers.

With this logical name disabled, UIDs and GIDs are derived from the process UIC.

This feature is only available on OpenVMS systems providing POSIX style UID and GID support.

DECC\$PRINTF_USES_VAX_ROUND

With DECC\$PRINTF_USES_VAX_ROUND enabled, the F and E format specifiers of printf use VAX rounding rules for programs compiled with IEEE float.

DECC\$READDIR_DROPDOTNOTYPE

With DECC\$READDIR_DROPDOTNOTYPE enabled, readdir when reporting files in UNIX style only reports the trailing period (.) for files with no file type when the filename contains a period.

With this logical name disabled, all files without a file type are reported with a trailing period.

DECC\$READDIR_KEEPPDOTDIR

The default behavior when reporting files in UNIX style from readdir is to report directories without a file type.

With DECC\$READDIR_KEEPPDOTDIR enabled, directories are reported in UNIX style with a file type of ".DIR".

DECC\$RENAME_NO_INHERIT

DECC\$RENAME_NO_INHERIT provides more UNIX compliant behavior in the rename function. With DECC\$RENAME_NO_INHERIT enabled, the following behaviors are enforced:

- If the *old* argument points to the pathname of a file that is not a directory, the *new* argument will not point to the pathname of a directory.
- The new argument cannot point to a directory that exists.
- If the *old* argument points to the pathname of a directory, the *new* argument will not point to the pathname of a file that is not a directory.

- The new name for the file does not inherit anything from the old name. The new name must be specified completely. For example:

Renaming "A.A" to "B" yields "B"

With this logical name disabled, you get the expected OpenVMS behavior. For example:

Renaming "A.A" to "B" yields "B.A"

DECC\$RENAME_ALLOW_DIR

Enabling DECC\$RENAME_ALLOW_DIR restores the prior OpenVMS behavior of the rename function by allowing conversion to a directory specification when the second argument is an ambiguous file specification passed as a logical name. The ambiguity is whether the logical name is a UNIX or OpenVMS file specification. Consider the following example with DECC\$RENAME_ALLOW_DIR enabled:

```
rename("file.ext", "logical_name") /* where logical_name = dev:[dir.subdir] */
                                     /* and :[dir.subdir] exists.          */
```

This results in:

```
dev:[dir.subdir]file.ext
```

This example renames a file from one directory into another directory, which is the same behavior as in legacy versions of OpenVMS (versions before 7.3-1). Also in this example, if dev:[dir.subdir] does not exist, rename returns an error.

Disabling DECC\$RENAME_ALLOW_DIR provides a more UNIX compliant conversion of the "logical_name" argument of rename. Consider the following example with DECC\$RENAME_ALLOW_DIR disabled:

```
rename("file.ext", "logical_name") /* where logical_name = dev:[dir.subdir] */
```

This results in:

```
dev:[dir]subdir.ext
```

This example renames the file using the subdir part of the "logical_name" argument as the new filename because on UNIX systems, renaming a file to a directory is not allowed. So rename internally converts the "logical_name" to a filename, and dev:[dir]subdir is the most reasonable conversion it can perform.

This new feature switch has a side effect of causing rename to a directory to take precedence over rename to a file. Consider this example:

```
rename ( "file1.ext", "dir2" )      /* dir2 is not a logical */
```

With DECC\$RENAME_ALLOW_DIR disabled, this example results in dir2.ext, regardless of whether or not subdirectory [.dir2] exists.

With DECC\$RENAME_ALLOW_DIR enabled, this example results in dir2.ext only if subdirectory [.dir2] does not exist. If subdirectory [.dir2] does exist, the result is [.dir2]file1.ext.

Note

If DECC\$RENAME_NO_INHERIT is enabled, UNIX compliant behavior is expected, so DECC\$RENAME_ALLOW_DIR is ignored, and renaming a file to a directory is not allowed.

DECC\$SELECT_IGNORES_INVALID_FD

With DECC\$SELECT_IGNORES_INVALID_FD enabled, select fails with errno set to EBADF when an invalid file descriptor is specified in one of the descriptor sets.

With DECC\$SELECT_IGNORES_INVALID_FD disabled, select ignores invalid file descriptors.

DECC\$STDIO_CTX_EOL

With DECC\$STDIO_CTX_EOL enabled, writing to stdout and stderr for stream access is deferred until a terminator is seen or the buffer is full.

With DECC\$STDIO_CTX_EOL disabled, each fwrite generates a separate write, which for mailbox and record files generates a separate record.

DECC\$STREAM_PIPE

With DECC\$STREAM_PIPE enabled, the C RTL pipe function uses the more UNIX compatible stream I/O.

With DECC\$STREAM_PIPE disabled, pipe uses the OpenVMS legacy record I/O. This is the default.

DECC\$STRTOL_ERANGE

With DECC\$STRTOL_ERANGE enabled, the strtol behavior for an ERANGE error is corrected to consume all remaining digits in the string.

With DECC\$STRTOL_ERANGE disabled, the legacy behavior of leaving the pointer at the failing digit is preserved.

DECC\$THREAD_DATA_AST_SAFE

The C RTL has a mode that allocates storage for thread-specific data allocated by threads at non-AST level separate for data allocated for ASTs. In this mode, each access to thread-specific data requires a call to LIB\$AST_IN_PROG, which can add significant overhead when accessing thread-specific data in the C RTL.

The alternate mode protects thread-specific data only if another function has it locked. This protects data that is in use within the C RTL, but does not protect the caller from an AST changing the data pointed to.

This latter mode is now the C RTL default for the strtok, ecvt, and fcvt functions.

You can select the legacy AST safe mode by enabling DECC\$THREAD_DATA_AST_SAFE.

DECC\$TZ_CACHE_SIZE

DECC\$TZ_CACHE_SIZE specifies the number of time zones that can be held in memory.

Default: 2

Maximum: 2147483647

DECC\$UMASK

DECC\$UMASK specifies the default value for the permission mask umask. By default, a parent C program sets the umask from the RMS default permissions for the process. A child process inherits the parent's value for umask.

To enter the value as an octal value, add the leading zero; otherwise, it is translated as a decimal value. For example:

```
$ DEFINE DECC$UMASK 026
```

Maximum: 0777

DECC\$UNIX_LEVEL

With the DECC\$UNIX_LEVEL logical name, you can manage multiple C RTL feature logical names at once. By setting a value for DECC\$UNIX_LEVEL from 1 to 100, you determine the default value for groups of feature logical names. The value you set has a cumulative effect: the higher the value, the more groups that are affected. Setting a value of 20, for example, enables all the feature logicals associated with a DECC\$UNIX_LEVEL of 20, 10, and 1.

The principal logical names affecting UNIX like behavior are grouped as follows:

- 1 General corrections
- 10 Enhancements
- 20 UNIX style filenames
- 30 UNIX style file attributes
- 90 Full UNIX behavior - No concessions to OpenVMS

Level 30 is appropriate for UNIX like programs such as BASH and GNV.

The DECC\$UNIX_LEVEL values and associated groups of affected feature logical names are:

```
General Corrections          (DECC$UNIX_LEVEL 1)
  DECC$FIXED_LENGTH_SEEK_TO_EOF  1
  DECC$POSIX_SEEK_STREAM_FILE    1
  DECC$SELECT_IGNORES_INVALID_FD 1
  DECC$STRTOL_ERANGE             1
  DECC$VALIDATE_SIGNAL_IN_KILL   1

General Enhancements        (DECC$UNIX_LEVEL 10)
  DECC$ARGV_PARSE_STYLE          1
  DECC$EFS_CASE_PRESERVE         1
  DECC$STDIO_CTX_EOL             1
  DECC$PIPE_BUFFER_SIZE          4096
  DECC$USE_RAB64                  1

UNIX style filenames        (DECC$UNIX_LEVEL 20)
  DECC$DISABLE_TO_VMS_LOGNAME_TRANSLATION 1
  DECC$EFS_CHARSET                1
  DECC$FILENAME_UNIX_NO_VERSION  1
  DECC$FILENAME_UNIX_REPORT      1
  DECC$REaddir_DROPDOTNOTYPE     1
  DECC$RENAME_NO_INHERIT         1
  DECC$GLOB_UNIX_STYLE

UNIX like file attributes   (DECC$UNIX_LEVEL 30)
  DECC$EFS_FILE_TIMESTAMPS        1
  DECC$EXEC_FILEATTR_INHERITANCE 1
  DECC$FILE_OWNER_UNIX            1
  DECC$FILE_PERMISSION_UNIX      1
  DECC$FILE_SHARING               1

UNIX compliant behavior     (DECC$UNIX_LEVEL 90)
```

DECC\$FILENAME_UNIX_ONLY	1
DECC\$POSIX_STYLE_UTD	1
DECC\$USE_JPI\$_CREATOR	1
DECC\$DETACHED_CHILD_PROCESS	1

Notes

- Defining a logical name for an individual feature logical supersedes the default value established by DECC\$UNIX_LEVEL for that feature.
 - Future revisions of the C RTL may add new feature logicals to a given DECC\$UNIX_LEVEL. For applications that specify that UNIX level, the effect is to enable those new feature logicals by default.
-

DECC\$UNIX_PATH_BEFORE_LOGNAME

With DECC\$UNIX_PATH_BEFORE_LOGNAME enabled, when translating a UNIX filename not starting with a leading slash (/), an attempt is made to match this to a file or directory in the current directory. If this is not found and the name is valid as a logical name in an OpenVMS filename, an attempt is made to translate the logical name and, if found, is used as part of the resulting filename.

Enabling DECC\$UNIX_PATH_BEFORE_LOGNAME overrides the setting for DECC\$DISABLE_TO_VMS_LOGNAME_TRANSLATION.

DECC\$USE_JPI\$_CREATOR

When enabled, DECC\$USE_JPI\$_CREATOR determines the parent process ID in getppid by calling \$GETJPI using item JPI\$_CREATOR instead of JPI\$_OWNER.

This feature is only available on systems supporting POSIX style session identifiers.

DECC\$USE_RAB64

With DECC\$USE_RAB64 enabled, open functions allocate a RAB64 structure instead of the traditional RAB structure.

This provides latent support for file buffers in 64-bit memory.

DECC\$VALIDATE_SIGNAL_IN_KILL

With DECC\$VALIDATE_SIGNAL_IN_KILL enabled, a signal value that is in the range 0 to _SIG_MAX but is not supported by the C RTL generates an error with errno set to EINVAL, which makes the behavior the same as for raise.

With this logical name disabled, validation of signals is restricted to checking that the signal value is in the range 0 to _SIG_MAX. If sys\$sigprc fails, errno is set based on sys\$sigprc exit status.

DECC\$V62_RECORD_GENERATION

OpenVMS Versions 6.2 and higher can output record files using different rules.

With DECC\$V62_RECORD_GENERATION enabled, the output mechanism follows the rules used for OpenVMS Version 6.2.

DECC\$WRITE_SHORT_RECORDS

The DECC\$WRITE_SHORT_RECORDS feature logical supports a previous change to the fwrite function (to accommodate writing records with size less than the maximum record size), while retaining the legacy way of writing records to a fixed-length file as the default behavior:

With DECC\$WRITE_SHORT_RECORDS enabled, short-sized records (records with size less than the maximum record size) written at EOF are padded with zeros to align records on record boundaries. This is the behavior seen in OpenVMS Version 7.3-1 and some ACRTL ECOs of that time period.

With DECC\$WRITE_SHORT_RECORDS disabled, the legacy behavior of writing records with no padding is implemented. This is the recommended and default behavior.

DECC\$XPG4_STRPTIME

XPG5 support for strptime introduces pivoting year support so that years in the range 0 to 68 are in the 21st century, and years in the range 69-99 are in the 20th century.

With DECC\$XPG4_STRPTIME enabled, XPG5 support for the pivoting year is disabled and all years in the range 0 to 99 are in the current century.

1.6 32-Bit UIDs/GIDs and POSIX Style Identifiers

Where supported in versions of the OpenVMS operating system, POSIX style identifiers refers to the User Identifier (UID), Group Identifier (GID), and Process Group. The scope includes real and effective identifiers.

The support for POSIX style identifiers in the HP C RTL requires 32-bit user and group ID support and also depends on features in the base version of OpenVMS. POSIX style IDs are supported by OpenVMS Version 7.3-2 and higher.

To use POSIX style identifiers on OpenVMS versions that support them requires applications to be compiled for 32-bit UID/GID. On OpenVMS versions where 32-bit UID/GID is the default, the user or application must still enable POSIX style IDs by defining the DECC\$POSIX_STYLE_UID feature logical name:

```
$ DEFINE DECC$POSIX_STYLE_UID ENABLE
```

With POSIX style IDs enabled, at compile time you can selectively invoke the traditional (UIC-based) definition for an individual function by explicitly calling it by its decc\$-prefixed entry point (as opposed to the decc\$__long_gid_-prefixed entry point, which provides the POSIX style behavior).

To disable POSIX style IDs:

```
$ DEFINE DECC$POSIX_STYLE_UID DISABLE
```

OpenVMS Version 7.3-2 and higher supports POSIX style IDs as well as 32-bit UID/GIDs. When an application is compiled to use 32-bit UID/GIDs, the UID and GID are derived from the UIC as in previous versions of the operating system. In some cases, such as with the getgroups function, more information may be returned when the application supports 32-bit GIDs.

To compile an application for 16-bit UID/GID support on systems that by default use 32-bit UIDs/GIDs, define the `_DECC_SHORT_GID_T` macro to 1.

1.7 Input and Output on OpenVMS Systems

After you learn how to link with the HP C RTL and call HP C functions and macros, you can use the HP C RTL for its primary purpose: input/output (I/O).

Since every system has different methods of I/O, familiarize yourself with the OpenVMS specific methods of file access. In this way, you will be equipped to predict functional differences when porting your source program from one operating system to another.

Figure 1–3 shows the I/O methods available with the HP C RTL. The OpenVMS system services communicate directly with the OpenVMS operating system, so they are closest to the operating system. The OpenVMS Record Management Services (RMS) functions use the system services, which manipulate the operating system. The HP C Standard I/O and UNIX I/O functions and macros use the RMS functions. Since the HP C RTL Standard I/O and UNIX I/O functions and macros must go through several layers of function calls before the system is manipulated, they are furthest from the operating system.

Figure 1–3 I/O Interface from C Programs

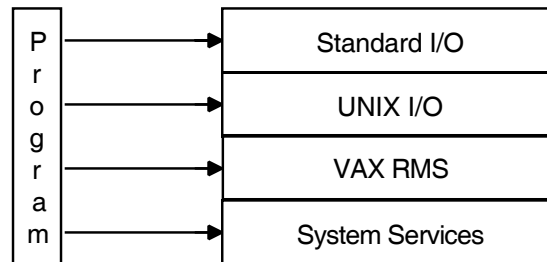

ZK-0493-GE

The C programming language was developed on the UNIX operating system, and the Standard I/O functions were designed to provide a convenient method of I/O that would be powerful enough to be efficient for most applications, and also be portable so that the functions could be used on any system running C language compilers.

The HP C RTL adds functionality to this original specification. Since, as implemented in the HP C RTL, the Standard I/O functions recognize line terminators, the HP C RTL Standard I/O functions are particularly useful for text manipulation. The HP C RTL also implements some of the Standard I/O functions as preprocessor-defined macros.

In a similar manner, the UNIX I/O functions originally were designed to provide a more direct access to the UNIX operating systems. These functions were meant to use a numeric file descriptor to represent a file. A UNIX system represents all peripheral devices as files to provide a uniform method of access.

The HP C RTL adds functionality to the original specification. The UNIX I/O functions, as implemented in HP C, are particularly useful for manipulating binary data. The HP C RTL also implements some of the UNIX I/O functions as preprocessor-defined macros.

The HP C RTL includes the Standard I/O functions that should exist on all C compilers, and also the UNIX I/O functions to maintain compatibility with as many other implementations of C as possible. However, both Standard I/O and UNIX I/O use RMS to access files. To understand how the Standard I/O and UNIX I/O functions manipulate RMS formatted files, learn the fundamentals of RMS. See Section 1.7.1 for more information about Standard I/O and UNIX I/O in relationship to RMS files. For an introduction to RMS, see the *Guide to OpenVMS File Applications*.

Before deciding which method is appropriate for you, first ask this question: Are you concerned with UNIX compatibility or with developing code that will run solely under the OpenVMS operating system?

- If UNIX compatibility is important, you probably want to use the highest levels of I/O—Standard I/O and UNIX I/O—because that level is largely independent of the operating system. Also, the highest level is easier to learn quickly, an important consideration if you are a new programmer.
- If UNIX compatibility is not important to you or if you require the sophisticated file processing that the Standard I/O and UNIX I/O methods do not provide, you might find RMS desirable.

If you are writing system-level software, you may need to access the OpenVMS operating system directly through calls to system services. For example, you may need to access a user-written device driver directly through the Queue I/O Request System Service (\$QIO). To do this, use the OpenVMS level of I/O; this level is recommended if you are an experienced OpenVMS programmer. For examples of programs that call OpenVMS system services, see the *HP C User's Guide for OpenVMS Systems*.

You may never use the RMS or the OpenVMS system services. The Standard I/O and UNIX I/O functions are efficient enough for a large number of applications. Figure 1-4 shows the dependency of the Standard I/O and the UNIX I/O functions on RMS, and the various methods of I/O available to you.

Figure 1–4 Mapping Standard I/O and UNIX I/O to RMS

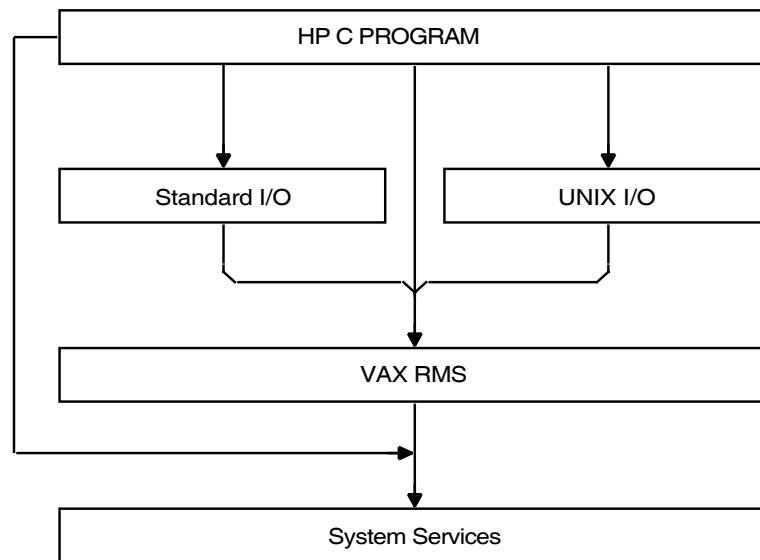

ZK-0494-GE

1.7.1 RMS Record and File Formats

To understand the capabilities and the restrictions of the Standard I/O and UNIX I/O functions and macros, you need to understand OpenVMS Record Management Services (RMS).

RMS supports the following file organizations:

- Sequential
- Relative
- Indexed

Sequential files have consecutive records with no empty records in between; relative files have fixed-length cells that may or may not contain a record; and indexed files have records that contain data, carriage-control information, and keys that permit various orders of access.

The HP C RTL functions can access only sequential files. If you wish to use the other file organizations, you must use the RMS functions. For more information about the RMS functions, see the *HP C User's Guide for OpenVMS Systems*.

RMS is not concerned with the contents of records, but it is concerned about the record format, which is the way a record physically appears on the recording surface of the storage medium.

RMS supports the following record formats:

- Fixed-length
- Variable-length
- Variable with fixed-length control (VFC)
- Stream

You can specify a fixed-length record format at the time of file creation. This means that all records occupy the same amount of space in the file. You cannot change the record format once you create the file.

The length of records in variable-length, VFC, and stream file formats can vary up to a maximum size that must be specified when you create the file. With variable-length record or VFC format files, the size of the record is held in a header section at the beginning of the data record. With stream files, RMS terminates the records when it encounters a specific character, such as a carriage-control or line-feed character. Stream files are useful for storing text.

RMS allows you to specify carriage-control attributes for records in a file. Such attributes include the implied carriage-return or the Fortran formatted records. RMS interprets these carriage controls when the file is output to a terminal, a line printer, or other device. The carriage-control information is not stored in the data records.

By default, files inherit the RMS record format, maximum record size and record attributes, from the previous version of the file, if one exists; to an OpenVMS system programmer, the inherited attributes are known as FAB\$_RFM, FAB\$_MRS and FAB\$_RAT. If no previous versions exist, the newly created file defaults to stream format with line-feed record separator and implied carriage-return attributes. (This manual refers to this type of file as a *stream file*.) You can manipulate stream files using the Standard I/O and the UNIX I/O functions of the HP C RTL. When using these files and fixed-record files with no carriage control, there is no restriction on the ability to seek to any random byte of the file using the `fseek` or the `lseek` functions. However, if the file has one of the other RMS record formats, such as variable-length record format, then these functions, due to RMS restrictions, can seek only to record boundaries. Use the default VAX stream format unless you need to create or access files to be used with other VAX languages or utilities.

1.7.2 Access to RMS Files

RMS sequential files can be opened in record mode or stream mode. By default, `STREAM_LF` files are opened in stream mode; all other file types are opened in record mode. When opening a file, you can override these defaults by specifying the optional argument `"ctx=rec"` to force record mode, or `"ctx=stm"` to force stream mode. RMS relative and indexed files are always opened in record mode. The access mode determines the behavior of various I/O functions in the HP C RTL.

One of the file types defined by RMS is an RMS-11 stream format file, corresponding to a value of `FAB$_STM` for the record format. The definition of this format is such that the RMS record operation `SYS$GET` removes leading null bytes from each record. Because this file type is processed in record mode by the HP C RTL, it is unsuitable as a file format for binary data unless it is explicitly opened with `"ctx=stm"`, in which case the raw bytes of data from the file are returned.

Note

In OpenVMS Version 7.0 the default LRL value on stream files was changed from 0 to 32767. This change caused significant performance degradation on certain file operations such as `sort`.

This is no longer a problem. The HP C RTL now lets you define the logical `DECC$DEFAULT_LRL` to change the default record-length value on stream files.

The HP C RTL first looks for this logical. If it is found and it translates to a numeric value between 0 and 32767, that value is used for the default LRL.

To restore the behavior prior to OpenVMS Version 7.0, enter the following command:

```
$ DEFINE DECC$DEFAULT_LRL 0
```

1.7.2.1 Accessing RMS Files in Stream Mode

Stream access to RMS files is done with the block I/O facilities of RMS. Stream input is performed from RMS files by passing each byte of the on-disk representation of the file to your program. Stream output to RMS files is done by passing each byte from your program to the file. The HP C RTL performs no special processing on the data.

When opening a file in stream mode, the HP C RTL allocates a large internal buffer area. Data is read from the file using a single read into the buffer area and then passing the data to your program as needed. Data is written to the file when the internal buffer is full or when the `fflush` function is called.

1.7.2.2 Accessing RMS Record Files in Record Mode

Record access to record files is done with the record I/O facilities of RMS. The HP C RTL emulates a byte stream by translating carriage-control characters during the process of reading and writing records. Random access is allowed to all record files, but positioning (with `fseek` and `lseek`) must be on a record boundary for VFC files, variable record files, or files with non-null carriage control. Positioning a record file causes all buffered input to be discarded and buffered output to be written to the file.

Record input from RMS record files is emulated by the HP C RTL in two steps:

1. The HP C RTL reads a logical record from the file.
If the record format is variable length with fixed control (RFM = VFC), and the record attributes are not print carriage control (RAT is not PRN), then the HP C RTL concatenates the fixed-control area to the beginning of the record.
2. The HP C RTL expands the record to simulate a stream of bytes by translating the record's carriage-control information (if any).

In RMS terms, the HP C RTL translates the record's carriage-control information using one of the following methods:

- If the record attribute is implied carriage control (RAT = CR), then the HP C RTL appends a new-line character to the record.
This new-line character is considered an integral part of the record, which means for example, that it can be obtained by the `fgetc` function and is considered a line terminator by the `fgets` function. Since `fgets` reads the file up to the new-line character, for RAT=CR files this function cannot retrieve a string that crosses the record boundaries.
- If the record attributes are print carriage control (RAT = PRN), then the HP C RTL expands and concatenates the prefix and postfix carriage controls before and after the record.

This translation is done according to rules specified by RMS, with one exception: if the prefix character is x01 and the postfix character is x8D, then nothing is attached to the beginning of the record and a single new-line character is attached to the end of it. This is done because this prefix/postfix combination is normally used to represent a line.

- If the record attributes are Fortran carriage control (RAT = FTN), then the HP C RTL removes the initial control byte and attaches the appropriate carriage-control characters before and after the data as defined by RMS, with the exception of the space and default carriage-control characters. In these cases, which are used to represent a line, the HP C RTL appends a single new-line character to the data.

The mapping of Fortran carriage-control can be disabled by using "ctx=nocvt".

- If the record attributes are null (RAT = NONE) and the input is coming from a terminal, then the HP C RTL appends the terminating character to the record. If the terminator is a carriage return or Ctrl/Z, then HP C translates the character to a new-line character (\n).

If the input is coming from a nonterminal file, then the HP C RTL passes the record unchanged to your program with no additional prefix or postfix characters.

As you read from the file, the HP C RTL delivers a stream of bytes resulting from the translations. Information that is not read from an expanded record by one function call is delivered on the next input function call.

The HP C RTL performs record output to RMS record files in two steps.

The first part of the record output emulation is the formation of a logical record. As you write bytes to a record file, the emulator examines the information being written for record boundaries. The handling of information in the byte stream depends on the attributes of the destination file or device, as follows:

- For all files, if the number of output bytes is greater than the internal buffer allocated by the HP C RTL, a record is output.
- For files with fixed record length (RFM = FIX) or for files opened with "ctx=bin" or "ctx=xplct", a record is output only when the internal buffer is filled or when the flush function is called.
- For files with STREAM_CR record format (RFM = STMCR), the HP C RTL outputs a record when it encounters a carriage-return character (\r).
- For files with STREAM record format (RFM = STM) the HP C RTL outputs a record when it encounters a new-line (\n), form feed (\f), or vertical tab (\v) character.
- For all other file types, the HP C RTL outputs a record when it encounters a new-line (\n) character.

The second part of record output emulation is to write the logical record formed during the first step. The HP C RTL forms the output record as follows:

- If the record attribute is carriage control (RAT = CR), and if the logical record ends with a new-line character (\n), the HP C RTL drops the new-line character and writes the logical record with implied carriage control.

- If the record attribute is print carriage control (RAT = PRN), then the HP C RTL writes the record with print carriage control according to the rules specified by RMS. If the logical record ends with a single new-line character (\n), the HP C RTL maps the new-line character to an x01 prefix and x8D postfix character. This is the reverse of the translation for record input files with print carriage-control attributes.
- If the record attributes are Fortran carriage control (RAT = FTN), then the HP C RTL removes any prefix and/or postfix carriage-control characters and concatenates a single carriage-control byte to the beginning of the record as defined by RMS, with one exception: If the output record ends in a new-line character (\n), the HP C RTL will remove the new-line character and use the space carriage-control byte. This is the reverse of the translation for record input files with Fortran carriage-control attributes.

The mapping of Fortran carriage-control can be disabled by using "ctx=nocvt".

- If the logical record is to be written to a terminal device and the last character of the record is a new-line character (\n) the HP C RTL replaces the new-line character with a carriage-return (\r), and attaches a line-feed character (\n) to the front of the record. The HP C RTL then writes out the record with no carriage control.
- If the output file record format is variable length with fixed control (RFM = VFC), and the record attributes do not include print carriage control (RAT is not PRN), then the HP C RTL takes the beginning of the logical record to be the fixed-control header, and reduces the number of bytes written out by the length of the header. These bytes are then used to construct the fixed-control header. If there are too few bytes in the logical record, an error is signaled.

1.7.2.2.1 Accessing Variable-Length or VFC Record Files in Record Mode

When you access a variable-length or VFC record file in record mode, many I/O functions behave differently than they would if they were being used with stream mode. This section describes these differences.

In general, the new-line character (\n) is the record separator for all record modes. On output, when a new-line character is encountered, a record is generated unless you specify an optional argument (such as "ctx=bin" or "ctx=xplct") that affects the interpretation of new lines.

The read and `decc$record_read` functions always read at most one record. The write and `decc$record_write` functions always generate at least one record.

`decc$record_read` and `decc$record_write` are equivalent, respectively, to read and write, except that they work with file pointers rather than file descriptors.

Unlike the read function, which reads at most one record, the `fread` function can span records. Rather than read *number_items* records (where *number_items* is the third parameter to `fread`), `fread` tries to read the number of bytes equal to *number_items* × *size_of_item* (where *size_of_item* is the second parameter to `fread`). The value returned by `fread` is equal to the number of bytes read divided by *size_of_item*.

However, the `fwrite` function always generates at least *number_items* records.

The `fgets` and `gets` functions read to either a new-line character or a record boundary.

The `fflush` function always generates a record if there is unwritten data in the buffer. The same is true of `close`, `fclose`, `fseek`, `lseek`, `rewind`, and `fsetpos`, all of which perform implicit `fflush` functions.

A record is also generated whenever an attempt is made to write more characters than allowed by the maximum record size.

For more information on these functions, see the Reference Section.

1.7.2.2.2 Accessing Fixed-Length Record Files in Record Mode When accessing a fixed-length record file in record mode, the I/O functions generally behave as described in Section 1.7.2.2.1.

The write, fwrite, and decc\$record_write functions will fail if given a record size that is not an integral multiple of the maximum record size, unless the file was opened with the "ctx=xplct" optional argument specified. All other output functions will generate records at every *n*th byte, where *n* is the maximum record size.

If a new record is forced by fflush, the data in the buffer is padded to the maximum record size with null characters.

Note

This padding can cause problems for programs that seek to the end-of-file. For example, if a program were to append data to a file, then seek backwards in the file (causing an fflush to occur), and then seek to the end-of-file again, a zero-filled "hole" will have been created between the previous end-of-file and the new end-of-file if the previous end-of-file was not on a record boundary.

1.7.2.3 Example—Difference Between Stream Mode and Record Mode

Example 1–1 demonstrates the difference between stream mode and record mode access.

Example 1–1 Differences Between Stream Mode and Record Mode Access

```
/*      CHAP_1_STREAM_RECORD.C      */
/* This program demonstrates the difference between */
/* record mode and stream mode input/output.      */
#include <stdio.h>
#include <stdlib.h>
#include <string.h>

void process_records(const char *fspec, FILE * fp);

main()
{
    FILE *fp;

    fp = fopen("example-fixed.dat", "w", "rfm=fix", "mrs=40", "rat=none");
    if (fp == NULL) {
        perror("example-fixed");
        exit(EXIT_FAILURE);
    }
    printf("Record mode\n");
    process_records("example-fixed.dat", fp);
    fclose(fp);
}
```

(continued on next page)

Example 1-1 (Cont.) Differences Between Stream Mode and Record Mode Access

```
printf("\nStream mode\n");
fp = fopen("example-streamlf.dat", "w");
if (fp == NULL) {
    perror("example-streamlf");
    exit(EXIT_FAILURE);
}
process_records("example-streamlf.dat", fp);
fclose(fp);
}

void process_records(const char *fspec, FILE * fp)
{
    int i,
        sts;

    char buffer[40];

    /* Write records of all 1's, all 2's and all 3's */
    for (i = 0; i < 3; i++) {
        memset(buffer, '1' + i, 40);
        sts = fwrite(buffer, 40, 1, fp);
        if (sts != 1) {
            perror("fwrite");
            exit(EXIT_FAILURE);
        }
    }

    /* Rewind the file and write 10 characters of A's, then 10 B's, */
    /* then 10 C's. */
    /* For stream mode, each fwrite call outputs 10 characters */
    /* and advances the file position 10 characters */
    /* characters. */
    /* For record mode, each fwrite merges the 10 characters into */
    /* the existing 40-character record, updates the record and */
    /* advances the file position 40 characters to the next record. */
    rewind(fp);
    for (i = 0; i < 3; i++) {
        memset(buffer, 'A' + i, 10);
        sts = fwrite(buffer, 10, 1, fp);
        if (sts != 1) {
            perror("fwrite2");
            exit(EXIT_FAILURE);
        }
    }

    /* Now reopen the file and output the records. */
    fclose(fp);
    fp = fopen(fspec, "r");
    for (i = 0; i < 3; i++) {
        sts = fread(buffer, 40, 1, fp);
        if (sts != 1)
            perror("fread");
        printf("%.40s\n", buffer);
    }
}
```

(continued on next page)

Example 1–1 (Cont.) Differences Between Stream Mode and Record Mode Access

```
    return;  
}
```

Running this program produces the following output:

```
Record Mode  
AAAAAAAAA11111111111111111111111111111111  
BBBBBBBBB22222222222222222222222222222222  
CCCCCCCCC33333333333333333333333333333333  
  
Stream mode  
AAAAAAAAABB BBBB BCCCCCCCCC11111111111  
222222222222222222222222222222222222222  
333333333333333333333333333333333333333
```

1.8 Specific Portability Concerns

One of the last tasks in preparing to use the HP C RTL, if you are going to port your source programs across systems, is to be aware of specific differences between the HP C RTL and the run-time libraries of other implementations of the C language. This section describes some of the problems that you might encounter when porting programs to and from an OpenVMS system. Although portability is closely tied to the implementation of the HP C RTL, this section also contains information on the portability of other HP C for OpenVMS constructs.

The HP C RTL provides ANSI C defined library functions as well as many commonly available APIs and a few OpenVMS extensions. See Section 1.4 for specific standards, portions of which are implemented by the HP C RTL. Attempts have been made to maintain complete portability in functionality whenever possible. Many of the Standard I/O and UNIX I/O functions and macros contained in the HP C RTL are functionally equivalent to those of other implementations.

The RTL function and macro descriptions elaborate on issues presented in this section and describe concerns not documented here.

The following list documents issues of concern if you wish to port C programs to the OpenVMS environment:

- HP C for OpenVMS Systems does not implement the global symbols end, edata, and etext.
- There are differences in how OpenVMS and UNIX systems lay out virtual memory. In some UNIX systems, the address space between 0 and the break address is accessible to your program. In OpenVMS systems, the first page of memory is not accessible.

For example, if a program tries to reference location 0 on an OpenVMS system, a hardware error (ACCVIO) is returned and the program terminates abnormally. OpenVMS systems reserve the first page of address space to catch incorrect pointer references, such as a reference to a location pointed to by a null pointer. For this reason, some existing programs that run on some UNIX systems may fail and you should modify them, as necessary. (Tru64 UNIX and OpenVMS, however, are compatible in this regard.)

- Some C programmers code all external declarations in #include files. Then, specific declarations that require initialization are redeclared in the relevant module. This practice causes the HP C compiler to issue a warning message about multiply declared variables in the same compilation. One way to avoid this warning is to make the redeclared symbols extern variables in the #include files.
- HP C does not support asm calls on OpenVMS VAX and Integrity server systems. They are supported on OpenVMS Alpha systems. See the *HP C User's Guide for OpenVMS Systems* for more information on intrinsic functions.
- Some C programs call the counted string functions strcmpn and strcpyn. These names are not used by HP C for OpenVMS Systems. Instead, you can define macros that expand the strcmpn and strcpyn names into the equivalent, ANSI-compliant names strncmp and strncpy.
- The HP C for OpenVMS compiler does not support the following initialization form:

```
int foo 123;
```

Programs using this form of initialization must be changed.

- HP C for OpenVMS Systems predefines several compile-time macros such as __vax, __alpha, __ia64 __32BITS, __vms, __vaxc, __VMS_VER, __DECC_VER, __D_FLOAT, __G_FLOAT, __IEEE_FLOAT, __X_FLOAT, and others. These predefined macros are useful for programs that must be compatible on other machines and operating systems. For more information, see the predefined macro chapter of the *HP C User's Guide for OpenVMS Systems*.
- The ANSI C language does not guarantee any memory order for the variables in a declaration. For example:

```
int a, b, c;
```

- Depending on the type of external linkage requested, extern variables in a program may be treated differently using HP C on OpenVMS systems than they would on UNIX systems. See the *HP C User's Guide for OpenVMS Systems* for more information.
- The dollar sign (\$) is a legal character in HP C for OpenVMS identifiers, and can be used as the first character.
- The ANSI C language does not define any order for evaluating expressions in function parameter lists or for many kinds of expressions. The way in which different C compilers evaluate an expression is only important when the expression has side effects. Consider the following examples:

```
a[i] = i++;
x = func_y() + func_z();
f(p++, p++)
```

Neither HP C nor any other C compiler can guarantee that such expressions evaluate in the same order on all C compilers.

- The size of a HP C variable of type int is 32 bits on OpenVMS systems. You will have to modify programs that are written for other machines and that assume a different size for a variable of type int. A variable of type long is the same size (32 bits) as a variable of type int.

- The C language defines structure alignment to be dependent on the machine for which the compiler is designed. On OpenVMS Alpha systems, HP C aligns structure members on natural boundaries, unless `#pragma nomember_alignment` is specified. Other implementations may align structure members differently.
- References to structure members in HP C cannot be vague. For more information, see the *HP C Language Reference Manual*.
- Registers are allocated based upon how often a variable is used, but the `register` keyword gives the compiler a strong hint that you want to place a particular variable into a register. Whenever possible, the variable is placed into a register. Any scalar variable with the storage class `auto` or `register` can be allocated to a register as long as the variable's address is not taken with the ampersand operator (`&`) and it is not a member of a structure or union.

1.8.1 Reentrancy

The HP C RTL supports an improved and enhanced reentrancy. The following types of reentrancy are supported:

- `AST` reentrancy uses the `_BBSSI` built-in function to perform simple locking around critical sections of RTL code, but it may also disable asynchronous system traps (ASTs) in locked regions of code. This type of locking should be used when AST code contains calls to HP C RTL I/O routines.
Failure to specify AST reentrancy might cause I/O routines to fail, setting `errno` to `EALREADY`.
- `MULTITHREAD` reentrancy is designed to be used in threaded programs such as those that use the POSIX threads library. It performs threads locking and never disables ASTs. The POSIX Threads library must be available on your system to use this form of reentrancy.
- `TOLERANT` reentrancy uses the `_BBSSI` built-in function to perform simple locking around critical sections of RTL code, but ASTs are not disabled. This type of locking should be used when ASTs are used and must be delivered immediately.
- `NONE` gives optimal performance in the HP C RTL, but does absolutely no locking around critical sections of RTL code. It should only be used in a single-threaded environment when there is no chance that the thread of execution will be interrupted by an AST that would call the HP C RTL.

For nonthreaded processes, the default reentrancy type is `TOLERANT`. When the threads library is loaded, the reentrancy level is implicitly set to `C$C_MULTITHREAD`, and the application cannot change it after that.

You can set the reentrancy type by compiling with the `/REENTRANCY` command-line qualifier or by calling the `decc$set_reentrancy` function. This function must be called exclusively from non-AST level.

When programming an application using multiple threads or ASTs, consider three classes of functions:

- Functions with no internal data
- Functions with thread-local internal data
- Functions with processwide internal data

Most functions have no internal data at all. For these functions, synchronization is necessary only if the parameter is used by the application in multiple threads or in both AST and non-AST contexts. For example, although the `strcat` function is ordinarily safe, the following is an example of unsafe usage:

```
extern char buffer[100];
void routine1(char *data) {
    strcat( buffer, data );
}
```

If `routine1` executed concurrently in multiple threads, or if `routine1` is interrupted by an AST routine that calls it, the results of the `strcat` call are unpredictable.

The second class of functions are those that have thread-local static data. Typically, these are routines in the library that return a string where the application is not permitted to free the storage for the string. These routines are thread-safe but not AST-reentrant. This means they can safely be called concurrently, and each thread will have its own copy of the data. They cannot be called from AST routines if it is possible that the same routine was executing in non-AST context. The routines in this class are:

```
asctime          stat
ctermid          strerror
ctime            strtok
cuserid          VAXC$ESTABLISH
gmtime           the errno variable
localtime        wcstok
perror
```

All the socket functions are also included in this list if the TCP/IP product in use is thread-safe.

The third class of functions are those that affect processwide data. These functions are neither thread-safe nor AST-reentrant. For example, `sigsetmask` establishes the processwide signal mask. Consider a routine like the following:

```
void update_data
base()
{
    int old_mask;
    old_mask = sigsetmask( 1 << (SIGINT - 1));
    /* Do work here that should not be aborted. */
    sigsetmask( old_mask );
}
```

If `update_data` was called concurrently in multiple threads, thread 1 might unblock `SIGINT` while thread 2 was still performing work that should not be aborted.

The routines in this class are:

- All the signal routines
- All the exec routines
- The `exit`, `_exit`, `nice`, `system`, `wait`, `getitimer`, `setitimer`, and `setlocale` routines.

Note

Generally, UTC-based time functions can affect in-memory time-zone information, which is processwide data. However, if the system time zone remains the same during the execution of the application (which is the common case) and the cache of time-zone files is enabled (which is the default), then the `_r` variant of the time functions `asctime_r`, `ctime_r`, `gmtime_r` and `localtime_r` is both thread-safe and AST-reentrant.

If, however, the system time zone can change during the execution of the application or the cache of time-zone files is not enabled, then both variants of the UTC-based time functions belong to the third class of functions, which are neither thread-safe nor AST-reentrant.

Some functions remain inherently nonthread-safe regardless of the reentrancy type. They are:

<code>execl</code>	<code>exit</code>
<code>execle</code>	<code>_exit</code>
<code>execlp</code>	<code>nice</code>
<code>execv</code>	<code>system</code>
<code>execve</code>	<code>vfork</code>
<code>execvp</code>	

1.8.2 Multithread Restrictions

Mixing the multithread programming model and the OpenVMS AST programming model in the same application is not recommended. The application has no mechanism to control which thread gets interrupted by an AST. This can result in a resource deadlock if the thread holds a resource that is also needed by the AST routine. The following functions use mutexes. To avoid a potential resource deadlock, do not call them from AST functions in a multithreaded application.

- All the I/O functions
- All the socket functions
- All the signal functions
- `vfork`, `exec`, `wait`, `system`
- `catgets`
- `set_new_handler` (C++ only)
- `getenv`
- `rand` and `srand`
- `exit` and `_exit`
- `clock`
- `nice`
- `times`
- `ctime`, `localtime`, `asctime`, `mktime`

1.9 64-Bit Pointer Support *(Integrity servers, Alpha)*

This section is for application developers who need to use 64-bit virtual memory addressing on OpenVMS Alpha Version 7.0 or higher.

OpenVMS Alpha 64-bit virtual addressing support makes the 64-bit virtual address space defined by the Alpha architecture available to both the OpenVMS operating system and its users. It also allows per-process virtual addressing for accessing dynamically mapped data beyond traditional 32-bit limits.

The HP C Run-Time Library on OpenVMS Alpha Version 7.0 systems and higher includes the following features in support of 64-bit pointers:

- Guaranteed binary and source compatibility of existing programs
- No impact on applications that are not modified to exploit 64-bit support
- Enhanced memory allocation routines that allocate 64-bit memory
- Widened function parameters to accommodate 64-bit pointers
- Dual implementations of functions that need to know the pointer size used by the caller
- New information available to the DEC C Version 5.2 compiler or higher to seamlessly call the correct implementation
- Ability to explicitly call either the 32-bit or 64-bit form of functions for applications that mix pointer sizes
- A single shareable image for use by 32-bit and 64-bit applications

1.9.1 Using the HP C Run-Time Library

The HP C Run-Time library on OpenVMS Alpha Version 7.0 systems and higher can generate and accept 64-bit pointers. Functions that require a second interface to be used with 64-bit pointers reside in the same object libraries and shareable images as their 32-bit counterparts. No new object libraries or shareable images are introduced. Using 64-bit pointers does not require changes to your link command or link options files.

The HP C 64-bit environment allows an application to use both 32-bit and 64-bit addresses. For more information about how to manipulate pointer sizes, see the `/POINTER_SIZE` qualifier and `#pragma pointer_size` and `#pragma required_pointer_size` preprocessor directives in the *HP C User's Guide for OpenVMS Systems*.

The `/POINTER_SIZE` qualifier requires you to specify a value of 32 or 64. This value is used as the default pointer size within the compilation unit. You can compile one set of modules using 32-bit pointers and another set using 64-bit pointers. Care must be taken when these two separate groups of modules call each other.

Use of the `/POINTER_SIZE` qualifier also influences the processing of HP C RTL header files. For those functions that have a 32-bit and 64-bit implementation, specifying `/POINTER_SIZE` enables function prototypes to access both functions, regardless of the actual value supplied to the qualifier. In addition, the value specified to the qualifier determines the default implementation to call during that compilation unit.

The `#pragma pointer_size` and `#pragma required_pointer_size` preprocessor directives can be used to change the pointer size in effect within a compilation unit. You can default pointers to 32-bit pointers and then declare specific pointers within the module as 64-bit pointers. You would also need to specifically call the `_malloc64` form of `malloc` to obtain memory from the 64-bit memory area.

1.9.2 Obtaining 64-Bit Pointers to Memory

The HP C RTL has many functions that return pointers to newly allocated memory. In each of these functions, the application owns the memory pointed to and is responsible for freeing that memory.

Functions that allocate memory are:

```
malloc
calloc
realloc
strdup
```

Each of these functions have a 32-bit and a 64-bit implementation. When the `/POINTER_SIZE` qualifier is used, the following functions can also be called:

```
_malloc32, _malloc64
_calloc32, _calloc64
_realloc32, _realloc64
_strdup32, _strdup64
```

When `/POINTER_SIZE=32` is specified, all `malloc` calls default to `_malloc32`.

When `/POINTER_SIZE=64` is specified, all `malloc` calls default to `_malloc64`.

Regardless of whether the application calls a 32-bit or 64-bit memory allocation routine, there is still a single `free` function. This function accepts either pointer size.

Be aware that the memory allocation functions are the only ones that return pointers to 64-bit memory. All HP C RTL structure pointers returned to the calling application (such as a `FILE`, `WINDOW`, or `DIR`) are always 32-bit pointers. This allows both 32-bit and 64-bit callers to pass these structure pointers within the application.

1.9.3 HP C Header Files

The header files distributed with OpenVMS support 64-bit pointers. Each function prototype whose signature contains a pointer is constructed to indicate the size of the pointer accepted.

A 32-bit pointer can be passed as an argument to functions that accept either a 32-bit or 64-bit pointer for that argument.

A 64-bit pointer, however, cannot be passed as an argument to a function that accepts a 32-bit pointer. Attempts to do this are diagnosed by the compiler with a `MAYLOSEDATA` message. The diagnostic message `IMPLICITFUNC` means the compiler can do no additional pointer-size validation for calls to that function. If this function is an HP C RTL function, refer to the reference section of this manual for the name of the header file that defines that function.

You might find the following pointer-size compiler diagnostics useful:

- `%CC-IMPLICITFUNC`

A function prototype was not found before using the specified function. The compiler and run-time system rely on prototype definitions to detect incorrect pointer-size usage. Failure to include the proper header files can lead to incorrect results and/or pointer truncation.

- **%CC-MAYLOSEDATA**

A truncation is necessary to do this operation. The operation could be passing a 64-bit pointer to a function that does not support a 64-bit pointer in the given context. It could also be a function returning a 64-bit pointer to a calling application that is trying to store that return value in a 32-bit pointer.

- **%CC-MAYHIDELOSS**

This message (when enabled) helps expose real MAYLOSEDATA messages that are being suppressed because of a cast operation. To enable this warning, compile with the qualifier `/WARNINGS=ENABLE=MAYHIDELOSS`.

1.9.4 Functions Affected

The HP C RTL accommodates applications that use only 32-bit pointers, only 64-bit pointers, or combinations of both. To use 64-bit memory, you must, at a minimum, recompile and relink an application. The amount of source code change required depends on the application itself, calls to other run-time libraries, and the combinations of pointer sizes used.

With respect to 64-bit pointer support, the functions in the HP C RTL fall into four categories:

- Functions not impacted by choice of pointer size
- Functions enhanced to accept either pointer size
- Functions having a 32-bit and 64-bit implementation
- Functions that accept only 32-bit pointers

From an application developer's perspective, the first two types of functions are the easiest to use in either a single- or mixed-pointer mode.

The third type requires no modifications when used in a single-pointer compilation, but might require source code changes when used in a mixed-pointer mode.

The fourth type requires careful attention whenever 64-bit pointers are used.

1.9.4.1 No Pointer-Size Impact

The choice of pointer size has no impact on a function if its prototype contains no pointer-related parameters or return values. The mathematical functions are good examples of this.

Even some functions in this category that do have pointers in their prototype are not impacted by pointer size. For example, `strerror` has the prototype:

```
char * strerror (int error_number);
```

This function returns a pointer to a character string, but this string is allocated by the HP C RTL. As a result, to support both 32-bit and 64-bit applications, these types of pointers are guaranteed to fit in a 32-bit pointer.

1.9.4.2 Functions Accepting Both Pointer Sizes

The Alpha architecture supports 64-bit pointers. The OpenVMS Alpha calling standard specifies that all arguments are actually passed as 64-bit values. Before OpenVMS Alpha Version 7.0, all 32-bit addresses passed to procedures were sign-extended into this 64-bit parameter. The called function declared the parameters as 32-bit addresses, which caused the compiler to generate 32-bit instructions (such as LDL) to manipulate these parameters.

Many functions in the HP C RTL are enhanced to receive the full 64-bit address. For example, consider `strlen`:

```
size_t strlen (const char *string);
```

The only pointer in this function is the character-string pointer. If the caller passes a 32-bit pointer, the function works with the sign-extended 64-bit address. If the caller passes a 64-bit address, the function works directly with that address.

The HP C RTL continues to have only a single entry point for functions in this category. There are no source-code changes required to add any of the four pointer-size options for functions of this type. The OpenVMS documentation refers to these functions as 64-bit friendly.

1.9.4.3 Functions with Two Implementations

There are many reasons why a function might need one implementation for 32-bit pointers and another for 64-bit pointers. Some of these reasons include:

- The pointer size of the return value is the same size as the pointer size of one of the arguments. If the argument is 32 bits, the return value is 32 bits. If the argument is 64 bits, the return value is 64 bits.
- One of the arguments is a pointer to an object whose size is pointer-size sensitive. To know how many bytes are being pointed to, the function must know if the code was compiled in 32-bit or 64-bit pointer-size mode.
- The function returns the address of dynamically allocated memory. The memory is allocated in 32-bit space when compiled for 32-bit pointers, and is allocated in 64-bit space when compiled for 64-bit pointers.

From the application developer's point of view, there are three function prototypes for each of these functions. The `<string.h>` header file contains many functions whose return value is dependent upon the pointer size used as the first argument to the function call. For example, consider the `memset` function. The header file defines three entry points for this function:

```
void * memset (void *memory_pointer, int character, size_t size);  
void * _memset32 (void *memory_pointer, int character, size_t size);  
void * _memset64 (void *memory_pointer, int character, size_t size);
```

The first prototype is the function that your application would currently call if using this function. The compiler changes a call to `memset` into a call to either `_memset32` when compiled with `/POINTER_SIZE=32`, or `_memset64` when compiled with `/POINTER_SIZE=64`.

You can override this default behavior by directly calling either the 32-bit or the 64-bit form of the function. This accommodates applications using mixed-pointer sizes, regardless of the default pointer size specified with the `/POINTER_SIZE` qualifier.

If the application is compiled *without* specifying the `/POINTER_SIZE` qualifier, *neither* the 32-bit specific *nor* the 64-bit specific function prototypes are defined. In this case, the compiler automatically calls the 32-bit interface for all interfaces having dual implementations.

Table 1–5 shows the HP C RTL functions that have dual implementations to support 64-bit pointer size. When compiling with the `/POINTER_SIZE` qualifier, calls to the unmodified function names are changed to calls to the function interface that matches the pointer size specified on the qualifier.

Table 1–5 Functions with Dual Implementations

basename	bsearch	calloc	catgets
ctermid	cuserid	dirname	fgetname
fgets	fgetws	gcvt	getcwd
getname	getpwent	getpwnam	getpwnam_r
getpwuid	getpwuid_r	gets	index
longname	malloc	mbsrtowcs	memccpy
memchr	memcpy	memmove	memset
mktemp	mmap	qsort	readv
realloc	rindex	strcat	strchr
strcpy	strdup	strncat	strncpy
strpbrk	strptime	strrchr	strsep
strstr	strtod	strtok	strtok_r
strtol	strtoll	strtoq	strtoul
strtoull	strtouq	tmpnam	wscat
wcschr	wscpy	wcsncat	wcsncpy
wcspbrk	wcsrchr	wcsrtombs	wcsstr
wcstok	wcstol	wcstoul	wcswcs
wmemchr	wmemcpy	wmemmove	wmemset
writev	glob	globfree	

Table 1–6 shows the TCP/IP socket routines that have dual implementations to support 64-bit pointer size.

Table 1–6 Socket Routines with Dual Implementations

freeaddrinfo	getaddrinfo
recvmsg	sendmsg

1.9.4.4 Socket Transfers Greater than 64 KB

Starting with OpenVMS Version 8.3, support is added for socket transfers greater than 64 KB for the following socket routines:

send	recv	read
sendto	recvfrom	write
sendmsg	recvmsg	

1.9.4.5 Functions Requiring Explicit use of 64-Bit Structures

Some functions require explicit use of 64-bit structures when compiling `/POINTER_SIZE=LONG`. This is necessary for functions that have recently had 64-bit support added to avoid unexpected runtime errors by inadvertently mixing 32-bit and 64-bit versions of structures.

Consider the following functions:

<code>getaddrinfo</code>	<code>getpwnam</code>
<code>freeaddrinfo</code>	<code>getpwnam_r</code>
<code>getpwuid</code>	<code>getpwent</code>
<code>sendmsg</code>	<code>getpwent_r</code>
<code>recvmsg</code>	

These functions previously offered 32-bit support only, even when compiled with `/POINTER_SIZE=LONG`. In order to preserve the previous behavior of 32-bit pointer support in those functions even when compiled with `/POINTER_SIZE=LONG`, these seven functions do not follow the normal convention for 32-bit and 64-bit support as documented in the previous section.

The following variants of these functions, and the corresponding structures they use, have been added to the C RTL to provide 64-bit support:

Function	Structure
<code>__getaddrinfo32</code>	<code>__addrinfo32</code>
<code>__getaddrinfo64</code>	<code>__addrinfo64</code>
<code>__freeaddrinfo32</code>	<code>__addrinfo32</code>
<code>__freeaddrinfo64</code>	<code>__addrinfo64</code>
<code>__recvmsg32</code>	<code>__msghdr32</code>
<code>__recvmsg64</code>	<code>__msghdr64</code>
<code>__sendmsg32</code>	<code>__msghdr32</code>
<code>__sendmsg64</code>	<code>__msghdr64</code>
<code>__32_getpwnam</code>	<code>__passwd32</code>
<code>__64_getpwnam</code>	<code>__passwd64</code>
<code>__getpwnam_r32</code>	<code>__passwd32</code>
<code>__getpwnam_r64</code>	<code>__passwd64</code>
<code>__32_getpwuid</code>	<code>__passwd32</code>
<code>__64_getpwuid</code>	<code>__passwd64</code>
<code>__getpwuid_r32</code>	<code>__passwd32</code>
<code>__getpwuid_r64</code>	<code>__passwd64</code>
<code>__32_getpwent</code>	<code>__passwd32</code>
<code>__64_getpwent</code>	<code>__passwd64</code>

When compiling the standard versions of these functions, the following behavior occurs:

- With `/POINTER_SIZE=32` specified, the compiler converts the call to the 32-bit version of the function. For example, `getaddrinfo` is converted to `__getaddrinfo32`.
- With `/POINTER_SIZE=64` specified, the compiler converts the call to the 64-bit version of the function. For example, `getaddrinfo` is converted to `__getaddrinfo64`.
- When the `/POINTER_SIZE` qualifier is not specified, neither the 32-bit-specific nor the 64-bit-specific function prototypes are defined.

However, a similar conversion of the corresponding structures does *not* occur for these functions. This behavior is necessary because these structures existed before OpenVMS Version 7.3-2 as 32-bit versions only, even when compiled with `/POINTER_SIZE=LONG`. Implicitly changing the size of the structure could result in unexpected run-time errors.

When compiling programs that use the standard version of these functions for 64-bit support, you must use the 64-bit-specific definition of the related structure. With `/POINTER_SIZE=64` specified, compiling a program with the standard function name and standard structure definition will result in compiler PTRMISMATCH warning messages.

For example, the following program uses the `getaddrinfo` and `freeaddrinfo` routines, along with the standard definition of the `addrinfo` structure. Compiling this program results in the warning messages shown:

```
$ type test.c
#include <netdb.h>

int main ()
{
    struct addrinfo *ai;

    getaddrinfo ("althea", 0, 0, &ai);
    freeaddrinfo (ai);
    return 0;
}
$ cc /pointer_size=64 TEST.C
    getaddrinfo ("althea", 0, 0, &ai);
    ....
    ^
%CC-W-PTRMISMATCH, In this statement, the referenced type of the pointer value
"ai" is "long pointer to struct addrinfo", which is not compatible with "long
pointer to struct __addrinfo64".
at line number 7 in file TEST.C;1

    freeaddrinfo (ai);
    ....
    ^
%CC-W-PTRMISMATCH, In this statement, the referenced type of the pointer value
"ai" is "struct addrinfo", which is not compatible with "struct __addrinfo64".
at line number 8 in file TEST.C;1
$
```

When compiling for 64 bits, you need to use the 64-bit-specific version of the related structure. In the previous example, the declaration of the `ai` structure could be changed to the following:

```
struct __addrinfo64 *ai;
```

Or, to provide flexibility between 32-bit and 64-bit compilations, the `ai` structure could be declared as follows:

```
#if __INITIAL_POINTER_SIZE == 64
    struct __addrinfo64 *ai;
#else
    struct __addrinfo32 *ai;
#endif
```

1.9.4.6 Functions Restricted to 32-Bit Pointers

A few functions in the HP C RTL do not support 64-bit pointers. If you try to pass a 64-bit pointer to one of these functions, the compiler generates a %CC-W-MAYLOSEDATA warning. Applications compiled with /POINTER_SIZE=64 might need to be modified to avoid passing 64-bit pointers to these functions.

Table 1–7 shows the functions restricted to using 32-bit pointers. The HP C RTL offers no 64-bit support for these functions. You must ensure that only 32-bit pointers are used with these functions.

Table 1–7 Functions Restricted to 32-Bit Pointers

atexit	getopt	putenv
execv	iconv	setbuf
execve	initstate	setstate
execvp	ioctl	setvbuf

Table 1–8 shows functions that make callbacks to user-supplied functions as part of processing that function call. The callback procedures are not passed 64-bit pointers.

Table 1–8 Callbacks that Pass Only 32-Bit Pointers

decc\$from_vms	decc\$to_vms
ftw	tputs

1.9.5 Reading Header Files

This section introduces the pointer-size manipulations used in the HP C RTL header files. Use the following examples to become more proficient in reading these header files and to help modify your own header files.

Examples

```
1. :
   #if __INITIAL_POINTER_SIZE ❶
   #   if (__VMS_VER < 70000000) || !defined __ALPHA ❷
   #       error "Pointer size usage not permitted before OpenVMS Alpha V7.0"
   #   endif
   #   pragma __pointer_size __save ❸
   #   pragma __pointer_size 32 ❹
   #endif
   :
   :
   #if __INITIAL_POINTER_SIZE ❺
   #   pragma __pointer_size 64
   #endif
   :
   :
   #if __INITIAL_POINTER_SIZE ❻
   #   pragma __pointer_size __restore
   #endif
   :
```

All HP C compilers that support the /POINTER_SIZE qualifier predefine the __INITIAL_POINTER_SIZE macro. The HP C RTL header files take

advantage of the ANSI rule that if a macro is not defined, it has an implicit value of 0.

The macro is defined as 32 or 64 when the `/POINTER_SIZE` qualifier is used. It is defined as 0 if the qualifier is not used. The statement at ❶ can be read as "if the user has specified either `/POINTER_SIZE=32` or `/POINTER_SIZE=64` on the command line".

The C compiler is supported on many OpenVMS versions. The lines at ❷ generate an error message if the target of the compilation is one that does not support 64-bit pointers.

A header file cannot assume anything about the actual pointer-size context in effect at the time the header file is included. Furthermore, the HP C compiler offers only the `__INITIAL_POINTER_SIZE` macro and a mechanism to change the pointer size, but not a way to determine the current pointer size.

All header files that have a dependency on pointer sizes are responsible for saving ❸, initializing ❹, altering ❺, and restoring ❻ the pointer-size context.

```
2. :
   :
   #ifndef __CHAR_PTR32 ❶
   #   define __CHAR_PTR32 1
   #   typedef char * __char_ptr32;
   #   typedef const char * __const_char_ptr32;
   #endif
   :
   :
   #if __INITIAL_POINTER_SIZE
   #   pragma __pointer_size 64
   #endif
   :
   :
   #ifndef __CHAR_PTR64 ❷
   #   define __CHAR_PTR64 1
   #   typedef char * __char_ptr64;
   #   typedef const char * __const_char_ptr64;
   #endif
   :
```

Some function prototypes need to refer to a 32-bit pointer when in a 64-bit pointer-size context. Other function prototypes need to refer to a 64-bit pointer when in a 32-bit pointer-size context.

HP C binds the pointer size used in a typedef at the time the typedef is made. Assuming this header file is compiled with no `/POINTER_SIZE` qualifier or with `/POINTER_SIZE=SHORT`, the typedef declaration of `__char_ptr32` ❶ is made in a 32-bit context. The typedef declaration of `__char_ptr64` ❷ is made in a 64-bit context.

```

3. :
   :
   #if __INITIAL_POINTER_SIZE
   # if (__VMS_VER < 70000000) || !defined __ALPHA
   #   error " Pointer size usage not permitted before OpenVMS Alpha V7.0"
   # endif
   # pragma __pointer_size __save
   # pragma __pointer_size 32
   #endif
   :
   ❶
   :
   #if __INITIAL_POINTER_SIZE ❷
   # pragma __pointer_size 64
   #endif
   :
   ❸
   :
   int abs (int __j); ❹
   :
   __char_ptr32 strerror (int __errnum); ❺
   :

```

Before declaring function prototypes that support 64-bit pointers, the pointer context is changed ❷ from 32-bit pointers to 64-bit pointers.

Functions restricted to 32-bit pointers are placed in the 32-bit pointer context section ❶ of the header file. All other functions are placed in the 64-bit context section ❸ of the header file.

Functions that have no pointer-size impact (❹ and ❺) are located in the 64-bit section. Functions that have no pointer-size impact except for a 32-bit address return value ❺ are also in the 64-bit section, and use the 32-bit specific typedefs previously discussed.

```

4. :
   :
   #if __INITIAL_POINTER_SIZE
   # pragma __pointer_size 64
   #endif
   :
   :
   #if __INITIAL_POINTER_SIZE == 32 ❶
   # pragma __pointer_size 32
   #endif
   :
   char *strcat (char *__s1, __const_char_ptr64 __s2); ❷
   :
   #if __INITIAL_POINTER_SIZE
   # pragma __pointer_size 32
   :
   char *_strcat32 (char *__s1, __const_char_ptr64 __s2); ❸
   :
   # pragma __pointer_size 64
   :
   char *_strcat64 (char *__s1, const char *__s2); ❹
   :
   #endif
   :

```

This example shows declarations of functions that have both a 32-bit and 64-bit implementation. These declarations are located in the 64-bit section of the header file.

The normal interface to the function ❷ is declared using the pointer size specified on the `/POINTER_SIZE` qualifier. Because the header file is in 64-bit pointer context and because of the statements at ❶, the declaration at ❷ is made using the same pointer-size context as the `/POINTER_SIZE` qualifier.

The 32-bit specific interface ❸ and the 64-bit specific interface ❹ are declared in 32-bit and 64-bit pointer-size context, respectively.

Understanding Input and Output

There are three types of input and output (I/O) in the HP C Run-Time Library (RTL): UNIX, Standard, and Terminal. Table 2–1 lists all the I/O functions and macros found in the HP C RTL. For more detailed information on each function and macro, see the Reference Section.

Table 2–1 I/O Functions and Macros

Function or Macro	Description
UNIX I/O—Opening and Closing Files	
close	Closes the file associated with a file descriptor.
creat	Creates a new file.
dup, dup2	Allocates a new descriptor that refers to a file specified by a file descriptor returned by open, creat, or pipe.
open	Opens a file and positions it at its beginning.
UNIX I/O—Reading from Files	
read	Reads bytes from a file and places them in a buffer.
UNIX I/O—Writing to Files	
write	Writes a specified number of bytes from a buffer to a file.
UNIX I/O—Maneuvering in Files	
lseek	Positions a stream file to an arbitrary byte position and returns the new position as an int.

(continued on next page)

Table 2–1 (Cont.) I/O Functions and Macros

Function or Macro	Description
UNIX I/O—Additional X/Open I/O Functions and Macros	
<code>fstat, stat</code>	Accesses information about the file descriptor or the file specification.
<code>flockfile, ftrylockfile, funlockfile</code>	File-pointer-locking functions.
<code>fsync</code>	Writes to disk any buffered information for the specified file.
<code>getname</code>	Returns the file specification associated with a file descriptor.
<code>isapipe</code>	Returns 1 if the file descriptor is associated with a pipe and 0 if it is not.
<code>isatty</code>	Returns 1 if the specified file descriptor is associated with a terminal and 0 if it is not.
<code>lwait</code>	Waits for completion of pending asynchronous I/O.
<code>ttyname</code>	Returns a pointer to the null-terminated name of the terminal device associated with file descriptor 0, the default input device.
Standard I/O—Opening and Closing Files	
<code>fclose</code>	Closes a function by flushing any buffers associated with the file control block, and freeing the file control block and buffers previously associated with the file pointer.
<code>fdopen</code>	Associates a file pointer with a file descriptor returned by an <code>open</code> , <code>creat</code> , <code>dup</code> , <code>dup2</code> , or <code>pipe</code> function.
<code>fopen</code>	Opens a file by returning the address of a FILE structure.
<code>freopen</code>	Substitutes the file, named by a file specification, for the open file addressed by a file pointer.
Standard I/O—Reading from Files	
<code>fgetc, getc, fgetwc, getw, getwc</code>	Returns characters from a specified file.
<code>fgets, fgets</code>	Reads a line from a specified file and stores the string in an argument.
<code>fread</code>	Reads a specified number of items from a file.
<code>fscanf, fwscanf, vfscanf, vfwscanf</code>	Performs formatted input from a specified file.
<code>sscanf, swscanf, vsscanf, vswscanf</code>	Performs formatted input from a character string in memory.
<code>ungetc, ungetwc</code>	Pushes back a character into the input stream and leaves the stream positioned before the character.

(continued on next page)

Table 2–1 (Cont.) I/O Functions and Macros

Function or Macro	Description
Standard I/O—Writing to Files	
<code>fprintf, fwprintf, vfprintf, vfwprintf</code>	Performs formatted output to a specified file.
<code>fputc, putc, putw, putwc, fputc</code>	Writes characters to a specified file.
<code>fputs, fputs</code>	Writes a character string to a file without copying the string's null terminator.
<code>fwrite</code>	Writes a specified number of items to a file.
<code>sprintf, swprintf, vsprintf, vswprintf</code>	Performs formatted output to a string in memory.
Standard I/O—Maneuvering in Files	
<code>fflush</code>	Sends any buffered information for the specified file to RMS.
<code>fgetpos</code>	Stores the current value of the file position indicator for the stream.
<code>fsetpos</code>	Sets the file position indicator for the stream according to the value of the object pointed to.
<code>fseek, fseeko</code>	Positions the file to the specified byte offset in the file.
<code>ftell, ftello</code>	Returns the current byte offset to the specified stream file.
<code>rewind</code>	Sets the file to its beginning.
Standard I/O—Additional Standard I/O Functions and Macros	
<code>access</code>	Checks a file to see whether a specified access mode is allowed.
<code>clearerr</code>	Resets the error and end-of-file indications for a file.
<code>feof</code>	Tests a file to see if the end-of-file has been reached.
<code>ferror</code>	Returns a nonzero integer if an error has occurred while reading or writing a file.
<code>fgetname</code>	Returns the file specification associated with a file pointer.
<code>fileno</code>	Returns an integer file descriptor that identifies the specified file.
<code>ftruncate</code>	Truncates a file at the specified position.
<code>fwait</code>	Waits for completion of pending asynchronous I/O.
<code>fwide</code>	Sets the orientation a stream.
<code>mktemp</code>	Creates a unique filename from a template.
<code>remove, delete</code>	Deletes a file.
<code>rename</code>	Gives a new name to an existing file.
<code>setbuf, setvbuf</code>	Associates a buffer with an input or output file.
<code>tmpfile</code>	Creates a temporary file that is opened for update.
<code>tmpnam</code>	Creates a character string that can be used in place of the file-name argument in other function calls.

(continued on next page)

Table 2–1 (Cont.) I/O Functions and Macros

Function or Macro	Description
Terminal I/O—Reading from Files	
<code>getchar</code> , <code>getwchar</code>	Reads a single character from the standard input (<code>stdin</code>).
<code>gets</code>	Reads a line from the standard input (<code>stdin</code>).
<code>scanf</code> , <code>wscanf</code> , <code>vscanf</code> , <code>vwscanf</code>	Performs formatted input from the standard input.
Terminal I/O—Writing to Files	
<code>printf</code> , <code>wprintf</code> , <code>vprintf</code> , <code>vwprintf</code>	Performs formatted output to the standard output (<code>stdout</code>).
<code>putchar</code> , <code>putwchar</code>	Writes a single character to the standard output and returns the character.
<code>puts</code>	Writes a character string to the standard output followed by a new-line character.

2.1 Using RMS from RTL Routines

When you create a file using the HP C RTL I/O functions and macros, you can supply values for many RMS file attributes, including:

- Allocation quantity
- Block size
- Default file extension
- Default filename
- File access context options
- File-processing options
- File-sharing options
- Multiblock count
- Multibuffer count
- Maximum record size
- Record attributes
- Record format
- Record-processing options

See the description of the `creat` function in the Reference Section for information on these values.

Other functions that allow you to set these values include `open`, `fopen`, and `freopen`.

For more information about RMS, see the *HP C User's Guide for OpenVMS Systems*.

2.2 UNIX I/O and Standard I/O

UNIX I/O functions are UNIX system services, now standardized by ISO POSIX-1 (the ISO Portable Operating System Interface).

UNIX I/O functions use file descriptors to access files. A *file descriptor* is an integer that identifies the file. A file descriptor is declared in the following way, where *file_desc* is the name of the file descriptor:

```
int file_desc;
```

UNIX I/O functions, such as `creat`, associate the file descriptor with a file. Consider the following example:

```
file_desc1 = creat("INFILE.DAT", 0, "rat=cr", "rfm=var");
```

This statement creates the file, `INFILE.DAT`, with file access mode 0, carriage-return control, variable-length records, and it associates the variable `file_desc1` with the file. When the file is accessed for other operations, such as reading or writing, the file descriptor is used to refer to the file. For example:

```
write(file_desc1, buffer, sizeof(buffer));
```

This statement writes the contents of the buffer to `INFILE.DAT`.

There may be circumstances when you should use UNIX I/O functions and macros instead of the Standard I/O functions and macros. For a detailed discussion of both forms of I/O and how they manipulate the RMS file formats, see Chapter 1.

Standard I/O functions are specified by the ANSI C Standard.

Standard I/O functions add buffering to the features of UNIX I/O and use file pointers to access files. A *file pointer* is an object of type `FILE *`, which is a typedef defined in the `<stdio.h>` header file as follows:

```
typedef struct _iobuf *FILE;
```

The `_iobuf` identifier is also defined in `<stdio.h>`.

To declare a file pointer, use the following:

```
FILE *file_ptr;
```

Use the Standard I/O `fopen` function to create or open an existing file. For example:

```
#include <stdio.h>
main()
{
    FILE *outfile;
    outfile = fopen("DISKFILE.DAT", "w+");
    .
    .
    .
}
```

Here, the file `DISKFILE.DAT` is opened for write-update access.

The HP C RTL provides the following functions for converting between file descriptors and file pointers:

- `fileno`—returns the file descriptor associated with the specified file pointer.
- `fdopen`—associates a file pointer with a file descriptor returned by an `open`, `creat`, `dup`, `dup2`, or `pipe` function.

2.3 Wide-Character Versus Byte I/O Functions

The wide-character I/O functions provide operations similar to most of the byte I/O functions, except that the fundamental units internal to the wide-character functions are wide characters.

However, the external representation (in files) is a sequence of multibyte characters, not wide characters. For the wide-character formatted input and output functions:

- The wide-character formatted *input* functions (such as `fwscanf`) always read a sequence of multibyte characters from files, regardless of the specified directive and, before any further processing, convert this sequence to a sequence of wide characters.
- The wide-character formatted *output* functions (such as `fwprintf`) write wide characters to output files by first converting wide-character argument types to a sequence of multibyte characters, then calling the underlying operating system output primitives.

Byte I/O functions cannot handle state-dependent encodings. Wide-character I/O functions can. They accomplish this by associating each wide-character stream with a conversion-state object of type `mbstate_t`.

The wide-character I/O functions are:

<code>fgetc</code>	<code>fputc</code>	<code>fwscanf</code>	<code>fwprintf</code>	<code>ungetc</code>
<code>fgetws</code>	<code>fputws</code>	<code>wscanf</code>	<code>wprintf</code>	
<code>getc</code>	<code>putc</code>		<code>vfwprintf</code>	
<code>getwchar</code>	<code>putwchar</code>		<code>vwprintf</code>	

The byte I/O functions are:

<code>fgetc</code>	<code>fputc</code>	<code>fscanf</code>	<code>fprintf</code>	<code>ungetc</code>
<code>fgets</code>	<code>fputs</code>	<code>scanf</code>	<code>printf</code>	<code>fread</code>
<code>getc</code>	<code>putc</code>		<code>vfprintf</code>	<code>fwrite</code>
<code>gets</code>	<code>puts</code>		<code>vprintf</code>	
<code>getchar</code>	<code>putchar</code>			

The wide-character input functions read multibyte characters from the stream and convert them to wide characters as if they were read by successive calls to the `fgetc` function. Each conversion occurs as if a call were made to the `mbrtowc` function with the conversion state described by the stream's own `mbstate_t` object.

The wide-character output functions convert wide characters to multibyte characters and write them to the stream as if they were written by successive calls to the `fputc` function. Each conversion occurs as if a call were made to the `wcrtomb` function, with the conversion state described by the I/O stream's own `mbstate_t` object.

If a wide-character I/O function encounters an invalid multibyte character, the function sets `errno` to the value `EILSEQ`.

2.4 Conversion Specifications

Several of the Standard I/O functions (including the Terminal I/O functions) use conversion specifications to specify data formats for I/O. These functions are the formatted-input and formatted-output functions. Consider the following example:

```
int    x = 5.0;
FILE  *outfile;
      .
      .
      .
fprintf(outfile, "The answer is %d.\n", x);
```

The decimal value of the variable `x` replaces the conversion specification `%d` in the string to be written to the file associated with the identifier `outfile`.

Each conversion specification begins with a percent sign (`%`) and ends with a *conversion specifier*, which is a character that specifies the type of conversion to be performed. Optional characters can appear between the percent sign and the conversion specifier.

For the wide-character formatted I/O functions, the conversion specification is a string of wide characters. For the byte I/O equivalent functions, it is a string of bytes.

Sections 2.4.1 and 2.4.2 describe these optional characters and conversion specifiers.

2.4.1 Converting Input Information

The format specification string for the input of information can include three kinds of items:

- White-space characters (spaces, tabs, and new-line characters), which match optional white-space characters in the input field.
- Ordinary characters (not `%`), which must match the next nonwhite-space character in the input.
- Conversion specifications, which govern the conversion of the characters in an input field and their assignment to an object indicated by a corresponding input pointer.

Each input pointer is an address expression indicating an object whose type matches that of a corresponding conversion specification. Conversion specifications form part of the format string. The indicated object is the target that receives the input value. There must be as many input pointers as there are conversion specifications, and the addressed objects must match the types of the conversion specifications.

A conversion specification consists of the following characters, in the order listed:

- A percent character (`%`) or the sequence `%n$` (where `n` is an integer),
The sequence `%n$` denotes that the conversion is applied to the `n`th input pointer listed, where `n` is a decimal integer between `[1, NL_ARGMAX]` (see the `<limits.h>` header file). For example, a conversion specification beginning with `%5$` means that the conversion will be applied to the fifth input pointer listed after the format specification. The sequence `%$` is invalid.

If the conversion specification does not begin with the sequence `%n$`, the conversion specification is matched to its input pointer in left-to-right order. You should only use one type of conversion specification (`%` or `%n$`) in a format specification.

- One or more optional characters (see Table 2–2).
- A conversion specifier (see Table 2–3).

Table 2–2 shows the characters you can use between the percent sign (`%`) (or the sequence `%n$`), and the conversion specifier. These characters are optional but, if specified, must occur in the order shown in Table 2–2.

Table 2–2 Optional Characters Between `%` (or `%n$`) and the Input Conversion Specifier

Character	Meaning
*	An assignment-suppressing character.
field width	<p>A nonzero decimal integer that specifies the maximum field width. For the wide-character input functions, the field width is measured in wide characters. For the byte input functions, the field width is measured in bytes, unless the directive is one of the following:</p> <p><code>%lc, %ls, %C, %S, %[</code></p> <p>In these cases, the field width is measured in multibyte character units.</p> <p>For programs compiled with <code>/L_DOUBLE=64</code> (that is, compiled without the default <code>/L_DOUBLE=128</code>), the maximum field width is 1024.</p>
h, l, or L (or ll)	<p>Precede a conversion specifier of <code>d</code>, <code>i</code>, or <code>n</code> with an <code>h</code> if the corresponding argument is a pointer to <code>short int</code> rather than a pointer to <code>int</code>; with an <code>l</code> (lowercase ell) if it is a pointer to <code>long int</code>; or, for OpenVMS Alpha systems only, with an <code>L</code> or <code>ll</code> (two lowercase ells) if it is a pointer to <code>__int64</code>.</p> <p>Precede a conversion specifier of <code>o</code>, <code>u</code>, or <code>x</code> with an <code>h</code> if the corresponding argument is a pointer to <code>unsigned short int</code> rather than a pointer to <code>unsigned int</code>; with an <code>l</code> if it is a pointer to <code>unsigned long int</code>; or, for OpenVMS Alpha systems only, with an <code>L</code> or <code>ll</code> if it is a pointer to <code>unsigned __int64</code>.</p> <p>Precede a conversion specifier of <code>c</code>, <code>s</code>, or <code>[</code> with an <code>l</code> (lowercase ell) if the corresponding argument is a pointer to a <code>wchar_t</code>.</p> <p>Finally, precede a conversion specifier of <code>e</code>, <code>f</code>, or <code>g</code> with an <code>l</code> (lowercase ell) if the corresponding argument is a pointer to <code>double</code> rather than a pointer to <code>float</code>, or with an <code>L</code> if it is a pointer to <code>long double</code>.</p> <p>If an <code>h</code>, <code>l</code>, <code>L</code>, or <code>ll</code> appears with any other conversion specifier, then the behavior is undefined.</p>

Table 2–3 describes the conversion specifiers for formatted input.

Table 2–3 Conversion Specifiers for Formatted Input

Specifier	Input Type ¹	Description
d		Expects a decimal integer in the input whose format is the same as expected for the subject sequence of the <code>strtol</code> function with the value 10 for the base argument. The corresponding argument must be a pointer to <code>int</code> .
i		Expects an integer whose type is determined by the leading input characters. A leading 0 is equated to octal, a leading 0X or 0x is equated to hexadecimal, and all other forms are equated to decimal. The corresponding argument must be a pointer to <code>int</code> .
o		Expects an octal integer in the input (with or without a leading 0). The corresponding argument must be a pointer to <code>int</code> .
u		Expects a decimal integer in the input whose format is the same as expected for the subject sequence of the <code>strtoul</code> function with the value 10 for the base argument.
x		Expects a hexadecimal integer in the input (with or without a leading 0x). The corresponding argument must be a pointer to unsigned <code>int</code> .
c	Byte	<p>Expects a single byte in the input. The corresponding argument must be a pointer to <code>char</code>.</p> <p>If a field width precedes the <code>c</code> conversion specifier, then the number of characters specified by the field width is read. In this case, the corresponding argument must be a pointer to an array of <code>char</code>.</p> <p>If the optional character <code>l</code> (lowercase ell) precedes this conversion specifier, then the specifier expects a multibyte character in the input which is converted into a wide-character code.</p> <p>The corresponding argument must be a pointer to type <code>wchar_t</code>. If a field width also precedes the <code>c</code> conversion specifier, then the number of characters specified by the field width is read. In this case, the corresponding argument must be a pointer to an array of <code>wchar_t</code>.</p>
	Wide-character	<p>Expects a sequence of the number of characters specified in the optional field width; this is 1 if not specified.</p> <p>If no <code>l</code> (lowercase ell) precedes the <code>c</code> specifier, then the corresponding argument must be a pointer to an array of <code>char</code>.</p> <p>If an <code>l</code> (lowercase ell) precedes the <code>c</code> specifier, then the corresponding argument must be a pointer to an array of <code>wchar_t</code>.</p>

¹Either *byte* or *wide-character*. Where neither is shown for a given specifier, the specifier description applies to both.

(continued on next page)

Table 2–3 (Cont.) Conversion Specifiers for Formatted Input

Specifier	Input Type ¹	Description
C	Byte	<p>The specifier expects a multibyte character in the input, which is converted into a wide-character code. The corresponding argument must be a pointer to type <code>wchar_t</code>.</p> <p>If a field width also precedes the C conversion specifier, then the number of characters specified by the field width is read. In this case, the corresponding argument must be a pointer to an array of <code>wchar_t</code>.</p>
	Wide-character	<p>Expects a sequence of the number of characters specified in the optional field width; this is 1 if not specified. The corresponding argument must be a pointer to an array of <code>wchar_t</code>.</p>
s	Byte	<p>Expects a sequences of bytes in the input. The corresponding argument must be a pointer to an array of characters that is large enough to contain the sequence and a terminating null character (<code>\0</code>) that is automatically added. The input field is terminated by a space, tab, or new-line character.</p> <p>If the optional character l (ell) precedes this conversion specifier, then the specifier expects a sequence of multibyte characters in the input, which are converted to wide-character codes. The corresponding argument must be a pointer to an array of wide characters (type <code>wchar_t</code>) that is large enough to contain the sequence plus the terminating null wide-character code that is automatically added. The input field is terminated by a space, tab, or new-line character.</p>
	Wide-character	<p>Expects (conceptually) a sequence of nonwhite-space characters in the input.</p> <p>If no l (lowercase ell) precedes the s specifier, then the corresponding argument must be a pointer to an array of <code>char</code> large enough to contain the sequence plus the terminating null byte that is automatically added.</p> <p>If an l (lowercase ell) precedes the s specifier, then the corresponding argument must be a pointer to an array of <code>wchar_t</code> large enough to contain the sequence plus the terminating null wide character that is automatically added.</p>
S	Byte	<p>The specifier expects a sequence of multibyte characters in the input, which are converted to wide-character codes. The corresponding argument must be a pointer to an array of wide characters (type <code>wchar_t</code>) that is large enough to contain the sequence plus a terminating null wide-character code that is added automatically. The input field is terminated by a space, tab, or new-line character.</p>
	Wide-character	<p>Expects a sequence of nonwhite-space characters in the input. The corresponding argument must be a pointer to an array of <code>wchar_t</code> large enough to contain the sequence plus the terminating null wide character that is automatically added.</p>

¹Either *byte* or *wide-character*. Where neither is shown for a given specifier, the specifier description applies to both.

(continued on next page)

Table 2–3 (Cont.) Conversion Specifiers for Formatted Input

Specifier	Input Type ¹	Description
e, f, g		Expects a floating-point number in the input. The corresponding argument must be a pointer to <code>float</code> . The input format for floating-point numbers is: <code>[±]nnn[radix][ddd][{E e}[±]nn]</code> . The n's and d's are decimal digits (as many as indicated by the field width minus the signs and the letter E). The radix character is defined in the current locale.
[. . .]		Expects a nonempty sequence of characters that is not delimited by a white-space character. The brackets enclose a set of characters (the <i>scanset</i>) expected in the input sequence. Any character in the input sequence that does not match a character in the scanset terminates the character sequence. All characters between the brackets comprise the scanset, unless the first character after the left bracket is a circumflex (^). In this case, the scanset contains all characters other than those that appear between the circumflex and the right bracket. Any character that <i>does</i> appear between the circumflex and the right bracket will terminate the input character sequence. If the conversion specifier begins with <code>[]</code> or <code>[^]</code> , then the right bracket character is in the scanset and the next right bracket character is the matching right bracket that ends the specification; otherwise, the first right bracket character ends the specification.
	Byte	If an <code>l</code> (lowercase ell) does not precede the <code>[]</code> specifier, then the characters in the scanset must be single-byte characters only. In this case, the corresponding argument must be a pointer to an array of <code>char</code> large enough to accept the sequence and the terminating null byte that is automatically added. If an <code>l</code> (lowercase ell) does precede the <code>[]</code> specifier, then the characters in the input sequence are considered to be multibyte characters, which are then converted to a wide-character sequence for further processing. If character ranges are specified in the scanset, then the processing is done according to the <code>LC_COLLATE</code> category of the current program's locale. In this case, the corresponding argument must be a pointer to an array of <code>wchar_t</code> large enough to accept the sequence and the terminating null wide character that is automatically added.

¹Either *byte* or *wide-character*. Where neither is shown for a given specifier, the specifier description applies to both.

(continued on next page)

Table 2–3 (Cont.) Conversion Specifiers for Formatted Input

Specifier	Input Type ¹	Description
	Wide-character	<p>If no l (lowercase ell) precedes the [conversion specifier, then processing is the same as described for the byte-input type of the %[specifier, except that the corresponding argument must be an array of char large enough to accept the multibyte sequence plus the terminating null byte that is automatically added.</p> <p>If an l (lowercase ell) precedes the [conversion specifier, then processing is the same as in the preceding paragraph except that the corresponding argument must be an array of wchar_t large enough to accept the wide-character sequence plus the terminating null wide character that is automatically added.</p>
p		Requires an argument that is a pointer to void. The input value is interpreted as a hexadecimal value.
n		No input is consumed. The corresponding argument is a pointer to an integer. The integer is assigned the number of characters read from the input stream so far by this call to the formatted input function. Execution of a %n directive does not increment the assignment count returned when the formatted input function completes execution.
%		Matches a single percent symbol. No conversion or assignment takes place. The complete conversion specification would be %%.

¹Either *byte* or *wide-character*. Where neither is shown for a given specifier, the specifier description applies to both.

Remarks

- You can change the delimiters of the input field with the bracket ([]) conversion specification. Otherwise, an input field is defined as a string of nonwhite-space characters. It extends either to the next white-space character or until the field width, if specified, is exhausted. The function reads across line and record boundaries, since the new-line character is a white-space character.
- A call to one of the input conversion functions resumes searching immediately after the last character processed by a previous call.
- If the assignment-suppression character (*) appears in the format specification, no assignment is made. The corresponding input field is interpreted and then skipped.
- The arguments must be pointers or other address-valued expressions, since HP C permits only calls by value. To read a number in decimal format and assign its value to n, you must use the following form:

```
scanf("%d", &n)
```

You cannot use the following form:

```
scanf("%d", n)
```

- White space in a format specification matches optional white space in the input field. Consider the following format specification:

```
field = %x
```

This format specification matches the following forms:

```
field = 5218
field=5218
field= 5218
field =5218
```

These forms do not match the following example:

```
fiel d=5218
```

2.4.2 Converting Output Information

The format specification string for the output of information can contain:

- Ordinary characters, which are copied to the output.
- Conversion specifications, each of which causes the conversion of a corresponding output source to a character string in a particular format. Conversion specifications are matched to output sources in left-to-right order.

A conversion specification consists of the following, in the order listed:

- A percent character (%) or the sequence %n\$.

The sequence %n\$ denotes that the conversion is applied to the *n*th output source listed, where *n* is a decimal integer between [1, NL_ARGMAX] (see the <limits.h> header file). For example, a conversion specification beginning with %5\$ means that the conversion will be applied to the fifth output source listed after the format specification.

If the conversion specification does not begin with the sequence %n\$, the conversion specification is matched to its output source in left-to-right order. You should only use one type of conversion specification (% or %n\$) in a format specification.

- One or more optional characters (see Table 2–4).
- A conversion specifier (see Table 2–5) concludes the conversion specification.

For examples of conversion specifications, see the sample programs in Section 2.6.

Table 2–4 shows the characters you can use between the percent sign (%) (or the sequence %n\$) and the conversion specifier. These characters are optional, but if specified, they must occur in the order shown in Table 2–4.

Table 2–4 Optional Characters Between % (or %n\$) and the Output Conversion Specifier

Character	Meaning
flags	You can use the following flag characters, alone or in any combined order, to modify the conversion specification:
' (single quote)	Requests that a numeric conversion is formatted with the thousands separator character. Only the numbers to the left of the radix character are formatted with the separator character. The character used as a separator and the positioning of the separators are defined in the program's current locale.
– (hyphen)	Left-justifies the converted output source in its field.
+	Requests that an explicit sign be present on a signed conversion. If this flag is not specified, the result of a signed conversion begins with a sign only when a negative value is converted.
<i>space</i>	Prefixes a space to the result of a signed conversion, if the first character of the conversion is not a sign, or if the conversion results in no characters. If you specify both the <i>space</i> and the + flag, the <i>space</i> flag is ignored.
#	Requests an alternate conversion format. Depending on the conversion specified, different actions will occur. For the o (octal) conversion, the precision is increased to force the first digit to be a zero. For the x (or X) conversion, a nonzero result is prefixed with 0x (or 0X). For e, E, f, g, and G conversions, the result contains a decimal point even at the end of an integer value. For g and G conversions, trailing zeros are not trimmed. For other conversions, the effect of # is undefined.
0	Uses zeros rather than spaces to pad the field width for d, i, o, u, x, X, e, E, f, g, and G conversions. If both the 0 and the – flags are specified, then the 0 flag is ignored. For d, i, o, u, x, and X conversions, if a precision is specified, the 0 flag is ignored. For other conversions, the behavior of the 0 flag is undefined.

(continued on next page)

Table 2–4 (Cont.) Optional Characters Between % (or %n\$) and the Output Conversion Specifier

Character	Meaning
field width	<p>The minimum field width can be designated by a decimal integer constant, or by an output source. To specify an output source, use an asterisk (*) or the sequence *n\$, where <i>n</i> refers to the <i>n</i>th output source listed after the format specification.</p> <p>The minimum field width is considered after the conversion is done according to all the other components of the format directive. This component affects the padding of the conversion result as follows:</p> <p>If the result of the conversion is wider than the minimum field, write it out.</p> <p>If the result of the conversion is narrower than the minimum width, pad it to make up the field width. Pad with spaces by default. Pad with zeros if the 0 flag is specified; this does not mean that the width is an octal number. Padding is on the left by default, and on the right if a minus sign is specified.</p> <p>For the wide-character output functions, the field width is measured in wide characters; for the byte output functions, it is measured in bytes.</p> <p>For programs compiled with /L_DOUBLE=64 (that is, compiled without the default /L_DOUBLE=128), the maximum field width is 1024.</p>
. (period)	<p>Separates the field width from the precision.</p>
precision	<p>The precision defines any of the following:</p> <ul style="list-style-type: none"> • Minimum number of digits to appear for d, i, o, u, x, and X conversions • Number of digits to appear after the decimal-point character for e, E, and f conversions • Maximum number of significant digits for g and G conversions • Maximum number of characters to be written from a string in an s or S conversion <p>If a precision appears with any other conversion specifier, the behavior is undefined.</p> <p>Precision can be designated by a decimal integer constant, or by an output source. To specify an output source, use an asterisk (*) or the sequence *n\$, where <i>n</i> refers to the <i>n</i>th output source listed after the format specification.</p> <p>If only the period is specified, the precision is taken as 0.</p>

(continued on next page)

Table 2–4 (Cont.) Optional Characters Between % (or %n\$) and the Output Conversion Specifier

Character	Meaning
h, l, or L (or ll)	<p>An h specifies that a following d, i, o, u, x, or X conversion specifier applies to a short int or unsigned short int argument; an h can also specify that a following n conversion specifier applies to a pointer to a short int argument.</p> <p>An l (lowercase ell) specifies that a following d, i, o, u, x, or X conversion specifier applies to a long int or unsigned long int argument; an l can also specify that a following n conversion specifier applies to a pointer to a long int argument.</p> <p>On OpenVMS Alpha and Integrity server systems, an L or ll (two lowercase ell) specifies that a following d, i, o, u, x, or X conversion specifier applies to an <code>__int64</code> or unsigned <code>__int64</code> argument. <i>(Integrity servers, Alpha)</i></p> <p>An L specifies that a following e, E, f, g, or G conversion specifier applies to a long double argument.</p> <p>An l specifies that a following c or s conversion specifier applies to a <code>wchar_t</code> argument.</p> <p>If an h, l, or L appears with any other conversion specifier, the behavior is undefined.</p> <p>OpenVMS Alpha systems, HP C int values are equivalent to long values.</p>

Table 2–5 describes the conversion specifiers for formatted output.

Table 2–5 Conversion Specifiers for Formatted Output

Specifier	Output Type ¹	Description
d, i		Converts an int argument to signed decimal format.
o		Converts an unsigned int argument to unsigned octal format.
u		Converts an unsigned int argument to unsigned decimal format (giving a number in the range 0 to 4,294,967,295).
x, X		Converts an unsigned int argument to unsigned hexadecimal format (with or without a leading 0x). The letters abcdef are used for x conversion, and the letters ABCDEF are used for X conversion.

¹Either *byte* or *wide-character*. Where neither is shown for a given specifier, the specifier description applies to both.

(continued on next page)

Table 2–5 (Cont.) Conversion Specifiers for Formatted Output

Specifier	Output Type ¹	Description
f		<p>Converts a float or double argument to the format <code>[-]mmm.nnnnnn</code>. The number of n's is equal to the precision specification as follows:</p> <ul style="list-style-type: none"> • If no precision is specified, the default is 6. • If the precision is 0 and the # flag is specified, the decimal point appears but no n's appear. • If the precision is 0 and the # flag is not specified, the decimal point also does not appear. • If a decimal point appears, at least one digit appears before it. <p>The value is rounded to the appropriate number of digits.</p>
e, E		<p>Converts a float or double argument to the format <code>[-]m.nnnnnnE±xx</code>. The number of n's is specified by the precision. If no precision is specified, the default is 6. If the precision is explicitly 0 and the # flag is specified, the decimal point appears but no n's appear. If the precision is explicitly 0 and the # flag is not specified, the decimal point also does not appear. An 'e' is printed for e conversion; an 'E' is printed for E conversion. The exponent always contains at least two digits. If the value is 0, the exponent is 0.</p>
g, G		<p>Converts a float or double argument to format f or e (or E if the G conversion specifier is used), with the precision specifying the number of significant digits. If the precision is 0, it is taken as 1. The format used depends on the value of the argument: format e (or E) is used only if the exponent resulting from such a conversion is less than -4, or is greater than or equal to the precision; otherwise, format f is used. Trailing zeros are suppressed in the fractional portion of the result. A decimal point appears only if it is followed by a digit.</p>
c	Byte	<p>Converts an int argument to an unsigned char, and writes the resulting byte.</p> <p>If the optional character l (lowercase ell) precedes this conversion specifier, then the specifier converts a wchar_t argument to an array of bytes representing the character, and writes the resulting character. If the field width is specified and the resulting character occupies fewer bytes than the field width, then it will be padded to the given width with space characters. If the precision is specified, then the behavior is undefined.</p>

¹Either *byte* or *wide-character*. Where neither is shown for a given specifier, the specifier description applies to both.

(continued on next page)

Table 2–5 (Cont.) Conversion Specifiers for Formatted Output

Specifier	Output Type ¹	Description
	Wide-character	<p>If an <code>l</code> (lowercase ell) does not precede the <code>c</code> specifier, then the <code>int</code> argument is converted to a wide character as if by calling <code>btowc</code>, and the resulting character is written.</p> <p>If an <code>l</code> (lowercase ell) precedes the <code>c</code> specifier, then the specifier converts a <code>wchar_t</code> argument to an array of bytes representing the character, and writes the resulting character. If the field width is specified and the resulting character occupies fewer characters than the field width, it will be padded to the given width with space characters. If the precision is specified, the behavior is undefined.</p>
<code>C</code>	Byte	<p>Converts a <code>wchar_t</code> argument to an array of bytes representing the character, and writes the resulting character. If the field width is specified and the resulting character occupies fewer bytes than the field width, then it will be padded to the given width with space characters. If the precision is specified, then the behavior is undefined.</p>
	Wide-character	<p>Converts a <code>wchar_t</code> argument to an array of bytes representing the character, and writes the resulting character. If the field width is specified and the resulting character occupies fewer wide characters than the field width, then it will be padded to the given width with space characters. If the precision is specified, then the behavior is undefined.</p>
<code>s</code>	Byte	<p>Requires an argument that is a pointer to an array of characters of type <code>char</code>. The argument is used to write characters until a null character is encountered or until the number of characters indicated by the precision specification is exhausted. If the precision specification is 0 or omitted, then all characters up to a null are output.</p> <p>If the optional character <code>l</code> (lowercase ell) precedes this conversion specifier, then the specifier converts an array of wide-character codes to multibyte characters, and writes the multibyte characters. Requires an argument that is a pointer to an array of wide characters of type <code>wchar_t</code>. Characters are written until a null wide character is encountered or until the number of bytes indicated by the precision specification is exhausted. If the precision specification is omitted or is greater than the size of the array of converted bytes, then the array of wide characters must be terminated by a null wide character.</p>

¹Either *byte* or *wide-character*. Where neither is shown for a given specifier, the specifier description applies to both.

(continued on next page)

Table 2–5 (Cont.) Conversion Specifiers for Formatted Output

Specifier	Output Type ¹	Description
	Wide-character	<p>If an <code>l</code> (lowercase ell) does not precede the <code>s</code> specifier, then the specifier converts an array of multibyte characters, as if by calling <code>mbrtowc</code> for each multibyte character, and writes the resulting characters until a null wide character is encountered or the number of wide characters indicated by the precision specification is exhausted. If the precision specification is omitted or is greater than the size of the array of converted characters, then the converted array must be terminated by a null wide character.</p> <p>If an <code>l</code> precedes this conversion specifier, then the argument is a pointer to an array of <code>wchar_t</code>. Characters from this array are written until a null wide character is encountered or the number of wide characters indicated by the precision specification is exhausted. If the precision specification is omitted or is greater than the size of the array, then the array must be terminated by a null wide character.</p>
<code>S</code>	Byte	<p>Converts an array of wide-character codes to multibyte characters, and writes the multibyte characters. Requires an argument that is a pointer to an array of wide characters of type <code>wchar_t</code>. Characters are written until a null wide character is encountered or until the number of bytes indicated by the precision specification is exhausted. If the precision specification is omitted or is greater than the size of the array of converted bytes, then the array of wide characters must be terminated by a null wide character.</p>
	Wide-character	<p>The argument is a pointer to an array of <code>wchar_t</code>. Characters from this array are written until a null wide character is encountered or the number of wide characters indicated by the precision specification is exhausted. If the precision specification is omitted or is greater than the size of the array, then the array must be terminated by a null wide character.</p>
<code>p</code>		<p>Requires an argument that is a pointer to <code>void</code>. The value of the pointer is output as a hexadecimal number.</p>
<code>n</code>		<p>Requires an argument that is a pointer to an integer. The integer is assigned the number of characters written to the output stream so far by this call to the formatted output function. No argument is converted.</p>
<code>%</code>		<p>Writes out the percent symbol. No conversion is performed. The complete conversion specification would be <code>%%</code>.</p>

¹Either *byte* or *wide-character*. Where neither is shown for a given specifier, the specifier description applies to both.

2.5 Terminal I/O

HP C defines three file pointers that allow you to perform I/O to and from the logical devices usually associated with your terminal (for interactive jobs) or a batch stream (for batch jobs). In the OpenVMS environment, the three permanent process files `SYS$INPUT`, `SYS$OUTPUT`, and `SYS$ERROR` perform the same functions for both interactive and batch jobs. Terminal I/O refers to both terminal and batch stream I/O. The file pointers `stdin`, `stdout`, and `stderr` are defined when you include the `<stdio.h>` header file using the `#include` preprocessor directive.

The `stdin` file pointer is associated with the terminal to perform input. This file is equivalent to `SYS$INPUT`. The `stdout` file pointer is associated with the terminal to perform output. This file is equivalent to `SYS$OUTPUT`. The `stderr` file pointer is associated with the terminal to report run-time errors. This file is equivalent to `SYS$ERROR`.

There are three file descriptors that refer to the terminal. The file descriptor 0 is equivalent to `SYS$INPUT`, 1 is equivalent to `SYS$OUTPUT`, and 2 is equivalent to `SYS$ERROR`.

When performing I/O at the terminal, you can use Standard I/O functions and macros (specifying the pointers `stdin`, `stdout`, or `stderr` as arguments), you can use UNIX I/O functions (giving the corresponding file descriptor as an argument), or you can use the Terminal I/O functions and macros. There is no functional advantage to using one type of I/O over another; the Terminal I/O functions might save keystrokes since there are no arguments.

2.6 Program Examples

This section gives some program examples that show how the I/O functions can be used in applications.

Example 2-1 shows the `printf` function.

Example 2-1 Output of the Conversion Specifications

```
/*      CHAP_2_OUT_CONV.C      */
/* This program uses the printf function to print the */
/* various conversion specifications and their effect */
/* on the output. */
/* Include the proper header files in case printf has */
/* to return EOF. */

#include <stdlib.h>
#include <stdio.h>
#include <wchar.h>

#define WIDE_STR_SIZE 20

main()
{
    double val = 123345.5;
    char c = 'C';
    int i = -1500000000;
    char *s = "thomasina";
    wchar_t wc;
    wchar_t ws[WIDE_STR_SIZE];

    /* Produce a wide character and a wide character string */
    if (mbtowlc(&wc, "W", 1) == -1) {
        perror("mbtowlc");
        exit(EXIT_FAILURE);
    }
    if (mbstowcs(ws, "THOMASINA", WIDE_STR_SIZE) == -1) {
        perror("mbstowcs");
        exit(EXIT_FAILURE);
    }
}
```

(continued on next page)

Example 2-1 (Cont.) Output of the Conversion Specifications

```
/* Print the specification code, a colon, two tabs, and the */
/* formatted output value delimited by the angle bracket */
/* characters (<>). */

printf("%9.4f:\t\t<%9.4f>\n", val);
printf("%9f:\t\t<%9f>\n", val);
printf("%9.0f:\t\t<%9.0f>\n", val);
printf("%-9.0f:\t\t<%-9.0f>\n\n", val);

printf("%11.6e:\t\t<%11.6e>\n", val);
printf("%11e:\t\t<%11e>\n", val);
printf("%11.0e:\t\t<%11.0e>\n", val);
printf("%-11.0e:\t\t<%-11.0e>\n\n", val);

printf("%11g:\t\t<%11g>\n", val);
printf("%9g:\t\t<%9g>\n\n", val);

printf("%d:\t\t<%d>\n", c);
printf("%c:\t\t<%c>\n", c);
printf("%o:\t\t<%o>\n", c);
printf("%x:\t\t<%x>\n\n", c);

printf("%d:\t\t<%d>\n", i);
printf("%u:\t\t<%u>\n", i);
printf("%x:\t\t<%x>\n\n", i);

printf("%s:\t\t<%s>\n", s);
printf("%-9.6s:\t\t<%-9.6s>\n", s);
printf("%-*. *s:\t\t<%-*. *s>\n", 9, 5, s);
printf("%6.0s:\t\t<%6.0s>\n\n", s);
printf("%cC:\t\t<%C>\n", wc);
printf("%sS:\t\t<%S>\n", ws);
printf("%-9.6S:\t\t<%-9.6S>\n", ws);
printf("%-*. *S:\t\t<%-*. *S>\n", 9, 5, ws);
printf("%6.0S:\t\t<%6.0S>\n\n", ws);
}
```

Running Example 2-1 produces the following output:

```
$ RUN EXAMPLE
%9.4f:      <123345.5000>
%9f:       <123345.500000>
%9.0f:     < 123346>
%-9.0f:    <123346 >

%11.6e:    <1.233455e+05>
%11e:     <1.233455e+05>
%11.0e:    < 1e+05>
%-11.0e:  <1e+05 >

%11g:     < 123346>
%9g:      < 123346>

%d:       <67>
%c:       <C>
%o:       <103>
%x:       <43>

%d:       <-1500000000>
%u:       <2794967296>
%x:       <a697d100>

%s:       <thomasina>
%-9.6s:   <thomas >
%-*. *s:  <thoma >
%6.0s:    < >
```

```

%C:          <W>
%S:          <THOMASINA>
%-9.6S:     <THOMAS  >
%-*.*S:     <THOMA  >
%6.0S:      <      >
$

```

Example 2–2 shows the use of the `fopen`, `ftell`, `sprintf`, `fputs`, `fseek`, `fgets`, and `fclose` functions.

Example 2–2 Using the Standard I/O Functions

```

/*      CHAP_2_STDIO.C  */

/* This program establishes a file pointer, writes lines from
/* a buffer to the file, moves the file pointer to the second
/* record, copies the record to the buffer, and then prints
/* the buffer to the screen. */

#include <stdio.h>
#include <stdlib.h>

main()
{
    char buffer[32];
    int i,
        pos;
    FILE *fptr;

    /* Set file pointer. */
    fptr = fopen("data.dat", "w+");
    if (fptr == NULL) {
        perror("fopen");
        exit(EXIT_FAILURE);
    }

    for (i = 1; i < 5; i++) {
        if (i == 2) /* Get position of record 2. */
            pos = ftell(fptr);
        /* Print a line to the buffer. */
        sprintf(buffer, "test data line %d\n", i);
        /* Print buffer to the record. */
        fputs(buffer, fptr);
    }

    /* Go to record number 2. */
    if (fseek(fptr, pos, 0) < 0) {
        perror("fseek"); /* Exit on fseek error. */
        exit(EXIT_FAILURE);
    }

    /* Read record 2 in the buffer. */
    if (fgets(buffer, 32, fptr) == NULL) {
        perror("fgets"); /* Exit on fgets error. */
        exit(EXIT_FAILURE);
    }

    /* Print the buffer. */
    printf("Data in record 2 is: %s", buffer);
    fclose(fptr); /* Close the file. */
}

```

Running Example 2–2 produces the following result:

```

$ RUN EXAMPLE
Data in record 2 is: test data line 2

```

The output to DATA.DAT from Example 2-2 is:

```
test data line 1
test data line 2
test data line 3
test data line 4
```

Example 2-3 Using Wide Character I/O Functions

```
/*      CHAP_2_WC_IO.C      */
/* This program establishes a file pointer, writes lines from */
/* a buffer to the file using wide-character codes, moves the */
/* file pointer to the second record, copies the record to the */
/* wide-character buffer, and then prints the buffer to the */
/* screen.      */
#include <stdio.h>
#include <stdlib.h>
#include <wchar.h>

main()
{
    char flat_buffer[32];
    wchar_t wide_buffer[32];
    wchar_t format[32];
    int i,
        pos;
    FILE *fptr;

    /* Set file pointer.      */
    fptr = fopen("data.dat", "w+");
    if (fptr == NULL) {
        perror("fopen");
        exit(EXIT_FAILURE);
    }

    for (i = 1; i < 5; i++) {
        if (i == 2) /* Get position of record 2. */
            pos = ftell(fptr);
        /* Print a line to the buffer. */
        sprintf(flat_buffer, "test data line %d\n", i);
        if (mbstowcs(wide_buffer, flat_buffer, 32) == -1) {
            perror("mbstowcs");
            exit(EXIT_FAILURE);
        }

        /* Print buffer to the record. */
        fputws(wide_buffer, fptr);
    }

    /* Go to record number 2. */
    if (fseek(fptr, pos, 0) < 0) {
        perror("fseek"); /* Exit on fseek error. */
        exit(EXIT_FAILURE);
    }
}
```

(continued on next page)

Example 2–3 (Cont.) Using Wide Character I/O Functions

```
/* Put record 2 in the buffer. */
if (fgetws(wide_buffer, 32, fptr) == NULL) {
    perror("fgetws"); /* Exit on fgets error. */
    exit(EXIT_FAILURE);
}
/* Print the buffer. */
printf("Data in record 2 is: %S", wide_buffer);
fclose(fptr); /* Close the file. */
}
```

Running Example 2–3 produces the following result:

```
$ RUN EXAMPLE
Data in record 2 is: test data line 2
```

The output to DATA.DAT from Example 2–3 is:

```
test data line 1
test data line 2
test data line 3
test data line 4
```

Example 2–4 shows the use of both a file pointer and a file descriptor to access a single file.

Example 2–4 I/O Using File Descriptors and Pointers

```
/*      CHAP_2_FILE_DIS_AND_POINTER.C      */
/* The following example creates a file with variable-length */
/* records (rfm=var) and the carriage-return attribute (rat=cr).*/
/* */
/* The program uses creat to create and open the file, and */
/* fdopen to associate the file descriptor with a file pointer. */
/* After using the fdopen function, the file must be referenced */
/* using the Standard I/O functions.      */

#include <unixio.h>
#include <stdio.h>
#include <stdlib.h>
#include <string.h>
#define ERROR 0
#define ERROR1 -1
#define BUFFSIZE 132

main()
{
    char buffer[BUFFSIZE];
    int fildes;
    FILE *fp;

    if ((fildes = creat("data.dat", 0, "rat=cr",
                      "rfm=var")) == ERROR1) {
        perror("DATA.DAT: creat() failed\n");
        exit(EXIT_FAILURE);
    }
}
```

(continued on next page)

Example 2–4 (Cont.) I/O Using File Descriptors and Pointers

```
if ((fp = fdopen(fildes, "w")) == NULL) {
    perror("DATA.DAT: fdopen() failed\n");
    exit(EXIT_FAILURE);
}
while (fgets(buffer, BUFSIZE, stdin) != NULL)
    if (fwrite(buffer, strlen(buffer), 1, fp) == ERROR) {
        perror("DATA.DAT: fwrite() failed\n");
        exit(EXIT_FAILURE);
    }
if (fclose(fp) == EOF) {
    perror("DATA.DAT: fclose() failed\n");
    exit(EXIT_FAILURE);
}
}
```

Character, String, and Argument-List Functions

Table 3–1 describes the character, string, and argument-list functions in the HP C Run-Time Library (RTL). Although further discussion follows in this chapter, see the Reference Section for more detailed information on each function.

Table 3–1 Character, String, and Argument-List Functions

Function	Description
Character Classification	
isalnum, iswalnum	Returns a nonzero integer if its argument is one of the alphanumeric characters in the current locale.
isalpha, iswalpha	Returns a nonzero integer if its argument is one of the alphabetic characters in the current locale.
isascii	Returns a nonzero integer if its argument is any ASCII character.
isctrl, iswctrl	Returns a nonzero integer if its argument is a control character in the current locale.
isdigit, iswdigit	Returns a nonzero integer if its argument is a digit character in the current locale.
isgraph, iswgraph	Returns a nonzero integer if its argument is a graphic character in the current locale.
islower, iswlower	Returns a nonzero integer if its argument is a lowercase character in the current locale.
isprint, iswprint	Returns a nonzero integer if its argument is a printing character in the current locale.
ispunct, iswpunct	Returns a nonzero integer if its argument is a punctuation character in the current locale.
isspace, iswspace	Returns a nonzero integer if its argument is a white-space character in the current locale.
isupper, iswupper	Returns a nonzero integer if its argument is an uppercase character in the current locale.
iswctype	Returns a nonzero integer if its argument has the specified property.
isxdigit, iswxdigit	Returns a nonzero integer if its argument is a hexadecimal digit (0 to 9, A to F, or a to f).

(continued on next page)

Table 3–1 (Cont.) Character, String, and Argument-List Functions

Function	Description
Character Conversion	
<code>btowc</code>	Converts a one-byte multibyte character to a wide character in the initial shift state.
<code>ecvt, fcvt, gcvt</code>	Converts an argument to a null-terminated string of ASCII digits and return the address of the string.
<code>index, rindex</code>	Searches for a character in a string.
<code>mblen, mbrlen</code>	Determines the number of bytes in a multibyte character.
<code>mbsinit</code>	Determines whether an <code>mbstate_t</code> object describes an initial conversion state.
<code>mbstowcs</code>	Converts a sequence of multibyte characters into a sequence of corresponding codes.
<code>toascii</code>	Converts its argument, an 8-bit ASCII character, to a 7-bit ASCII character.
<code>tolower, _tolower, towlower</code>	Converts its argument, an uppercase character, to lowercase.
<code>toupper, _toupper, towupper</code>	Converts its argument, a lowercase character, to uppercase.
<code>towctrans</code>	Maps one wide character to another according to a specified mapping descriptor.
<code>wcstombs</code>	Converts a sequence of wide-character codes corresponding to multibyte characters to a sequence of multibyte characters.
<code>wctob</code>	Determines if a wide character corresponds to a single-byte multibyte character and returns its multibyte character representation.
<code>wctomb</code>	Converts a wide character to its multibyte character representation.
<code>wctrans</code>	Returns the description of a mapping, corresponding to specified property, that can be later used in a call to <code>towctrans</code> .
<code>wctype</code>	Converts a valid character class defined for the current locale to an object of type <code>wctype_t</code> .
String Manipulation	
<code>atof</code>	Converts a given string to a double-precision number.
<code>atoi, atol</code>	Converts a given string of ASCII characters to the appropriate numeric values.
<code>atoll, atog</code> <i>(Integrity servers, Alpha)</i>	Converts a given string of ASCII characters to an <code>__int64</code> .
<code>basename</code>	Returns the last component of a path name.
<code>dirname</code>	Reports the parent directory name of a file path name.
<code>strcat, strncat, wscat, wcsncat</code>	Appends one string to the end of another string.
<code>strchr, strchr, wcschr, wcsrchr</code>	Returns the address of the first or last occurrence of a given character in a null-terminated string.

(continued on next page)

Table 3–1 (Cont.) Character, String, and Argument-List Functions

Function	Description
String Manipulation	
<code>strcmp</code> , <code>strncmp</code> , <code>strcoll</code> , <code>wscmp</code> , <code>wscncmp</code> , <code>wscoll</code>	Compares two character strings and returns a negative, zero, or positive integer indicating that the values of the individual characters in the first string are less than, equal to, or greater than the values in the second string.
<code>strcpy</code> , <code>strncpy</code> , <code>wscpy</code> , <code>wcsncpy</code>	Copies all or part of one string into another.
<code>strxfrm</code> , <code>wcsxfrm</code>	Transforms a multibyte string to another string ready for comparisons using the <code>strcmp</code> or <code>wscmp</code> function.
<code>strcspn</code> , <code>wscspn</code>	Searches a string for a character that is in a specified set of characters.
<code>strlen</code> , <code>wcslen</code>	Returns the length of a string of characters. The returned length does not include the terminating null character (<code>\0</code>).
<code>strpbrk</code> , <code>wcspbrk</code>	Searches a string for the occurrence of one of a specified set of characters.
<code>strspn</code> , <code>wcsspn</code>	Searches a string for the occurrence of a character that is not in a specified set of characters.
<code>strstr</code> , <code>wcs wcs</code>	Searches a string for the first occurrence of a specified set of characters.
<code>strtod</code> , <code>wcstod</code>	Converts a given string to a double-precision number.
<code>strtok</code> , <code>wcstok</code>	Locates text tokens in a given string.
<code>strtol</code> , <code>wcstol</code>	Converts the initial portion of a string to a signed long integer.
<code>strtoll</code> , <code>strtog</code> <i>(Integrity servers, Alpha)</i>	Converts the initial portion of a string to signed <code>__int64</code> .
<code>strtoul</code> , <code>wcstoul</code>	Converts the initial portion of a string to an unsigned long integer.
<code>strtoull</code> , <code>strtoug</code> <i>(Integrity servers, Alpha)</i>	Converts the initial portion of the string pointed to by the pointer to the character string to an unsigned <code>__int64</code> .
String Handling—Accessing Binary Data	
<code>bcmp</code>	Compares byte strings.
<code>bcopy</code>	Copies byte strings.
<code>bzero</code>	Copies nulls into byte strings.
<code>memchr</code> , <code>wmemchr</code>	Locates the first occurrence of the specified byte within the initial length of the object to be searched.
<code>memcmp</code> , <code>wmemcmp</code>	Compares two objects byte by byte.
<code>memcpy</code> , <code>memmove</code> , <code>wmemcpy</code> , <code>wmemmove</code>	Copies a specified number of bytes from one object to another.
<code>memset</code> , <code>wmemset</code>	Sets a specified number of bytes in a given object to a given value.

(continued on next page)

Table 3–1 (Cont.) Character, String, and Argument-List Functions

Function	Description
Argument-List Handling—Accessing a Variable-Length Argument List	
<code>va_arg</code>	Returns the next item in the argument list.
<code>va_count</code>	Returns the number of quadwords (<i>Alpha only</i>) in the argument list.
<code>va_end</code>	Finishes the <code>va_start</code> session.
<code>va_start</code> , <code>va_start_1</code>	Initializes a variable to the beginning of the argument list.
<code>vfprintf</code> , <code>vprintf</code> , <code>vsprintf</code>	Prints formatted output based on an argument list.

3.1 Character-Classification Functions

The character-classification functions take a single argument on which they perform a logical operation. The argument can have any value; it does not have to be an ASCII character. The `isascii` function determines if the argument is an ASCII character (0 through 177 octal). The other functions determine whether the argument is a particular type of ASCII character, such as a graphic character or digit. The `isw*` functions test wide characters. Character-classification information is in the `LC_CTYPE` category of the program's current locale.

For all functions, a positive return value indicates TRUE. A return value of 0 indicates FALSE.

To briefly reference the character-classification functions in a subsequent table, each function is assigned a number, as shown in Table 3–2.

Table 3–2 Character-Classification Functions

Function Number	Function	Function Number	Function
1	<code>isalnum</code>	7	<code>islower</code>
2	<code>isalpha</code>	8	<code>isprint</code>
3	<code>isascii</code>	9	<code>ispunct</code>
4	<code>iscntrl</code>	10	<code>isspace</code>
5	<code>isdigit</code>	11	<code>isupper</code>
6	<code>isgraph</code>	12	<code>isxdigit</code>

Table 3–3 lists the numbers of the functions (as assigned in Table 3–2) that return the value TRUE for each of the given ASCII characters. The numeric code represents the octal value of each of the ASCII characters.

Table 3–3 ASCII Characters and the Character-Classification Functions

ASCII Values	Function Numbers	ASCII Values	Function Numbers
NUL 00	3,4	@ 100	3,6,8,9
SOH 01	3,4	A 101	1,2,3,6,8,11,12
STX 02	3,4	B 102	1,2,3,6,8,11,12
ETX 03	3,4	C 103	1,2,3,6,8,11,12
EOT 04	3,4	D 104	1,2,3,6,8,11,12
ENQ 05	3,4	E 105	1,2,3,6,8,11,12
ACK 06	3,4	F 106	1,2,3,6,8,11,12
BEL 07	3,4	G 107	1,2,3,6,8,11
BS 10	3,4	H 110	1,2,3,6,8,11
HT 11	3,4,10	I 111	1,2,3,6,8,11
LF 12	3,4,10	J 112	1,2,3,6,8,11
VT 13	3,4,10	K 113	1,2,3,6,8,11
FF 14	3,4,10	L 114	1,2,3,6,8,11
CR 15	3,4,10	M 115	1,2,3,6,8,11
SO 16	3,4	N 116	1,2,3,6,8,11
SI 17	3,4	O 117	1,2,3,6,8,11
DLE 20	3,4	P 120	1,2,3,6,8,11
DC1 21	3,4	Q 121	1,2,3,6,8,11
DC2 22	3,4	R 122	1,2,3,6,8,11
DC3 23	3,4	S 123	1,2,3,6,8,11
DC4 24	3,4	T 124	1,2,3,6,8,11
NAK 25	3,4	U 125	1,2,3,6,8,11
SYN 26	3,4	V 126	1,2,3,6,8,11
ETB 27	3,4	W 127	1,2,3,6,8,11
CAN 30	3,4	X 130	1,2,3,6,8,11
EM 31	3,4	Y 131	1,2,3,6,8,11
SUB 32	3,4	Z 132	1,2,3,6,8,11
ESC 33	3,4	[133	3,6,8,9
FS 34	3,4	\ 134	3,6,8,9
GS 35	3,4] 135	3,6,8,9
RS 36	3,4	^ 136	3,6,8,9
US 37	3,4	- 137	3,6,8,9
SP 40	3,8,10	` 140	3,6,8,9
! 41	3,6,8,9	a 141	1,2,3,6,7,8,12

(continued on next page)

Table 3–3 (Cont.) ASCII Characters and the Character-Classification Functions

ASCII Values	Function Numbers	ASCII Values	Function Numbers
" 42	3,6,8,9	b 142	1,2,3,6,7,8,12
# 43	3,6,8,9	c 143	1,2,3,6,7,8,12
\$ 44	3,6,8,9	d 144	1,2,3,6,7,8,12
% 45	3,6,8,9	e 145	1,2,3,6,7,8,12
& 46	3,6,8,9	f 146	1,2,3,6,7,8,12
' 47	3,6,8,9	g 147	1,2,3,6,7,8
(50	3,6,8,9	h 150	1,2,3,6,7,8
) 51	3,6,8,9	i 151	1,2,3,6,7,8
* 52	3,6,8,9	j 152	1,2,3,6,7,8
+ 53	3,6,8,9	k 153	1,2,3,6,7,8
' 54	3,6,8,9	l 154	1,2,3,6,7,8
- 55	3,6,8,9	m 155	1,2,3,6,7,8
. 56	3,6,8,9	n 156	1,2,3,6,7,8
/ 57	3,6,8,9	o 157	1,2,3,6,7,8
0 60	1,3,5,6,8,12	p 160	1,2,3,6,7,8
1 61	1,3,5,6,8,12	q 161	1,2,3,6,7,8
2 62	1,3,5,6,8,12	r 162	1,2,3,6,7,8
3 63	1,3,5,6,8,12	s 163	1,2,3,6,7,8
4 64	1,3,5,6,8,12	t 164	1,2,3,6,7,8
5 65	1,3,5,6,8,12	u 165	1,2,3,6,7,8
6 66	1,3,5,6,8,12	v 166	1,2,3,6,7,8
7 67	1,3,5,6,8,12	w 167	1,2,3,6,7,8
8 70	1,3,5,6,8,12	x 170	1,2,3,5,6,8
9 71	1,3,5,6,8,12	y 171	1,2,3,5,6,8
: 72	3,6,8,9	z 172	1,2,3,5,6,8
; 73	3,6,8,9	{ 173	3,6,8,9
< 74	3,6,8,9	174	3,6,8,9
= 75	3,6,8,9	} 175	3,6,8,9
> 76	3,6,8,9	~ 176	3,6,8,9
? 77	3,6,8,9	DEL 177	3,4

Example 3–1 shows how the character-classification functions are used.

Example 3–1 Character-Classification Functions

```
/*      CHAP_3_CHARCLASS.C      */
/* This example uses the isalpha, isdigit, and isspace      */
/* functions to count the number of occurrences of letters, */
/* digits, and white-space characters entered through the   */
/* standard input (stdin).                                   */

#include <ctype.h>
#include <stdio.h>
#include <stdlib.h>

main()
{
    char c;
    int i = 0,
        j = 0,
        k = 0;

    while ((c = getchar()) != EOF) {
        if (isalpha(c))
            i++;
        if (isdigit(c))
            j++;
        if (isspace(c))
            k++;
    }

    printf("Number of letters: %d\n", i);
    printf("Number of digits:  %d\n", j);
    printf("Number of spaces:  %d\n", k);
}
```

The sample input and output from Example 3–1 follows:

```
$ RUN EXAMPLE1
I saw 35 people riding bicycles on Main Street.  

Number of letters: 36
Number of digits:  2
Number of spaces:  8
$
```

3.2 Character-Conversion Functions

The character-conversion functions convert one type of character to another type. These functions include:

ecvt	tolower
fcvt	toupper
gcvt	toupper
mbtowc	towctrans
mbrtowc	wctrans
mbsrtowcs	wcrtomb
toascii	wcsrtombs
tolower	

For more information on each of these functions, see the Reference Section.

Example 3–2 shows how to use the `ecvt` function.

Example 3–2 Converting Double Values to an ASCII String

```
/*      CHAP_3_CHARCONV.C                                */
/* This program uses the ecvt function to convert a double */
/* value to a string. The program then prints the string. */
#include <stdio.h>
#include <stdlib.h>
#include <unistd.h>
#include <string.h>

main()
{
    double val;          /* Value to be converted */
    int sign,            /* Variables for sign */
        point;          /* and decimal place */

    /* Array for the converted string */
    static char string[20];

    val = -3.1297830e-10;

    printf("original value: %e\n", val);
    if (sign)
        printf("value is negative\n");
    else
        printf("value is positive\n");
    printf("decimal point at %d\n", point);
}
```

The output from Example 3–2 is as follows:

```
$ RUN EXAMPLE2
original value: -3.129783e-10
converted string: 31298
value is negative
decimal point at -9
$
```

Example 3–3 shows how to use the `toupper` and `tolower` functions.

Example 3–3 Changing Characters to and from Uppercase Letters

```
/*      CHAP_3_CONV_UPPERLOWER.C                        */
/* This program uses the functions toupper and tolower to */
/* convert uppercase to lowercase and lowercase to uppercase */
/* using input from the standard input (stdin).          */
#include <ctype.h>
#include <stdio.h>      /* To use EOF identifier */
#include <stdlib.h>

main()
{
    char c,
        ch;
```

(continued on next page)

Example 3–3 (Cont.) Changing Characters to and from Uppercase Letters

```
while ((c = getchar()) != EOF) {
    if (c >= 'A' && c <= 'Z')
        ch = tolower(c);
    else
        ch = toupper(c);
    putchar(ch);
}
```

Sample input and output from Example 3–3 are as follows:

```
$ RUN EXAMPLE3
LET'S GO TO THE welcome INN. Ctrl/Z
let's go to the WELCOME inn.
$
```

3.3 String and Argument-List Functions

The HP C RTL contains a group of functions that manipulate strings. Some of these functions concatenate strings; others search a string for specific characters or perform some other comparison, such as determining the equality of two strings.

The HP C RTL also contains a set of functions that allow you to copy buffers containing binary data.

The set of functions defined and declared in the `<varargs.h>` and the `<stdarg.h>` header files provide a method of accessing variable-length argument lists. The `<stdarg.h>` functions are defined by the ANSI C Standard and are more portable than those defined in `<varargs.h>`.

The RTL functions such as `printf` and `execl`, for example, use variable-length argument lists. User-defined functions with variable-length argument lists that do not use `<varargs.h>` or `<stdarg.h>` are not portable due to the different argument-passing conventions of various machines.

The `<stdarg.h>` header file does not contain `va_alist` and `va_dcl`. The following shows a syntax example when using `<stdarg.h>`:

```
function_name(int arg1, ...)
{
```

```
    va_list ap;
    ...
```

When using `<varargs.h>`:

- The identifier `va_alist` is a parameter in the function definition.
- `va_dcl` declares the parameter `va_alist`, a declaration that is not terminated with a semicolon (;).
- The type `va_list` is used in the declaration of the variable used to traverse the list. You must declare at least one variable of type `va_list` when using `<varargs.h>`.

These names and declarations have the following syntax:

```
function_name(int arg1, ... )
{
    va_list ap;
    .
    .
    .
}
```

3.4 Program Examples

Example 3–4 shows how to use the `strcat` and `strncat` functions.

Example 3–4 Concatenating Two Strings

```
/*          CHAP_3_CONCAT.C          */
/* This example uses strcat and strncat to concatenate two */
/* strings.                                          */
#include <stdio.h>
#include <string.h>
main()
{
    static char string1[80] = "Concatenates ";
    static char string2[] = "two strings ";
    static char string3[] = "up to a maximum of characters.";
    static char string4[] = "imum number of characters";

    printf("strcat:\t%s\n", strcat(string1, string2));
    printf("strncat ( 0):\t%s\n", strncat(string1, string3, 0));
    printf("strncat (11):\t%s\n", strncat(string1, string3, 11));
    printf("strncat (40):\t%s\n", strncat(string1, string4, 40));
}
```

Example 3–4 produces the following output:

```
$ RUN EXAMPLE1
strcat: Concatenates two strings
strncat ( 0): Concatenates two strings
strncat (11): Concatenates two strings up to a max
strncat (40): Concatenates two strings up to a maximum number of characters.
$
```

Example 3–5 shows how to use the `strcspn` function.

Example 3–5 Four Arguments to the `strcspn` Function

```
/*          CHAP_3_STRCSPN.C          */
/* This example shows how strcspn interprets four */
/* different kinds of arguments.                */
#include <stdio.h>
main()
{
    printf("strcspn with null charset: %d\n",
           strcspn("abcdef", ""));
}
```

(continued on next page)

Example 3–5 (Cont.) Four Arguments to the strcspn Function

```
printf("strcspn with null string: %d\n",
      strcspn("", "abcdef"));

printf("strcspn(\"xabc\", \"abc\"): %d\n",
      strcspn("xabc", "abc"));

printf("strcspn(\"abc\", \"def\"): %d\n",
      strcspn("abc", "def"));
}
```

The sample output, to the file `strcspn.out`, in Example 3–5 is as follows:

```
$ RUN EXAMPLE2

strcspn with null charset: 6
strcspn with null string: 0
strcspn("xabc","abc"): 1
strcspn("abc","def"): 3
```

Example 3–6 shows how to use the `<stdarg.h>` functions and definitions.

Example 3–6 Using the `<stdarg.h>` Functions and Definitions

```
/*          CHAP_3_STDARG.C          */
/* This routine accepts a variable number of string arguments, */
/* preceded by a count of the number of such strings. It      */
/* allocates enough space in which to concatenate all of the  */
/* strings, concatenates them together, and returns the address */
/* of the new string. It returns NULL if there are no string   */
/* arguments, or if they are all null strings.                 */
#include <stdarg.h>      /* Include appropriate header files */
#include <stdlib.h>      /* for the "example" call in main. */
#include <string.h>
#include <stdio.h>

/* NSTRINGS is the maximum number of string arguments accepted */
/* (arbitrary).                                                 */
#define NSTRINGS 10

char *concatenate(int n,...)
{
    va_list ap;          /* Declare the argument pointer. */
    char *list[NSTRINGS],
          *string;
    int index = 0,
        size = 0;

    /* Check that the number of arguments is within range. */
    if (n <= 0)
        return NULL;
    if (n > NSTRINGS)
        n = NSTRINGS;

    va_start(ap, n);    /* Initialize the argument pointer. */
    do {
        /* Extract the next argument and save it. */
        list[index] = va_arg(ap, char *);
```

(continued on next page)

Example 3–6 (Cont.) Using the <stdarg.h> Functions and Definitions

```
        size += strlen(list[index]);
    } while (++index < n);
    va_end(ap); /* Terminate use of ap. */
    if (size == 0)
        return NULL;
    string = malloc(size + 1);
    string[0] = '\0';
    /* Append each argument to the end of the growing result    */
    /* string.                                                  */
    for (index = 0; index < n; ++index)
        strcat(string, list[index]);
    return string;
}
/* An example of calling this routine is */
main() {
    char *ret_string ;
    ret_string = concatenate(7, "This ", "message ", "is ",
                             "built with ", "a", " variable arg",
                             " list."); ;
    puts(ret_string) ;
}
```

The call to Example 3–6 produces the following output:

This message is built with a variable arg list.

Error and Signal Handling

Table 4–1 lists and describes all the error- and signal-handling functions found in the HP C Run-Time Library (RTL). For more detailed information on each function, see the Reference Section.

Table 4–1 Error- and Signal-Handling Functions

Function	Description
abort	Raises the signal SIGABRT that terminates the execution of the program.
assert	Puts diagnostics into programs.
atexit	Registers a function to be called at program termination.
exit, _exit	Terminates the current program.
perror	Writes a short error message to <code>stderr</code> describing the current <code>errno</code> value.
strerror	Maps the error code in <code>errno</code> to an error message string.
alarm	Sends the signal SIGALARM to the invoking process after the number of seconds indicated by its argument has elapsed.
gsignal	Generates a specified software signal.
kill	Sends a SIGKILL signal to the process specified by a process ID.
longjmp	Transfers control from a nested series of function invocations back to a predefined point without returning normally.
pause	Causes the process to wait until it receives a signal.
raise	Generates a specified signal.
setjmp	Establishes the context for a later transfer of control from a nested series of function invocations, without returning normally.
sigaction	Specifies the action to take upon delivery of a signal.
sigaddset	Adds the specified individual signal.
sigblock	Causes the signals in its argument to be added to the current set of signals being blocked from delivery.
sigdelset	Deletes a specified individual signal.
sigemptyset	Initializes the signal set to exclude all signals.
sigfillset	Initializes the signal set to include all signals.
sighold	Adds the specified signal to the calling process's signal mask.
sigignore	Sets the disposition of the specified signal to SIG_IGN.

(continued on next page)

Table 4–1 (Cont.) Error- and Signal-Handling Functions

Function	Description
sigismember	Tests whether a specified signal is a member of the signal set.
siglongjmp	Nonlocal goto with signal handling.
sigmask	Constructs the mask for a given signal number.
signal	Catches or ignores a signal.
sigpause	Blocks a specified set of signals and then waits for a signal that was not blocked.
sigpending	Examines pending signals.
sigprocmask	Sets the current signal mask.
sigrelse	Removes the specified signal from the calling process's signal mask.
sigsetjmp	Sets the jump point for a nonlocal goto.
sigsetmask	Establishes the signals that are blocked from delivery.
sigsuspend	Atomically changes the set of blocked signals and waits for a signal.
sigtimedwait	Suspends a calling thread and waits for queued signals to arrive.
sigvec	Permanently assigns a handler for a specific signal.
sigwait	Suspends a calling thread and waits for queued signals to arrive.
sigwaitinfo	Suspends a calling thread and waits for queued signals to arrive.
ssignal	Allows you to specify the action to be taken when a particular signal is raised.
VAXC\$ESTABLISH	Establishes an application exception handler in a way that is compatible with HP C RTL exception handling.

4.1 Error Handling

When an error occurs during a call to any of the HP C RTL functions, the function returns an unsuccessful status. Many RTL routines also set the external variable `errno` to a value that indicates the reason for the failure. You should always check the return value for an error situation.

The `<errno.h>` header file declares `errno` and symbolically defines the possible error codes. By including the `<errno.h>` header file in your program, you can check for specific error codes after a HP C RTL function call.

At program startup, the value of `errno` is 0. The value of `errno` can be set to a nonzero value by many HP C RTL functions. It is not reset to 0 by any HP C RTL function, so it is only valid to use `errno` after a HP C RTL function call has been made and a failure status returned. Table 4–2 lists the symbolic values that may be assigned to `errno` by the HP C RTL.

Table 4-2 The Error Code Symbolic Values

Symbolic Constant	Description
E2BIG	Argument list too long
EACCES	Permission denied
EADDRINUSE	Address already in use
EADDRNOTAVAIL	Can't assign requested address
EAFNOSUPPORT	Address family not supported
EAGAIN	No more processes
EALIGN	Alignment error
EALREADY	Operation already in progress
EBADF	Bad file number
EBADCAT	Bad message catalog format
EBADMSG	Corrupted message detected
EBUSY	Mount device busy
ECANCELED	Operation canceled
ECHILD	No children
ECONNABORTED	Software caused connection abort
ECONNREFUSED	Connection refused
ECONNRESET	Connection reset by peer
EDEADLK	Resource deadlock avoided
EDESTADDRREQ	Destination address required
EDOM	Math argument
EDQUOT	Disk quota exceeded
EEXIST	File exists
EFAIL	Cannot start operation
EFAULT	Bad address
EFBIG	File too large
EFTYPE	Inappropriate operation for file type
EHOSTDOWN	Host is down
EHOSTUNREACH	No route to host
EIDRM	Identifier removed
EILSEQ	Illegal byte sequence
EINPROGRESS	Operation now in progress
EINPROG	Asynchronous operation in progress
EINTR	Interrupted system call
EINVAL	Invalid argument
EIO	I/O error
EISCONN	Socket is already connected
EISDIR	Is a directory
ELOOP	Too many levels of symbolic links

(continued on next page)

Table 4–2 (Cont.) The Error Code Symbolic Values

Symbolic Constant	Description
EMFILE	Too many open files
EMLINK	Too many links
EMSGSIZE	Message too long
ENAMETOOLONG	Filename too long
ENETDOWN	Network is down
ENETRESET	Network dropped connection on reset
ENETUNREACH	Network is unreachable
ENFILE	File table overflow
ENOBUFS	No buffer space available
ENODEV	No such device
ENOENT	No such file or directory
ENOEXEC	Exec format error
ENOLCK	No locks available
ENOMEM	Not enough core
ENOMSG	No message of desired type
ENOPROTOPT	Protocol not available
ENOSPC	No space left on device
ENOSYS	Function not implemented
ENOTBLK	Block device required
ENOTCONN	Socket is not connected
ENOTDIR	Not a directory
ENOTEMPTY	Directory not empty
ENOTSOCK	Socket operation on nonsocket
ENOTSUP	Function not implemented
ENOTTY	Not a typewriter
ENWAIT	No waiting processes
ENXIO	No such device or address
EOPNOTSUPP	Operation not supported on socket
EPERM	Not owner
EPFNOSUPPORT	Protocol family not supported
EPIPE	Broken pipe
EPROCLIM	Too many processes
EPROTONOSUPPORT	Protocol not supported
EPROTOTYPE	Protocol wrong type for socket
ERANGE	Result too large
EREMOTE	Too many levels of remote in path
EROFS	Read-only file system
ESHUTDOWN	Can't send after socket shutdown

(continued on next page)

Table 4–2 (Cont.) The Error Code Symbolic Values

Symbolic Constant	Description
ESOCKTNOSUPPORT	Socket type not supported
ESPIPE	Illegal seek
ESRCH	No such process
ESTALE	Stale NFS file handle
ETIMEDOUT	Connection timed out
ETOOMANYREFS	Too many references: can't splice
ETXTBSY	Text file busy
EUSERS	Too many users
EVMSError	OpenVMS specific nontranslatable error code
EWouldBlock	I/O operation would block channel
EXDEV	Cross-device link

You can translate the error codes to a message, similar to that found in UNIX systems, by using the `perror` or `strerror` function. If `errno` is set to `EVMSError`, `perror` cannot translate the error code and prints the following message, followed by the OpenVMS error message associated with the value:

```
%s:nontranslatable vms error code: xxxxxx vms message:
```

In the message, `%s` is the string you supply to `perror`; `xxxxxx` is the OpenVMS condition value.

If `errno` is set to `EVMSError`, then the OpenVMS condition value is available in the `vaxc$errno` variable declared in the `<errno.h>` header file. The `vaxc$errno` variable is guaranteed to have a valid value only if `errno` is set to `EVMSError`; if `errno` is set to a value other than `EVMSError`, the value of `vaxc$errno` is undefined.

See the `strerror` function in the Reference Section for another way to translate error codes.

4.2 Signal Handling

A signal is a form of software interrupt to the normal execution of a user process. Signals occur as a result of a variety of events, including any of the following:

- Typing Ctrl/C at a terminal
- Certain programming errors
- A call to the `gsignal` or `raise` function
- A wake-up action

4.2.1 OpenVMS Versus UNIX Terminology

Both OpenVMS and UNIX systems provide signal-handling mechanisms that behave differently but use similar terminology. With the HP C RTL, you can program using either signal-handling mechanism. Before describing the signal-handling routines, some terminology must be established.

The UNIX term for a software interrupt is *signal*. A routine called by the UNIX system to process a signal is termed a *signal handler*.

A software interrupt on an OpenVMS system is referred to as a *signal, condition, or exception*. A routine called by the OpenVMS system to process software interrupts is termed a *signal handler, condition handler, or exception handler*.

To prevent confusion, the terms *signal* and *signal handler* in this manual refer to UNIX interrupts and interrupt processing routines, while the terms *exception* and *exception handler* refer to OpenVMS interrupts and interrupt processing routines.

4.2.2 UNIX Signals and the HP C RTL

Signals are represented by mnemonics defined in the <signal.h> header file. Table 4–3 lists the supported signal mnemonics and the corresponding event that causes each signal to be generated on the OpenVMS operating system.

Table 4–3 HP C RTL Signals

Name	Description	Generated by
SIGABRT ¹	Abort	abort()
SIGALRM	Alarm clock	Timer AST, alarm routine
SIGBUS	Bus error	Access violation or change mode user
SIGCHLD	Child process stopped	Child process terminated or stopped
SIGEMT	EMT instruction	Compatibility mode trap or opcode reserved to customer
SIGFPE	Floating-point exception	Floating-point overflow/underflow
SIGHUP	Hang up	Data set hang up
SIGILL ¹	Illegal instruction	Illegal instruction, reserved operand, or reserved address mode
SIGINT ⁴	Interrupt	OpenVMS Ctrl/C interrupt
SIGIOT ¹	IOT instruction	Opcode reserved to customer
SIGKILL ^{2, 3}	Kill	External signal only
SIGQUIT ⁵	Quit	Not implemented.
SIGPIPE	Broken pipe	Write to a pipe with no readers.
SIGSEGV	Segment violation	Length violation or change mode user
SIGSYS	System call error	Bad argument to system call
SIGTERM	Software terminate	External signal only
SIGTRAP ¹	Trace trap	TBIT trace trap or breakpoint fault instruction

¹Cannot be reset when intercepted.

²Cannot be intercepted or ignored.

³Cannot be blocked.

⁴Setting SIGINT can affect processing of Ctrl/Y interrupts. For example, in response to a caller's request to block or ignore SIGINT, the HP C RTL disables the Ctrl/Y interrupt.

⁵"Not implemented" for SIGQUIT means that there is no external event, including a Ctrl/Y interrupt, that would trigger a SIGQUIT signal, thereby causing a signal handler established for SIGQUIT to be invoked. This signal can be generated only through an appropriate HP C RTL function, such as raise.

(continued on next page)

Table 4–3 (Cont.) HP C RTL Signals

Name	Description	Generated by
SIGUSR1	User-defined signal	Explicit program call to raise the signal
SIGUSR2	User-defined signal	Explicit program call to raise the signal
SIGWINCH ⁶	Window size changed	Explicit program call to raise the signal

⁶Supported on OpenVMS Version 7.3 and higher.

By default, when a signal (except for SIGCHLD) occurs, the process is terminated. However, you can choose to have the signal ignored by using one of the following functions:

```
sigaction
signal
sigvec
ssignal
```

You can have the signal blocked by using one of the following functions:

```
sigblock
sigsetmask
sigprocmask
sigsuspend
sigpause
```

Table 4–3 indicates those signals that cannot be ignored or blocked.

You can also establish a signal handler to catch and process a signal by using one of the following functions:

```
sigaction
signal
sigvec
ssignal
```

Unless noted in Table 4–3, each signal can be reset. A signal is reset if the signal handler function calls `signal` or `ssignal` to re-establish itself to catch the signal. Example 4–1 shows how to establish a signal handler and reset the signal.

The calling interface to a signal handler is:

```
void handler (int sigint);
```

Where *sigint* is the signal number of the raised signal that caused this handler to be called.

A signal handler installed with `sigvec` remains installed until it is changed.

A signal handler installed with `signal` or `signal` remains installed until the signal is generated.

A signal handler can be installed for more than one signal. Use the `sigaction` routine with the `SA_RESETHAND` flag to control this.

4.2.3 Signal-Handling Concepts

A signal is said to be *generated* for (or sent to) a process when the event that causes the signal first occurs. Examples of such events include detection of hardware faults, timer expiration, and terminal activity, as well as the invocation of kill. In some circumstances, the same event generates signals for multiple processes.

Each process has an action to be taken in response to each signal defined by the system. A signal is said to be *delivered* to a process when the appropriate action for the process and signal is taken.

During the time between the generation of a signal and its delivery, the signal is said to be *pending*. Ordinarily, this interval cannot be detected by an application. However, a signal can be *blocked* from delivery to a process:

- If the action associated with a blocked signal is anything other than to ignore the signal, and if that signal is generated for the process, the signal remains pending until either it is unblocked or the action associated with it is set to ignore the signal.
- If the action associated with a blocked signal is to ignore the signal and if that signal is generated for the process, it is unspecified whether the signal is discarded immediately upon generation or remains pending.

Each process has a *signal mask* that defines the set of signals currently blocked from delivery to it. The signal mask for a process is initialized from that of its parent. The sigaction, sigprocmask, and sigsuspend functions control the manipulation of the signal mask.

The determination of which action is taken in response to a signal is made at the time the signal is delivered, allowing for any changes since the time of generation. This determination is independent of the means by which the signal was originally generated. If a subsequent occurrence of a pending signal is generated, it is implementation-dependent as to whether the signal is delivered more than once. The HP C RTL delivers the signal only once. The order in which multiple, simultaneously pending signals are delivered to a process is unspecified.

4.2.4 Signal Actions

This section applies to the sigaction, signal, sigvec, and ssignal functions.

There are three types of action that can be associated with a signal:

```
SIG_DFL
SIG_IGN
pointer to a function
```

Initially, all signals are set to SIG_DFL or SIG_IGN prior to entry of the main routine (see the exec functions.) The actions prescribed by these values are:

SIG_DFL — signal-specific default action

- The default actions for the signals defined in this document are specified under <signal.h>.
- If the default action is to stop the process, the execution of that process is temporarily suspended. When a process stops, a SIGCHLD signal is generated for its parent process, unless the parent process has set the SA_NOCLDSTOP flag. While a process is stopped, any additional signals that are sent to the process are not delivered until the process

is continued, except SIGKILL which always terminates the receiving process. A process that is a member of an orphaned process group is not allowed to stop in response to the SIGSTOP, SIGTTIN, or SIGTTOU signals. In cases where delivery of one of these signals would stop such a process, the signal is discarded.

- Setting a signal action to SIG_DFL for a signal that is pending and whose default action is to ignore the signal (for example, SIGCHLD), causes the pending signal to be discarded, whether or not it is blocked.

SIG_IGN — ignore signal

- Delivery of the signal has no effect on the process. The behavior of a process is undefined after it ignores a SIGFPE, SIGILL, or SIGSEGV signal that was not generated by kill or raise.
- The system does not allow the action for the SIGKILL or SIGSTOP signals to be set to SIG_IGN.
- Setting a signal action to SIG_IGN for a signal that is pending causes the pending signal to be discarded, whether or not it is blocked.
- If a process sets the action for the SIGCHLD signal to SIG_IGN, the behavior is unspecified.

pointer to a function — catch signal

- On delivery of the signal, the receiving process executes the signal-catching function at the specified address. After returning from the signal-catching function, the receiving process resumes execution at the point at which it was interrupted.

- Specify the signal-catching function as:

```
void func(int signo);
```

Here, *func* is the specified signal-catching function and *signo* is the signal number of the signal being delivered.

- The behavior of a process is undefined after it returns normally from a signal-catching function for a SIGFPE, SIGKILL, or SIGSEGV signal that was not generated by kill or raise.
- The system does not allow a process to catch the signals SIGKILL and SIGSTOP.
- If a process establishes a signal-catching function for the SIGCHLD signal while it has a terminated child process for which it has not waited, it is unspecified whether a SIGCHLD signal is generated to indicate that child process.

4.2.5 Signal Handling and OpenVMS Exception Handling

This section discusses how HP C RTL signal handling is implemented with and interacts with OpenVMS exception handling. Information in this section allows you to write OpenVMS exception handlers that do not conflict with HP C RTL signal handling. For information on OpenVMS exception handling, see the *OpenVMS Procedure Calling and Condition Handling Standard*.

The HP C RTL implements signals with OpenVMS exceptions. When `gsignal` or `raise` is called, the signal number is translated to a particular OpenVMS exception, which is used in a call to `LIB$SIGNAL`. This mechanism is necessary to catch an OpenVMS exception resulting from a user error and translate it into a corresponding UNIX signal. For example, an `ACCVIO` resulting from a write to a `NULL` pointer is translated to a `SIGBUS` or `SIGSEGV` signal.

Tables 4–4 and 4–5 list the HP C RTL signal names, the corresponding OpenVMS Alpha and Integrity server system exceptions, the event that generates the signal, and the optional signal code for use with the `gsignal` and `raise` functions.

To call a signal handler that you have established with `signal` or `sigvec`, the HP C RTL intercepts the OpenVMS exceptions that correspond to signals by having an OpenVMS exception handler in the main routine of the program. If your program has a main function, then this exception handler is automatically established. If you do not have a main function, or if your main function is written in a language other than HP C, then you must invoke the `VAXC$CRTL_INIT` routine to establish this handler.

The HP C RTL uses OpenVMS exceptions to implement the `setjmp` and `longjmp` functions. When the `longjmp` function is called, a `C$_LONGJMP` OpenVMS exception is signaled. To prevent the `C$_LONGJMP` exception from being interfered with by user exception handlers, use the `VAXC$ESTABLISH` routine to establish user OpenVMS exception handlers instead of calling `LIB$ESTABLISH`. The `C$_LONGJMP` mnemonic is defined in the `<errnodef.h>` header file.

If you want to use OpenVMS exception handlers and UNIX signals in your C program, your OpenVMS exception handler must be prepared to accept and resignal the OpenVMS exceptions listed in Table 4–4 (*Alpha only*), as well as the `C$_LONGJMP` exception and any C\$ facility exception that might be introduced in future versions of the HP C RTL. This is because UNIX signals are global in context, whereas OpenVMS exceptions are stack-frame based.

Consequently, an OpenVMS exception handler always receives the exception that corresponds to the UNIX signal before the HP C RTL exception handler in the main routine does. By resignaling the OpenVMS exception, you allow the HP C RTL exception handler to receive the exception. You can intercept any of those OpenVMS exceptions yourself, but in doing so you will disable the corresponding UNIX signal.

Table 4–4 HP C RTL Signals and Corresponding OpenVMS Alpha Exceptions (*Alpha only*)

Name	OpenVMS Exception	Generated By	Code
SIGABRT	SS\$_OPCCUS	The <code>abort</code> function	–
SIGALRM	SS\$_ASTFLT	The <code>alarm</code> function	–
SIGBUS	SS\$_ACCVIO	Access violation	–
SIGBUS	SS\$_CMODUSER	Change mode user	–
SIGCHLD	C\$_SIGCHLD	Child process stopped	–
SIGEMT	SS\$_COMPAT	Compatibility mode trap	–
SIGFPE	SS\$_DECDIV	Decimal divide trap	FPE_DECDIV_TRAP
SIGFPE	SS\$_DECINV	Decimal invalid operand trap	FPE_DECINV_TRAP

(continued on next page)

Table 4–4 (Cont.) HP C RTL Signals and Corresponding OpenVMS Alpha Exceptions *(Alpha only)*

Name	OpenVMS Exception	Generated By	Code
SIGFPE	SS\$_DECOVF	Decimal overflow trap	FPE_DECOVF_TRAP
SIGFPE	SS\$_HPARITH	Floating/decimal division by 0	FPE_FLTDIV_TRAP
SIGFPE	SS\$_HPARITH	Floating overflow trap	FPE_FLTOVF_TRAP
SIGFPE	SS\$_HPARITH	Floating underflow trap	FPE_FLTUND_TRAP
SIGFPE	SS\$_HPARITH	Integer overflow	FPE_INTOVF_TRAP
SIGFPE	SS\$_HPARITH	Invalid operand	FPE_INVOPR_TRAP
SIGFPE	SS\$_HPARITH	Inexact result	FPE_INXRES_TRAP
SIGFPE	SS\$_INTDIV	Integer div by zero	FPE_INTDIV_TRAP
SIGFPE	SS\$_SUBRNG	Subscript out of range	FPE_SUBRNG_TRAP
SIGFPE	SS\$_SUBRNG1	Subscript1 out of range	FPE_SUBRNG1_TRAP
SIGFPE	SS\$_SUBRNG2	Subscript2 out of range	FPE_SUBRNG2_TRAP
SIGFPE	SS\$_SUBRNG3	Subscript3 out of range	FPE_SUBRNG3_TRAP
SIGFPE	SS\$_SUBRNG4	Subscript4 out of range	FPE_SUBRNG4_TRAP
SIGFPE	SS\$_SUBRNG5	Subscript5 out of range	FPE_SUBRNG5_TRAP
SIGFPE	SS\$_SUBRNG6	Subscript6 out of range	FPE_SUBRNG6_TRAP
SIGFPE	SS\$_SUBRNG7	Subscript7 out of range	FPE_SUBRNG7_TRAP
SIGHUP	SS\$_HANGUP	Data set hangup	–
SIGILL	SS\$_OPCDEC	Reserved instruction	ILL_PRIVIN_FAULT
SIGILL	SS\$_ROPRAND	Reserved operand	ILL_RESOP_FAULT
SIGINT	SS\$_CONTROL	OpenVMS Ctrl/C interrupt	–
SIGIOT	SS\$_OPCCUS	Customer-reserved opcode	–
SIGKILL	SS\$_ABORT	External signal only	–
SIGQUIT	SS\$_CONTROL	The raise function	–
SIGPIPE	SS\$_NOMBX	No mailbox	–
SIGPIPE	C\$_SIGPIPE	Broken pipe	–
SIGSEGV	SS\$_ACCVIO	Length violation	–
SIGSEGV	SS\$_CMODSUPR	Change mode supervisor	–
SIGSYS	SS\$_BADPARAM	Bad argument to system call	–
SIGTERM	Not implemented	–	–
SIGTRAP	SS\$_BREAK	Breakpoint fault instruction	–
SIGUSR1	C\$_SIGUSR1	The raise function	–
SIGUSR2	C\$_SIGUSR2	The raise function	–
SIGWINCH ¹	C\$_SIGWINCH ²	The raise function	–

¹Supported on OpenVMS Version 7.3 and higher.²SS\$_BADWINCNT when C\$_SIGWINCH not defined (OpenVMS versions before 7.3).

- While all signals that exist on OpenVMS VAX systems also exist on OpenVMS Alpha systems, the corresponding OpenVMS exceptions and code is different in a number of cases because on Alpha processors there are two new OpenVMS exceptions and several others that are obsolete.
- All floating-point exceptions on OpenVMS Alpha systems are signaled by the OpenVMS exception SS\$_HPARITH (high-performance arithmetic trap). The particular type of trap that occurred is translated by the HP C RTL through use of the exception summary longword, which is set when a high-performance arithmetic trap is signaled.

Table 4-5 HP C RTL Signals and Corresponding OpenVMS Integrity server system Exceptions

(Integrity servers only)

Name	OpenVMS Exception	Generated By	Code
SIGABRT	SS\$_OPCCUS	The abort function	–
SIGALRM	SS\$_ASTFLT	The alarm function	–
SIGBUS	SS\$_ACCVIO	Access violation	–
SIGBUS	SS\$_CMODUSER	Change mode user	–
SIGCHLD	C\$_SIGCHLD	Child process stopped	–
SIGEMT	SS\$_COMPAT	Compatibility mode trap	–
SIGFPE	SS\$_DECOVF	Decimal overflow trap	FPE_DECOVF_TRAP
SIGFPE	SS\$_DECDIV	Decimal divide trap	FPE_DECDIV_TRAP
SIGFPE	SS\$_DECINV	Decimal invalid operand trap	FPE_DECINV_TRAP
SIGFPE	SS\$_FLT DENORMAL	Denormal operand fault	FPE_FLTDENORMAL_FAULT
SIGFPE	SS\$_FLTDIV	Floating/decimal division by 0	FPE_FLTDIV_TRAP
SIGFPE	SS\$_FLTDIV_F	Floating divide by 0 fault	FPE_FLTDIV_FAULT
SIGFPE	SS\$_FLTINE	Inexact operation trap	FPE_FLTINE_TRAP
SIGFPE	SS\$_FLTINV	Invalid operation trap	FPE_FLTINV_TRAP
SIGFPE	SS\$_FLTINV_F	Invalid operation fault	FPE_FLTINV_FAULT
SIGFPE	SS\$_FLTOVF	Floating overflow trap	FPE_FLTOVF_TRAP
SIGFPE	SS\$_FLTUND	Floating underflow trap	FPE_FLTUND_TRAP
SIGFPE	SS\$_INTDIV	Integer division by 0	FPE_INTDIV_TRAP
SIGFPE	SS\$_INTOVF	Integer overflow	FPE_INTOVF_TRAP
SIGFPE	SS\$_SUBRNG	Subscript-range	FPE_SUBRNG_TRAP
SIGHUP	SS\$_HANGUP	Data set hangup	–
SIGILL	SS\$_OPCDEC	Reserved instruction	ILL_PRIVIN_FAULT
SIGILL	SS\$_ROPRAND	Reserved operand	ILL_RESOP_FAULT

(continued on next page)

Table 4–5 (Cont.) HP C RTL Signals and Corresponding OpenVMS Integrity server system Exceptions *(Integrity servers only)*

Name	OpenVMS Exception	Generated By	Code
SIGINT	SS\$_CONTROL	OpenVMS Ctrl/C interrupt	–
SIGIOT	SS\$_OPCCUS	Customer-reserved opcode	–
SIGKILL	SS\$_ABORT	External signal only	–
SIGQUIT	SS\$_CONTROL	The raise function	–
SIGPIPE	SS\$_NOMBX	No mailbox	–
SIGPIPE	C\$_SIGPIPE	Broken pipe	–
SIGSEGV	SS\$_ACCVIO	Length violation	–
SIGSEGV	SS\$_CMODSUPR	Change mode supervisor	–
SIGSYS	SS\$_BADPARAM	Bad argument to system call	–
SIGTERM	Not implemented	–	–
SIGTRAP	SS\$_TBIT	TBIT trace trap	–
SIGTRAP	SS\$_BREAK	Breakpoint fault instruction	–
SIGUSR1	C\$_SIGUSR1	The raise function	–
SIGUSR2	C\$_SIGUSR2	The raise function	–
SIGWINCH	C\$_SIGWINCH	The raise function	–

4.3 Program Example

Example 4–1 shows how the signal, alarm, and pause functions operate. It also shows how to establish a signal handler to catch a signal, which prevents program termination.

Example 4–1 Suspending and Resuming Programs

```

/*   CHAP_4_SUSPEND_RESUME.C                               */
/* This program shows how to alternately suspend and resume a */
/* program using the signal, alarm, and pause functions.     */
#define SECONDS 5
#include <stdio.h>
#include <signal.h>
int number_of_alarms = 5;      /* Set alarm counter.          */
void alarm_action(int);
main()
{
    signal(SIGALRM, alarm_action); /* Establish a signal handler. */
                                   /* to catch the SIGALRM signal.*/
    alarm(SECONDS);               /* Set alarm clock for 5 seconds. */
    pause();                      /* Suspend the process until      *
                                   * the signal is received.      */
}

```

(continued on next page)

Example 4-1 (Cont.) Suspending and Resuming Programs

```
void alarm_action(int x)
{
    printf("\t<%d\007>", number_of_alarms); /* Print the value of */
                                           /* the alarm counter. */

    signal(SIGALRM, alarm_action); /* Reset the signal. */

    alarm(SECONDS); /* Set the alarm clock. */

    if (--number_of_alarms) /* Decrement alarm counter. */
        pause();
}
```

Here is the sample output from Example 4-1:

```
$ RUN EXAMPLE
   <5>  <4>  <3>  <2>  <1>
```

Subprocess Functions

The HP C Run-Time Library (RTL) provides functions that allow you to create subprocesses from a HP C program. The creating process is called the *parent* and the created subprocess is called the *child*.

To create a child process within the parent process, use the `exec` functions (`execl`, `execle`, `execv`, `execve`, `execlp`, and `execvp`) and the `vfork` function. Other functions are available to allow the parent and child to read and write data across processes (`pipe`) and to allow for synchronization of the two processes (`wait`). This chapter describes how to implement and use these functions.

The parent process can execute HP C programs in its children, either synchronously or asynchronously. The number of children that can run simultaneously is determined by the `/PRCLM` user authorization quota established for each user on your system. Other quotas that may affect the use of subprocesses are `/ENQLM` (Queue Entry Limit), `/ASTLM` (AST Waits Limit), and `/FILLM` (Open File Limit).

This chapter discusses the subprocess functions. Table 5–1 lists and describes all the subprocess functions found in the HP C RTL. For more detailed information on each function, see the Reference Section.

Table 5–1 Subprocess Functions

Function	Description
Implementation of Child Processes	
<code>system</code>	Passes a given string to the host environment to be executed by a command processor.
<code>vfork</code>	Creates an independent child process.
The <code>exec</code> Functions	
<code>execl</code> , <code>execle</code> , <code>execlp</code> <code>execv</code> , <code>execve</code> , <code>execvp</code>	Passes the name of the image to be activated in a child process.
Synchronizing Process	
<code>wait</code> , <code>wait3</code> , <code>wait4</code> , <code>waitpid</code> ,	Suspends the parent process until a value is returned from a child.
Interprocess Communication	
<code>pipe</code>	Allows for communication between a parent and child.

5.1 Implementing Child Processes in HP C

Child processes are created by HP C functions with the OpenVMS LIB\$SPAWN RTL routine. (See the *VMS Run-Time Library Routines Volume* for information on LIB\$SPAWN.) Using LIB\$SPAWN allows you to create multiple levels of child processes; the parent's children can also spawn children, and so on, up to the limits allowed by the user authorization quotas discussed in the introduction to this chapter.

Child processes can only execute other HP C programs. Other native-mode OpenVMS languages do not share the ability of HP C to communicate between processes; if they do, they do not use the same mechanisms. The parent process must be run under an HP supported command-language interpreter (CLI), such as DCL. You cannot run the parent as a detached process or under control of a user-supplied CLI.

Enabling the DECC\$DETACHED_CHILD_PROCESS feature logical allows child processes to be created as detached processes instead of subprocesses. This feature has only limited support. In some cases, the console cannot be shared between the parent process and the detached process, which can cause exec to fail.

Parent and child processes communicate through a mailbox as shown in Figure 5-1. This mailbox transfers the context in which the child will run. This *context mailbox* passes information to the child that it inherits from the parent, such as the names and file descriptors of all the files opened by the parent and the current location within those files. The mailbox is deleted by the parent when the child image exits.

Figure 5-1 Communications Links Between Parent and Child Processes



ZK-4002-GE

Note

The mailbox created by the vfork and exec functions is temporary. The logical name of this mailbox is VAXC\$EXECMBX and is reserved for use by the HP C RTL.

The mailbox is created with a maximum message size and a buffer quota of 512 bytes each, unless the buffer size and quota are explicitly specified with the DECC\$PIPE_BUFFER_SIZE or DECC\$PIPE_BUFFER_QUOTA feature logicals, or with the *bufsize* or *bufquota* parameters of the pipe function. See the pipe function for more information.

You need the TMPMBX privilege to create a mailbox with these RTL functions. Since TMPMBX is the privilege required by the DCL commands PRINT and SUBMIT, most users on a system have this privilege. To see what system privileges you have, enter a SHOW PROCESS/PRIVILEGES command.

You cannot change the characteristics of these mailboxes. For more information on mailboxes, see the *VMS I/O User's Reference Volume*.

5.2 The exec Functions

There are six exec functions that you can call to execute an HP C image in the child process. These functions expect that vfork has been called to set up a return address. The exec functions will call vfork if the parent process did not.

When vfork is called by the parent, the exec function returns to the parent process. When vfork was called by an exec function, the exec function returns to itself, waits for the child to exit, and then exits the parent process. The exec function does not return to the parent process unless the parent calls vfork to save the return address.

In OpenVMS Version 7.2, the exec functions were enhanced to activate either executable images or DCL command procedures. If no file extension is specified in the *file_name* argument, the functions first search for the file with the .EXE file extension and then for the file with the .COM file extension. If both the executable image and the command procedure with the same name exist, you must explicitly specify the .COM file extension to force activating the command procedure.

For a DCL command procedure, the exec functions pass the first eight *arg0*, *arg1*, ..., arguments specified in the exec call to the command procedure as *P1*, *P2*, ... parameters, preserving the case.

Unlike UNIX based systems, the exec functions in the HP C RTL cannot always determine if the specified executable image or command procedure exists and can be activated and executed. Therefore, the exec functions might appear to succeed even though the specified file cannot be executed by the child process.

The status of the child process, returned to the parent process, indicates that the error occurred. You can retrieve this error code by using one of the functions from the wait family of functions.

Note

The vfork and exec functions in the HP C RTL on OpenVMS systems work differently than on UNIX systems:

- On UNIX systems, vfork creates a child process, suspends the parent, and starts the child running where the parent left off.
- On OpenVMS systems, vfork establishes context later used by an exec function, but it is the exec function, not vfork, that starts a process running the specified program.

For a programmer, the key differences are:

- On OpenVMS systems, code between the call to vfork and the call to an exec function runs in the parent process.
On UNIX systems, this code runs in the child process.
 - On OpenVMS systems, the child inherits open file descriptors and so on, at the point where the exec function is called.
On UNIX systems, this occurs at the point where vfork is called.
-

5.2.1 exec Processing

The exec functions use the LIB\$SPAWN routine to create the subprocess and activate the child image within the subprocess. This child process inherits the parent's environment, including all defined logical names and command-line interpreter symbols.

By default, child processes also inherit the default (working) directory of their parent process. However, you can use the `decc$set_child_default_dir` function to set the default directory for a child process as it begins execution. For more information about the `decc$set_child_default_dir` function, see the Reference Section.

The exec functions use the logical name `VAXC$EXECMBX` to communicate between parent and child; this logical name must not exist outside the context of the parent image.

The exec functions pass the following information to the child:

- The parent's umask value, which specifies whether any access is to be disallowed when a new file is created. For more information about the umask function, see the Reference Section.
- The file-name string associated with each file descriptor and the current position within each file. The child opens the file and calls `lseek` to position the file to the same location as the parent. If the file is a record file, the child is positioned on a record boundary, regardless of the parent's position within the record. For more information about file descriptors, see Chapter 2. For more information on the `lseek` function, see the Reference Section.

This information is sent to the child for all descriptors known to the parent including all descriptors for open files, null descriptors, and duplicate descriptors.

File pointers are not transferred to the child. For files opened by a file pointer in the parent, only their corresponding file descriptors are passed to the child. The `fdopen` function must be called to associate a file pointer with the file descriptor if the child will access the file-by-file pointer. For more information about the `fdopen` function, see the Reference Section.

The `DECC$EXEC_FILEATTR_INHERITANCE` feature logical can be used to control whether or not a child process inherits file positioning, and if so, for which access modes. For more information on `DECC$EXEC_FILEATTR_INHERITANCE`, see Section 1.5.

- The signal database. Only `SIG_IGN` (ignore) actions are inherited. Actions specified as routines are changed to `SIG_DFL` (default) because the parent's signal-handling routines are inaccessible to the child.
- The environment and argument vectors.

When everything is transmitted to the child, exec processing is complete. Control in the parent process then returns to the address saved by `vfork` and the child's process ID is returned to the parent.

See Section 4.2.4 for a discussion of signal actions and the `SIGCHLD` signal.

5.2.2 exec Error Conditions

The exec functions will fail if LIB\$SPAWN cannot create the subprocess. Conditions that can cause a failure include exceeding the subprocess quota or finding the communications by the context mailbox between the parent and child to be broken. Exceeding some quotas will not cause LIB\$SPAWN to fail, but will put LIB\$SPAWN into a wait state that can cause the parent process to hang. An example of such a quota is the Open File Limit quota.

You will need an Open File Limit quota of at least 20 files, with an average of three times the number of concurrent processes that your program will run. If you use more than one open pipe at a time, or perform I/O on several files at one time, this quota may need to be even higher. See your system manager if this quota needs to be increased.

When an exec function fails, a value of -1 is returned. After such a failure, the parent is expected to call either the `exit` or `_exit` function. Both functions then return to the parent's `vfork` call, which returns the child's process ID. In this case, the child process ID returned by the exec function is less than zero. For more information about the exit function, see the Reference Section.

5.3 Synchronizing Processes

A child process is terminated when the parent process terminates. Therefore, the parent process must check the status of its child processes before exiting. This is done using the HP C RTL function `wait`.

5.4 Interprocess Communication

A channel through which parent and child processes communicate is called a *pipe*. Use the `pipe` function to create a pipe.

5.5 Program Examples

Example 5-1 shows the basic procedures for executing an image in a child process. The child process in Example 5-1 prints a message 10 times.

Example 5-1 Creating the Child Process

```
/*      chap_5_exec_image.c      */

/* This example creates the child process. The only      */
/* functionality given to the child is the ability to    */
/* print a message 10 times.                             */

#include <climgdef.h> /* CLI status values */
#include <stdio.h>
#include <perror.h>
#include <processes.h>
#include <stdlib.h>

static const char *child_name = "chap_5_exec_image_child.exe" ;

main()
{
    int status,
        cstatus;
```

(continued on next page)

Example 5–1 (Cont.) Creating the Child Process

```
/* NOTE:
/* Any local automatic variables, even those
/* having the volatile attribute, may have
/* indeterminant values if they are modified
/* between the vfork() call and the matching
/* exec() call.
1 if ((status = vfork()) != 0) {
/* This is either an error or
/* the "second" vfork return, taking us "back"
/* to parent mode.
3 if (status < 0)
    printf("Parent - Child process failed\n");
    else {
4 printf("Parent - Waiting for Child\n");
    if ((status = wait(&cstatus)) == -1)
        perror("Parent - Wait failed");
5 else if (cstatus == CLI$ _IMAGEFNF)
    printf("Parent - Child does not exist\n");
    else
        printf("Parent - Child final status: %d\n", cstatus);
    }
}
2 else { /* The FIRST Vfork return is zero, do the exec */
    printf("Parent - Starting Child\n");
    if ((status = execl(child name, 0)) == -1) {
        perror("Parent - Execl failed");
        exit(EXIT_FAILURE);
    }
}
}

-----

/*      CHAP_5_EXEC_IMAGE_CHILD.C
/* This is the child program that writes a message
/* through the parent to "stdout"
#include <stdio.h>
main()
{
    int i;
    for (i = 0; i < 10; i++)
        printf("Child - executing\n");
    return (255) ; /* Set an unusual success stat */
}
```

Key to Example 5–1:

- 1 The `vfork` function is called to set up the return address for the `exec` call. The `vfork` function is normally used in the expression of an `if` statement. This construct allows you to take advantage of the double return aspect of `vfork`, since one return value is 0 and the other is nonzero.
- 2 A 0 return value is returned the first time `vfork` is called and the parent executes the `else` clause associated with the `vfork` call, which calls `execl`.
- 3 A negative child process ID is returned when an `exec` function fails. The return value is checked for these conditions.

- ④ The wait function is used to synchronize the parent and child processes.
- ⑤ Since the exec functions can indicate success up to this point even if the image to be activated in the child does not exist, the parent checks the child's return status for the predefined status, CLI\$_IMAGEFNF (file not found).

In Example 5-2, the parent passes arguments to the child process.

Example 5-2 Passing Arguments to the Child Process

```

/*      CHAP_5_CHILDARG.C      */
/* In this example, the arguments are placed in an array, gargv,      */
/* but they can be passed to the child explicitly as a zero-          */
/* terminated series of character strings. The child program in this  */
/* example writes the arguments that have been passed it to stdout.  */

#include <climgdef.h>
#include <stdio.h>
#include <stdlib.h>
#include <perror.h>
#include <processes.h>

const char *child_name = "chap_5_childarg_child.exe" ;

main()
{
    int status,
        cstatus;
    char *gargv[] =
        {"Child", "ARGC1", "ARGC2", "Parent", 0};

    if ((status = vfork()) != 0) {
        if (status < -1)
            printf("Parent - Child process failed\n");
        else {
            printf("Parent - waiting for Child\n");
            if ((status = wait(&cstatus)) == -1)
                perror("Parent - Wait failed");
            else if (cstatus == CLI$_IMAGEFNF)
                printf("Parent - Child does not exist\n");
            else
                printf("Parent - Child final status: %x\n",
                    cstatus);
        }
    }
    else {
        printf("Parent - Starting Child\n");
        if ((status = execv(child_name, gargv)) == -1) {
            perror("Parent - Exec failed");
            exit(EXIT_FAILURE);
        }
    }
}

-----
/*      CHAP_5_CHILDARG_CHILD.C      */
/* This is a child program that echo's its arguments      */
#include <stdio.h>

```

(continued on next page)

Example 5–2 (Cont.) Passing Arguments to the Child Process

```
main(argc, argv)
    int argc;
    char *argv[];
{
    int i;

    printf("Program name: %s\n", argv[0]);

    for (i = 1; i < argc; i++)
        printf("Argument %d: %s\n", i, argv[i]);

    return(255) ;
}
```

Example 5–3 shows how to use the wait function to check the final status of multiple children being run simultaneously.

Example 5–3 Checking the Status of Child Processes

```
/*          CHAP_5_CHECK_STAT.C          */
/* In this example 5 child processes are started. The wait() */
/* function is placed in a separate for loop so that it is  */
/* called once for each child. If wait() were called within */
/* the first for loop, the parent would wait for one child to */
/* terminate before executing the next child. If there were */
/* only one wait request, any child still running when the */
/* parent exits would terminate prematurely.                */
#include <climgdef.h>
#include <stdio.h>
#include <stdlib.h>
#include <perror.h>
#include <processes.h>

const char *child_name = "chap_5_check_stat_child.exe" ;

main()
{
    int status,
        cstatus,
        i;

    for (i = 0; i < 5; i++) {
        if ((status = vfork()) == 0) {
            printf("Parent - Starting Child %d\n", i);
            if ((status = execl(child_name, 0)) == -1) {
                perror("Parent - Exec failed");
                exit(EXIT_FAILURE);
            }
        }
        else if (status < -1)
            printf("Parent - Child process failed\n");
    }

    printf("Parent - Waiting for children\n");
}
```

(continued on next page)

Example 5–3 (Cont.) Checking the Status of Child Processes

```
for (i = 0; i < 5; i++) {
    if ((status = wait(&cstatus)) == -1)
        perror("Parent - Wait failed");
    else if (cstatus == CLI$ IMAGEFNF)
        printf("Parent - Child does not exist\n");
    else
        printf("Parent - Child %X final status: %d\n",
              status, cstatus);
}
}
```

Example 5–4 shows how to use the pipe and dup2 functions to communicate between a parent and child process through specific file descriptors. The #define preprocessor directive defines the preprocessor constants inpipe and outpipe as the names of file descriptors 11 and 12.

Example 5–4 Communicating Through a Pipe

```
/*          CHAP_5_PIPE.C          */
/* In this example, the parent writes a string to the pipe for */
/* the child to read. The child then writes the string back */
/* to the pipe for the parent to read. The wait function is */
/* called before the parent reads the string that the child has */
/* passed back through the pipe. Otherwise, the reads and */
/* writes will not be synchronized. */

#include <perror.h>
#include <climgdef.h>
#include <stdio.h>
#include <stdlib.h>
#include <string.h>
#include <processes.h>
#include <unixio.h>

#define inpipe 11
#define outpipe 12

const char *child_name = "chap_5_pipe_child.exe" ;

main()
{
    int pipes[2];
    int mode,
        status,
        cstatus,
        len;
    char *outbuf,
        *inbuf;

    if ((outbuf = malloc(512)) == 0) {
        printf("Parent - Outbuf allocation failed\n");
        exit(EXIT_FAILURE);
    }
}
```

(continued on next page)

Example 5-4 (Cont.) Communicating Through a Pipe

```
if ((inbuf = malloc(512)) == 0) {
    printf("Parent - Inbuf allocation failed\n");
    exit(EXIT_FAILURE);
}
if (pipe(pipes) == -1) {
    printf("Parent - Pipe allocation failed\n");
    exit(EXIT_FAILURE);
}
dup2(pipes[0], inpipe);
dup2(pipes[1], outpipe);
strcpy(outbuf, "This is a test of two-way pipes.\n");
status = vfork();
switch (status) {
case 0:
    printf("Parent - Starting child\n");
    if ((status = execl(child_name, 0)) == -1) {
        printf("Parent - Exec failed");
        exit(EXIT_FAILURE);
    }
    break;
case -1:
    printf("Parent - Child process failed\n");
    break;
default:
    printf("Parent - Writing to child\n");
    if (write(outpipe, outbuf, strlen(outbuf) + 1) == -1) {
        perror("Parent - Write failed");
        exit(EXIT_FAILURE);
    }
    else {
        if ((status = wait(&cstatus)) == -1)
            perror("Parent - Wait failed");

        if (cstatus == CLI$ _IMAGEFNF)
            printf("Parent - Child does not exist\n");
        else {
            printf("Parent - Reading from child\n");
            if ((len = read(inpipe, inbuf, 512)) <= 0) {
                perror("Parent - Read failed");
                exit(EXIT_FAILURE);
            }
            else {
                printf("Parent: %s\n", inbuf);
                printf("Parent - Child final status: %d\n",
                    cstatus);
            }
        }
    }
    break;
}
}

-----
/*          CHAP_5_PIPE_CHILD.C          */
/* This is a child program which reads from a pipe and writes */
/* the received message back to its parent.          */
```

(continued on next page)

Example 5–4 (Cont.) Communicating Through a Pipe

```
#include <stdlib.h>
#include <stdio.h>
#include <string.h>
#include <unistd.h>

#define inpipe 11
#define outpipe 12

main()
{
    char *buffer;
    int len;

    if ((buffer = malloc(512)) == 0) {
        perror("Child - Buffer allocation failed\n");
        exit(EXIT_FAILURE);
    }

    printf("Child - Reading from parent\n");
    if ((len = read(inpipe, buffer, 512)) <= 0) {
        perror("Child - Read failed");
        exit(EXIT_FAILURE);
    }
    else {
        printf("Child: %s\n", buffer);
        printf("Child - Writing to parent\n");
        if (write(outpipe, buffer, strlen(buffer) + 1) == -1) {
            perror("Child - Write failed");
            exit(EXIT_FAILURE);
        }
    }
    exit(EXIT_SUCCESS);
}
```

Curses Screen Management Functions and Macros

This chapter describes the screen management routines available with HP C for OpenVMS Systems.

The OpenVMS Curses screen management package is supported on all OpenVMS systems.

On OpenVMS Alpha systems, two screen management packages are supported: OpenVMS Curses and a more UNIX compatible package based on the Berkeley Standard Distribution (BSD) Curses software.¹ See Section 6.1 for more information.

Furthermore, the HP C RTL offers a Curses package based on the 4.4BSD Berkeley Software Distribution. Documentation on the 4.4BSD Curses package can be found in *Screen Updating and Cursor Movement Optimization: A Library Package*, by Kenneth C.R.C. Arnold.

The functions and macros in the OpenVMS and BSD-based Curses packages are nearly the same. Most differences between them are called out in this chapter. Otherwise, this chapter makes no distinction between the two Curses packages, and refers to "Curses" or the "Curses functions and macros."

6.1 Using the BSD-Based Curses Package *(Alpha only)*

The `<curses.h>` header file required to use the BSD-based Curses implementation is provided with the HP C compiler on OpenVMS Alpha systems.

Existing programs are not affected by the BSD-based Curses functions because the OpenVMS Curses functions are still available as the default Curses package. (Note that is a change from previous versions of HP C, where BSD-based Curses was the default.)

To get the 4.4BSD Curses implementation, you must compile modules that include `<curses.h>` with the following qualifier:

```
/DEFINE=_BSD44_CURSES
```

The BSD-based Curses functions do not provide the support required to call the OpenVMS SMG\$ routines with the pasteboard and keyboard allocated by the Curses functions. Consequently, Curses programs that rely on calling SMG\$ entry points, as well as Curses functions, must continue to use the OpenVMS Curses implementation.

¹ Copyright (c) 1981 Regents of the University of California.
All rights reserved.

The BSD-based Curses implementation is not interoperable with the old implementation. Attempts to mix calls to the new functions and the old functions will result in incorrect output displayed on the screen and could result in an exception from an SMG\$ routine.

6.2 Curses Overview

Curses, the HP C Screen Management Package, is composed of HP C RTL functions and macros that create and modify defined sections of the terminal screen and optimize cursor movement. Using the screen management package, you can develop a user interface that is both visually attractive and user-friendly. Curses is terminal-independent and provides simplified terminal screen formatting and efficient cursor movement.

Most Curses functions and macros are listed in pairs where the first routine is a macro and the second is a function beginning with the prefix “w,” for “window.” These prefixes are delimited by brackets ([]). For example, [w]addstr designates the addstr macro and the waddstr function. The macros default to the window stdscr; the functions accept a specified window as an argument.

To access the Curses functions and macros, include the <curses.h> header file.

The terminal-independent Screen Management Software, which is part of the OpenVMS RTL, is used to implement Curses. For portability purposes, most functions and macros are designed to perform in a manner similar to other C implementations. However, the Curses routines depend on the OpenVMS system and its Screen Management Software, so performance of some functions and macros could differ slightly from those of other implementations.

Some functions and macros available on other systems are not available with the HP C RTL Curses package.

Some functions, such as [w]clrattr, [w]insstr, mv[w]insstr, and [w]setattr are specific to HP C for OpenVMS Systems and are not portable.

Table 6–1 lists all of the Curses functions and macros found in the HP C RTL. For more detailed information on each function and macro, see the Reference Section.

Table 6–1 Curses Functions and Macros

Function or Macro	Description
[w]addch	Adds a character to the window at the current position of the cursor.
[w]addstr	Adds a string to the window at the current position of the cursor.
box	Draws a box around the window.
[w]clear	Erases the contents of the specified window and resets the cursor to coordinates (0,0).
clearok	Sets the clear flag for the window.
[w]clrattr	Deactivates the video display attribute within the window.
[w]clrtoBot	Erases the contents of the window from the current position of the cursor to the bottom of the window.

(continued on next page)

Table 6–1 (Cont.) Curses Functions and Macros

Function or Macro	Description
[w]clrtoeol	Erases the contents of the window from the current cursor position to the end of the line on the specified window.
[no]crmode	Sets and unsets the terminal from cbreak mode.
[w]delch	Deletes the character on the specified window at the current position of the cursor.
[w]deleteln	Deletes the line at the current position of the cursor.
delwin	Deletes the specified window from memory.
[no]echo	Sets the terminal so that characters may or may not be echoed on the terminal screen.
endwin	Clears the terminal screen and frees any virtual memory allocated to Curses data structures.
[w]erase	Erases the window by painting it with blanks.
[w]getch	Gets a character from the terminal screen and echoes it on the specified window.
[w]getstr	Gets a string from the terminal screen, stores it in a character variable, and echoes it on the specified window.
getyx	Puts the (y,x) coordinates of the current cursor position on the window in the variables y and x.
[w]inch	Returns the character at the current cursor position on the specified window without making changes to the window.
initscr	Initializes the terminal-type data and all screen functions.
[w]insch	Inserts a character at the current cursor position in the specified window.
[w]insertln	Inserts a line above the line containing the current cursor position.
[w]insstr	Inserts a string at the current cursor position on the specified window.
leaveok	Leaves the cursor at the current coordinates after an update to the window.
longname	Assigns the full terminal name to a character name that must be large enough to hold the character string.
[w]move	Changes the current cursor position on the specified window.
mv[w]addch	Moves the cursor and adds a character to the specified window.
mv[w]addstr	Moves the cursor and adds a string to the specified window.
mvcur	Moves the terminal's cursor.
mv[w]delch	Moves the cursor and deletes a character on the specified window.
mv[w]getch	Moves the cursor, gets a character from the terminal screen, and echoes it on the specified window.
mv[w]getstr	Moves the cursor, gets a string from the terminal screen, stores it in a variable, and echoes it on the specified window.
mv[w]inch	Moves the cursor and returns the character on the specified window without making changes to the window.

(continued on next page)

Table 6–1 (Cont.) Curses Functions and Macros

Function or Macro	Description
<code>mv[w]insch</code>	Moves the cursor and inserts a character in the specified window.
<code>mv[w]insstr</code>	Moves the cursor and inserts a string in the specified window.
<code>mvwin</code>	Moves the starting position of the window to the specified coordinates.
<code>newwin</code>	Creates a new window with lines and columns starting at the coordinates on the terminal screen.
<code>[no]nl</code>	Provided only for UNIX software compatibility and has no functionality in the OpenVMS environment.
<code>overlay</code>	Writes the contents of one window that will fit over the contents of another window, beginning at the starting coordinates of both windows.
<code>overwrite</code>	Writes the contents of one window, insofar as it will fit, over the contents of another window beginning at the starting coordinates of both windows.
<code>[w]printw</code>	Performs a <code>printf</code> on the window starting at the current position of the cursor.
<code>[no]raw</code>	Provided only for UNIX software compatibility and has no functionality in the OpenVMS environment.
<code>[w]refresh</code>	Repaints the specified window on the terminal screen.
<code>[w]scanw</code>	Performs a <code>scanf</code> on the window.
<code>scroll</code>	Moves all the lines on the window up one line.
<code>scrollok</code>	Sets the scroll flag for the specified window.
<code>[w]setattr</code>	Activates the video display attribute within the window.
<code>[w]standend</code>	Deactivates the boldface attribute for the specified window.
<code>[w]standout</code>	Activates the boldface attribute of the specified window.
<code>subwin</code>	Creates a new subwindow with lines and columns starting at the coordinates on the terminal screen.
<code>touchwin</code>	Places the most recently edited version of the specified window on the terminal screen.
<code>wrapok</code>	OpenVMS Curses only. Allows the wrapping of a word from the right border of the window to the beginning of the next line.

6.3 Curses Terminology

This section explains some of the Curses terminology and shows you how Curses looks on the terminal screen.

Consider a Curses application as being a series of overlapping windows. Window overlapping is called *occlusion*. To distinguish the boundaries of these occluding windows, you can outline the rectangular windows with specified characters, or you can turn on the reverse video option (make the window a light background with dark writing).

6.3.1 Predefined Windows (stdscr and curscr)

Initially, two windows the size of the terminal screen are predefined by Curses. These windows are called `stdscr` and `curscr`. The `stdscr` window is defined for your use. Many Curses macros default to this window. For example, if you draw a box around `stdscr`, move the cursor to the left-corner area of the screen, write a string to `stdscr`, and then display `stdscr` on the terminal screen, your display will look like that in Figure 6–1.

Figure 6–1 An Example of the `stdscr` Window

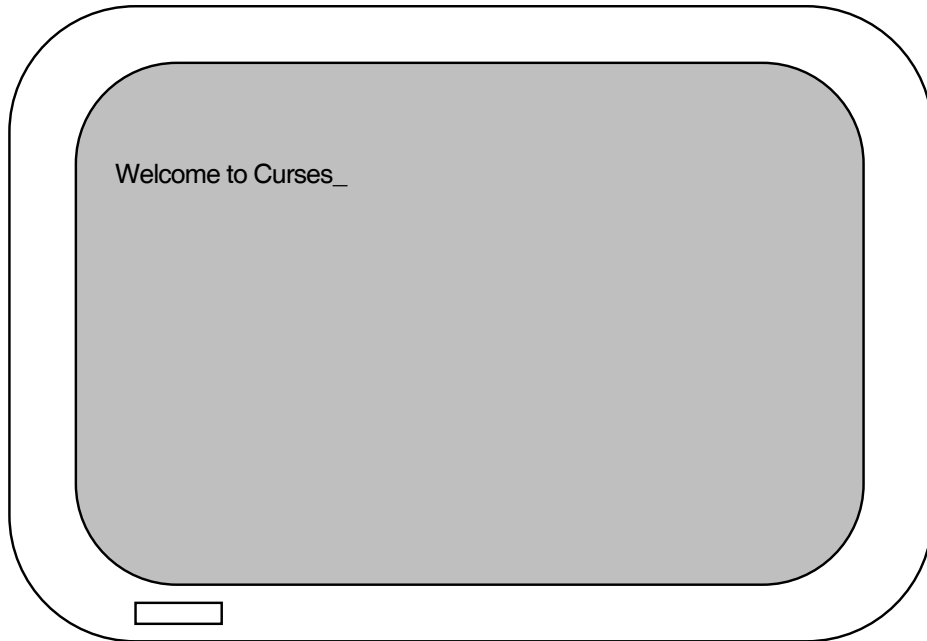

ZK-5752-GE

The second predefined window, `curscr`, is designed for internal Curses work; it is an image of what is currently displayed on the terminal screen. The only HP C for OpenVMS Curses function that will accept this window as an argument is `clearok`. Do not write to or read from `curscr`. Use `stdscr` and user-defined windows for all your Curses applications.

6.3.2 User-Defined Windows

You can occlude `stdscr` with your own windows. The size and location of each window is given in terms of the number of lines, the number of columns, and the starting position.

The lines and columns of the terminal screen form a coordinate system, or grid, on which the windows are formed. You specify the starting position of a window with the (y,x) coordinates on the terminal screen where the upper left corner of the window is located. The coordinates (0,0) on the terminal screen, for example, are the upper left corner of the screen.

The entire area of the window must be within the terminal screen borders; windows can be as small as a single character or as large as the entire terminal screen. You can create as many windows as memory allows.

When writing to or deleting from windows, changes do not appear on the terminal screen until the window is *refreshed*. When refreshing a window, you place the updated window onto the terminal screen, which leaves the rest of the screen unaltered.

All user-defined windows, by default, occlude `stdscr`. You can create two or more windows that occlude each other as well as `stdscr`. When writing data to one occluding window, the data is not written to the underlying window.

You can create overlapping windows (called *subwindows*). A declared window must contain the entire area of its subwindow. When writing data to a subwindow or to the portion of the window overlapped by the subwindow, both windows contain the new data. For instance, if you write data to a subwindow and then delete that subwindow, the data is still present on the underlying window.

If you create a window that occludes `stdscr` and a subwindow of `stdscr`, your terminal screen will look like Figure 6-2.

Figure 6-2 Displaying Windows and Subwindows

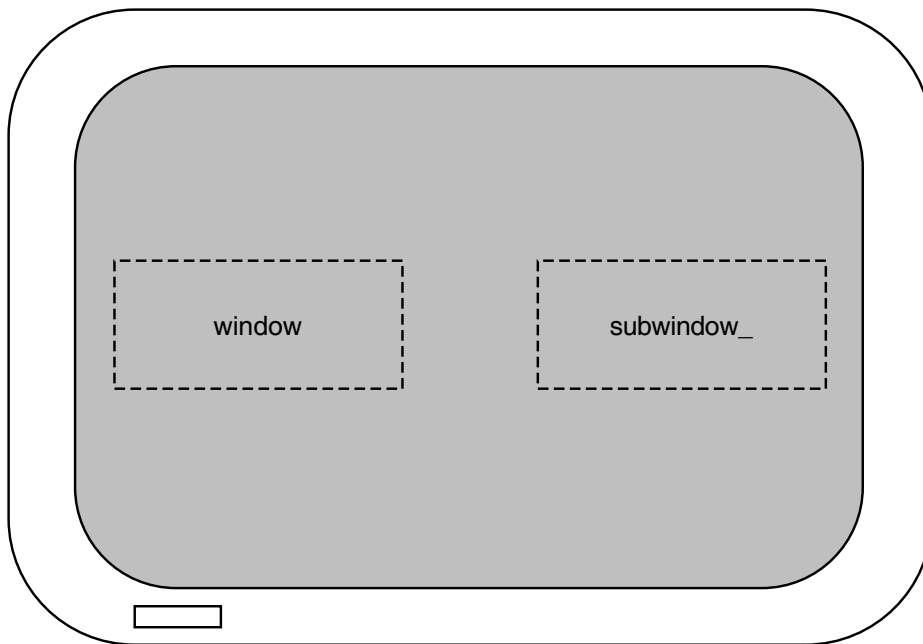

ZK-5754-GE

If you delete both the user-defined window and the subwindow, and then update the terminal screen with the new image, your terminal screen will look like Figure 6-3.

Figure 6–3 Updating the Terminal Screen

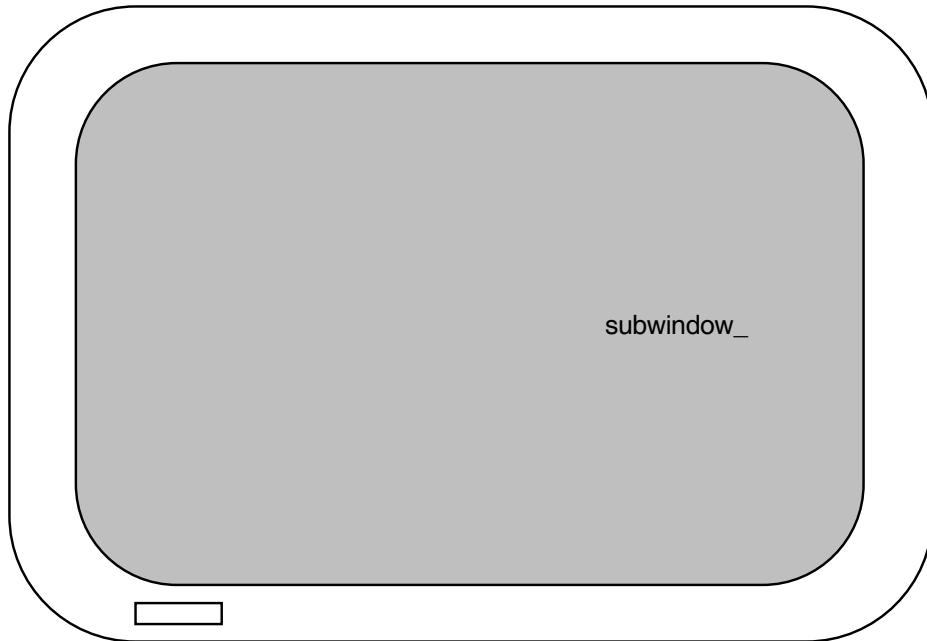

ZK-5753-GE

The string written on the window is deleted, but the string written on the subwindow remains on `stdscr`.

6.4 Getting Started with Curses

There are commands that you must use to initialize and restore the terminal screen when using Curses Screen Management functions and macros. Also, there are predefined variables and constants on which Curses depends. Example 6–1 shows how to set up a program using Curses.

Example 6–1 A Curses Program

```
❶ #include < curses.h>
❷ WINDOW *win1, *win2, *win3;
main()
{
❸  initscr();
    .
    .
    .
    endwin();
}
```

Key to Example 6–1:

- ❶ The preprocessor directive includes the `<curses.h>` header file, which defines the data structures and variables used to implement Curses. The `<curses.h>` header file includes the `<stdio.h>` header file, so it is not necessary to duplicate this action by including `<stdio.h>` again in the program source

code. You must include `<curses.h>` to use any of the Curses functions or macros.

- ❷ In the example, `WINDOW` is a data structure defined in `<curses.h>`. You must declare each user-specified window in this manner. In Example 6–1, the three defined windows are `win1`, `win2`, and `win3`.
- ❸ The `initscr` and `endwin` functions begin and end the window editing session. The `initscr` function clears the terminal screen (for OpenVMS Curses only; BSD-based Curses does not clear the screen), and allocates space for the windows `stdscr` and `curscr`. The `endwin` function deletes all windows and clears the terminal screen.

Most Curses users wish to define and modify windows. Example 6–2 shows you how to define and write to a single window.

Example 6–2 Manipulating Windows

```
#include <curses.h>
WINDOW *win1, *win2, *win3;
main()
{
    initscr();
    ❶ win1 = newwin(24, 80, 0, 0);
    ❷ mvwaddstr(win1, 2, 2, "HELLO");
        .
        .
        .
    endwin();
}
```

Key to Example 6–2:

- ❶ The `newwin` function defines a window 24 rows high and 80 columns wide with a starting position at coordinates (0,0), the upper left corner of the terminal screen. The program assigns these attributes to `win1`. The coordinates are specified as follows: (lines,columns) or (y,x).
- ❷ The `mvwaddstr` macro performs the same task as a call to the separate macros `move` and `addstr`. The `mvwaddstr` macro moves the cursor to the specified coordinates and writes a string onto `stdscr`.

Note

Most Curses macros update `stdscr` by default. Curses functions that update other windows have the same name as the macros but with the added prefix “w”. For example, the `addstr` macro adds a given string to `stdscr` at the current cursor position. The `waddstr` function adds a given string to a specified window at the current cursor position.

When updating a window, specify the cursor position relative to the origin of the window, not the origin of the terminal screen. For example, if a window has a starting position of (10,10) and you want to add a character to the window at its starting position, specify the coordinates (0,0), not (10,10).

The string HELLO in Example 6–2 does not appear on the terminal screen until you refresh the screen. You accomplish this by using the wrefresh function. Example 6–3 shows how to display the contents of win1 on the terminal screen.

Example 6–3 Refreshing the Terminal Screen

```
#include <curses.h>
WINDOW *win1, *win2, *win3;
main()
{
    initscr();

    win1 = newwin(22, 60, 0, 0);
    mvwaddstr(win1, 2, 2, "HELLO");
    wrefresh(win1);
    .
    .
    .
    endwin();
}
```

The wrefresh function updates just the region of the specified window on the terminal screen. When the program is executed, the string HELLO appears on the terminal screen until the program executes the endwin function. The wrefresh function only refreshes the part of the window on the terminal screen that is not overlapped by another window. If win1 was overlapped by another window and you want all of win1 to be displayed on the terminal screen, call the touchwin function.

6.5 Predefined Variables and Constants

The <curses.h> header file defines variables and constants useful for implementing Curses (see Table 6–2).

Table 6–2 Curses Predefined Variables and #define Constants

Name	Type	Description
curscr	WINDOW *	Window of current screen
stdscr	WINDOW *	Default window
LINES	int	Number of lines on the terminal screen
COLS	int	Number of columns on the terminal screen
ERR	—	Flag (0) for failed routines
OK	—	Flag (1) for successful routines
TRUE	—	Boolean true flag (1)
FALSE	—	Boolean false flag (0)
_BLINK	—	Parameter for setattr and clrattr
_BOLD	—	Parameter for setattr and clrattr

(continued on next page)

Table 6–2 (Cont.) Curses Predefined Variables and #define Constants

Name	Type	Description
<code>_REVERSE</code>	—	Parameter for <code>setattr</code> and <code>clrattr</code>
<code>_UNDERLINE</code>	—	Parameter for <code>setattr</code> and <code>clrattr</code>

For example, you can use the predefined macro `ERR` to test the success or failure of a Curses function. Example 6–4 shows how to perform such a test.

Example 6–4 Curses Predefined Variables

```
#include <curses.h>
WINDOW *win1, *win2, *win3;
main()
{
    initscr();
    win1 = newwin(10, 10, 1, 5);
    .
    .
    .
    if (mvwin(win1, 1, 10) == ERR)
        addstr("The MVWIN function failed.");
    .
    .
    .
    endwin();
}
```

In Example 6–4, if the `mvwin` function fails, the program adds a string to `stdscr` that explains the outcome. The Curses `mvwin` function moves the starting position of a window.

6.6 Cursor Movement

In the UNIX system environment, you can use Curses functions to move the cursor across the terminal screen. With other implementations, you can either allow Curses to move the cursor using the `move` function, or you can specify the origin and the destination of the cursor to the `mvcur` function, which moves the cursor in a more efficient manner.

In HP C for OpenVMS Systems, the two functions are functionally equivalent and move the cursor with the same efficiency.

Example 6–5 shows how to use the `move` and `mvcur` functions.

Example 6–5 The Cursor Movement Functions

```
#include <curses.h>

main()
{
    initscr();
    .
    .
    .
    ❶ clear();
    ❷ move(10, 10);
    ❸ move(LINES/2, COLS/2);
    ❹ mvcur(0, COLS-1, LINES-1, 0);
    .
    .
    .
    endwin();
}
```

Key to Example 6–5:

- ❶ The `clear` macro erases `stdscr` and positions the cursor at coordinates (0,0).
- ❷ The first occurrence of `move` moves the cursor to coordinates (10,10).
- ❸ The second occurrence of `move` uses the predefined variables `LINES` and `COLS` to calculate the center of the screen (by calculating the value of half the number of `LINES` and `COLS` on the screen).
- ❹ The `mvcur` function forces absolute addressing. This function can address the lower left corner of the screen by claiming that the cursor is presently in the upper right corner. You can use this method if you are unsure of the current position of the cursor, but `move` works just as well.

6.7 Program Example

The following program example shows the effects of many of the Curses macros and functions. You can find explanations of the individual lines of code, if not self-explanatory, in the comments to the right of the particular line. Detailed discussions of the functions follow the source code listing.

Example 6–6 shows the definition and manipulation of one user-defined window and `stdscr`.

Example 6–6 `stdscr` and Occluding Windows

```
/*          CHAP_6_STDCR_OCCLUDE.C          */
/* This program defines one window: win1. win1 is */
/* located towards the center of the default window */
/* stdscr. When writing to an occluding window (win1) */
/* that is later erased, the writing is erased as well. */
#include <curses.h> /* Include header file. */
WINDOW *win1; /* Define windows. */
main()
{
    char str[80]; /* Variable declaration.*/
```

(continued on next page)

Example 6–6 (Cont.) stdscr and Occluding Windows

```
    initscr(); /* Set up Curses. */
    noecho(); /* Turn off echo. */

    /* Create window. */
    win1 = newwin(10, 20, 10, 10);

    box(stdscr, '|', '-'); /* Draw a box around stdscr. */
    box(win1, '|', '-'); /* Draw a box around win1. */

    refresh(); /* Display stdscr on screen. */

    wrefresh(win1); /* Display win1 on screen. */

❶ getch(str); /* Pause. Type a few words! */

❷ mvaddstr(22, 1, str);
  getch();
  /* Add string to win1. */

  mvwaddstr(win1, 5, 5, "Hello");
  wrefresh(win1); /* Add win1 to terminal scr. */

  getch(); /* Pause. Press Return. */

  delwin(win1); /* Delete win1. */

❸ touchwin(stdscr); /* Refresh all of stdscr. */

  getch(); /* Pause. Press Return. */
  endwin(); /* Ends session. */
}
```

Key to Example 6–6:

- ❶ The program waits for input. The echo was disabled using the `noecho` macro, so the words that you type do not appear on `stdscr`. However, the macro stores the words in the variable `str` for use elsewhere in the program.
- ❷ The `getch` macro causes the program to pause. When you are finished viewing the screen, press Return so the program can resume. The `getch` macro refreshes `stdscr` on the terminal screen without calling `refresh`. The screen appears like Figure 6–4.

Figure 6-4 An Example of the getch Macro

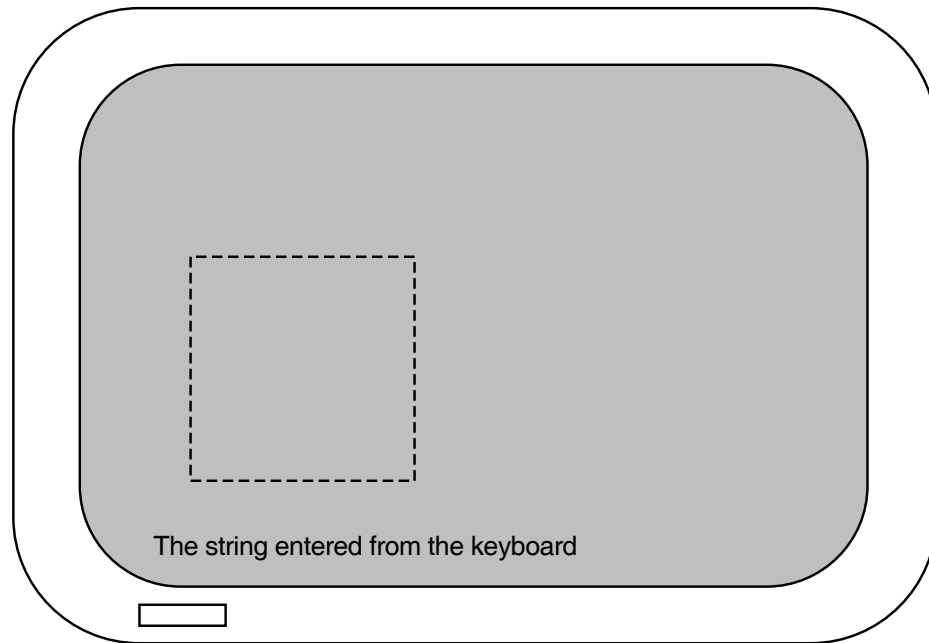

ZK-5751-GE

- ③ The touchwin function refreshes the screen so that all of stdscr is visible and the deleted occluding window no longer appears on the screen.

Math Functions

Table 7–1 lists and describes the math functions in the HP C Run-Time Library (RTL). For more detailed information on each function, see the Reference Section.

Table 7–1 Math Functions

Function	Description
abs	Returns the absolute value of an integer.
acos	Returns the arc cosine of its radian argument, in the range $[0, \pi]$ radians.
acosc <i>(Integrity servers, Alpha)</i>	Returns the arc cosine of its radian argument, in the range $[0, 180]$ degrees.
acosh <i>(Integrity servers, Alpha)</i>	Returns the hyperbolic arc cosine of its argument.
asin	Returns the arc sine of its radian argument in the range $[-\pi/2, \pi/2]$ radians.
asind <i>(Integrity servers, Alpha)</i>	Returns the arc sine of its radian argument, in the range $[-90, 90]$ degrees.
asinh <i>(Integrity servers, Alpha)</i>	Returns the hyperbolic arc sine of its argument.
atan	Returns the arc tangent of its radian argument, in the range $[-\pi/2, \pi/2]$ radians.
atand <i>(Integrity servers, Alpha)</i>	Returns the arc tangent of its radian argument, in the range $[-90, 90]$ degrees.
atan2	Returns the arc tangent of y/x (its two radian arguments), in the range $[-\pi, \pi]$ radians.
atand2 <i>(Integrity servers, Alpha)</i>	Returns the arc tangent of y/x (its two radian arguments), in the range $[-180, 180]$ degrees.
atanh <i>(Integrity servers, Alpha)</i>	Returns the hyperbolic arc tangent of its radian argument.
cabs	Returns the absolute value of a complex number as: $\text{sqrt}(x^2 + y^2)$.
cbrt <i>(Integrity servers, Alpha)</i>	Returns the rounded cube root of its argument.
ceil	Returns the smallest integer greater than or equal to its argument.
copysign <i>(Integrity servers, Alpha)</i>	Returns its first argument with the same sign as its second.
cos	Returns the cosine of its radian argument in radians.

(continued on next page)

Table 7–1 (Cont.) Math Functions

Function	Description
<code>cosd</code> <i>(Integrity servers, Alpha)</i>	Returns the cosine of its radian argument in degrees.
<code>cosh</code>	Returns the hyperbolic cosine of its argument.
<code>cot</code>	Returns the cotangent of its radian argument in radians.
<code>cotd</code> <i>(Integrity servers, Alpha)</i>	Returns the cotangent of its radian argument in degrees.
<code>drand48</code> , <code>erand48</code> , <code>jrand48</code> , <code>lrand48</code> , <code>mrand48</code> , <code>rand48</code>	Generates uniformly distributed pseudorandom number sequences. Returns 48-bit, nonnegative, double-precision floating-point values.
<code>erf</code> <i>(Integrity servers, Alpha)</i>	Returns the error function of its argument.
<code>erfc</code> <i>(Integrity servers, Alpha)</i>	Returns $(1.0 - \text{erf}(x))$.
<code>exp</code>	Returns the base e raised to the power of the argument.
<code>expm1</code> <i>(Integrity servers, Alpha)</i>	Returns $\text{exp}(x) - 1$.
<code>fabs</code>	Returns the absolute value of a floating-point value.
<code>finite</code> <i>(Integrity servers, Alpha)</i>	Returns 1 if its argument is a finite number; 0 if not.
<code>floor</code>	Returns the largest integer less than or equal to its argument.
<code>fmod</code>	Computes the floating-point remainder of its first argument divided by its second.
<code>fp_class</code> <i>(Integrity servers, Alpha)</i>	Determines the class of IEEE floating-point values, returning a constant from the <code><fp_class.h></code> header file.
<code>isnan</code> <i>(Integrity servers, Alpha)</i>	Test for NaN. Returns 1 if its argument is a NaN; 0 if not.
<code>j0</code> , <code>j1</code> , <code>jn</code> <i>(Integrity servers, Alpha)</i>	Computes Bessel functions of the first kind.
<code>frexp</code>	Calculates the fractional and exponent parts of a floating-point value.
<code>hypot</code>	Returns the square root of the sum of the squares of two arguments.
<code>initstate</code>	Initializes random number generators.
<code>labs</code>	Returns the absolute value of an integer as a long int.
<code>lcong48</code>	Initializes a 48-bit uniformly distributed pseudorandom number sequence.
<code>lgamma</code> <i>(Integrity servers, Alpha)</i>	Computes the logarithm of the gamma function.
<code>llabs</code> , <code>qabs</code> <i>(Integrity servers, Alpha)</i>	Returns the absolute value of an <code>__int64</code> integer.
<code>ldexp</code>	Returns its first argument multiplied by 2 raised to the power of its second argument.
<code>ldiv</code> , <code>div</code>	Returns the quotient and remainder after the division of their arguments.

(continued on next page)

Table 7–1 (Cont.) Math Functions

Function	Description
lldiv, qdiv <i>(Integrity servers, Alpha)</i>	Returns the quotient and remainder after the division of their arguments.
log2 <i>(Integrity servers, Alpha)</i> , log, log10	Returns the logarithm of their arguments.
log1p <i>(Integrity servers, Alpha)</i>	Computes $\ln(1+x)$ accurately.
logb <i>(Integrity servers, Alpha)</i>	Returns the radix-independent exponent of its argument.
nextafter <i>(Integrity servers, Alpha)</i>	Returns the next machine-representable number following x in the direction of y .
nint <i>(Integrity servers, Alpha)</i>	Returns the nearest integral value to the argument.
modf	Returns the positive fractional part of its first argument and assigns the integral part to the object whose address is specified by the second argument.
pow	Returns the first argument raised to the power of the second.
rand, srand	Returns pseudorandom numbers in the range 0 to $2^{31} - 1$.
random, srandom	Generates pseudorandom numbers in a more random sequence.
rint <i>(Integrity servers, Alpha)</i>	Rounds its argument to an integral value according to the current IEEE rounding direction specified by the user.
scalb <i>(Integrity servers, Alpha)</i>	Returns the exponent of a floating-point number.
seed48, srand48	Initializes a 48-bit random number generator.
setstate	Restarts, and changes random number generators.
sin	Returns the sine of its radian argument in radians.
sind <i>(Integrity servers, Alpha)</i>	Returns the sine of its radian argument in degrees.
sinh	Returns the hyperbolic sine of its argument.
sqrt	Returns the square root of its argument.
tan	Returns the tangent of its radian argument in radians.
tand <i>(Integrity servers, Alpha)</i>	Returns the tangent of its radian argument in degrees.
tanh	Returns the hyperbolic tangent of its argument.
trunc <i>(Integrity servers, Alpha)</i>	Truncates its argument to an integral value.
unordered <i>(Integrity servers, Alpha)</i>	Returns 1 if either or both of its arguments is a NaN; 0, if not.
y0, y1, yn <i>(Integrity servers, Alpha)</i>	Computes Bessel functions of the second kind.

7.1 Math Function Variants—float, long double (Integrity servers, Alpha)

Additional math routine variants are supported for HP C on OpenVMS Alpha and Integrity server systems only. They are defined in `<math.h>` and are float and long double variants of the routines listed in Table 7-1.

Float variants take float arguments and return float values. Their names have an `f` suffix. For example:

```
float cosf (float x);
float tanf (float x);
```

Long double variants take long double arguments and return long double values. Their names have an `l` suffix. For example:

```
long double cosl (long double x);
long double tandl (long double x);
```

All math routine variants are included in the Reference Section of this manual.

Note that for programs compiled without `/L_DOUBLE=64` (that is, compiled with the default `/L_DOUBLE=128`), the long double variants of these HP C RTL math routines map to the `X_FLOAT` entry points documented in the *HP Portable Mathematics Library* (HPML) manual.

7.2 Error Detection

To help you detect run-time errors, the `<errno.h>` header file defines the following two symbolic values that are returned by many (but not all) of the mathematical functions:

- `EDOM` indicates that an argument is inappropriate; the argument is not within the function's domain.
- `ERANGE` indicates that a result is out of range; the argument is too large or too small to be represented by the machine.

When using the math functions, you can check the external variable `errno` for either or both of these values and take the appropriate action if an error occurs.

The following program example checks the variable `errno` for the value `EDOM`, which indicates that a negative number was specified as input to the function `sqrt`:

```
#include <errno.h>
#include <math.h>
#include <stdio.h>

main()
{
    double input, square_root;

    printf("Enter a number: ");
    scanf("%le", &input);
    errno = 0;
    square_root = sqrt(input);

    if (errno == EDOM)
        perror("Input was negative");
    else
        printf("Square root of %e = %e\n",
            input, square_root);
}
```

If you did not check `errno` for this symbolic value, the `sqrt` function returns 0 when a negative number is entered. For more information about the `<errno.h>` header file, see Chapter 4.

7.3 The `<fp.h>` Header File

The `<fp.h>` header file implements some of the features defined by the Numerical C Extensions Group of the ANSI X3J11 committee. You might find this useful for applications that make extensive use of floating-point functions.

Some of the double-precision functions listed in this chapter return the value `±HUGE_VAL` (defined in either `<math.h>` or `<fp.h>`) if the result is out of range. The float version of those functions return the value `HUGE_VALF` (defined only in `<fp.h>`) for the same conditions. The long double version returns the value `HUGE_VALL` (also defined in `<fp.h>`).

For programs compiled to enable IEEE infinity and NaN values, the values `HUGE_VAL`, `HUGE_VALF`, and `HUGE_VALL` are expressions, not compile-time constants. Initializations such as the following cause a compile-time error:

```
$ CREATE IEEE_INFINITY.C
#include <fp.h>

double my_huge_val = HUGE_VAL
^Z
$ CC /FLOAT=IEEE/IEEE=DENORM IEEE_INFINITY
double my_huge_val = HUGE_VAL;
.....^
%CC-E-NEEDCONSTEXPR, In the initializer for my_huge_val, "decc$gt_dbl_infinity"
is not constant, but occurs in a context that requires a constant expression.
at line number 3 in file WORK1$:[RTL]IEEE_INFINITY.C;1
$
```

When using both `<math.h>` and `<fp.h>`, be aware that `<math.h>` defines a function `isnan` and `<fp.h>` defines a macro by the same name. Whichever header is included first in the application will resolve a reference to `isnan`.

7.4 Example

Example 7-1 shows how the `tan`, `sin`, and `cos` functions operate.

Example 7-1 Calculating and Verifying a Tangent Value

```
/*          CHAP_7_MATH_EXAMPLE.C          */
/* This example uses two functions --- mytan and main --- */
/* to calculate the tangent value of a number, and to check */
/* the calculation using the sin and cos functions.          */

#include <math.h>
#include <stdio.h>

/* This function calculates the tangent using the sin and */
/* cos functions.                                          */

double mytan(x)
    double x;
{
    double y,
           y1,
           y2;
```

(continued on next page)

Example 7–1 (Cont.) Calculating and Verifying a Tangent Value

```
    y1 = sin(x);
    y2 = cos(x);
    if (y2 == 0)
        y = 0;
    else
        y = y1 / y2;
    return y;
}
main()
{
    double x;
    /* Print values: compare */
    for (x = 0.0; x < 1.5; x += 0.1)
        printf("tan of %4.1f = %6.2f\t%6.2f\n", x, mytan(x), tan(x));
}
```

Example 7–1 produces the following output:

```
$ RUN EXAMPLE
tan of 0.0 = 0.00 0.00
tan of 0.1 = 0.10 0.10
tan of 0.2 = 0.20 0.20
tan of 0.3 = 0.31 0.31
tan of 0.4 = 0.42 0.42
tan of 0.5 = 0.55 0.55
tan of 0.6 = 0.68 0.68
tan of 0.7 = 0.84 0.84
tan of 0.8 = 1.03 1.03
tan of 0.9 = 1.26 1.26
tan of 1.0 = 1.56 1.56
tan of 1.1 = 1.96 1.96
tan of 1.2 = 2.57 2.57
tan of 1.3 = 3.60 3.60
tan of 1.4 = 5.80 5.80
$
```

Memory Allocation Functions

Table 8–1 lists and describes all the memory allocation functions found in the HP C Run-Time Library (RTL). For a more detailed description of each function, see the Reference Section.

Table 8–1 Memory Allocation Functions

Function	Description
<code>brk</code> , <code>sbrk</code>	Determine the lowest virtual address that is not used with the program.
<code>calloc</code> , <code>malloc</code>	Allocate an area of memory.
<code>cfree</code> , <code>free</code>	Make available for reallocation the area allocated by a previous <code>calloc</code> , <code>malloc</code> , or <code>realloc</code> call.
<code>realloc</code>	Changes the size of the area pointed to by the first argument to the number of bytes given by the second argument.
<code>strdup</code>	Duplicates a string.

All HP C RTL functions requiring additional storage from the heap get that storage using the HP C RTL memory allocation functions `malloc`, `calloc`, `realloc`, `free`, and `cfree`. Memory allocated by these functions is quadword-aligned.

The ANSI C standard does not include `cfree`. For this reason, it is preferable to free memory using the functionally equivalent `free` function.

The `brk` and `sbrk` functions assume that memory can be allocated contiguously from the top of your address space. However, the `malloc` function and RMS may allocate space from this same address space. Do not use the `brk` and `sbrk` functions in conjunction with RMS and HP C RTL routines that use `malloc`.

Previous versions of the VAX C RTL documentation indicated that the memory allocation routines used the OpenVMS RTL functions `LIB$GET_VM` and `LIB$FREE_VM` to acquire and return dynamic memory. This is no longer the case; interaction between these routines and the HP C RTL memory allocation routines is no longer problematic (although `LIB$SHOW_VM` can no longer be used to track HP C RTL `malloc` and `free` usage).

The HP C RTL memory allocation functions `calloc`, `malloc`, `realloc`, and `free` are based on the `LIB$` routines `LIB$VM_CALLOC`, `LIB$VM_MALLOC`, `LIB$VM_REALLOC` and `LIB$VM_FREE`, respectively.

The routines `VAXC$CALLOC_OPT`, `VAXC$CFREE_OPT`, `VAXC$FREE_OPT`, `VAXC$MALLOC_OPT`, and `VAXC$REALLOC_OPT` are now obsolete and should not be used in new development. However, versions of these routines that are equivalent to the standard C memory allocation routines are provided for backward compatibility.

8.1 Program Example

Example 8–1 shows the use of the malloc, calloc, and free functions.

Example 8–1 Allocating and Deallocating Memory for Structures

```
/*          CHAP_8_MEM_MANAGEMENT.C          */
/* This example takes lines of input from the terminal until */
/* it encounters a Ctrl/Z, places the strings into an      */
/* allocated buffer, copies the strings to memory allocated for */
/* structures, prints the lines back to the screen, and then */
/* deallocates all the memory used for the structures.      */

#include <stdlib.h>
#include <stdio.h>
#define MAX_LINE_LENGTH 80

struct line_rec {          /* Declare the structure. */
    struct line_rec *next; /* Pointer to next line. */
    char *data;            /* A line from terminal. */
};

int main(void)
{
    char *buffer;

    /* Define pointers to */
    /* structure (input lines). */

    struct line_rec *first_line = NULL,
                    *next_line,
                    *last_line = NULL;

    /* Buffer points to memory. */
    buffer = malloc(MAX_LINE_LENGTH);

    if (buffer == NULL) { /* If error ... */
        perror("malloc");
        exit(EXIT_FAILURE);
    }

    while (gets(buffer) != NULL) { /* While not Ctrl/Z ... */
        /* Allocate for input line. */
        next_line = calloc(1, sizeof (struct line_rec));

        if (next_line == NULL) {
            perror("calloc");
            exit(EXIT_FAILURE);
        }

        /* Put line in data area. */
        next_line->data = buffer;

        if (last_line == NULL) /* Reset pointers. */
            first_line = next_line;
        else
            last_line->next = next_line;

        last_line = next_line;
        /* Allocate space for the */
        /* next input line. */
        buffer = malloc(MAX_LINE_LENGTH);
    }
}
```

(continued on next page)

Example 8–1 (Cont.) Allocating and Deallocating Memory for Structures

```
    if (buffer == NULL) {
        perror("malloc");
        exit(EXIT_FAILURE);
    }
}
free(buffer);          /* Last buffer always unused. */
next_line = first_line; /* Pointer to beginning. */
while (next_line != NULL) {
    puts(next_line->data); /* Write line to screen. */
    free(next_line->data); /* Deallocate a line. */
    last_line = next_line;
    next_line = next_line->next;
    free(last_line);
}
exit(EXIT_SUCCESS);
}
```

The sample input and output for Example 8–1 are as follows:

```
$ RUN EXAMPLE
line one
line two
Ctrl/Z
EXIT
line one
line two
$
```

System Functions

The C programming language is a good choice if you wish to write operating systems. For example, much of the UNIX operating system is written in C. When writing system programs, it is sometimes necessary to retrieve or modify the environment in which the program is running. This chapter describes the HP C Run-Time Library (RTL) functions that accomplish this and other system tasks.

Table 9–1 lists and describes all the system functions found in the HP C RTL. For a more detailed description of each function, see the Reference Section.

Table 9–1 System Functions

Function	Description
System Functions—Searching and Sorting Utilities	
bsearch	Performs a binary search on an array of sorted objects for a specified object.
qsort	Sorts an array of objects in place by implementing the quick-sort algorithm.
System Functions—Retrieving Process Information	
ctermid	Returns a character string giving the equivalence string of SYS\$COMMAND, which is the name of the controlling terminal.
cuserid	Returns a pointer to a character string containing the name of the user who initiated the current process.
getcwd	Returns a pointer to the file specification for the current working directory.
getegid, geteuid, getgid, getuid	Return, in OpenVMS terms, group and member numbers from the user-identification code (UIC).
getenv	Searches the environment array for the current process and returns the value associated with a specified environment.
getlogin	Gets the login name of the user associated with the current session.
getpid	Returns the process ID of the current process.
getppid	Returns the parent process ID of the calling process.
getpwnam	Accesses user-name information in the user database.
getpwuid	Accesses user-ID information in the user database.

(continued on next page)

Table 9–1 (Cont.) System Functions

Function	Description
System Functions—Changing Process Information	
chdir	Changes the default directory.
chmod	Changes the file protection of a file.
chown	Changes the owner user identification code (UIC) of a file.
mkdir	Creates a directory.
nice	Increases or decreases the process priority to the process base priority by the amount of the argument.
putenv	Sets an environmental variable.
setenv	Inserts or resets the environment variable name in the current environment list.
setgid, setuid	Implemented for program portability and have no functionality.
sleep, usleep	Suspend the execution of the current process for at least the number of seconds indicated by its argument.
umask	Creates a file protection mask that is used whenever a new file is created. It returns the old mask value.
System Functions—Retrieving and Converting Date/Time Information	
asctime	Converts a broken-down time into a 26-character string.
clock	Determines the CPU time, in microseconds, used since the beginning of the program execution.
clock_getres	Gets the resolution for the specified clock.
clock_gettime	Returns the current time (in seconds and nanoseconds) for the specified clock.
clock_settime	Sets the specified clock.
ctime	Converts a time, in seconds, to an ASCII string in the form generated by the asctime function.
decc\$fix_time	Converts OpenVMS binary system times to UNIX binary times.
difftime	Computes the difference, in seconds, between the two times specified by its arguments.
ftime	Returns the elapsed time since 00:00:00, January 1, 1970, in the structure timeb.
getclock	Gets the current value of the systemwide clock.
getdate	Converts a formatted string to a time/date structure.
getitimer	Returns the value of interval timers.
gettimeofday	Gets the date and time.
gmtime	Converts time units to broken-down UTC time.
localtime	Converts a time (expressed as the number of seconds elapsed since 00:00:00, January 1, 1970) into hours, minutes, seconds, and so on.
mktime	Converts a local-time structure into time since the Epoch.

(continued on next page)

Table 9–1 (Cont.) System Functions

Function	Description
System Functions—Retrieving and Converting Date/Time Information	
nanosleep	High-resolution sleep (REALTIME). Suspends a process from execution for the specified timer interval.
setitimer	Sets the value of interval timers.
strftime, wcsftime	Place characters into an array, as controlled by a specified format string.
strptime	Converts a character string into date and time values.
time	Returns the time elapsed since 00:00:00, January 1, 1970, in seconds.
times	Returns the accumulated times of the current process and of its terminated child processes.
tzset	Sets and accesses time-zone conversion.
ualarm	Sets or changes the timeout of interval timers.
wcsftime	Uses date and time information stored in a tm structure to create a wide-character output string.
System Function—Miscellaneous	
VAXC\$CRTL_INIT	Initializes the run-time environment and establishes an exit and condition handler, which makes it possible for HP C RTL functions to be called from other languages.

Example 9–1 shows how the cuserid function is used.

Example 9–1 Accessing the User Name

```

/*          CHAP_9_GET_USER.C          */
/* Using cuserid, this program returns the user name.          */
#include <stdio.h>
main()
{
    static char string[L_cuserid];
    cuserid(string);
    printf("Initiating user: %s\n", string);
}

```

If a user named TOLLIVER runs the program, the following is displayed on stdout:

```

$ RUN EXAMPLE1
Initiating user: TOLLIVER

```

Example 9–2 shows how the getenv function is used.

Example 9–2 Accessing Terminal Information

```
/*          CHAP_9_GETTERM.C          */
/* Using getenv, this program returns the terminal. */
#include <stdio.h>
#include <stdlib.h>

main()
{
    printf("Terminal type: %s\n", getenv("TERM"));
}
```

Running Example 9–2 on a VT100 terminal in 132-column mode displays the following:

```
$ RUN EXAMPLE3
Terminal type: vt100-132
```

Example 9–3 shows how to use `getenv` to find the user’s default login directory and how to use `chdir` to change to that directory.

Example 9–3 Manipulating the Default Directory

```
/*          CHAP_9_CHANGE_DIR.C          */
/* This program performs the equivalent of the DCL command */
/* SET DEFAULT SYS$LOGIN. However, once the program exits, the */
/* directory is reset to the directory from which the program */
/* was run. */
#include <stdio.h>
#include <unistd.h>
#include <stdlib.h>

main()
{
    char *dir;
    int i;

    dir = getenv("HOME");
    if ((i = chdir(dir)) != 0) {
        perror("Cannot set directory");
        exit(0);
    }

    printf("Current directory: %s\n", dir);
}
```

Running Example 9–3 displays the following:

```
$ RUN EXAMPLE4
Current directory: dba0:[tolliver]
$
```

Example 9–4 shows how to use the `time`, `localtime`, and `strftime` functions to print the correct date and time at the terminal.

Example 9–4 Printing the Date and Time

```
/*          CHAP_9_DATE_TIME.C          */
/* The time function returns the time in seconds; the localtime */
/* function converts the time to hours, minutes, and so on;    */
/* the strftime function uses these values to obtain a string  */
/* in the desired format.                                       */

#include <time.h>
#include <stdio.h>

#define MAX_STRING 80

main()
{
    struct tm *time_structure;
    time_t time_val;
    char output_str[MAX_STRING];

    time(&time_val);
    time_structure = localtime(&time_val);

    /* Print the date */
    strftime(output_str, MAX_STRING,
              "Today is %A, %B %d, %Y", time_structure);

    printf("%s\n", output_str);

    /* Print the time using a 12-hour clock format. */
    strftime(output_str, MAX_STRING,
              "The time is %I:%M %p", time_structure);

    printf("%s\n", output_str);
}
```

Running Example 9–4 displays the following:

```
$ RUN EXAMPLE5
Today is Thursday, May 20, 1993
The time is 10:18 AM
$
```

Developing International Software

This chapter describes typical features of international software and the features provided with the HP C Run-Time Library (RTL) that enable you to design and implement international software.

See the Reference Section for more detailed information on the functions described in this chapter.

10.1 Internationalization Support

The HP C RTL has added capabilities to allow application developers to create international software. The HP C RTL obtains information about a language and a culture by reading this information from *locale* files.

10.1.1 Installation

If you are using these HP C RTL capabilities, you must install a separate kit to provide these files to your system. See the appendix "Installing OpenVMS Internationalization data kit" in the *OpenVMS Upgrade and Installation Guide*.

On OpenVMS Alpha systems the save set is provided on the Layered Product CD, and is named VMSI18N0nn or ALPVMSI18N0n_07nn.

To install this save set, follow the standard OpenVMS installation procedures using this save-set name as the name of the kit. There are several categories of locales that you can select to install. You can select as many locales as you need by answering the following prompts:

- * Do you want European and US support? [YES]?
- * Do you want Chinese GB18030 support (locale and Unicode converters) [YES]?
- * Do you want Chinese support? [YES]?
- * Do you want Japanese support? [YES]?
- * Do you want Korean support? [YES]?
- * Do you want Thai support? [YES]?
- * Do you want the Unicode converters? [YES]?

This kit also has an Installation Verification Procedure that we recommend you run to verify the correct installation of the kit.

10.1.2 Unicode Support

In OpenVMS Version 7.2, the HP C Run-Time Library added the Universal Unicode locale, which is distributed with the OpenVMS system, not with the VMSI18N0nn kit. The name of the Unicode locale is:

UTF8-20

Like those locales shipped with the VMSI18N0nn kit, the Unicode locale is located at the standard location referred to by the SYS\$I18N_LOCALE logical name.

The UTF8-20 Unicode is based on Unicode standard Version V2.0. The Unicode locale uses UCS-4 as wide-character encoding and UTF-8 as multibyte character encodings.

HP C RTL also includes converters that perform conversions between Unicode and any other supported character sets. The expanded set of converters includes converters for UCS-2, UCS-4, and UTF-8 Unicode encoding. The Unicode converters can be used by the ICONV CONVERT utility and by the iconv family of functions in the HP C Run-Time Library.

In OpenVMS Version 7.2, the HP C Run-Time Library added Unicode character set converters for Microsoft Code Page 437.

10.2 Features of International Software

International software is software that can support multiple languages and cultures. An international program should be able to:

- Display messages in the user's own language. This includes screen displays, error messages, and prompts.
- Handle culture-specific information such as:

- Date and time formatting

The conventions for representing dates and times vary from one country to another. For example, in the US the month is given first; in the UK the day is specified first. Therefore, the date 12/5/1993 is interpreted as December 5, 1993 in the US, and as May 12, 1993 in the UK.

- Numeric formatting

The character that represents the decimal point (the radix character) and the thousands separator character vary from one country to another. For example, in the UK the period (.) is used to represent the radix character, and the comma is used as a separator. However, in Germany, the comma is used as the radix character and the period is the separator character. Therefore, the number 2,345.67 in the UK is the same as 2.345,67 in Germany.

- Monetary formatting

Currency values are represented by different symbols and can be formatted using a variety of separator characters, depending on the currency.

- Handle different coded character sets (not just ASCII).
- Handle a mixture of single and multibyte characters.
- Provide multipass string comparisons.

String comparison functions such as `strcmp` compare strings by comparing the codepoint values of the characters in the strings. However, some languages require more complex comparisons to correctly sort strings.

To meet the previous requirements, an application should not make any assumptions about the language, local customs, or the coded character set used. All this localization data should be defined separately from the program, and only bound to it at run time.

The rest of this chapter describes how you can create international software using HP C.

10.3 Developing International Software Using HP C

The HP C environment provides the following facilities to create international software:

- A method for separating localization data from a program.
Localization data is held in a database known as a *locale*. This stores all the language and culture information required by a program. See Section 10.4 for details of the structure of locales.
A program specifies what locales to use by calling the `setlocale` function. See Section 10.5 for more information.
- A method of separating message text from the program source.
This is achieved using *message catalogs* that store all the messages for an application. The message catalog is linked to the application at run time. This means that the messages can be translated into different languages and then the required language version is selected at run time. See Section 10.6.
- HP C RTL functions that are sensitive to localization data.
The HP C RTL includes functions for:
 - Converting between different codesets. See Section 10.7.
 - Handling culture-specific information. See Section 10.8.
 - Multipass string collation. See Section 10.10.
- A special wide-character data type defined in the HP C RTL makes it easier to handle codesets that have a mixture of single and multibyte characters. A set of functions is also defined to support this wide-character data type. See Section 10.9.

10.4 Locales

A locale consists of different categories, each of which determines one aspect of the international environment. Table 10–1 lists the categories in a locale and describes the information in each.

Table 10–1 Locale Categories

Category	Description
LC_COLLATE	Contains information about collating sequences.
LC_CTYPE	Contains information about character classification.
LC_MESSAGES	Defines the answers that are expected in response to yes/no prompts.
LC_MONETARY	Contains monetary formatting information.
LC_NUMERIC	Contains information about formatting numbers.
LC_TIME	Contains time and date information.

The locales provided reside in the directory defined by the `SYS$I18N_LOCALE` logical name. The file-naming convention for locales is:

`language_country_codeset.locale`

Where:

- *language* is the mnemonic for the language. For example, EN indicates an English locale.
- *country* is the mnemonic for the country. For example, GB indicates a British locale.
- *codeset* is the name of the ISO standard codeset for the locale. For example, ISO8859-1 is the ISO 8859 codeset for the Western European languages. See Section 10.7 for more information about the codesets supported.

10.5 Using the `setlocale` Function to Set Up an International Environment

An application sets up its international environment at run time by calling the `setlocale` function. The international environment is set up in one of two ways:

- The environment is defined by one locale. In this case, each of the locale categories is defined by the same locale.
- Categories are defined separately. This lets you define a mixed environment that uses different locales depending on the operation performed. For example, if an English user has some Spanish files that are to be processed by an application, the `LC_COLLATE` category could be defined by a Spanish locale while the other categories are defined by an English locale. To do this you would call `setlocale` once for each category.

The syntax for the `setlocale` function is:

```
char *setlocale(int category, const char *locale)
```

Where:

- *category* is either the name of a category, or `LC_ALL`. Specifying `LC_ALL` means that all the categories are defined by the same locale. Specify a category name to set up a mixed environment.
- *locale* is one of the following:

- The name of the locale to use.

If you want users to specify the locale interactively, your application could prompt the user for a locale name, and then pass the name as an argument to the `setlocale` function. A locale name has the following format:

```
language_country.codeset[@modifier]
```

For example, `setlocale(LC_COLLATE, "en_US.ISO8859-1")` selects the locale `en_US.ISO8859-1` for the `LC_COLLATE` category.

- ""

This causes the function to use logical names to determine the locale for the category specified. See [Specifying the Locale Using Logical Names](#) for details.

If an application does not call the `setlocale` function, the default locale is the C locale. This allows such applications to call those functions that use information in the current locale.

Specifying the Locale Using Logical Names

If the `setlocale` function is called with "" as the *locale* argument, the function checks for a number of logical names to determine the locale name for the category specified.

There are a number of logical names that users can set up to define their international environment:

- Logical name corresponding to a category
For example, the `LC_NUMERIC` logical name defines the locale associated with the `LC_NUMERIC` category within the user's environment.
- `LC_ALL`
- `LANG`
The `LANG` logical name defines the user's language.

In addition to the logical names defined by a user, there are a number of systemwide logical names, set up during system startup, that define the default international environment for all users on a system:

- `SYS$category`
Where *category* is the name of a category. This specifies the system default for that category.
- `SYS$LC_ALL`
- `SYS$LANG`

The `setlocale` function checks for user-defined logical names first, and if these are not defined, it checks the system logical names.

10.6 Using Message Catalogs

An important requirement for international software is that it should be able to communicate with the user in the user's own language. The messaging system enables program messages to be created separately from the program source, and linked to the program at run time.

Messages are defined in a message text source file, and compiled into a message catalog using the `GENCAT` command. The message catalog is accessed by a program using the functions provided in the HP C RTL.

The functions provided to access the messages in a catalog are:

- The `catopen` function, which opens a specified catalog ready for use.
- The `catgets` function, which enables the program to read a specific message from a catalog.
- The `catclose` function, which closes a specified catalog. Open message catalogs are also closed by the `exit` function.

For information on generating message catalogs, see the `GENCAT` command description in the OpenVMS system documentation.

10.7 Handling Different Character Sets

The HP C RTL supports a number of state-independent codesets and codeset encoding schemes that contain the ASCII encoded Portable Character Set. It does not support state-dependent codesets. The codesets supported are:

- ISO8859-*n*
where *n* = 1,2,5,7,8 or 9. This covers codesets for North America, Europe (West and East), Israel, and Turkey.
- eucJP, SJIS, DECKANJI, SDECKANJI: Codesets used in Japan.
- eucTW, DECHANYU, BIG5, DECHANZI: Chinese codesets used in China (PRC), Hong-Kong, and Taiwan.
- DECKOREAN: Codeset used in Korea.

10.7.1 Charmap File

The characters in a codeset are defined in a charmap file. The charmap files supplied by HP are located in the directory defined by the SYS\$I18N_LOCALE logical name. The file type for a charmap file is .CMAP.

10.7.2 Converter Functions

As well as supporting different coded character sets, the HP C RTL provides the following converter functions that enable you to convert characters from one codeset to another:

- `iconv_open`—Specifies the type of conversion. It allocates a conversion descriptor required by the `iconv` function.
- `iconv`—Converts characters in a file to the equivalent characters in a different codeset. The converted characters are stored in a separate file.
- `iconv_close`—Deallocates a conversion descriptor and the resources allocated to the descriptor.

10.7.3 Using Codeset Converter Files

The file-naming convention for codeset converters is:

fromcode_tocode.iconv

Where *fromcode* is the name of the source codeset, and *tocode* is the name of the codeset to which characters are converted.

You can add codeset converters to a given system by installing the converter files in the directory pointed by the logical name SYS\$I18N_ICONV.

Codeset converter files can be implemented either as table-based conversion files or as algorithm-based converter files created as OpenVMS shareable images.

Creating a Table-Based Conversion File

The following summarizes the necessary steps to create a table-based codeset converter file:

1. Create a text file that describes the mapping between any character from the source codeset to the target codeset. For the format of this file, see the DCL command `ICONV COMPILE` in the OpenVMS *New Features Manual*, which processes such a file and creates a codeset converter table file.

2. Copy the resulting file from the previous step to the directory pointed by the logical SYS\$I18N_ICONV, assuming you have the privilege to do so.

Creating an Algorithm-Based Conversion File

To create an algorithm-based codeset converter file implemented as a shareable image, follow these steps:

1. Create C source files that implement the codeset converter. The API is documented in the public header file `<iconv.h>` as follows:
 - The universal entry point `_u_iconv_open` is called by the HP C RTL routine `iconv_open` to initialize a conversion.
 - `_u_iconv_open` returns to `iconv_open` a pointer to the structure `__iconv_extern_obj_t`.
 - Within this structure, the converter exports its own conversion entry point and conversion close routine, which are called by the HP C RTL routines `iconv` and `iconv_close`, respectively.
 - The major and minor identifier fields are required by `iconv_open` to test for a possible mismatch between the library and the converter. The converter usually assigns the constants `__ICONV_MAJOR` and `__ICONV_MINOR`, defined in the `<iconv.h>` header file.
 - The field `tcs_mb_cur_max` is used only by the DCL command `ICONV CONVERT` to optimize its buffer usage. This field reflects the maximum number of bytes that comprise a single character in the target codeset, including the shift sequence (if any).
2. Compile and link the modules that comprise the codeset converter as an OpenVMS shareable image, making sure that the filename adheres to the preceding conventions.
3. Copy the resulting file from the previous step to the directory pointed by the logical SYS\$I18N_ICONV, assuming you have the privilege to do so.

Some Final Notes

By default, SYS\$I18N_ICONV is a search list where the first directory in the list SYS\$SYSROOT:[SYS\$I18N.ICONV.USER] is meant for use as a site-specific repository for `iconv` codeset converters.

The number of codesets and locales installed vary from system to system. Check the SYS\$I18N directory tree for the codesets, converters, and locales installed on your system.

10.8 Handling Culture-Specific Information

Each locale contains the following cultural information:

- Date and time information
The `LC_TIME` category defines the conventions for writing date and time, the names of the days of the week, and the names of months of the year.
- Numeric information
The `LC_NUMERIC` category defines the conventions for formatting nonmonetary values.
- Monetary information

The LC_MONETARY category defines currency symbols and the conventions used to format monetary values.

- Yes and no responses

The LC_MESSAGES category defines the strings expected in response to yes/no questions.

You can extract some of this cultural information using the `nl_langinfo` function and the `localeconv` function. See Section 10.8.1.

10.8.1 Extracting Cultural Information From a Locale

The `nl_langinfo` function returns a pointer to a string that contains an item of information obtained from the program's current locale. The information you can extract from the locale is:

- Date and time formats
- The names of the days of the week, and months of the year in the local language
- The radix character
- The character used to separate groups of digits in nonmonetary values
- The currency symbol
- The name of the codeset for the locale
- The strings defined for responses to yes/no questions

The `localeconv` function returns a pointer to a data structure that contains numeric formatting and monetary formatting data from the LC_NUMERIC and LC_MONETARY categories.

10.8.2 Date and Time Formatting Functions

The functions that use the date and time information are:

- `strftime`—Takes date and time values stored in a data structure and formats them into an output string. The format of the output string is controlled by a format string.
- `strptime`—Converts a string (of type `char`) into date and time values. A format string defines how the string is interpreted.
- `wcsftime`—Does the same as `strftime` except that it creates a wide-character string.

10.8.3 Monetary Formatting Function

The `strfmon` function uses the monetary information in a locale to convert a number of values into a string. The format of the string is controlled by a format string.

10.8.4 Numeric Formatting

The information in LC_NUMERIC is used by various functions. For example, `strtod`, `wcstod`, and the `print` and `scan` functions determine the radix character from the LC_NUMERIC category.

10.9 Functions for Handling Wide Characters

A character can be represented by single-byte or multibyte values depending on the codeset. To make it easier to handle both single-byte and multibyte characters in the same way, the HP C RTL defines a wide-character data type, `wchar_t`. This data type can store characters that are represented by 1-, 2-, 3-, or 4-byte values.

The functions provided to support wide characters are:

- Character classification functions. See Section 10.9.1.
- Case conversion functions. See Section 10.9.2.
- Input and output functions. See Section 10.9.3.
- Multibyte to wide-character conversion functions. See Section 10.9.4.
- Wide-character to multibyte conversion functions. See Section 10.9.4.
- Wide-character string manipulation functions. See Section 10.9.5.
- Wide-character string collation and comparison functions. See Section 10.10.

10.9.1 Character Classification Functions

The `LC_CTYPE` category in a locale classifies the characters in the locale's codeset into different types (alphabetic, numeric, lowercase, uppercase, and so on). There are two sets of functions, one for wide characters and one for single-byte characters, that test whether a character is of a specific type. The `is*` functions test single-byte characters, and the `isw*` functions test wide characters.

For example, the `iswalnum` function tests if a wide character is classed as either alphabetic or numeric. It returns a nonzero value if the character is one of these types. For more information about the classification functions, see Chapter 3 and the Reference Section.

10.9.2 Case Conversion Functions

The `LC_CTYPE` category defines mapping between pairs of characters of the locale. The most common character mapping is between uppercase and lowercase characters. However, a locale can support more than just case mappings.

Two functions are provided to map one character to another according to the information in the `LC_CTYPE` category of the locale:

- `wctrans`—Looks for the named mapping (predefined in the locale) between characters.
- `towctrans`—Maps one character to another according to the named mapping given to the `wctrans` function.

Two functions are provided for character case mapping:

- `towlower`—Maps an uppercase wide character to its lowercase equivalent.
- `towupper`—Maps a lowercase wide character to its uppercase equivalent.

For more information about these functions, see the Reference Section.

10.9.3 Functions for Input and Output of Wide Characters

The set of input and output functions manages wide characters and wide-character strings.

Read Functions

The functions for reading wide characters and wide-character strings are `fgetwc`, `fgetws`, `getwc`, and `getwchar`.

There is also an `ungetwc` function that pushes a wide character back into the input stream.

Write Functions

The functions for writing wide characters and wide-character strings are `fputwc`, `fputws`, `putwc`, and `putwchar`.

Scan Functions

All the scan functions allow for a culture-specific radix character, as defined in the `LC_NUMERIC` category of the current locale.

The `%lc`, `%C`, `%ls`, and `%S` conversion specifiers enable the scan functions `fwscanf`, `wscanf`, `swscanf`, `fscanf`, `scanf`, and `sscanf` to read in wide characters.

Print Functions

All the print functions can format numeric values according to the data in the `LC_NUMERIC` category of the current locale.

The `%lc`, `%C` and `%ls`, `%S` conversion specifiers used with print functions convert wide characters to multibyte characters and print the resulting characters.

See Chapter 2 for details of all input and output functions.

10.9.4 Functions for Converting Multibyte and Wide Characters

Wide characters are used internally by an application to manage single-byte or multibyte characters. However, text files are generally stored in multibyte character format. To process these files, the multibyte characters need converting to wide-character format. This can be achieved using the following functions:

- `mbtowc`, `mbrtowc`, `btowc`—Convert one multibyte character to a wide character.
- `mbsrtowcs`, `mbstowcs`—Convert a multibyte character string to a wide-character string.

Similarly, the following functions convert wide characters into their multibyte equivalent:

- `wrtomb`, `wctomb`, `wctob`—Convert a single wide character to a multibyte character.
- `wcsrtombs`, `wcstombs`—Convert a wide-character string to a multibyte character string.

Associated with these conversion functions, the `mblen` and `mbrlen` functions are used to determine the size of a multibyte character.

Several of the wide-character functions take an argument of type "pointer to `mbstate_t`", where `mbstate_t` is an opaque datatype (like `FILE` or `fpos_t`) intended to keep the conversion state for the state-dependent codesets.

10.9.5 Functions for Manipulating Wide-Character Strings and Arrays

The HP C RTL contains a set of functions (the `wcs*` and `wmem*` functions) that manipulate wide-character strings. For example, the `wscat` function appends a wide-character string to the end of another string in the same way that the `strcat` function works on character strings of type *char*.

See Chapter 3 for details of the string manipulation functions.

10.10 Collating Functions

In an international environment, string comparison functions need to allow for multipass collations. The collation requirements include:

- Ordering accented characters.
- Collating a character sequence as a single character. For example, *ch* in Spanish should be collated after *c* but before *d*.
- Collating a single character as a two-character sequence.
- Ignoring some characters.

Collating information is stored in the `LC_COLLATE` category of a locale. The HP C RTL includes the `strcoll` and `wscoll` functions that use this collating information to compare two strings.

Multipass collations by `strcoll` or `wscoll` can be slower than using the `strcmp` or `wscmp` functions. If your program needs to do many string comparisons using `strcoll` or `wscoll`, it may be quicker to transform the strings once, using the `strxfrm` or `wcsxfrm` function, and then use the `strcmp` or `wscmp` function.

The term *collation* refers to the relative order of characters. The collation order is locale-specific and might ignore some characters. For example, an American dictionary ignores the hyphen in words and lists *take-out* between *takeoff* and *takeover*.

Comparison, on the other hand, refers to the examination of characters for sameness or difference. For example, *takeout* and *take-out* are different words, although they may collate the same.

Suppose an application sorts a list of words so it can later perform a binary search on the list to quickly retrieve a word. Using `strcmp`, *take-in*, *take-out*, and *take-up* would be grouped in one part of the table. Using `strcoll` and a locale that ignores hyphens, *take-out* would be grouped with *takeoff* and *takeover*, and would be considered a duplicate of *takeout*. To avoid a binary search finding *takeout* as a duplicate of *take-out*, an application would most likely use `strcmp` rather than `strcoll` for forming a binary tree.

Date/Time Functions

This chapter describes the date/time functions available with HP C for OpenVMS Systems. For more detailed information on each function, see the Reference Section.

Table 11–1 Date/Time Functions

Function	Description
asctime	Converts a broken-down time from <code>localtime</code> into a 26-character string.
ctime	Converts a time, in seconds, since 00:00:00, January 1, 1970 to an ASCII string of the form generated by the <code>asctime</code> function.
ftime	Returns the elapsed time since 00:00:00, January 1, 1970 in the structure pointed to by its argument.
getclock	Gets the current value of the systemwide clock.
gettimeofday	Gets the date and time.
gmtime	Converts time units to GMT (Greenwich Mean Time).
localtime	Converts a time (expressed as the number of seconds elapsed since 00:00:00, January 1, 1970) into hours, minutes, seconds, and so on.
mktime	Converts a local time structure to a calendar time value.
time	Returns the time elapsed since 00:00:00, January 1, 1970, in seconds.
tzset	Sets and accesses time-zone conversion.

Also, the time-related information returned by `fstat` and `stat` uses the new date/time model described in Section 11.1.

11.1 Date/Time Support Models

Beginning with OpenVMS Version 7.0, the HP C RTL changed its date/time support model from one based on local time to one based on Universal Coordinated Time (UTC). This allows the HP C RTL to implement ANSI C/POSIX functionality that previously could not be implemented. A UTC time-based model also makes the HP C RTL compatible with the behavior of the Tru64 UNIX time functions.

By default, newly compiled programs will generate entry points into UTC-based date/time routines.

For compatibility with OpenVMS systems prior to Version 7.0, previously compiled programs that relink on an OpenVMS Version 7.0 system will retain local-time-based date/time support. Relinking alone will not access UTC support.

Compiling programs with the `_DECC_V4_SOURCE` and `_VMS_V6_SOURCE` feature-test macros defined will also enable local-time-based entry points. That is, the new OpenVMS Version 7.0 date/time functions will not be enabled.

Functions with both UTC-based and local-time-based entry points are:

ctime	mktime
fstat	stat
ftime	strftime
gmtime	time
localtime	wcsftime

Note

Introducing a UTC-based, date/time model implies a certain loss of performance because time-related functions supporting UTC must read and interpret time-zone files instead of doing simple computations in memory as was done for the date/time model based on local time.

To decrease this performance degradation, OpenVMS Version 7.1 and higher can maintain the processwide cache of time-zone files. The size of the cache (that is, the number of files in the memory) is determined by the value of the DECC\$TZ_CACHE_SIZE logical name. The default value is 2.

Because the time-zone files are relatively small (about 3 blocks each), consider defining DECC\$TZ_CACHE_SIZE as the maximum number of time zones used by the application. For example, the default cache size fits an application that does not switch time zones during the run and runs on a system where the TZ environment variable is defined with both Standard and Summer time zone.

11.2 Overview of Date/Time Functions

In the UTC-based model, times are represented as seconds since the Epoch. The Epoch is defined as the time 0 hours, 0 minutes, 0 seconds, January 1, 1970 UTC. Seconds since the Epoch is a value interpreted as the number of seconds between a specified time and the Epoch.

The functions `time` and `ftime` return the time as seconds since the Epoch.

The functions `ctime`, `gmtime`, and `localtime` take as their argument a time value that represents the time in seconds from the Epoch.

The function `mktime` converts a broken-down time, expressed as local time, into a time value in terms of seconds since the Epoch.

The values `st_ctime`, `st_atime`, and `st_mtime` returned in the `stat` structure by the `stat` and `fstat` functions are also in terms of UTC.

Time support new to OpenVMS Version 7.0 includes the functions `tzset`, `gettimeofday`, and `getclock`, and the external variables `tzname`, `timezone`, and `daylight`.

The UTC-based time model enables the HP C RTL to:

- Implement the ANSI C `gmtime` function, which returns a structure in terms of GMT time.
- Specify the ANSI `tm_isdst` field of the `tm` structure, which specifies whether daylight savings time is in effect.

- Provide time-related POSIX and X/Open extensions (such as the `tzset` function (which lets you get time information from any time zone), and the external variables `tzname`, `timezone`, and `daylight`).
- Correctly compute the local time for times in the past, something that the time functions like `localtime` need to do.
- Enable `localtime` and `gmtime`, through the use of feature-test macros (see Section 1.4), to return two additional fields: `tm_zone` (an abbreviation of the time-zone name) and `tm_gmtoff` (the offset from UTC in seconds) in the `tm` structure they return.

11.3 HP C RTL Date/Time Computations—UTC and Local Time

Universal Coordinated Time (UTC) is an international standard for measuring time of day. Under the UTC time standard, zero hour occurs when the Greenwich Meridian is at midnight. UTC has the advantage of always increasing, unlike local time, which can go backwards/forwards depending on daylight saving time.

Also, UTC has two additional components:

- A measure of inaccuracy (optional)
- A time-differential factor, which is an offset applied to UTC to derive local time.

The time-differential factor associates each local time zone with UTC; the time differential factor is applied to UTC to derive local time. (Local times can vary up to -12 hours West of the Greenwich Meridian and +13 hours East of it).

For the HP C RTL time support to work correctly on OpenVMS Version 7.0 and higher, the following must be in place:

- Your OpenVMS system must be correctly configured to use a valid OpenVMS TDF. Make sure this is set correctly by checking the value of the `SYS$TIMEZONE_DIFFERENTIAL` logical. This logical should contain the time difference added to UTC to arrive at your local time.
- Your OpenVMS installation must correctly set the local time zone that describes the location that you want to be your default local time zone. In general, this is the local time zone in which your system is running.

For more information, see the section on setting up your system to compensate for different time zones in your *OpenVMS System Manager's Manual: Essentials*.

The HP C RTL uses local time-zone conversion rules to compute local time from UTC, as follows:

1. The HP C RTL internally computes time in terms of UTC.
2. The HP C RTL then uses time-zone conversion rules to compute a time-differential factor to apply to UTC to derive local time. See the `tzset` function in the Reference Section of this manual for more information on the time-zone conversion rules.

By default, the time-zone conversion rules used for computing local time from UTC are specified in time-zone files defined by the `SYS$LOCALTIME` and `SYS$POSIXRULES` system logicals. These logicals are set during an OpenVMS installation to point to time-zone files that represent the system's best approximation to local wall-clock time:

- `SYS$LOCALTIME` defines the time-zone file containing the default conversion rules used by the HP C RTL to compute local time.
- `SYS$POSIXRULES` defines the time-zone file that specifies the default rules to be applied to POSIX style time zones that do not specify when to change to summer time and back.

`SYS$POSIXRULES` can be the same as `SYS$LOCALTIME`. See the `tzset` function for more information.

11.4 Time-Zone Conversion Rule Files

The time-zone files pointed to by the `SYS$LOCALTIME` and `SYS$POSIXRULES` logicals are part of a public-domain, time-zone support package installed on OpenVMS Version 7.0 and higher systems.

This support package includes a series of source files that describe the time-zone conversion rules for computing local time from UTC in worldwide time zones. OpenVMS Version 7.0 and higher systems provide a time-zone compiler called ZIC. The ZIC compiler compiles time-zone source files into binary files that the HP C RTL reads to acquire time-zone conversion specifications. For more information on the format of these source files, see the OpenVMS system documentation for ZIC.

The time-zone files are organized as follows:

- The root time-zone directory is `SYS$COMMON:[SYS$TIMEZONE.SYSTEM]`. The system logical `SYS$TZDIR` is set during installation to point to this area.
- Time-zone source files are found in `SYS$COMMON:[SYS$TIMEZONE.SYSTEM.SOURCES]`.
- Binary time-zone files use `SYS$COMMON:[SYS$TIMEZONE.SYSTEM]` as their root directory. Some binaries reside in this directory while others reside in its subdirectories.
- Binaries residing in subdirectories are time-zone files that represent specific time zones in a larger geographic area. For example, `SYS$COMMON:[SYS$TIMEZONE.SYSTEM]` contains a subdirectory for the United States and a subdirectory for Canada, because each of these geographic locations contains several time zones. Each time zone in the US is represented by a time-zone file in the Unites States subdirectory. Each time zone in Canada is represented by a time-zone file in the Canada subdirectory.

Several of the time-zone files have names based on acronyms for the areas that they represent. Table 11–2 lists these acronyms.

Table 11–2 Time-zone Filename Acronyms

Time-Zone Acronym	Description
CET	Central European Time
EET	Eastern European Time
Factory	Specifies No Time Zone
GB-Eire	Great Britain/Ireland

(continued on next page)

Table 11–2 (Cont.) Time-zone Filename Acronyms

Time-Zone Acronym	Description
GMT	Greenwich Mean Time
NZ	New Zealand
NZ-CHAT	New Zealand, Chatham Islands
MET	Middle European Time
PRC	Peoples Republic of China
ROC	Republic of China
ROK	Republic of Korea
SystemV	Specific to System V operating system
UCT	Universal Coordinated Time
US	United States
UTC	Universal Coordinated Time
Universal	Universal Coordinated Time
W-SU	Middle European Time
WET	Western European Time

A mechanism is available for you to define and implement your own time-zone rules. For more information, see the OpenVMS system documentation on the ZIC compiler and the description of tzset in the reference section of this manual.

Also, the SYS\$LOCALTIME and SYS\$POSIXRULES system logicals can be redefined to user-supplied time zones.

11.5 Sample Date/Time Scenario

The following example and explanation shows how to use the HP C RTL time functions to print the current time:

```
#include <stdio.h>
#include <time.h>

main ()
{
    time_t t;
    t = time((time_t)0);
    printf ("The current time is: %s\n",asctime (localtime (&t)));
}
```

This example:

1. Calls the time function to get the current time in seconds since the Epoch, in terms of UTC.
2. Passes this value to the localtime function, which uses time-conversion information as specified by tzset to determine which time-zone conversion rules should be used to compute local time from UTC. By default, these rules are specified in the file defined by SYS\$LOCALTIME:
 - a. For a user in the Eastern United States interested in their local time, SYS\$LOCALTIME would be defined during installation to SYS\$COMMON:[SYS\$ZONEINFO.US]EASTERN, the time-zone file containing conversion rules for the Eastern U.S. time zone.

- b. If the local time falls during daylight savings time (DST), `SYS$COMMON:[SYS$ZONEINFO.US]EASTERN` indicates that a time differential factor of `-4` hours needs to be applied to UTC to get local time.

If the local time falls during Eastern standard time (EST), `SYS$COMMON:[SYS$ZONEINFO.US]EASTERN` indicates that a time differential factor of `-5` hours needs to be applied to UTC to get local time.
 - c. The HP C RTL applies `-4` (DST) or `-5` (EST) to UTC, and `localtime` returns the local time in terms of a `tm` structure.
3. Pass this `tm` structure to the `asctime` function to print the local time in a readable format.

Symbolic Links and POSIX Pathname Support

OpenVMS Version 8.3 and higher provides Open Group compliant symbolic link support and POSIX pathname processing support. This support will help partners and customers who port UNIX and LINUX applications to OpenVMS or who use a UNIX style development environment to reduce the application development costs and complexity previously associated with such porting efforts.

The following OpenVMS features are provided to support symbolic links and POSIX pathname processing:

- The Open Group compliant symbolic-link functions `symlink`, `readlink`, `unlink`, `realpath`, `lchown` and `lstat` are added to the C Run-Time Library (C RTL) (see Section 12.3.3).
- Existing C RTL functions such as `creat`, `open`, `delete`, and `remove`, now behave in accordance with Open Group specifications for symbolic links (see Section 12.3.4).
- RMS allows the C RTL to implement the above-mentioned functions. RMS routines such as `SYS$OPEN`, `SYS$CREATE`, `SYS$PARSE`, and `SYS$SEARCH` now support symbolic links (see Section 12.4).
- The contents of symbolic links on OpenVMS are interpreted as POSIX pathnames when encountered during pathwalks and searches. POSIX pathnames are now supported in OpenVMS and are usable through C RTL and RMS interfaces (see Section 12.1.2.)
- A new feature logical `DECC$POSIX_COMPLIANT_PATHNAMES` is added to the C RTL to indicate that an application is operating in a POSIX-compliant mode. In POSIX-compliant mode, only the newest version of a file is visible. Access to multiple versions of a file is not allowed (see Section 12.3.1).
- The DCL command `CREATE/SYMLINK` is used to create a symbolic link. (see Section 12.2.1).
- The DCL command `SET ROOT` is used to create the system POSIX root (see Section 12.5).
- Two GNV utilities, `mnt` and `umnt`, are provided to set mount points (see Section 12.7).
- DCL commands and utilities are modified to behave appropriately when acting on and encountering symbolic links (see Section 12.9).
- The TCP/IP Services for OpenVMS Network File System (NFS) client and server are enhanced to support symbolic links on ODS5 volumes.
- Relevant GNV utilities such as `ln` (which can create a symbolic link) and `ls` (which can display the contents of a symbolic link) are updated to provide access to and management of symbolic links (see Sections 12.2.2 and 12.10).

12.1 POSIX Pathnames and Filenames

A POSIX pathname is a non-empty character string consisting of 0 or more filenames, separated by a / (the path delimiter). The path delimiter can be the first or last character of a pathname and is also the separator between filenames. Multiple consecutive delimiters are valid and are equivalent to a single delimiter.

POSIX filenames can consist of all ASCII characters except / (the path delimiter) and NUL, which is used as a string terminator in many APIs. (On OpenVMS systems, POSIX filenames are also currently restricted to not contain the ? or * character.) A filename is sometimes referred to as a *pathname component*.

12.1.1 POSIX Pathname Interpretation

If the pathname begins with a /, it is considered to be an absolute pathname, and pathname processing begins at the device and directory specified by the POSIX *root* (see Section 12.5 for the method to define the root).

If the pathname does not begin with a /, it is considered to be a relative pathname, and pathname processing begins with the current working directory.

See Section 12.6 for how OpenVMS interprets the current working directory.

12.1.1.1 The POSIX Root Directory

The POSIX *root* directory is a directory that is used in pathname resolution for absolute pathnames.

The root directory, is the top-most node of the hierarchy, and has itself as its parent directory. The pathname of the root directory is /, and the parent directory of the root directory is /. Note that only files and directories actually entered in the root directory are accessible with a POSIX pathname. For additional details, see the note in Section 12.3.1.

See Section 12.5 for defining the POSIX root on OpenVMS.

12.1.1.2 Symbolic Links

A *symbolic link* is a special kind of file that points to another file. It is a directory entry that associates a filename with a text string that is interpreted as a POSIX pathname when accessed by certain services. Most operations that access a symbolic link are rerouted to the object to which the text contents refer; if that object does not exist, the operation fails. A symbolic link is implemented on OpenVMS as a file of organization SPECIAL and type SYMBOLIC_LINK.

A symbolic link can specify an absolute pathname or a relative pathname. The relative path in a symbolic link is relative to the location of the link. For example, a symbolic link whose content begins with the path "." refers to its parent directory. If the symbolic link is moved to another directory, it refers to its new parent directory. Note that the path specified by a symbolic link is a POSIX pathname and is subject to the restrictions described in Section 12.3.1.

See Section 12.2 for symbolic link usage on OpenVMS.

12.1.1.3 Mount Points

A *mount point* is a location (in fact, a directory) where a file system is attached. The UNIX term *file system* is essentially equivalent to the OpenVMS concept of a disk volume. After a mount point is established, any contents of the original directory are inaccessible.

Mount points do not persist across reboots.

See Section 12.7 for establishing mount points on OpenVMS.

12.1.1.4 Reserved Filenames . and ..

There are two reserved POSIX filenames:

- . (the current directory)
- .. (the parent directory)

12.1.1.5 Character Special Files

On UNIX systems, a *special file* is associated with a particular hardware device or other resource of the computer system. The operating system uses character special files, sometimes called device files, to provide I/O access to specific character devices.

Special files, at first glance, appear to be just like ordinary files, in that they:

- Have path names that appear in a directory
- Have the same access protection as ordinary files
- Can be used in almost every way that ordinary files can be used

However, there is an important difference between the two: an ordinary file is a logical grouping of data recorded on disk, whereas a special file corresponds to a device entity. Examples are:

- An actual device, such as a line printer
- A logical subdevice, such as a large section of the disk drive
- A pseudo device, such as the physical memory of the computer (/dev/mem), the terminal file (/dev/tty), or the null file (/dev/null).

Only the null special file (/dev/null) is supported. This file is created during the GNV configuration procedure. Data written on the null special file is discarded. Reads from a null special file always return 0 bytes.

12.1.2 Using POSIX Pathnames with OpenVMS Interfaces

POSIX compliant pathnames can be passed to most OpenVMS applications, utilities, and APIs.

The existing DCL convention of doubling any quote character that is in a quoted string has been adopted.

Also, in order to avoid constraints on future use of quoted strings for pathnames (for example, to support another syntactic variation, such as Windows-compatible names), the leading tag `^UP^` is required on the quoted pathname to identify it as a POSIX pathname to DCL, RMS, and OpenVMS utilities. It is *not* required for the C RTL or GNV.

So, for example, `/a/b/c` becomes `^UP^/a/b/c` and `/a/b"/c` becomes `^UP^/a/b"/c`.

Throughout the remainder of this chapter, the term *POSIX pathname* refers to the unmodified pathname (for example, `/a/b/c`) and *quoted pathname* refers to our quoted, tagged pathname (for example, `^UP^/a/b/c`).

12.1.2.1 Special Considerations with POSIX Filenames

When a user creates a file on OpenVMS using a POSIX filename, it would be ideal if the filename viewed as an OpenVMS filename were the same. For example, when a user asks to create a file with POSIX filename a.b, OpenVMS could create a file with the name a.b; (where ; represents the file version).

But because one of the components of an OpenVMS filename is the file type (consisting of at least a period), POSIX filenames without a period cannot be mapped in as direct a fashion (for example, POSIX filename a cannot be mapped to OpenVMS filename a;). The reasonable solution is for OpenVMS to append a period (representing a null file-type field) so that POSIX filename a becomes OpenVMS filename a.;

Note that OpenVMS appends a period (or null type) even to a POSIX filename that itself ends in a period. This is necessary to distinguish POSIX filenames a. and a from each other.

Furthermore, OpenVMS directories have a type and version of .DIR;1. When a directory of POSIX filename a is created on OpenVMS, it is created with an OpenVMS filename of a.DIR;1. And because a.DIR is a valid POSIX filename, it needs to be distinguished from a directory with POSIX filename a residing in the same directory. So OpenVMS adds a period (or null type) to POSIX filenames ending in .DIR (so a file with POSIX filename a.DIR becomes a.DIR.;).

Keeping the above rules in mind, the following are POSIX filenames that are unmodified on OpenVMS, except for adding a version:

POSIX filename	OpenVMS name	Type	Version	Displayed by DIR as
a.b	a	.b	;	a.b;
a.b;	a	.b;	;	a.b;;
a.b;2	a	.b;2	;	a.b;2;

The following are examples of POSIX filenames that end with a period (.) or .DIR and, therefore, have a period appended when creating the OpenVMS filename:

POSIX filename	OpenVMS name	Type	Version	Displayed by DIR as
a	a	.	;	a.;
a.	a.	.	;	a^. .;
a..	a..	.	;	a^.^. .;
a.b.	a.b.	.	;	a^.b^. .;
a.DIR	a.DIR	.	;	a^.DIR.;

Finally, OpenVMS will add .DIR;1 to the end of any POSIX directory:

POSIX filename	OpenVMS name	Type	Version	Displayed by DIR as
a	a	.DIR	;1	a.DIR;1
a.dir	a.dir	.DIR	;1	a^.dir.DIR;1
a.	a.	.DIR	;1	a^. .DIR;1

Note that both the OpenVMS filenames a.DIR;1 and a.; map to the POSIX filename a . . Specifying the POSIX filename a will find either a.DIR;1 or a.; . If both are present, it finds a.; . The ambiguous mapping applies whether a.DIR;1 is a directory or an ordinary file.

All POSIX filenames that contain the * or ? characters are unmappable. This is an open issue to be addressed in a future release of OpenVMS.

12.1.2.2 Special Considerations with OpenVMS Filenames

When mapping OpenVMS filenames to POSIX filenames (a feature provided by C RTL function `readdir`), the following rules apply:

If the OpenVMS filename ends in `.DIR;1` and the type of a file is a directory, then `.DIR;1` is removed. For all other files, the ending semi-colon and version number are removed from the OpenVMS filename.

If the OpenVMS filename ends in a period, the period is removed.

All OpenVMS filenames that contain the `/` or `NUL` characters are unmappable and, therefore, not returned to the caller.

OpenVMS directories `..DIR;1` and `...DIR;1` are unmappable because their corresponding POSIX filenames would be the special filenames `.` and `..`.

OpenVMS file `.` is unmappable because the resulting POSIX filename would be a `NULL` string.

12.2 Using Symbolic Links

There are several ways to create a symbolic link:

- Using the DCL command `CREATE/SYMLINK` (Section 12.2.1)
- Using the `ln -s` utility within the GNV bash shell (Section 12.2.2)
- Using the C RTL `symlink` function (Section 12.3.3)

12.2.1 Creating and Using Symbolic Links with DCL

The following examples show how to create and access symbolic links using DCL commands:

Examples

```
1. $ create/symlink="a/b.txt" link_to_b.txt
   $
   $ dir/date link_to_b.txt
   Directory DKB0:[TEST]
   link_to_b.txt -> a/b.txt
                        27-MAY-2005 09:45:15.20
```

This example creates the symbolic link file `link_to_b.txt` with contents equal to the specified text string representing the pathname to which the symbolic link points, `a/b.txt`. Note that `a/b.txt` may or may not exist. Also note that the `symlink` file must be reachable from the POSIX root.

```
2. $ type link to b.txt
   %TYPE-W-OPENIN, error opening DKB0:[TEST]LINK_TO_B.TXT; as input
   -RMS-E-FNF, file not found
```

To access the file referenced in a symbolic link, specify the symbolic link name on the command. The `TYPE` command error message in this example indicates that the file `a/b.txt`, referenced through the symbolic link `link_to_b.txt` created in the first example, does not exist.

```

3.  $ create [.a]b.txt
    This is a text file.
    Exit
    $
    $ type link_to_b.txt
    This is a text file
    $

```

This example creates the missing file `b.txt`. Once the referenced file exists, the `TYPE` command through the symbolic link is successful.

Alternatively, you can create the file through the symbolic link:

```

$ create link to b.txt
  This is a text file.
  Exit
$ dir [.a]
Directory DKB0:[TEST.A]
b.txt;1
$
$ type link_to_b.txt
  This is a text file.
$

```

12.2.2 Using Symbolic Links through GNV POSIX and DCL Commands

You can create a symbolic link within the GNV bash shell with the `ln` utility:

```
bash$ ln -s filename slinkname
```

Most utilities and commands that reference *slinkname* are redirected so that they act on *filename*. Some commands, such as `ls`, are symbolic link-aware, and show information about the link itself (such as its contents).

A link can be removed with the `rm` command (which cannot be made to follow the link and remove what it points to).

The examples that follow show how to manage symbolic links through GNV POSIX commands as compared with DCL commands.

Examples

```

1.  From GNV:
    bash$ cd /symlink_example
    bash$ echo This is a test. > text
    bash$ cat text
    This is a test.
    bash$ ln -s text LINKTOTEXT
    bash$

    From DCL:
    $ set def DISK$XALR:[PSX$ROOT.symlink_example]
    $ create text.
    This is a test.
    Exit
    $ type text.
    This is a test.
    $ create/symlink="text" LINKTOTEXT

```

This example creates a symbolic link called `LINKTOTEXT` that points to a text file called `text`.

```
2. From GNV:
    bash$ cat LINKTOTEXT
    This is a test.
    bash$
```

```
From DCL:
    $ type LINKTOTEXT.
    This is a test.
    $
```

This example displays the contents of the text file using the symbolic link.

```
3. From GNV:
    bash$ ls
    LINKTOTEXT text
    bash$ ls -l
    total 1
    lrwxr-x---  1 SYSTEM  1          4 May 12 08:41 LINKTOTEXT -> text
    -rw-r----- 1 SYSTEM  1          16 May 12 08:40 text
    bash$
```

```
From DCL:
    $ DIR
    Directory DISK$XALR:[PSX$ROOT.symlink_example]
    LINKTOTEXT.;1      text.;1
    Total of 2 files.
    $ DIR/DATE
    Directory DISK$XALR:[PSX$ROOT.symlink_example]
    LINKTOTEXT.;1 -> /symlink_example/text
                    12-MAY-2005 08:46:31.40
    text.;1         12-MAY-2005 08:43:47.53
    Total of 2 files.
    $
```

This example displays the content of a symbolic link. Notice that when you do an `ls` or a `DIR` using switches that show any file attribute, then the content of the symbolic link is also displayed.

```
4. From GNV:
    bash$ rm text
    bash$ cat LINKTOTEXT
    cat: linktotext: i/o error
    bash$ rm LINKTOTEXT
```

```
From DCL:
    $ DEL text.;1
    $ TYPE LINKTOTEXT.
    %TYPE-W-OPENIN, error opening
    DISK$XALR:[PSX$ROOT.symlink_example]LINKTOTEXT.;1 as input
    -RMS-E-ACC, ACP file access failed
    -SYSTEM-F-FILNOTACC, file not accessed on channel
    $ DEL LINKTOTEXT.;1
    $
```

This example deletes files.

12.3 C RTL Support

The following sections describe POSIX-compliant pathname and symbolic link support in the C RTL.

12.3.1 DECC\$POSIX_COMPLIANT_PATHNAMES Feature Logical

In order for a POSIX-compliant user to have consistency between the pathnames stored in symbolic links and the pathnames used as input to C RTL functions, the C RTL provides a feature logical, `DECC$POSIX_COMPLIANT_PATHNAMES`, to allow an application to present POSIX-compliant pathnames to any C RTL function that accepts a pathname.

By default `DECC$POSIX_COMPLIANT_PATHNAMES` is disabled, and the usual C RTL behavior prevails. Notice that this disabled mode includes interpretation of pathnames as UNIX style specifications and uses rules that are different and unrelated to POSIX-compliant pathname processing.

To disable `DECC$POSIX_COMPLIANT_PATHNAMES` when necessary, `DEFINE` it to 0 or "DISABLE":

```
$ DEFINE DECC$POSIX_COMPLIANT_PATHNAMES 0
```

To enable `DECC$POSIX_COMPLIANT_PATHNAMES`, set it to one of the following values:

- 1 POSIX only - All pathnames are designated as POSIX style.
- 2 Leans POSIX - Pathnames that end in ":" or contain any of the bracket characters "[]<>", and that can be successfully parsed by the `SYS$FILESCAN` service, are designated as OpenVMS style. Otherwise, they are designated as POSIX style.
- 3 Leans OpenVMS - The pathnames "." and "..", or pathnames that contain "/" are designated as POSIX style. Otherwise, they are designated as OpenVMS style.
- 4 OpenVMS only - All pathnames are designated as OpenVMS style.

Note

Modes 1 and 4 are not recommended because of interactions with other shareable libraries and utilities.

With `DECC$POSIX_COMPLIANT_PATHNAMES` thus enabled, the C RTL examines pathnames to determine if they should be designated as POSIX style or OpenVMS style, following rules determined by the value assigned to `DECC$POSIX_COMPLIANT_PATHNAMES`.

For example, to designate that most pathnames are to be POSIX-compliant:

```
$ DEFINE DECC$POSIX_COMPLIANT_PATHNAMES 2
```

When the C RTL designates a pathname as POSIX style, it does not convert a POSIX pathname it receives into an OpenVMS file specification; instead, it converts the POSIX pathname into the quoted pathname format (previously described) and allows RMS to process the pathname as it would process a pathname found in a symbolic link.

Note

Starting with OpenVMS Version 8.4, logical names and device names *are* supported with DECC\$POSIX_COMPLIANT_PATHNAMES defined, whereas in previous OpenVMS versions they were not supported.

When DECC\$POSIX_COMPLIANT_PATHNAMES is defined, the following C RTL feature logicals are ignored:

```
DECC$ARGV_PARSE_STYLE
DECC$DISABLE_POSIX_ROOT
DECC$DISABLE_TO_VMS_LOGNAME_TRANSLATION
DECC$EFS_CASE_PRESERVE
DECC$EFS_CASE_SPECIAL
DECC$EFS_CHARSET
DECC$EFS_NO_DOTS_IN_DIRNAME
DECC$ENABLE_TO_VMS_LOGNAME_CACHE
DECC$FILENAME_UNIX_NO_VERSION
DECC$FILENAME_UNIX_ONLY
DECC$FILENAME_UNIX_REPORT
DECC$NO_ROOTED_SEARCH_LISTS
DECC$READDIR_DROPDOTNOTYPE
DECC$READDIR_KEEPPDOTDIR
DECC$RENAME_ALLOW_DIR
DECC$RENAME_NO_INHERIT
DECC$UNIX_PATH_BEFORE_LOGNAME
```

12.3.2 decc\$to_vms, decc\$from_vms, and decc\$translate_vms

When operating in POSIX-compliant mode, the C RTL function `decc$to_vms` converts a POSIX pathname into the RMS quoted pathname format. If an RMS quoted pathname is passed to either `decc$from_vms` or `decc$translate_vms`, these functions change the quoted pathname into a POSIX pathname by removing the quotes and the `^UP^` prefix (so, for example, "`^UP^a/b`" becomes `a/b`). When not in POSIX-compliant mode, these functions operate as they did previously.

12.3.3 Symbolic Link Functions

Table 12–1 lists and describes the symbolic-link functions in the HP C Run-Time Library (RTL). For more detailed information on each function, see the Reference Section.

Table 12–1 Symbolic Link Functions

Function	Description
lchown	Changes the owner and/or group of a file. If the file is a symbolic link, the owner of the symbolic link is modified (in contrast to <code>chown</code> which would modify the file that the symbolic link points to).
lstat	Retrieves information about the specified file. If the file is a symbolic link, information about the link itself is returned (in contrast to <code>stat</code> , which would return information about the file that the symbolic link points to).
readlink	Reads the contents of a symbolic link and places them into a user-supplied buffer.
realpath	Returns an absolute pathname from the POSIX root. This function is only supported in POSIX-compliant modes; that is, with <code>DECC\$POSIX_COMPLIANT_PATHNAMES</code> enabled.
unlink	Deletes a symbolic link from the system.
symlink	Creates a symbolic link containing the specified contents.

12.3.4 Modifications to Existing Functions

In addition to the previously described new functions, the following C RTL functions are modified to support symbolic links:

`creat`

When a new version of a file is created, and the named file already exists as a symbolic link, the file to which the symbolic link refers is created.

`open`

If the *file_spec* parameter refers to a symbolic link, the `open` function opens the file pointed to by the symbolic link.

`delete`, `remove`

When `delete` or `remove` is used to delete a symbolic link, the link itself is deleted, not the file to which it refers.

Also, in accordance with the Open Group specification, an `errno` value of `ELOOP` is returned if a loop exists in the resolution of a symbolic link.

12.3.5 Non POSIX-Compliant Behavior

12.3.5.1 Multiple Versions of Files

When using POSIX-compliant pathnames, if multiple versions of a file exist, you can access only the latest version of the file. Deleting a file results in the deletion of only the highest-numbered version of a file.

12.3.5.2 Ambiguous Filenames

If the file "a" and directory "a.DIR;1" both exist in a directory, users in POSIX-compliant mode will have the following access:

- Functions that take only a directory name as input (such as `chdir` and `opendir`) will return an error (ENOEXIST).
- Functions whose input is a non-directory file (such as `open`) will act on the non-directory file.
- Functions whose input can be either a file or a directory (such as `stat`) will act on the non-directory file.
- `readdir` will return entries for both the file and the directory.

12.3.5.3 POSIX Security Behavior for File Deletion

The OpenVMS C RTL library follows traditional OpenVMS security rules for permitting the deletion or unlinking of files and uses the protection on the files or links, whereas the POSIX security behavior for deleting files is to follow the security settings for the parent directory of the files or links.

To get the POSIX security behavior, files in a directory must have an Access Control Entry (ACE) placed on them that always grants delete access to those files by the class of users or programs that you want to have this behavior. You may also want to create a default protection ACE on the parent directory so newly created files get the desired behavior.

Please consult the *HP OpenVMS Guide to System Security* for more information on how to manage Access Control Entries.

12.4 RMS Interface

12.4.1 RMS Input/Output of POSIX Pathnames

As previously described, a quoted pathname is a POSIX pathname prefixed with the tag string `^UP^` and enclosed with opening and closing quotation marks. In addition, any quotation marks present in the POSIX pathname need to be doubled, consistent with the way DCL handles quoted strings.

Quoted pathnames are allowed in the primary name, default name, and/or related names. By identifying the `^UP^` prefix and the opening and closing quotation marks, RMS interprets the rest of the characters as a standard POSIX pathname (with the exception that every pair of quotation marks in the pathname is treated as a single quotation mark). If RMS detects a quoted pathname, then the expanded and resultant file specifications are supplied by RMS as quoted pathnames as well.

The components of the returned quoted pathname are referenced by the NAM or NAML as follows:

- The *node* is NULL
- The *dev* is `^UP^`
- The *dir* consists of all characters between the dev string up to and including the final slash (`/`)
- The *name* consists of all characters following the dir up to the final period (`.`) (If there is no final period, the name consists of all characters following the *dir* up to the closing double quote (`"`))

- The *type* consists of all characters following the *name* up to the closing double quote (")
- The *version* is double quote (")

The *dir*, *name*, and *type* fields can be NUL.

For example, the quoted pathname "^UP^/a/b.c" consists of the following components:

```
The node is NUL
The dev is "^UP^"
The dir is /a/
The name is b
The type is .c
The version is "
```

The following RMS routines support symbolic links:

- SYS\$OPEN operates on the target file pointed to by the symbolic link.
- SYS\$CREATE creates the file pointed to by the symbolic link.
- SYS\$PARSE analyzes the file specification string and fills in various NAM block fields.
- SYS\$SEARCH returns the DVI and FID of the target file. The DID is zero. The resultant name is that of the symbolic link and not the target file.
- Setting NAML\$V_OPEN_SPECIAL causes SYS\$OPEN and SYS\$SEARCH to not follow the symbolic link.

The following restrictions apply to RMS processing of POSIX pathnames:

- If the primary file specification is a quoted pathname, then SYS\$SEARCH returns only one file; in pathnames, no characters are defined as being wildcards.
- If the primary file specification is a quoted pathname, then the default and related specifications are ignored.
- If the primary file specification is a traditional OpenVMS file specification, then the default specification can be a quoted pathname; however, only the filename and type are used from the default specification.

12.4.2 Application Control of RMS Symbolic Link Processing

Applications, including DCL commands and utilities, need the ability to control RMS behavior when RMS encounters symbolic links during typical file operations. Specifically, applications need to be able to specify whether or not a pathname stored in a symbolic link should be included as part of pathname processing and directory searches. Furthermore, applications need to be able to specify different behavior depending on how the symbolic link is encountered.

A NAML\$L_INPUT_FLAGS flag is now provided to allow necessary application flexibility:

- If SYS\$OPEN is supplied a pathname that is a symbolic link, the default behavior is to open the file specified by the pathname stored in the symbolic link. If the flag NAML\$V_OPEN_SPECIAL is set, then the symbolic link file itself is opened.

- If the result of a call to SYS\$SEARCH is a symbolic link and the flag NAML\$V_OPEN_SPECIAL is set, the DVI/FID of the symbolic link itself is returned. Otherwise, the default behavior is that the DVI/FID of the file specified by the pathname stored in the symbolic link is returned, unless that pathname is also a symbolic link, in which case the process is repeated until a non-symbolic link is reached before returning the DVI/FID.
- When SYS\$SEARCH performs wildcard directory lookups, then any symbolic links encountered are not examined to determine if they refer to directories.

Also, on ODS-5 volumes, a SPECIAL_FILES flag is used to communicate to RMS operations whether to follow symbolic links or not. The RMS operations that follow symbolic links are SYS\$OPEN, SYS\$CREATE, SYS\$SEARCH and all directory path interpretations.

For more information on how to set the SPECIAL_FILES flag, see *HP OpenVMS System Services Reference Manual* and *HP OpenVMS DCL Dictionary*.

12.5 Defining the POSIX Root

For absolute POSIX pathnames, RMS needs to interpret the leading '/' as a UNIX-style root. POSIX expects that everything starts from this POSIX root. The POSIX root can be established with the GNV installation procedure or with the new DCL command, SET ROOT.

12.5.1 Suggested Placement of the POSIX Root

During the GNV installation and configuration procedure or when using the SET ROOT command, you need to provide a location for the POSIX root for the system. By default, the GNV installation establishes the location of the root at SYS\$SYSDEVICE:[PSX\$ROOT]. You can accept this directory as the root or specify another directory. GNV then optionally creates a mount point in "/mnt" (which is directory "mnt" in your POSIX root directory) for each disk device on your system.

If you accept the default for the root, or specify any other directory that is not the top-level directory of a device, then files that do not reside in the directory tree under the root directory will be inaccessible using a POSIX pathname, unless the device containing the root directory is mounted by means of a mount point under the root. (This mount point is optionally generated by GNV during the configuration.) See Figure 12–1.

Figure 12–1 POSIX Root Placement

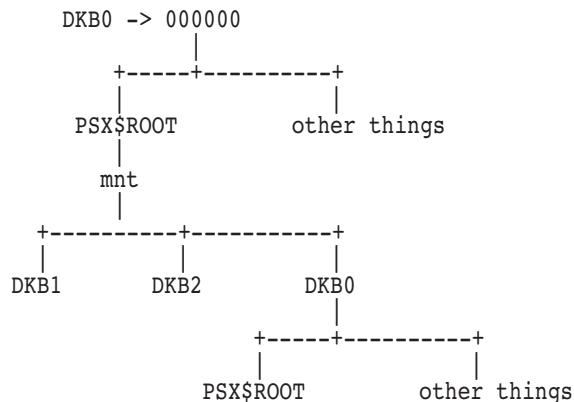

An alternative is to specify the top-level directory, the Master File Directory (MFD), of a device as the root and not create a mount point for that device. This makes all of the files on the device accessible via POSIX pathnames. However, using the MFD of a device (especially the system device) as the root means that all of the files in the MFD are visible when a user displays the files in a root directory (such as "ls /"). GNV users will see OpenVMS files that they might not expect to see; similarly, DCL users will see UNIX files they might not expect to see. Also, the MFD of a device might not be accessible to most general users, resulting in unexpected failures.

We recommend you use the supplied default root directory.

For more information on mount points, see Section 12.7.

12.5.2 The SET ROOT Command

The SET ROOT command has the following format:

```
SET ROOT device-name:directory-spec
```

This command defines the POSIX root. In POSIX pathname processing mode, RMS and the C RTL will treat the leading '/' of a pathname as referring to the defined root. By default, the root is SYS\$SYSDEVICE:[PSX\$ROOT].

The root definition does not persist across a reboot.

The SET ROOT command has the following qualifier:

```
/LOG (default)
```

```
/NOLOG
```

Controls whether the SET ROOT command displays a success indication after the root definition is set.

12.5.3 The SHOW ROOT Command

The SHOW ROOT command displays the current value of the system root and, if defined, the process root.

This command has the following format:

```
SHOW ROOT
```

12.6 Current Working Directory

On UNIX systems, the current working directory is a directory that is used in pathname resolution for pathnames that do not begin with a slash.

If RMS encounters a symbolic link, the directory in which the symbolic link is found is the current working directory for the purposes of pathname resolution.

For the resolution of POSIX pathnames passed directly to RMS, the current working directory is the current OpenVMS default directory for the process. If the OpenVMS default directory is not a single directory (for example, the directory specification includes a search list), then the current working directory is the first directory encountered through the search list.

12.7 Establishing Mount Points

Two new utilities, `mnt` and `umnt` provide a way for a user to mount and dismount file systems from mount points. Only users who have CMKRNL privilege can mount and dismount file systems. These utilities are shipped as part of GNV.

The utilities maintain their own logical name table of mount points, which is used to display currently available mount points upon request.

The interfaces for these utilities are as follows:

`mnt`

List existing mount points.

`mnt file_system mount_point`

Mount file system *file_system* on mount point *mount_point*.

`umnt mount_point`

Unmount the file system mounted on mount point *mount_point*.

`umnt file_system`

Unmount the file system *file_system* from its mount point.

`umnt -A`

Unmount all file systems from their mount points.

Note that both OpenVMS file specifications and POSIX pathnames are allowed for the arguments.

12.8 NFS

In TCP/IP Services for OpenVMS, Version 5.4 and older, there was limited symbolic link support in the NFS client for the purpose of backing up symbolic links from a UNIX server into an OpenVMS saveset and correctly restoring them. The client used an application ACE to flag a file as a symbolic link. In Version 5.5, the client preserves this behavior for an ODS-2 mount. For an ODS-5 mount, it creates a symbolic link when it sees the application ACE. This allows savesets created with older versions of the client to still be restored with newer versions.

12.9 DCL

OpenVMS DCL commands and utilities behave in predictable ways when encountering symbolic links. Usually, the symbolic link is followed; for example, if symbolic link LINKFILE.TXT points to file TEXT.TXT, then entering the command "type LINKFILE.TXT" displays the text contained in TEXT.TXT.

The symbolic link is followed even if the symbolic link itself is not directly specified; for example, if a symbolic link that references a directory is encountered when processing a command such as "dir [...]*.TXT", any files with a type of ".TXT" that exist in the pointed-to directory (and its subdirectories) would be displayed. (Note: For OpenVMS Version 8.3, during directory wildcard operations, symbolic links are not examined to see if they refer to directories.)

There are some cases, however, where the symbolic link should not be followed by default. Also, it is sometimes desirable to give the user the option of whether or not to follow a symbolic link.

The following commands either do not follow the symbolic link by default and/or provide an option whether or not to follow a symbolic link.

BACKUP

When a symbolic link is encountered during a backup operation, the symbolic link itself is copied. This is true for all backup types—physical, image and file.

COPY

/SYMLINK

/NOSYMLINK (default)

If an input file is a symbolic link, the file referred to by the symbolic link is the file that is copied.

The /SYMLINK qualifier indicates that any input symbolic link is copied.

CREATE

/SYMLINK="*text*"

Creates a symbolic link containing the specified text without the enclosing quotation marks.

If the created symbolic link is subsequently encountered during any filename processing, the contents of the symbolic link are read and treated as a POSIX pathname specification.

No previous version of the symbolic link can exist.

DELETE

If an input file specification parameter is a symbolic link, the symbolic link itself is deleted.

DIRECTORY

/SYMLINK (default)

/NOSYMLINK

If an input file specification parameter is a symbolic link, the displayed file attributes are those of the symbolic link itself. If any file attribute is requested, then the contents of the symbolic link are also displayed with an arrow appearing between the filename and the contents (for example, LINK.TXT -> FILE.TXT).

The /NOSYMLINK qualifier indicates that if an input file specification is a symbolic link, then the file attributes of the file to which the symbolic link refers are displayed; the displayed name is still the name of the symbolic link itself.

DUMP

/SYMLINK

/NOSYMLINK (default)

If an input file is a symbolic link, the file referred to by the symbolic link is the file that is dumped.

The /SYMLINK qualifier indicates that any input symbolic link is dumped.

PURGE

If an input file specification is a symbolic link, the symbolic link itself is purged. Because only one version of a symbolic link can exist, this command has no effect on that file.

RENAME

If an input file specification is a symbolic link, the symbolic link itself is renamed.

If the output file specification is a symbolic link, the operation fails.

SET FILE

/SYMLINK

/NOSYMLINK (default)

If an input file is a symbolic link, the file referred to by the symbolic link is the file that is set.

The /SYMLINK qualifier indicates that the symbolic link itself is set.

Notes

- The /EXCLUDE qualifier excludes symbolic links that match the qualifier's file specification of files to be excluded. The filename of a file that is referred to by a symbolic link is not excluded on the basis of its own name.

Example:

If symbolic link LINK.TXT refers to TEXT.TXT in another directory, then:

/EXCLUDE=LINK.TXT would exclude LINK.TXT (and, therefore, TEXT.TXT) from the operation.

`/EXCLUDE=TEXT.TXT` would not exclude `LINK.TXT` or `TEXT.TXT` from the operation.

- Given a symbolic link, `F$FILE_ATTRIBUTES` acts on the file to which the symbolic link refers. A new lexical function, `F$SYMLINK_ATTRIBUTES`, returns information on the symbolic link itself. New lexical function `F$READLINK` returns the text contents of a symbolic link, and `NULL` if the input is not a symbolic link.
 - Some compilers and utilities will accept quoted pathnames as input file specifications and as arguments to qualifiers. These include the C and C++ compilers, `CXXLINK`, the Linker, and the Librarian. Linker option files can also contain quoted pathnames. Note that the `/INCLUDE_DIRECTORY` qualifier for the compilers continues to accept standard POSIX pathnames rather than the quoted pathnames. The Java compiler also continues to accept standard POSIX pathnames. In addition, `SET DEFAULT` accepts quoted pathnames as input.
-

12.10 GNV

GNV is the mechanism by which the Open Group utilities are provided on OpenVMS systems. GNV is an open source project with updates released on the Sourceforge web site. GNV is also available on the OpenVMS Open Source CD.

Because GNV relies on the C RTL for all file access, no modifications are made to GNV for its provided utilities to behave as defined by the Open Group specification for symbolic links. To make use of the new symbolic-link and POSIX pathname support features, users should set the C RTL `DECC$POSIX_COMPLIANT_PATHNAMES` feature logical appropriately, before invoking `BASH`.

12.11 Restrictions

The following are known restrictions with symbolic link support:

- `SET FILE/REMOVE` on a symbolic link silently fails.
When `SET FILE/REMOVE` is executed on a symbolic link, the link is not removed. No error is displayed.
- Coding consideration with RMS and symbolic links:
With the introduction of symbolic links and POSIX pathname processing, the device name that occurs in a file specification may be different from the device on which the file exists. The `NAM$T_DVI` returned by `SYS$PARSE/SYS$SEARCH` properly identifies the device on which the file resides.

Reference Section

This section describes the functions contained in the HP C Run-Time Library (RTL), listed alphabetically.

a64l *(Integrity servers, Alpha)*

Converts a character string to a long integer.

Format

```
#include <stdlib.h>
long a64l (const char *s);
```

Argument**s**

Pointer to the character string that is to be converted to a long integer.

Description

The a64l and l64a functions are used to maintain numbers stored in base-64 ASCII characters as follows:

- a64l converts a character string to a long integer.
- l64a converts a long integer to a character string.

Each character used for storing a long integer represents a numeric value from 0 through 63. Up to six characters can be used to represent a long integer.

The characters are translated as follows:

- A period (.) represents 0.
- A slash (/) represents 1.
- The numbers 0 through 9 represent 2 through 11.
- Uppercase letters A through Z represent 12 through 37.
- Lowercase letters a through z represent 38 through 63.

The a64l function takes a pointer to a base-64 representation, in which the first digit is the least significant, and returns a corresponding long value. If the string pointed to by the s parameter exceeds six characters, a64l uses only the first six characters.

If the first six characters of the string contain a null terminator, a64l uses only characters preceding the null terminator.

The a64l function translates a character string from left to right with the least significant number on the left, decoding each character as a 6-bit base-64 number.

If s is the NULL pointer or if the string pointed to by s was not generated by a previous call to l64a, the behavior of a64l is unspecified.

See also l64a.

Return Values

n

Upon successful completion, the long value resulting from conversion of the input string.

0L

Indicates that the string pointed to by *s* is an empty string.

abort

Sends the signal SIGABRT that terminates execution of the program.

Format

```
#include <stdlib.h>  
void abort (void);
```

abs

abs

Returns the absolute value of an integer.

Format

```
#include <stdlib.h>
int abs (int x);
```

Argument

x
An integer.

Return Value

x The absolute value of the input argument. If the argument is `LONG_MIN`, `abs` returns `LONG_MIN` because `-LONG_MIN` cannot fit in an `int` variable.

access

Checks a file to see whether a specified access mode is allowed.

Note

The access function does not accept network files as arguments.

Format

```
#include <unistd.h>
int access (const char *file_spec, int mode);
```

Arguments

file_spec

A character string that gives an OpenVMS or UNIX style file specification. The usual defaults and logical name translations are applied to the file specification.

mode

Interpreted as shown in Table REF-1.

Table REF-1 Interpretation of the mode Argument

Mode Argument	Access Mode
F_OK	Tests to see if the file exists
X_OK	Execute
W_OK	Write (implies delete access)
R_OK	Read

Combinations of access modes are indicated by ORing the values. For example, to check to see if a file has RWED access mode, invoke access as follows:

```
access (file_spec, R_OK | W_OK | X_OK);
```

Description

The access function checks a file to see whether a specified access mode is allowed. If the DECC\$ACL_ACCESS_CHECK feature logical is enabled, this function checks OpenVMS Access Control Lists (ACLs) as well as the UIC protection.

Return Values

0	Indicates that the access is allowed.
-1	Indicates that the access is not allowed.

access

Example

```
#include <unistd.h>
#include <stdlib.h>
#include <stdio.h>

main()
{
    if (access("sys$login:login.com", F_OK)) {
        perror("ACCESS - FAILED");
        exit(2);
    }
}
```

acos

Returns the arc cosine of its argument.

Format

```
#include <math.h>
double acos (double x);
float acosf (float x); (Integrity servers, Alpha)
long double acosl (long double x); (Integrity servers, Alpha)
double acosd (double x); (Integrity servers, Alpha)
float acosdf (float x); (Integrity servers, Alpha)
long double acosdl (long double x); (Integrity servers, Alpha)
```

Argument

x
A radian expressed as a real value in the domain $[-1,1]$.

Description

The `acos` functions compute the principal value of the arc cosine of x in the range $[0, \pi]$ radians for x in the domain $[-1,1]$.

The `acosd` functions compute the principal value of the arc cosine of x in the range $[0,180]$ degrees for x in the domain $[-1,1]$.

For $\text{abs}(x) > 1$, the value of `acos(x)` is 0, and `errno` is set to `EDOM`.

acosh (*Integrity servers, Alpha*)

acosh (*Integrity servers, Alpha*)

Returns the hyperbolic arc cosine of its argument.

Format

```
#include <math.h>
double acosh (double x);
float acoshf (float x);
long double acoshl (long double x);
```

Argument

x
A radian expressed as a real value in the domain [1, +Infinity].

Description

The acosh functions return the hyperbolic arc cosine of x for x in the domain [1, +Infinity], where $\text{acosh}(x) = \ln(x + \sqrt{x^2 - 1})$.

The acosh function is the inverse function of cosh where $\text{acosh}(\cosh(x)) = |x|$.
 $x < 1$ is an invalid argument.

[w]addch

Add a character to the window at the current position of the cursor.

Format

```
#include <curses.h>
int addch (char ch);
int waddch (WINDOW *win, char ch);
```

Arguments**win**

A pointer to the window.

ch

The character to be added. A new-line character (`\n`) clears the line to the end, and moves the cursor to the next line at the same x coordinate. A return character (`\r`) moves the cursor to the beginning of the line on the window. A tab character (`\t`) moves the cursor to the next tabstop within the window.

Description

When the `waddch` function is used on a subwindow, it writes the character onto the underlying window as well.

The `addch` routine performs the same function as `waddch`, but on the `stdscr` window.

The cursor is moved after the character is written to the screen.

Return Values

OK	Indicates success.
ERR	Indicates that writing the character would cause the screen to scroll illegally. For more information, see the <code>scrollok</code> function.

[w]addstr

[w]addstr

Add the string pointed to by *str* to the window at the current position of the cursor.

Format

```
#include <curses.h>
int addstr (char *str);
int waddstr (WINDOW *win, char *str);
```

Arguments

win

A pointer to the window.

str

A pointer to a character string.

Description

When the `waddstr` function is used on a subwindow, the string is written onto the underlying window as well.

The `addstr` routine performs the same function as `waddstr`, but on the `stdscr` window.

The cursor position changes as a result of calling this routine.

Return Values

OK

Indicates success.

ERR

Indicates that the function causes the screen to scroll illegally, but it places as much of the string onto the window as possible. For more information, see the `scrollok` function.

alarm

Sends the signal SIGALRM (defined in the <signal.h> header file) to the invoking process after the number of seconds indicated by its argument has elapsed.

Format

```
#include <unistd.h>
```

```
unsigned int alarm (unsigned int seconds); (ISO POSIX-1)
```

```
int alarm (unsigned int seconds); (Compatibility)
```

Argument

seconds

Has a maximum limit of LONG_MAX seconds.

Description

Calling the alarm function with a 0 argument cancels any pending alarms.

Unless it is intercepted or ignored, the signal generated by alarm terminates the process. Successive alarm calls reinitialize the alarm clock. Alarms are not stacked.

Because the clock has a 1-second resolution, the signal may occur up to 1 second early. If the SIGALRM signal is intercepted, resumption of execution may be held up due to scheduling delays.

When the SIGALRM signal is generated, a call to SYS\$WAKE is generated whether or not the process is hibernating. The pending wake causes the current pause() to return immediately (after completing any function that catches the SIGALRM).

Return Value

n	The number of seconds remaining from a previous alarm request.
---	--

asctime, asctime_r

asctime, asctime_r

Converts a broken-down time in a `tm` structure into a 26-character string in the following form:

```
Sun Sep 16 01:03:52 1984\n\0
```

All fields have a constant width.

Format

```
#include <time.h>
```

```
char *asctime (const struct tm *timeptr);
```

```
char *asctime_r (const struct tm *timeptr, char *buffer); (ISO POSIX-1)
```

Arguments

timeptr

A pointer to a structure of type `tm`, which contains the broken-down time.

The `tm` structure is defined in the `<time.h>` header file, and also shown in Table REF-4 in the description of `localtime`.

buffer

A pointer to a character array that is at least 26 bytes long. This array is used to store the generated date-and-time string.

Description

The `asctime` and `asctime_r` functions convert the contents of `tm` into a 26-character string and returns a pointer to the string.

The difference between `asctime_r` and `asctime` is that the former puts the result into a user-specified buffer. The latter puts the result into thread-specific static memory allocated by the HP C RTL, which can be overwritten by subsequent calls to `ctime` or `asctime`; you must make a copy if you want to save it.

On success, `asctime` returns a pointer to the string; `asctime_r` returns its second argument. On failure, these functions return the `NULL` pointer.

See the `localtime` function for a list of the members in `tm`.

Note

Generally speaking, UTC-based time functions can affect in-memory time-zone information, which is processwide data. However, if the system time zone remains the same during the execution of the application (which is the common case) and the cache of timezone files is enabled (which is the default), then the `_r` variant of the time functions `asctime_r`, `ctime_r`, `gmtime_r` and `localtime_r`, is both thread-safe and AST-reentrant.

If, however, the system time zone can change during the execution of the application or the cache of timezone files is not enabled, then both variants of the UTC-based time functions belong to the third class of functions, which are neither thread-safe nor AST-reentrant.

Return Values

x	A pointer to the string, if successful.
NULL	Indicates failure.

asin

asin

Returns the arc sine of its argument.

Format

```
#include <math.h>
double asin (double x);
float asinf (float x); (Integrity servers, Alpha)
long double asinl (long double x); (Integrity servers, Alpha)
double asind (double x); (Integrity servers, Alpha)
float asindf (float x); (Integrity servers, Alpha)
long double asindl (long double x); (Integrity servers, Alpha)
```

Argument

x
A radian expressed as a real number in the domain $[-1,1]$.

Description

The asin functions compute the principal value of the arc sine of x in the range $[-\pi/2, \pi/2]$ radians for x in the domain $[-1,1]$.

The asind functions compute the principal value of the arc sine of x in the range $[-90,90]$ degrees for x in the domain $[-1,1]$.

When $\text{abs}(x)$ is greater than 1.0, the value of $\text{asin}(x)$ is 0, and errno is set to EDOM.

asinh (*Integrity servers, Alpha*)

Returns the hyperbolic arc sine of its argument.

Format

```
#include <math.h>
double asinh (double x);
float asinhf (float x);
long double asinhl (long double x);
```

Argument

x
A radian expressed as a real value in the domain $[-\text{Infinity}, +\text{Infinity}]$.

Description

The asinh functions return the hyperbolic arc sine of x for x in the domain $[-\text{Infinity}, +\text{Infinity}]$, where $\text{asinh}(x) = \ln(x + \sqrt{x^2 + 1})$.

The asinh function is the inverse function of sinh where $\text{asinh}(\sinh(x)) = x$.

assert

assert

Used for implementing run-time diagnostics in programs.

Format

```
#include <assert.h>
void assert (int expression);
```

Argument

expression

An expression that has an int type.

Description

When `assert` is executed, if *expression* is false (that is, it evaluates to 0), `assert` writes information about the particular call that failed (including the text of the argument, the name of the source file, and the source line number; the latter two are, respectively, the values of the preprocessing macros `__FILE__` and `__LINE__`) to the standard error file in an implementation-defined format. Then, it calls the `abort` function.

The `assert` function writes a message in the following form:

```
Assertion failed: expression, file aaa, line nnn
```

If *expression* is true (that is, it evaluates to nonzero) or if the signal `SIGABRT` is being ignored, `assert` returns no value.

Note

If a null character (`'\0'`) is part of the expression being asserted, then only the text up to and including the null character is printed, since the null character effectively terminates the string being output.

Compiling with the `CC` command qualifier `/DEFINE=NDEBUG` or with the preprocessor directive `#define NDEBUG` ahead of the `#include assert` statement causes the `assert` function to have no effect.

Example

```
#include <stdio.h>
#include <assert.h>

main()
{
    printf("Only this and the assert\n");
    assert(1 == 2);    /* expression is FALSE */
    /* abort should be called so the printf will not happen. */
    printf("FAIL abort did not execute");
}
```

atan

Format

```
#include <math.h>
double atan (double x);
float atanf (float x); (Integrity servers, Alpha)
long double atanl (long double x); (Integrity servers, Alpha)
double atand (double x); (Integrity servers, Alpha)
float atandf (float x); (Integrity servers, Alpha)
long double atandl (long double x); (Integrity servers, Alpha)
```

Argument

x
A radian expressed as a real number.

Description

The atan functions compute the principal value of the arc tangent of x in the range $[-\pi/2, \pi/2]$ radians.

The atand functions compute the principal value of the arc tangent of x in the range $[-90,90]$ degrees.

atan2

Format

```
#include <math.h>

double atan2 (double y, double x);
float atan2f (float y, float x); (Integrity servers, Alpha)
long double atan2l (long double y, long double x); (Integrity servers, Alpha)
double atand2 (double y, double x); (Integrity servers, Alpha)
float atand2f (float y, float x); (Integrity servers, Alpha)
long double atand2l (long double y, long double x); (Integrity servers, Alpha)
```

Arguments

y

A radian expressed as a real number.

x

A radian expressed as a real number.

Description

The atan2 functions compute the principal value of the arc tangent of y/x in the range $[-\pi, \pi]$ radians. The sign of atan2 and atan2f is determined by the sign of y . The value of atan2(y,x) is computed as follows, where f is the number of fraction bits associated with the data type:

Value of Input Arguments	Angle Returned
$x = 0$ or $y/x > 2^{*(f+1)}$	$\pi/2 * (\text{sign } y)$
$x > 0$ and $y/x \leq 2^{*(f+1)}$	$\text{atan}(y/x)$
$x < 0$ and $y/x \leq 2^{*(f+1)}$	$\pi * (\text{sign } y) + \text{atan}(y/x)$

The atand2 functions compute the principal value of the arc tangent of y/x in the range $[-180,180]$ degrees. The sign of atand2 and atand2f is determined by the sign of y .

The following are invalid arguments for the atan2 and atand2 functions:

Function	Exceptional Argument
atan2, atan2f, atan2l	$x = y = 0$
atan2, atan2f, atan2l	$ x = y = \text{Infinity}$
atand2, atand2f, atand2l	$x = y = 0$
atand2, atand2f, atand2l	$ x = y = \text{Infinity}$

atanh (*Integrity servers, Alpha*)

Returns the hyperbolic arc tangent of its argument.

Format

```
#include <math.h>
double atanh (double x);
float atanhf (float x);
long double atanhl (long double x);
```

Argument

x
A radian expressed as a real value in the domain $[-1,1]$.

Description

The atanh functions return the hyperbolic arc tangent of x . The atanh function is the inverse function of tanh where $\text{atanh}(\tanh(x)) = x$.

$|x| > 1$ is an invalid argument.

atexit

atexit

Registers a function that is called without arguments at program termination.

Format

```
#include <stdlib.h>
int atexit (void (*func) (void));
```

Argument

func
A pointer to the function to be registered.

Return Values

0	Indicates that the registration has succeeded.
nonzero	Indicates failure.

Restriction

The `longjmp` function cannot be executed from within the handler, because the destination address of the `longjmp` no longer exists.

Example

```
#include <stdlib.h>
#include <stdio.h>
static void hw(void);
main()
{
    atexit(hw);
}
static void hw()
{
    puts("Hello, world\n");
}
```

Running this example produces the following output:

```
Hello, world
```

atof

Converts an ASCII character string to a double-precision number.

Format

```
#include <stdlib.h>
double atof (const char *nptr);
```

Argument

nptr

A pointer to the character string to be converted to a double-precision number. The string is interpreted by the same rules that are used to interpret floating constants.

Description

The string to be converted has the following format:

```
[white-spaces][+|-]digits[radix-character][digits][e|E[+|-]integer]
```

Where *radix-character* is defined in the current locale.

The first unrecognized character ends the conversion.

This function is equivalent to `strtod(nptr, (char**) NULL)`.

Return Values

x	The converted value.
0	Indicates an underflow or the conversion could not be performed. The function sets <code>errno</code> to <code>ERANGE</code> or <code>EINVAL</code> , respectively.
\pm HUGE_VAL	Overflow occurred; <code>errno</code> is set to <code>ERANGE</code> .

atoi, atol

atoi, atol

Convert strings of ASCII characters to the appropriate numeric values.

Format

```
#include <stdlib.h>
int atoi (const char *nptr);
long int atol (const char *nptr);
```

Argument

nptr

A pointer to the character string to be converted to a numeric value.

Description

The `atoi` and `atol` functions convert the initial portion of a string to its decimal `int` or `long int` value, respectively. The `atoi` and `atol` functions do not account for overflows resulting from the conversion. The string to be converted has the following format:

```
[white-spaces][+|-]digits
```

The function call `atol (str)` is equivalent to `strtol (str, (char**)NULL, 10)`, and the function call `atoi (str)` is equivalent to `(int) strtol (str, (char**)NULL, 10)`, except, in both cases, for the behavior on error.

Return Value

<code>n</code>	The converted value.
----------------	----------------------

atoq, atoll *(Integrity servers, Alpha)*

Convert strings of ASCII characters to the appropriate numeric values. `atoll` is a synonym for `atoq`.

Format

```
#include <stdlib.h>
__int64 atoq (const char *nptr);
__int64 atoll (const char *nptr);
```

Argument**nptr**

A pointer to the character string to be converted to a numeric value.

Description

The `atoq` (or `atoll`) function converts the initial portion of a string to its decimal `__int64` value. This function does not account for overflows resulting from the conversion. The string to be converted has the following format:

```
[white-spaces][+|-]digits
```

The function call `atoq (str)` is equivalent to `strtoc (str, (char**)NULL, 10)`, except for the behavior on error.

Return Value

n

The converted value.

basename

basename

Returns the last component of a pathname.

Format

```
#include <libgen.h>
char *basename (char *path);
```

Function Variants

The `basename` function has variants named `_basename32` and `_basename64` for use with 32-bit and 64-bit pointer sizes, respectively. See Section 1.9 for more information on using pointer-size-specific functions.

Argument

path

A UNIX style pathname from which the base pathname is extracted.

Description

The `basename` function takes the UNIX style pathname pointed to by *path* and returns a pointer to the pathname's final component, deleting any trailing slash (`/`) characters.

If *path* consists entirely of the slash (`/`) character, the function returns a pointer to the string `"/"`.

If *path* is a NULL pointer or points to an empty string, the function returns a pointer to the string `""`.

The `basename` function can modify the string pointed to by *path*.

Return Values

<code>x</code>	A pointer to the final component of <i>path</i> .
<code>"/"</code>	If <i>path</i> consists entirely of the <code>'/'</code> character.
<code>""</code>	If <i>path</i> is a NULL pointer or points to an empty string.

bcmp

Compares byte strings.

Format

```
#include <strings.h>
void bcmp (const void *string1, const void *string2, size_t length);
```

Arguments

string1, string2

The byte strings to be compared.

length

The length (in bytes) of the strings.

Description

The `bcmp` function compares the byte string in *string1* against the byte string in *string2*.

Unlike the string functions, there is no checking for null bytes. Zero-length strings are always identical.

Note that `bcmp` is equivalent to `memcmp`, which is defined by the ANSI C Standard. Therefore, using `memcmp` is recommended for portable programs.

Return Values

0	The strings are identical.
Nonzero	The strings are not identical.

bcopy

bcopy

Copies byte strings.

Format

```
#include <strings.h>
void bcopy (const void *source, void *destination, size_t length);
```

Arguments

source

Pointer to the source string.

destination

Pointer to the destination string.

length

The length (in bytes) of the string.

Description

The `bcopy` function operates on variable-length strings of bytes. It copies the value of the *length* argument, in bytes, from the string in the *source* argument to the string in the *destination* argument.

Unlike the string functions, there is no checking for null bytes. If the *length* argument is 0 (zero), no bytes are copied.

Note that `bcopy` is equivalent to `memcpy`, which is defined by the ANSI C Standard. Therefore, using `memcpy` is recommended for portable programs.

box

Draws a box around the window using the character *vert* as the character for drawing the vertical lines of the rectangle, and *hor* for drawing the horizontal lines of the rectangle.

Format

```
#include <curses.h>
int box (WINDOW *win, char vert, char hor);
```

Arguments

win
The address of the window.

vert
The character for the vertical edges of the window.

hor
The character for the horizontal edges of the window.

Description

The `box` function copies boxes drawn on subwindows onto the underlying window. Use caution when using functions such as `overlay` and `overwrite` with boxed subwindows. Such functions copy the box onto the underlying window.

Return Values

OK	Indicates success.
ERR	Indicates an error.

brk

brk

Determines the lowest virtual address that is not used with the program.

Format

```
#include <stdlib.h>
void *brk (unsigned long int addr);
```

Argument

addr

The lowest address, which the function rounds up to the next multiple of the page size. This rounded address is called the *break address*.

Description

An address that is greater than or equal to the break address and less than the stack pointer is considered to be outside the program's address space. Attempts to reference it will cause access violations.

When a program is executed, the break address is set to the highest location defined by the program and data storage areas. Consequently, `brk` is needed only by programs that have growing data areas.

Return Values

<code>n</code>	The new break address.
<code>(void *)(-1)</code>	Indicates that the program is requesting too much memory. <code>errno</code> and <code>vaxc\$errno</code> are updated.

Restriction

Unlike other C library implementations, the HP C RTL memory allocation functions (such as `malloc`) do not rely on `brk` or `sbrk` to manage the program heap space. Consequently, on OpenVMS systems, calling `brk` or `sbrk` can interfere with memory allocation routines. The `brk` and `sbrk` functions are provided only for compatibility purposes.

bsearch

Performs a binary search. It searches an array of sorted objects for a specified object.

Format

```
#include <stdlib.h>

void *bsearch (const void *key, const void *base, size_t nmemb, size_t size, int (*compar)
              (const void *, const void *));
```

Function Variants

The `bsearch` function has variants named `_bsearch32` and `_bsearch64` for use with 32-bit and 64-bit pointer sizes, respectively. See Section 1.9 for more information on using pointer-size-specific functions.

Arguments

key

A pointer to the object to be sought in the array. This pointer should be of type pointer-to-object and cast to type pointer-to-void.

base

A pointer to the initial member of the array. This pointer should be of type pointer-to-object and cast to type pointer-to-void.

nmemb

The number of objects in the array.

size

The size of an object, in bytes.

compar

A pointer to the comparison function.

Description

The array must first be sorted in increasing order according to the specified comparison function pointed to by *compar*.

Two arguments are passed to the comparison function pointed to by *compar*. The two arguments point to the objects being compared. Depending on whether the first argument is less than, equal to, or greater than the second argument, the comparison function must return an integer less than, equal to, or greater than 0.

It is not necessary for the comparison function (*compar*) to compare every byte in the array. Therefore, the objects in the array can contain arbitrary data in addition to the data being compared.

Since it is declared as type pointer-to-void, the value returned must be cast or assigned into type pointer-to-object.

bsearch

Return Values

x	A pointer to the matching member of the array or a null pointer if no match is found.
NULL	Indicates that the key cannot be found in the array.

Example

```
#include <stdio.h>
#include <stdlib.h>

#define SSIZE 30

extern int compare(); /* prototype for comparison function */
int array[SSIZE] = {30, 1, 29, 2, 28, 3, 27, 4, 26, 5,
                  24, 6, 23, 7, 22, 8, 21, 9, 20, 10,
                  19, 11, 18, 12, 17, 13, 16, 14, 15, 25};

/* This program takes an unsorted array, sorts it using qsort, */
/* and then calls bsearch for each element in the array,      */
/* making sure that bsearch returns the correct element.      */

main()
{
    int i;
    int failure = FALSE;
    int *rkey;

    qsort(array, SSIZE, sizeof (array[0]), &compare);

    /* search for each element */
    for (i = 0; i < SSIZE - 1; i++) {
        /* search array element i */
        rkey = bsearch((array + i), array, SSIZE,
                      sizeof(array[0]), &compare);
        /* check for successful search */
        if (&array[i] != rkey) {
            printf("Not in array, array element %d\n", i);
            failure = TRUE;
            break;
        }
    }
    if (!failure)
        printf("All elements successfully found!\n");
}

/* Simple comparison routine. */
/* Returns: = 0 if a == b */
/*           < 0 if a < b */
/*           > 0 if a > b */

int compare(int *a, int *b)
{
    return (*a - *b);
}
```

This example program outputs the following:

```
All elements successfully found!
```

btowc

Converts a one-byte multibyte character to a wide character in the initial shift state.

Format

```
#include <wchar.h>
wint_t btowc (int c);
```

Argument

c
The character to be converted to a wide-character representation.

Description

The `btowc` function determines whether `(unsigned char)c` is a valid one-byte multibyte character in the initial shift state, and if so, returns a wide-character representation of that character.

Return Values

x	The wide-character representation of unsigned char <i>c</i> .
WEOF	Indicates an error. The <i>c</i> argument has the value EOF or does not constitute a valid one-byte multibyte character in the initial shift state.

bzero

bzero

Copies null characters into byte strings.

Format

```
#include <strings.h>
void bzero (void *string, size_t length);
```

Arguments

string

Specifies the byte string into which you want to copy null characters.

length

Specifies the length (in bytes) of the string.

Description

The `bzero` function copies null characters (`'\0'`) into the byte string pointed to by *string* for *length* bytes. If *length* is 0 (zero), then no bytes are copied.

cabs

Returns the absolute value of a complex number.

Format

```
#include <math.h>

double cabs (cabs_t z);
float cabsf (cabsf_t z); (Integrity servers, Alpha)
long double cabsl (cabsl_t z); (Integrity servers, Alpha)
```

Argument

z

A structure of type `cabs_t`, `cabsf_t`, or `cabsl_t`. These types are defined in the `<math.h>` header file as follows:

```
typedef struct {double x,y;} cabs_t;
typedef struct { float x, y; } cabsf_t; (Integrity servers, Alpha)
typedef struct { long double x, y; } cabsl_t; (Integrity servers, Alpha)
```

Description

The `cabs` functions return the absolute value of a complex number by computing the Euclidean distance between its two points as the square root of their respective squares:

$$\sqrt{x^2 + y^2}$$

On overflow, the return value is undefined.

The `cabs`, `cabsf`, and `cabsl` functions are equivalent to the `hypot`, `hypotf`, and `hypotl` functions, respectively.

cacos (*Integrity servers, Alpha*)

Returns the complex arc cosine of its argument.

Format

```
#include <complex.h>
double complex cacos (double complex z);
float complex cacosf (float complex z);
long double complex cacosl (long double complex z);
```

Argument

z
A complex value.

Description

The cacos functions compute the complex arc cosine of z , with branch cuts outside the interval $[-1, +1]$ along the real axis.

Return Values

n	The complex arc cosine value, in the range of a strip mathematically unbounded along the imaginary axis and in the interval $[0, \pi]$ along the real axis.
---	---

cacosh (*Integrity servers, Alpha*)

Returns the complex arc hyperbolic cosine of its argument.

Format

```
#include <complex.h>
double complex cacosh (double complex z);
float complex cacoshf (float complex z);
long double complex cacoshl (long double complex z);
```

Argument

z
A complex value.

Description

The `cacosh` functions compute the complex arc hyperbolic cosine of z , with a branch cut at values less than 1 along the real axis.

Return Values

n The complex arc hyperbolic cosine value, in the range of a half-strip of non-negative values along the real axis and in the interval $[-i\pi, +i\pi]$ along the imaginary axis.

calloc

calloc

Allocates an area of zeroed memory. This function is AST-reentrant.

Format

```
#include <stdlib.h>
void *calloc (size_t number, size_t size);
```

Function Variants

The calloc function has variants named `_calloc32` and `_calloc64` for use with 32-bit and 64-bit pointer sizes, respectively. See Section 1.9 for more information on using pointer-size-specific functions.

Arguments

number

The number of items to be allocated.

size

The size of each item.

Description

The calloc function initializes the items to 0. The maximum amount of memory allocated at once is limited to 0xFFFFD000.

See also malloc and realloc.

Return Values

x	The address of the first byte, which is aligned on a quadword boundary (<i>Alpha only</i>) or an octaword boundary (<i>Integrity servers only</i>).
NULL	Indicates an inability to allocate the space.

carg (*Integrity servers, Alpha*)

Returns the phase angle of its complex argument.

Format

```
#include <complex.h>
double carg (double complex z);
float cargf (float complex z);
long double cargl (long double complex z);
```

Argument

z
A complex value.

Description

The `carg` functions compute the argument (also called phase angle) of z , with a branch cut along the negative real axis.

Return Values

n	The value of the argument of z , in the interval $[-\pi, +\pi]$.
---	---

casin (*Integrity servers, Alpha*)

casin (*Integrity servers, Alpha*)

Returns the complex arc sine of its argument.

Format

```
#include <complex.h>
double complex casin (double complex z);
float complex casinf (float complex z);
long double complex casinl (long double complex z);
```

Argument

z
A complex value.

Description

The `casin` functions compute the complex arc sine of z , with branch cuts outside the interval $[-1, +1]$ along the real axis.

Return Values

n	The complex arc sine value, in the range of a strip mathematically unbounded along the imaginary axis and in the interval $[-\pi/2, +\pi/2]$ along the real axis.
---	---

casinh (*Integrity servers, Alpha*)

Returns the complex arc hyperbolic sine of its argument.

Format

```
#include <complex.h>
double complex casinh (double complex z);
float complex casinhf (float complex z);
long double complex casinhl (long double complex z);
```

Argument

z
A complex value.

Description

The `casinh` functions compute the complex arc hyperbolic sine of z , with branch cuts outside the interval $[-i, +i]$ along the imaginary axis.

Return Values

n The complex arc hyperbolic sine value, in the range of a strip mathematically unbounded along the real axis and in the interval $[-i\pi/2, +i\pi/2]$ along the imaginary axis.

catan (*Integrity servers, Alpha*)

catan (*Integrity servers, Alpha*)

Returns the complex arc tangent of its argument.

Format

```
#include <complex.h>
double complex catan (double complex z);
float complex catanf (float complex z);
long double complex catanl (long double complex z);
```

Argument

z
A complex value.

Description

The `catan` functions compute the complex arc tangent of z , with branch cuts outside the interval $[-i, +i]$ along the imaginary axis.

Return Values

n	The complex arc tangent value, in the range of a strip mathematically unbounded along the imaginary axis and in the interval $[-\pi/2, +\pi/2]$ along the real axis.
---	--

catanh *(Integrity servers, Alpha)*

Returns the complex arc hyperbolic tangent of its argument.

Format

```
#include <complex.h>
double complex catanh (double complex z);
float complex catanhf (float complex z);
long double complex catanhl (long double complex z);
```

Argument

z
A complex value.

Description

The `catanh` functions compute the complex arc hyperbolic tangent of z , with branch cuts outside the interval $[-1, +1]$ along the imaginary axis.

Return Values

n The complex arc hyperbolic tangent value, in the range of a strip mathematically unbounded along the real axis and in the interval $[-i\pi/2, +i\pi/2]$ along the imaginary axis.

catclose

catclose

Closes a message catalog.

Format

```
#include <nl_types.h>
int catclose (nl_catd catd);
```

Argument

catd

A message catalog descriptor. This is returned by a successful call to *catopen*.

Description

The *catclose* function closes the message catalog referenced by *catd* and frees the catalog file descriptor.

Return Values

0

Indicates that the catalog was successfully closed.

-1

Indicates that an error occurred. The function sets `errno` to the following value:

- EBADF – The catalog descriptor is not valid.

catgets

Retrieves a message from a message catalog.

Format

```
#include <nl_types.h>
char *catgets (nl_catd catd, int set_id, int msg_id, const char *s);
```

Function Variants

The `catgets` function has variants named `_catgets32` and `_catgets64` for use with 32-bit and 64-bit pointer sizes, respectively. See Section 1.9 for more information on using pointer-size-specific functions.

Arguments

catd

A message catalog descriptor. This is returned by a successful call to `catopen`.

set_id

An integer set identifier.

msg_id

An integer message identifier.

s

A pointer to a default message string that is returned by the function if the message cannot be retrieved.

Description

The `catgets` function retrieves a message identified by `set_id` and `msg_id`, in the message catalog `catd`. The message is stored in a message buffer in the `nl_catd` structure, which is overwritten by subsequent calls to `catgets`. If a message string needs to be preserved, it should be copied to another location by the program.

Return Values

x

Pointer to the retrieved message.

catgets

s

Pointer to the default message string. Indicates that the function is not able to retrieve the requested message from the catalog. This condition can arise if the requested pair (*set_d*, *msg_id*) does not represent an existing message from the open catalog, or it indicates that an error occurred. If an error occurred, the function sets `errno` to one of the following values:

- EBADF – The catalog descriptor is not valid.
- EVMSRR – An OpenVMS I/O read error; the OpenVMS error code can be found in `vaxc$errno`.

Example

```
#include <nl_types.h>
#include <locale.h>
#include <stdarg.h>
#include <stdio.h>
#include <stdlib.h>
#include <unixio.h>

/* This test makes use of all the message catalog routines. catopen */
/* opens the catalog ready for reading, then each of the three */
/* messages in the catalog are extracted in turn using catgets and */
/* printed out. catclose closes the catalog after use. */
/* The catalog source file used to create the catalog is as follows: */
/* $ This is a message file
* $
* $quote "
* $ another comment line
* $set 1
* 1 "First set, first message"
* 2 "second message - This long message uses a backslash \
* for continuation."
* $set 2
* 1 "Second set, first message" */

char *default_msg = "this is the first message.";

main()
{
    nl_catd catalog;
    int msg1,
        msg2,
        retval;

    char *cat = "sys$disk:[]catgets_example.cat"; /*Force local catalog*/
    char *msgtxt;
    char string[128];

    /* Create the message test catalog */
    system("gencat catgets_example.msgx catgets_example.cat") ;
    if ((catalog = catopen(cat, 0)) == (nl_catd) - 1) {
        perror("catopen");
        exit(EXIT_FAILURE);
    }

    msgtxt = catgets(catalog, 1, 1, default_msg);
    printf("%s\n", msgtxt);
}
```

```
msgtxt = catgets(catalog, 1, 2, default_msg);
printf("%s\n", msgtxt);

msgtxt = catgets(catalog, 2, 1, default_msg);
printf("%s\n", msgtxt);

if ((retval = catclose(catalog)) == -1) {
    perror("catclose");
    exit(EXIT_FAILURE);
}

delete("catgets_example.cat;") ; /* Remove the test catalog */
}
```

Running the example program produces the following result:

```
First set, first message
second message - This long message uses a backslash for
                                                         continuation.
Second set, first message
```

catopen

Opens a message catalog.

Format

```
#include <nl_types.h>
nl_catd catopen (const char *name, int oflag);
```

Arguments

name

The name of the message catalog to open.

oflag

An object of type `int` that determines whether the locale set for the `LC_MESSAGES` category in the current program's locale or the logical name `LANG` is used to search for the catalog file.

Description

The `catopen` function opens the message catalog identified by *name*.

If *name* contains a colon (:), a square opening bracket ([), or an angle bracket (<), or is defined as a logical name, then it is assumed that *name* is the complete file specification of the catalog.

If it does not include these characters, `catopen` assumes that *name* is a logical name pointing to an existing catalog file. If *name* is not a logical name, then the logical name `NLSPATH` is used to define the file specification of the message catalog. `NLSPATH` is defined in the user's process. If the `NLSPATH` logical name is not defined, or no message catalog can be opened in any of the components specified by the `NLSPATH`, then the `SYS$NLSPATH` logical name is used to search for a message catalog file.

Both `NLSPATH` and `SYS$NLSPATH` are comma-separated lists of templates. The `catopen` function uses each template to construct a file specification. For example, `NLSPATH` could be defined as:

```
DEFINE NLSPATH SYS$SYSROOT:[SYS$I18N.MSG]%N.CAT,SYS$COMMON:[SYSMSG]%N.CAT
```

In this example, `catopen` first searches the directory `SYS$SYSROOT:[SYS$I18N.MSG]` for the named catalog. If the named catalog is not found there, the directory `SYS$COMMON:[SYSMSG]` is searched. The catalog name is constructed by substituting `%N` with the name passed to `catopen`, and adding the `.cat` suffix. `%N` is known as a substitution field. The following substitution fields are valid:

Field	Meaning
<code>%N</code>	Substitute the <i>name</i> passed to <code>catopen</code>

Field	Meaning
<code>%L</code> ¹	Substitute the locale name. The period (.) and at-sign (@) characters in the locale name are replaced by an underscore (_) character. For example, the "zh_CN.dechanzi@radical" locale name results in a substitution of ZH_CN_DECHANZI_RADICAL.
<code>%l</code> ¹	Substitute the <i>language</i> part of the locale name. For example, the language part of the en_GB.ISO8859-1 locale name is en.
<code>%t</code> ¹	Substitute the <i>territory</i> part of the locale name. For example, the territory part of the en_GB.ISO8859-1 locale is GB.
<code>%c</code> ¹	Substitute the <i>codeset</i> name from the locale name. For example, the codeset name of the en_GB.ISO8859-1 locale name is ISO8859-1.

¹This substitution assumes that the locale name is of the form *language_territory.codeset@mode*

If the *oflag* argument is set to NL_CAT_LOCALE, then the current locale as defined for the LC_MESSAGES category is used to determine the substitution for the `%L`, `%l`, `%t`, and `%c` substitution fields. If the *oflag* argument is set to 0, then the value of the LANG environment variable is used as a locale name to determine the substitution for these fields. Note that using NL_CAT_LOCALE conforms to the XPG4 specification while a value of 0 (zero) exists for the purpose of preserving XPG3 compatibility. Note also, that catopen uses the value of the LANG environment variable without checking whether the program's locale can be set using this value. That is, catopen does not check whether this value can serve as a valid locale argument in the setlocale call.

If the substitution value is not defined, an empty string is substituted.

A leading comma or two adjacent commas (,,) is equivalent to specifying `%N`. For example,

```
DEFINE NLSPATH ",%N.CAT,SYS$COMMON:[SYSMSG,%L]%N.CAT"
```

In this example, catopen searches in the following locations in the order shown:

1. *name* (in the current directory)
2. *name.cat* (in the current directory)
3. SYS\$COMMON:[SYSMSG.*locale_name*]*name.cat*

catopen

Return Values

- | | |
|---------------|--|
| x | A message catalog file descriptor. Indicates the call was successful. This descriptor is used in calls to <code>catgets</code> and <code>catclose</code> . |
| (nl_catd) - 1 | Indicates an error occurred. The function sets <code>errno</code> to one of the following values: <ul style="list-style-type: none">• <code>EACCES</code> – Insufficient privilege or file protection violation, or file currently locked by another user.• <code>EMFILE</code> – Process channel count exceeded.• <code>ENAMETOOLONG</code> – The full file specification for message catalog is too long• <code>ENOENT</code> – Unable to find the requested message catalog.• <code>ENOMEM</code> – Insufficient memory available.• <code>ENOTDIR</code> – Part of the <i>name</i> argument is not a valid directory.• <code>EVMSEERR</code> – An error occurred that does not match any <code>errno</code> value. Check the value of <code>vaxc\$errno</code>. |

cbrt (*Integrity servers, Alpha*)

Returns the rounded cube root of y .

Format

```
#include <math.h>
double cbrt (double y);
float cbrtf (float y);
long double cbrtl (long double y);
```

Argument

y
A real number.

CCOS (*Integrity servers, Alpha*)

Returns the complex cosine of its argument.

Format

```
#include <complex.h>
double complex ccos (double complex z);
float complex ccosf (float complex z);
long double complex ccosl (long double complex z);
```

Argument

z
A complex value.

Description

The `ccos` functions return the complex cosine of *z*.

Return Values

x The complex cosine value.

ceil

ceil

Returns the smallest integer that is greater than or equal to its argument.

Format

```
#include <math.h>
```

```
double ceil (double x);
```

```
float ceilf (float x); (Integrity servers, Alpha)
```

```
long double ceill (long double x); (Integrity servers, Alpha)
```

Argument

x

A real value.

Return Value

n

The smallest integer greater than or equal to the function argument.

cfree

cfree

Makes available for reallocation the area allocated by a previous `calloc`, `malloc`, or `realloc` call. This function is AST-reentrant.

Format

```
#include <stdlib.h>
void cfree (void *ptr);
```

Argument

ptr
The address returned by a previous call to `malloc`, `calloc`, or `realloc`.

Description

The contents of the deallocated area are unchanged.

In HP C for OpenVMS Systems, the `free` and `cfree` functions are equivalent. Some other C implementations use `free` with `malloc` or `realloc`, and `cfree` with `calloc`. However, since the ANSI C standard does not include `cfree`, using `free` may be preferable.

See also `free`.

chdir

Changes the default directory.

Format

```
#include <unistd.h>
int chdir (const char *dir_spec); (ISO POSIX-1)
int chdir (const char *dir_spec, . . . ); (HP C Extension)
```

Arguments

dir_spec

A null-terminated character string naming a directory in either an OpenVMS or UNIX style specification.

. . .

This argument is an HP C extension available when not defining any of the standards-related feature-test macros (see Section 1.4) and not compiling in strict ANSI C mode (*/STANDARD=ANSI89*). The argument is an optional flag of type `int` that is significant only when calling `chdir` from `USER` mode.

If the value of the flag is 1, the new directory is effective across images. If the value is not 1, the original default directory is restored when the image exits.

Description

The `chdir` function changes the default directory. The change can be permanent or temporary. Permanent means that the new directory remains as the default directory after the image exits. Temporary means that on image exit, the default is set to whatever it was before the execution of the image.

There are two ways of making the change permanent:

- Call `chdir` from `USER` mode with the second argument set to 1.
- Call `chdir` from `SUPERVISOR` or `EXECUTIVE` mode, regardless of the value of the second argument.

Otherwise, the change is temporary.

Return Values

0	Indicates that the directory is successfully changed to the given name.
-1	Indicates that the change attempt has failed.

chmod

chmod

Changes the file protection of a file.

Format

```
#include <stat.h>
int chmod (const char *file_spec, mode_t mode);
```

Arguments

file_spec

The name of an OpenVMS or UNIX style file specification.

mode

A file protection. Modes are constructed by performing a bitwise OR on any of the values shown in Table REF-2.

Table REF-2 File Protection Values and Their Meanings

Value	Privilege
0400	OWNER:READ
0200	OWNER:WRITE
0100	OWNER:EXECUTE
0040	GROUP:READ
0020	GROUP:WRITE
0010	GROUP:EXECUTE
0004	WORLD:READ
0002	WORLD:WRITE
0001	WORLD:EXECUTE

When you supply a *mode* value of 0, the chmod function gives the file the user's default file protection.

The system is given the same privileges as the owner. A WRITE privilege also implies a DELETE privilege.

Description

You must have a WRITE privilege for the file specified to change the mode.

The C RTL does not support the S_ISVTX bit. Setting the S_ISVTX mode has no effect.

Return Values

0	Indicates that the mode is successfully changed.
-1	Indicates that the change attempt has failed.

chown

Changes the user ID and group ID of the specified file.

Format

```
#include <unistd.h>
int chown (const char *file_spec, uid_t owner, gid_t group);
```

Arguments

file_spec

The address of an ASCII filename.

owner

The new user ID of the file.

group

The new group ID of the file.

Return Values

0	Indicates success.
-1	Indicates failure.

[w]clear

Erase the contents of the specified window and reset the cursor to coordinates (0,0). The clear function acts on the stdscr window.

Format

```
#include <curses.h>
int clear();
int wclear (WINDOW *win);
```

Argument

win
A pointer to the window.

Return Values

OK	Indicates success.
ERR	Indicates an error.

clearerr

clearerr

Resets the error and end-of-file indicators for a file (so that `ferror` and `feof` will not return a nonzero value).

Format

```
#include <stdio.h>
void clearerr (FILE *file_ptr);
```

Argument

file_ptr
A file pointer.

clearerr_unlocked *(Integrity servers, Alpha)*

Same as the `clearerr` function, except used only within a scope protected by `flockfile` and `funlockfile`.

Format

```
#include <stdio.h>

void clearerr_unlocked (FILE *file_ptr);
```

Argument

file_ptr
A file pointer.

Description

The reentrant version of the `clearerr` function is locked against multiple threads calling it simultaneously. This incurs overhead to ensure integrity of the stream. The unlocked version of this call, `clearerr_unlocked` can be used to avoid the overhead. The `clearerr_unlocked` macro is functionally identical to the `clearerr` macro, except that it is not required to be implemented in a thread-safe manner. The `clearerr_unlocked` function can be safely used only within a scope that is protected by the `flockfile` and `funlockfile` functions used as a pair. The caller must ensure that the stream is locked before `clearerr_unlocked` is used.

See also `flockfile`, `ftrylockfile`, and `funlockfile`.

clearok

clearok

Sets the clear flag for the window.

Format

```
#include <curses.h>
clearok (WINDOW *win, bool boolf);
```

Arguments

win

The entire size of the terminal screen. You can use the windows `stdscr` and `curscr` with `clearok`.

boolf

A Boolean value of `TRUE` or `FALSE`. If the argument is `TRUE`, this forces a clearscreen to be printed on the next call to `refresh`, or stops the screen from being cleared if *boolf* is `FALSE`.

The type `bool` is defined in the `<curses.h>` header file as follows:

```
#define bool int
```

Description

Unlike the `clear` function, the `clearok` function does not alter the contents of the window. If the *win* argument is `curscr`, the next call to `refresh` causes a clearscreen, even if the window passed to `refresh` is not a window the size of the entire terminal screen.

clock

Determines the CPU time (in 10-millisecond units) used since the beginning of the process. The time reported is the sum of the user and system times of the calling process and any terminated child processes for which the calling process has executed `wait` or `system`.

Format

```
#include <time.h>
clock_t clock (void);
```

Description

The value returned by the `clock` function must be divided by the value of the `CLK_TCK`, as defined in the standard header file `<time.h>`, to obtain the time in seconds.

The type `clock_t` is defined in the `<time.h>` header file as follows:

```
typedef long int clock_t;
```

Only the accumulated times for child processes running a C main program or a program that calls `VAXC$CTRL_INIT` or `DECC$CTRL_INIT` are included.

A typical usage of the `clock` function is to call it after a program does its initial setup, and then again after the program executes the code to be timed. Then subtract the two values to give elapsed CPU time.

Return Values

n	The processor time used.
-1	Indicates that the processor time used is not available.

clock_getres *(Integrity servers, Alpha)*

clock_getres *(Integrity servers, Alpha)*

Gets the resolution for the specified clock.

Format

```
#include <time.h>
int clock_getres (clockid_t clock_id, struct timespec *res);
```

Arguments

clock_id

The clock type used to obtain the resolution. The `CLOCK_REALTIME` clock is supported and represents the TIME-OF-DAY clock for the system.

res

A pointer to the `timespec` data structure that receives the value of the clock's resolution.

Description

The `clock_getres` function obtains the resolution value for the specified clock. Clock resolutions are implementation-dependent and cannot be set by a process.

If the `res` argument is not `NULL`, the resolution of the specified clock is stored in the location pointed to by `res`.

If `res` is `NULL`, the clock resolution is not stored.

If the time argument (*tp*) of `clock_gettime` is not a multiple of `res`, then the value is truncated to a multiple of `res`.

On success, the function returns 0.

On failure, the function returns `-1` and sets `errno` to indicate the error.

See also `clock_gettime`, `clock_settime`, `time`, and `ctime`.

Return Values

0	Indicates success.
-1	Indicates failure; <code>errno</code> is set to the following value: <ul style="list-style-type: none">• <code>EINVAL</code> – The <code>clock_id</code> argument does not specify a known clock.

clock_gettime (*Integrity servers, Alpha*)

Returns the current time (in seconds and nanoseconds) for the specified clock.

Format

```
#include <time.h>
int clock_gettime (clockid_t clock_id, struct timespec *tp);
```

Arguments

clock_id

The clock type used to obtain the time for the clock that is set. The CLOCK_REALTIME clock is supported and represents the TIME-OF-DAY clock for the system.

tp

A pointer to a timespec data structure.

Description

The clock_gettime function returns the current *tp* value for the specified clock, *clock_id*.

On success, the function returns 0.

On failure, the function returns -1 and sets errno to indicate the error.

See also clock_getres, clock_gettime, time, and ctime.

Return Values

- | | |
|----|---|
| 0 | Indicates success. |
| -1 | Indicates failure; errno is set to the following value: <ul style="list-style-type: none">• EINVAL – The <i>clock_id</i> argument does not specify a known clock, or the <i>tp</i> argument specifies a nanosecond value less than 0 or greater than or equal to 1 billion. |

clock_gettime *(Integrity servers, Alpha)*

clock_gettime *(Integrity servers, Alpha)*

Sets the specified clock.

Format

```
#include <time.h>
int clock_gettime (clockid_t clock_id, const struct timespec *tp);
```

Arguments

clock_id

The clock type used for the clock that is to be set. The CLOCK_REALTIME clock is supported and represents the TIME-OF-DAY clock for the system.

tp

A pointer to a timespec data structure.

Description

The clock_gettime function sets the specified clock, *clock_id*, to the value specified by *tp*. Time values that are between two consecutive non-negative integer multiples of the resolution of the specified clock are truncated down to the smaller multiple of the resolution.

A clock can be systemwide (that is, visible to all processes) or per-process (measuring time that is meaningful only within a process).

The CLOCK_REALTIME clock, defined in <time.h>, represents the realtime clock for the system. For this clock, the values specified by clock_gettime and returned by clock_gettime represent the amount of time elapsed, in seconds and nanoseconds, since the Epoch. The Epoch is defined as 00:00:00:00 January 1, 1970 Greenwich Mean Time (GMT).

You must have OPER, LOG_IO, and SYSPRV privileges to use the clock_gettime function.

On success, the function returns 0.

On failure, the function returns -1 and sets errno to indicate the error.

See also clock_getres, clock_gettime, time, and ctime.

Return Values

0	Indicates success.
---	--------------------

-1

Indicates failure; `errno` is set to the following value:

- `EINVAL` – The `clock_id` argument does not specify a known clock, or the `tp` argument is outside the range for the given `clock_id` or specifies a nanosecond value less than 0 or greater than or equal to 1 billion.
- `EPERM` – The requesting process does not have the appropriate privilege to set the specified clock.

clog (*Integrity servers, Alpha*)

clog (*Integrity servers, Alpha*)

Returns the complex natural (base e) logarithm of its argument.

Format

```
#include <complex.h>
double complex clog (double complex z);
float complex clogf (float complex z);
long double complex clogl (long double complex z);
```

Argument

z
A complex value.

Description

The clog functions return the complex natural (base e) logarithm of z , with a branch cut along the negative real axis.

Return Values

x	The complex natural logarithm value in the range of a strip mathematically unbounded along the real axis and in the interval $[-i\pi, +i\pi]$ along the imaginary axis.
---	---

close

Closes the file associated with a file descriptor.

Format

```
#include <unistd.h>
int close (int file_desc);
```

Argument

file_desc
A file descriptor.

Description

The close function tries to write buffered data by using an implicit call to fflush. If the write fails (because the disk is full or the user's quota was exceeded, for example), close continues executing. It closes the OpenVMS channel, deallocates any buffers, and releases the memory associated with the file descriptor (or FILE pointer). Any buffered data is lost, and the file descriptor (or FILE pointer) no longer refers to the file.

If your program needs to recover from errors when flushing buffered data, it should make an explicit call to fsync (or fflush) before calling close.

Return Values

0	Indicates that the file is properly closed.
-1	Indicates that the file descriptor is undefined or an error occurred while the file was being closed (for example, if the buffered data cannot be written out).

Example

```
#include <unistd.h>
int fd;
.
.
.
fd = open ("student.dat", 1);
.
.
.
close(fd);
```

closedir

closedir

Closes directories.

Format

```
#include <dirent.h>
int closedir (DIR *dir_pointer);
```

Argument

dir_pointer

Pointer to the `dir` structure of an open directory.

Description

The `closedir` function closes a directory stream and frees the structure associated with the `dir_pointer` argument. Upon return, the value of `dir_pointer` does not necessarily point to an accessible object of the type `DIR`.

The type `DIR`, which is defined in the `<dirent.h>` header file, represents a directory stream that is an ordered sequence of all the directory entries in a particular directory. Directory entries represent files. You can remove files from or add files to a directory asynchronously to the operation of the `readdir` function.

Note

An open directory must always be closed with the `closedir` function to ensure that the next attempt to open the directory is successful.

Example

The following example shows how to search a directory for the entry name, using the `opendir`, `readdir`, and `closedir` functions:

```
#include <dirent.h>
#include <stdio.h>
#include <stdlib.h>
#include <string.h>

#define FOUND 1
#define NOT_FOUND 0

static int dir_example(const char *name, unsigned int unix_style)
{
    DIR *dir_pointer;
    struct dirent *dp;

    if ( unix_style )
        dir_pointer = opendir(".");
    else
        dir_pointer = opendir(getenv("PATH"));

    if ( !dir_pointer ) {
        perror("opendir");
        return NOT_FOUND;
    }
}
```



```

/* Note, that if opendir() was called with UNIX style file */
/* spec like ".", readdir() will return only a single */
/* version of each file in the directory. In this case the */
/* name returned in d name member of the dirent structure */
/* will contain only file name and file extension fields, */
/* both lowercased like "foo.bar". */

/* If opendir() was called with OpenVMS style file spec, */
/* readdir() will return every version of each file in the */
/* directory. In this case the name returned in d name */
/* member of the dirent structure will contain file name, */
/* file extension and file version fields. All in upper */
/* case, like "FOO.BAR;1". */

for ( dp = readdir(dir_pointer);
      dp && strcmp(dp->d_name, name);
      dp = readdir(dir_pointer) )
    ;

closedir(dir_pointer);

if ( dp != NULL )
    return FOUND;
else
    return NOT_FOUND;
}

int main(void)
{
    char *filename = "foo.bar";
    FILE *fp;

    remove(filename);

    if ( !(fp = fopen(filename, "w")) ) {
        perror("fopen");
        return (EXIT_FAILURE);
    }

    if ( dir_example( "FOO.BAR;1", 0 ) == FOUND )
        puts("OpenVMS style: found");
    else
        puts("OpenVMS style: not found");

    if ( dir_example( "foo.bar", 1 ) == FOUND )
        puts("UNIX style: found");
    else
        puts("UNIX style: not found");

    fclose(fp);
    remove(filename);
    return( EXIT_SUCCESS );
}

```

Return Values

0	Indicates success.
-1	Indicates an error and is further specified in the global errno.

[w]clrattr

[w]clrattr

Deactivate the video display attribute *attr* within the window. The `clrattr` function acts on the `stdscr` window.

Format

```
#include <curses.h>
int clrattr (int attr);
int wclrattr (WINDOW *win, int attr);
```

Arguments

win

A pointer to the window.

attr

Video display attributes that can be blinking, boldface, reverse video, and underlining; they are represented by the defined constants `_BLINK`, `_BOLD`, `_REVERSE`, and `_UNDERLINE`. To clear multiple attributes, separate them with a bitwise OR operator (`|`) as follows:

```
clrattr(_BLINK | _UNDERLINE);
```

Description

These functions are specific to HP C for OpenVMS Systems and are not portable.

Return Values

OK	Indicates success.
ERR	Indicates an error.

[w]clrtoobot

Erase the contents of the window from the current position of the cursor to the bottom of the window. The `clrtoobot` function acts on the `stdscr` window.

Format

```
#include <curses.h>
int clrtoobot();
int wclrtoobot (WINDOW *win);
```

Argument

win
A pointer to the window.

Return Values

OK	Indicates success.
ERR	Indicates an error.

[w]clrtoeol

[w]clrtoeol

Erase the contents of the window from the current cursor position to the end of the line on the specified window. The `clrtoeol` function acts on the `stdscr` window.

Format

```
#include <curses.h>
int clrtoeol();
int wclrtoeol (WINDOW *win);
```

Argument

win
A pointer to the window.

Return Values

OK	Indicates success.
ERR	Indicates an error.

confstr

Determines the current value of a specified system variable defined by a string value.

Format

```
#include <unistd.h>

size_t confstr (int name, char *buf, size_t len);
```

Arguments

name

The system variable setting. Valid values for the *name* argument are the `_CS_X` names defined in the `<unistd.h>` header file.

buf

Pointer to the buffer where the `confstr` function copies the *name* value.

len

The size of the buffer storing the *name* value.

Description

The `confstr` function allows an application to determine the current setting of certain system parameters, limits, or options that are defined by a string value. The function is mainly used by applications to find the system default value for the `PATH` environment variable.

If the following conditions are true, then the `confstr` function copies that value into a *len*-byte buffer pointed to by *buf*:

- The *len* argument can be 0 (zero).
- The *name* argument has a system-defined value.
- The *buf* argument is not a NULL pointer.

If the returned string is longer than *len* bytes, including the terminating null, then the `confstr` function truncates the string to *len* - 1 bytes and adds a terminating null to the result. The application can detect that the string was truncated by comparing the value returned by the `confstr` function with the value of the *len* argument.

The `<limits.h>` header file contains system-defined limits. The `<unistd.h>` header file contains system-defined environmental variables.

Also, `confstr` supports the following three HP-UX symbolic constants, which are added to header file `<unistd.h>`:

- `_CS_MACHINE_IDENT`
- `_CS_PARTITION_IDENT`
- `_CS_MACHINE_SERIAL`

confstr

Example

To find out how big a buffer is needed to store the string value of *name*, enter:

```
confstr(_CS_PATH, NULL, (size_t) 0)
```

The `confstr` function returns the size of the buffer necessary.

Return Values

0	Indicates an error. When the specified <i>name</i> value: <ul style="list-style-type: none">• Is invalid, <code>errno</code> is set to <code>EINVAL</code>.• Does not have a system-defined value, <code>errno</code> is not set.
n	The size of the buffer needed to hold the value. <ul style="list-style-type: none">• When the value of the <i>name</i> argument is system-defined, <code>confstr</code> returns the size of the buffer needed to hold the entire value. If this return value is greater than the <i>len</i> value, the string returned as the <i>buf</i> value is truncated.• When the value of the <i>len</i> argument is set to 0 or the <i>buf</i> value is <code>NULL</code>, <code>confstr</code> returns the size of the buffer needed to hold the entire system-defined value. The string value is not copied.

conj (*Integrity servers, Alpha*)

Returns the complex conjugate of its argument.

Format

```
#include <complex.h>
double complex conj (double complex z);
float complex conjf (float complex z);
long double complex conjl (long double complex z);
```

Argument

z
A complex value.

Description

The conj functions return the complex conjugate of z , by reversing the sign of its imaginary part.

Return Values

x The complex conjugate value.

copysign (*Integrity servers, Alpha*)

copysign (*Integrity servers, Alpha*)

Returns x with the same sign as y .

Format

```
#include <math.h>
```

```
double copysign (double x, double y);
```

```
float copysignf (float x, float y); (Integrity servers, Alpha)
```

```
long double copysignl (long double x, long double y); (Integrity servers, Alpha)
```

Arguments

x

A real value.

y

A real value.

Description

The copysign functions return x with the same sign as y . IEEE 754 requires `copysign(x,NaN)`, `copysignf(x,NaN)`, and `copysignl(x,NaN)` to return $+x$ or $-x$.

Return Value

x

The value of x with the same sign as y .

COS

Returns the cosine of its radian argument.

Format

```
#include <math.h>
double cos (double x);
float cosf (float x); (Integrity servers, Alpha)
long double cosl (long double x); (Integrity servers, Alpha)
double cosd (double x); (Integrity servers, Alpha)
float cosdf (float x); (Integrity servers, Alpha)
long double cosdl (long double x); (Integrity servers, Alpha)
```

Argument

x
A radian expressed as a real value.

Description

The cos functions return the cosine of their argument, measured in radians.

The cosd functions return the cosine of their argument, measured in degrees.

$|x| = \text{Infinity}$ is an invalid argument.

Return Values

x	The cosine of the argument.
HUGE_VAL	Indicates that the argument is too large; errno is set to ERANGE.

cosh

cosh

Returns the hyperbolic cosine of its radian argument.

Format

```
#include <math.h>
double cosh (double x);
float coshf (float x); (Integrity servers, Alpha)
long double coshl (long double x); (Integrity servers, Alpha)
```

Argument

x
A radian expressed as a real number.

Description

The cosh functions return the hyperbolic cosine of x and are defined as $(e^{**x} + e^{**(-x)})/2$.

Return Values

x	The hyperbolic cosine of the argument.
HUGE_VAL	Indicates that the argument is too large; errno is set to ERANGE.

cot

Returns the cotangent of its radian argument.

Format

```
#include <math.h>
double cot (double x);
float cotf (float x); (Integrity servers, Alpha)
long double cotl (long double x); (Integrity servers, Alpha)
double cotd (double x); (Integrity servers, Alpha)
float cotdf (float x); (Integrity servers, Alpha)
long double cotdl (long double x); (Integrity servers, Alpha)
```

Argument

x
A radian expressed as a real number.

Description

The cot functions return the cotangent of their argument, measured in radians.
The cotd functions return the cotangent of their argument, measured in degrees.
 $x = 0$ is an invalid argument.

Return Values

x	The cotangent of the argument.
HUGE_VAL	Indicates that the argument is zero; errno is set to ERANGE.

cpow (*Integrity servers, Alpha*)

cpow (*Integrity servers, Alpha*)

Returns the complex power function $x^{**}y$.

Format

```
#include <complex.h>
```

```
double complex cpow (double complex x, double complex y);
```

```
float complex cpowf (float complex x, float complex y);
```

```
long double complex cpowl (long double complex x, long double complex y);
```

Argument

x

A complex value.

y

A complex value.

Description

The cpow functions return the complex power function $x^{**}y$, with a branch cut for the first parameter along the negative real axis.

Return Values

x

The complex power function value.

cproj *(Integrity servers, Alpha)*

Returns a projection of its argument onto the Riemann sphere.

Format

```
#include <complex.h>
double complex cproj (double complex z);
float complex cprojf (float complex z);
long double complex cprojl (long double complex z);
```

Argument

z
A complex value.

Description

The `cproj` functions compute and return a projection of z onto the Riemann sphere: z projects to z , except that all complex infinities (even those with one infinite part and one NaN part) project to positive infinity on the real axis. If z has an infinite part, then `cproj(z)` is equivalent to:

```
INFINITY + I * copysign(0.0, cimag(z))
```

Return Values

x	The value of the projection onto the Riemann sphere.
---	--

creal (*Integrity servers, Alpha*)

creal (*Integrity servers, Alpha*)

Returns the real part of its complex argument.

Format

```
#include <complex.h>
double creal (double complex z);
float crealf (float complex z);
long double creall (long double complex z);
```

Argument

z
A complex value.

Description

The `creal` functions return the real part of z .

Return Values

x The real part value.

creat

Creates a new file.

Format

```
#include <fcntl.h>
```

```
int creat (const char *file_spec, mode_t mode); (ISO POSIX-1)
```

```
int creat (const char *file_spec, mode_t mode, ... ); (HP C Extension)
```

Arguments

file_spec

A null-terminated string containing any valid file specification.

mode

An unsigned value that specifies the file-protection mode. The compiler performs a bitwise AND operation on the mode and the complement of the current protection mode.

You can construct modes by using the bitwise OR operator (|) to create mode combinations. The modes are:

0400	OWNER:READ
0200	OWNER:WRITE
0100	OWNER:EXECUTE
0040	GROUP:READ
0020	GROUP:WRITE
0010	GROUP:EXECUTE
0004	WORLD:READ
0002	WORLD:WRITE
0001	WORLD:EXECUTE

The system is given the same privileges as the owner. A WRITE privilege implies a DELETE privilege.

Note

To create files with OpenVMS RMS default protections using the UNIX system-call functions `umask`, `mkdir`, `creat`, and `open`, call `mkdir`, `creat`, and `open` with a file-protection mode argument of `0777` in a program that never specifically calls `umask`. These default protections include correctly establishing protections based on ACLs, previous versions of files, and so on.

In programs that do `vfork/exec` calls, the new process image inherits whether `umask` has ever been called or not from the calling process image. The `umask` setting and whether the `umask` function has ever been called are both inherited attributes.

creat

...

An optional argument list of character strings of the following form:

```
"keyword = value", ... , "keyword = value"
```

Or in the case of "acc" or "err", this form:

```
"keyword"
```

Here, *keyword* is an RMS field in the file access block (FAB) or record access block (RAB); *value* is valid for assignment to that field. Some fields permit you to specify more than one value. In these cases, the values are separated by commas.

The RMS callback keywords "acc" and "err" are the only keywords that do not take values. Instead, they are followed by a pointer to the callback routine to be used, followed by a pointer to a user-specified value to be used as the first argument of the callback routine. For example, to set up an access callback routine called `acc_callback` whose first argument is a pointer to the integer variable `first_arg` in a call to `open`, you can use the following statement:

```
open("file.dat", O_RDONLY, 0, "acc", acc_callback, &first_arg)
```

The second and third arguments to the callback routine must be pointers to a FAB and RAB, respectively, and the routine must have a return type of `int`. If the callback returns a value less than 0, the `open`, `creat`, or `fopen` fails. The error callback can correct the error condition and return a status greater than or equal to 0 to continue the `creat` call. Assuming the previous `open` statement, the function prototype for `acc_callback` would be similar to the following statement:

```
#include <rms.h>
```

```
int acc_callback(int *first_arg, struct FAB *fab, struct RAB *rab);
```

FAB and RAB are defined in the `<rms.h>` header file, and the actual pointers passed to the routine are pointers to the RAB and FAB being used to open the file `file.dat`.

If an access callback routine is established, then it will be called in the `open`-type routine immediately before the call to the RMS function `sys$create` or `sys$open`. If an error callback routine is established and an error status is returned from the `sys$create` or `sys$open` function, then the callback routine will be invoked immediately after the status is checked and the error value is discovered.

Note

Any manipulation of the RAB or FAB in a callback function could lead to serious problems in later calls to the HP C RTL I/O functions.

Table REF-3 describes the RMS keywords and values.

Table REF-3 RMS Valid Keywords and Values

Keyword	Value	Description
"acc"	callback	Access callback routine.
"alq = n"	decimal	Allocation quantity.

(continued on next page)

Table REF-3 (Cont.) RMS Valid Keywords and Values

Keyword	Value	Description
"bls = n"	decimal	Block size.
"ctx = bin"	string	No translation of '\n' to the terminal. Use this for writing binary data to files.
"ctx = cvt"	string	Negates a previous setting of "ctx=nocvt". This is the default.
"ctx = nocvt"	string	No conversion of Fortran carriage-control bytes.
"ctx = rec"	string	Forces record mode access.
"ctx = stm"	string	Forces stream mode access.
"ctx = xplct"	string	Causes records to be written only when explicitly specified by a call to fflush, close, or fclose.
"deq = n"	decimal	Default extension quantity.
"dna = filespec"	string	Default file-name string.
"err"	callback	Error callback routine.
"fop = val, val , . . . "		File-processing options:
	ctg	Contiguous.
	cbt	Contiguous-best-try.
	dfw	Deferred write; only applicable to files opened for shared access.
	dlt	Delete file on close.
	tef	Truncate at end-of-file.
	cif	Create if nonexistent.
	sup	Supersede.
	scf	Submit as command file on close.
	spl	Spool to system printer on close.
	tmd	Temporary delete.
	tmp	Temporary (no file directory).
	nef	Not end-of-file.
	rck	Read check compare operation.
	wck	Write check compare operation.
	mxv	Maximize version number.
	rwo	Rewind file on open.
	pos	Current position.
	rwc	Rewind file on close.
	sqo	File can only be processed in a sequential manner.
"fsz = n"	decimal	Fixed header size.
"gbc = n"	decimal	The requested number of global buffers for a file.
"mbc = n"	decimal	Multiblock count.
"mbf = n"	decimal	Multibuffer count.
"mrs = n"	decimal	Maximum record size.

(continued on next page)

Table REF-3 (Cont.) RMS Valid Keywords and Values

Keyword	Value	Description
"pmt=usr-prmpt"	string	Prompts for terminal input. Any RMS input from a terminal device will be preceded by "usr-prmpt" when this option and "rop=pmt" are specified.
"rat = val, val . . . "		Record attributes:
	cr	Carriage-return control.
	blk	Disallow records to span block boundaries.
	ftn	Fortran print control.
	none	Explicitly forces no carriage control.
	prn	Print file format.
"rfm = val"		Record format:
	fix	Fixed-length record format.
	stm	RMS stream record format.
	stmlf	Stream format with line-feed terminator.
	stmcr	Stream format with carriage-return terminator.
	var	Variable-length record format.
	vfc	Variable-length record with fixed control.
	udf	Undefined.
"rop = val, val . . . "		Record-processing operations:
	asy	Asynchronous I/O.
	cco	Cancels Ctrl/O (used with Terminal I/O).
	cvt	Capitalizes characters on a read from the terminal.
	eof	Positions the record stream to the end-of-file for the connect operation only.
	nlk	Do not lock record.
	pmt	Enables use of the prompt specified by "pmt=usr-prmpt" on input from the terminal.
	pta	Eliminates any information in the type-ahead buffer on a read from the terminal.
	rea	Locks record for a read operation for this process, while allowing other accessors to read the record.
	rlk	Locks record for write.
	rne	Suppresses echoing of input data on the screen as it is entered on the keyboard.
	rnf	Indicates that Ctrl/U, Ctrl/R, and DELETE are not to be considered control commands on terminal input, but are to be passed to the application program.
	rrl	Reads regardless of lock.

(continued on next page)

Table REF-3 (Cont.) RMS Valid Keywords and Values

Keyword	Value	Description
	syncsts	Returns a success status of RMS\$_SYNCH if the requested service completes its task immediately.
	tmo	Timeout I/O.
	tpt	Allows put/write services using sequential record access mode to occur at any point in the file, truncating the file at that point.
	ulk	Prohibits RMS from automatically unlocking records.
	wat	Wait until record is available, if currently locked by another stream.
	rah	Read ahead.
	wbh	Write behind.
"rtv=n"	decimal	The number of retrieval pointers that RMS has to maintain in memory (0 to 127,255).
"shr = val, val, . . . "		File sharing options:
	del	Allows users to delete.
	get	Allows users to read.
	mse	Allows multistream connects.
	nil	Prohibits file sharing.
	put	Allows users to write.
	upd	Allows users to update.
	upi	Allows one or more writers.
	nql	No query locking (file level).
"tmo = n"	decimal	I/O timeout value.

In addition to these options, any option that takes a key value (such as "fop" or "rat") can be negated by prefixing the value with "no". For example, specify "fop=notmp" to clear the "tmp" bit in the "fop" field.

Notes

- While these options provide much flexibility and functionality, many of them can also cause severe problems if not used correctly.
 - You cannot share the default HP C for OpenVMS stream file I/O. If you wish to share files, you must specify "ctx=rec" to force record access mode. You must also specify the appropriate "shr" options depending on the type of access you want.
 - If you intend to share a file opened for append, you must specify appropriate share and record-locking options, to allow other accessors to read the record. The reason for doing this: the file is positioned at the end-of-file by reading records in a loop until end-of-file is reached.
-

For more information on these options, see the *OpenVMS Record Management Services Reference Manual*.

creat

Description

The HP C RTL opens the new file for reading and writing, and returns the corresponding file descriptor.

If the file exists:

- A version number one greater than any existing version is assigned to the newly created file.
- By default, the new file inherits certain attributes from the existing version of the file unless those attributes are specified in the `creat` call. The following attributes are inherited:
 - Record format (FAB\$B_RFM)
 - Maximum record size (FAB\$W_MRS)
 - Carriage control (FAB\$B_RAT)
 - File protection
- When a new version of a file is created, and the named file already exists as a symbolic link, the file to which the symbolic link refers is created.

If the file did not previously exist:

- It is given the file protection that results from performing a bitwise AND on the *mode* argument and the complement of the current protection mask.
- It defaults to stream format with line-feed record separator and implied carriage-return attributes.

See also `open`, `close`, `read`, `write`, and `lseek` in this section.

Return Values

n	A file descriptor.
-1	Indicates errors, including protection violations, undefined directories, and conflicting file attributes.

[no]crmode

In the UNIX system environment, the `crmode` and `nocrmode` functions set and unset the terminal from cbreak mode. In cbreak mode, a single input character can be processed without pressing Return. This mode of single-character input is only supported with the Curses input routine `getch`.

Format

```
#include <curses.h>

crmode()

nocrmode()
```

Example

```
/* Program to demonstrate the use of crmod() and curses */
#include <curses.h>
main()
{
    WINDOW *win1;
    char vert = '.',
        hor = '.',
        str[80];

    /* Initialize standard screen, turn echo off. */
    initscr();
    noecho();

    /* Define a user window. */
    win1 = newwin(22, 78, 1, 1);

    /* Turn on reverse video and draw a box on border. */
    setattr(_REVERSE);
    box(stdscr, vert, hor);
    mvwaddstr(win1, 2, 2, "Test cbreak input");
    refresh();
    wrefresh(win1);

    /* Set cbreak, do some input, and output it. */
    crmode();
    getch();
    nocrmode(); /* Turn off cbreak. */
    mvwaddstr(win1, 5, 5, str);
    mvwaddstr(win1, 7, 7, "Type something to clear the screen");
    wrefresh(win1);

    /* Get another character, then delete the window. */
    getch();
    wclear(win1);
    touchwin(stdscr);
    endwin();
}
```

In this example, the first call to `getch` returns as soon as one character is entered, because `crmode` was called before `getch` was called. The second time `getch` is called, it waits until the Return key is pressed before processing the character entered, because `nocrmode` was called before `getch` was called the second time.

crypt

crypt

The password encryption function.

Format

```
#include <unistd.h>
#include <stdlib.h>
char *crypt (const char *key, const char *salt);
```

Function Variants

The `crypt` function has variants named `_crypt32` and `_crypt64` for use with 32-bit and 64-bit pointer sizes, respectively. See Section 1.9 for more information on using pointer-size-specific functions.

Argument

key

A user's typed password.

salt

A 2-character string.

Description

The `crypt` function generates an encoded version of a password. It is based on the NBS Data Encryption Standard, with variations intended to frustrate use of hardware implementations of the DES for key search.

The first argument to `crypt` is normally a user's typed password. The second is a 2-character string chosen from the set `[a-zA-Z0-9./]`. The *salt* string is used to perturb the DES algorithm in one of 4096 different ways, after which the password is used as the key to encrypt repeatedly a constant string. The returned value points to the encrypted password, in the same alphabet as the salt. The first two characters are the salt itself.

The return value from `crypt` points to a static data area whose content is overwritten by each call.

See also `encrypt` and `setkey`.

Return Value

pointer	Pointer to the encrypted password.
---------	------------------------------------

csinh (*Integrity servers, Alpha*)

csinh (*Integrity servers, Alpha*)

Returns the complex hyperbolic sine of its argument.

Format

```
#include <complex.h>
double complex csinh (double complex z);
float complex csinhf (float complex z);
long double complex csinhl (long double complex z);
```

Argument

z
A complex value.

Description

The `csinh` functions compute the complex hyperbolic sine of z .

Return Values

x The complex hyperbolic sine value.

ctermid

ctermid

Returns a character string giving the equivalence string of `SYS$COMMAND`. This is the name of the controlling terminal.

Format

```
#include <stdio.h>
char *ctermid (char *str);
```

Function Variants

The `ctermid` function has variants named `_ctermid32` and `_ctermid64` for use with 32-bit and 64-bit pointer sizes, respectively. See Section 1.9 for more information on using pointer-size-specific functions.

Argument

str

Must be a pointer to an array of characters. If this argument is `NULL`, the filename is stored internally and might be overwritten by the next `ctermid` call. Otherwise, the filename is stored beginning at the location indicated by the argument. The argument must point to a storage area of length `L_ctermid` (defined by the `<stdio.h>` header file).

Return Value

pointer	Points to a character string.
---------	-------------------------------

ctime, ctime_r

Converts a time in seconds, since 00:00:00 January 1, 1970, to an ASCII string in the form generated by the `asctime` function.

Format

```
#include <time.h>

char *ctime (const time_t *bintim);

char *ctime_r (const time_t *bintim, char *buffer); (ISO POSIX-1)
```

Function Variants

Compiling with the `_DECC_V4_SOURCE` and `_VMS_V6_SOURCE` feature-test macros defined enables a local-time-based entry point to this function that is equivalent to the behavior before OpenVMS Version 7.0.

Arguments

bintim

A pointer to a variable that specifies the time value (in seconds) to be converted.

buffer

A pointer to a character array that is at least 26 bytes long. This array is used to store the generated date-and-time string.

Description

The `ctime` and `ctime_r` functions convert the time pointed to by `bintim` into a 26-character string, and return a pointer to the string.

The difference between the `ctime_r` and `ctime` functions is that the former puts its result into a user-specified buffer. The latter puts its result into thread-specific static memory allocated by the HP C RTL, which can be overwritten by subsequent calls to `ctime` or `asctime`; you must make a copy if you want to save it.

On success, `ctime` returns a pointer to the string; `ctime_r` returns its second argument. On failure, these functions return the NULL pointer.

The type `time_t` is defined in the `<time.h>` header file as follows:

```
typedef long int time_t
```

The `ctime` function behaves as if it called `tzset`.

Note

Generally speaking, UTC-based time functions can affect in-memory time-zone information, which is processwide data. However, if the system time zone remains the same during the execution of the application (which is the common case) and the cache of timezone files is enabled (which is the default), then the `_r` variant of the time functions `asctime_r`, `ctime_r`, `gmtime_r`, and `localtime_r`, is both thread-safe and AST-reentrant.

If, however, the system time zone can change during the execution of the application or the cache of timezone files is not enabled, then both

ctime, ctime_r

variants of the UTC-based time functions belong to the third class of functions, which are neither thread-safe nor AST-reentrant.

Return Values

x	A pointer to the 26-character ASCII string, if successful.
NULL	Indicates failure.

cuserid

Returns a pointer to a character string containing the name of the user initiating the current process.

Format

```
#include <unistd.h> (X/Open, POSIX-1)
```

```
#include <stdio.h> (X/Open)
```

```
char *cuserid (char *str);
```

Function Variants

The `cuserid` function has variants named `_cuserid32` and `_cuserid64` for use with 32-bit and 64-bit pointer sizes, respectively. See Section 1.9 for more information on using pointer-size-specific functions.

Argument

str

If this argument is `NULL`, the user name is stored internally. If the argument is not `NULL`, it points to a storage area of length `L_cuserid` (defined by the `<stdio.h>` header file), and the name is written into that storage. If the user name is a null string, the function returns `NULL`.

Return Values

pointer	Points to a string.
<code>NULL</code>	If the user name is a null string.

DECC\$CRTL_INIT

DECC\$CRTL_INIT

Allows you to call the HP C RTL from other languages or to use the HP C RTL when your main function is not in C. It initializes the run-time environment and establishes both an exit and condition handler. VAXC\$CRTL_INIT is a synonym for DECC\$CRTL_INIT. Either name invokes the same routine.

Format

```
#include <signal.h>
void DECC$CRTL_INIT(void);
```

Description

The following example shows a Pascal program that calls the HP C RTL using the DECC\$CRTL_INIT function:

```
$ PASCAL EXAMPLE1
$ LINK EXAMPLE1
$ TY EXAMPLE1.PAS
PROGRAM TESTC(input, output);
PROCEDURE DECC$CRTL_INIT; extern;
BEGIN
    DECC$CRTL_INIT;
END
```

A shareable image need only call this function if it contains an HP C function for signal handling, environment variables, I/O, exit handling, a default file protection mask, or if it is a child process that should inherit context.

Although many of the initialization activities are performed only once, DECC\$CRTL_INIT can safely be called multiple times.

At least one frame in the current call stack must have that handler established for OpenVMS exceptions to get mapped to UNIX signals.

decc\$feature_get

Calls `decc$feature_get_value` with a character-string feature name, rather than an index.

Format

```
#include <unixlib.h>

int decc$feature_get (const char *name, int mode);
```

Argument

name

Pointer to a character string passed as a name in the list of supported features.

mode

An integer indicating which feature value to return. The values for mode are:

<code>__FEATURE_MODE_DEFVAL</code>	Default value
<code>__FEATURE_MODE_CURVAL</code>	Current value
<code>__FEATURE_MODE_MINVAL</code>	Minimum value
<code>__FEATURE_MODE_MAXVAL</code>	Maximum value
<code>__FEATURE_MODE_INIT_STATE</code>	Initialization state

Description

The `decc$feature_get` function allows you to call the `decc$feature_get_value` function with a character-string feature name, rather than an index into an internal C RTL table.

On error, `-1` is returned and `errno` is set to indicate the error.

See also `decc$feature_get_value`, `decc$feature_get_index`, `decc$feature_get_name`, `decc$feature_set`, `decc$feature_set_value`, `decc$feature_show`, and `decc$feature_show_all`.

Return Values

<code>n</code>	An integer corresponding to the specified <i>name</i> and <i>mode</i> arguments.
<code>-1</code>	Indicates an error; <code>errno</code> is set.

decc\$feature_get_index

decc\$feature_get_index

Returns an index for accessing feature values.

Format

```
#include <unixlib.h>
int decc$feature_get_index (char *name);
```

Argument

name

Pointer to a character string passed as a name in the list of supported features.

Description

The `decc$feature_get_index` function looks up the string passed as *name* in the list of supported features. If the name is found, `decc$feature_get_index` returns a (nonnegative) index that can be used to set or retrieve the values for the feature. The comparison for *name* is case insensitive.

On error, `-1` is returned and `errno` is set to indicate the error.

See also `decc$feature_get`, `decc$feature_get_value`, `decc$feature_get_name`, `decc$feature_set`, `decc$feature_set_value`, `decc$feature_show`, and `decc$feature_show_all`.

Return Values

n	A nonnegative index that can be used to set or retrieve the specified values for the feature.
-1	Indicates an error; <code>errno</code> is set.

decc\$feature_get_name

Returns a feature name.

Format

```
#include <unixlib.h>
char *decc$feature_get_name (int index);
```

Argument

index

An integer value from 0 to the highest allocated feature.

Description

The `decc$feature_get_name` function returns a pointer to a null-terminated string containing the name of the feature for the entry specified by *index*. The *index* value can be 0 to the highest allocated feature. If there is no feature corresponding to the *index* value, then the function returns a NULL pointer.

On error, NULL is returned and `errno` is set to indicate the error.

See also `decc$feature_get`, `decc$feature_get_index`, `decc$feature_get_value`, `decc$feature_set`, `decc$feature_set_value`, `decc$feature_show`, and `decc$feature_show_all`.

Return Values

x	Pointer to a null-terminated string containing the name of the feature for the entry specified by <i>index</i> .
NULL	Indicates an error; <code>errno</code> is set.

decc\$feature_get_value

decc\$feature_get_value

Returns a feature value specified by the *index* and *mode* arguments.

Format

```
#include <unixlib.h>
int decc$feature_get_value (int index, int mode);
```

Arguments

index

An integer value from 0 to the highest allocated feature.

mode

An integer indicating which feature value to return. The values for mode are:

<code>__FEATURE_MODE_DEFVAL</code>	Default value
<code>__FEATURE_MODE_CURVAL</code>	Current value
<code>__FEATURE_MODE_MINVAL</code>	Minimum value
<code>__FEATURE_MODE_MAXVAL</code>	Maximum value
<code>__FEATURE_MODE_INIT_STATE</code>	Initialization state

Description

The `decc$feature_get_value` function retrieves a value for the feature specified by *index*. The *mode* determines which value is returned.

The default value is what is used if not set by a logical name or overridden by a call to `decc$feature_set_value`.

If *mode* = 4, then the initialization state is returned. Values for the initialization state are:

0	not initialized
1	set by logical name
2	forced by <code>decc\$feature_set_value</code>
-1	initialized to default value

On error, -1 is returned and `errno` is set to indicate the error.

See also `decc$feature_get`, `decc$feature_get_index`, `decc$feature_get_name`, `decc$feature_set`, `decc$feature_set_value`, `decc$feature_show`, and `decc$feature_show_all`.

Return Values

<code>n</code>	An integer corresponding to the specified <i>index</i> and <i>mode</i> arguments.
-1	Indicates an error; <code>errno</code> is set.

decc\$feature_set

Calls `decc$feature_set_value` with a character-string feature name, rather than an index.

Format

```
#include <unixlib.h>

int decc$feature_set (const char *name, int mode, int value);
```

Argument

name

Pointer to a character string passed as a name in the list of supported features.

mode

An integer indicating which feature value to return. The values for mode are:

<code>__FEATURE_MODE_DEFVAL</code>	Default value
<code>__FEATURE_MODE_CURVAL</code>	Current value
<code>__FEATURE_MODE_MINVAL</code>	Minimum value
<code>__FEATURE_MODE_MAXVAL</code>	Maximum value
<code>__FEATURE_MODE_INIT_STATE</code>	Initialization state

value

The feature value to be set.

Description

The `decc$feature_set` function allows you to call the `decc$feature_set_value` function with a character-string feature name, rather than an index into an internal C RTL table.

If successful, the function returns the previous value.

On error, `-1` is returned and `errno` is set to indicate the error.

See also `decc$feature_set_value`, `decc$feature_get`, `decc$feature_get_index`, `decc$feature_get_name`, `decc$feature_get_value`, `decc$feature_show`, and `decc$feature_show_all`.

Return Values

<code>n</code>	The previous feature value.
<code>-1</code>	Indicates an error; <code>errno</code> is set.

decc\$feature_set_value

decc\$feature_set_value

Sets the default value or the current value for the feature specified by *index*.

Format

```
#include <unixlib.h>
int decc$feature_set_value (int index, int mode, int value);
```

Arguments

index

An integer value from 0 to the highest allocated feature.

mode

An integer indicating whether to set the default or current feature value. The values for mode are:

- 0 default value
- 1 current value

value

The feature value to be set.

Description

The `decc$feature_set_value` function sets the default value or the current value (as determined by the *mode* argument) for the feature specified by *index*.

If this function is successful, it returns the previous value.

On error, `-1` is returned and `errno` is set to indicate the error.

See also `decc$feature_get`, `decc$feature_get_index`, `decc$feature_get_name`, `decc$feature_get_value`, `decc$feature_set`, `decc$feature_show`, and `decc$feature_show_all`.

Return Values

- | | |
|----|--|
| n | The previous feature value. |
| -1 | Indicates an error; <code>errno</code> is set. |

decc\$feature_show

Displays all feature values for the specified feature name.

Format

```
#include <unixlib.h>
int decc$feature_show (const char *name);
```

Argument

name

Pointer to a character string passed as a name in the list of supported features.

Description

The `decc$feature_show` function displays to `stdout` all values for the specified feature *name*. For example:

```
----- C RTL Feature Name -----   Cur  Def  Min  Max  Ini
DECC$V62_RECORD_GENERATION           0    0    0    1   -1
```

On error, `-1` is returned and `errno` is set to indicate the error.

See also `decc$feature_get`, `decc$feature_get_index`, `decc$feature_get_name`, `decc$feature_get_value`, `decc$feature_set`, `decc$feature_set_value`, and `decc$feature_show_all`.

Return Values

0	Indicates success.
-1	Indicates an error; <code>errno</code> is set.

decc\$feature_show_all

decc\$feature_show_all

Displays all feature values for all feature names.

Format

```
#include <unixlib.h>
int decc$feature_show_all (void);
```

Description

The `decc$feature_show_all` function displays to `stdout` all values for all feature names.

On error, `-1` is returned and `errno` is set to indicate the error.

See also `decc$feature_get`, `decc$feature_get_index`, `decc$feature_get_name`, `decc$feature_get_value`, `decc$feature_set`, `decc$feature_set_value`, and `decc$feature_show`.

Return Values

0	Indicates success.
-1	Indicates an error; <code>errno</code> is set.

decc\$fix_time

Converts OpenVMS binary system times to UNIX binary times.

Format

```
#include <unixlib.h>
unsigned int decc$fix_time (void *vms_time);
```

Argument

vms_time

The address of a quadword containing an OpenVMS binary time:

```
unsigned int quadword[2];
unsigned int *vms_time = quadword;
```

Description

The `decc$fix_time` routine converts an OpenVMS binary system time (a 64-bit quadword containing the number of 100-nanosecond ticks since 00:00 November 17, 1858) to a UNIX binary time (a longword containing the number of seconds since 00:00 January 1, 1970). This routine is useful for converting binary times returned by OpenVMS system services and RMS services to the format used by some HP C RTL routines, such as `ctime` and `localtime`.

Return Values

x	A longword containing the number of seconds since 00:00 January 1, 1970.
(unsigned int)(-1)	Indicates an error. Be aware, that a return value of (unsigned int)(-1) can also represent a valid date of Sun Feb 7 06:28:15 2106.

Example

```
#include <unixlib.h>
#include <stdio.h>
#include <starlet.h> /* OpenVMS specific SYS$ routines) */

main()
{
  unsigned int current_vms_time[2]; /*quadword for OpenVMS time*/
  unsigned int number_of_seconds; /* number of seconds */

  /* first get the current system time */
  sys$gettim(&current_vms_time[0]);

  /* fix the time */
  number_of_seconds = decc$fix_time(&current_vms_time[0]);

  printf("Number of seconds since 00:00 January 1, 1970 = %d",
        number_of_seconds);
}
```

This example shows how to use the `decc$fix_time` routine in HP C. It also shows the use of the `SYS$GETTIM` system service.

```
/* print the name on each line */
print_name(char *name)
{
    printf("\n%s", name);
    /* will continue as long as success status is returned */
    return (1);
}
```

This example shows how to use the `decc$from_vms` routine in HP C. It produces a simple form of the `ls` command that lists existing files that match an OpenVMS file specification supplied on the command line. The matching files are displayed in UNIX style file specification format.

decc\$match_wild

decc\$match_wild

Matches a string to a pattern.

Format

```
#include <unixlib.h>
int decc$match_wild (char *test_string, char *string_pattern);
```

Arguments

test_string

The address of a null-terminated string.

string_pattern

The address of a string containing the pattern to be matched. This pattern can contain wildcards (such as asterisks (*), question marks (?), and percent signs (%)) as well as regular expressions (such as the range [a-z]).

Description

The `decc$match_wild` routine determines whether the specified test string is a member of the set of strings specified by the pattern.

Return Values

1 (TRUE)	The string matches the pattern.
0 (FALSE)	The string does not match the pattern.

Example

```
/* Define as a foreign command and then provide */
/* two arguments: test_string, string_pattern. */
#include <unixlib.h>
#include <stdio.h>
int main(int argc, char *argv[])
{
    if (decc$match_wild(argv[1], argv[2]))
        printf("\n%s matches %s", argv[1], argv[2]);
    else
        printf("\n%s does not match %s", argv[1], argv[2]);
}
```

decc\$record_read

Reads a record from a file.

Format

```
#include <stdio.h>
int decc$record_read (FILE *fp, void *buffer, int nbytes);
```

Arguments

fp

A file pointer. The specified file pointer must refer to a file currently opened for reading.

buffer

The address of contiguous storage in which the input data is placed.

nbytes

The maximum number of bytes involved in the read operation.

Description

The `decc$record_read` function is specific to OpenVMS systems and should not be used when writing portable applications.

This function is equivalent to the `read` function, except that the first argument is a file pointer, not a file descriptor.

Return Values

x	The number of characters read.
-1	Indicates a read error, including physical input errors, illegal buffer addresses, protection violations, undefined file descriptors, and so forth.

decc\$record_write

decc\$record_write

Writes a record to a file.

Format

```
#include <stdio.h>
int decc$record_write (FILE *fp, void *buffer, int nbytes);
```

Arguments

fp

A file pointer. The specified file pointer must refer to a file currently opened for writing or updating.

buffer

The address of contiguous storage from which the output data is taken.

nbytes

The maximum number of bytes involved in the write operation.

Description

The `decc$record_write` function is specific to OpenVMS systems and should not be used when writing portable applications.

This function is equivalent to the `write` function, except that the first argument is a file pointer, not a file descriptor.

Return Values

x	The number of bytes written.
-1	Indicates errors, including undefined file descriptors, illegal buffer addresses, and physical I/O errors.

decc\$set_child_default_dir (*Integrity servers, Alpha*)

Sets the default directory for a child process spawned by a function from the exec family of functions.

Format

```
#include <unixlib.h>

int decc$set_child_default_dir (const char *default_dir);
```

Arguments

default_dir

The default directory specification for child processes, or NULL.

Description

By default, child processes created by one of the exec family of functions inherit the default (working) directory of their parent process.

The `decc$set_child_default_dir` function lets you set the default directory for a child process. After calling `decc$set_child_default_dir`, newly spawned child processes have their default directory set to *default_dir* as they begin execution. The *default_dir* argument must represent a valid directory specification, or results of the call are unpredictable (subsequent calls to the child process might fail without notification). Both OpenVMS and UNIX style file specifications are supported for this function call.

You can reestablish the default behavior by specifying *default_dir* as NULL. Subsequently, newly created child processes will inherit their parent's working directory.

Return Values

- | | |
|----|---|
| 0 | Successful completion. The new inherited default directory was established. |
| -1 | Indicates failure. No new default directory was established for child processes. The function sets <code>errno</code> to one of the following values: <ul style="list-style-type: none">• ENOMEM – Insufficient memory• ENAMETOOLONG – <i>default_dir</i> is too long to issue the required SET DEFAULT command. |

decc\$set_child_standard_streams

decc\$set_child_standard_streams

For a child spawned by a function from the exec family of functions, associates specified file descriptors with a child's standard streams: stdin, stdout, and stderr.

Format

```
#include <unixlib.h>
```

```
int decc$set_child_standard_streams (int fd1, int fd2, int fd3);
```

Arguments

fd1

The file associated with this file descriptor in the parent process is associated with file descriptor number 0 (stdin) in the child process. If -1 is specified, the file associated with the parent's file descriptor number 0 is used (the default).

fd2

The file associated with this file descriptor in the parent process is associated with file descriptor number 1 (stdout) in the child process. If -1 is specified, the file associated with the parent's file descriptor number 1 is used (the default).

fd3

The file associated with this file descriptor in the parent process is associated with file descriptor number 2 (stderr) in the child process. If -1 is specified, the file associated with the parent's file descriptor number 2 is used (the default).

Description

The `decc$set_child_standard_streams` function allows mapping of specified file descriptors to the child's stdin/stdout/stderr streams, thereby compensating, to a certain degree, the lack of a real fork function on OpenVMS systems.

On UNIX systems, the code between fork and exec is executed in the context of the child process:

```
parent:
  create pipes p1, p2 and p3
  fork
child:
  map stdin to p1 like dup2(p1, stdin);
  map stdout to p2 like dup2(p2, stdout);
  map stderr to p3 like dup2(p3, stderr);

  exec (child reads from stdin and writes to stdout and stderr)
  exit
parent:
  communicates with the child using pipes
```

On OpenVMS systems, the same task could be achieved as follows:

decc\$set_child_standard_streams

```
parent:
  create pipes p1, p2 and p3
  decc$set_child_standard_streams(p1, p2, p3);
  vfork
  exec (child reads from stdin and writes to stdout and stderr)
parent:
  communicates with the child using pipes
```

Once established through the call to `decc$set_child_standard_streams`, the mapping of the child's standard streams remains in effect until explicitly disabled by one of the following calls:

```
decc$set_child_standard_streams(-1, -1, -1);
```

Or:

```
decc$set_child_standard_streams(0, 1, 2);
```

Usually, the child process inherits all its parent's open file descriptors. However, if file descriptor number *n* was specified in the call to `decc$set_child_standard_streams`, it is not inherited by the child process as file descriptor number *n*; instead, it becomes one of the child's standard streams.

Notes

- Standard streams can be redirected only to pipes.
- If the parent process redefines the DCL DEFINE command, this redefinition is not in effect in a subprocess with user-defined channels. The subprocess always sees the standard DCL DEFINE command.
- It is the responsibility of the parent process to consume all the output written by the child process to `stdout` and `stderr`. Depending on how the subprocess writes to `stdout` and `stderr`—in `wait` or `nowait` mode—the subprocess might be placed in LEF state waiting for the reader. For example, DCL writes to `SYS$OUTPUT` and `SYS$ERROR` in a `wait` mode, so a child process executing a DCL command procedure will wait until all the output is read by the parent process.

Recommendation: Read the pipes associated with the child process' `stdout` and `stderr` in a loop until an EOF message is received, or declare write attention ASTs on these mailboxes.

- The amount of data written to `SYS$OUTPUT` depends on the verification status of the process (`SET VERIFY/NOVERIFY` command); the subprocess inherits the verification status of the parent process. It is the caller's responsibility to set the verification status of the parent process to match the expected amount of data written to `SYS$OUTPUT` by the subprocess.
- Some applications, like DTM, define `SYS$ERROR` as `SYS$OUTPUT`. If `stderr` is not redefined by the caller, it is set in the subprocess as the parent's `SYS$ERROR`, which in this case translates to the parent's `SYS$OUTPUT`.

If the caller redefines `stdout` to a pipe and does not redefine `stderr`, output sent to `stderr` goes to the pipe associated with `stdout`, and the amount of data written to this mailbox may be more than expected.

decc\$set_child_standard_streams

Although redefinition of any subset of standard channels is supported, it is always safe to explicitly redefine all of them (or at least stdout and stderr) to avoid this situation.

- For a child process executing a DCL command procedure, SYS\$COMMAND is set to the pipe specified for the child's stdin so that the parent process can feed the child requesting data from SYS\$COMMAND through the pipe. For DCL command procedures, it is impossible to pass data from the parent to the child by means of the child's SYS\$INPUT because for a command procedure, DCL defines SYS\$INPUT as the command file itself.
-

Return Values

x	The number of file descriptors set for the child. This number does not include file descriptors specified as -1 in the call.
-1	indicates that an invalid file descriptor was specified; errno is set to EBADF.

Example

```
parent.c
=====
#include <stdio.h>
#include <string.h>
#include <unistd.h>

int decc$set_child_standard_streams(int, int, int);

main()
{
    int fdin[2], fdout[2], fderr[2];
    char msg[] = "parent writing to child's stdin";
    char buf[80];
    int nbytes;

    pipe(fdin);
    pipe(fdout);
    pipe(fderr);

    if ( vfork() == 0 ) {
        decc$set_child_standard_streams(fdin[0], fdout[1], fderr[1]);
        execl( "child", "child" );
    }
    else {
        write(fdin[1], msg, sizeof(msg));
        nbytes = read(fdout[0], buf, sizeof(buf));
        buf[nbytes] = '\0';
        puts(buf);
        nbytes = read(fderr[0], buf, sizeof(buf));
        buf[nbytes] = '\0';
        puts(buf);
    }
}

child.c
=====
#include <stdio.h>
#include <unistd.h>
```

decc\$set_child_standard_streams

```
main()
{
    char msg[] = "child writing to stderr";
    char buf[80];
    int nbytes;

    nbytes = read(0, buf, sizeof(buf));
    write(1, buf, nbytes);
    write(2, msg, sizeof(msg));
}

child.com
=====

$ read sys$command s
$ write sys$output s
$ write sys$error "child writing to stderr"
```

This example program returns the following for both child.c and child.com:

```
$ run parent
parent writing to child's stdin
child writing to stderr
```

Note that in order to activate child.com, you must explicitly specify `execl("child.com", ...)` in the parent.c program.

decc\$set_reentrancy

decc\$set_reentrancy

Controls the type of reentrancy that reentrant HP C RTL routines will exhibit.

Format

```
#include <reentrancy.h>
int decc$set_reentrancy (int type);
```

Argument

type

The type of reentrancy desired. Use one of the following values:

- `C$C_MULTITHREAD` — Designed to be used in conjunction with the DECthreads product. It performs DECthreads locking and never disables ASTs. DECthreads must be available on your system to use this form of reentrancy.
- `C$C_AST` — Uses the `__TESTBITSSI` (*Integrity servers, Alpha*) built-in function to perform simple locking around critical sections of RTL code, and it may additionally disable asynchronous system traps (ASTs) in locked regions of code. This type of locking should be used when AST code contains calls to HP C RTL I/O routines, or when the user application disables ASTs.
- `C$C_TOLERANT` — Uses the `__TESTBITSSI` (*Integrity servers, Alpha*) built-in function to perform simple locking around critical sections of RTL code, but ASTs are not disabled. This type of locking should be used when ASTs are used and must be delivered immediately. TOLERANT is the default reentrancy type.
- `C$C_NONE` — Gives optimal performance in the HP C RTL, but does absolutely no locking around critical sections of RTL code. It should only be used in a single-threaded environment when there is no chance that the thread of execution will be interrupted by an AST that would call the HP C RTL.

The reentrancy type can be raised but never lowered. The ordering of reentrancy types from low to high is `C$C_NONE`, `C$C_TOLERANT`, `C$C_AST` and `C$C_MULTITHREAD`. For example, once an application is set to multithread, a call to set the reentrancy to AST is ignored. A call to `decc$set_reentrancy` that attempts to lower the reentrancy type returns a value of `-1`.

Description

Use the `decc$set_reentrancy` function to change the type of reentrancy exhibited by reentrant routines.

`decc$set_reentrancy` must be called exclusively at the non-AST level.

In an application using DECthreads, DECthreads automatically sets the reentrancy to multithread.

Return Value

type
-1

The type of reentrancy used before this call.
The reentrancy was set to a lower type.

decc\$to_vms

decc\$to_vms

Converts UNIX style file specifications to OpenVMS file specifications.

Format

```
#include <unixlib.h>
```

```
int decc$to_vms (const char *unix_style_filespec, int (*action_routine)(char *OpenVMS_style_filespec,  
int type_of_file), int allow_wild, int no_directory);
```

Arguments

unix_style_filespec

The address of a null-terminated string containing a name in UNIX style file specification format.

action_routine

The address of a routine called by `decc$to_vms` that accepts the following arguments:

- A pointer to a null-terminated string that is the result of the translation to OpenVMS format.
- An integer that has one of the following values:

Value	Translation
0 (DECC\$K_FOREIGN)	A file on a remote system that is not running the OpenVMS or VAXELN operating system.
1 (DECC\$K_FILE)	The translation is a file.
2 (DECC\$K_DIRECTORY)	The OpenVMS translation of the UNIX style filename is a directory.

These values can be defined symbolically with the symbols `DECC$K_FOREIGN`, `DECC$K_FILE`, and `DECC$K_DIRECTORY`. See the example for more information.

If *action_routine* returns a nonzero value (TRUE), file translation continues. If it returns a 0 value (FALSE), no further file translation takes place.

allow_wild

Either 0 or 1, passed by value. If a 0 is specified, wildcards found in *unix_style_filespec* are not expanded. Otherwise, wildcards are expanded and each one is passed to *action_routine*. Only expanded filenames that correspond to existing OpenVMS files are included.

no_directory

An integer that has one of the following values:

decc\$translate_vms

decc\$translate_vms

Translates OpenVMS file specifications to UNIX style file specifications.

Format

```
#include <unixlib.h>
char *decc$translate_vms (const char *vms_filespec);
```

Argument

vms_filespec

The address of a null-terminated string containing a name in OpenVMS file specification format.

Description

The `decc$translate_vms` function translates the given OpenVMS file specification into the equivalent UNIX style file specification, whether or not the file exists. The translated name string is stored in a thread-specific memory, which is overwritten by each call to `decc$translate_vms` from the same thread.

This function differs from the `decc$from_vms` function, which does the conversion for existing files only.

Return Values

x	The address of a null-terminated string containing a name in UNIX style file specification format.
0	Indicates that the filename is null or syntactically incorrect.
-1	Indicates that the file specification contains an ellipsis (for example, [. . .]a.dat), but is otherwise correct. You cannot translate the OpenVMS ellipsis syntax into a valid UNIX style file specification.

Example

```
/* Demonstrate translation of a "UNIX" name to OpenVMS */
/* form, define a foreign command, and pass the name as */
/* the argument. */
#include <unixlib.h>
#include <stdio.h>
int main(int argc, char *argv[])
{
    char *ptr; /* translation result */
    ptr = decc$translate_vms( argv[1] );
    if ((int) ptr == 0 || (int) ptr == -1)
```



```
        printf( "could not translate %s\n", argv[1]);  
    else  
        printf( "%s is translated to %s\n", argv[1], ptr );  
}
```

decc\$validate_wchar

decc\$validate_wchar

Confirms that its argument is a valid wide character in the current program's locale.

Format

```
#include <unistd.h>
int decc$validate_wchar (wchar_t wc);
```

Argument

wc
Wide character to be validated.

Description

The `decc$validate_wchar` function provides a convenient way to verify whether a specified argument of `wchar_t` type is a valid wide character in the current program's locale.

One reason to call `decc$validate_wchar` is that the `isw*` wide-character classification functions and macros do not validate their argument before dereferencing the `classmask` array describing character properties. Passing an `isw*` function a value that exceeds the maximum wide-character value for the current program's locale can result in an attempt to access memory beyond the allocated `classmask` array.

A standard way to validate a wide character is to call the `wctomb` function, but this way is less convenient because it requires declaring a multibyte character array of sufficient size and passing it to `wctomb`.

Return Values

- | | |
|---|---|
| 1 | Indicates that the specified wide character is a valid wide character in the current program's locale. |
| 0 | Indicates that the specified wide character is not a valid wide character in the current program's locale. <code>errno</code> is not set. |

decc\$write_eof_to_mbx

Writes an end-of-file message to the mailbox.

Format

```
#include <unistd.h>
int decc$write_eof_to_mbx (int fd);
```

Argument

fd
File descriptor associated with the mailbox.

Description

The `decc$write_eof_to_mbx` function writes end-of-file message to the mailbox.

For a mailbox that is not a pipe, the write function called with an *nbytes* argument value of 0 sends an end-of-file message to the mailbox. For a pipe, however, the only way to write an end-of-file message to the mailbox is to close the pipe.

If the child's standard input is redirected to a pipe through a call to the `decc$set_child_standard_streams` function, the parent process can call `decc$write_eof_to_mbx` for this pipe to send an EOF message to the child. It has the same effect as if the child read the data from a terminal, and Ctrl/Z was pressed.

After a call to `decc$write_eof_to_mbx`, the pipe can be reused for communication with another child, for example. This is the purpose of `decc$write_eof_to_mbx`: to allow reuse of the pipe instead of having to close it just to send an end-of-file message.

Return Values

0	Indicates success.
-1	Indicates failure; <code>errno</code> and <code>vaxc\$errno</code> are set according to the failure status returned by <code>SYS\$QIOW</code> .

Example

```
/*      decc$write_eof_to_mbx_example.c      */
#include <errno.h>
#include <stdio.h>
#include <string.h>

#include <fcntl.h>
#include <unistd.h>
#include <unixio.h>

#include <descrip.h>
#include <ssdef.h>
#include <starlet.h>

int decc$write_eof_to_mbx( int );
```

decc\$write_eof_to_mbx

```
main()
{
    int status, nbytes, failed = 0;
    int fd, fd2[2];
    short int channel;
    $DESCRIPTOR(mbxname_dsc, "TEST_MBX");
    char c;

    /* first try a mailbox created by SYS$CREMBX      */
    status = sys$crembx(0, &channel, 0, 0, 0, 0, &mbxname_dsc, 0, 0);
    if ( status != SS$ NORMAL ) {
        printf("sys$crembx failed: %s\n",strerror(EVMSERR, status));
        failed = 1;
    }
    if ( (fd = open(mbxname_dsc.dsc$a_pointer, O_RDWR, 0)) == -1 ) {
        perror("? open mailbox");
        failed = 1;
    }
    if ( decc$write_eof_to_mbx(fd) == -1 ) {
        perror("? decc$write_eof_to_mbx to mailbox");
        failed = 1;
    }
    if ( (nbytes = read(fd, &c, 1)) != 0 || errno != 0 ) {
        perror("? read mailbox");
        printf("? nbytes = %d\n", nbytes);
        failed = 1;
    }
    if ( close(fd) == -1 ) {
        perror("? close mailbox");
        failed = 1;
    }
    /* Now do the same thing with a pipe      */
    errno = 0;          /* Clear errno for consistency */
    if ( pipe(fd2) == -1 ) {
        perror("? opening pipe");
        failed = 1;
    }
    if ( decc$write_eof_to_mbx(fd2[1]) == -1 ) {
        perror("? decc$write_eof_to_mbx to pipe");
        failed = 1;
    }
    if ( (nbytes = read(fd2[0], &c, 1)) != 0 || errno != 0 ) {
        perror("? read pipe");
        printf("? nbytes = %d\n", nbytes);
        failed = 1;
    }
    /* Close both file descriptors involved with the pipe */
    if ( close(fd2[0]) == -1 ) {
        perror("close(fd2[0])");
        failed = 1;
    }
    if ( close(fd2[1]) == -1 ) {
        perror("close(fd2[1])");
        failed = 1;
    }
}
```

```
if ( failed )
    puts("?Example program failed");
else
    puts("Example ran to completion");
}
```

This example program produces the following result:

Example ran to completion

[w]delch

[w]delch

Delete the character on the specified window at the current position of the cursor. The `delch` function operates on the `stdscr` window.

Format

```
#include <curses.h>
int delch();
int wdelch (WINDOW *win);
```

Argument

win
A pointer to the window.

Description

All of the characters to the right of the cursor on the same line are shifted to the left, and a blank character is appended to the end of the line.

Return Values

OK	Indicates success.
ERR	Indicates an error.

delete

Deletes a file.

Format

```
#include <unistd.h>
int delete (const char *file_spec);
```

Argument

file_spec

A pointer to the string that is an OpenVMS or UNIX style file specification. The file specification can include a wildcard in its version number (but not in any other part of the file spec). So, for example, files of the form *filename.txt;** can be deleted.

Description

If you specify a directory in the filename and it is a search list that contains an error, HP C for OpenVMS Systems interprets it as a file error.

When delete is used to delete a symbolic link, the link itself is deleted, not the file to which it refers.

The remove and delete functions are functionally equivalent in the HP C RTL.

See also remove.

Note

The delete routine is not available to C++ programmers because it conflicts with the C++ reserved word delete. C++ programmers should use the ANSI/ISO C standard function remove instead.

Return Values

0	Indicates success.
nonzero value	Indicates that the operation has failed.

[w]deleteln

[w]deleteln

Delete the line at the current position of the cursor. The `deleteln` function acts on the `stdscr` window.

Format

```
#include <curses.h>
int deleteln();
int wdeleteln (WINDOW *win);
```

Argument

win
A pointer to the window.

Description

Every line below the deleted line moves up, and the bottom line becomes blank. The current (y,x) coordinates of the cursor remain unchanged.

Return Values

OK	Indicates success.
ERR	Indicates an error.

delwin

Deletes the specified window from memory.

Format

```
#include <curses.h>
int delwin (WINDOW *win);
```

Argument

win
A pointer to the window.

Description

If the window being deleted contains a subwindow, the subwindow is invalidated. Delete subwindows before deleting their parent. The `delwin` function refreshes all windows covered by the deleted window.

Return Values

OK	Indicates success.
ERR	Indicates an error.

difftime

difftime

Computes the difference, in seconds, between the two times specified by the *time1* and *time2* arguments.

Format

```
#include <time.h>
double difftime (time_t time2, time_t time1);
```

Arguments

time2

A time value of type `time_t`.

time1

A time value of type `time_t`.

Description

The type `time_t` is defined in the `<time.h>` header file as follows:

```
typedef unsigned long int time_t
```

Return Value

n $time2 - time1$ in seconds expressed as a double.

dirname

Reports the parent directory name of a file pathname.

Format

```
#include <libgen.h>
char *dirname (char *path);
```

Function Variants

The `dirname` function has variants named `_dirname32` and `_dirname64` for use with 32-bit and 64-bit pointer sizes, respectively. See Section 1.9 for more information on using pointer-size-specific functions.

Argument

path
The file pathname.

Description

The `dirname` function takes a pointer to a character string that contains a UNIX pathname and returns a pointer to a string that is a pathname of the parent directory of that file. Trailing slash (`/`) characters in the path are not counted as part of the path.

This function returns a pointer to the string `"."` (dot), when the *path* argument:

- Does not contain a slash (`/`).
- Is a NULL pointer.
- Points to an empty string.

The `dirname` function can modify the string pointed to by the *path* argument.

The `dirname` and `basename` functions together yield a complete pathname. The expression `dirname(path)` obtains the pathname of the directory where `basename(path)` is found.

See also `basename`.

Return Values

x	A pointer to a string that is the parent directory of the <i>path</i> argument.
"."	The <i>path</i> argument: <ul style="list-style-type: none">• Does not contain a slash (<code>/</code>).• Is a NULL pointer.• Points to an empty string.

dirname

Example

Using the `dirname` function, the following example reads a pathname, changes the current working directory to the parent directory, and opens a file.

```
char path [MAXPATHLEN], *pathcopy;
int fd;

fgets(path, MAXPATHLEN, stdin);
pathcopy = strdup(path);
chdir(dirname(pathcopy));
fd = open(basename(path), O_RDONLY);
```

div

Returns the quotient and the remainder after the division of its arguments.

Format

```
#include <stdlib.h>
div_t div (int numer, int denom);
```

Arguments

numer

A numerator of type int.

denom

A denominator of type int.

Description

The type `div_t` is defined in the standard header file `<stdlib.h>` as follows:

```
typedef struct
{
    int    quot, rem;
} div_t;
```

dlclose

dlclose

Deallocates the address space for a shared library.

Format

```
#include <dlfcn.h>
void dlclose (void *handle);
```

Argument

handle
Pointer to the shared library.

Description

The `dlclose` function deallocates the address space allocated by the HP C RTL for the handle.

There is no way on OpenVMS systems to unload a shareable image dynamically loaded by the `LIB$FIND_IMAGE_SYMBOL` routine, which is the routine called by the `dlsym` function. In other words, there is no way on OpenVMS systems to release the address space occupied by the shareable image brought into memory by `dlsym`.

dlerror

Returns a string describing the last error that occurred from a call to `dlopen`, `dlclose`, or `dlsym`.

Format

```
#include <dlfcn.h>
char *dlerror (void);
```

Return Value

x	A string describing the last error that occurred from a call to <code>dlopen</code> , <code>dlclose</code> , or <code>dlsym</code> .
---	--

dlopen

dlopen

Provides an interface to the dynamic library loader to allow shareable images to be loaded and called at run time.

Format

```
#include <dlfcn.h>

void *dlopen (char *pathname, int mode);
```

Arguments

pathname

The name of the shareable image. This name is saved for subsequent use by the `dlsym` function.

mode

This argument is ignored on OpenVMS systems.

Description

The `dlopen` function provides an interface to the dynamic library loader to allow shareable images to be loaded and called at run time.

This function does not load a shareable image but rather saves its *pathname* argument for subsequent use by the `dlsym` function. `dlsym` is the function that actually loads the shareable image through a call to `LIB$FIND_IMAGE_SYMBOL`.

The *pathname* argument of the `dlopen` function must be the name of the shareable image. This name is passed as-is by the `dlsym` function to the `LIB$FIND_IMAGE_SYMBOL` routine as the *filename* argument. No *image-name* argument is specified in the call to `LIB$FIND_IMAGE_SYMBOL`, so default file specification of `SYS$SHARE:.EXE` is applied to the image name.

The `dlopen` function returns a handle that is used by a `dlsym` or `dlclose` call. If an error occurs, a `NULL` pointer is returned.

Return Values

x	A handle to be used by a <code>dlsym</code> or <code>dlclose</code> call.
NULL	Indicates an error.

dlsym

Returns the address of the symbol name found in a shareable image.

Format

```
#include <dlfcn.h>
void *dlsym (void *handle, char *name);
```

Arguments

handle

Pointer to the shareable image.

name

Pointer to the symbol name.

Description

The `dlsym` function returns the address of the symbol name found in the shareable image corresponding to *handle*. If the symbol is not found, a NULL pointer is returned.

As of OpenVMS Version 7.3-2, library symbols containing lowercase characters can be loaded using the `dlsym` function. More generally, the functions that dynamically load libraries (`dlopen`, `dlsym`, `dlclose`, `dlerror`) are enhanced to provide the following capabilities:

- Support for libraries with mixed-case symbol names
- Ability to pass a full file path to `dlopen`
- Validation of the specified library name

Return Values

x	Address of the symbol name found.
NULL	Indicates that the symbol was not found.

drand48

drand48

Generates uniformly distributed pseudorandom-number sequences. Returns 48-bit, nonnegative, double-precision floating-point values.

Format

```
#include <stdlib.h>
double drand48 (void);
```

Description

The `drand48` function generates pseudorandom numbers using the linear congruential algorithm and 48-bit integer arithmetic.

It returns nonnegative, double-precision, floating-point values uniformly distributed over the range of y values such that $0.0 \leq y < 1.0$.

Before you call `drand48`, use either `srand48`, `seed48`, or `lcong48` to initialize the random-number generator. You must initialize prior to invoking the `drand48` function because it stores the last 48-bit X_i generated into an internal buffer. (Although it is not recommended, constant default initializer values are supplied automatically if the `drand48`, `lrand48`, or `mrnd48` functions are called without first calling an initialization function.)

The `drand48` function works by generating a sequence of 48-bit integer values, X_i , according to the linear congruential formula:

$$X_{n+1} = (aX_n + c) \bmod m \quad n \geq 0$$

The argument m equals 2^{48} , so 48-bit integer arithmetic is performed. Unless you invoke `lcong48`, the multiplier value a and the addend value c are:

$$\begin{aligned} a &= 5DEECE66D_{16} = 2736731631558 \\ c &= B_{16} = 138 \end{aligned}$$

The values returned by `drand48` are computed by first generating the next 48-bit X_i in the sequence. Then the appropriate bits, according to the type of returned data item, are copied from the high-order (most significant) bits of X_i and transformed into the returned value.

See also `srand48`, `seed48`, `lcong48`, `lrand48`, and `mrnd48`.

Return Value

n A nonnegative, double-precision, floating-point value.

dup, dup2

Allocate a new descriptor that refers to a file specified by a file descriptor returned by `open`, `creat`, or `pipe`.

Format

```
#include <unistd.h>
int dup (int file_desc1);
int dup2 (int file_desc1, int file_desc2);
```

Arguments

file_desc1

The file descriptor being duplicated.

file_desc2

The new file descriptor to be assigned to the file designated by *file_desc1*.

Description

The `dup` function causes a previously unallocated descriptor to refer to its argument, while the `dup2` function causes its second argument to refer to the same file as its first argument.

The argument *file_desc1* is invalid if it does not describe an open file; *file_desc2* is invalid if the new file descriptor cannot be allocated. If *file_desc2* is connected to an open file, that file is closed.

Return Values

n	The new file descriptor.
-1	Indicates that an invalid argument was passed to the function.

[no]echo

[no]echo

Set the terminal so that characters may or may not be echoed on the terminal screen. This mode of single-character input is only supported with Curses.

Format

```
#include <curses.h>
void echo (void);
void noecho (void);
```

Description

The `noecho` function may be helpful when accepting input from the terminal screen with `wgetch` and `wgetstr`; it prevents the input characters from being written onto the screen.

ecvt

Converts its argument to a null-terminated string of ASCII digits and returns the address of the string. The string is stored in a thread-specific memory location created by the HP C RTL.

Format

```
#include <stdlib.h>

char *ecvt (double value, int ndigits, int *decpt, int *sign);
```

Arguments

value

An object of type `double` that is converted to a null-terminated string of ASCII digits.

ndigits

The number of ASCII digits to be used in the converted string.

decpt

The position of the decimal point relative to the first character in the returned string. A negative `int` value means that the decimal point is *decpt* number of spaces to the left of the returned digits (the spaces being filled with zeros). A 0 value means that the decimal point is immediately to the left of the first digit in the returned string.

sign

An integer value that indicates whether the *value* argument is positive or negative. If *value* is negative, the function places a nonzero value at the address specified by *sign*. Otherwise, the function assigns 0 to the address specified by *sign*.

Description

The `ecvt` function converts *value* to a null-terminated string of length *ndigits*, and returns a pointer to it. The resulting low-order digit is rounded to the correct digit for outputting *ndigits* digits in C E-format. The *decpt* argument is assigned the position of the decimal point relative to the first character in the string.

Repeated calls to the `ecvt` function overwrite any existing string.

The `ecvt`, `fcvt`, and `gcvt` functions represent the following special values specified in the IEEE Standard for floating-point arithmetic:

encrypt

Encrypts a string using the key generated by the setkey function.

Format

```
#include <unistd.h>
#include <stdlib.h>
void encrypt (char *block[64], int edflag);
```

Argument

block

A character array of length 64 containing 0s and 1s.

edflag

An integer. If edflag is 0, the argument is encrypted; if nonzero, it is decrypted.

Description

The encrypt function encrypts a string using the key generated by the setkey function.

The first argument to encrypt is a character array of length 64 containing 0s and 1s. The argument array is modified in place to a similar array representing the bits of the argument after having been subjected to the DES algorithm using the key set by setkey.

The second argument, *edflag*, determines whether the first argument is encrypted or decrypted: if *edflag* is 0, the first argument array is encrypted; if nonzero, it is decrypted.

No value is returned.

See also crypt and setkey.

Return Value

pointer	Pointer to the encrypted password.
---------	------------------------------------

endgrent (*Integrity servers, Alpha*)

endgrent (*Integrity servers, Alpha*)

Closes the group database when processing is complete.

Format

```
#include <grp.h>
void endgrent (void);
```

Description

The endgrent function closes the group database.

This function is always successful. No value is returned, and errno is not set.

endpwent

Closes the user database and any private stream used by getpwent.

Format

```
#include <pwd.h>
void endpwent (void);
```

Description

The endpwent function closes the user database and any private stream used by getpwent.

No value is returned. If an I/O error occurred, the function sets errno to EIO.

See also getpwent, getpwuid, getpwnam, and setpwent.

endwin

endwin

Clears the terminal screen and frees any virtual memory allocated to Curses data structures.

Format

```
#include <curses.h>
void endwin (void);
```

Description

A program that calls Curses functions must call the `endwin` function before exiting to restore the previous environment of the terminal screen.

erand48

Generates uniformly distributed pseudorandom-number sequences. Returns 48-bit nonnegative, double-precision, floating-point values.

Format

```
#include <stdlib.h>

double erand48 (unsigned short int xsubi[3]);
```

Argument

xsubi

An array of three short ints, which form a 48-bit integer when concatenated together.

Description

The `erand48` function generates pseudorandom numbers using the linear congruential algorithm and 48-bit integer arithmetic.

It returns nonnegative, double-precision, floating-point values uniformly distributed over the range of y values, such that $0.0 \leq y < 1.0$.

The `erand48` function works by generating a sequence of 48-bit integer values, X_i , according to the linear congruential formula:

$$X_{n+1} = (aX_n + c) \bmod m \quad n \geq 0$$

The argument m equals 2^{48} , so 48-bit integer arithmetic is performed. Unless you invoke the `lcong48` function, the multiplier value a and the addend value c are:

$$\begin{aligned} a &= 5DEECE66D_{16} = 273673163155g \\ c &= B_{16} = 13g \end{aligned}$$

The `erand48` function requires that the calling program pass an array as the `xsubi` argument. For the first call, the array must be initialized to the value of the pseudorandom-number sequence. Unlike the `drand48` function, it is not necessary to call an initialization function prior to the first call.

By using different arguments, the `erand48` function allows separate modules of a large program to generate several independent sequences of pseudorandom numbers; for example, the sequence of numbers that one module generates does not depend upon how many times the function is called by other modules.

Return Value

n	A nonnegative, double-precision, floating-point value.
---	--

[w]erase

[w]erase

Erases the window by painting it with blanks. The erase function acts on the stdscr window.

Format

```
#include <curses.h>
int erase();
int werase (WINDOW *win);
```

Argument

win
A pointer to the window.

Description

Both the erase and werase functions leave the cursor at the current position on the terminal screen after completion; they do not return the cursor to the home coordinates of (0,0).

Return Values

OK	Indicates success.
ERR	Indicates an error.

erf

Returns the error function of its argument.

Format

```
#include <math.h>
double erf (double x);
float erff (float x); (Integrity servers, Alpha)
long double erfl (long double x); (Integrity servers, Alpha)
double erfc (double x); (Integrity servers, Alpha)
float erfcf (float x); (Integrity servers, Alpha)
long double erfc1 (long double x); (Integrity servers, Alpha)
```

Argument

x
A radian expressed as a real number.

Description

The erf functions return the error function of x , where $\text{erf}(x)$, $\text{erff}(x)$, and $\text{erfl}(x)$ equal $2/\sqrt{\pi}$ times the area under the curve $e^{-(t^2)}$ between 0 and x .

The erfc functions return $(1.0 - \text{erf}(x))$. The erfc function can result in an underflow as x gets large.

Return Values

x	The value of the error function (erf) or complementary error function (erfc).
NaN	x is NaN; errno is set to EDOM.
0	Underflow occurred; errno is set to ERANGE.

execl

Passes the name of an image to be activated in a child process. This function is nonreentrant.

Format

```
#include <unistd.h>
```

```
int execl (const char *file_spec, const char *arg0, . . . , (char *)0); (ISO POSIX-1)
```

```
int execl (char *file_spec, . . . ); (Compatibility)
```

Arguments**file_spec**

The full file specification of a new image to be activated in the child process.

arg0, ...

A sequence of pointers to null-terminated character strings.

If the POSIX-1 format is used, at least one argument must be present and must point to a string that is the same as the new process filename (or its last component). (This pointer can also be the NULL pointer, but then `execl` would accomplish nothing.) The last pointer must be the NULL pointer. This is also the convention if the compatibility format is used.

Description

To understand how the `exec` functions operate, consider how the OpenVMS system calls any HP C program, as shown in the following syntax:

```
int main (int argc, char *argv[], char *envp[]);
```

The identifier `argc` is the argument count; `argv` is an array of argument strings. The first member of the array (`argv[0]`) contains the name of the image. The arguments are placed in subsequent elements of the array. The last element of the array is always the NULL pointer.

An `exec` function calls a child process in the same way that the run-time system calls any other HP C program. The `exec` functions pass the name of the image to be activated in the child; this value is placed in `argv[0]`. However, the functions differ in the way they pass arguments and environment information to the child:

- Arguments can be passed in separate character strings (`execl`, `execle`, and `execlp`) or in an array of character strings (`execv`, `execve`, and `execvp`).
- The environment can be explicitly passed in an array (`execle` and `execve`) or taken from the parent's environment (`execl`, `execv`, `execlp`, and `execvp`).

If `vfork` was called before invoking an `exec` function, then when the `exec` function completes, control is returned to the parent process at the point of the `vfork` call. If `vfork` was not called, the `exec` function waits until the child has completed execution and then exits the parent process. See `vfork` and Chapter 5 for more information.

Return Value

-1

Indicates failure.

exit, _exit

Terminate execution of the program from which they are called. These functions are nonreentrant.

Format

```
#include <stdlib.h>
void exit (int status);
#include <unistd.h>
void _exit (int status);
```

Argument

status

For non-POSIX behavior, a status value of EXIT_SUCCESS (1), EXIT_FAILURE (2), or a number from 3 to 255, as follows:

- A status value of 0, 1 or EXIT_SUCCESS is translated to the OpenVMS SS\$_NORMAL status code to return the OpenVMS success value.
- A status value of 2 or EXIT_FAILURE is translated to an error-level exit status. The status value is passed to the parent process.
- Any other status value is left the same.

For POSIX behavior:

- A status value of 0 is translated to the OpenVMS SS\$_NORMAL status code to return the OpenVMS success value.
- Any other status is returned to the parent process as an OpenVMS message symbol with facility set to C, severity set to success, and with the status in the message number field. For more information on the format of message symbols, see "message code" in the *HP OpenVMS Command Definition, Librarian, and Message Utilities Manual*.

To get POSIX behavior, include <unistd.h> and compile with the `_POSIX_EXIT` feature-test macro set (either with `/DEFINE=_POSIX_EXIT`, or with `#define _POSIX_EXIT` at the top of your file, before any file inclusions). This behavior is available only on OpenVMS Version 7.0 and higher systems.

Description

If the process was invoked by DCL, the status is interpreted by DCL, and a message is displayed.

If the process was a child process created using `vfork` or an `exec` function, then the child process exits and control returns to the parent. The two functions are identical; the `_exit` function is retained for reasons of compatibility with VAX C.

The `exit` and `_exit` functions make use of the `$EXIT` system service. If your process is being invoked by the `RUN` command using any of the hibernation and scheduled wakeup qualifiers, the process might not correctly return to hibernation state when an `exit` or `_exit` call is made.

exit, _exit

The C compiler command-line qualifier `/[NO]MAIN=POSIX_EXIT` can be used to direct the compiler to call `__posix_exit` instead of `exit` when returning from `main`. The default is `/NOMAIN`.

Beginning with OpenVMS Version 8.3, C RTL contains a fix for the problem in which a call to `_exit` after a failed `exec1` really exits but must not.

In the OpenVMS implementation of `vfork`, a child process is not actually started as it is started on most UNIX systems. However, the C RTL creates some internal data structures intended to mimic child-process functionality (called the "child context").

A bug occurred whereby after a `vfork` while in the child context, a call to an `exec` function justifiably fails, then calls `_exit`. On UNIX systems, after the failed `exec` call, the child process continues to execute. A subsequent call to `_exit` terminates the child. In the OpenVMS implementation, after the failed `exec` call, the child context terminates. A subsequent call to `_exit` terminates the parent. The C RTL fix is enabled by a feature logical switch, `DECC$EXIT_AFTER_FAILED_EXEC`. Enabling this feature logical allows the child context to continue execution.

With `DECC$EXIT_AFTER_FAILED_EXEC` disabled or not defined, the current behavior remains the default.

Note

`EXIT_SUCCESS` and `EXIT_FAILURE` are portable across any ANSI C compiler to indicate success or failure. On OpenVMS systems, they are mapped to OpenVMS condition codes with the severity set to success or failure, respectively. Values in the range of 3 to 255 can be used by a child process to communicate a small amount of data to the parent. The parent retrieves this data using the `wait`, `wait3`, `wait4`, or `waitpid` functions.

exp

Returns the base e raised to the power of the argument.

Format

```
#include <math.h>
double exp (double x);
float expf (float x); (Integrity servers, Alpha)
long double expl (long double x); (Integrity servers, Alpha)
double expm1 (double x); (Integrity servers, Alpha)
float expm1f (float x); (Integrity servers, Alpha)
long double expm1l (long double x); (Integrity servers, Alpha)
```

Argument

x
A real value.

Description

The exp functions compute the value of the exponential function, defined as e^{**x} , where e is the constant used as a base for natural logarithms.

The expm1 functions compute $\exp(x) - 1$ accurately, even for tiny x .

If an overflow occurs, the exp functions return the largest possible floating-point value and set errno to ERANGE. The constant HUGE_VAL is defined in the <math.h> header file to be the largest possible floating-point value.

Return Values

x	The exponential value of the argument.
HUGE_VAL	Overflow occurred; errno is set to ERANGE.
0	Underflow occurred; errno is set to ERANGE.
NaN	x is NaN; errno is set to EDOM.

exp2 (*Integrity servers, Alpha*)

Returns the value of 2 raised to the power of the argument.

Format

```
#include <math.h>
double exp2 (double x);
float exp2f (float x);
long double exp2l (long double x);
```

Argument

x
A real value.

Description

The `exp2` functions compute the base-2 exponential of x .
If an overflow occurs, the `exp` functions return the largest possible floating-point value and set `errno` to `ERANGE`. The constant `HUGE_VAL` is defined in the `<math.h>` header file to be the largest possible floating-point value.

Return Values

<code>n</code>	$2^{**}x$.
<code>HUGE_VAL</code>	Overflow occurred; <code>errno</code> is set to <code>ERANGE</code> .
<code>1</code>	x is <code>+0</code> or <code>-0</code> ; <code>errno</code> is set to <code>ERANGE</code> .
<code>0</code>	x is <code>-Inf</code> or underflow occurred; <code>errno</code> is set to <code>ERANGE</code> .
x	x is <code>+Inf</code> ; <code>errno</code> is set to <code>ERANGE</code> .
<code>NaN</code>	x is <code>NaN</code> ; <code>errno</code> is set to <code>EDOM</code> .

fchmod

fchmod

Changes file access permissions.

Format

```
#include <stat.h>
int fchmod (int fildes, mode_t mode);
```

Arguments

fildes

An open file descriptor.

mode

The bit pattern that determines the access permissions.

Description

The `fchmod` function is equivalent to the `chmod` function, except that the file whose permissions are changed is specified by a file descriptor (*fildes*) rather than a filename.

Return Values

0	Indicates that the mode is successfully changed.
-1	Indicates that the change attempt has failed.

fchown

Changes the owner and group of a file.

Format

```
#include <unistd.h>
int fchown (int fildes, uid_t owner, gid_t group);
```

Arguments

fildes

An open file descriptor.

owner

A user ID corresponding to the new owner of the file.

group

A group ID corresponding to the group of the file.

Description

The `fchown` function has the same effect as `chown` except that the file whose owner and group are to be changed is specified by the file descriptor *fildes*.

Return Values

0

Indicates success.

-1

Indicates failure. The function sets `errno` to one of the following values:

The `fchown` function *will* fail if:

- `EBADF` – The *fildes* argument is not an open file descriptor.
- `EPERM` – The effective user ID does not match the owner of the file, or the process does not have appropriate privilege.
- `EROFS` – The file referred to by *fildes* resides on a read-only file system.

The `fchown` function *may* fail if:

- `EINVAL` – The owner or group ID is not a value supported by the implementation.
- `EIO` – A physical I/O error has occurred.
- `EINTR` – The `fchown` function was interrupted by a signal that was intercepted.

fclose

fclose

Closes a file by flushing any buffers associated with the file control block and freeing the file control block and buffers previously associated with the file pointer.

Format

```
#include <stdio.h>
int fclose (FILE *file_ptr);
```

Argument

file_ptr
A pointer to the file to be closed.

Description

When a program terminates normally, the `fclose` function is automatically called for all open files.

The `fclose` function tries to write buffered data by using an implicit call to `fflush`.

If the write fails (because the disk is full or the user's quota is exceeded, for example), `fclose` continues executing. It closes the OpenVMS channel, deallocates any buffers, and releases the memory associated with the file descriptor (or FILE pointer). Any buffered data is lost, and the file descriptor (or FILE pointer) no longer refers to the file.

If your program needs to recover from errors when flushing buffered data, it should make an explicit call to `fsync` (or `fflush`) before calling `fclose`.

Return Values

0	Indicates success.
EOF	Indicates that the file control block is not associated with an open file.

fcntl

Performs controlling operations on an open file.

Format

```
#include <sys/types.h>
#include <unistd.h>
#include <fcntl.h>

int fcntl (int file_desc, int request [, int arg]);
int fcntl (int file_desc, int request [, struct flock *arg]);
```

Arguments

file_desc

An open file descriptor obtained from a successful open, fcntl, or pipe function.

request

The operation to be performed.

arg

A variable that depends on the value of the *request* argument.

For a *request* of F_DUPFD, F_SETFD, or F_SETFL, specify *arg* as an int.

For a *request* of F_GETFD and F_GETFL, do not specify *arg*.

For a *request* of F_GETLK, F_SETLK, or F_SETLKW specify *arg* as a pointer to a flock structure.

Description

The fcntl function performs controlling operations on the open file specified by the *file_desc* argument.

The values for the *request* argument are defined in the header file <fcntl.h>, and include the following:

F_DUPFD	Returns a new file descriptor that is the lowest numbered available (that is, not already open) file descriptor greater than or equal to the third argument (<i>arg</i>) taken as an integer of type int.
---------	---

The new file descriptor refers to the same file as the original file descriptor (*file_desc*). The FD_CLOEXEC flag associated with the new file descriptor is cleared to keep the file open across calls to one of the exec functions.

fcntl

The following two calls are equivalent:

```
fid = dup(file_desc);  
fid = fcntl(file_desc, F_DUPFD, 0);
```

Consider the following call:

```
fid = dup2(file_desc, arg);
```

It is similar (but not equivalent) to:

```
close(arg);  
fid = fcntl(file_desc, F_DUPFD, arg);
```

F_GETFD	Gets the value of the close-on-exec flag associated with the file descriptor <i>file_desc</i> . File descriptor flags are associated with a single file descriptor and do not affect other file descriptors that refer to the same file. The <i>arg</i> argument should not be specified.
F_SETFD	Sets the close-on-exec flag associated with <i>file_desc</i> to the value of the third argument, taken as type <code>int</code> . If the third argument is 0, the file remains open across the <code>exec</code> functions, which means that a child process spawned by the <code>exec</code> function inherits this file descriptor from the parent. If the third argument is <code>FD_CLOEXEC</code> , the file is closed on successful execution of the next <code>exec</code> function, which means that the child process spawned by the <code>exec</code> function will not inherit this file descriptor from the parent.
F_GETFL	Gets the file status flags and file access modes, defined in <code><fcntl.h></code> , for the file description associated with <i>file_desc</i> . The file access modes can be extracted from the return value using the mask <code>O_ACCMODE</code> , which is defined in <code><fcntl.h></code> . File status flags and file access modes are associated with the file description and do not affect other file descriptors that refer to the same file with different open file descriptions.
F_SETFL	Sets the file status flags, defined in <code><fcntl.h></code> , for the file description associated with <i>file_desc</i> from the corresponding bits in the third argument, <i>arg</i> , taken as type <code>int</code> . Bits corresponding to the file access mode and the file creation flags, as defined in <code><fcntl.h></code> , that are set in <i>arg</i> are ignored. If any bits in <i>arg</i> other than those mentioned here are changed by the application, the result is unspecified.

Note: The only status bit recognized is O_APPEND. Support for O_APPEND is not standard-compliant. The X/Open standard states that "File status flags and file access modes are associated with the file description and do not affect other file descriptors that refer to the same file with different open file descriptions." However, because the append bit is stored in the FCB, all file descriptors using the same FCB are using the same append flag, so that setting this flag with `fcntl(F_SETFL)` will affect all files sharing the FCB; that is, all files duplicated from the same file descriptor.

Record Locking Requests

F_GETLK Gets the first lock that blocks the lock description pointed to by the *arg* parameter, taken as a pointer to type `struct flock`. The information retrieved overwrites the information passed to the `fcntl` function in the `flock` structure. If no lock is found that would prevent this lock from being created, then the structure is left unchanged except for the lock type, which is set to F_UNLCK.

F_SETLK Sets or clears a file segment lock according to the lock description pointed to by *arg*, taken as a pointer to type `struct flock`. F_SETLK is used to establish shared locks (F_RDLCK), or exclusive locks (F_WRLCK), as well as remove either type of lock (F_UNLCK). If a shared (read) or exclusive (write) lock cannot be set, the `fcntl` function returns immediately with a value of `-1`.

An unlock (F_UNLCK) request in which the *l_len* of the `flock` structure is nonzero and the offset of the last byte of the requested segment is the maximum value for an object of type `off_t`, when the process has an existing lock in which *l_len* is `0` and which includes the last byte of the requested segment, is treated as a request to unlock from the start of the requested segment with an *l_len* equal to `0`. Otherwise, an unlock (F_UNLCK) request attempts to unlock only the requested file.

F_SETLKW Same as F_SETLK except that if a shared or exclusive lock is blocked by other locks, the process will wait until it is unblocked. If a signal is received while `fcntl` is waiting for a region, the function is interrupted, `-1` is returned, and `errno` is set to EINTR.

File Locking

The C RTL supports byte-range file locking using the F_GETLK, F_SETLK, and F_SETLKW commands of the `fcntl` function, as defined in the X/Open specification. Byte-range file locking is supported across OpenVMS clusters. You can only use offsets that fit into 32-bit unsigned integers.

When a shared lock is set on a segment of a file, other processes on the cluster are able to set shared locks on that segment or a portion of it. A shared lock prevents any other process from setting an exclusive lock on any portion of the protected

fcntl

area. A request for a shared lock fails if the file descriptor was not opened with read access.

An exclusive lock prevents any other process on the cluster from setting a shared lock or an exclusive lock on any portion of the protected area. A request for an exclusive lock fails if the file descriptor was not opened with write access.

The flock structure describes the type (*l_type*), starting offset (*l_whence*), relative offset (*l_start*), size (*l_len*) and process ID (*l_pid*) of the segment of the file to be affected.

The value of *l_whence* is set to SEEK_SET, SEEK_CUR or SEEK_END, to indicate that the relative offset *l_start* bytes is measured from the start of the file, from the current position, or from the end of the file, respectively. The value of *l_len* is the number of consecutive bytes to be locked. The *l_len* value may be negative (where the definition of *off_t* permits negative values of *l_len*). The *l_pid* field is only used with F_GETLCK to return the process ID of the process holding a blocking lock. After a successful F_GETLCK request, the value of *l_whence* becomes SEEK_SET.

If *l_len* is positive, the area affected starts at *l_start* and ends at *l_start* + *l_len* - 1. If *l_len* is negative, the area affected starts at *l_start* + *l_len* and ends at *l_start* - 1. Locks may start and extend beyond the current end of a file, but may not be negative relative to the beginning of the file. If *l_len* is set to 0 (zero), a lock may be set to always extend to the largest possible value of the file offset for that file. If such a lock also has *l_start* set to 0 (zero) and *l_whence* is set to SEEK_SET, the whole file is locked.

Changing or unlocking a portion from the middle of a larger locked segment leaves a smaller segment at either end. Locking a segment that is already locked by the calling process causes the old lock type to be removed and the new lock type to take effect.

All locks associated with a file for a given process are removed when a file descriptor for that file is closed by that process or the process holding that file descriptor terminates. Locks are not inherited by a child process.

If the *request* argument is F_SETLKW, the lock is blocked by some lock from another process, and putting the calling process to sleep to wait for that lock to become free would cause a deadlock, then the application will hang.

Return Values

n	Upon successful completion, the value returned depends on the value of the <i>request</i> argument as follows:
	<ul style="list-style-type: none">• F_DUPFD – Returns a new file descriptor.• F_GETFD – Returns FD_CLOEXEC or 0.• F_SETFD, F_GETLCK, F_SETLCK, F_UNLCK – Return a value other than -1.

Indicates that an error occurred. The function sets `errno` to one of the following values:

- **EACCES** – The *request* argument is `F_SETLK`; the type of lock (*l_type*) is a shared (`F_RDLCK`) or exclusive (`F_WRLCK`) lock, and the segment of a file to be locked is already exclusive-locked by another process; or the type is an exclusive (`F_WRLCK`) lock and the some portion of the segment of a file to be locked is already shared-locked or exclusive-locked by another process.
- **EBADF** – The *file_desc* argument is not a valid open file descriptor and the *arg* argument is negative or greater than or equal to the per-process limit.
The *request* parameter is `F_SETLK` or `F_SETLKW`, the type of lock (*l_type*) is a shared lock (`F_RDLCK`), and *file_desc* is not a valid file descriptor open for reading.
The type of lock (*l_type*) is an exclusive lock (`F_WRLCK`), and *file_desc* is not a valid file descriptor open for writing.
- **EFAULT** – The *arg* argument is an invalid address.
- **EINVAL** – The *request* argument is `F_DUPFD` and *arg* is negative or greater than or equal to `OPEN_MAX`.
Either the `OPEN_MAX` value or the per-process soft descriptor limit is checked.
An illegal value was provided for the *request* argument.
The *request* argument is `F_GETLK`, `F_SETLK`, or `F_SETLKW` and the data pointed to by *arg* is invalid, or *file_desc* refers to a file that does not support locking.
- **EMFILE** – The *request* argument is `F_DUPFD` and too many or `OPEN_MAX` file descriptors are currently open in the calling process, or no file descriptors greater than or equal to *arg* are available.
Either the `OPEN_MAX` value or the per-process soft descriptor limit is checked.

fcntl

- EOVERFLOW – One of the values to be returned cannot be represented correctly. The request argument is F_GETLK, F_SETLK, or F_SETLKW and the smallest or, if *l_len* is nonzero, the largest offset of any byte in the requested segment cannot be represented correctly in an object of type *off_t*.
- EINTR – The *request* argument is F_SETLKW, and the function was interrupted by a signal.
- ENOLCK – The *request* argument is F_SETLK or F_SETLKW, and satisfying the lock or unlock request would exceed the configurable system limit of NLOCK_RECORD.
- ENOMEM – The system was unable to allocate memory for the requested file descriptor.

fcvt

Converts its argument to a null-terminated string of ASCII digits and returns the address of the string. The string is stored in a thread-specific location created by the HP C RTL.

Format

```
#include <stdlib.h>

char *fcvt (double value, int ndigits, int *decpt, int *sign);
```

Arguments

value

An object of type `double` that is converted to a null-terminated string of ASCII digits.

ndigits

The number of ASCII digits after the decimal point to be used in the converted string.

decpt

The position of the decimal point relative to the first character in the returned string. The returned string does not contain the actual decimal point. A negative `int` value means that the decimal point is *decpt* number of spaces to the left of the returned digits (the spaces are filled with zeros). A 0 value means that the decimal point is immediately to the left of the first digit in the returned string.

sign

An integer value that indicates whether the *value* argument is positive or negative. If *value* is negative, the `fcvt` function places a nonzero value at the address specified by *sign*. Otherwise, the functions assign 0 to the address specified by *sign*.

Description

The `fcvt` function converts *value* to a null-terminated string and returns a pointer to it. The resulting low-order digit is rounded to the correct digit for outputting *ndigits* digits in C F-format. The *decpt* argument is assigned the position of the decimal point relative to the first character in the string.

In C F-format, *ndigits* is the number of digits desired after the decimal point. Very large numbers produce a very long string of digits before the decimal point, and *ndigit* of digits after the decimal point. For large numbers, it is preferable to use the `gcv` or `ecvt` function so that E-format is used.

Repeated calls to the `fcvt` function overwrite any existing string.

The `ecvt`, `fcvt`, and `gcv` functions represent the following special values specified in the IEEE Standard for floating-point arithmetic:

Value	Representation
Quiet NaN	NaNQ

fdim (*Integrity servers, Alpha*)

Determines the positive difference between its arguments.

Format

```
#include <math.h>
double fdim (double x, double y);
float fdimf (float x, float y);
long double fdiml (long double x, long double y);
```

Argument

x
A real value.

y
A real value.

Description

The `fdim` functions determine the positive difference between their arguments. If x is greater than y , $x - y$ is returned. If x is less than or equal to y , $+0$ is returned.

Return Values

<code>n</code>	Upon success, the positive difference value.
<code>HUGE_VAL</code>	If $x - y$ is positive and overflows; <code>errno</code> is set to <code>ERANGE</code> .
<code>0</code>	If $x - y$ is positive and underflows; <code>errno</code> is set to <code>ERANGE</code> .
<code>NaN</code>	x or y is <code>NaN</code> ; <code>errno</code> is set to <code>EDOM</code> .

fdopen

fdopen

Associates a file pointer with a file descriptor returned by an `open`, `creat`, `dup`, `dup2`, or `pipe` function.

Format

```
#include <stdio.h>
FILE *fdopen (int file_desc, char *a_mode);
```

Arguments

file_desc

The file descriptor returned by `open`, `creat`, `dup`, `dup2`, or `pipe`.

a_mode

The access mode indicator. See the `fopen` function for a description. Note that the access mode specified must agree with the mode used to originally open the file. This includes binary/text access mode ("b" mode on `fdopen` and the "ctx=bin" option on `creat` or `open`).

Description

The `fdopen` function allows you to access a file, originally opened by one of the UNIX I/O functions, with Standard I/O functions. Ordinarily, a file can be accessed by either a file descriptor or by a file pointer, but not both, depending on the way you open it. For more information, see Chapters 1 and 2.

Return Values

pointer	Indicates that the operation has succeeded.
NULL	Indicates that an error has occurred.

feof

Tests a file to see if the end-of-file has been reached.

Format

```
#include <stdio.h>
int feof (FILE *file_ptr);
```

Argument

file_ptr
A file pointer.

Return Values

nonzero integer
0

Indicates that the end-of-file has been reached.
Indicates that the end-of-file has not been reached.

feof_unlocked *(Integrity servers, Alpha)*

feof_unlocked *(Integrity servers, Alpha)*

Same as feof, except used only within a scope protected by flockfile and funlockfile.

Format

```
#include <stdio.h>
int feof_unlocked (FILE *file_ptr);
```

Argument

file_ptr
A file pointer.

Description

The reentrant version of the feof function is locked against multiple threads calling it simultaneously. This incurs overhead to ensure integrity of the stream. The unlocked version of this call, feof_unlocked can be used to avoid the overhead. The feof_unlocked function is functionally identical to the feof function, except that it is not required to be implemented in a thread-safe manner. The feof_unlocked function can be safely used only within a scope that is protected by the flockfile and funlockfile functions used as a pair. The caller must ensure that the stream is locked before feof_unlocked is used.

See also flockfile, ftrylockfile, and funlockfile.

Return Values

nonzero integer	Indicates end-of-file has been reached.
0	Indicates end-of-file has not been reached.

ferror

Returns a nonzero integer if an error occurred while reading or writing a file.

Format

```
#include <stdio.h>
int ferror (FILE *file_ptr);
```

Argument

file_ptr
A file pointer.

Description

A call to `ferror` continues to return a nonzero integer until the file is closed or until `clearerr` is called.

Return Values

0	Indicates success.
nonzero integer	Indicates that an error has occurred.

ferorr_unlocked *(Integrity servers, Alpha)*

ferorr_unlocked *(Integrity servers, Alpha)*

Same as `ferorr`, except used only within a scope protected by `flockfile` and `funlockfile`.

Format

```
#include <stdio.h>
int ferorr_unlocked (FILE *file_ptr);
```

Argument

file_ptr
A file pointer.

Description

The reentrant version of the `ferorr` function is locked against multiple threads calling it simultaneously. This incurs overhead to ensure integrity of the stream. The unlocked version of this call, `ferorr_unlocked` can be used to avoid the overhead. The `ferorr_unlocked` function is functionally identical to the `ferorr` function, except that it is not required to be implemented in a thread-safe manner. The `ferorr_unlocked` function can be safely used only within a scope that is protected by the `flockfile` and `funlockfile` functions used as a pair. The caller must ensure that the stream is locked before `ferorr_unlocked` is used.

See also `flockfile`, `ftrylockfile`, and `funlockfile`.

Return Values

0	Indicates success.
nonzero integer	Indicates that an error has occurred.

fflush

Writes out any buffered information for the specified file.

Format

```
#include <stdio.h>
int fflush (FILE *file_ptr);
```

Argument

file_ptr

A file pointer. If this argument is a NULL pointer, all buffers associated with all currently open files are flushed.

Description

The output files are normally buffered only if they are not directed to a terminal, except for stderr, which is not buffered by default.

The fflush function flushes the HP C RTL buffers. However, RMS has its own buffers. The fflush function does not guarantee that the file will be written to disk. (See the description of fsync for a way to flush buffers to disk.)

If the file pointed to by *file_ptr* was opened in record mode and if there is unwritten data in the buffer, then fflush always generates a record.

Return Values

0	Indicates that the operation is successful.
EOF	Indicates that the buffered data cannot be written to the file, or that the file control block is not associated with an output file.

ffs

ffs

Finds the index of the first bit set in a string.

Format

```
#include <strings.h>
int ffs (int iteger);
```

Argument

integer
The integer to be examined for the first bit set.

Description

The `ffs` function finds the first bit set (beginning with the least significant bit) and returns the index of that bit. Bits are numbered starting at 1 (the least significant bit).

Return Values

x	The index of the first bit set.
0	If <i>index</i> is 0.

fgetc

Returns the next character from a specified file.

Format

```
#include <stdio.h>
int fgetc (FILE *file_ptr);
```

Argument

file_ptr
A pointer to the file to be accessed.

Description

The `fgetc` function returns the next character from the specified file.

Compiling with the `__UNIX_PUTC` macro defined enables an optimization that uses a faster, inlined version of this function.

See also the `fgetc_unlocked` function and the `getc` macro.

Return Values

x	The returned character.
EOF	Indicates the end-of-file or an error.

fgetc_unlocked *(Integrity servers, Alpha)*

fgetc_unlocked *(Integrity servers, Alpha)*

Same as the `fgetc` function, except used only within a scope protected by `flockfile` and `funlockfile`.

Format

```
#include <stdio.h>
int fgetc_unlocked (FILE *file_ptr);
```

Argument

file_ptr
A file pointer.

Description

The reentrant version of the `fgetc` function is locked against multiple threads calling it simultaneously. This incurs overhead to ensure integrity of the stream. The unlocked version of this call, `fgetc_unlocked` can be used to avoid the overhead. The `fgetc_unlocked` function is functionally identical to the `fgetc` function, except that `fgetc_unlocked` can be safely used only within a scope that is protected by the `flockfile` and `funlockfile` functions used as a pair. The caller must ensure that the stream is locked before `fgetc_unlocked` is used.

Compiling with the `__UNIX_PUTC` macro defined enables an optimization that uses a faster, inlined version of this function.

See also `getc_unlocked`, `flockfile`, `ftrylockfile`, and `funlockfile`.

Return Values

<code>n</code>	The returned character.
<code>EOF</code>	Indicates the end-of-file or an error.

fgetname

Returns the file specification associated with a file pointer.

Format

```
#include <stdio.h>
char *fgetname (FILE *file_ptr, char *buffer, ... );
```

Function Variants

The `fgetname` function has variants named `_fgetname32` and `_fgetname64` for use with 32-bit and 64-bit pointer sizes, respectively. See Section 1.9 for more information on using pointer-size-specific functions.

Arguments

file_ptr

A file pointer.

buffer

A pointer to a character string that is large enough to hold the file specification.

...

An optional additional argument that can be either 1 or 0. If you specify 1, the `fgetname` function returns the file specification in OpenVMS format. If you specify 0, `fgetname` returns the file specification in UNIX style format. If you do not specify this argument, `fgetname` returns the filename according to your current command language interpreter. For more information about UNIX style file specifications, see Section 1.3.3.

Description

The `fgetname` function places the file specification at the address given in the buffer. The buffer should be an array large enough to contain a fully qualified file specification (the maximum length is 256 characters).

Return Values

n	The address of the buffer.
0	Indicates an error.

Restriction

The `fgetname` function is specific to the HP C RTL and is not portable.

fgetpos

fgetpos

Stores the current file position for a given file.

Format

```
#include <stdio.h>
int fgetpos (FILE *stream, fpos_t *pos);
```

Arguments

stream

A file pointer.

pos

A pointer to an implementation-defined structure. The `fgetpos` function fills this structure with information that can be used on subsequent calls to `fsetpos`.

Description

The `fgetpos` function stores the current value of the file position indicator for the stream pointed to by *stream* into the object pointed to by *pos*.

Return Values

0	Indicates successful completion.
-1	Indicates that there are errors.

Example

```
#include <stdio.h>
#include <stdlib.h>
main()
{
    FILE *fp;
    int stat,
        i;
    int character;
    char ch,
        c_ptr[130],
        d_ptr[130];
    fpos_t posit;
    /* Open a file for writing. */
    if ((fp = fopen("file.dat", "w+")) == NULL) {
        perror("open");
        exit(1);
    }
    /* Get the beginning position in the file. */
    if (fgetpos(fp, &posit) != 0)
        perror("fgetpos");
    /* Write some data to the file. */
    if (fprintf(fp, "this is a test\n") == 0) {
        perror("fprintf");
        exit(1);
    }
}
```



```
/* Set the file position back to the beginning. */
if (fsetpos(fp, &posit) != 0)
    perror("fsetpos");
fgets(c_ptr, 130, fp);
puts(c_ptr);      /* Should be "this is a test." */
/* Close the file. */
if (fclose(fp) != 0) {
    perror("close");
    exit(1);
}
}
```

fgets

fgets

Reads a line from the specified file, up to one less than the specified maximum number of characters or up to and including the new-line character, whichever comes first. The function stores the string in *str*.

Format

```
#include <stdio.h>

char *fgets (char *str, int maxchar, FILE *file_ptr);
```

Function Variants

The `fgets` function has variants named `_fgets32` and `_fgets64` for use with 32-bit and 64-bit pointer sizes, respectively. See Section 1.9 for more information on using pointer-size-specific functions.

Arguments

str

A pointer to a character string that is large enough to hold the information fetched from the file.

maxchar

The maximum number of characters to fetch.

file_ptr

A file pointer.

Description

The `fgets` function terminates the line with a null character (`\0`). Unlike `gets`, `fgets` places the new-line character that terminates the input line into the user buffer if more than *maxchar* characters have not already been fetched.

When the file pointed to by *file_ptr* is opened in record mode, `fgets` treats the end of a record the same as a new-line character, so it reads up to and including a new-line character or to the end of the record.

Return Values

x	Pointer to <i>str</i> .
NULL	Indicates the end-of-file or an error. The contents of <i>str</i> are undefined if a read error occurs.

Example

```
#include <stdio.h>
#include <stdlib.h>
#include <unistd.h>

main()
{
    FILE *fp;
    char c_ptr[130];
    /* Create a dummy data file */
```

```
if ((fp = fopen("file.dat", "w+")) == NULL) {
    perror("open");
    exit(1);
}
fprintf(fp, "this is a test\n") ;
fclose(fp) ;
/* Open a file with some data -"this is a test" */
if ((fp = fopen("file.dat", "r+")) == NULL) {
    perror("open error") ;
    exit(1);
}
fgets(c_ptr, 130, fp);
puts(c_ptr);      /* Display what fgets got. */
fclose(fp);
delete("file.dat") ;
}
```

fgetwc

fgetwc

Reads the next character from a specified file, and converts it to a wide-character code.

Format

```
#include <wchar.h>
wint_t fgetwc (FILE *file_ptr);
```

Argument

file_ptr
A pointer to the file to be accessed.

Description

Upon successful completion, the `fgetwc` function returns the wide-character code read from the file pointed to by `file_ptr` and converted to type `wint_t`. If the file is at end-of-file, the end-of-file indicator is set, and `WEOF` is returned. If an I/O read error occurred, then the error indicator is set, and `WEOF` is returned.

Applications can use `ferror` or `feof` to distinguish between an error condition and an end-of-file condition.

Return Values

<code>x</code>	The wide-character code of the character read.
<code>WEOF</code>	Indicates the end-of-file or an error. If a read error occurs, the function sets <code>errno</code> to one of the following: <ul style="list-style-type: none">• <code>EALREADY</code> – An operation is already in progress on the same file.• <code>EBADF</code> – The file descriptor is not valid.• <code>EILSEQ</code> – Invalid character detected.

fgetws

Reads a line of wide characters from a specified file.

Format

```
#include <wchar.h>
wchar_t *fgetws (wchar_t *wstr, int maxchar, FILE *file_ptr);
```

Function Variants

The `fgetws` function has variants named `_fgetws32` and `_fgetws64` for use with 32-bit and 64-bit pointer sizes, respectively. See Section 1.9 for more information on using pointer-size-specific functions.

Arguments

wstr

A pointer to a wide-character string large enough to hold the information fetched from the file.

maxchar

The maximum number of wide characters to fetch.

file_ptr

A file pointer.

Description

The `fgetws` function reads wide characters from the specified file and stores them in the array pointed to by `wstr`. The function reads up to `maxchar-1` characters or until the new-line character is read, converted, and transferred to `wstr`, or until an end-of-file condition is encountered. The function terminates the line with a null wide character. `fgetws` places the new-line that terminates the input line into the user buffer, unless `maxchar` characters have already been fetched.

Return Values

<code>x</code>	Pointer to <code>wstr</code> .
<code>NULL</code>	Indicates the end-of-file or an error. The contents of <code>wstr</code> are undefined if a read error occurs. If a read error occurs, the function sets <code>errno</code> . For a list of possible <code>errno</code> values, see <code>fgetwc</code> .

Example

```
#include <stdlib.h>
#include <stdio.h>
#include <locale.h>
#include <wchar.h>

main()
{
    wchar_t wstr[80],
            *ret;
    FILE *fp;
```

fgetws

```
/* Create a dummy data file */
if ((fp = fopen("file.dat", "w+")) == NULL) {
    perror("open");
    exit(1);
}
fprintf(fp, "this is a test\n");
fclose(fp);
/* Open a test file containing : "this is a test" */
if ((fp = fopen("file.dat", "r")) == (FILE *) NULL) {
    perror("File open error");
    exit(EXIT_FAILURE);
}
ret = fgetws(wstr, 80, fp);
if (ret == (wchar_t *) NULL) {
    perror("fgetws failure");
    exit(EXIT_FAILURE);
}
fputws(wstr, stdout);
fclose(fp);
delete("file.dat");
}
```

fileno

Returns the file descriptor associated with the specified file pointer.

Format

```
#include <stdio.h>
int fileno (FILE *file_ptr);
```

Argument

file_ptr
A file pointer.

Description

If you are using version 5.2 or lower of the C compiler, undefine the `fileno` macro:

```
#if defined(fileno)
#undef fileno
#endif
```

Return Values

x	Integer file descriptor.
-1	Indicates an error.

finite (*Integrity servers, Alpha*)

finite (*Integrity servers, Alpha*)

Returns the integer value 1 (TRUE) when its argument is a finite number, or 0 (FALSE) if not.

Format

```
#include <math.h>
int finite (double x);
int finitf (float x);
int double finitel (long double x);
```

Argument

x
A real value.

Description

The `finite` functions return 1 when $-\text{Infinity} < x < +\text{Infinity}$. They return 0 when $|x| = \text{Infinity}$, or x is a NaN.

flockfile *(Integrity servers, Alpha)*

Locks a stdio stream.

Format

```
#include <stdio.h>
void flockfile (FILE *file_ptr);
```

Argument

file_ptr
A file pointer.

Description

The flockfile function locks a stdio stream so that a thread can have exclusive use of that stream for multiple I/O operations. Use the flockfile function for a thread that wants to ensure that the output of several printf functions, for example, is not garbled by another thread also trying to use printf.

File pointers passed are assumed to be valid; flockfile will perform locking even on invalid file pointers. Also, the funlockfile function will not fail if the calling thread does not own a lock on the file pointer passed.

Matching flockfile and funlockfile calls can be nested. If the stream has been locked recursively, it will remain locked until the last matching funlockfile is called.

All C RTL file-pointer I/O functions lock their file pointers as if calling flockfile and funlockfile.

See also ftrylockfile and funlockfile.

fma (*Integrity servers, Alpha*)

Computes $(x * y) + z$, rounded as one ternary operation.

Format

```
#include <math.h>
double fma (double x, double y, double z);
float fmaf (float x, float y, float z);
long double fmal (long double x, long double y, long double z);
```

Argument

x,y,z
Real values.

Description

The `fma` functions compute $(x * y) + z$, rounded as one ternary operation: the value is computed as if to infinite precision and rounded once to the result format, according to the rounding mode characterized by the value of `FLT_ROUNDS`.

Return Values

n	Upon success, $(x * y) + z$, rounded as one ternary operation.
NaN	x or y is NaN; <code>errno</code> is set to <code>EDOM</code> .

fmax (*Integrity servers, Alpha*)

Returns the maximum numeric value of its arguments.

Format

```
#include <math.h>
double fmax (double x, double y);
float fmaxf (float x, float y);
long double fmaxl (long double x, long double y);
```

Argument

x
A real value.

y
A real value.

Description

The `fmax` functions determine the maximum numeric value of their arguments. NaN arguments are treated as missing data: if one argument is a NaN and the other numeric, then the numeric value is returned.

Return Values

n	Upon success, the maximum numeric value of the arguments. If just one argument is a NaN, the other argument is returned.
NaN	Both <i>x</i> and <i>y</i> are NaNs.

fmin (*Integrity servers, Alpha*)

Returns the minimum numeric value of its arguments.

Format

```
#include <math.h>
double fmin (double x, double y);
float fminf (float x, float y);
long double fminl (long double x, long double y);
```

Argument

x
A real value.

y
A real value.

Description

The `fmin` functions determine the minimum numeric value of their arguments. NaN arguments are treated as missing data: if one argument is a NaN and the other numeric, then the numeric value is returned.

Return Values

n	Upon success, the minimum numeric value of the arguments. If just one argument is a NaN, the other argument is returned.
NaN	Both <i>x</i> and <i>y</i> are NaNs.

fmod

fmod

Computes the floating-point remainder.

Format

```
#include <math.h>
double fmod (double x, double y);
float fmodf (float x, float y); (Integrity servers, Alpha)
long double fmodl (long double x, long double y); (Integrity servers, Alpha)
```

Arguments

x
A real value.

y
A real value.

Description

The fmod functions return the floating-point remainder of the first argument divided by the second. If the second argument is 0, the function returns 0.

Return Values

x	The value f , which has the same sign as the argument x , such that $x == i * y + f$ for some integer i , where the magnitude of f is less than the magnitude of y .
0	Indicates that y is 0.

fopen

Opens a file by returning the address of a FILE structure.

Format

```
#include <stdio.h>
```

```
FILE *fopen (const char *file_spec, const char *a_mode); (ANSI C)
```

```
FILE *fopen (const char *file_spec, const char *a_mode, ... ); (HP C Extension)
```

Arguments

file_spec

A character string containing a valid file specification.

a_mode

The access mode indicator. Use one of the following character strings: "r", "w", "a", "r+", "w+", "rb", "r+b", "rb+", "wb", "w+b", "wb+", "ab", "a+b", "ab+", or "a+".

These access modes have the following effects:

- "r" opens an existing file for reading.
- "w" creates a new file, if necessary, and opens the file for writing. If the file exists, it creates a new file with the same name and a higher version number.
- "a" opens the file for append access. An existing file is positioned at the end-of-file, and data is written there. If the file does not exist, the HP C RTL creates it.

The update access modes allow a file to be opened for both reading and writing. When used with existing files, "r+" and "a+" differ only in the initial positioning within the file. The modes are:

- "r+" opens an existing file for read update access. It is opened for reading, positioned first at the beginning-of-file, but writing is also allowed.
- "w+" opens a new file for write update access.
- "a+" opens a file for append update access. The file is first positioned at the end-of-file (writing). If the file does not exist, the HP C RTL creates it.
- "b" means binary access mode. In this case, no conversion of carriage-control information is attempted.

...

Optional file attribute arguments. The file attribute arguments are the same as those used in the creat function. For more information, see the creat function.

Description

If a version of the file exists, a new file created with fopen inherits certain attributes from the existing file unless those attributes are specified in the fopen call. The following attributes are inherited:

- Record format
- Maximum record size
- Carriage control

fopen

File protection

If you specify a directory in the filename and it is a search list that contains an error, HP C for OpenVMS Systems interprets it as a file open error.

The file control block can be freed with the `fclose` function, or by default on normal program termination.

Return Values

x

File pointer.

NULL

Indicates an error. The constant `NULL` is defined in the `<stdio.h>` header file to be the `NULL` pointer value. The function returns `NULL` to signal the following errors:

- File protection violations
- Attempts to open a nonexistent file for read access
- Failure to open the specified file

fpathconf

fpathconf

Retrieves file implementation characteristics.

Format

```
#include <unistd.h>
long int fpathconf (int filesdes, int name);
```

Arguments

filesdes

An open file descriptor.

name

The configuration attribute to query. If this attribute is not applicable to the file specified by the *filesdes* argument, `fpathconf` returns an error.

Description

The `fpathconf` function allows an application to retrieve the characteristics of operations supported by the file system underlying the filename by the *filesdes* argument. Read, write, or execute permission of the named file is not required, but you must be able to search all directories in the path leading to the file.

Symbolic values for the *name* argument are defined in the `<unistd.h>` header file as follows:

<code>_PC_LINK_MAX</code>	The maximum number of links to the file. If the <i>filesdes</i> argument refers to a directory, the value returned applies to the directory itself.
<code>_PC_MAX_CANON</code>	The maximum number of bytes in a canonical input line. This is applicable only to terminal devices.
<code>_PC_MAX_INPUT</code>	The number of types allowed in an input queue. This is applicable only to terminal devices.
<code>_PC_NAME_MAX</code>	Maximum number of bytes in a filename (not including a terminating null). The byte range value is between 13 and 255. This is applicable only to a directory file. The value returned applies to filenames within the directory.
<code>_PC_PATH_MAX</code>	Maximum number of bytes in a pathname (not including a terminating null). The value is never larger than 65,535. This is applicable only to a directory file. The value returned is the maximum length of a relative pathname when the specified directory is the working directory.
<code>_PC_PIPE_BUF</code>	Maximum number of bytes guaranteed to be written atomically. This is applicable only to a FIFO. The value returned applies to the referenced object. If the <i>path</i> argument refers to a directory, the value returned applies to any FIFO that exists or can be created within the directory.

<code>_PC_CHOWN_RESTRICTED</code>	The value returned applies to any files (other than directories) that exist or can be created within the directory. This is applicable only to a directory file.
<code>_PC_NO_TRUNC</code>	Returns 1 if supplying a component name longer than allowed by <code>NAME_MAX</code> causes an error. Returns 0 (zero) if long component names are truncated. This is applicable only to a directory file.
<code>_PC_VDISABLE</code>	This is always 0 (zero); no disabling character is defined. This is applicable only to a terminal device.

Return Values

<code>x</code>	The resultant value for the configuration attribute specified in the <i>name</i> argument.
<code>-1</code>	Indicates an error; <code>errno</code> is set to one of the following values: <ul style="list-style-type: none"> • <code>EINVAL</code> – The <i>name</i> argument specifies an unknown or inapplicable characteristic. • <code>EBADF</code> – the <i>filedes</i> argument is not a valid file descriptor.

fprintf

fprintf

Performs formatted output to a specified file.

Format

```
#include <stdio.h>
int fprintf (FILE *file_ptr, const char *format_spec, ... );
```

Arguments

file_ptr

A pointer to the file to which the output is directed.

format_spec

A pointer to a character string that contains the format specification. For more information on format specifications and conversion characters, see Chapter 2.

...

Optional expressions whose resultant types correspond to conversion specifications given in the format specification.

If no conversion specifications are given, the output sources can be omitted. Otherwise, the function calls must have exactly as many output sources as there are conversion specifications, and the conversion specifications must match the types of the output sources.

Conversion specifications are matched to output sources in left-to-right order. Any excess output sources are ignored.

Example

An example of a conversion specification follows:

```
#include <stdio.h>
main()
{
    int temp = 4, temp2 = 17;
    fprintf(stdout, "The answers are %d, and %d.", temp, temp2);
}
```

This example outputs the following to the stdout file:

```
The answers are 4, and 17.
```

For a complete description of the format specification and the output source, see Chapter 2.

Return Values

x	The number of bytes written, excluding the null terminator.
---	---

Negative value

Indicates an error. The function sets `errno` to one of the following:

- `EILSEQ` – Invalid character detected.
- `EINVAL` – Insufficient arguments.
- `ENOMEM` – Not enough memory available for conversion.
- `ERANGE` – Floating-point calculations overflow.
- `EVMSEERR` – Nontranslatable OpenVMS error. `vaxc$errno` contains the OpenVMS error code. This might indicate that conversion to a numeric value failed because of overflow.

The function can also set `errno` to the following as a result of errors returned from the I/O subsystem:

- `EBADF` – The file descriptor is not valid.
- `EIO` – I/O error.
- `ENOSPC` – No free space on the device containing the file.
- `ENXIO` – Device does not exist.
- `EPIPE` – Broken pipe.
- `ESPIPE` – Illegal seek in a file opened for append.
- `EVMSEERR` – Nontranslatable OpenVMS error. `vaxc$errno` contains the OpenVMS error code. This indicates that an I/O error occurred for which there is no equivalent C error code.

fputc

fputc

Writes a character to a specified file.

Format

```
#include <stdio.h>
int fputc (int character, FILE *file_ptr);
```

Arguments

character
An object of type int.

file_ptr
A file pointer.

Description

The `fputc` function writes a single character to the specified file and returns the character.

Compiling with the `__UNIX_PUTC` macro defined enables an optimization that uses a faster, inlined version of this function.

See also the `fputc_unlocked` function and the `putc` macro.

Return Values

x	The character written to the file. Indicates success.
EOF	Indicates an output error.

fputc_unlocked (*Integrity servers, Alpha*)

Same as the `fputc` function, except used only within a scope protected by `flockfile` and `funlockfile`.

Format

```
#include <stdio.h>
int fputc_unlocked (int character, FILE *file_ptr);
```

Arguments

character

The character to be written. An object of type `int`.

file_ptr

A file pointer.

Description

See the `putc_unlocked` macro.

Compiling with the `__UNIX_PUTC` macro defined enables an optimization that uses a faster, inlined version of this function.

See also `flockfile`, `ftrylockfile`, and `funlockfile`.

Return Values

<code>n</code>	The returned character.
<code>EOF</code>	Indicates the end-of-file or an error.

fputs

fputs

Writes a character string to a file without copying the string's null terminator (`\0`).

Format

```
#include <stdio.h>
int fputs (const char *str, FILE *file_ptr);
```

Arguments

str
A pointer to a character string.

file_ptr
A file pointer.

Description

Unlike `puts`, the `fputs` function does not append a new-line character to the output string.

See also `puts`.

Return Values

Nonnegative value	Indicates success.
EOF	Indicates an error.

fputc

Converts a wide character to its corresponding multibyte value, and writes the result to a specified file.

Format

```
#include <wchar.h>
wint_t fputc (wint_t wc, FILE *file_ptr);
```

Arguments

wc
An object of type `wint_t`.

file_ptr
A file pointer.

Description

The `fputc` function writes a wide character to a file and returns the character.

See also `putc`.

Return Values

x	The character written to the file. Indicates success.
---	---

fputc

WEOF

Indicates an output error. The function sets `errno` to the following:

- `EILSEQ` – Invalid wide-character code detected.

The function can also set `errno` to the following as a result of errors returned from the I/O subsystem:

- `EBADF` – The file descriptor is not valid.
- `EIO` – I/O error.
- `ENOSPC` – No free space on the device containing the file.
- `ENXIO` – Device does not exist.
- `EPIPE` – Broken pipe.
- `ESPIPE` – Illegal seek in a file opened for append.
- `EVMISERR` – Nontranslatable OpenVMS error. `vaxc$errno` contains the OpenVMS error code. This indicates that an I/O error occurred for which there is no equivalent C error code.

fputws

Writes a wide-character string to a file without copying the null-terminating character.

Format

```
#include <wchar.h>
int fputws (const wchar_t *wstr, FILE *file_ptr);
```

Arguments

wstr
A pointer to a wide-character string.

file_ptr
A file pointer.

Description

The `fputws` function converts the specified wide-character string to a multibyte character string and writes it to the specified file. The function does not append a terminating null byte corresponding to the null wide-character to the output string.

Return Values

Nonnegative value	Indicates success.
-1	Indicates an error. The function sets <code>errno</code> . For a list of the values, see <code>fputwc</code> .

fread

fread

Reads a specified number of items from the file.

Format

```
#include <stdio.h>
size_t fread (void *ptr, size_t size_of_item, size_t number_items, FILE *file_ptr);
```

Arguments

ptr

A pointer to the location, within memory, where you place the information being read. The type of the object pointed to is determined by the type of the item being read.

size_of_item

The size of the items being read, in bytes.

number_items

The number of items to be read.

file_ptr

A pointer that indicates the file from which the items are to be read.

Description

The type `size_t` is defined in the header file `<stdio.h>` as follows:

```
typedef unsigned int size_t
```

The reading begins at the current location in the file. The items read are placed in storage beginning at the location given by the first argument. You must also specify the size of an item, in bytes.

If the file pointed to by *file_ptr* was opened in record mode, `fread` will read *size_of_item* multiplied by *number_items* bytes from the file. That is, it does not necessarily read *number_items* records.

Return Values

n	The number of bytes read divided by <i>size_of_item</i> .
0	Indicates the end-of-file or an error.

free

Makes available for reallocation the area allocated by a previous `calloc`, `malloc`, or `realloc` call.

Format

```
#include <stdlib.h>
void free (void *ptr);
```

Argument**ptr**

The address returned by a previous call to `malloc`, `calloc`, or `realloc`. If *ptr* is a NULL pointer, no action occurs.

Description

The ANSI C standard defines `free` as not returning a value; therefore, the function prototype for `free` is declared with a return type of `void`. However, since a `free` can fail, and since previous versions of the HP C RTL have declared `free` to return an `int`, the implementation of `free` does return 0 on success and -1 on failure.

freopen

freopen

Substitutes the filename by a file specification for the open file addressed by a file pointer. The latter file is closed.

Format

```
#include <stdio.h>
```

```
FILE *freopen (const char *file_spec, const char *a_mode, FILE *file_ptr, ... );
```

Arguments

file_spec

A pointer to a string that contains a valid OpenVMS or UNIX style file specification. After the function call, the given file pointer is associated with this file.

a_mode

The access mode indicator. See the fopen function for a description.

file_ptr

A file pointer.

...

Optional file attribute arguments. The file attribute arguments are the same as those used in the creat function.

Description

The freopen function is typically used to associate one of the predefined names stdin, stdout, or stderr with a file. For more information about these predefined names, see Chapter 2.

Return Values

file_ptr	The file pointer, if freopen is successful.
NULL	Indicates an error.

frexp

Calculates the fractional and exponent parts of a floating-point value.

Format

```
#include <math.h>
double frexp (double value, int *ept);
float frexpf (float value, int *ept); (Integrity servers, Alpha)
long double frexpl (long double value, int *ept); (Integrity servers, Alpha)
```

Arguments

value

A floating-point number of type double, float, or long double.

ept

A pointer to an int where frexp places the exponent.

Description

The frexp functions break the floating-point number (*value*) into a normalized fraction and an integral power of 2, as follows:

$$\text{value} = \text{fraction} * (2^{\text{exp}})$$

The fractional part is returned as the return value. The exponent is placed in the integer variable pointed to by *ept*.

Example

```
#include <math.h>
main ()
{
    double val = 16.0, fraction;
    int exp;

    fraction = frexp(val, &exp);
    printf("fraction = %f\n", fraction);
    printf("exp = %d\n", exp);
}
```

In this example, frexp converts the value 16 to $.5 * 2^5$. The example produces the following output:

```
fraction = 0.500000
exp = 5
```

| *value* | = Infinity or NaN is an invalid argument.

frexp

Return Values

<i>x</i>	The fractional part of <i>value</i> .
0	Both parts of the result are 0.
NaN	If <i>value</i> is NaN, NaN is returned, <code>errno</code> is set to EDOM, and the value of <i>*eptr</i> is unspecified.
<i>value</i>	If $ value = \text{Infinity}$, <i>value</i> is returned, <code>errno</code> is set to EDOM, and the value of <i>*eptr</i> is unspecified.

fscanf

Performs formatted input from a specified file, interpreting it according to the format specification.

Format

```
#include <stdio.h>
int fscanf (FILE *file_ptr, const char *format_spec, ... );
```

Arguments

file_ptr

A pointer to the file that provides input text.

format_spec

A pointer to a character string that contains the format specification. For more information on conversion characters, see Chapter 2.

...

Optional expressions whose results correspond to conversion specifications given in the format specification.

If no conversion specifications are given, you can omit the input pointers. Otherwise, the function calls must have exactly as many input pointers as there are conversion specifications, and the conversion specifications must match the types of the input pointers.

Conversion specifications are matched to input sources in left-to-right order. Excess input pointers, if any, are ignored.

Description

An example of a conversion specification follows:

```
#include <stdio.h>
main ()
{
    int    temp, temp2;
    fscanf(stdin, "%d %d", &temp, &temp2);
    printf("The answers are %d, and %d.", temp, temp2);
}
```

Consider a file, designated by `stdin`, with the following contents:

```
4 17
```

The example conversion specification produces the following result:

```
The answers are 4, and 17.
```

For a complete description of the format specification and the input pointers, see Chapter 2.

fscanf

Return Values

- x
- The number of successfully matched and assigned input items.
- EOF
- Indicates that the end-of-file was encountered or a read error occurred. If a read error occurs, the function sets `errno` to one of the following:
- EILSEQ – Invalid character detected.
 - EVMSEERR – Nontranslatable OpenVMS error. `vaxc$errno` contains the OpenVMS error code. This can indicate that conversion to a numeric value failed due to overflow.
- The function can also set `errno` to the following as a result of errors returned from the I/O subsystem:
- EBADF – The file descriptor is not valid.
 - EIO – I/O error.
 - ENXIO – Device does not exist.
 - EPIPE – Broken pipe.
 - EVMSEERR – Nontranslatable OpenVMS error. `vaxc$errno` contains the OpenVMS error code. This indicates that an I/O error occurred for which there is no equivalent C error code.

fseek

Positions the file to the specified byte offset in the file.

Format

```
#include <stdio.h>
int fseek (FILE *file_ptr, long int offset, int direction);
```

Arguments

file_ptr

A file pointer.

offset

The offset, specified in bytes.

direction

An integer indicating the position to which the *offset* is added to calculate the new position. The new position is the beginning of the file if *direction* is `SEEK_SET`, the current value of the file position indicator if *direction* is `SEEK_CUR`, or end-of-file if *direction* is `SEEK_END`.

Description

The `fseek` function can position a fixed-length record-access file with no carriage control or a stream-access file on any byte offset, but can position all other files only on record boundaries.

The available Standard I/O functions position a variable-length or VFC record file at its first byte, at the end-of-file, or on a record boundary. Therefore, the arguments given to `fseek` must specify any of the following:

- The beginning or end of the file
- A 0 offset from the current position (an arbitrary record boundary)
- The position returned by a previous, valid `ftell` call

See the `fgetpos` and `fsetpos` functions for a portable way to seek to arbitrary locations with these types of record files.

CAUTION

If, while accessing a stream file, you seek beyond the end-of-file and then write to the file, the `fseek` function creates a hole by filling the skipped bytes with zeros.

In general, for record files, `fseek` should only be directed to an absolute position that was returned by a previous valid call to `ftell`, or to the beginning or end of a file. If a call to `fseek` does not satisfy these conditions, the results are unpredictable.

See also `open`, `creat`, `dup`, `dup2`, and `lseek`.

fseek

Return Values

0	Indicates successful seeks.
-1	Indicates improper seeks.

fseeko

Positions the file to the specified byte offset in the file. Equivalent to `fseek`.

Format

```
#include <stdio.h>

int fseeko (FILE *file_ptr, off_t offset, int direction);
```

Arguments

file_ptr

A file pointer.

offset

The offset, specified in bytes. The `off_t` data type is either a 32-bit or 64-bit integer. The 64-bit interface allows for file sizes greater than 2 GB, and can be selected at compile time by defining the `_LARGEFILE` feature-test macro as follows:

```
CC/DEFINE=_LARGEFILE
```

direction

An integer indicating the position to which the *offset* is added to calculate the new position. The new position is the beginning of the file if *direction* is `SEEK_SET`, the current value of the file position indicator if *direction* is `SEEK_CUR`, or end-of-file if *direction* is `SEEK_END`.

Description

The `fseeko` function is identical to the `fseek` function, except that the *offset* argument is of type `off_t` instead of `long int`.

fsetpos

fsetpos

Sets the file position indicator for a given file.

Format

```
#include <stdio.h>
int fsetpos (FILE *stream, const fpos_t *pos);
```

Arguments

stream

A file pointer.

pos

A pointer to an implementation-defined structure. The `fgetpos` function fills this structure with information that can be used on subsequent calls to `fsetpos`.

Description

Call the `fgetpos` function before using the `fsetpos` function.

Return Values

0	Indicates success.
-1	Indicates an error.

fstat

Accesses information about the file specified by the file descriptor.

Format

```
#include <stat.h>

int fstat (int file_desc, struct stat *buffer);
```

Function Variants

Compiling with the `_DECC_V4_SOURCE` and `_VMS_V6_SOURCE` feature-test macros defined enables a local-time-based entry point to the `fstat` function that is equivalent to the behavior before OpenVMS Version 7.0.

Arguments

file_desc

A file descriptor.

buffer

A pointer to a structure of type `stat_t`, which is defined in the `<stat.h>` header file. The argument receives information about that particular file. The members of the structure pointed to by *buffer* are:

Member	Type	Definition
<code>st_dev</code>	<code>dev_t</code>	Pointer to a physical device name
<code>st_ino[3]</code>	<code>ino_t</code>	Three words to receive the file ID
<code>st_mode</code>	<code>mode_t</code>	File “mode” (<code>prot</code> , <code>dir</code> , . . .)
<code>st_nlink</code>	<code>nlink_t</code>	For UNIX system compatibility only
<code>st_uid</code>	<code>uid_t</code>	Owner user ID
<code>st_gid</code>	<code>gid_t</code>	Group member: from <code>st_uid</code>
<code>st_rdev</code>	<code>dev_t</code>	UNIX system compatibility – always 0
<code>st_size</code>	<code>off_t</code>	File size, in bytes. For <code>st_size</code> to report a correct value, you need to flush both the C RTL and RMS buffers.
<code>st_atime</code>	<code>time_t</code>	File access time; always the same as <code>st_mtime</code>
<code>st_mtime</code>	<code>time_t</code>	Last modification time
<code>st_ctime</code>	<code>time_t</code>	File creation time
<code>st_fab_rfm</code>	<code>char</code>	Record format
<code>st_fab_rat</code>	<code>char</code>	Record attributes
<code>st_fab_fsz</code>	<code>char</code>	Fixed header size
<code>st_fab_mrs</code>	<code>unsigned</code>	Record size

The types `dev_t`, `ino_t`, `off_t`, `mode_t`, `nlink_t`, `uid_t`, `gid_t`, and `time_t`, are defined in the `<stat.h>` header file. However, when compiling for compatibility (`/DEFINE=_DECC_V4_SOURCE`), only `dev_t`, `ino_t`, and `off_t` are defined.

fstat

The `off_t` data type is either a 32-bit or 64-bit integer. The 64-bit interface allows for file sizes greater than 2 GB, and can be selected at compile time by defining the `_LARGEFILE` feature-test macro as follows:

```
CC/DEFINE=_LARGEFILE
```

As of OpenVMS Version 7.0, times are given in seconds since the Epoch (00:00:00 GMT, January 1, 1970).

The `st_mode` structure member is the status information mode and is defined in the `<stat.h>` header file. The `st_mode` bits follow:

Bits	Constant	Definition
0170000	S_IFMT	Type of file
0040000	S_IFDIR	Directory
0020000	S_IFCHR	Character special
0060000	S_IFBLK	Block special
0100000	S_IFREG	Regular
0030000	S_IFMPC	Multiplexed char special
0070000	S_IFMPB	Multiplexed block special
0004000	S_ISUID	Set user ID on execution
0002000	S_ISGID	Set group ID on execution
0001000	S_ISVTX	Save swapped text even after use
0000400	S_IREAD	Read permission, owner
0000200	S_IWRITE	Write permission, owner
0000100	S_IEXEC	Execute/search permission, owner

Description

The `fstat` function does not work on remote network files.

Be aware that for the `stat_t` structure member `st_size` to report a correct value, you need to flush both the C RTL and RMS buffers.

Note *(Integrity servers, Alpha)*

On OpenVMS Alpha and Integrity server systems, the `stat`, `fstat`, `utime`, and `utimes` functions have been enhanced to take advantage of the new file-system support for POSIX compliant file timestamps.

This support is available only on ODS-5 devices on OpenVMS Alpha and Integrity servers systems beginning with a version of OpenVMS Alpha after Version 7.3.

Before this change, the `stat` and `fstat` functions were setting the values of the `st_ctime`, `st_mtime`, and `st_atime` fields based on the following file attributes:

`st_ctime` - `ATR$C_CREDATE` (file creation time)
`st_mtime` - `ATR$C_REVDATE` (file revision time)

st_atime - was always set to st_mtime because no support for file access time was available

Also, for the file-modification time, utime and utimes were modifying the ATR\$C_REVDATE file attribute, and ignoring the file-access-time argument.

After the change, for a file on an ODS-5 device, the stat and fstat functions set the values of the st_ctime, st_mtime, and st_atime fields based on the following new file attributes:

st_ctime - ATR\$C_ATTDATE (last attribute modification time)
 st_mtime - ATR\$C_MODDATE (last data modification time)
 st_atime - ATR\$C_ACCDATE (last access time)

If ATR\$C_ACCDATE is zero, as on an ODS-2 device, the stat and fstat functions set st_atime to st_mtime.

For the file-modification time, the utime and utimes functions modify both the ATR\$C_REVDATE and ATR\$C_MODDATE file attributes. For the file-access time, these functions modify the ATR\$C_ACCDATE file attribute. Setting the ATR\$C_MODDATE and ATR\$C_ACCDATE file attributes on an ODS-2 device has no effect.

For compatibility, the old behavior of stat, fstat, utime, and utimes remains the default, regardless of the kind of device.

The new behavior must be explicitly enabled at run time by defining the DECC\$EFS_FILE_TIMESTAMP logical name to "ENABLE" before invoking the application. Setting this logical does not affect the behavior of stat, fstat, utime and utimes for files on an ODS-2 device.

Return Values

0	Indicates successful completion.
-1	Indicates an error other than a protection violation.
-2	Indicates a protection violation.

fstatvfs (*Integrity servers, Alpha*)

Gets information about a device containing the specified file.

Format

```
#include <statvfs.h>
int fstatvfs (int filedes, struct statvfs *buffer);
```

Arguments

filedes

File descriptor obtained from a successful open or fcntl function call.

buffer

Pointer to a statvfs structure to hold the returned information.

Description

The fstatvfs function returns descriptive information about the device containing the specified file. Read, write, or execute permission of the specified file is not required. The returned information is in the format of a statvfs structure, which is defined in the <statvfs.h> header file and contains the following members:

unsigned long f_bsize - Preferred block size.

unsigned long f_frsize - Fundamental block size.

fsblkcnt_t f_blocks - Total number of blocks in units of f_frsize.

fsblkcnt_t f_bfree - Total number of free blocks. If f_bfree would assume a meaningless value due to the misreporting of free block count by \$GETDVI for a DFS disk, then f_bfree is set to the maximum block count.

fsblkcnt_t f_bavail - Number of free blocks available. Set to the unused portion of the caller's disk quota.

fsfilcnt_t f_files - Total file (inode) count.

fsfilcnt_t f_ffree - Free file (inode) count. For OpenVMS systems, this value is calculated as freeblocks/clustersize.

fsfilcnt_t f_favail - Free file (inode) count nonprivileged. Set to f_ffree.

unsigned long f_fsid - File system identifier. This identifier is based on the allocation-class device name. This gives a unique value based on device, as long as the device is locally mounted.

unsigned long f_flag - Bit mask representing one or more of the following flags:

ST_RDONLY - The volume is read-only.

ST_NOSUID - The volume has protected subsystems enabled.

unsigned long `f_namemax` - Maximum length of a filename.
char `f_basetype[64]` - Device-type name.
char `f_fstr[64]` - Logical volume name.
char `__reserved[64]` - Media type name.

Upon successful completion, `fstatvfs` returns 0 (zero). Otherwise, it returns `-1` and sets `errno` to indicate the error.

See also `statvfs`.

Return Value

0	Successful completion.
-1	Indicates an error. <code>errno</code> is set to one of the following: <ul style="list-style-type: none">• <code>EBADF</code> - The file descriptor parameter contains an invalid value.• <code>EIO</code> - An I/O error occurred while reading the device.• <code>EINTR</code> - A signal was intercepted during execution of the function.• <code>EOVERFLOW</code> - One of the values to be returned cannot be represented correctly in the structure pointed to by <i>buffer</i>.

fsync

fsync

Flushes data all the way to the disk.

Format

```
#include <unistd.h>
int fsync (int fd);
```

Argument

fd
A file descriptor corresponding to an open file.

Description

The `fsync` function behaves much like the `fflush` function. The primary difference between the two is that `fsync` flushes data all the way to the disk while `fflush` flushes data only as far as the underlying RMS buffers. Also, with `fflush`, you can flush all buffers at once; with `fsync` you cannot.

Return Values

0	Indicates successful completion.
-1	Indicates an error.

ftell

Returns the current byte offset to the specified stream file.

Format

```
#include <stdio.h>
long int ftell (FILE *file_ptr);
```

Argument

file_ptr
A file pointer.

Description

The `ftell` function measures the byte offset from the beginning of the file.

For variable-length files, VFC files, or any file with carriage-control attributes, if the file is opened in record mode, then `ftell` returns the starting position of the current record, not the current byte offset.

When using record files, the `ftell` function ignores any characters that have been pushed back using either `ungetc` or `ungetwc`. This behavior does not occur if stream files are being used.

For a portable way to measure the exact offset for any type of file, see the `fgetpos` function.

Return Values

<code>n</code>	The current offset.
<code>EOF</code>	Indicates an error.

ftello

ftello

Returns the current byte offset to the specified stream file. This function is equivalent to `ftell`.

Format

```
#include <stdio.h>
off_t ftello (FILE *file_ptr);
```

Argument

file_ptr
A file pointer.

Description

The `ftello` function is identical to the `ftell` function, except that the return value is of type `off_t` instead of `long int`.

The `off_t` data type is either a 64-bit or 32-bit integer. The 64-bit interface allows for file sizes greater than 2 GB, and can be selected at compile time by defining the `_LARGEFILE` feature-test macro as follows:

```
CC/DEFINE=_LARGEFILE
```

ftime

Returns the elapsed time since 00:00:00, January 1, 1970, in the structure pointed at by *timeptr*.

Format

```
#include <timeb.h>

int ftime (struct timeb *timeptr);
```

Function Variants

Compiling with the `_DECC_V4_SOURCE` and `_VMS_V6_SOURCE` feature-test macros defined enables a local-time-based entry point to the `ftime` function that is equivalent to the behavior before OpenVMS Version 7.0.

Argument

timeptr

A pointer to the structure `timeb_t`.

Description

The typedef `timeb_t` refers to the following structure defined in the `<timeb.h>` header file:

```
typedef struct timeb
{
    time_t      time;
    unsigned short millitm;
    short       timezone;
    short       dstflag;
};
```

The member `time` gives the time in seconds.

The member `millitm` gives the fractional time in milliseconds.

After a call to `ftime`, the `timezone` and `dstflag` members of the `timeb` structure have the values of the global variables `timezone` and `dstflag`, respectively. See the description of the `tzset` function for `timezone` and `dstflag` global variables.

Return Values

0	Successful execution. The <code>timeb_t</code> structure is filled in.
-1	Indicates an error. Failure might indicate that the system's time-differential factor (that is, the difference between the system time and UTC time) is not set correctly. If the value of the <code>SYS\$TIMEZONE_DIFFERENTIAL</code> logical is wrong, the function fails with <code>errno</code> set to <code>EINVAL</code> .

ftok (*Integrity servers, Alpha*)

Generates a standard interprocess communication key that is usable in subsequent calls to `semget`.

Format

```
#include <ipc.h>
key_t ftok (const char *path_name, int project_id);
```

Argument

path_name

the pathname of an existing file that is accessible to the process.

project_id

a value that uniquely identifies a project.

Description

The `ftok` function returns a key, based on the *path_name* and *project_id* parameters, that is usable in subsequent calls to the `semget` function. The `ftok` function returns the same key for all paths that name the same file, when called with the same *project_id* parameter. Different keys are returned for the same file if different *project_id* parameters are used, or if paths are used that name different files existing on the same file system at the same time. If a file named by *path_name* is removed and recreated with the same name, the `ftok` function may return a different key than the original one.

Only the low order 8 bits of *project_id* are significant. The behavior of `ftok` is unspecified if these bits are 0.

For maximum portability, *project_id* must be a single-byte character.

Upon successful completion, the `ftok` function returns a key. Otherwise, it returns the value `(key_t)-1` and sets `errno` to indicate the error.

Return Values

<code>n</code>	Upon successful completion, the <code>ftok</code> function returns a key.
<code>(key_t)-1</code>	Indicates an error. The function sets <code>errno</code> to: <ul style="list-style-type: none">• <code>EACCESS</code> – Search permission is denied for a component of the <i>path_name</i> parameter.

ftruncate

Truncates a file to a specified length.

Format

```
#include <unistd.h>
int ftruncate (int filedes, off_t length);
```

Arguments

filedes

The descriptor of a file that must be open for writing.

length

The new length of the file, in bytes. The `off_t` data type is either a 32-bit or 64-bit integer. The 64-bit interface allows for file sizes greater than 2 GB, and can be selected at compile time by defining the `_LARGEFILE` feature-test macro as follows:

```
CC/DEFINE=_LARGEFILE
```

Description

The `ftruncate` function truncates a file at the specified position. For record files, the position must be a record boundary. Also, the files must be local, regular files.

If the file was previously larger than *length*, extra data is lost. If the file was previously shorter than *length*, bytes between the old and new lengths are read as zeros.

Return Values

0	Indicates success.
-1	An error occurred; <code>errno</code> is set to indicate the error.

ftrylockfile *(Integrity servers, Alpha)*

ftrylockfile *(Integrity servers, Alpha)*

Acquires ownership of a `stdio (FILE*)` object.

Format

```
#include <stdio.h>
int ftrylockfile (FILE *file_ptr);
```

Argument

file_ptr
A file pointer.

Description

The `ftrylockfile` function is used by a thread to acquire ownership of a `stdio (FILE*)` object, if the object is available. The `ftrylockfile` function is a non-blocking version of `flockfile`.

The `ftrylockfile` function returns zero for success and nonzero to indicate that the lock cannot be acquired.

See also `flockfile` and `funlockfile`.

Return Values

0	Indicates success.
nonzero	Indicates the lock cannot be acquired.

ftw

Walks a file tree.

Format

```
#include <ftw.h>

int ftw (const char *path, int(*function)(const char *, const struct stat *, int), int depth);
```

Arguments

path

The directory hierarchy to be searched.

function

The function to be invoked for each file in the directory hierarchy.

depth

The maximum number of directory streams or file descriptors, or both, available for use by `ftw`. This argument should be in the range of 1 to `OPEN_MAX`.

Description

The `ftw` function recursively searches the directory hierarchy that descends from the directory specified by the `path` argument. The `path` argument can be specified in OpenVMS style or UNIX style.

For each file in the hierarchy, `ftw` calls the function specified by the `function` argument, passes it a pointer to a null-terminated character string containing the name of the file, a pointer to a `stat` structure containing information about the file, and an integer.

The integer identifies the file type. Possible values, defined in `<ftw.h>` are:

<code>FTW_F</code>	Regular file.
<code>FTW_D</code>	Directory.
<code>FTW_DNR</code>	Directory that cannot be read.
<code>FTW_NS</code>	A file on which <code>stat</code> could not successfully be executed.

If the integer is `FTW_DNR`, then the files and subdirectories contained in that directory are not processed.

If the integer is `FTW_NS`, then the `stat` structure contents are meaningless. For example, a file in a directory for which you have read permission but not execute (search) permission can cause the `function` argument to pass `FTW_NS`.

The `ftw` function finishes processing a directory before processing any of its files or subdirectories.

The `ftw` function continues the search until:

- The directory hierarchy specified by the `path` argument is completed.
- An invocation of the function specified by the `function` argument returns a nonzero value.
- An error (such as an I/O error) is detected within the `ftw` function.

ftw

Because the `ftw` function is recursive, it is possible for it to terminate with a memory fault because of stack overflow when applied to very deep file structures.

The `ftw` function uses the `malloc` function to allocate dynamic storage during its operation. If `ftw` is forcibly terminated, as with a call to `longjmp` from the function pointed to by the *function* argument, `ftw` has no chance to free that storage. It remains allocated.

A safe way to handle interrupts is to store the fact that an interrupt has occurred, and arrange to have the function specified by the *function* argument return a nonzero value the next time it is called.

Notes

- The `ftw` function is reentrant; make sure that the function supplied as argument function is also reentrant.
 - The C RTL supports a standard-compliant definition of the `stat` structure and associated definitions. To use them, compile your application with the `_USE_STD_STAT` feature-test macro defined. See the `<stat.h>` header file on your system for more information.
 - The `ftw` function supports UNIX style path name specifications. For more information about UNIX style directory specifications, see Section 1.3.3.
-

See also `malloc`, `longjump`, and `stat`.

Return Values

0	Indicates success.
x	Indicates that the function specified by the <i>function</i> argument stops its search, and returns the value that was returned by the function.

-1

Indicates an error; `errno` is set to one of the following values:

- `EACCES` – Search permission is denied for any component of the *path* argument or read permission is denied for the *path* argument.
- `ENAMETOOLONG` – The length of the path string exceeds `PATH_MAX`, or a pathname component is longer than `NAME_MAX` while `[_POSIX_NO_TRUNC]` is in effect.
- `ENOENT` – The *path* argument points to the name of a file that does not exist or points to an empty string.
- `ENOMEM` – There is insufficient memory for this operation.

Also, if the function pointed to by the *function* argument encounters an error, `errno` can be set accordingly.

funlockfile *(Integrity servers, Alpha)*

funlockfile *(Integrity servers, Alpha)*

Unlocks a stdio stream.

Format

```
#include <stdio.h>
void funlockfile (FILE *file_ptr);
```

Argument

file_ptr
A file pointer.

Description

The `funlockfile` function unlocks a stdio stream, causing the thread that had been holding the lock to relinquish exclusive use of the stream.

File pointers passed are assumed to be valid; `flockfile` will perform locking even on invalid file pointers. Also, the `funlockfile` function will not fail if the calling thread does not own a lock on the file pointer passed.

Matching `flockfile` and `funlockfile` calls can be nested. If the stream has been locked recursively, it will remain locked until the last matching `funlockfile` is called.

All C RTL file-pointer I/O functions lock their file pointers as if calling `flockfile` and `funlockfile`.

See also `flockfile` and `ftrylockfile`.

fwait

Waits for I/O on a specific file to complete.

Format

```
#include <stdio.h>
int fwait (FILE *fp);
```

Argument

fp
A file pointer corresponding to an open file.

Description

The `fwait` function is used primarily to wait for completion of pending asynchronous I/O.

Return Values

0	Indicates successful completion.
-1	Indicates an error.

fwide

fwide

Determines and sets the orientation of a stream.

Format

```
#include <wchar.h>
int fwide (FILE *stream, int mode);
```

Arguments

stream

A file pointer.

mode

A value that specifies the desired orientation of the stream.

Description

The `fwide` function determines the orientation of the stream pointed to by *stream* and sets the orientation of a nonoriented stream according to the *mode* argument in the following way:

If the <i>mode</i> argument is:	Then the <i>fwide</i> function:
greater than zero	makes the stream wide-oriented.
less than zero	makes the stream byte-oriented.
zero	does not alter the orientation of the stream.

If the orientation of the stream has already been set, `fwide` does not alter it. Because no error status is defined for `fwide`, the calling application should check `errno` if `fwide` returns a 0.

Return Values

> 0	After the call, the stream is wide-oriented.
< 0	After the call, the stream is byte-oriented.
0	After the call, the stream has no orientation or a stream argument is invalid; the function sets <code>errno</code> .

fwprintf

Negative value

Indicates an error. The function sets `errno` to one of the following:

- `EILSEQ` – Invalid character detected.
- `EINVAL` – Insufficient arguments.
- `ENOMEM` – Not enough memory available for conversion.
- `ERANGE` – Floating-point calculations overflow.
- `EVMSEERR` – Nontranslatable OpenVMS error. `vaxc$errno` contains the OpenVMS error code. This might indicate that conversion to a numeric value failed because of overflow.

The function can also set `errno` to the following as a result of errors returned from the I/O subsystem:

- `EBADF` – The file descriptor is not valid.
- `EIO` – I/O error.
- `ENOSPC` – No free space on the device containing the file.
- `ENXIO` – Device does not exist.
- `EPIPE` – Broken pipe.
- `ESPIPE` – Illegal seek in a file opened for append.
- `EVMSEERR` – Nontranslatable OpenVMS error. `vaxc$errno` contains the OpenVMS error code. This indicates that an I/O error occurred for which there is no equivalent C error code.

Example

The following example shows how to print a date and time in the form "Sunday, July 3, 10:02", followed by π to five decimal places:

```
#include <math.h>
#include <stdio.h>
#include <wchar.h>
/* . . . */
wchar_t *weekday, *month; /* pointers to wide-character strings */
int day, hours, min;
fwprintf(stdout, L"%ls, %ls %d, %.2d:%.2d\n",
         weekday, month, day, hour, min);
fwprintf(stdout, L"pi = %.5f\n", 4 * atan(1.0));
```

fwrite

Writes a specified number of items to the file.

Format

```
#include <stdio.h>
size_t fwrite (const void *ptr, size_t size_of_item, size_t number_items, FILE *file_ptr);
```

Arguments

ptr

A pointer to the memory location from which information is being written. The type of the object pointed to is determined by the type of the item being written.

size_of_item

The size, in bytes, of the items being written.

number_items

The number of items to be written.

file_ptr

A file pointer that indicates the file to which the items are being written.

Description

The type `size_t` is defined in the header file `<stdio.h>` as follows:

```
typedef unsigned int size_t
```

The writing begins at the current location in the file. The items are written from storage beginning at the location given by the first argument. You must also specify the size of an item, in bytes.

If the file pointed to by *file_ptr* is a record file, the `fwrite` function outputs at least *number_items* records, each of length *size_of_item*.

Return Value

x	The number of items written. The number of records written depends upon the maximum record size of the file.
---	--

fwscanf

fwscanf

Reads input from the stream under control of the wide-character format string.

Format

```
#include <wchar.h>
int fwscanf (FILE *stream, const wchar_t *format, ... );
```

Arguments

stream

A file pointer.

format

A pointer to a wide-character string containing the format specification. For more information about format and conversion specifications and their corresponding arguments, see Chapter 2.

...

Optional expressions whose results correspond to conversion specifications given in the format specification. For more information about format and conversion specifications and their corresponding arguments, see Chapter 2.

If no conversion specifications are given, you can omit the input pointers. Otherwise, the function calls must have exactly as many input pointers as there are conversion specifications, and the conversion specifications must match the types of the input pointers.

Conversion specifications are matched to input sources in left-to-right order. Excess input pointers, if any, are ignored.

Description

The `fwscanf` function reads input from the stream pointed to by *stream* under the control of the wide-character string pointed to by *format*. If there are insufficient arguments for the format, the behavior is undefined. If the format is exhausted while arguments remain, the excess arguments are evaluated, but otherwise ignored.

The format is composed of zero or more directives that include:

- One or more white-space wide characters.
- An ordinary wide character (neither a percent (`%`)) nor a white-space wide character).
- Conversion specifications.

Each conversion specification is introduced by the wide character `%`.

If the stream pointed to by the stream argument has no orientation, `fwscanf` makes the stream wide-oriented.

Return Values

n	The number of input items assigned, sometimes fewer than provided for, or even zero, in the event of an early matching failure.
EOF	Indicates an error; input failure occurs before any conversion.

gcvt

gcvt

Converts its argument to a null-terminated string of ASCII digits and returns the address of the string.

Format

```
#include <stdlib.h>

char *gcvt (double value, int ndigit, char *buffer);
```

Function Variants

The `gcvt` function has variants named `_gcvt32` and `_gcvt64` for use with 32-bit and 64-bit pointer sizes, respectively. See Section 1.9 for more information on using pointer-size-specific functions.

Arguments

value

An object of type `double` that is converted to a null-terminated string of ASCII digits.

ndigit

The number of ASCII digits to use in the converted string. If `ndigit` is less than 6, the value of 6 is used.

buffer

A storage location to hold the converted string.

Description

The `gcvt` function places the converted string in a buffer and returns the address of the buffer. If possible, `gcvt` produces `ndigit` significant digits in F-format, or if not possible, in E-format. Trailing zeros are suppressed.

The `ecvt`, `fcvt`, and `gcvt` functions represent the following special values specified in the IEEE Standard for floating-point arithmetic:

Value	Representation
Quiet NaN	NaNQ
Signalling NaN	NaNS
+Infinity	Infinity
-Infinity	-Infinity

The sign associated with each of these values is stored into the `sign` argument. In IEEE floating-point representation, a value of 0 (zero) can be positive or negative, as set by the `sign` argument.

See also `fcvt` and `ecvt`.

Return Value

x

The address of the buffer.

getc

getc

Returns the next character from a specified file.

Format

```
#include <stdio.h>
int getc (FILE *file_ptr);
```

Argument

file_ptr
A pointer to the file to be accessed.

Description

The `getc` macro returns the next byte from the input stream specified by the *file_ptr* parameter and moves the file pointer, if defined, ahead one byte in the input stream.

Since `getc` is a macro, a file pointer argument with side effects (for example, `getc (*f++)`) might be evaluated incorrectly. In such a case, use the `fgetc` function instead. See the `fgetc` function.

See also `getc_unlocked`.

Return Values

<code>n</code>	The returned character.
<code>EOF</code>	Indicates the end-of-file or an error.

getc_unlocked *(Integrity servers, Alpha)*

Same as `getc`, except used only within a scope protected by `flockfile` and `funlockfile`.

Format

```
#include <stdio.h>
int getc_unlocked (FILE *file_ptr);
```

Argument

file_ptr
A file pointer.

Description

The reentrant version of the `getc` macro is locked against multiple threads calling it simultaneously. This incurs overhead to ensure integrity of the stream. The unlocked version of this call, `getc_unlocked` can be used to avoid the overhead. The `getc_unlocked` macro is functionally identical to the `getc` macro, except that it is not required to be implemented in a thread-safe manner. The `getc_unlocked` macro can be safely used only within a scope that is protected by the `flockfile` and `funlockfile` functions used as a pair. The caller must ensure that the stream is locked before `getc_unlocked` is used.

Since `getc_unlocked` is a macro, a file pointer argument with side effects might be evaluated incorrectly. In such a case, use the `fgetc_unlocked` function instead.

See also `flockfile`, `ftrylockfile`, and `funlockfile`.

Return Values

<code>n</code>	The returned character.
<code>EOF</code>	Indicates the end-of-file or an error.

[w]getch

[w]getch

Get a character from the terminal screen and echo it on the specified window. The getch function echoes the character on the stdscr window.

Format

```
#include <curses.h>
char getch();
char wgetch (WINDOW *win);
```

Argument

win
A pointer to the window.

Description

The getch and wgetch functions refresh the specified window before fetching a character. For more information, see the scrolllok function.

Return Values

x	The returned character.
ERR	Indicates that the function makes the screen scroll illegally.

getchar

Reads a single character from the standard input (stdin).

Format

```
#include <stdio.h>
int getchar (void);
```

Description

The `getchar` function is identical to `fgetc(stdin)`.

See also `getchar_unlocked`.

Return Values

x	The next character from <code>stdin</code> , converted to <code>int</code> .
EOF	Indicates the end-of-file or an error.

getchar_unlocked *(Integrity servers, Alpha)*

getchar_unlocked *(Integrity servers, Alpha)*

Same as `getchar`, except used only within a scope protected by `flockfile` and `funlockfile`.

Format

```
#include <stdio.h>

int getchar_unlocked (void);
```

Description

The reentrant version of the `getchar` function is locked against multiple threads calling it simultaneously. This incurs overhead to ensure integrity of the input stream. The unlocked version of this call, `getchar_unlocked` can be used to avoid the overhead. The `getchar_unlocked` function is functionally identical to the `getchar` function, except that it is not required to be implemented in a thread-safe manner. The `getchar_unlocked` function can be safely used only within a scope that is protected by the `flockfile` and `funlockfile` functions used as a pair. The caller must ensure that the stream is locked before `getchar_unlocked` is used.

See also `flockfile`, `ftrylockfile`, and `funlockfile`.

Return Values

<code>x</code>	The next character from <code>stdin</code> , converted to <code>int</code> .
<code>EOF</code>	Indicates the end-of-file or an error.

getclock

Gets the current value of the systemwide clock.

Format

```
#include <timers.h>

int getclock (int clktyp, struct timespec *tp);
```

Arguments

clktyp

The type of systemwide clock.

tp

Pointer to a `timespec` structure space where the current value of the systemwide clock is stored.

Description

The `getclock` function sets the current value of the clock specified by *clktyp* into the location pointed to by *tp*.

The *clktyp* argument is given as a symbolic constant name, as defined in the `<timers.h>` header file. Only the `TIMEOFDAY` symbolic constant, which specifies the normal time-of-day clock to access for systemwide time, is supported.

For the clock specified by `TIMEOFDAY`, the value returned by this function is the elapsed time since the Epoch. The Epoch is referenced to 00:00:00 UTC (Coordinated Universal Time) 1 Jan 1970.

The `getclock` function returns a `timespec` structure, which is defined in the `<timers.h>` header file as follows:

```
struct timespec {
    unsigned long tv_sec /* Elapsed time in seconds since the Epoch*/
    long tv_nsec /* Elapsed time as a fraction of a second */
                /* since the Epoch (in nanoseconds) */
};
```

Return Values

- | | |
|----|--|
| 0 | Indicates success. |
| -1 | Indicates an error; <code>errno</code> is set to one of the following values: <ul style="list-style-type: none"> • <code>EINVAL</code> – The <i>clktyp</i> argument does not specify a known systemwide clock. Or, the value of <code>SYS\$TIMEZONE_DIFFERENTIAL</code> logical is wrong. • <code>EIO</code> – An error occurred when the systemwide clock specified by the <i>clktyp</i> argument was accessed. |

getcwd

getcwd

Returns a pointer to the file specification for the current working directory.

Format

```
#include <unistd.h>
```

```
char *getcwd (char *buffer, size_t size); (ISO POSIX-1)
```

```
char *getcwd (char *buffer, unsigned int size, . . . ); (HP C Extension)
```

Function Variants

The `getcwd` function has variants named `_getcwd32` and `_getcwd64` for use with 32-bit and 64-bit pointer sizes, respectively. See Section 1.9 for more information on using pointer-size-specific functions.

Arguments

buffer

Pointer to a character string large enough to hold the directory specification.

If *buffer* is a NULL pointer, `getcwd` obtains *size* bytes of space using `malloc`. In this case, you can use the pointer returned by `getcwd` as the argument in a subsequent call to `free`.

size

The length of the directory specification to be returned.

. . .

An optional argument that can be either 1 or 0. If you specify 1, the directory specification is returned in OpenVMS format. If you specify 0, the directory specification (pathname) is returned in UNIX style format. If you omit this argument, `getcwd` returns the filename according to your current command-language interpreter (CLI). For more information about UNIX style directory specifications, see Section 1.3.3.

Return Values

x	A pointer to the file specification.
NULL	Indicates an error.

getdtablesize

Gets the total number of file descriptors that a process can have open simultaneously.

Format

```
#include <unistd.h>
int getdtablesize (void);
```

Description

The `getdtablesize` function returns the total number of file descriptors that a process can have open simultaneously. Each process is limited to a fixed number of open file descriptors.

The number of file descriptors that a process can have open is the minimum of the following:

- HP C RTL open file limit—65535 on OpenVMS Alpha and Integrity servers.
- `SYSGEN CHANNELCNT` parameter—permanent I/O channel count.
- Process open file quota `FILLM` parameter—number of open files that can be opened by a process at one time.

Return Values

x	The number of file descriptors that a process can have open simultaneously.
-1	Indicates an error.

getegid

getegid

With POSIX IDs disabled, this function is equivalent to `getgid` and returns the group number from the user identification code (UIC).

With POSIX IDs enabled, this function returns the effective group ID of the calling process.

Format

```
#include <unistd.h>
gid_t getegid (void);
```

Description

The `getegid` function can be used with POSIX style identifiers (IDs) or with UIC-based identifiers.

POSIX style IDs are supported on OpenVMS Version 7.3-2 and higher.

With POSIX style IDs disabled, the `getegid` and `getgid` functions are equivalent and return the group number from the current UIC. For example, if the UIC is [313,031], 313 is the group number.

With POSIX style IDs enabled, `getegid` returns the effective group ID of the calling process, and `getgid` returns the real group ID of the calling process. The real group ID is specified at login time. The effective group ID is more transient, and determines additional access permission during execution of a *set-group-ID* process. It is for such processes that the `getgid` function is most useful.

The `getegid` function is always successful; no return value is reserved to indicate an error.

To enable/disable POSIX style IDs, see Section 1.6.

See also `geteuid` and `getuid`.

Return Value

x	The effective group ID (POSIX IDs enabled), or the group number from the UIC (POSIX IDs disabled).
---	--

getenv

Searches the environment array for the current process and returns the value associated with a specified environment name.

Format

```
#include <stdlib.h>
char *getenv (const char *name);
```

Argument

name

One of the following values:

- HOME—Your login directory
- TERM—The type of terminal being used
- PATH—The default device and directory
- USER—The name of the user who initiated the process
- Logical name or command-language interpreter (CLI) symbolic name
- An environment variable set with `setenv` or `putenv`

The case of the specified *name* is important.

Description

In certain situations, the `getenv` function attempts to perform a logical name translation on the user-specified argument:

1. If the argument to `getenv` does not match any of the environment strings present in your environment array, `getenv` attempts to translate your argument as a logical name by searching the logical name tables indicated by the `LNM$FILE_DEV` logical, as is done for file processing.

`getenv` first does a case-sensitive lookup. If that fails, it does a case-insensitive lookup. In most instances, logical names are defined in uppercase, but `getenv` can also find logical names that include lowercase letters.

`getenv` does not perform iterative logical name translation.

2. If the logical name is a search list with multiple equivalence values, the returned value points to the first equivalence value. For example:

```
$ DEFINE A B,C
```

```
ptr = getenv("A");
```

A returns a pointer to "B".

3. If no logical name exists, `getenv` attempts to translate the argument string as a CLI symbol. If it succeeds, it returns the translated symbol text. If it fails, the return value is `NULL`.

`getenv` does not perform iterative CLI translation.

getenv

If your CLI is the DEC/Shell, the function does not attempt a logical name translation since Shell environment symbols are implemented as DCL symbols.

Notes

- In OpenVMS Version 7.1, a cache of OpenVMS environment variables (that is, logical names and DCL symbols) was added to the `getenv` function to avoid the library making repeated calls to translate a logical name or to obtain the value of a DCL symbol. By default, the cache is disabled. If your application does not need to track changes in OpenVMS environment variables that can occur during its execution, the cache can be enabled by enabling the `DECC$ENABLE_GETENV_CACHE` logical before invoking the application.
- Do not use the `setenv`, `getenv`, and `putenv` functions to manipulate symbols and logicals. Instead use the OpenVMS library calls `lib$set_logical`, `lib$get_logical`, `lib$set_symbol`, and `lib$get_symbol`. The `*env` functions deliberately provide UNIX behavior, and are not a substitute for these OpenVMS runtime library calls.

OpenVMS DCL symbols, not logical names, are the closest analog to environment variables on UNIX systems. While `getenv` is a mechanism to retrieve either a logical name or a symbol, it maintains an internal cache of values for use with `setenv` and subsequent `getenv` calls. The `setenv` function does not write or create DCL symbols or OpenVMS logical names.

This is consistent with UNIX behavior. On UNIX systems, `setenv` does not change or create any symbols that will be visible in the shell after the program exits.

Return Values

x	Pointer to an array containing the translated symbol. An equivalence name is returned at index zero.
NULL	Indicates that the translation failed.

geteuid

With POSIX IDs disabled, this function is equivalent to `getuid` and returns the member number (in OpenVMS terms) from the user identification code (UIC).

With POSIX IDs enabled, this function returns the effective user ID.

Format

```
#include <unistd.h>
uid_t geteuid (void);
```

Description

The `geteuid` function can be used with POSIX style identifiers (IDs) or with UIC-based identifiers.

POSIX style IDs are supported on OpenVMS Version 7.3-2 and higher.

With POSIX style IDs disabled (the default), the `geteuid` and `getuid` functions are equivalent and return the member number from the current UIC as follows:

- For programs compiled with the `_VMS_V6_SOURCE` feature-test macro or programs that do not include the `<unistd.h>` header file, the `getuid` and `geteuid` functions return the member number of the OpenVMS UIC. For example, if the UIC is [313,31], then the member number, 31, is returned.
- For programs compiled without the `_VMS_V6_SOURCE` feature-test macro that do include the `<unistd.h>` header file, the full UIC is returned in decimal after converting the octal representation to decimal. For example, if the UIC is [313, 31] then 13303833 is returned. (13303833 = 25 + 203 * 65536; Octal 31 = 25 decimal; Octal 313 = 203 decimal.)

With POSIX style IDs enabled, `geteuid` returns the effective user ID of the calling process, and `getuid` returns the real user ID of the calling process.

To enable/disable POSIX style IDs, see Section 1.6.

See also `getegid` and `getgid`.

Return Value

x	The effective user ID (POSIX IDs enabled), or the member number from the current UIC or the full UIC (POSIX IDs disabled).
---	--

getgid

getgid

With POSIX IDs disabled, this function is equivalent to `getegid` and returns the group number from the user identification code (UIC).

With POSIX IDs enabled, this function returns the real group ID.

Format

```
#include <unistd.h>
gid_t getgid (void);
```

Description

The `getgid` function can be used with POSIX style identifiers or with UIC-based identifiers.

POSIX style IDs are supported on OpenVMS Version 7.3-2 and higher.

With POSIX style IDs disabled (the default), the `getegid` and `getgid` functions are equivalent and return the group number from the current UIC. For example, if the UIC is [313,031], 313 is the group number.

With POSIX style IDs enabled, `getegid` returns the effective group ID of the calling process, and `getgid` returns the real group ID of the calling process. The real group ID is specified at login time. The effective group ID is more transient, and determines additional access permission during execution of a *set-group-ID* process. It is for such processes that the `getgid` function is most useful.

To enable/disable POSIX style IDs, see Section 1.6.

See also `geteuid` and `getuid`.

Return Value

x	The real group ID (POSIX IDs enabled), or the group number from the current UIC (POSIX IDs disabled).
---	---

getgrent (*Integrity servers, Alpha*)

Gets a group database entry.

Format

```
#include <grp.h>
struct group *getgrent (void);
```

Description

The `getgrent` function returns the next group in the sequential search, returning a pointer to a structure containing the broken-out fields of an entry in the group database.

When first called, `getgrent` returns a pointer to a group structure containing the first entry in the group database. Thereafter, it returns a pointer to the next group structure in the group database, so successive calls can be used to search the entire database.

If an end-of-file or an error is encountered on reading, `getgrent` returns a `NULL` pointer and sets `errno`.

Return Values

<code>x</code>	Pointer to a group structure, if successful.
<code>NULL</code>	Indicates that an error occurred. The function sets <code>errno</code> to one of the following values: <ul style="list-style-type: none">• <code>EACCES</code> – The user process does not have appropriate privileges enabled to access the user authorization file.• <code>EINTR</code> – A signal was intercepted during the operation.• <code>EIO</code> – Indicates that an I/O error occurred.• <code>EMFILE</code> – <code>OPEN_MAX</code> file descriptors are currently open in the calling process.• <code>ENFILE</code> – The maximum allowable number of files is currently open in the system.

getgrgid (*Integrity servers, Alpha*)

Gets a group database entry for a group ID.

Format

```
#include <types.h>
#include <grp.h>
struct group *getgrgid (gid_t gid);
```

Argument

gid

The group ID of the group for which the group database entry is to be retrieved.

Description

The `getgrgid` function searches the group database for an entry with a matching *gid* and returns a pointer to the group structure containing the matching entry.

Return Values

x	Pointer to a valid group structure containing a matching entry.
NULL	An error occurred. Note: The return value points to a static area that is overwritten by subsequent calls to <code>getgrent</code> , <code>getgrgid</code> , or <code>getgrnam</code> . On error, the function sets <code>errno</code> to one of the following values: <ul style="list-style-type: none">• EACCES – The user process does not have appropriate privileges enabled to access the user authorization file.• EIO – An I/O error has occurred.• EINTR – A signal was intercepted during <code>getgrgid</code>.• EMFILE – <code>OPEN_MAX</code> file descriptors are currently open in the calling process.• ENFILE – The maximum allowable number of files is currently open in the system. Applications checking for error situations must set <code>errno</code> to 0 before calling <code>getgrgid</code> . If <code>errno</code> is set on return, an error has occurred.

getgrgid_r (Integrity servers, Alpha)

Gets a group database entry for a group ID.

Format

```
#include <types.h>
#include <grp.h>
int getgrgid_r (gid_t gid, struct group *grp, char *buffer, size_t bufsize, struct group **result);
```

Arguments**gid**

The group ID of the group for which the group database entry is to be retrieved.

grp

Storage area to hold the retrieved group structure.

buffer

The working buffer that is able to hold the longest group entry in the database.

bufsize

The length, in characters, of *buffer*.

result

Upon successful return, *result* points to the retrieved group structure.

Upon unsuccessful return, *result* is set to NULL.

Description

The `getgrgid_r` function updates the group structure pointed to by *grp* and stores a pointer to that structure at the location pointed to by *result*. The structure contains an entry from the group database with a matching *gid*. Storage referenced by the group structure is allocated from the memory provided with the *buffer* argument, which is *bufsize* characters in size. The maximum size needed for this buffer can be determined with the `_SC_GETGR_R_SIZE_MAX` parameter of the `sysconf` function. On error or if the requested entry is not found, a NULL pointer is returned at the location pointed to by *result*.

Return Values

- | | |
|---|---|
| 0 | Successful completion. |
| x | On error, the function sets the return value to one of the following: <ul style="list-style-type: none">• EACCES – The user process does not have appropriate privileges enabled to access the user authorization file.• EIO – An I/O error has occurred.• EINTR – A signal was intercepted during getgrgid.• EMFILE – OPEN_MAX file descriptors are currently open in the calling process.• ENFILE – The maximum allowable number of files is currently open in the system.• ERANGE – Insufficient storage was supplied through the <i>buffer</i> and <i>bufsize</i> arguments to contain the data to be referenced by the resulting group structure. |

getgrnam (Integrity servers, Alpha)

Gets a group database entry for a name.

Format

```
#include <types.h>
#include <grp.h>
struct group *getgrnam (const char *name);
```

Argument**name**

The group name of the group for which the group database entry is to be retrieved.

Description

The getgrnam function searches the group database for an entry with a matching *name*, and returns a pointer to the group structure containing the matching entry.

Return Values

x	Pointer to a valid group structure containing a matching entry.
NULL	Indicates an error. Note: The return value points to a static area which is overwritten by subsequent calls to getgrent, getgrgid, or getgrnam. On error, the function sets the return value to one of the following: <ul style="list-style-type: none">• EACCES – The user process does not have appropriate privileges enabled to access the user authorization file.• EIO – An I/O error has occurred.• EINTR – A signal was intercepted during getgrnam.• EMFILE – OPEN_MAX file descriptors are currently open in the calling process.• ENFILE – The maximum allowable number of files is currently open in the system.

Applications wishing to check for error situations should set errno to 0 before calling getgrnam. If errno is set on return, an error occurred.

getgrnam_r (*Integrity servers, Alpha*)

Gets a group database entry for a name.

Format

```
#include <types.h>
#include <grp.h>
int getgrnam_r (const char *name, struct group *grp, char *buffer, size_t bufsize, struct group **result);
```

Arguments

name

The group name of the group for which the group database entry is to be retrieved.

grp

Storage area to hold the retrieved group structure.

buffer

The working buffer that is able to hold the longest group entry in the database.

bufsize

The length, in characters, of *buffer*.

result

Upon successful return, *result* points to the retrieved group structure.

Upon unsuccessful return, *result* is set to NULL.

Description

The `getgrnam_r` function updates the group structure pointed to by *grp* and stores a pointer to that structure at the location pointed to by *result*. The structure contains an entry from the group database with a matching *name*. Storage referenced by the group structure is allocated from the memory provided with the *buffer* argument, which is *bufsize* characters in size. The maximum size needed for this buffer can be determined with the `_SC_GETGR_R_SIZE_MAX` parameter of the `sysconf` function. On error or if the requested entry is not found, a NULL pointer is returned at the location pointed to by *result*.

Return Values

0

Successful completion.

x

On error, the function sets the return value to one of the following:

- **EACCES** – The user process does not have appropriate privileges enabled to access the user authorization file.
- **EIO** – An I/O error has occurred.
- **EINTR** – A signal was intercepted during `getgrnam`.
- **EMFILE** – `OPEN_MAX` file descriptors are currently open in the calling process.
- **ENFILE** – The maximum allowable number of files is currently open in the system.
- **ERANGE** – Insufficient storage was supplied through the *buffer* and *bufsize* arguments to contain the data to be referenced by the resulting group structure.

getgroups

getgroups

Gets the current supplementary group IDs of the calling process.

Format

```
#include <unistd.h>
int getgroups (int gidsetsize, gid_t grouplist[]);
```

Arguments

gidsetsize

Indicates the number of entries that can be stored in the array pointed to by the *grouplist* parameter.

grouplist

Points to the array in which the supplementary group IDs of the process are stored. The effective group ID of the process is not returned by the `getgroups` function if it is not also a supplementary group ID of the calling process.

Description

The `getgroups` function gets the current supplementary group IDs of the calling process. The list is stored in the array pointed to by the *grouplist* parameter. The *gidsetsize* parameter indicates the number of entries that can be stored in this array.

The `getgroups` function never returns more IDs than the value indicated by the `sysconf` parameter `_SC_NGROUPS_MAX`.

See also `getgid` and `setsid`.

Return Value

n	The number of elements stored in the array pointed to by the <i>grouplist</i> parameter.
-1	Indicates failure. <code>errno</code> might be set to one of the following values: <ul style="list-style-type: none">• <code>EFAULT</code> – The <i>gidsetsize</i> and <i>grouplist</i> parameters specify an array that is partially or completely outside of the allocated address space of the process.• <code>EINVAL</code> – The <i>gidsetsize</i> parameter is nonzero and smaller than the number of supplementary group IDs.

getitimer

Returns the value of interval timers.

Format

```
#include <time.h>

int getitimer (int which, struct itimerval *value);
```

Arguments

which

The type of interval timer. The HP C RTL supports only ITIMER_REAL.

value

Pointer to an `itimerval` structure whose members specify a timer interval and the time left to the end of the interval.

Description

The `getitimer` function returns the current value for the timer specified by the *which* argument in the structure pointed to by *value*.

A timer value is defined by the `itimerval` structure:

```
struct itimerval {
    struct timeval it_interval;
    struct timeval it_value;
};
```

The following table lists the values for the `itimerval` structure members:

itimerval Member Value	Meaning
<code>it_interval = 0</code>	Disables a timer after its next expiration and assumes <code>it_value</code> is nonzero.
<code>it_interval = nonzero</code>	Specifies a value used in reloading <code>it_value</code> when the timer expires.
<code>it_value = 0</code>	Disables a timer.
<code>it_value = nonzero</code>	Indicates the time to the next timer expiration.

Time values smaller than the resolution of the system clock are rounded up to this resolution.

The HP C RTL provides each process with one interval timer, defined in the `<time.h>` header file as `ITIMER_REAL`. This timer decrements in real time and delivers a `SIGALRM` signal when the timer expires.

getitimer

Return Values

0	Indicates success.
-1	Indicates an error; errno is set to EINVAL (The <i>value</i> argument specified a time that was too large to handle.)

getlogin

Gets the login name.

Format

```
#include <unistd.h>
char *getlogin (void);
int *getlogin_r (char *name, size_t namesize);
```

Description

The `getlogin` function returns the login name of the user associated with the current session. If `getlogin` returns a non-null pointer, then that pointer points to the name that the user logged in under, even if there are several login names with the same user ID.

The `getlogin_r` function is the reentrant version of `getlogin`. Upon successful completion, `getlogin_r` returns 0 and puts the name associated by the login activity with the controlling terminal of the current process in the character array pointed to by *name*. The array is *namesize* characters long and should have space for the name and the terminating null character. The maximum size of the login name is `LOGIN_NAME_MAX`.

If `getlogin_r` is successful, *name* points to the name the user used at login, even if there are several login names with the same user ID.

Return Values

x	Upon successful completion, <code>getlogin</code> returns a pointer to a null-terminated string in a static buffer.
0	Indicates successful completion of <code>getlogin_r</code> .
NULL	Indicates an error; <code>errno</code> is set.

getname

getname

Returns the file specification associated with a file descriptor.

Format

```
#include <unixio.h>
char *getname (int file_desc, char *buffer, ... );
```

Function Variants

The `getname` function has variants named `_getname32` and `_getname64` for use with 32-bit and 64-bit pointer sizes, respectively. See Section 1.9 for more information on using pointer-size-specific functions.

Arguments

file_desc

A file descriptor.

buffer

A pointer to a character string that is large enough to hold the file specification.

...

An optional argument that can be either 1 or 0. If you specify 1, the `getname` function returns the file specification in OpenVMS format. If you specify 0, the `getname` function returns the file specification in UNIX style format. If you omit this argument, the `getname` function returns the filename according to your current command-language interpreter (CLI). For more information about UNIX style file specifications, see Section 1.3.3.

Description

The `getname` function places the file specification into the area pointed to by *buffer* and returns that address. The area pointed to by *buffer* should be an array large enough to contain a fully qualified file specification (the maximum length is 256 characters).

Return Values

x	The address passed in the <i>buffer</i> argument.
0	Indicates an error.

getopt

A command-line parser that can be used by applications that follow UNIX command-line conventions.

Format

```
#include <unistd.h> (X/Open, POSIX-1)
#include <stdio.h> (X/Open, POSIX-2)

int getopt (int argc, char * const argv[], const char *optstring);
extern char *optarg;
extern int optind, opterr, optopt;
```

Arguments

argc

The argument count as passed to main.

argv

The argument array as passed to main.

optstring

A string of recognized option characters. If a character is followed by a colon, the option takes an argument.

Description

The variable `optind` is the index of the next element of the `argv` vector to be processed. It is initialized to 1 by the system, and it is updated by `getopt` when it finishes with each element of `argv`. When an element of `argv` contains multiple option characters, it is unspecified how `getopt` determines which options have already been processed.

The `getopt` function returns the next option character (if one is found) from `argv` that matches a character in `optstring`, if there is one that matches. If the option takes an argument, `getopt` sets the variable `optarg` to point to the option-argument as follows:

- If the option was the last character in the string pointed to by an element of `argv`, then `optarg` contains the next element of `argv`, and `optind` is incremented by 2. If the resulting value of `optind` is not less than `argc`, `getopt` returns an error, indicating a missing option-argument.
- Otherwise, `optarg` points to the string following the option character in that element of `argv`, and `optind` is incremented by 1.

If one of the following is true, `getopt` returns `-1` without changing `optind`:

```
argv[optind] is a NULL pointer
*argv[optind] is not the character -
argv[optind] points to the string "--"
```

If `argv[optind]` points to the string `--` `getopt` returns `-1` after incrementing `optind`.

getopt

If `getopt` encounters an option character not contained in *optstring*, the question-mark character (?) is returned.

If `getopt` detects a missing argument, the colon character (:) is returned if the first character of *optstring* is a colon; otherwise, a question-mark character is returned.

In either of the previous two cases, `getopt` sets the variable `optopt` to the option character that caused the error. If the application has not set the variable `opterr` to 0 and the first character of *optstring* is not a colon, `getopt` also prints a diagnostic message to `stderr`.

Return Values

x	The next option character specified on the command line. A colon is returned if <code>getopt</code> detects a missing argument and the first character of <i>optstring</i> is a colon. A question mark is returned if <code>getopt</code> encounters an option character not in <i>optstring</i> or detects a missing argument and the first character of <i>optstring</i> is not a colon.
-1	When all command-line options are parsed.

Example

The following example shows how you might process the arguments for a utility that can take the mutually exclusive options *a* and *b* and the options *f* and *o*, both of which require arguments:

```
#include <unistd.h>
int main (int argc, char *argv[ ])
{
    int c;
    int bflg, aflg, errflg;
    char *ifile;
    char *ofile;
    extern char *optarg;
    extern int optind, optopt;
    .
    .
    .
    while ((c = getopt(argc, argv, ":abf:o:)) != -1) {
        switch (c) {
            case 'a':
                if (bflg)
                    errflg++;
                else
                    aflg++;
                break;
            case 'b':
                if (aflg)
                    errflg++;
                else {
                    bflg++;
                    bproc();
                }
        }
    }
}
```

```

        break;
    case 'f':
        ifile = optarg;
        break;
    case 'o':
        ofile = optarg;
        break;
    case ':': /* -f or -o without operand */
        fprintf (stderr,
                "Option -%c requires an operand\n" optopt);
        errflg++;
        break;
    case '?':
        fprintf (stderr,
                "Unrecognized option -%c\n" optopt);
        errflg++;
    }
}
if (errflg) {
    fprintf (stderr, "usage: ...");
    exit(2);
}
for ( ; optind < argc; optind++) {
    if (access(argv[optind], R_OK)) {
        .
        .
        .
    }
}

```

This sample code accepts any of the following as equivalent:

```

cmd -ao arg path path
cmd -a -o arg path path
cmd -o arg -a path path
cmd -a -o arg -- path path
cmd -a -oarg path path
cmd -aoarg path path

```

getpagesize

getpagesize

Gets the system page size.

Format

```
#include <unistd.h>
int getpagesize (void);
```

Description

The `getpagesize` function returns the number of bytes in a page. The system page size is useful for specifying arguments to memory management system calls.

The page size is a system page size and is not necessarily the same as the underlying hardware page size.

Return Value

x Always indicates success. Returns the number of bytes in a page.

getpgid (Integrity servers, Alpha)

Gets the process group ID for a process.

Format

```
#include <unistd.h>
pid_t getpgid (pid_t pid);
```

Argument**pid**

The process ID for which the group ID is being requested.

Description

The `getpgid` function returns the process group ID of the process specified by *pid*. If *pid* is 0, the `getpgid` function returns the process group ID of the calling process.

This function requires that long (32-bit) UID/GID support be enabled. See Section 1.4.8 for more information.

Return Values

x	The process group ID of the session leader of the specified process.
(pid_t)-1	Indicates an error. The function sets <code>errno</code> to one of the following values: <ul style="list-style-type: none">• <code>EPERM</code> – The process specified by <i>pid</i> is not in the same session as the calling process, and the implementation does not allow access to the process group ID of that process from the calling process.• <code>ESRCH</code> – There is no process with a process ID of <i>pid</i>.• <code>EINVAL</code> – The value of <i>pid</i> is invalid.

getppid

getppid

Returns the parent process ID of the calling process.

Format

```
#include <unistd.h>
pid_t getppid (void);
```

Return Values

x	The parent process ID.
0	Indicates that the calling process does not have a parent process.

getpwent

Accesses user entry information in the user database, returning a pointer to a passwd structure.

Format

```
#include <pwd.h>
struct passwd *getpwent (void);
```

Function Variants

The `getpwent` function has variants named `__32_getpwent` and `__64_getpwent` for use with 32-bit and 64-bit pointer sizes, respectively. See Section 1.9 for more information on using pointer-size-specific functions.

Description

The `getpwent` function returns a pointer to a structure containing fields whose values are derived from an entry in the user database. Entries in the database are accessed sequentially by `getpwent`. When first called, `getpwent` returns a pointer to a `passwd` structure containing the first entry in the user database. Thereafter, it returns a pointer to a `passwd` structure containing the next entry in the user database. Successive calls can be used to search the entire user database.

The `passwd` structure is defined in the `<pwd.h>` header file as follows:

<code>pw_name</code>	The name of the user.
<code>pw_uid</code>	The ID of the user.
<code>pw_gid</code>	The group ID of the principle group of the user.
<code>pw_dir</code>	The home directory of the user.
<code>pw_shell</code>	The initial program for the user.

If an end-of-file or an error is encountered on reading, `getpwent` returns a NULL pointer.

Because `getpwent` accesses the user authorization file (SYSUAF) directly, the process must have appropriate privileges enabled or the function will fail.

Notes

All information generated by the `getpwent` function is stored in a per-thread static area and is overwritten on subsequent calls to the function. Password file entries that are too long are ignored.

getpwent

Return Values

x

NULL

Pointer to a passwd structure, if successful.

Indicates an end-of-file or error occurred. The function sets errno to one of the following values:

- EIO – Indicates that an I/O error occurred or the user does not have appropriate privileges enabled to access the user authorization file (SYSUAF).
- EMFILE – OPEN_MAX file descriptors are currently open in the calling process.
- ENFILE – The maximum allowable number of files is currently open in the system.

getpwnam, getpwnam_r

The `getpwnam` function returns information about a user database entry for the specified *name*.

The `getpwnam_r` function is a reentrant version of `getpwnam`.

Format

```
#include <pwd.h>

struct passwd *getpwnam (const char *name); (ISO POSIX-1)

struct passwd *getpwnam (const char *name, . . . ); (HP C Extension)

int getpwnam_r (const char *name, struct passwd *pwd, char *buffer, size_t bufsize, struct passwd
               **result); (ISO POSIX-1), (Integrity servers, Alpha)

int getpwnam_r (const char *name, struct passwd *pwd, char *buffer, size_t bufsize, struct passwd
               **result, . . . ); (HP C Extension), (Integrity servers, Alpha)
```

Function Variants

The `getpwnam` and `getpwnam_r` functions have variants named `__32_getpwnam`, `__getpwnam_r32` and `__64_getpwnam`, `__getpwnam_r64` for use with 32-bit and 64-bit pointer sizes, respectively. See Section 1.9 for more information on using pointer-size-specific functions.

Arguments

name

The name of the user for which the attributes are to be read.

pwd

The address of a `passwd` structure into which the function writes its results.

buffer

A working buffer for the *result* argument that is able to hold the largest entry in the `passwd` structure. Storage referenced by the `passwd` structure is allocated from the memory provided with the *buffer* argument, which is *bufsize* characters in length.

bufsize

The length of the character array that *buffer* points to.

result

Upon successful return, is set to *pwd*. Upon unsuccessful return, the result is set to `NULL`.

. . .

An optional argument that can be either 1 or 0. If you specify 1, the directory specification is returned in OpenVMS format. If you specify 0, the directory specification (pathname) is returned in UNIX style format. If you omit this argument, the function returns the directory specification according to your current command-language interpreter. For more information about UNIX style directory specifications, see Section 1.3.3.

getpwnam, getpwnam_r

Description

The `getpwnam` function searches the user database for an entry with the specified *name*. The function returns the first user entry in the database with the `pw_name` member of the `passwd` structure that matches the *name* argument.

The `passwd` structure is defined in the `<pwd.h>` header file as follows:

<code>pw_name</code>	The user's login name.
<code>pw_uid</code>	The numerical user ID.
<code>pw_gid</code>	The numerical group ID.
<code>pw_dir</code>	The home directory of the user.
<code>pw_shell</code>	The initial program for the user.

Note

All information generated by the `getpwnam` function is stored in a per-thread static area and is overwritten on subsequent calls to the function.

The `getpwnam_r` function is the reentrant version of `getpwnam`. The `getpwnam_r` function updates the `passwd` structure pointed to by *pwd* and stores a pointer to that structure at the location pointed to by *result*. The structure will contain an entry from the user database that matches the specified *name*. Storage referenced by the structure is allocated from the memory provided with the *buffer* argument, which is *bufsize* characters in length. The maximum size needed for this buffer can be determined with the `_SC_GETPW_R_SIZE_MAX` parameter of the `sysconf` function. On error or if the requested entry is not found, a NULL pointer is returned at the location pointed to by *result*.

Applications wishing to check for error situations should set `errno` to 0 before calling `getpwnam`. If `getpwnam` returns a NULL pointer and `errno` is nonzero, an error occurred.

Return Values

<code>x</code>	<code>getpwnam</code> returns a pointer to a valid <code>passwd</code> structure, if a matching entry is found.
NULL	<code>getpwnam</code> returns NULL if an error occurred or a the specified entry was not found. <code>errno</code> is set to indicate the error. The <code>getpwnam</code> function may fail if: <ul style="list-style-type: none">• EIO – An I/O error has occurred.• EINTR – A signal was intercepted during <code>getpwnam</code>.• EMFILE – OPEN_MAX file descriptors are currently open in the calling process.• ENFILE – The maximum allowable number of files is currently open in the system.

- 0 When successful, `getpwnam_r` returns 0 and stores a pointer to the updated `passwd` structure at the location pointed to by *result*.
- 0 When unsuccessful (on error or if the requested entry is not found), `getpwnam_r` returns 0 and stores a NULL pointer at the location pointed to by *result*. The `getpwnam_r` function may fail if:
- ERANGE – Insufficient storage was supplied through *buffer* and *bufsize* to contain the data to be referenced by the resulting `passwd` structure.

Example

When building a sample program with `/def=_USE_STD_STAT`, you can observe the following:

- When the `DECC$POSIX_STYLE_UID` logical is enabled:
 - For a system, that supports POSIX style identifiers:
 - `getpwnam_r` API reads information from the TCP/IP proxy database and fills UID and GID with values from the TCP/IP proxy database.
 - `getgrgid_r` API returns `gr_name` and `gr_mem` from the right's database associated with GID returned by `getpwnam_r` API.
 - System with no support for POSIX style identifiers, `getpwnam_r` fills GID and UID with `SYSGEN` parameters as "DEFUID" and "DEFGID".
- When the `DECC$POSIX_STYLE_UID` logical is not defined:
`getpwnam` function returns information about a user database entry for the specified name, which is specified in `SYSUAF.DAT`

```
#include <unistd> // getuid()
#include <pwd> // getpwuid_r()
#include <grp>
#include <errno.h>
#include <stdio.h>
#include <string.h>

main()
{
    struct passwd pwd2;
    const unsigned int PWD_BUFF_SIZE = 1024; const unsigned int GRP_BUFF_SIZE = 1024;

    struct passwd *p_passwd;
    struct passwd *result;
    struct group *grpresult;
    struct group grp;
    char pwdBuffer[PWD_BUFF_SIZE], *name;
    char grpBuffer[GRP_BUFF_SIZE];
    char buf[PWD_BUFF_SIZE];

    gid_t gid;
    uid_t uid;

    int status;
    p_passwd = getpwnam("user1");
    uid=p_passwd->pw_uid;
    gid=p_passwd->pw_gid;
```

getpwnam, getpwnam_r

```
printf("User id is %u\n", uid);
printf("Group id is %u\n", gid);

status = getpwnam_r("user1", &pwd2, pwdBuffer, PWD_BUFF_SIZE, &result);
gid = pwd2.pw_gid;

status = getgrgid_r(gid, &grp, grpBuffer, GRP_BUFF_SIZE, &grpresult);
gid=grp.gr_gid; name=grp.gr_name;
strcpy(name,grp.gr_name);

printf("Group id is %u\n", gid);
printf("Group name is %s\n", name);
}
```

Running the example program with `/def=_USE_STD_STAT` produces the following result:

- When the `DECC$POSIX_STYLE_UID` logical is NOT enabled, prints uid as 11010118 (result of $65536*168 + 70$) and gid as 168 with group name as RTL.
- When the `DECC$POSIX_STYLE_UID` logical is enabled and POSIX style identifiers are supported, prints uid as 70, gid as 168 with group name as FOR_POSIX_TEST (retrieved from TCP/IP proxy database).
- When the `DECC$POSIX_STYLE_UID` logical is enabled, but POSIX style identifiers are not supported, prints uid as DEFUID, gid as DEFGID with group name as invalid buffer.

getpwuid, getpwuid_r (Integrity servers, Alpha)

The `getpwuid` function returns information about a user database entry for the specified `uid`.

The `getpwuid_r` function is a reentrant version of `getpwuid`.

Format

```
#include <pwd.h>

struct passwd *getpwuid (uid_t uid); (ISO POSIX-1)
struct passwd *getpwuid (uid_t uid, ... ); (HP C Extension)

int getpwuid_r (uid_t uid, struct passwd *pwd, char *buffer, size_t bufsize, struct passwd **result); (ISO
POSIX-1)

int getpwuid_r (uid_t uid, struct passwd *pwd, char *buffer, size_t bufsize, struct passwd **result, ... );
(HP C Extension)
```

Function Variants

The `getpwuid` and `getpwuid_r` functions have variants named `__32_getpwuid`, `__getpwuid_r32` and `__64_getpwuid`, `__getpwuid_r64` for use with 32-bit and 64-bit pointer sizes, respectively. See Section 1.9 for more information on using pointer-size-specific functions.

Arguments**uid**

The user ID (UID) for which the attributes are to be read.

pwd

The location where the retrieved `passwd` structure is to be placed.

buffer

A working buffer for the `result` argument that is able to hold the entry in the `passwd` structure. Storage referenced by the `passwd` structure is allocated from the memory provided with the `buffer` argument, which is `bufsize` characters in size.

bufsize

The length of the character array that `buffer` points to.

result

Upon successful return, `result` is set to `pwd`. Upon unsuccessful return, `result` is set to `NULL`.

...

An optional argument that can be either 1 or 0. If you specify 1, the directory specification is returned in OpenVMS format. If you specify 0, the directory specification (pathname) is returned in UNIX style format. If you omit this argument, the function returns the directory specification according to your current command-language interpreter. For more information about UNIX style directory specifications, see Section 1.3.3.

Description

The `getpwuid` function searches the user database for an entry with the specified *uid*. The function returns the first user entry in the database with a `pw_uid` member of the `passwd` structure that matches the *uid* argument.

The `passwd` structure is defined in the `<pwd.h>` header file as follows:

<code>pw_name</code>	The user's login name.
<code>pw_uid</code>	The numerical user ID.
<code>pw_gid</code>	The numerical group ID.
<code>pw_dir</code>	The home directory of the user.
<code>pw_shell</code>	The initial program for the user.

Note

All information generated by the `getpwuid` function is stored in a per-thread static area and is overwritten on subsequent calls to the function.

The `getpwuid_r` function is the reentrant version of `getpwuid`. The `getpwuid_r` function updates the `passwd` structure pointed to by *pwd* and stores a pointer to that structure at the location pointed to by *result*. The structure will contain an entry from the user database with a matching *uid*. Storage referenced by the structure is allocated from the memory provided with the *buffer* argument, which is *bufsize* characters in size. The maximum size needed for this buffer can be determined with the `_SC_GETPW_R_SIZE_MAX` parameter of the `sysconf` function. On error or if the requested entry is not found, a NULL pointer is returned at the location pointed to by *result*.

Applications wishing to check for error situations should set `errno` to 0 before calling `getpwuid`. If `getpwuid` returns a NULL pointer and `errno` is nonzero, an error occurred.

See also `getuid` to know how UIC is represented.

Return Values

<code>x</code>	<code>getpwuid</code> returns a pointer to a valid <code>passwd</code> structure, if a matching entry is found.
<code>NULL</code>	<code>getpwuid</code> returns <code>NULL</code> if an error occurred or a matching entry was not found. <code>errno</code> is set to indicate the error. The <code>getpwuid</code> function may fail if: <ul style="list-style-type: none">• <code>EIO</code> – An I/O error has occurred.• <code>EINTR</code> – A signal was intercepted during <code>getpwnam</code>.• <code>EMFILE</code> – <code>OPEN_MAX</code> file descriptors are currently open in the calling process.• <code>ENFILE</code> – The maximum allowable number of files is currently open in the system.

getpwuid, getpwuid_r *(Integrity servers, Alpha)*

- 0 When successful, `getpwuid_r` returns 0 and stores a pointer to the updated `passwd` structure at the location pointed to by *result*.
- 0 When unsuccessful (on error or if the requested entry is not found), `getpwuid_r` returns 0 and stores a NULL pointer at the location pointed to by *result*. The `getpwuid_r` function may fail if:
- `ERANGE` – Insufficient storage was supplied through *buffer* and *bufsize* to contain the data to be referenced by the resulting `passwd` structure.

gets

gets

Reads a line from the standard input (`stdin`).

Format

```
#include <stdio.h>
char *gets (char *str);
```

Function Variants

The `gets` function has variants named `_gets32` and `_gets64` for use with 32-bit and 64-bit pointer sizes, respectively. See Section 1.9 for more information on using pointer-size-specific functions.

Argument

str

A pointer to a character string that is large enough to hold the information fetched from `stdin`.

Description

The new-line character (`\n`) that ends the line is replaced by the function with an ASCII null character (`\0`).

When `stdin` is opened in record mode, `gets` treats the end of a record the same as a new-line character and, therefore, reads up to and including a new-line character or to the end of the record.

Return Values

<code>x</code>	A pointer to the <i>str</i> argument.
<code>NULL</code>	Indicates that an error has occurred or that the end-of-file was encountered before a new-line character was encountered. The contents of <i>str</i> are undefined if a read error occurs.

getsid (*Integrity servers, Alpha*)

Gets the process group ID of the session leader.

Format

```
#include <unistd.h>
pid_t getsid (pid_t pid);
```

Argument**pid**

The process ID of the process whose session leader process group ID is being requested.

Description

The `getsid` function obtains the process group ID of the process that is the session leader of the process specified by *pid*. If *pid* is `(pid_t)0`, it specifies the calling process.

This function requires that long (32-bit) UID/GID support be enabled. See Section 1.4.8 for more information.

Return Values

x	The process group ID of the session leader of the specified process.
<code>(pid_t)-1</code>	Indicates an error. The function sets <code>errno</code> to one of the following values: <ul style="list-style-type: none">• <code>EPERM</code> – The process specified by <i>pid</i> is not in the same session as the calling process, and the implementation does not allow access to the process group ID of the session leader of that process from the calling process.• <code>ESRCH</code> – There is no process with a process ID of <i>pid</i>.

[w]getstr

[w]getstr

Get a string from the terminal screen, store it in the variable *str*, and echo it on the specified window. The `getstr` function works on the `stdscr` window.

Format

```
#include <curses.h>
int getstr (char *str);
int wgetstr (WINDOW *win, char *str);
```

Arguments

win

A pointer to the window.

str

Must be large enough to hold the character string fetched from the window.

Description

The `getstr` and `wgetstr` functions refresh the specified window before fetching a string. The new-line terminator is stripped from the fetched string. For more information, see the `scrollok` function.

Return Values

OK	Indicates success.
ERR	Indicates that the function makes the screen scroll illegally.

gettimeofday

Gets the date and time.

Format

```
#include <time.h>
int gettimeofday (struct timeval *tp, void *tzp);
```

Arguments

tp

Pointer to a `timeval` structure, defined in the `<time.h>` header file.

tzp

A NULL pointer. If this argument is not a NULL pointer, it is ignored.

Description

The `gettimeofday` function gets the current time (expressed as seconds and microseconds) since 00::00 Coordinated Universal Time, January 1, 1970. The current time is stored in the `timeval` structure pointed to by the `tp` argument.

The `tzp` argument is intended to hold time-zone information set by the kernel. However, because the OpenVMS kernel does not set time-zone information, the `tzp` argument should be NULL. If it is not NULL, it is ignored. This function is supported for compatibility with BSD programs.

If the value of the `SYS$TIMEZONE_DIFFERENTIAL` logical is wrong, the function fails with `errno` set to `EINVAL`.

Return Values

0	Indicates success.
-1	An error occurred. <code>errno</code> is set to indicate the error.

getuid

getuid

With POSIX IDs disabled, this function is equivalent to `geteuid` and returns the member number (in OpenVMS terms) from the user identification code (UIC).

With POSIX IDs enabled, returns the real user ID.

Format

```
#include <unistd.h>
uid_t getuid (void);
```

Description

The `getuid` function can be used with POSIX style identifiers or with UIC-based identifiers.

POSIX style IDs are supported on OpenVMS Version 7.3-2 and higher.

With POSIX style IDs disabled (the default), the `geteuid` and `getuid` functions are equivalent and return the member number from the current UIC as follows:

- For programs compiled with the `_VMS_V6_SOURCE` feature-test macro or programs that do not include the `<unistd.h>` header file, the `getuid` and `geteuid` functions return the member number of the OpenVMS UIC. For example, if the UIC is [313,31], then the member number, 31, is returned.
- For programs compiled without the `_VMS_V6_SOURCE` feature-test macro that do include the `<unistd.h>` header file, the full UIC is returned in decimal after converting the octal representation to decimal. For example, if the UIC is [313, 31] then 13303833 is returned. (13303833 = 25 + 203 * 65536; Octal 31 = 25 decimal; Octal 313 = 203 decimal.)

With POSIX style IDs enabled, `geteuid` returns the effective user ID of the calling process, and `getuid` returns the real user ID of the calling process.

To enable/disable POSIX style IDs, see Section 1.6.

See also `getegid` and `getgid`.

Return Value

x	The real user ID (POSIX IDs enabled), or the member number from the current UIC or the full UIC (POSIX IDs disabled).
---	---

getw

Returns characters from a specified file.

Format

```
#include <stdio.h>
int getw (FILE *file_ptr);
```

Argument

file_ptr
A pointer to the file to be accessed.

Description

The `getw` function returns the next four characters from the specified input file as an `int`.

Return Values

<code>x</code>	The next four characters, in an <code>int</code> .
<code>EOF</code>	Indicates that the end-of-file was encountered during the retrieval of any of the four characters and all four characters were lost. Since <code>EOF</code> is an acceptable integer, use <code>feof</code> and <code>ferror</code> to check the success of the function.

getwc

getwc

Reads the next character from a specified file, and converts it to a wide-character code.

Format

```
#include <wchar.h>
wint_t getwc (FILE *file_ptr);
```

Argument

file_ptr
A pointer to the file to be accessed.

Description

Since `getwc` is implemented as a macro, a file pointer argument with side effects (for example `getwc (*f++)`) might be evaluated incorrectly. In such a case, use the `fgetwc` function instead. See the `fgetwc` function.

Return Values

<code>n</code>	The returned character.
<code>WEOF</code>	Indicates the end-of-file or an error. If an error occurs, the function sets <code>errno</code> . For a list of the values set by this function, see <code>fgetwc</code> .

getwchar

Reads a single wide character from the standard input (stdin).

Format

```
#include <wchar.h>
wint_t getwchar (void);
```

Description

The `getwchar` function is identical to `fgetwc(stdin)`.

Return Values

<code>x</code>	The next character from <code>stdin</code> , converted to <code>wint_t</code> .
<code>WEOF</code>	Indicates the end-of-file or an error. If an error occurs, the function sets <code>errno</code> . For a list of the values set by this function, see <code>fgetwc</code> .

getyx

getyx

Puts the (y,x) coordinates of the current cursor position on *win* in the variables *y* and *x*.

Format

```
#include <curses.h>
getyx (WINDOW *win, int y, int x);
```

Arguments

win
Must be a pointer to the window.

y
Must be a valid lvalue.

x
Must be a valid lvalue.

glob (Integrity servers, Alpha)

Returns a list of existing files for a user supplied pathname (with optional wildcards).

Format

```
#include <glob.h>

int glob (const char *pattern, int flags, int (*errfunc)(const char *epath, int errno), glob_t *pglob);
```

Function Variants

The glob function has variants named `_glob32` and `_glob64` for use with 32-bit and 64-bit pointer sizes, respectively. See Section 1.9 for more information on using pointer-size-specific functions.

Arguments**pattern**

The pattern string to match with accessible files and pathnames. This pattern can have wildcards.

flags

Controls the customizable behavior of the glob function.

errfunc

An optional function that, if specified, is called when the glob function detects an error condition, or if not specified, is NULL.

epath

First argument of the optional *errfunc* function, *epath* is the pathname that failed because a directory could not be opened or read.

errno

Second argument of the optional *errfunc* function, *errno* is the errno value from a failure specified by the *epath* argument as set by the `opendir`, `readdir`, or `stat` functions.

pglob

Pointer to a `glob_t` structure that returns the matching accessible existing filenames. The structure is allocated by the caller. The array of structures containing the located filenames that match the *pattern* argument are stored by the glob function into the structure. The last entry is a NULL pointer.

The structure type `glob_t` is defined in the `<glob.h>` header file and includes at least the following members:

```
size_t  gl_pathc  //Count of paths matched by pattern.
char**  gl_pathv  //Pointer to a list of matched pathnames.
size_t  gl_offs   //Slots to reserve at the beginning of gl_pathv.
```

Description

The `glob` function constructs a list of accessible files that match the *pattern* argument.

The `glob` function operates in one of two modes: UNIX mode or OpenVMS mode.

You can select UNIX mode explicitly by enabling the feature logical `DECC$GLOB_UNIX_STYLE`, which is disabled by default.

The `glob` function defaults to OpenVMS mode unless one of the following conditions is met (in which case `glob` uses UNIX mode):

- The `DECC$GLOB_UNIX_STYLE` is enabled.
- The `DECC$FILENAME_UNIX_ONLY` feature logical is enabled.
- The `glob` function checks the specified pattern for pathname indications, such as directory delimiters, and determines it to be a UNIX style pathname.

OpenVMS mode

This mode allows an OpenVMS programmer to give an OpenVMS style pattern to the `glob` function and get expected OpenVMS style output. The OpenVMS style pattern is what a user would expect from DCL commands or as input to the `SYS$PARSE` and `SYS$SEARCH` system routines.

In this mode, you can use any of the expected OpenVMS wildcards (see the OpenVMS documentation for additional information).

OpenVMS mode does not support the UNIX wildcard `?`, or `[]` pattern matching. OpenVMS users expect `[]` to be available as directory delimiters.

Some additional behavior differences between OpenVMS mode and UNIX mode:

- OpenVMS mode outputs full file specifications, not relative ones, as in UNIX mode.
- The `GLOB_MARK` flag is ignored in OpenVMS mode because it is not meaningful to append a slash (`/`) to a directory on OpenVMS.

For example:

Sample pattern input	Sample output
<code>[.SUBDIR1]A.TXT</code>	<code>DEV:[DIR.SUBDIR1]A.TXT;1</code>
<code>[.SUB*]*.*</code>	<code>DEV:[DIR.SUBDIR1]A.TXT;1</code>

UNIX mode

You can enable this mode explicitly with:

```
$ DEFINE DECC$GLOB_UNIX_STYLE ENABLE
```

UNIX mode is also enabled if the `DECC$FILENAME_UNIX_ONLY` feature logical is set, or if the `glob` function determines that the specified pattern looks like a UNIX style pathname.

In UNIX mode, the `glob` function follows the X/Open specification where possible.

For example:

Sample pattern input	Sample output
<code>./a/b/c</code>	<code>./a/b/c</code>
<code>./?/b/*</code>	<code>./a/b/c</code>
<code>[a-c]</code>	<code>c</code>

Standard Description

The glob function matches all accessible pathnames against this pattern and develops a list of all pathnames that match. To have access to a pathname, the glob function requires search permission on every component of a pathname except the last, and read permission on each directory of any filename component of the *pattern* argument.

The glob function stores the number of matched pathnames and a pointer to a list of pointers to pathnames in the *pglob* argument. The pathnames are sorted, based on the setting of the LC_COLLATE category in the current locale. The first pointer after the last pathname is NULL. If the pattern does not match any pathnames, the returned number of matched pathnames is 0.

It is the caller's responsibility to create the structure pointed to by the *pglob* argument. The glob function allocates other space as needed. The globfree function frees any space associated with the *pglob* argument as a result of a previous call to the glob function.

The *flags* argument is used to control the behavior of the glob function. The *flags* value is the bitwise inclusive OR (|) of any of the following constants, which are defined in the <glob.h> header file:

GLOB_APPEND	Appends pathnames located with this call to any pathnames previously located.
GLOB_DOOFFS	Uses the <i>gl_offs</i> structure to specify the number of NULL pointers to add to the beginning of the <i>gl_pathv</i> component of the <i>pglob</i> argument.
GLOB_ERR	Causes the glob function to return when it encounters a directory that it cannot open or read. If the GLOB_ERR flag is not set, the glob function continues to find matches if it encounters a directory that it cannot open or read.
GLOB_MARK	Specifies that each pathname that is a directory should have a slash (/) appended. GLOB_MARK is ignored in OpenVMS mode because it is not meaningful to append a slash to a directory on OpenVMS systems.
GLOB_NOCHECK	If the <i>pattern</i> argument does not match any pathname, then the glob function returns a list consisting only of the <i>pattern</i> argument, and the number of matched pathnames is 1.
GLOB_NOESCAPE	If the GLOB_NOESCAPE flag is set, a backslash (\) cannot be used to escape metacharacters.

The GLOB_APPEND flag can be used to append a new set of pathnames to those found in a previous call to the glob function. The following rules apply when two or more calls to the glob function are made with the same value of the *pglob* argument, and without intervening calls to the globfree function:

- If the application sets the GLOB_DOOFFS flag in the first call to the glob function, then it is also set in the second call, and the value of the *gl_offs* field of the *pglob* argument is not modified between the calls.
- If the application did not set the GLOB_DOOFFS flag in the first call to the glob function, then it is not set in the second call.

- After the second call, *pglob->gl_pathv* points to a list containing the following:
 - Zero or more NULLs, as specified by the GLOB_DOOFFS flag and *pglob->gl_offs*.
 - Pointers to the pathnames that were in the *pglob->gl_pathv* list before the call, in the same order as after the first call to the glob function.
 - Pointers to the new pathnames generated by the second call, in the specified order.
- The count returned in the *pglob->gl_offs* argument is the total number of pathnames from the two calls.
- The application should not modify the *pglob->gl_pathc* or *pglob->gl_pathv* fields between the two calls.

On successful completion, the glob function returns a value of 0 (zero). The *pglob->gl_pathc* field returns the number of matched pathnames and the *pglob->gl_pathv* field contains a pointer to a NULL-terminated list of matched and sorted pathnames. If the number of matched pathnames in the *pglob->gl_pathc* argument is 0 (zero), the pointer in the *pglob->gl_pathv* argument is undefined.

If the glob function terminates because of an error, the function returns one of the nonzero constants GLOB_ABORTED, GLOB_NOMATCH, or GLOB_NOSPACE, defined in the <glob.h> header file. In this case, the *pglob* argument values are still set as defined above.

If, during the search, a directory is encountered that cannot be opened or read and the *errfunc* argument value is not NULL, the glob function calls *errfunc* with the two arguments *epath* and *errno*:

epath—The pathname that failed because a directory could not be opened or read.

errno—The errno value from a failure specified by the *epath* argument as set by the opendir, readdir, or stat functions.

If *errfunc* is called and returns nonzero, or if the GLOB_ERR flag is set in *flags*, the glob function stops the scan and returns GLOB_ABORTED after setting the *pglob* argument to reflect the pathnames already scanned. If GLOB_ERR is not set and either *errfunc* is NULL or *errfunc* returns zero, the error is ignored.

No errno values are returned.

See also globfree, readdir, and stat.

Return Values

0	Successful completion.
GLOB_ABORTED	The scan was stopped because GLOB_ERROR was set or <i>errfunc</i> returned a nonzero value.
GLOB_NOMATCH	The pattern does not match any existing pathname, and GLOB_NOCHECK was not set in <i>flags</i> .
GLOB_NOSPACE	An attempt to allocate memory failed.

globfree

Frees any space associated with the *pglob* argument resulting from a previous call to the `glob` function.

Format

```
#include <glob.h>

void globfree (glob_t *pglob);
```

Function Variants

The `globfree` function has variants named `_globfree32` and `_globfree64` for use with 32-bit and 64-bit pointer sizes, respectively. See Section 1.9 for more information on using pointer-size-specific functions.

Argument

pglob

Pointer to a previously allocated `glob_t` structure.

Description

The `globfree` function frees any space associated with the *pglob* argument resulting from a previous call to the `glob` function. The `globfree` function returns no value.

gmtime, gmtime_r

gmtime, gmtime_r

Converts time units to the broken-down UTC time.

Format

```
#include <time.h>
struct tm *gmtime (const time_t *timer);
struct tm *gmtime_r (const time_t *timer, struct tm *result); (ISO POSIX-1)
```

Function Variants

Compiling with the `_DECC_V4_SOURCE` and `_VMS_V6_SOURCE` feature-test macros defined enables a local-time-based entry point to the `gmtime_r` function that is equivalent to the behavior before OpenVMS Version 7.0.

Arguments

timer

Points to a variable that specifies a time value in seconds since the Epoch.

result

A pointer to a `tm` structure where the result is stored.

The `tm` structure is defined in the `<time.h>` header, and is also shown in Table REF-4 in the description of `localtime`.

Description

The `gmtime` and `gmtime_r` functions convert the time (in seconds since the Epoch) pointed to by `timer` into a broken-down time, expressed as Coordinated Universal Time (UTC), and store it in a `tm` structure.

The difference between the `gmtime_r` and `gmtime` functions is that the former puts the result into a user-specified `tm` structure where the result is stored. The latter puts the result into thread-specific static memory allocated by the HP C RTL, and which is overwritten by subsequent calls to `gmtime`; you must make a copy if you want to save it.

On success, `gmtime` returns a pointer to the `tm` structure; `gmtime_r` returns its second argument. On failure, these functions return the NULL pointer.

Note

Generally speaking, UTC-based time functions can affect in-memory time-zone information, which is processwide data. However, if the system time zone remains the same during the execution of the application (which is the common case) and the cache of timezone files is enabled (which is the default), then the `_r` variant of the time functions `asctime_r`, `ctime_r`, `gmtime_r` and `localtime_r`, is both thread-safe and AST-reentrant.

If, however, the system time zone can change during the execution of the application or the cache of timezone files is not enabled, then both variants of the UTC-based time functions belong to the third class of functions, which are neither thread-safe nor AST-reentrant.

Return Values

x

Pointer to a tm structure.

NULL

Indicates an error; errno is set to the following value:

- EINVAL – The *timer* argument is NULL.

gsignal

gsignal

Generates a specified software signal, which invokes the action routine established by a `signal`, `ssignal`, or `sigvec` function.

Format

```
#include <signal.h>
int gsignal (int sig [, int sigcode]);
```

Arguments

sig

The signal to be generated.

sigcode

An optional signal code. For example, signal SIGFPE—the arithmetic trap signal—has 10 different codes, each representing a different type of arithmetic trap.

The signal codes can be represented by mnemonics or numbers. The arithmetic trap codes are represented by the numbers 1 to 10, but the SIGILL codes are represented by the numbers 0 to 2. The code values are defined in the `<signal.h>` header file. See Table 4–4 for a list of signal mnemonics, codes, and corresponding OpenVMS exceptions.

Description

Calling the `gsignal` function has one of the following results:

- If `gsignal` specifies a *sig* argument that is outside the range defined in the `<signal.h>` header file, then `gsignal` returns 0 and sets `errno` to `EINVAL`.
- If `signal`, `ssignal`, or `sigvec` establishes `SIG_DFL` (default action) for the signal, then `gsignal` does not return. The image is exited with the OpenVMS error code corresponding to the signal.
- If `signal`, `ssignal`, or `sigvec` establishes `SIG_IGN` (ignore signal) as the action for the signal, then `gsignal` returns its argument, *sig*.
- `signal`, `ssignal`, or `sigvec` must be used to establish an action routine for the signal. That function is called and its return value is returned by `gsignal`.

See Chapter 4 for more information.

See also `raise`, `signal`, `ssignal`, and `sigvec`.

Return Values

0	Indicates a <i>sig</i> argument that is outside the range defined in the <code><signal.h></code> header file; <code>errno</code> is set to <code>EINVAL</code> .
<i>sig</i>	Indicates that <code>SIG_IGN</code> (ignore signal) has been established as the action for the signal.

x

Indicates that `signal`, `ssignal`, or `sigvec` has established an action function for the signal. That function is called, and its return value is returned by `gsignal`.

hypot

hypot

Returns the length of the hypotenuse of a right triangle.

Format

```
#include <math.h>
double hypot (double x, double y);
float hypotf (float x, float y); (Integrity servers, Alpha)
long double hypotl (long double x, long double y); (Integrity servers, Alpha)
```

Arguments

x
A real value.

y
A real value.

Description

The hypot functions return the length of the hypotenuse of a right triangle, where x and y represent the perpendicular sides of the triangle. The length is calculated as:

$$\text{sqrt}(x^2 + y^2)$$

On overflow, the return value is undefined, and `errno` is set to `ERANGE`.

Return Values

<code>x</code>	The length of the hypotenuse.
<code>HUGE_VAL</code>	Overflow occurred; <code>errno</code> is set to <code>ERANGE</code> .
<code>0</code>	Underflow occurred; <code>errno</code> is set to <code>ERANGE</code> .
<code>NaN</code>	x or y is NaN; <code>errno</code> is set to <code>EDOM</code> .

iconv

Converts characters coded in one codeset to characters coded in another codeset.

Format

```
#include <iconv.h>
size_t iconv (iconv_t cd, const char **inbuf, size_t *inbytesleft, char **outbuf, size_t *outbytesleft);
```

Arguments

cd

A conversion descriptor. This is returned by a successful call to `iconv_open`.

inbuf

A pointer to a variable that points to the first character in the input buffer.

inbytesleft

Initially, this argument is a pointer to a variable that indicates the number of bytes to the end of the input buffer (*inbuf*). When the conversion is completed, the variable indicates the number of bytes in *inbuf* not converted.

outbuf

A pointer to a variable that points to the first available byte in the output buffer. The output buffer contains the converted characters.

outbytesleft

Initially, this argument is a pointer to a variable that indicates the number of bytes to the end of the output buffer (*outbuf*). When the conversion is completed, the variable indicates the number of bytes left in *outbuf*.

Description

The `iconv` function converts characters in the buffer pointed to by *inbuf* to characters in another code set. The resulting characters are stored in the buffer pointed to by *outbuf*. The conversion type is specified by the conversion descriptor *cd*. This descriptor is returned from a successful call to `iconv_open`.

If an invalid character is found in the input buffer, the conversion stops after the last successful conversion. The variable pointed to by *inbytesleft* is updated to reflect the number of bytes in the input buffer that are not converted. The variable pointed to by *outbytesleft* is updated to reflect the number of bytes remaining in the output buffer.

Return Values

x	Number of nonidentical conversions performed. Indicates successful conversion. In most cases, 0 is returned.
---	--

iconv

(size_t) -1

Indicates an error condition. The function sets `errno` to one of the following:

- `EBADF` – The *cd* argument is not a valid conversion descriptor.
- `EILSEQ` – The conversion stops when an invalid character detected.
- `E2BIG` – The conversion stops because of insufficient space in the output buffer.
- `EINVAL` – The conversion stops because of an incomplete character at the end of the input buffer.

iconv_close

Deallocates a specified conversion descriptor and the resources allocated to the descriptor.

Format

```
#include <iconv.h>
int iconv_close (iconv_t cd);
```

Argument

cd

The conversion descriptor to be deallocated. A conversion descriptor is returned by a successful call to `iconv_open`.

Return Values

0	Indicates that the conversion descriptor was successfully deallocated.
-1	Indicates an error occurred. The function sets <code>errno</code> to one of the following: <ul style="list-style-type: none">• <code>EBADF</code> – The <i>cd</i> argument is not a valid conversion descriptor.• <code>EVMSEERR</code> – Nontranslatable OpenVMS error occur. <code>vaxc\$errno</code> contains the VMS error code.

```

char fromcodeset[30];
char tocodeset[30];
int iconv_opened;
iconv_t iconv_struct;      /* Iconv descriptor      */
/* Initialize variables      */
sprintf(fromcodeset, "DECHANYU");
sprintf(tocodeset, "EUCTW");
iconv_opened = FALSE;

/* Attempt to create a conversion descriptor for the */
/* codesets specified. If the return value from      */
/* iconv_open is -1 then an error has occurred.      */
/* Check the value of errno.                          */
if ((iconv_struct = iconv_open(tocodeset, fromcodeset)
    == (iconv_t) - 1) {
    /* Check the value of errno                          */

    switch (errno) {
    case EMFILE:
    case ENFILE:
        printf("Too many iconv conversion files open\n");
        break;

    case ENOMEM:
        printf("Not enough memory\n");
        break;

    case EINVAL:
        printf("Unsupported conversion\n");
        break;

    default:
        printf("Unexpected error from iconv_open\n");
        break;
    }
}
else
    /* Successfully allocated a conversion descriptor */
    iconv_opened = TRUE;

/* Was a conversion descriptor allocated      */
if (iconv_opened) {
    /* Attempt to deallocate the conversion descriptor. */
    /* If iconv_close returns -1 then an error has      */
    /* occurred.                                          */
    if (iconv_close(iconv_struct) == -1) {
        /* An error occurred. Check the value of errno */

        switch (errno) {
        case EBADF:
            printf("Conversion descriptor is invalid\n");
            break;
        default:
            printf("Unexpected error from iconv_close\n");
            break;
        }
    }
}
return (EXIT_FAILURE);
}

```

[w]inch

Return the character at the current cursor position on the specified window without making changes to the window. The `inch` function acts on the `stdscr` window.

Format

```
#include <curses.h>
char inch();
char winch (WINDOW *win);
```

Argument

win
A pointer to the window.

Return Values

x	The returned character.
ERR	Indicates an input error.

index

index

Searches for a character in a string.

Format

```
#include <strings.h>
char *index (const char *s, int c);
```

Function Variants

The `index` function has variants named `_index32` and `_index64` for use with 32-bit and 64-bit pointer sizes, respectively. See Section 1.9 for more information on using pointer-size-specific functions.

Arguments

s
The string to search.

c
The character to search for.

Description

The `index` function is identical to the `strchr` function, and is provided for compatibility with some UNIX implementations.

initscr

Initializes the terminal-type data and all screen functions. You must call `initscr` before using any of the curses functions.

Format

```
#include <curses.h>
void initscr (void);
```

Description

The OpenVMS Curses version of the `initscr` function clears the screen before doing the initialization. The BSD-based Curses version does not.

initstate

initstate

Initializes random-number generators.

Format

```
#include <stdlib.h>
char *initstate (unsigned int seed, char *state, int size);
```

Arguments

seed

An initial seed value.

state

Pointer to an array of state information.

size

The size of the state information array.

Description

The `initstate` function initializes random-number generators. It lets you initialize, for future use, a state array passed as an argument. The size, in bytes, of the state array is used by the `initstate` function to decide how sophisticated a random-number generator to use; the larger the state array, the more random the numbers.

Values for the amount of state information are 8, 32, 64, 128, and 256 bytes. Amounts less than 8 bytes generate an error, while other amounts are rounded down to the nearest known value.

The *seed* argument specifies a starting point for the random-number sequence and provides for restarting at the same point. The `initstate` function returns a pointer to the previous state information array.

Once you initialize a state, the `setstate` function allows rapid switching between states. The array defined by the *state* argument is used for further random-number generation until the `initstate` function is called or the `setstate` function is called again. The `setstate` function returns a pointer to the previous state array.

After initialization, you can restart a state array at a different point in one of two ways:

- Use the `initstate` function with the desired *seed* argument, *state* array, and *size* of the array.
- Use the `setstate` function with the desired state, followed by the `srandom` function with the desired *seed*. The advantage of using both functions is that you do not have to save the state array size once you initialize it.

See also `setstate`, `srandom`, and `random`.

Return Values

x

A pointer to the previous state array information.

0

Indicates an error. Call made with less than 8 bytes of state information. Further specified in the global `errno`.

[w]insch

[w]insch

Insert a character at the current cursor position in the specified window. The `insch` function acts on the `stdscr` window.

Format

```
#include <curses.h>
int insch (char ch);
int winsch (WINDOW *win, char ch);
```

Arguments

win

A pointer to the window.

ch

The character to be inserted.

Description

After the character is inserted, each character on the line shifts to the right, and the last character in the line is deleted. For more information, see the `scrollok` function.

Return Values

OK

Indicates success.

ERR

Indicates that the function makes the screen scroll illegally.

[w]insertln

Insert a line above the line containing the current cursor position. The `insertln` function acts on the `stdscr` window.

Format

```
#include <curses.h>
int insertln();
int winsertln (WINDOW *win);
```

Argument

win
A pointer to the window.

Description

The current line and every line below it shifts down, and the bottom line disappears. The inserted line is blank and the current (y,x) coordinates remain the same. For more information, see the `scrollok` function.

Return Values

OK	Indicates success.
ERR	Indicates that the function makes the screen scroll illegally.

[w]insstr

[w]insstr

Insert a string at the current cursor position in the specified window. The `insstr` function acts on the `stdscr` window.

Format

```
#include <curses.h>
int insstr (char *str);
int winsstr (WINDOW *win, char *str);
```

Arguments

win

A pointer to the window.

str

A pointer to the string to be inserted.

Description

Each character after the string shifts to the right, and the last character disappears. These functions are specific to HP C for OpenVMS Systems and are not portable.

Return Values

OK

Indicates success.

ERR

Indicates that the function makes the screen scroll illegally. For more information, see the `scrollok` function.

isalnum

Indicates if a character is classed either as alphabetic or as a digit in the program's current locale.

Format

```
#include <ctype.h>
int isalnum (int character);
```

Argument

character

An object of type `int`. The value of *character* must be representable as an unsigned `char` or must equal the value of the macro `EOF`. If it has any other value, the behavior is undefined.

Return Values

nonzero	If alphanumeric.
0	If not alphanumeric.

isalpha

isalpha

Indicates if a character is classed as an alphabetic character in the program's current locale.

Format

```
#include <ctype.h>
int isalpha (int character);
```

Argument

character

An object of type `int`. The value of *character* must be representable as an unsigned `char` or must equal the value of the macro `EOF`. If it has any other value, the behavior is undefined.

Return Values

nonzero	If alphabetic.
0	If not alphabetic.

isapipe

Indicates if a specified file descriptor is associated with a pipe.

Format

```
#include <unistd.h>
int isapipe (int file_desc);
```

Argument

file_desc
A file descriptor.

Description

For more information about pipes, see Chapter 5.

Return Values

1	Indicates an association with a pipe.
0	Indicates no association with a pipe.
-1	Indicates an error (for example, if the file descriptor is not associated with an open file).

isascii

isascii

Indicates if a character is an ASCII character.

Format

```
#include <ctype.h>
int isascii (int character);
```

Argument

character
An object of type char.

Return Values

nonzero	If ASCII.
0	If not ASCII.

isatty

Indicates if a specified file descriptor is associated with a terminal.

Format

```
#include <unistd.h>
int isatty (int file_desc);
```

Argument

file_desc
A file descriptor.

Return Values

1	If the file descriptor is associated with a terminal.
0	If the file descriptor is not associated with a terminal.
-1	Indicates an error (for example, if the file descriptor is not associated with an open file).

iscntrl

iscntrl

Indicates if a character is classed as a control character in the program's current locale.

Format

```
#include <ctype.h>
int iscntrl (int character);
```

Argument

character

An object of type `int`. The value of *character* must be representable as an unsigned `char` or must equal the value of the macro `EOF`. If it has any other value, the behavior is undefined.

Return Values

nonzero	If a control character.
0	If not a control character.

isdigit

Indicates if a character is classed as a digit in the program's current locale.

Format

```
#include <ctype.h>
int isdigit (int character);
```

Argument

character

An object of type `int`. The value of *character* must be representable as an unsigned `char` or must equal the value of the macro `EOF`. If it has any other value, the behavior is undefined.

Return Values

nonzero	If a decimal digit.
0	If not a decimal digit.

isgraph

isgraph

Indicates if a character is classed as a graphic character in the program's current locale.

Format

```
#include <ctype.h>
int isgraph (int character);
```

Argument

character

An object of type `int`. The value of *character* must be representable as an unsigned `char` or must equal the value of the macro `EOF`. If it has any other value, the behavior is undefined.

Return Values

nonzero	If a graphic character.
0	If not a graphic character.

islower

Indicates if a character is classed as a lowercase character in the program's current locale.

Format

```
#include <ctype.h>
int islower (int character);
```

Argument

character

An object of type `int`. The value of *character* must be representable as an unsigned `char` or must equal the value of the macro `EOF`. If it has any other value, the behavior is undefined.

Return Values

nonzero	If a lowercase alphabetic character.
0	If not a lowercase alphabetic character.

isnan (*Integrity servers, Alpha*)

isnan (*Integrity servers, Alpha*)

Tests for a NaN. Returns 1 if the argument is NaN; 0 if not.

Format

```
#include <math.h>
int isnan (double x);
int isnanf (float x);
int isnanl (long double x);
```

Argument

x
A real value.

Description

The `isnan` functions return the integer value 1 (TRUE) if x is NaN (the IEEE floating point reserved not-a-number value); otherwise, they return the value 0 (FALSE).

isprint

Indicates if a character is classed as a printing character in the program's current locale.

Format

```
#include <ctype.h>
int isprint (int character);
```

Argument

character

An object of type `int`. The value of *character* must be representable as an unsigned `char` or must equal the value of the macro `EOF`. If it has any other value, the behavior is undefined.

Return Values

nonzero	If a printing character.
0	If not a printing character.

ispunct

ispunct

Indicates if a character is classed as a punctuation character in the program's current locale.

Format

```
#include <ctype.h>
int ispunct (int character);
```

Argument

character

An object of type `int`. The value of *character* must be representable as an unsigned `char` or must equal the value of the macro `EOF`. If it has any other value, the behavior is undefined.

Return Values

nonzero	If a punctuation character.
0	If not a punctuation character.

isspace

Indicates if a character is classed as white space in the program's current locale; that is, if it is an ASCII space, tab (horizontal or vertical), carriage-return, form-feed, or new-line character.

Format

```
#include <ctype.h>
int isspace (int character);
```

Argument

character

An object of type `int`. The value of *character* must be representable as an unsigned `char` or must equal the value of the macro `EOF`. If it has any other value, the behavior is undefined.

Return Values

nonzero	If a white-space character.
0	If not a white-space character.

isupper

isupper

Indicates if a character is classed as an uppercase character in the program's current locale.

Format

```
#include <ctype.h>
int isupper (int character);
```

Argument

character

An object of type `int`. The value of *character* must be representable as an unsigned `char` or must equal the value of the macro `EOF`. If it has any other value, the behavior is undefined.

Return Values

nonzero	If an uppercase alphabetic character.
0	If not an uppercase alphabetic character.

iswalnum

Indicates if a wide character is classed either as alphabetic or as a digit in the program's current locale.

Format

```
#include <wctype.h> (ISO C)
```

```
#include <wchar.h> (XPG4)
```

```
int iswalnum (wint_t wc);
```

Argument

wc

An object of type `wint_t`. The value of *character* must be representable as a `wchar_t` in the current locale, or must equal the value of the macro `WEOF`. If it has any other value, the behavior is undefined.

Return Values

nonzero

If alphanumeric.

0

If not alphanumeric.

iswalpha

iswalpha

Indicates if a wide character is classed as an alphabetic character in the program's current locale.

Format

```
#include <wctype.h> (ISO C)
#include <wchar.h> (XPG4)
int iswalpha (wint_t wc);
```

Argument

wc

An object of type `wint_t`. The value of `wc` must be representable as a `wchar_t` in the current locale, or must equal the value of the macro `WEOF`. If it has any other value, the behavior is undefined.

Return Values

nonzero	If alphabetic.
0	If not alphabetic.

iswcntrl

Indicates if a wide character is classed as a control character in the program's current locale.

Format

```
#include <wctype.h> (ISO C)
```

```
#include <wchar.h> (XPG4)
```

```
int iswcntrl (wint_t wc);
```

Argument

wc

An object of type `wint_t`. The value of `wc` must be representable as a `wchar_t` in the current locale, or must equal the value of the macro `WEOF`. If it has any other value, the behavior is undefined.

Return Values

nonzero

If a control character.

0

If not a control character.

iswctype

iswctype

Indicates if a wide character has a specified property.

Format

```
#include <wctype.h> (ISO C)
#include <wchar.h> (XPG4)

int iswctype (wint_t wc, wctype_t wc_prop);
```

Arguments

wc

An object of type `wint_t`. The value of `wc` must be representable as a valid wide-character code in the current locale, or must equal the value of the macro `WEOF`. If it has any other value, the behavior is undefined.

wc_prop

A valid property name in the current locale. This is set up by calling the `wctype` function.

Description

The `iswctype` function tests whether `wc` has the character-class property `wc_prop`. Set `wc_prop` by calling the `wctype` function.

See also `wctype`.

Return Values

nonzero	If the character has the property <code>wc_prop</code> .
0	If the character does not have the property <code>wc_prop</code> .

Example

```
#include <locale.h>
#include <wchar.h>
#include <stdio.h>
#include <stdlib.h>
#include <string.h>
#include <ctype.h>

/* This test will set up the "upper" character class using
/* wctype() and then verify whether the characters 'a' and 'A'
/* are members of this class */
#include <stdlib.h>

main()
{
    wchar_t w_char1,
            w_char2;
    wctype_t ret_val;

    char *char1 = "a";
    char *char2 = "A";

    ret_val = wctype("upper");
```

```
/* Convert char1 to wide-character format - w_char1 */
if (mbtowl(&w_char1, char1, 1) == -1) {
    perror("mbtowl");
    exit(EXIT_FAILURE);
}
if (iswctype((wint_t) w_char1, ret_val))
    printf("[%C] is a member of the character class upper\n",
           w_char1);
else
    printf("[%C] is not a member of the character class upper\n",
           w_char1);
/* Convert char2 to wide-character format - w_char2 */
if (mbtowl(&w_char2, char2, 1) == -1) {
    perror("mbtowl");
    exit(EXIT_FAILURE);
}
if (iswctype((wint_t) w_char2, ret_val))
    printf("[%C] is a member of the character class upper\n",
           w_char2);
else
    printf("[%C] is not a member of the character class upper\n",
           w_char2);
}
```

Running the example program produces the following result:

```
[a] is not a member of the character class upper
[A] is a member of the character class upper
```

iswdigit

iswdigit

Indicates if a wide character is classed as a digit in the program's current locale.

Format

```
#include <wctype.h> (ISO C)
```

```
#include <wchar.h> (XPG4)
```

```
int iswdigit (wint_t wc);
```

Argument

wc

An object of type `wint_t`. The value of `wc` must be representable as a `wchar_t` in the current locale, or must equal the value of the macro `WEOF`. If it has any other value, the behavior is undefined.

Return Values

nonzero	If a decimal digit.
0	If not a decimal digit.

iswgraph

Indicates if a wide character is classed as a graphic character in the program's current locale.

Format

```
#include <wctype.h> (ISO C)
```

```
#include <wchar.h> (XPG4)
```

```
int iswgraph (wint_t wc);
```

Argument

wc

An object of type `wint_t`. The value of `wc` must be representable as a `wchar_t` in the current locale, or must equal the value of the macro `WEOF`. If it has any other value, the behavior is undefined.

Return Values

nonzero	If a graphic character.
0	If not a graphic character.

iswlower

iswlower

Indicates if a wide character is classed as a lowercase character in the program's current locale.

Format

```
#include <wctype.h> (ISO C)
#include <wchar.h> (XPG4)
int iswlower (wint_t wc);
```

Argument

wc

An object of type `wint_t`. The value of `wc` must be representable as a `wchar_t` in the current locale, or must equal the value of the macro `WEOF`. If it has any other value, the behavior is undefined.

Return Values

nonzero	If a lowercase character.
0	If not a lowercase character.

iswprint

Indicates if a wide character is classed as a printing character in the program's current locale.

Format

```
#include <wctype.h> (ISO C)
```

```
#include <wchar.h> (XPG4)
```

```
int iswprint (wint_t wc);
```

Argument

wc

An object of type `wint_t`. The value of `wc` must be representable as a `wchar_t` in the current locale, or must equal the value of the macro `WEOF`. If it has any other value, the behavior is undefined.

Return Values

nonzero

If a printing character.

0

If not a printing character.

iswpunct

iswpunct

Indicates if a wide character is classed as a punctuation character in the program's current locale.

Format

```
#include <wctype.h> (ISO C)
#include <wchar.h> (XPG4)
int iswpunct (wint_t wc);
```

Argument

wc

An object of type `wint_t`. The value of `wc` must be representable as a `wchar_t` in the current locale, or must equal the value of the macro `WEOF`. If it has any other value, the behavior is undefined.

Return Values

nonzero	If a punctuation character.
0	If not a punctuation character.

iswspace

Indicates if a wide character is classed as a space character in the program's current locale.

Format

```
#include <wctype.h> (ISO C)
```

```
#include <wchar.h> (XPG4)
```

```
int iswspace (wint_t wc);
```

Argument

wc

An object of type `wint_t`. The value of `wc` must be representable as a `wchar_t` in the current locale, or must equal the value of the macro `WEOF`. If it has any other value, the behavior is undefined.

Return Values

nonzero	If a white-space character.
0	If not a white-space character.

iswupper

iswupper

Indicates if a wide character is classed as an uppercase character in the program's current locale.

Format

```
#include <wctype.h> (ISO C)
```

```
#include <wchar.h> (XPG4)
```

```
int iswupper (wint_t wc);
```

Argument

wc

An object of type `wint_t`. The value of `wc` must be representable as a `wchar_t` in the current locale, or must equal the value of the macro `WEOF`. If it has any other value, the behavior is undefined.

Return Values

nonzero

If an uppercase character.

0

If not an uppercase character.

iswxdigit

Indicates if a wide character is a hexadecimal digit (0 to 9, A to F, or a to f) in the program's current locale.

Format

```
#include <wctype.h> (ISO C)
```

```
#include <wchar.h> (XPG4)
```

```
int iswxdigit (wint_t wc);
```

Argument

wc

An object of type `wint_t`. The value of `wc` must be representable as a `wchar_t` in the current locale, or must equal the value of the macro `WEOF`. If it has any other value, the behavior is undefined.

Return Values

nonzero	If a hexadecimal digit.
0	If not a hexadecimal digit.

isxdigit

isxdigit

Indicates if a character is a hexadecimal digit (0 to 9, A to F, or a to f) in the program's current locale.

Format

```
#include <ctype.h>
int isxdigit (int character);
```

Argument

character

An object of type `int`. The value of *character* must be representable as an unsigned `char` in the current locale, or must equal the value of the macro `EOF`. If it has any other value, the behavior is undefined.

Return Values

nonzero	If a hexadecimal digit.
0	If not a hexadecimal digit.

j0, j1, jn *(Integrity servers, Alpha)*

Compute Bessel functions of the first kind.

Format

```
#include <math.h>
double j0 (double x);
float j0f (float x);
long double j0l (long double x);
double j1 (double x);
float j1f (float x);
long double j1l (long double x);
double jn (int n, double x);
float jnf (int n, float x);
long double jnl (int n, long double x);
```

Arguments

x
A real value.

n
An integer.

Description

The `j0` functions return the value of the Bessel function of the first kind of order 0.

The `j1` functions return the value of the Bessel function of the first kind of order 1.

The `jn` functions return the value of the Bessel function of the first kind of order n .

The `j1` and `jn` functions can result in an underflow as x gets small. The largest value of x for which this occurs is a function of n .

Return Values

<code>x</code>	The relevant Bessel value of x of the first kind.
<code>0</code>	The value of the x argument is too large, or underflow occurred; <code>errno</code> is set to <code>ERANGE</code> .
<code>NaN</code>	x is <code>NaN</code> ; <code>errno</code> is set to <code>EDOM</code> .

jrand48

Generates uniformly distributed pseudorandom-number sequences. Returns 48-bit signed, long integers.

Format

```
#include <stdlib.h>

long int jrand48 (unsigned short int xsubi[3]);
```

Argument

xsubi

An array of three short ints that form a 48-bit integer when concatenated together.

Description

The `jrand48` function generates pseudorandom numbers using the linear congruential algorithm and 48-bit integer arithmetic.

The function returns signed long integers uniformly distributed over the range of y values, such that $-2^{31} \leq y < 2^{31}$.

The function works by generating a sequence of 48-bit integer values, X_i , according to the linear congruential formula:

$$X_{n+1} = (aX_n + c) \bmod m \quad n \geq 0$$

The argument m equals 2^{48} , so 48-bit integer arithmetic is performed. Unless you invoke the `lcong48` function, the multiplier value a and the addend value c are:

$$\begin{aligned} a &= 5DEECE66D_{16} = 2736731631558 \\ c &= B_{16} = 138 \end{aligned}$$

The `jrand48` function requires that the calling program pass an array as the `xsubi` argument, which for the first call must be initialized to the initial value of the pseudorandom-number sequence. Unlike the `drand48` function, it is not necessary to call an initialization function prior to the first call.

By using different arguments, `jrand48` allows separate modules of a large program to generate several independent sequences of pseudorandom numbers. For example, the sequence of numbers that one module generates does not depend upon how many times the function is called by other modules.

Return Value

n Signed, long integers uniformly distributed over the range $-2^{31} \leq y < 2^{31}$.

kill

Sends a signal to the process specified by a process ID.

Format

```
#include <signal.h>
int kill (int pid, int sig);
```

Arguments

pid
The process ID.

sig
The signal code.

Description

The kill function is restricted to C and C++ programs that include the main function.

The kill function sends a signal to a process, as if the process had called raise. If the signal is not trapped or ignored by the target program, the program exits.

OpenVMS VAX and Alpha implement different rules about what process you are allowed to send signals to. A program always has privileges to send a signal to a child started with vfork/exec. For other processes, the results are determined by the OpenVMS security model for your system.

Because of an OpenVMS restriction, the kill function cannot deliver a signal to a target process that runs an image installed with privileges.

Unless you have system privileges, the sending and receiving processes must have the same user identification code (UIC).

On OpenVMS systems before Version 7.0, kill treats a signal value of 0 as if SIGKILL were specified.

For OpenVMS Version 7.0 and higher systems, if you include <stdlib.h> and compile with the _POSIX_EXIT feature-test macro set, then:

- If the signal value is 0, kill validates the process ID but does not send any signals.
- If the process ID is not valid, kill returns -1 and sets errno to ESRCH.

Return Values

0	Indicates that kill was successfully queued.
-1	Indicates errors. The receiving process may have a different UIC and you are not a system user, or the receiving process does not exist.

labs

Returns the absolute value of an integer as a long int.

Format

```
#include <stdlib.h>
long int labs (long int j);
```

Argument

j
A value of type long int.

lchown

lchown

Changes the user and group ownership of the specified file.

Format

```
#include <unistd.h>
int lchown (const char *file_path, uid_t file_owner, gid_t file_group);
```

Arguments

file_path

The name of the file for which you want to change the owner and group IDs.

file_owner

The new user ID for the file.

file_group

The new group ID for the file.

Description

The `lchown` function changes the owner and/or group of the specified file (*file_path*). If the file is a symbolic link, the owner of the symbolic link is modified (in contrast to `chown` which would modify the file that the symbolic link points to).

See also `symlink`, `unlink`, `readlink`, `realpath`, and `lstat`.

Return Values

0	Successful completion.
-1	Indicates an error. <code>errno</code> is set to any <code>errno</code> value returned by <code>chown</code> .

lcong48

Initializes a 48-bit uniformly distributed pseudorandom-number sequence.

Format

```
#include <stdlib.h>
void lcong48 (unsigned short int param[7]);
```

Argument

param

An array that in turn specifies the initial X_i , the multiplier value a , and the addend value c .

Description

The `lcong48` function generates pseudorandom numbers using the linear congruential algorithm and 48-bit integer arithmetic.

You can use `lcong48` to initialize the random number generator before you call any of the following functions:

```
drand48
lrand48
mrand48
```

The `lcong48` function specifies the initial X_i value, the multiplier value a , and the addend value c . The *param* array elements specify the following:

<i>param</i> [0-2]	X_i
<i>param</i> [3-5]	Multiplier a value
<i>param</i> [6]	16-bit addend c value

After `lcong48` has been called, a subsequent call to either `srand48` or `seed48` restores the standard a and c as specified previously.

The `lcong48` function does not return a value.

See also `drand48`, `lrand48`, `mrand48`, `srand48`, and `seed48`.

ldexp

ldexp

Returns its first argument multiplied by 2 raised to the power of its second argument; that is, $x(2^n)$.

Format

```
#include <math.h>
double ldexp (double x, int n);
float ldexp (float x, int n); (Integrity servers, Alpha)
long double ldexp (long double x, int n); (Integrity servers, Alpha)
```

Arguments

x
A base value of type double, float, or long double that is to be multiplied by 2^n .

n
The integer exponent value to which 2 is raised.

Return Values

$x(2^n)$	The first argument multiplied by 2 raised to the power of the second argument.
0	Underflow occurred; errno is set to ERANGE.
HUGE_VAL	Overflow occurred; errno is set to ERANGE.
NaN	x is NaN; errno is set to EDOM.

ldiv

Returns the quotient and the remainder after the division of its arguments.

Format

```
#include <stdlib.h>
ldiv_t ldiv (long int numer, long int denom);
```

Arguments

numer

A numerator of type long int.

denom

A denominator of type long int.

Description

The type `ldiv_t` is defined in the `<stdlib.h>` header file as follows:

```
typedef struct
{
    long    quot, rem;
} ldiv_t;
```

See also `div`.

leaveok

leaveok

Signals Curses to leave the cursor at the current coordinates after an update to the window.

Format

```
#include <curses.h>
leaveok (WINDOW *win, bool boolf);
```

Arguments

win

A pointer to the window.

boolf

A Boolean TRUE or FALSE value. If *boolf* is TRUE, the cursor remains in place after the last update and the coordinate setting on *win* changes accordingly. If *boolf* is FALSE, the cursor moves to the currently specified (y,x) coordinates of *win*.

Description

The `leaveok` function defaults to moving the cursor to the current coordinates of *win*. The `bool` type is defined in the `<curses.h>` header file as follows:

```
#define bool int
```

lgamma *(Integrity servers, Alpha)*

Computes the logarithm of the gamma function.

Format

```
#include <math.h>
double lgamma (double x);
float lgammaf (float x);
long double lgammal (long double x);
```

Argument

x
A real number. x cannot be 0, a negative integer, or Infinity.

Description

The lgamma functions return the logarithm of the absolute value of gamma of x , or $\ln(| \Gamma(x) |)$, where Γ is the gamma function.

The sign of gamma of x is returned in the external integer variable `signgam`. The x argument cannot be 0, a negative integer, or Infinity.

Return Values

<code>x</code>	The logarithmic gamma of the x argument.
<code>-HUGE_VAL</code>	The x argument is a negative integer; <code>errno</code> is set to <code>ERANGE</code> .
<code>NaN</code>	The x argument is <code>NaN</code> ; <code>errno</code> is set to <code>EDOM</code> .
<code>0</code>	Underflow occurred; <code>errno</code> is set to <code>ERANGE</code> .
<code>HUGE_VAL</code>	Overflow occurred; <code>errno</code> is set to <code>ERANGE</code> .

link

link

Creates a new link (directory entry) for an existing file. This function is supported only on volumes that have hard link counts enabled.

Format

```
#include <unistd.h>
link (const char *path1, const char *path2);
```

Arguments

path1

Pointer to a pathname naming an existing file.

path2

Pointer to a pathname naming the new directory entry to be created.

Description

The link function atomically creates a new link for the existing file, and the link count of the file is incremented by one.

The link function can be used on directory files.

If link fails, no link is created and the link count of the file remains unchanged.

Return Values

0	Successful completion.
-1	Indicates an error. The function sets errno to one of the following values: <ul style="list-style-type: none">• EEXIST – The link named by <i>path2</i> exists.• EFTYPE – Wildcards appear in either <i>path1</i> or <i>path2</i>.• EINVAL – One or both arguments specify a syntactically invalid pathname.• ENAMETOOLONG – The length of <i>path1</i> or <i>path2</i> exceeds PATH_MAX, or a pathname component is longer than NAME_MAX.• EXDEV – The link named by <i>path2</i> and the filename by <i>path1</i> are on different devices.

localeconv

Sets the members of a structure of type `struct lconv` with values appropriate for formatting numeric quantities according to the rules of the current locale.

Format

```
#include <locale.h>

struct lconv *localeconv (void);
```

Description

The `localeconv` function returns a pointer to the `lconv` structure defined in the `<locale.h>` header file. This structure should not be modified by the program. It is overwritten by calls to `localeconv`, or by calls to the `setlocale` function that change the `LC_NUMERIC`, `LC_MONETARY`, or `LC_ALL` categories.

The members of the structure are:

Member	Description
<code>char *decimal_point</code>	The radix character.
<code>char *thousands_sep</code>	The character used to separate groups of digits.
<code>char *grouping</code>	The string that defines how digits are grouped in nonmonetary values.
<code>char *int_curr_symbol</code>	The international currency symbol.
<code>char *currency_symbol</code>	The local currency symbol.
<code>char *mon_decimal_point</code>	The radix character used to format monetary values.
<code>char *mon_thousands_sep</code>	The character used to separate groups of digits in monetary values.
<code>char *mon_grouping</code>	The string that defines how digits are grouped in a monetary value.
<code>char *positive_sign</code>	The string used to indicate a nonnegative monetary value.
<code>char *negative_sign</code>	The string used to indicate a negative monetary value.
<code>char int_frac_digits</code>	The number of digits displayed after the radix character in a monetary value formatted with the international currency symbol.
<code>char frac_digits</code>	The number of digits displayed after the radix character in a monetary value.
<code>char p_cs_precedes</code>	For positive monetary values, this is set to 1 if the local or international currency symbol precedes the number, and it is set to 0 if the symbol succeeds the number.

Member	Description
char p_sep_by_space	For positive monetary values, this is set to 0 if there is no space between the currency symbol and the number. It is set to 1 if there is a space, and it is set to 2 if there is a space between the symbol and the sign string.
char n_cs_precedes	For negative monetary values, this is set to 1 if the local or international currency symbol precedes the number, and it is set to 0 if the symbol succeeds the number.
char n_sep_by_space	For negative monetary values, this is set to 0 if there is no space between the currency symbol and the number. It is set to 1 if there is a space, and it is set to 2 if there is a space between the symbol and the sign string.
char p_sign_posn	An integer used to indicate where the <code>positive_sign</code> string should be placed for a nonnegative monetary quantity.
char n_sign_posn	An integer used to indicate where the <code>negative_sign</code> string should be placed for a negative monetary quantity.

Members of the structure of type `char*` are pointers to strings, any of which (except `decimal_point`) can point to "", indicating that the associated value is not available in the current locale or is zero length. Members of the structure of type `char` are positive numbers, any of which can be `CHAR_MAX`, indicating that the associated value is not available in the current locale. `CHAR_MAX` is defined in the `<limits.h>` header file.

Be aware that the value of the `CHAR_MAX` macro in the `<limits.h>` header depends on whether the program is compiled with the `/UNSIGNED_CHAR` qualifier:

- Use the `CHAR_MAX` macro as an indicator of a nonavailable value in the current locale only if the program is compiled *without* `/UNSIGNED_CHAR` (`/NOUNSIGNED_CHAR` is the default).
- If the program is compiled *with* `/UNSIGNED_CHAR`, use the `SCHAR_MAX` macro instead of the `CHAR_MAX` macro.

In `/NOUNSIGNED_CHAR` mode, the values of `CHAR_MAX` and `SCHAR_MAX` are the same; therefore, comparison with `SCHAR_MAX` gives correct results regardless of the `/[NO]UNSIGNED_CHAR` mode used.

The members `grouping` and `mon_grouping` point to a string that defines the size of each group of digits when formatting a number. Each group size is separated by a semicolon (;). For example, if `grouping` points to the string `5;3` and the `thousands_sep` character is a comma (,), the number `123450000` would be formatted as `1,234,50000`.

The elements of `grouping` and `mon_grouping` are interpreted as follows:

localeconv

```
/* Compare the international currency symbol string with an */
/* empty string. If they are equal, then the international */
/* currency symbol is not defined in the locale.          */
if (strcmp(lconv_ptr->int_curr_symbol, "")) {
    printf("International Currency Symbol = %s\n",
           lconv_ptr->int_curr_symbol);
}
else {
    printf("International Currency Symbol =");
    printf("[Not available in this locale]\n");
}

/* Compare International Fractional Digits with CHAR_MAX. */
/* If they are equal, then International Fractional Digits */
/* are not defined in this locale.                          */
if ((unsigned char) (lconv_ptr->int_frac_digits) != CHAR_MAX) {
    printf("International Fractional Digits = %d\n",
           lconv_ptr->int_frac_digits);
}
else {
    printf("International Fractional Digits =");
    printf("[Not available in this locale]\n");
}
}
```

Running the example program produces the following result:

```
International Currency Symbol = GBP
International Fractional Digits = 2
```

localtime, localtime_r

Convert a time value to broken-down local time.

Format

```
#include <time.h>
struct tm *localtime (const time_t *timer);
struct tm *localtime_r (const time_t *timer, struct tm *result); (ISO POSIX-1)
```

Function Variants

Compiling with the `_DECC_V4_SOURCE` and `_VMS_V6_SOURCE` feature-test macros defined enables a local-time-based entry point to the `localtime_r` function that is equivalent to the behavior before OpenVMS Version 7.0.

Arguments

timer

A pointer to a time in seconds since the Epoch. You can generate this time by using the `time` function or you can supply a time.

result

A pointer to a `tm` structure where the result is stored. The `tm` structure is defined in the `<time.h>` header file, and is also shown in Table REF-4.

Description

The `localtime` and `localtime_r` functions convert the time (in seconds since the Epoch) pointed to by `timer` into a broken-down time, expressed as a local time, and store it in a `tm` structure.

The difference between the `localtime_r` and `localtime` functions is that the former stores the result into a user-specified `tm` structure. The latter stores the result into thread-specific static memory allocated by the HP C RTL, and which is overwritten by subsequent calls to `localtime`; you must make a copy if you want to save it.

On success, `localtime` returns a pointer to the `tm` structure; `localtime_r` returns its second argument. On failure, these functions return the NULL pointer.

The `tm` structure is defined in the `<time.h>` header file and described in Table REF-4.

Table REF-4 tm Structure

<code>int tm_sec;</code>	Seconds after the minute (0-60)
<code>int tm_min;</code>	Minutes after the hour (0-59)
<code>int tm_hour;</code>	Hours since midnight (0-23)
<code>int tm_mday;</code>	Day of the month (1-31)
<code>int tm_mon;</code>	Months since January (1-11)

(continued on next page)

localtime, localtime_r

Table REF-4 (Cont.) tm Structure

int tm_year;	Years since 1900
int tm_wday;	Days since Sunday (0-6)
int tm_yday;	Days since January 1 (0-365)
int tm_isdst;	Daylight Savings Time flag
	<ul style="list-style-type: none">• tm_isdst = 0 for Standard Time• tm_isdst = 1 for Daylight Time
long tm_gmtoff; ¹	Seconds east of Greenwich (negative values indicate seconds west of Greenwich)
char *tm_zone; ¹	Time zone string, for example "GMT"

¹This field is an extension to the ANSI C structure. It is present unless you compile your program with /STANDARD=ANSI89 or with _DECC_V4_SOURCE defined.

The type time_t is defined in the <time.h> header file as follows:

```
typedef long int time_t
```

Note

Generally speaking, UTC-based time functions can affect in-memory time-zone information, which is processwide data. However, if the system time zone remains the same during the execution of the application (which is the common case) and the cache of timezone files is enabled (which is the default), then the _r variant of the time functions asctime_r, ctime_r, gmtime_r and localtime_r, is both thread-safe and AST-reentrant.

If, however, the system time zone can change during the execution of the application or the cache of timezone files is not enabled, then both variants of the UTC-based time functions belong to the third class of functions, which are neither thread-safe nor AST-reentrant.

Return Values

x	Pointer to a tm structure.
NULL	Indicates failure.

log, log2, log10

Return the logarithm of their arguments.

Format

```
#include <math.h>
double log (double x);
float logf (float x); (Integrity servers, Alpha)
long double logl (long double x); (Integrity servers, Alpha)
double log2 (double x); (Integrity servers, Alpha)
float log2f (float x); (Integrity servers, Alpha)
long double log2l (long double x); (Integrity servers, Alpha)
double log10 (double x);
float log10f (float x); (Integrity servers, Alpha)
long double log10l (long double x); (Integrity servers, Alpha)
```

Argument

x
A real number.

Description

The log functions compute the natural (base e) logarithm of x .

The log2 functions compute the base 2 logarithm of x .

The log10 functions compute the common (base 10) logarithm of x .

Return Values

x	The logarithm of the argument (in the appropriate base).
<code>-HUGE_VAL</code>	x is 0 (errno is set to ERANGE), or x is negative (errno is set to EDOM).
NaN	x is NaN; errno is set to EDOM.

log1p *(Integrity servers, Alpha)*

log1p *(Integrity servers, Alpha)*

Computes $\ln(1+y)$ accurately.

Format

```
#include <math.h>
double log1p (double y);
float log1pf (float y);
long double log1pl (long double y);
```

Argument

y
A real number greater than -1 .

Description

The `log1p` functions compute $\ln(1+y)$ accurately, even for tiny y .

Return Values

<code>x</code>	The natural logarithm of $(1+y)$.
<code>-HUGE_VAL</code>	y is less than -1 (<code>errno</code> is set to <code>EDOM</code>), or $y = -1$ (<code>errno</code> is set to <code>ERANGE</code>).
<code>NaN</code>	y is <code>NaN</code> ; <code>errno</code> is set to <code>EDOM</code> .

logb (*Integrity servers, Alpha*)

Returns the radix-independent exponent of the argument.

Format

```
#include <math.h>
double logb (double x);
float logbf (float x);
long double logbl (long double x);
```

Argument

x
A nonzero, real number.

Description

The `logb` functions return the exponent of x , which is the integral part of $\log_2 |x|$, as a signed floating-point value, for nonzero x .

Return Values

<code>x</code>	The exponent of x .
<code>-HUGE_VAL</code>	$x = 0.0$; <code>errno</code> is set to <code>EDOM</code> .
<code>+Infinity</code>	x is <code>+Infinity</code> or <code>-Infinity</code> .
<code>NaN</code>	y is <code>NaN</code> ; <code>errno</code> is set to <code>EDOM</code> .

longjmp

longjmp

Provides a way to transfer control from a nested series of function invocations back to a predefined point without returning normally; that is, by not using a series of return statements. The `longjmp` function restores the context of the environment buffer.

Format

```
#include <setjmp.h>

void longjmp (jmp_buf env, int value);
```

Arguments

env

The environment buffer, which must be an array of integers long enough to hold the register context of the calling function. The type `jmp_buf` is defined in the `<setjmp.h>` header file. The contents of the general-purpose registers, including the program counter (PC), are stored in the buffer.

value

Passed from `longjmp` to `setjmp`, and then becomes the subsequent return value of the `setjmp` call. If *value* is passed as 0, it is converted to 1.

Description

When `setjmp` is first called, it returns the value 0. If `longjmp` is then called, naming the same environment as the call to `setjmp`, control is returned to the `setjmp` call as if it had returned normally a second time. The return value of `setjmp` in this second return is the *value* you supply in the `longjmp` call. To preserve the true value of `setjmp`, the function calling `setjmp` must not be called again until the associated `longjmp` is called.

The `setjmp` function preserves the hardware general-purpose registers, and the `longjmp` function restores them. After a `longjmp`, all variables have their values as of the time of the `longjmp` except for local automatic variables not marked volatile. These variables have indeterminate values.

The `setjmp` and `longjmp` functions rely on the OpenVMS condition-handling facility to effect a nonlocal goto with a signal handler. The `longjmp` function is implemented by generating a HP C RTL specified signal and allowing the OpenVMS condition-handling facility to unwind back to the desired destination. The HP C RTL must be in control of signal handling for any HP C image.

For HP C to be in control of signal handling, you must establish all exception handlers through a call to the `VAXC$ESTABLISH` function (rather than `LIB$ESTABLISH`). See Section 4.2.5 and the `VAXC$ESTABLISH` function for more information.

Note

The C RTL provides nonstandard `decc$setjmp` and `decc$fast_longjmp` functions for Alpha and Integrity server systems. To use these nonstandard functions instead of the standard ones, a program must be compiled with the `__FAST_SETJMP` or `__UNIX_SETJMP` macros defined.

Unlike the standard `longjmp` function, the `decc$fast_longjmp` function does not convert its second argument from 0 to 1. After a call to `decc$fast_longjmp`, a corresponding `setjmp` function returns with the exact value of the second argument specified in the `decc$fast_longjmp` call.

Restrictions

You cannot invoke the `longjmp` function from an OpenVMS condition handler. However, you may invoke `longjmp` from a signal handler that has been established for any signal supported by the HP C RTL, subject to the following nesting restrictions:

- The `longjmp` function will not work if invoked from nested signal handlers. The result of the `longjmp` function, when invoked from a signal handler that has been entered as a result of an exception generated in another signal handler, is undefined.
- Do not invoke the `setjmp` function from a signal handler unless the associated `longjmp` is to be issued before the handling of that signal is completed.
- Do not invoke the `longjmp` function from within an exit handler (established with `atexit` or `SYS$DCLEXH`). Exit handlers are invoked after image tear-down, so the destination address of the `longjmp` no longer exists.
- Invoking `longjmp` from within a signal handler to return to the main thread of execution might leave your program in an inconsistent state. Possible side effects include the inability to perform I/O or to receive any more UNIX signals.

longname

longname

Returns the full name of the terminal.

Format

```
#include <curses.h>

void longname (char *termbuf, char *name);
```

Function Variants

The `longname` function has variants named `_longname32` and `_longname64` for use with 32-bit and 64-bit pointer sizes, respectively. See Section 1.9 for more information on using pointer-size-specific functions.

Arguments

termbuf

A string containing the name of the terminal.

name

A character-string buffer with a minimum length of 64 characters.

Description

The terminal name is in a readable format so that you can double-check to be sure that Curses has correctly identified your terminal. The dummy argument *termbuf* is required for UNIX software compatibility and serves no function in the OpenVMS environment. If portability is a concern, you must write a set of dummy routines to perform the functionality provided by the database `termcap` in the UNIX system environment.

lrand48

Generates uniformly distributed pseudorandom-number sequences. Returns 48-bit signed long integers.

Format

```
#include <stdlib.h>

long int lrand48 (void);
```

Description

The `lrand48` function generates pseudorandom numbers using the linear congruential algorithm and 48-bit integer arithmetic.

It returns nonnegative, long integers uniformly distributed over the range of y values such that $0 \leq y < 2^{31}$.

Before you call the `lrand48` function use either `srand48`, `seed48`, or `lcong48` to initialize the random-number generator. You must initialize prior to invoking the `lrand48` function, because it stores the last 48-bit X_i generated into an internal buffer. (Although it is not recommended, constant default initializer values are supplied automatically if the `drand48`, `lrand48`, or `mrnd48` functions are called without first calling an initialization function.)

The function works by generating a sequence of 48-bit integer values, X_i , according to the linear congruential formula:

$$X_{n+1} = (aX_n + c) \bmod m \quad n \geq 0$$

The argument m equals 2^{48} , so 48-bit integer arithmetic is performed. Unless you invoke the `lcong48` function, the multiplier value a and the addend value c are:

$$\begin{aligned} a &= 5DEECE66D_{16} = 2736731631558 \\ c &= B_{16} = 138 \end{aligned}$$

The value returned by the `lrand48` function is computed by first generating the next 48-bit X_i in the sequence. Then the appropriate bits, according to the type of data item to be returned, are copied from the high-order (most significant) bits of X_i and transformed into the returned value.

See also `drand48`, `lcong48`, `mrnd48`, `seed48`, and `srand48`.

Return Value

n	Signed nonnegative long integers uniformly distributed over the range $0 \leq y < 2^{31}$.
---	---

lseek

Positions a file to an arbitrary byte position and returns the new position.

Format

```
#include <unistd.h>
off_t lseek (int file_desc, off_t offset, int direction);
```

Arguments

file_desc

An integer returned by `open`, `creat`, `dup`, or `dup2`.

offset

The offset, specified in bytes. The `off_t` data type is either a 32-bit or a 64-bit integer. The 64-bit interface allows for file sizes greater than 2 GB, and can be selected at compile time by defining the `_LARGEFILE` feature-test macro as follows:

```
CC/DEFINE=_LARGEFILE
```

direction

An integer indicating whether the offset is to be measured forward from the beginning of the file (`direction=SEEK_SET`), forward from the current position (`direction=SEEK_CUR`), or backward from the end of the file (`direction=SEEK_END`).

Description

The `lseek` function can position a fixed-length record-access file with no carriage control or a stream-access file on any byte offset, but can position all other files only on record boundaries.

The available Standard I/O functions position a record file at its first byte, at the end-of-file, or on a record boundary. Therefore, the arguments given to `lseek` must specify either the beginning or end of the file, a 0 offset from the current position (an arbitrary record boundary), or the position returned by a previous, valid `lseek` call.

This function returns the new file position as an integer of type `off_t` which, like the *offset* argument, is either a 64-bit integer if `_LARGEFILE` is defined, or a 32-bit integer if not.

For a portable way to position an arbitrary byte location with any type of file, see the `fgetpos` and `fsetpos` functions.

Caution

If, while accessing a stream file, you seek beyond the end-of-file and then write to the file, the `lseek` function creates a hole by filling the skipped bytes with zeros.

In general, for record files, `lseek` should only be directed to an absolute position that was returned by a previous valid call to `lseek` or to the

beginning or end of a file. If a call to `lseek` does not satisfy these conditions, the results are unpredictable.

See also `open`, `creat`, `dup`, `dup2`, and `fseek`.

Return Values

<code>x</code>	The new file position.
<code>-1</code>	Indicates that the file descriptor is undefined, or a seek was attempted before the beginning of the file.

lstat (*Integrity servers, Alpha*)

lstat (*Integrity servers, Alpha*)

Retrieves information about the specified file.

Format

```
#include <sys/stat.h>
int lstat (const char *restrict file_path, struct stat *restrict user_buffer);
```

Arguments

file_path

The name of the file for which you want to retrieve information.

user_buffer

The `stat` structure in which information is returned.

Description

The `lstat` function retrieves information about the specified file (*file_path*). If the file is a symbolic link, information about the link itself is returned (in contrast to `stat`, which returns information about the file that the symbolic link points to).

See also `symlink`, `unlink`, `readlink`, `realpath`, and `lchown`.

Return Values

0	Successful completion.
-1	Indicates an error. <code>errno</code> is set to any <code>errno</code> value returned by <code>stat</code> .

lwait

Waits for I/O on a specific file to complete.

Format

```
#include <stdio.h>
int lwait (int fd);
```

Argument

fd
A file descriptor corresponding to an open file.

Description

The `lwait` function is used primarily to wait for completion of pending asynchronous I/O.

Return Values

0	Indicates successful completion.
-1	Indicates an error.

malloc

malloc

Allocates an area of memory. These functions are AST-reentrant.

Format

```
#include <stdlib.h>

void *malloc (size_t size);
```

Function Variants

The malloc function has variants named `_malloc32` and `_malloc64` for use with 32-bit and 64-bit pointer sizes, respectively. See Section 1.9 for more information on using pointer-size-specific functions.

Argument

size

The total number of bytes to be allocated.

Description

The malloc function allocates a contiguous area of memory whose size, in bytes, is supplied as an argument. The space is not initialized.

Note

The malloc routines call the system routine LIB\$VM_MALLOC. Because LIB\$VM_MALLOC is designed as a general-purpose routine to allocate memory, it is called upon in a wide array of scenarios to allocate and reallocate blocks efficiently. The most common usage is the management of smaller blocks of memory, and the most important aspect of memory allocation under these circumstances is efficiency.

LIB\$VM_MALLOC makes use of its own free space to satisfy requests, once the heap storage is consumed by splitting large blocks and merging adjacent blocks. Memory can still become fragmented, leaving unused blocks. Once heap storage is consumed, LIB\$VM_MALLOC manages its own free space and merged blocks to satisfy requests, but varying sizes of memory allocations can cause blocks to be left unused.

Because LIB\$VM_MALLOC cannot be made to satisfy all situations in the best possible manner, perform your own memory management if you have special memory usage needs. This assures the best use of memory for your particular application.

The *OpenVMS Programming Concepts Manual* explains the several memory allocation routines that are available. They are grouped into three levels of hierarchy:

1. At the highest level are the RTL Heap Management Routines LIB\$GET_VM and LIB\$FREE_VM, which provide a mechanism for allocating and freeing blocks of memory of arbitrary size. Also at this level are the routines based on the concept of zones, such as LIB\$CREATE_VM_ZONE, and so on.

2. At the next level are the RTL Page Management routines LIB\$GET_VM_PAGE and LIB\$FREE_VM_PAGE, which allocate a specified number of contiguous pages.
 3. At the lowest level are the Memory Management System Services, such as \$CRETVA and \$EXPREG, that provide extensive control over address space allocation. At this level, you must manage the allocation precisely.
-

The maximum amount of memory allocated at once is limited to 0xFFFFD000.

Return Values

x	The address of the first byte, which is aligned on a quadword boundary (<i>Alpha only</i>) or an octaword boundary (<i>Integrity servers only</i>).
NULL	Indicates that the function is unable to allocate enough memory. <code>errno</code> is set to <code>ENOMEM</code> .

mblen

mblen

Determines the number of bytes comprising a multibyte character.

Format

```
#include <stdlib.h>
int mblen (const char *s, size_t n);
```

Arguments

s
A pointer to the multibyte character.

n
The maximum number of bytes that comprise the multibyte character.

Description

If the character is *n* bytes or less, the `mblen` function returns the number of bytes comprising the multibyte character pointed to by *s*. If the character is greater than *n* bytes, the function returns `-1` to indicate an error.

This function is affected by the `LC_CTYPE` category of the program's current locale.

Return Values

<code>x</code>	The number of bytes that comprise the multibyte character, if the next <i>n</i> or fewer bytes form a valid character.
<code>0</code>	If <i>s</i> is <code>NULL</code> or a pointer to the <code>NULL</code> character.
<code>-1</code>	Indicates an error. The function sets <code>errno</code> to <code>EILSEQ</code> – Invalid character detected.

mbrlen

Determines the number of bytes comprising a multibyte character.

Format

```
#include <wchar.h>
size_t mbrlen (const char *s, size_t n, mbstate_t *ps);
```

Arguments

s

A pointer to a multibyte character.

n

The maximum number of bytes that comprise the multibyte character.

ps

A pointer to the `mbstate_t` object. If a NULL pointer is specified, the function uses its internal `mbstate_t` object. `mbstate_t` is an opaque datatype intended to keep the conversion state for the state-dependent codesets.

Description

The `mbrlen` function is equivalent to the call:

```
mbrtowc(NULL, s, n, ps != NULL ? ps : &internal)
```

Where *internal* is the `mbstate_t` object for the `mbrlen` function.

If the multibyte character pointed to by *s* is of *n* bytes or less, the function returns the number of bytes comprising the character (including any shift sequences).

If either an encoding error occurs or the next *n* bytes contribute to an incomplete but potentially valid multibyte character, the function returns `-1` or `-2`, respectively.

See also `mbrtowc`.

Return Values

x	The number of bytes comprising the multibyte character.
0	Indicates that <i>s</i> is a NULL pointer or a pointer to a null byte.
-1	Indicates an encoding error, in which case the next <i>n</i> or fewer bytes do not contribute to a complete and valid multibyte character. <code>errno</code> is set to <code>EILSEQ</code> ; the conversion state is undefined.
-2	Indicates an incomplete but potentially valid multibyte character (all <i>n</i> bytes have been processed).

mbrtowc

Converts a multibyte character to its wide-character representation.

Format

```
#include <wchar.h>
size_t mbrtowc (wchar_t *pwc, const char *s, size_t n, mbstate_t *ps);
```

Arguments

pwc

A pointer to the resulting wide-character code.

s

A pointer to a multibyte character.

n

The maximum number of bytes that comprise the multibyte character.

ps

A pointer to the `mbstate_t` object. If a NULL pointer is specified, the function uses its internal `mbstate_t` object. `mbstate_t` is an opaque datatype intended to keep the conversion state for the state-dependent codesets.

Description

If *s* is a NULL pointer, `mbrtowc` is equivalent to the call:

```
mbrtowc(NULL, "", 1, ps)
```

In this case, the values of *pwc* and *n* are ignored.

If *s* is not a NULL pointer, `mbrtowc` inspects at most *n* bytes beginning with the byte pointed to by *s* to determine the number of bytes needed to complete the next multibyte character (including any shift sequences).

If the function determines that the next multibyte character is completed, it determines the value of the corresponding wide character and then, if *pwc* is not a NULL pointer, stores that value in the object pointed to by *pwc*. If the corresponding wide character is the null wide character, the resulting state described is the initial conversion state.

If `mbrtowc` is called as a counting function, which means that *pwc* is a NULL pointer and *s* is neither a NULL pointer nor a pointer to a null byte, the value of the internal `mbstate_t` object will remain unchanged.

Return Values

x	The number of bytes comprising the multibyte character.
0	The next <i>n</i> or fewer bytes complete the multibyte character that corresponds to the null wide character (which is the value stored if <i>pwc</i> is not a NULL pointer). The wide-character code corresponding to a null byte is zero.
-1	Indicates an encoding error. The next <i>n</i> or fewer bytes do not contribute to a complete and valid multibyte character. <code>errno</code> is set to <code>EILSEQ</code> . The conversion state is undefined.
-2	Indicates an incomplete but potentially valid multibyte character (all <i>n</i> bytes have been processed).

mbstowcs

mbstowcs

Converts a sequence of multibyte characters into a sequence of corresponding wide-character codes.

Format

```
#include <stdlib.h>

size_t mbstowcs (wchar_t *pwcs, const char *s, size_t n);
```

Arguments

pwcs

A pointer to the array containing the resulting sequence of wide-character codes.

s

A pointer to the array of multibyte characters.

n

The maximum number of wide-character codes that can be stored in the array pointed to by *pwcs*.

Description

The `mbstowcs` function converts a sequence of multibyte characters from the array pointed to by *s* to a sequence of wide-character codes that are stored into the array pointed to by *pwcs*, up to a maximum of *n* codes.

This function is affected by the `LC_CTYPE` category of the program's current locale. If copying takes place between objects that overlap, the behavior is undefined.

Return Values

<code>x</code>	The number of array elements modified or required, not including any terminating zero code. The array will not be zero-terminated if the value returned is <i>n</i> . If <i>pwcs</i> is the NULL pointer, <code>mbstowcs</code> returns the number of elements required for the wide-character array.
<code>(size_t) -1</code>	Indicates that an error occurred. The function sets <code>errno</code> to <code>EILSEQ</code> - Invalid character detected.

mbtowc

Converts a multibyte character to its wide-character equivalent.

Format

```
#include <stdlib.h>
int mbtowc (wchar_t *pwc, const char *s, size_t n);
```

Arguments

pwc

A pointer to the resulting wide-character code.

s

A pointer to the multibyte character.

n

The maximum number of bytes that comprise the next multibyte character.

Description

If the character is n or fewer bytes, the `mbtowc` function converts the multibyte character pointed to by s to its wide-character equivalent. If the character is invalid or greater than n bytes, the function returns -1 to indicate an error.

If pwc is a NULL pointer and s is not a null pointer, the function determines the number of bytes that constitute the multibyte character pointed to by s (regardless of the value of n).

This function is affected by the `LC_CTYPE` category of the program's current locale.

Return Values

x	The number of bytes that comprise the valid character pointed to by s .
0	If s is either a NULL pointer or a pointer to the null byte.
-1	Indicates an error. The function sets <code>errno</code> to <code>EILSEQ</code> – Invalid character detected.

mbsinit

mbsinit

Determines whether an `mbstate_t` object describes an initial conversion state.

Format

```
#include <wchar.h>
int mbsinit (const mbstate_t *ps);
```

Argument

ps

A pointer to the `mbstate_t` object. `mbstate_t` is an opaque datatype intended to keep the conversion state for the state-dependent codesets.

Description

If *ps* is not a NULL pointer, the `mbsinit` function determines whether the `mbstate_t` object pointed to by *ps* describes an initial conversion state. A zero `mbstate_t` object always describes an initial conversion state.

Return Values

nonzero	The <i>ps</i> argument is a NULL pointer, or the <code>mbstate_t</code> object pointed to by <i>ps</i> describes an initial conversion state.
0	The <code>mbstate_t</code> object pointed to by <i>ps</i> does not describe an initial conversion state.

mbsrtowcs

Converts a sequence of multibyte characters to a sequence of corresponding wide-character codes.

Format

```
#include <wchar.h>

size_t mbsrtowcs (wchar_t *dst, const char **src, size_t len, mbstate_t *ps);
```

Function Variants

The `mbsrtowcs` function has variants named `_mbsrtowcs32` and `_mbsrtowcs64` for use with 32-bit and 64-bit pointer sizes, respectively. See Section 1.9 for more information on using pointer-size-specific functions.

Arguments

dst

A pointer to the destination array containing the resulting sequence of wide-character codes.

src

An address of the pointer to an array containing a sequence of multibyte characters to be converted.

len

The maximum number of wide character codes that can be stored in the array pointed to by *dst*.

ps

A pointer to the `mbstate_t` object. If a NULL pointer is specified, the function uses its internal `mbstate_t` object. `mbstate_t` is an opaque datatype intended to keep the conversion state for the state-dependent codesets.

Description

The `mbsrtowcs` function converts a sequence of multibyte characters, beginning in the conversion state described by the object pointed to by *ps*, from the array indirectly pointed to by *src*, into a sequence of corresponding wide characters.

If *dst* is not a NULL pointer, the converted characters are stored into the array pointed to by *dst*. Conversion continues up to and including a terminating null character, which is also stored.

Conversion stops earlier for one of the following reasons:

- A sequence of bytes is encountered that does not form a valid multibyte character.
- If *dst* is not a NULL pointer, when *len* codes have been stored into the array pointed to by *dst*.

mbsrtowcs

If *dst* is not a NULL pointer, the pointer object pointed to by *src* is assigned either a NULL pointer (if the conversion stopped because of reaching a terminating null wide character), or the address just beyond the last multibyte character converted (if any). If conversion stopped because of reaching a terminating null wide character, the resulting state described is the initial conversion state.

Return Values

n	The number of multibyte characters successfully converted, sequence, not including the terminating null (if any).
-1	Indicates an error. A sequence of bytes that do not form valid multibyte character was encountered. <code>errno</code> is set to <code>EILSEQ</code> ; the conversion state is undefined.

memccpy

Copies characters sequentially between strings in memory areas.

Format

```
#include <string.h>

void *memccpy (void *dest, void *source, int c, size_t n);
```

Function Variants

The memccpy function has variants named `_memccpy32` and `_memccpy64` for use with 32-bit and 64-bit pointer sizes, respectively. See Section 1.9 for more information on using pointer-size-specific functions.

Arguments

dest

A pointer to the location of a destination string.

source

A pointer to the location of a source string.

c

A character that you want to search for.

n

The number of character you want to copy.

Description

The memccpy function operates on strings in memory areas. A memory area is a group of contiguous characters bound by a count and not terminated by a null character. The function does not check for overflow of the receiving memory area. The memccpy function is defined in the `<string.h>` header file.

The memccpy function sequentially copies characters from the location pointed to by *source* into the location pointed to by *dest* until one of the following occurs:

- The character specified by *c* (converted to an unsigned char) is copied.
- The number of characters specified by *n* is copied.

Return Values

x	A pointer to the character following the character specified by <i>c</i> in the string pointed to by <i>dest</i> .
NULL	Indicates an error. The character <i>c</i> is not found after scanning <i>n</i> characters in the string.

memchr

memchr

Locates the first occurrence of the specified byte within the initial *size* bytes of a given object.

Format

```
#include <string.h>

void *memchr (const void *s1, int c, size_t size);
```

Function Variants

The `memchr` function has variants named `_memchr32` and `_memchr64` for use with 32-bit and 64-bit pointer sizes, respectively. See Section 1.9 for more information on using pointer-size-specific functions.

Arguments

s1
A pointer to the object to be searched.

c
The byte value to be located.

size
The length of the object to be searched.

If *size* is zero, `memchr` returns `NULL`.

Description

Unlike `strchr`, the `memchr` function does not stop when it encounters a null character.

Return Values

pointer	A pointer to the first occurrence of the byte.
<code>NULL</code>	Indicates that the specified byte does not occur in the object.

memcmp

Compares two objects, byte by byte. The compare operation starts with the first byte in each object.

Format

```
#include <string.h>

int memcmp (const void *s1, const void *s2, size_t size);
```

Arguments

s1

A pointer to the first object.

s2

A pointer to the second object.

size

The length of the objects to be compared.

If *size* is zero, the two objects are considered equal.

Description

The memcmp function uses native byte comparison. The sign of the value returned is determined by the sign of the difference between the values of the first pair of unlike bytes in the objects being compared. Unlike the strcmp function, the memcmp function does not stop when a null character is encountered.

Return Value

x

An integer less than, equal to, or greater than 0, depending on whether the lexical value of the first object is less than, equal to, or greater than that of the second object.

mkdir

Creates a directory.

Format

```
#include <stat.h>
```

```
int mkdir (const char *dir_spec, mode_t mode); (ISO POSIX-1)
```

```
int mkdir (const char *dir_spec, mode_t mode, ... ); (HP C Extension)
```

Arguments

dir_spec

A valid OpenVMS or UNIX style directory specification that may contain a device name. For example:

```
DBA0:[BAY.WINDOWS] /* OpenVMS */
/dba0/bay/windows /* UNIX style */
```

This specification cannot contain a node name, filename, file extension, file version, or a wildcard character. The same restriction applies to the UNIX style directory specifications. For more information about the restrictions on UNIX style specifications, see Chapter 1.

mode

A file protection. See the `chmod` function in this section for information about the specific file protections.

The file protection of the new directory is derived from the *mode* argument, the process's file protection mask (see the `umask` function), and the parent-directory default protections.

In a manner consistent with the OpenVMS behavior for creating directories, `mkdir` never applies delete access to the directory. An application that needs to set delete access should use an explicit call to `chmod` to set write permission.

See the Description section of this function for more information about how the file protection is set for the newly created directory.

...

Represents the following optional arguments. These arguments have fixed position in the argument list, and cannot be arbitrarily placed.

unsigned int **uic**

The user identification code (UIC) that identifies the owner of the created directory. If this argument is 0, the HP C RTL gives the created directory the UIC of the parent directory. If this argument is not specified, the HP C RTL gives the created directory your UIC. This optional argument is specific to the HP C RTL and is not portable.

unsigned short **max_versions**

The maximum number of file versions to be retained in the created directory. The system automatically purges the directory keeping, at most, *max_versions* number of every file.

If this argument is 0, the HP C RTL does not place a limit on the maximum number of file versions.

mkdir

If this argument is not specified, the HP C RTL gives the created directory the default version limit of the parent directory.

This optional argument is specific to the HP C RTL and is not portable.

unsigned short **r_v_number**

The volume (device) on which to place the created directory if the device is part of a volume set. If this argument is not specified, the HP C RTL arbitrarily places the created directory within the volume set. This optional argument is specific to the HP C RTL and is not portable.

Description

If *dir_spec* specifies a path that includes directories, which do not exist, intermediate directories are also created. This differs from the behavior of the UNIX system where these intermediate directories must exist and will not be created.

If you do not specify any optional arguments, the HP C RTL gives the directory your UIC and the default version limit of the parent directory, and arbitrarily places the directory within the volume set. You cannot get the default behavior for the *uic* or *max_versions* arguments if you specify any arguments after them.

Note

The way to create files with OpenVMS RMS default protections using the UNIX system-call functions `umask`, `mkdir`, `creat`, and `open` is to call `mkdir`, `creat`, and `open` with a file-protection mode argument of 0777 in a program that never specifically calls `umask`. These default protections include correctly establishing protections based on ACLs, previous versions of files, and so on.

In programs that do `vfork/exec` calls, the new process image inherits whether `umask` has ever been called or not from the calling process image. The `umask` setting and whether the `umask` function has ever been called are both inherited attributes.

The file protection supplied by the *mode* argument is modified by the process's file protection mask in such a way that the file protection for the new directory is set to the bitwise AND of the *mode* argument and the complement of the file protection mask.

Default file protections are supplied to the new directory from the parent-directory such that if a protection value bit in the new directory is zero, then the value of this bit is inherited from the parent directory. However, bits in the parent directory's file protection that indicate delete access do not cause corresponding bits to be set in the new directory's file protection.

Return Values

0	Indicates success.
-1	Indicates failure.

Examples

```
1. umask (0002); /* turn world write access off */
   mkdir ("sys$disk:[.parentdir.childdir]", 0222); /* turn write
                                                    access on */
```

Parent directory file protection: System:RWD, Owner:RWD, Group:R,
World:R

The file protection derived from the combination of the mode argument and the file protection mask set by umask is (0222) & ~(0002), which is 0220. When the parent directory defaults are applied to this protection, the protection for the new directory becomes:

File protection: System:RWD, Owner:RWD, Group:RWD, World:R

```
2. umask (0000);
   mkdir ("sys$disk:[.parentdir.childdir]", 0444); /* turn read
                                                    access on */
```

Parent directory file protection: System:RWD, Owner:RWD,
Group:RWD, World:RWD

The file protection derived from the combination of the mode argument and the file protection mask set by umask is (0444) & ~(0000), which is 0444. When the parent directory defaults are applied to this protection, the protection for the new directory is:

File protection: System:RW, Owner:RW, Group:RW, World:RW

Note that delete access is not inherited.

mkstemp

mkstemp

Constructs a unique filename.

Format

```
#include <stdlib.h>
int mkstemp (char *template);
```

Argument

template

A pointer to a string that is replaced with a unique filename. The string in the *template* argument must be a filename with six trailing Xs.

Description

The `mkstemp` function replaces the six trailing Xs of the string pointed to by *template* with a unique set of characters, and returns a file descriptor for the file open for reading and writing.

The string pointed to by *template* should look like a filename with six trailing X's. The `mkstemp` function replaces each X with a character from the portable file-name character set, making sure not to duplicate an existing filename.

If the string pointed to by *template* does not contain six trailing Xs, `-1` is returned.

Return Values

x	An open file descriptor.
-1	Indicates an error. (The string pointed to by <i>template</i> does not contain six trailing Xs.)

mktemp

Creates a unique filename from a template.

Format

```
#include <stdlib.h>
char *mktemp (char *template);
```

Function Variants

The `mktemp` function has variants named `_mktemp32` and `_mktemp64` for use with 32-bit and 64-bit pointer sizes, respectively. See Section 1.9 for more information on using pointer-size-specific functions.

Argument

template

A pointer to a buffer containing a user-defined template. You supply the template in the form, `namXXXXXX`. The six trailing Xs are replaced by a unique series of characters. You may supply the first three characters. Because the template argument is overwritten, do not specify a string literal (const object).

Description

The use of `mktemp` is not recommended for new applications. See the `tmpnam` and `mkstemp` functions for the preferable alternatives.

Return Value

x	A pointer to the template, with the template modified to contain the created filename. If this value is a pointer to a null string, it indicates that a unique filename cannot be created.
---	--

mktime

mktime

Converts a local-time structure to a time, in seconds, since the Epoch.

Format

```
#include <time.h>
time_t mktime (struct tm *timeptr);
```

Function Variants

Compiling with the `_DECC_V4_SOURCE` and `_VMS_V6_SOURCE` feature-test macros defined enables a local-time-based entry point to the `mktime` function that is equivalent to the behavior before OpenVMS Version 7.0.

Argument

timeptr

A pointer to the local-time structure.

Description

The `mktime` function converts a local-time structure (`struct tm`) pointed to by *timeptr*, to a time in seconds since the Epoch (a `time_t` variable), in the same manner as the values returned by the `time` function.

The original values of the `tm_wday` and `tm_yday` components of the structure are ignored, and the original values of the other components are not restricted to the ranges defined in `<time.h>`. Upon successful completion, the `tm_wday` and `tm_yday` components of the structure are set appropriately, and the other components are set to represent the specified time, with their values forced to the normal range.

If the local time cannot be encoded, then `mktime` returns the value `(time_t)(-1)`.

The `time_t` type is defined in the `<time.h>` header file as follows:

```
typedef unsigned long int time_t;
```

Local time-zone information is set as if `mktime` called `tzset`.

If the `tm_isdst` field in the local-time structure pointed to by *timeptr* is positive, `mktime` initially presumes that Daylight Savings Time (DST) is in effect for the specified time.

If `tm_isdst` is 0, `mktime` initially presumes that DST is not in effect.

If `tm_isdst` is negative, `mktime` attempts to determine whether or not DST is in effect for the specified time.

Return Values

x	The specified calendar time encoded as a value of type <code>time_t</code> .
---	--

`(time_t)(-1)`

If the local time cannot be encoded.

Be aware that a return value of `(time_t)(-1)` can also represent the valid date: Sun Feb 7 06:28:15 2106.

mmap

mmap

Maps file system object into virtual memory. This function is reentrant.

Format

```
#include <types.h>
```

```
#include <mman.h>
```

```
void mmap (void *addr, size_t len, int prot, int flags, int filedes, off_t off); (X/Open, POSIX-1)
```

```
void mmap (void *addr, size_t len, int prot, int flags, int filedes, off_t off ...); (HP C Extension)
```

Function Variants

The `mmap` function has variants named `_mmap32` and `_mmap64` for use with 32-bit and 64-bit pointer sizes, respectively. See Section 1.9 for more information on using pointer-size-specific functions.

Arguments

addr

The starting address of the new region (must be the page boundary).

len

The length, in bytes, of the new region.

prot

Access permission, as defined in the `<mman.h>` header file. Specify either `PROT_NONE`, `PROT_READ`, or `PROT_WRITE`.

flags

Attributes of the mapped region as the results of a bitwise-inclusive OR operation on any combination of the following:

- `MAP_FILE` or `MAP_ANONYMOUS`
- `MAP_VARIABLE` or `MAP_FIXED`
- `MAP_SHARED` or `MAP_PRIVATE`

filedes

The file that you want to map to the new mapped file region returned by the `open` function.

off

The offset, specified in bytes. The `off_t` data type is either a 64-bit or 32-bit integer. The 64-bit interface allows for file sizes greater than 2 GB, and can be selected at compile time by defining the `_LARGEFILE` feature-test macro as follows:

```
CC/DEFINE=_LARGEFILE
```

```
...
```

An optional integer specifying additional flags for the `SYS$CRMPSC` system service for `MAP_SHARED`. This optional argument (HP C Extension) of the `mmap` function was introduced in OpenVMS Version 7.2.

Description

The `mmap` function creates a new mapped file region, a new private region, or a new shared memory region.

Your application must ensure correct synchronization when using `mmap` in conjunction with any other file access method, such as `read` and `write`, and standard input/output.

Before calling `mmap`, the calling application must also ensure that all bytes in the range `[off, off+len]` are written to the file (using the `fsync` function, for example). If this requirement is not met, `mmap` fails with `errno` set to `ENXIO` (No such device or address).

The `addr` and `len` arguments specify the requested starting address and length, in bytes, for the new region. The address is a multiple of the page size returned by `sysconf(_SC_PAGE_SIZE)`.

If the `len` argument is not a multiple of the page size returned by `sysconf(_SC_PAGE_SIZE)`, then the result of any reference to an address between the end of the region and the end of the page containing the end of the region is undefined.

The `flags` argument specifies attributes of the mapped region. Values for `flags` are constructed by a bitwise-inclusive OR operation on the flags from the following list of symbolic names defined in the `<mman.h>` header file:

<code>MAP_FILE</code>	Create a mapped file region.
<code>MAP_ANONYMOUS</code>	Create an unnamed memory region.
<code>MAP_VARIABLE</code>	Place region at the computed address.
<code>MAP_FIXED</code>	Place region at fixed address.
<code>MAP_SHARED</code>	Share changes.
<code>MAP_PRIVATE</code>	Changes are private.

The `MAP_FILE` and `MAP_ANONYMOUS` flags control whether the region you want to map is a mapped file region or an anonymous shared memory region. One of these flags must be selected.

If `MAP_FILE` is set in the `flags` argument:

- A new mapped file region is created, mapping the file associated with the `filedes` argument.
- The `off` argument specifies the file byte offset where the mapping starts. This offset must be a multiple of the page size returned by `sysconf(_SC_PAGE_SIZE)`.
- If the end of the mapped file region is beyond the end of the file, the result of any reference to an address in the mapped file region corresponding to an offset beyond the end of the file is unspecified.

If `MAP_ANONYMOUS` is set in the `flags` argument:

- A new memory region is created and initialized to all zeros.
- The `filedes` argument is ignored.

mmap

The new region is placed at the requested address if the requested address is not null and it is possible to place the region at this address. When the requested address is null or the region cannot be placed at the requested address, the `MAP_VARIABLE` and `MAP_FIXED` flags control the placement of the region. One of these flags must be selected.

If `MAP_VARIABLE` is set in the *flags* argument:

- If the requested address is null or if it is not possible for the system to place the region at the requested address, the region is placed at an address selected by the system.

If `MAP_FIXED` is set in the *flags* argument:

- If the requested address is not null, the `mmap` function succeeds even if the requested address is already part of another region. (If the address is within an existing region, the effect on the pages within that region and within the area of the overlap produced by the two regions is the same as if they were unmapped. In other words, whatever is mapped between *addr* and *addr + len* is unmapped.)
- If the requested address is null and `MAP_FIXED` is specified, the results are undefined.

The `MAP_PRIVATE` and `MAP_SHARED` flags control the visibility of modifications to the mapped file or shared memory region. One of these flags must be selected.

If `MAP_SHARED` is set in the *flags* argument:

- If the region is a mapped region, modifications to the region are visible to other processes that mapped the same region using `MAP_SHARED`.
- If the region is a mapped file region, modifications to the region are written to the file. (Note that the modifications are not immediately written to the file because of buffer cache delay; that is, the write to the file does not occur until there is a need to reuse the buffer cache. If the modifications must be written to the file immediately, use the `msync` function to ensure that this is done.)

If `MAP_PRIVATE` is set in the *flags* argument:

- Modifications to the mapped region by the calling process are not visible to other processes that mapped the same region using either `MAP_PRIVATE` or `MAP_SHARED`.
- Modifications to the mapped region by the calling process are not written to the file.

It is unspecified whether modifications by processes that mapped the region using `MAP_SHARED` are visible to other processes that mapped the same region using `MAP_PRIVATE`.

The *prot* argument specifies access permissions for the mapped region. Specify one of the following:

<code>PROT_NONE</code>	No access
<code>PROT_READ</code>	Read-only
<code>PROT_WRITE</code>	Read/Write access

After the successful completion of the `mmap` function, you can close the *filedes* argument without effect on the mapped region or on the contents of the mapped file. Each mapped region creates a file reference, similar to an open file descriptor, that prevents the file data from being deallocated.

Note

The following rules apply to OpenVMS specific file references:

- Because of the additional file reference, if *filedes* is not opened for file sharing, `mmap` reopens it with file sharing enabled.
 - The additional file reference that remains for mapped regions implies that a later `open`, `fopen`, or `create` call to the file that is mapped must specify file sharing.
-

Modifications made to the file using the `write` function are visible to mapped regions, and modifications to a mapped region are visible with the `read` function.

Note

Beginning with OpenVMS Version 7.2, while processing a `MAP_SHARED` request, the `mmap` function constructs the *flags* argument of the `SYS$CRMPSC` service as a bitwise inclusive OR of those bits it sets by itself to fulfill the `MAP_SHARED` request and those bits specified by the caller in the optional argument.

By default, for `MAP_SHARED` the `mmap` function creates a temporary group global section. The optional `mmap` argument provides the caller with direct access to the features of the `SYS$CRMPSC` system service.

Using the optional argument, the caller can create, for example, a system global section (`SEC$M_SYSGBL` bit) or permanent global section (`SEC$M_PERM` bit). For example, to create a system permanent global section, the caller can specify `(SEC$M_SYSGBL | SEC$M_PERM)` in the optional argument.

The `mmap` function does not check or set any privileges. It is the responsibility of the caller to set appropriate privileges, such as `SYSGBL` privilege for `SEC$M_SYSGBL`, and `PRMGBL` for `SEC$M_PERM`, before calling `mmap` with the optional argument.

See also `read`, `write`, `open`, `fopen`, `creat`, and `sysconf`.

mmap

Return Values

x

MAP_FAILED

The address where the mapping is placed.

Indicates an error; `errno` is set to one of the following values:

- `EACCES` – The file referred to by *filedes* is not open for read access, or the file is not open for write access and `PROT_WRITE` was set for a `MAP_SHARED` mapping operation.
- `EBADF` – The *filedes* argument is not a valid file descriptor.
- `EINVAL` – The *flags* or *prot* argument is invalid, or the *addr* argument or *off* argument is not a multiple of the page size returned by `sysconf(_SC_PAGE_SIZE)`.
- `ENODEV` – The file descriptor *filedes* refers to an object that cannot be mapped, such as a terminal.
- `ENOMEM` – There is not enough address space to map *len* bytes.
- `ENXIO` – The addresses specified by the range [*off*, *off* + *len*] are invalid for *filedes*.
- `EFAULT` – The *addr* argument is an invalid address.

modf

Decomposes a floating-point number.

Format

```
#include <math.h>
double modf (double x, double *iptr);
float modff (float x, float *iptr); (Integrity servers, Alpha)
long double modfl (long double x, long double *iptr); (Integrity servers, Alpha)
```

Arguments

x
An object of type double, float, or long double.

iptr
A pointer to an object of type double, float, or long double to match the type of *x*.

Description

The modf functions decompose their first argument *x* into a positive fractional part *f* and an integer part *i*, each of which has the same sign as *x*.

The functions return *f* and assign *i* to the object pointed to by the second argument (*iptr*).

Return Values

<i>x</i>	The fractional part of the argument <i>x</i> .
NaN	<i>x</i> is NaN; errno is set to EDOM and * <i>iptr</i> is set to NaN.
0	Underflow occurred; errno is set to ERANGE.

[w]move

[w]move

Change the current cursor position on the specified window to the coordinates (y,x) . The move function acts on the `stdscr` window.

Format

```
#include <curses.h>
int move (int y, int x);
int wmove (WINDOW *win, int y, int x);
```

Arguments

win
A pointer to the window.

y
A window coordinate.

x
A window coordinate.

Description

For more information, see the `scrollok` function in this section.

Return Values

OK	Indicates success.
ERR	Indicates that the function makes the screen scroll illegally.

mprotect

Modifies access protections of memory mapping. This function is reentrant.

Format

```
#include <mman.h>
int mprotect (void *addr, size_t len, int prot);
```

Arguments

addr

The address of the region that you want to modify.

len

The length, in bytes, of the region that you want to modify.

prot

Access permission, as defined in the <mman.h> header file. Specify either PROT_NONE, PROT_READ, or PROT_WRITE.

Description

The `mprotect` function modifies the access protection of a mapped file or shared memory region.

The *addr* and *len* arguments specify the address and length, in bytes, of the region that you want to modify. The *len* argument must be a multiple of the page size as returned by `sysconf(_SC_PAGE_SIZE)`. If *len* is not a multiple of the page size as returned by `sysconf(_SC_PAGE_SIZE)`, the length of the region is rounded up to the next multiple of the page size.

The *prot* argument specifies access permissions for the mapped region. Specify one of the following:

PROT_NONE	No access
PROT_READ	Read-only
PROT_WRITE	Read/Write access

The `mprotect` function does not modify the access permission of any region that lies outside of the specified region, except that the effect on addresses between the end of the region, and the end of the page containing the end of the region, is unspecified.

If the `mprotect` function fails under a condition other than that specified by `EINVAL`, the access protection of some of the pages in the range [*addr*, *addr* + *len*] can change. Suppose the error occurs on some page at an *addr2*; `mprotect` can modify protections of all whole pages in the range [*addr*, *addr2*].

See also `sysconf`.

mprotect

Return Values

- | | |
|----|---|
| 0 | Indicates success. |
| -1 | Indicates an error; <code>errno</code> is set to one of the following values: <ul style="list-style-type: none">• <code>EACCESS</code> – The <i>prot</i> argument specifies a protection that conflicts with the access permission set for the underlying file.• <code>EINVAL</code> – The <i>prot</i> argument is invalid, or the <i>addr</i> argument is not a multiple of the page size as returned by <code>sysconf(_SC_PAGE_SIZE)</code>.• <code>EFAULT</code> – The range [<i>addr</i>, <i>addr + len</i>] includes an invalid address. |

mrand48

Generates uniformly distributed pseudorandom-number sequences. Returns 48-bit signed long integers.

Format

```
#include <stdlib.h>

long int mrand48 (void);
```

Description

The `mrand48` function generates pseudorandom numbers using the linear congruential algorithm and 48-bit integer arithmetic.

It returns signed long integers uniformly distributed over the range of y values such that $-2^{31} \leq y < 2^{31}$.

Before you call the `mrand48` function, use either `srand48`, `seed48`, or `lcong48` to initialize the random-number generator. You must initialize the `mrand48` function prior to invoking it, because it stores the last 48-bit X_i generated into an internal buffer. (Although it is not recommended, constant default initializer values are supplied automatically if the `drand48`, `lrand48`, or `mrand48` functions are called without first calling an initialization function.)

The function works by generating a sequence of 48-bit integer values, X_i , according to the linear congruential formula:

$$X_{n+1} = (aX_n + c) \bmod m \quad n \geq 0$$

The argument m equals 2^{48} , so 48-bit integer arithmetic is performed. Unless you invoke the `lcong48` function, the multiplier value a and the addend value c are:

$$\begin{aligned} a &= 5DEECE66D_{16} = 2736731631558 \\ c &= B_{16} = 138 \end{aligned}$$

The values returned by the `mrand48` function is computed by first generating the next 48-bit X_i in the sequence. Then the appropriate bits, according to the type of returned data item, are copied from the high-order (most significant) bits of X_i and transformed into the returned value.

See also `drand48`, `lrand48`, `lcong48`, `seed48`, and `srand48`.

Return Value

n	Returns signed long integers uniformly distributed over the range $-2^{31} \leq y < 2^{31}$.
---	---

msync

msync

Synchronizes a mapped file.

Format

```
#include <mman.h>
int msync (void *addr, size_t len, int flags);
```

Arguments

addr

The address of the region that you want to synchronize.

len

The length, in bytes, of the region that you want to synchronize.

flags

One of the following symbolic constants defined in the <mman.h> header file:

MS_SYNC	Synchronous cache flush
MS_ASYNC	Asynchronous cache flush
MS_INVALIDATE	Invalidate cached pages

Description

The `msync` function controls the caching operations of a mapped file region. Use `msync` to:

- Ensure that modified pages in the region transfer to the underlying storage device of the file.
- Control the visibility of modifications with respect to file system operations.

The `addr` and `len` arguments specify the region to be synchronized.

The `len` argument must be a multiple of the page size as returned by `sysconf(_SC_PAGE_SIZE)`; otherwise, the length of the region is rounded up to the next multiple of the page size.

If the `flags` argument is set to:

flags Argument	Then the msync Function...
MS_SYNC	Does not return until the system completes all I/O operations.
MS_ASYNC	Returns after the system schedules all I/O operations.
MS_INVALIDATE	Invalidates all cached copies of the pages. The operating system must obtain new copies of the pages from the file system the next time the application references them.

After a successful call to the `msync` function with the `flags` argument set to:

- `MS_SYNC` – All previous modifications to the mapped region are visible to processes using the `read` argument. Previous modifications to the file using the `write` function are lost.

- `MS_INVALIDATE` – All previous modifications to the file using the `write` function are visible to the mapped region. Previous direct modifications to the mapped region are lost.

See also `read`, `write`, and `sysconf`.

Return Values

0	Indicates success.
-1	Indicates an error; <code>errno</code> is set to one of the following values: <ul style="list-style-type: none">• <code>EIO</code> – An I/O error occurred while reading from or writing to the file system.• <code>ENOMEM</code> – The range specified by <code>[addr, addr + len]</code> is invalid for a process's address space, or the range specifies one or more unmapped pages.• <code>EINVAL</code> – The <code>addr</code> argument is not a multiple of the page size as returned by <code>sysconf(_SC_PAGE_SIZE)</code>.• <code>EFAULT</code> – The range <code>[addr, addr + len]</code> includes an invalid address.

munmap

munmap

Unmaps a mapped region. This function is reentrant.

Format

```
#include <mman.h>
int munmap (void *addr, size_t len);
```

Arguments

addr

The address of the region that you want to unmap.

len

The length, in bytes, of that region the you want to unmap.

Description

The munmap function unmaps a mapped file or shared memory region.

The *addr* and *len* arguments specify the address and length, in bytes, respectively, of the region to be unmapped.

The *len* argument must be a multiple of the page size as returned by `sysconf(_SC_PAGE_SIZE)`; otherwise, the length of the region is rounded up to the next multiple of the page size.

The result of using an address that lies in an unmapped region and not in any subsequently mapped region is undefined.

See also `sysconf`.

Return Values

0	Indicates success.
-1	Indicates an error; <code>errno</code> is set to one of the following values: <ul style="list-style-type: none">• <code>EINVAL</code> – The <i>addr</i> argument is not a multiple of the page size as returned by <code>sysconf(_SC_PAGE_SIZE)</code>.• <code>EFAULT</code> – The range [<i>addr</i>, <i>addr</i> + <i>len</i>] includes an invalid address.

mv[w]addch

Move the cursor to coordinates (y,x) and add a character to the specified window.

Format

```
#include <curses.h>
int mvaddch (int y, int x, char ch);
int mvwaddch (WINDOW *win, int y, int x, char ch);
```

Arguments

win

A pointer to the window.

y

A window coordinate.

x

A window coordinate.

ch

If this argument is a new-line character (`\n`), the `mvaddch` and `mvwaddch` functions clear the line to the end, and move the cursor to the next line at the same x coordinate. A carriage return (`\r`) moves the cursor to the beginning of the specified line. A tab (`\t`) moves the cursor to the next tabstop within the window.

Description

This routine performs the same function as `mvwaddch`, but on the `stdscr` window.

When `mvwaddch` is used on a subwindow, it writes the character onto the underlying window as well.

Return Values

OK

Indicates success.

ERR

Indicates that writing the character would cause the screen to scroll illegally. For more information, see the `scrollok` function.

mv[w]addstr

mv[w]addstr

Move the cursor to coordinates (y,x) and add the specified string, to which *str* points, to the specified window.

Format

```
#include <curses.h>
int mvaddstr (int y, int x, char *str);
int mvwaddstr (WINDOW *win, int y, int x, char *str);
```

Arguments

win

A pointer to the window.

y

A window coordinate.

x

A window coordinate.

str

A pointer to the character string.

Description

This routine performs the same function as `mvwaddstr`, but on the `stdscr` window.

When `mvwaddstr` is used on a subwindow, the string is written onto the underlying window as well.

Return Values

OK

Indicates success.

ERR

Indicates that the function causes the screen to scroll illegally, but it places as much of the string onto the window as possible. For more information, see the `scrollok` function.

mvcur

Moves the terminal's cursor from *(lasty,lastx)* to *(newy,newx)*.

Format

```
#include <curses.h>
int mvcur (int lasty, int lastx, int newy, int newx);
```

Arguments

lasty
The cursor position.

lastx
The cursor position.

newy
The resulting cursor position.

newx
The resulting cursor position.

Description

In HP C for OpenVMS Systems, `mvcur` and `move` perform the same function.
See also `move`.

Return Values

OK	Indicates success.
ERR	Indicates that moving the window placed part or all of the window off the edge of the terminal screen. The terminal screen remains unaltered.

mv[w]delch

mv[w]delch

Move the cursor to coordinates (y,x) and delete the character on the specified window. The `mvdelch` function acts on the `stdscr` window.

Format

```
#include <curses.h>
int mvdelch (int y, int x);
int mvwdelch (WINDOW *win, int y, int x);
```

Arguments

win
A pointer to the window.

y
A window coordinate.

x
A window coordinate.

Description

Each of the following characters on the same line shifts to the left, and the last character becomes blank.

Return Values

OK	Indicates success.
ERR	Indicates that deleting the character would cause the screen to scroll illegally. For more information, see the <code>scrollok</code> function.

mv[w]getch

Move the cursor to coordinates (y,x) , get a character from the terminal screen, and echo it on the specified window. The `mvgetch` function acts on the `stdscr` window.

Format

```
#include <curses.h>
int mvgetch (int y, int x);
int mvwgetch (WINDOW *win, int y, int x);
```

Arguments

win
A pointer to the window.

y
A window coordinate.

x
A window coordinate.

Description

The `mvgetch` and `mvwgetch` functions refresh the specified window before fetching the character.

Return Values

<code>x</code>	The returned character.
<code>ERR</code>	Indicates that the function causes the screen to scroll illegally. For more information, see the <code>scrollok</code> function in this section.

mv[w]getstr

mv[w]getstr

Move the cursor to coordinates (y,x) , get a string from the terminal screen, store it in the variable *str* (which must be large enough to contain the string), and echo it on the specified window. The `mvgetstr` function acts on the `stdscr` window.

Format

```
#include <curses.h>
int mvgetstr (int y, int x, char *str);
int mvwgetstr (WINDOW *win, int y, int x, char *str);
```

Arguments

win

A pointer to the window.

y

A window coordinate.

x

A window coordinate.

str

The string that is displayed.

Description

The `mvgetstr` and `mvwgetstr` functions strip the new-line terminator (`\n`) from the string.

Return Values

OK

Indicates success.

ERR

Indicates that the function causes the screen to scroll illegally.

mv[w]inch

Move the cursor to coordinates (y,x) and return the character on the specified window without making changes to the window. The `mvinch` function acts on the `stdscr` window.

Format

```
#include <curses.h>
int mvinch (int y, int x);
int mvwinch (WINDOW *win, int y, int x);
```

Arguments

win
A pointer to the window.

y
A window coordinate.

x
A window coordinate.

Return Values

x	The returned character.
ERR	Indicates an input error.

mv[w]insch

mv[w]insch

Move the cursor to coordinates (y,x) and insert the character *ch* into the specified window. The `mvinsch` function acts on the `stdscr` window.

Format

```
#include <curses.h>
int mvinsch (int y, int x, char ch);
int mvwinsch (WINDOW *win, int y, int x, char ch);
```

Arguments

win

A pointer to the window.

y

A window coordinate.

x

A window coordinate.

ch

The character to be inserted at the window's coordinates.

Description

After the character is inserted, each character on the line shifts to the right, and the last character on the line is deleted.

Return Values

OK

Indicates success.

ERR

Indicates that the function makes the screen scroll illegally. For more information, see the `scrollok` function in this section.

mv[w]insstr

Move the cursor to coordinates (y,x) and insert the specified string into the specified window. The mvinsstr function acts on the stdscr window.

Format

```
#include <curses.h>
int mvinsstr (int y, int x, char *str);
int mvwinsstr (WINDOW *win, int y, int x, char *str);
```

Arguments

win
A pointer to the window.

y
A window coordinate.

x
A window coordinate.

str
The string that is displayed.

Description

Each character after the string shifts to the right, and the last character disappears. The mvinsstr and mvwinsstr functions are specific to HP C for OpenVMS Systems and are not portable.

Return Values

OK	Indicates success.
ERR	Indicates that the function makes the screen scroll illegally. For more information, see the scrollok function.

mvwin

mvwin

Moves the starting position of the window to the specified (y,x) coordinates.

Format

```
#include <curses.h>
mvwin (WINDOW *win, int y, int x);
```

Arguments

win
A pointer to the window.

y
A window coordinate.

x
A window coordinate.

Description

When moving subwindows, the `mvwin` function does not rewrite the contents of the subwindow on the underlying window at the new position. If you write anything to the subwindow after the move, the function also writes to the underlying window.

Return Values

OK	Indicates success.
ERR	Indicates that moving the window put part or all of the window off the edge of the terminal screen. The terminal screen remains unaltered.

nanosleep (Integrity servers, Alpha)

High-resolution sleep (REALTIME). Suspends a process (or thread in a threaded program) from execution for the specified timer interval.

Format

```
#include <time.h>

int nanosleep (const struct timespec *rqtp, struct timespec *rmtp);
```

Arguments**rqtp**

A pointer to the `timespec` data structure that defines the time interval during which the calling process or thread is suspended.

rmtp

A pointer to the `timespec` data structure that receives the amount of time remaining in the previously requested interval, or zero if the full interval has elapsed.

Description

The `nanosleep` function suspends a process or thread until one of the following conditions is met:

- The time interval specified by the `rqtp` argument has elapsed.
- A signal is delivered to the calling process and the action is to invoke a signal-catching function or to terminate the process.

The suspension time may be longer than requested because the argument value is rounded up to an integer multiple of the sleep resolution or because of the scheduling of other activity by the system. Except when interrupted by a signal, the suspension time is not less than the time specified by the `rqtp` argument (as measured by the system clock, `CLOCK_REALTIME`).

The use of the `nanosleep` function has no effect on the action or blockage of any signal.

If the requested time has elapsed, the call was successful and the `nanosleep` function returns zero.

On failure, the `nanosleep` function returns `-1` and sets `errno` to indicate the failure. The function fails if it has been interrupted by a signal, or if the `rqtp` argument specified a nanosecond value less than 0 or greater than or equal to 1 billion.

If the `rmtp` argument is non-NULL, the `timespec` structure it references is updated to contain the amount of time remaining in the interval (the requested time minus the time actually slept).

If the `rmtp` argument is NULL, the remaining time is not returned.

See also `clock_getres`, `clock_gettime`, `clock_settime`, and `sleep`.

Return Values

- | | |
|----|--|
| 0 | Indicates success. The requested time has elapsed. |
| -1 | Indicates failure. The function call was unsuccessful or was interrupted by a signal; <code>errno</code> is set to one of the following values: <ul style="list-style-type: none">• <code>EINTR</code> – The <code>nanosleep</code> function was interrupted by a signal.• <code>EINVAL</code> – The <code>rqtp</code> argument specified a nanosecond value less than 0 or greater than or equal to 1 billion. |

newwin

Creates a new window with *numlines* lines and *numcols* columns starting at the coordinates (*begin_y*,*begin_x*) on the terminal screen.

Format

```
#include <curses.h>
```

```
WINDOW *newwin (int numlines, int numcols, int begin_y, int begin_x);
```

Arguments

numlines

If it is 0, the `newwin` function sets that dimension to `LINES` (*begin_y*). To get a new window of dimensions `LINES` by `COLS`, use the following line:

```
newwin (0, 0, 0, 0)
```

numcols

If it is 0, the `newwin` function sets that dimension to `COLS` (*begin_x*). Therefore, to get a new window of dimensions `LINES` by `COLS`, use the following line:

```
newwin (0, 0, 0, 0)
```

begin_y

A window coordinate.

begin_x

A window coordinate.

Return Values

x	The address of the allocated window.
ERR	Indicates an error.

nextafter (*Integrity servers, Alpha*)

nextafter (*Integrity servers, Alpha*)

Returns the next machine-representable number following x in the direction of y .

Format

```
#include <math.h>
double nextafter (double x, double y);
float nextafterf (float x, float y);
long double nextafterl (long double x, long double y);
```

Arguments

x
A real number.

y
A real number.

Description

The `nextafter` functions return the next machine-representable floating-point number following x in the direction of y . If y is less than x , `nextafter` returns the largest representable floating-point number less than x .

Return Values

<code>n</code>	The next representable floating-point value following x in the direction of y .
<code>HUGE_VAL</code>	Overflow; <code>errno</code> is set to <code>ERANGE</code> .
<code>NaN</code>	x or y is NaN; <code>errno</code> is set to <code>EDOM</code> .

nexttoward *(Integrity servers, Alpha)*

Equivalent to the nextafter function, with exceptions noted in the Description.

Format

```
#include <math.h>
double nexttoward (double x, long double y);
float nexttowardf (float x, long double y);
long double nexttowardl (long double x, long double y);
```

Arguments

x
A real number.

y
A real number.

Description

The nexttoward functions are equivalent to the corresponding nextafter functions, except that the second parameter has type long double and the functions return *y* converted to the type of the function if *x* equals *y*.

Return Values

<i>n</i>	The next representable floating-point value following <i>x</i> in the direction of <i>y</i> .
<i>y</i> (of the type <i>x</i>)	If <i>x</i> equals <i>y</i> .
HUGE_VAL	Overflow; errno is set to ERANGE.
NaN	<i>x</i> or <i>y</i> is NaN; errno is set to EDOM.

nice

nice

Increases or decreases process priority relative to the process current priority by the amount of the argument. This function is nonreentrant.

Format

```
#include <unistd.h>
int nice (int increment);
```

Argument

increment

As a positive argument, decreases priority; as a negative argument, increases priority. Issuing `nice(0)` restores the base priority. The resulting priority cannot be less than 1, or greater than the process's base priority. If it is, the `nice` function quietly does nothing.

Description

When a process calls the `vfork` function, the resulting child inherits the parent's priority.

With the `DECC$ALLOW_UNPRIVILEGED_NICE` feature logical enabled, the `nice` function exhibits its legacy behavior of not checking the privilege of the calling process (that is, any user may lower the `nice` value to increase process priorities). Also, when the caller sets a priority above `MAX_PRIORITY`, the `nice` value is set to the base priority.

With `DECC$ALLOW_UNPRIVILEGED_NICE` disabled, the `nice` function conforms to the X/Open standard of checking the privilege of the calling process (only users with `ALTPRI` privilege can lower the `nice` value to increase process priorities), and when the caller sets a priority above `MAX_PRIORITY`, the `nice` value is set to `MAX_PRIORITY`.

See also `vfork`.

Return Values

0	Indicates success.
-1	Indicates failure.

nint (*Integrity servers, Alpha*)

Returns the nearest integral value to the argument.

Format

```
#include <math.h>
double nint (double x);
float nintf (float x);
long double nintl (long double x);
```

Argument

x
A real number.

Description

The `nint` functions return the nearest integral value to x , except halfway cases are rounded to the integral value larger in magnitude. This corresponds to the Fortran generic intrinsic function `nint`.

Return Values

<code>n</code>	The nearest integral value to x .
<code>NaN</code>	x is NaN; <code>errno</code> is set to <code>EDOM</code> .

[no]nl

[no]nl

The nl and nonl functions are provided only for UNIX software compatibility and have no function in the OpenVMS environment.

Format

```
#include <curses.h>
void nl (void);
void nonl (void);
```

nl_langinfo

Returns a pointer to a string that contains information obtained from the program's current locale.

Format

```
#include <langinfo.h>
char *nl_langinfo (nl_item item);
```

Argument

item

The name of a constant that specifies the information required. These constants are defined in `<langinfo.h>`.

The following constants are valid:

Constant	Category	Description
D_T_FMT	LC_TIME	String for formatting date and time
D_FMT	LC_TIME	String for formatting date
T_FMT	LC_TIME	String for formatting time
T_FMT_AMPM	LC_TIME	Time format with AM/PM string
AM_STR	LC_TIME	String that represents AM in 12-hour clock notation
PM_STR	LC_TIME	String that represents PM in 12-hour clock notation
DAY_1	LC_TIME	The name of the first day of the week
...		
DAY_7	LC_TIME	The name of the seventh day of the week
ABDAY_1	LC_TIME	The abbreviated name of the first day of the week
...		
ABDAY_7	LC_TIME	The abbreviated name of the seventh day of the week
MON_1	LC_TIME	The name of the first month in the year
...		
MON_12	LC_TIME	The name of the twelfth month in the year
ABMON_1	LC_TIME	The abbreviated name of the first month in the year
...		
ABMON_12	LC_TIME	The abbreviated name of the twelfth month in the year
ERA	LC_TIME	Era description strings

```

int main()
{
    char *return_val;
    char *nl_ptr;

    /* set the locale, with user supplied locale name */
    return_val = setlocale(LC_ALL, "en_gb.iso8859-1");
    if (return_val == NULL) {
        printf("ERROR : The locale is unknown");
        exit(1);
    }
    printf("+-----+\n");
    /* Get the date and time format from the locale. */
    printf("D_T_FMT = ");

    /* Compare the returned string from nl_langinfo with */
    /* an empty string. */
    if (!strcmp((nl_ptr = (char *) nl_langinfo(D_T_FMT)), "")) {
        /* The string returned was empty this could mean that either */
        /* 1) The locale does not contain a value for this item */
        /* 2) The value for this item is an empty string */
        printf("nl_langinfo returned an empty string\n");
    }
    else {
        /* Display the date and time format */
        printf("%s\n", nl_ptr);
    }
}
/* Get the full name for the first day of the week from locale */
printf("DAY_1 = ");

/* Compare the returned string from nl_langinfo with */
/* an empty string. */
if (!strcmp((nl_ptr = (char *) nl_langinfo(DAY_1)), "")) {
    /* The string returned was empty this could mean that either */
    /* 1) The locale does not contain a value for the first */
    /* day of the week */
    /* 2) The value for the first day of the week is */
    /* an empty string */
    printf("nl_langinfo returned an empty string\n");
}
else {
    /* Display the full name of the first day of the week */
    printf("%s\n", nl_ptr);
}
/* Get the abbreviated name for the first day of the week
from locale */

printf("ABDAY_1 = ");

/* Compare the returned string from nl_langinfo with an empty */
/* string. */
if (!strcmp((nl_ptr = (char *) nl_langinfo(ABDAY_1)), "")) {
    /* The string returned was empty this could mean that either */
    /* 1) The locale does not contain a value for the first */
    /* day of the week */
    /* 2) The value for the first day of the week is an */
    /* empty string */
}

```

nl_langinfo

```
        printf("nl_langinfo returned an empty string\n");
    }
    else {
        /* Display the abbreviated name of the first day of the week */
        printf("%s\n", nl_ptr);
    }
}
```

Running the example program produces the following result:

```
+-----+
D_T_FMT = %a %e %b %H:%M:%S %Y
DAY_1 = Sunday
ABDAY_1 = Sun
```

nrand48

Generates uniformly distributed pseudorandom-number sequences. Returns 48-bit signed long integers.

Format

```
#include <stdlib.h>

long int nrand48 (unsigned short int xsubi[3]);
```

Argument

xsubi

An array of three short ints that, when concatenated together, form a 48-bit integer.

Description

The `nrand48` function generates pseudorandom numbers using the linear congruential algorithm and 48-bit integer arithmetic.

The `nrand48` function returns nonnegative, long integers uniformly distributed over the range of y values, such that $0 \leq y < 2^{31}$.

The function works by generating a sequence of 48-bit integer values, X_i , according to the linear congruential formula:

$$X_{n+1} = (aX_n + c) \bmod m \quad n \geq 0$$

The argument m equals 2^{48} , so 48-bit integer arithmetic is performed. Unless you invoke the `lcong48` function, the multiplier value a and the addend value c are:

$$\begin{aligned} a &= 5DEECE66D_{16} = 2736731631558 \\ c &= B_{16} = 138 \end{aligned}$$

The `nrand48` function requires that the calling program pass an array as the `xsubi` argument, which for the first call must be initialized to the initial value of the pseudorandom-number sequence. Unlike the `drand48` function, it is not necessary to call an initialization function prior to the first call.

By using different arguments, the `nrand48` function allows separate modules of a large program to generate several independent sequences of pseudorandom numbers. For example, the sequence of numbers that one module generates does not depend upon how many times the functions are called by other modules.

Return Value

`n` Returns nonnegative, long integers over the range $0 \leq y < 2^{31}$.

open

open

Opens a file for reading, writing, or editing. It positions the file at its beginning (byte 0).

Format

```
#include <fcntl.h>
```

```
int open (const char *file_spec, int flags, mode_t mode); (ANSI C)
```

```
int open (const char *file_spec, int flags, . . . ); (HP C Extension)
```

Arguments

file_spec

A null-terminated character string containing a valid file specification. If you specify a directory in the *file_spec* and it is a search list that contains an error, HP C interprets it as a file open error.

If the *file_spec* parameter refers to a symbolic link, the open function opens the file pointed to by the symbolic link.

flags

The following values are defined in the <fcntl.h> header file:

<code>O_RDONLY</code>	Open for reading only
<code>O_WRONLY</code>	Open for writing only
<code>O_RDWR</code>	Open for reading and writing
<code>O_NDELAY</code>	Open for asynchronous input
<code>O_APPEND</code>	Append on each write
<code>O_CREAT</code>	Create a file if it does not exist
<code>O_TRUNC</code>	Create a new version of this file
<code>O_EXCL</code>	Error if attempting to create existing file

These flags are set using the bitwise OR operator (|) to separate specified flags.

Opening a file with `O_APPEND` causes each write on the file to be appended to the end. (In contrast, with the VAX C RTL the behavior of files opened in append mode was to start at EOF and, thereafter, write at the current file position.)

If `O_TRUNC` is specified and the file exists, open creates a new file by incrementing the version number by 1, leaving the old version in existence.

If `O_CREAT` is set and the named file does not exist, the HP C RTL creates it with any attributes specified in the fourth and subsequent arguments (. . .). If `O_EXCL` is set with `O_CREAT` and the named file exists, the attempted open returns an error.

mode

An unsigned value that specifies the file-protection mode. The compiler performs a bitwise AND operation on the mode and the complement of the current protection mode.

You can construct modes by using the bitwise OR operator (|) to separate specified modes. The modes are:

```
0400    OWNER:READ
0200    OWNER:WRITE
0100    OWNER:EXECUTE
0040    GROUP:READ
0020    GROUP:WRITE
0010    GROUP:EXECUTE
0004    WORLD:READ
0002    WORLD:WRITE
0001    WORLD:EXECUTE
```

The system is given the same access privileges as the owner. A WRITE privilege also implies a DELETE privilege.

...

Optional file attribute arguments. The file attribute arguments are the same as those used in the creat function. For more information, see the creat function.

Description

If a version of the file exists, a new file created with open inherits certain attributes from the existing file unless those attributes are specified in the open call. The following attributes are inherited: record format, maximum record size, carriage control, and file protection.

Notes

- If you intend to do random writing to a file, the file must be opened for update by specifying a *flags* value of O_RDWR.
- To create files with OpenVMS RMS default protections by using the UNIX system-call functions umask, mkdir, creat, and open, call mkdir, creat, and open with a file-protection mode argument of 0777 in a program that never specifically calls umask. These default protections include correctly establishing protections based on ACLs, previous versions of files, and so on.

In programs that do vfork/exec calls, the new process image inherits whether umask has ever been called or not from the calling process image. The umask setting and whether the umask function has ever been called are both inherited attributes.

See also creat, read, write, close, dup, dup2, and lseek.

open

Return Values

x	A nonnegative file descriptor number.
-1	Indicates that the file does not exist, that it is protected against reading or writing, or that it cannot be opened for another reason.

Example

```
#include <unixio.h>
#include <fcntl.h>
#include <stdlib.h>

main()
{
    int file,
        stat;
    int flags;

    flags = O_RDWR; /* Open for read and write, */
                  /* with user default file protection, */
                  /* with max fixed record size of 2048, */
                  /* and a block size of 2048 bytes. */

    file=open("file.dat", flags, 0, "rfm=fix", "mrs=2048", "bls=2048");
    if (file == -1)
        perror("OPEN error"), exit(1);

    close(file);
}
```

opendir

Opens a specified directory.

Format

```
#include <dirent.h>
DIR *opendir (const char *dir_name);
```

Argument

dir_name

The name of the directory to be opened.

Description

The `opendir` function opens the directory specified by *dir_name* and associates a directory stream with it. The *dir_name* argument can be specified in OpenVMS style or UNIX style. The directory stream is positioned at the first entry. The type `DIR`, defined in the `<dirent.h>` header file, represents a directory stream. A directory stream is an ordered sequence of all the directory entries in a particular directory.

The `opendir` function also returns a pointer to identify the directory stream in subsequent operations. The `NULL` pointer is returned when the directory named by *dir_name* cannot be accessed, or when not enough memory is available to hold the entire stream.

Notes

- An open directory must always be closed with the `closedir` function to ensure that the next attempt to open that directory is successful. The `opendir` function should be used with `readdir`, `closedir`, and `rewinddir` to examine the contents of the directory.
 - The `opendir` function supports UNIX style path name specifications. For more information about UNIX style directory specifications, see Section 1.3.3.
-

Example

See the program example in the description of `closedir`.

opendir

Return Values

x

A pointer to an object of type DIR.

NULL

Indicates an error; `errno` is set to one of the following values:

- EACCES – Search permission is denied for any component of *dir_name* or read permission is denied for *dir_name*.
- ENAMETOOLONG – The length of the *dir_name* string exceeds `PATH_MAX`, or a pathname component is longer than `NAME_MAX`.
- ENOENT – The *dir_name* argument points to the name of a file that does not exist, or is an empty string.

overlay

Nondestructively superimposes *win1* on *win2*. The function writes the contents of *win1* that will fit onto *win2* beginning at the starting coordinates of both windows. Blanks on *win1* leave the contents of the corresponding space on *win2* unaltered. The overlay function copies as much of a window's box as possible.

Format

```
#include <curses.h>
int overlay (WINDOW *win1, WINDOW *win2);
```

Arguments

win1
A pointer to the window.

win2
A pointer to the window.

Return Values

OK	Indicates success.
ERR	Indicates an error.

overwrite

overwrite

Destructively writes the contents of *win1* on *win2*.

Format

```
#include <curses.h>
int overwrite (WINDOW *win1, WINDOW *win2);
```

Arguments

win1

A pointer to the window.

win2

A pointer to the window.

Description

The `overwrite` function writes the contents of *win1* that will fit onto *win2* beginning at the starting coordinates of both windows. Blanks on *win1* are written on *win2* as blanks. This function copies as much of a window's box as possible.

Return Values

OK	Indicates success.
ERR	Indicates failure.

pathconf

Retrieves file implementation characteristics.

Format

```
#include <unistd.h>

long int pathconf (const char *path, int name);
```

Arguments

path

The pathname of a file or directory.

name

The configuration attribute to query. If this attribute is not applicable to the file specified by the *path* argument, the pathconf function returns an error.

Description

The pathconf function allows an application to determine the characteristics of operations supported by the file system underlying the filename by *path*. Read, write, or execute permission of the named file is not required, but you must be able to search all directories in the path leading to the file.

Symbolic values for the *name* argument are defined in the <unistd.h> header file, as follows:

<code>_PC_LINK_MAX</code>	The maximum number of links to the file. If the <i>path</i> argument refers to a directory, the value returned applies to the directory itself.
<code>_PC_MAX_CANON</code>	The maximum number of bytes in a canonical input line. This is applicable only to terminal devices.
<code>_PC_MAX_INPUT</code>	The number of types allowed in an input queue. This is applicable only to terminal devices.
<code>_PC_NAME_MAX</code>	Maximum number of bytes in a filename (not including a terminating null). The byte range value is between 13 and 255. This is applicable only to a directory file. The value returned applies to filenames within the directory.
<code>_PC_PATH_MAX</code>	Maximum number of bytes in a pathname (not including a terminating null). The value is never larger than 65,535. This is applicable only to a directory file. The value returned is the maximum length of a relative pathname when the specified directory is the working directory.
<code>_PC_PIPE_BUF</code>	Maximum number of bytes guaranteed to be written atomically. This is applicable only to a FIFO. The value returned applies to the referenced object. If the <i>path</i> argument refers to a directory, the value returned applies to any FIFO that exists or can be created within the directory.

pathconf

<code>_PC_CHOWN_RESTRICTED</code>	This is applicable only to a directory file. The value returned applies to any files (other than directories) that exist or can be created within the directory.
<code>_PC_NO_TRUNC</code>	Returns 1 if supplying a component name longer than allowed by <code>NAME_MAX</code> causes an error. Returns 0 (zero) if long component names are truncated. This is applicable only to a directory file.
<code>_PC_VDISABLE</code>	This is always 0 (zero); no disabling character is defined. This is applicable only to a terminal device.

Return Values

<code>x</code>	Resultant value of the configuration attribute specified in <i>name</i> .
<code>-1</code>	Indicates an error; <code>errno</code> is set to one of the following values: <ul style="list-style-type: none">• <code>EACCES</code> – Search permission is denied for a component of the path prefix.• <code>EINVAL</code> – The <i>name</i> argument specifies an unknown or inapplicable characteristic.• <code>EFAULT</code> – The <i>path</i> argument is an invalid address.• <code>ENAMETOOLONG</code> – The length of the <i>path</i> string exceeds <code>PATH_MAX</code> or a pathname component is longer than <code>NAME_MAX</code>.• <code>ENOENT</code> – The named file does not exist or the <i>path</i> argument points to an empty string.• <code>ENOTDI</code> – A component of the <i>path</i> prefix is not a directory.

pause

Suspends the calling process until delivery of a signal whose action is either to execute a signal-catching function or to terminate the process.

Format

```
#include <unistd.h>
int pause (void);
```

Description

The pause function suspends the calling process until delivery of a signal whose action is either to execute a signal-catching function or to terminate the process.

If the action is to terminate the process, pause does not return.

If the action is to execute a signal-catching function, pause returns after the signal-catching function returns.

Return Value

	Since the pause function suspends process execution indefinitely unless interrupted by a signal, there is no successful completion return value.
-1	In cases where pause returns, the return value is -1, and errno is set to EINTR.

pclose

pclose

Closes a pipe to a process.

Format

```
#include <stdio.h>
int pclose (FILE *stream);
```

Arguments

stream

A pointer to a FILE structure for an open pipe returned by a previous call to the popen function.

Description

The pclose function closes a pipe between the calling program and a shell command to be executed. Use pclose to close any stream you have opened with popen. The pclose function waits for the associated process to end, and then returns the exit status of the command. See the description of waitpid for information on interpreting the exit status.

Beginning with OpenVMS Version 7.3-1, when compiled with the `_VMS_WAIT` macro defined, the pclose function returns the OpenVMS completion code of the child process.

See also popen.

Return Values

x	Exit status of child.
-1	Indicates an error. The <i>stream</i> argument is not associated with a popen function. <code>errno</code> is set to the following: <ul style="list-style-type: none">• <code>ECHILD</code> – cannot obtain the status of the child process.

perror

Writes a short error message to `stderr` describing the current value of `errno`.

Format

```
#include <stdio.h>

void perror (const char *str);
```

Argument

str

Usually the name of the program that caused the error.

Description

The `perror` function uses the error number in the external variable `errno` to retrieve the appropriate locale-dependent error message. The function writes out the message as follows: *str* (a user-supplied prefix to the error message), followed by a colon and a space, followed by the message itself, followed by a new-line character.

See the description of `errno` in Chapter 4 for a list of possible errors.

See also `strerror`.

Example

```
#include <stdio.h>
#include <stdlib.h>

main(argc, argv)
    int argc;
    char *argv[];
{
    FILE *fp;

    fp = fopen(argv[1], "r"); /* Open an input file. */
    if (fp == NULL) {
        /* If the fopen call failed, perror prints out a      */
        /* diagnostic:                                         */
        /* "open: <error message>"                             */
        /* This error message provides a diagnostic explaining */
        /* the cause of the failure.                           */
        perror("open");
        exit(EXIT_FAILURE);
    }
    else
        fclose(fd);
}
```

pipe

pipe

Creates a temporary mailbox that can be used to read and write data between a parent and child process. The channels through which the processes communicate are called a *pipe*.

Format

```
#include <unistd.h>

int pipe (int array_fdscptr[2]); (ISO POSIX-1)

int pipe (int array_fdscptr[2], . . . ); (HP C Extension)
```

Arguments

array_fdscptr

An array of file descriptors. A pipe is implemented as an array of file descriptors associated with a mailbox. These mailbox descriptors are special in that these are the only file descriptors which, when passed to the `isapipe` function, will return 1.

The file descriptors are allocated in the following way:

- The first available file descriptor is assigned to writing, and the next available file descriptor is assigned to reading.
- The file descriptors are then placed in the array in reverse order; element 0 contains the file descriptor for reading, and element 1 contains the file descriptor for writing.

...

Represents three optional, positional arguments, *flag*, *bufsize*, and *bufquota*:

flag

An optional argument used as a bitmask.

If either the `O_NDELAY` or `O_NONBLOCK` bit is set, the I/O operations to the mailbox through *array_fdscptr* file descriptors terminate immediately, rather than waiting for another process.

If, for example, the `O_NDELAY` bit is set and the child issues a read request to the mailbox before the parent has put any data into it, the read terminates immediately with 0 status. If neither the `O_NDELAY` nor `O_NONBLOCK` bit is set, the child will be waiting on the read until the parent writes any data into the mailbox. This is the default behavior if no *flag* argument is specified.

The values of `O_NDELAY` and `O_NONBLOCK` are defined in the `<fcntl.h>` header file. Any other bits in the *flag* argument are ignored. You must specify this argument if the second optional, positional argument *bufsize* is specified. If the *flag* argument is needed only to allow specification of the *bufsize* argument, specify *flag* as 0.

bufsize

Optional argument of type `int` that specifies the size of the mailbox, in bytes. Specify a value from 512 to 65535.

If you specify 0 or omit this argument, the operating system creates a mailbox with a default size of 512 bytes.

If you specify a value less than 0 or larger than 65535, the results are unpredictable.

If you do specify this argument, be sure to precede it with a *flag* argument.

The DECC\$PIPE_BUFFER_SIZE feature logical can also be used to specify the size of the mailbox. If *bufsize* is supplied, it takes precedence over the value of DECC\$PIPE_BUFFER_SIZE. Otherwise, the value of DECC\$PIPE_BUFFER_SIZE is used.

If neither *bufsize* nor DECC\$PIPE_BUFFER_SIZE is specified, the default buffer size of 512 is used.

bufquota

Optional argument of type int that specifies the buffer quota of the pipe's mailbox. Specify a value from 512 to 2147483647.

OpenVMS Version 7.3-2 added this argument. In previous OpenVMS versions, the buffer quota was equal to the buffer size.

The DECC\$PIPE_BUFFER_QUOTA feature logical can also be used to specify the buffer quota. If the optional *bufquota* argument of the pipe function is supplied, it takes precedence over the value of DECC\$PIPE_BUFFER_QUOTA. Otherwise, the value of DECC\$PIPE_BUFFER_QUOTA is used.

If neither *bufquota* nor DECC\$PIPE_BUFFER_QUOTA is specified, then the buffer quota defaults to the buffer size.

Description

The mailbox used for the pipe is a temporary mailbox. The mailbox is not deleted until all processes that have open channels to that mailbox close those channels. The last process that closes a pipe writes a message to the mailbox, indicating the end-of-file.

The mailbox is created by using the \$CREMBX system service, specifying the following characteristics:

- A maximum message length of 512 characters
- A buffer quota of 512 characters
- A protection mask granting all privileges to USER and GROUP and no privileges to SYSTEM or WORLD

The buffer quota of 512 characters implies that you cannot write more than 512 characters to the mailbox before all or part of the mailbox is read. Since a mailbox record is slightly larger than the data part of the message that it contains, not all of the 512 characters can be used for message data. You can increase the size of the buffer by specifying an alternative size using the optional, third argument to the pipe function. A pipe under the OpenVMS system is a stream-oriented file with no carriage-control attributes. It is fully buffered by default in the HP C RTL. A mailbox used as a pipe is different than a mailbox created by the application. A mailbox created by the application defaults to a record-oriented file with carriage return, carriage control. Additionally, writing a zero-length record to a mailbox writes an EOF, as does each close of the mailbox. For a pipe, only the last close of a pipe writes an EOF.

pipe

The pipe is created by the parent process before `vfork` and an `exec` function are called. By calling `pipe` first, the child inherits the open file descriptors for the pipe. You can then use the `getname` function to return the name of the mailbox associated with the pipe, if this information is desired. The mailbox name returned by `getname` has the format `_MBA $nnnn$` : (*Alpha only*) or `_MBA $nnnnn$` : (*Integrity servers only*), where $nnnn$ or $nnnnn$ is a unique number.

Both the parent and the child need to know in advance which file descriptors will be allocated for the pipe. This information cannot be retrieved at run time. Therefore, it is important to understand how file descriptors are used in any HP C for OpenVMS program. For more information about file descriptors, see Chapter 2.

File descriptors 0, 1, and 2 are open in a HP C for OpenVMS program for `stdin` (`SYS$INPUT`), `stdout` (`SYS$OUTPUT`), and `stderr` (`SYS$ERROR`), respectively. Therefore, if no other files are open when `pipe` is called, `pipe` assigns file descriptor 3 for writing and file descriptor 4 for reading. In the array returned by `pipe`, 4 is placed in element 0 and 3 is placed in element 1.

If other files have been opened, `pipe` assigns the first available file descriptor for writing and the next available file descriptor for reading. In this case, the pipe does not necessarily use adjacent file descriptors. For example, assume that two files have been opened and assigned to file descriptors 3 and 4 and the first file is then closed. If `pipe` is called at this point, file descriptor 3 is assigned for writing and file descriptor 5 is assigned for reading. Element 0 of the array will contain 5 and element 1 will contain 3.

In large applications that do large amounts of I/O, it gets more difficult to predict which file descriptors are going to be assigned to a pipe; and, unless the child knows which file descriptors are being used, it will not be able to read and write successfully from and to the pipe.

One way to be sure that the correct file descriptors are being used is to use the following procedure:

1. Choose two descriptor numbers that will be known to both the parent and the child. The numbers should be high enough to account for any I/O that might be done before the pipe is created.
2. Call `pipe` in the parent at some point before calling an `exec` function.
3. In the parent, use `dup2` to assign the file descriptors returned by `pipe` to the file descriptors you chose. This now reserves those file descriptors for the pipe; any subsequent I/O will not interfere with the pipe.

You can read and write through the pipe using the UNIX I/O functions `read` and `write`, specifying the appropriate file descriptors. As an alternative, you can issue `fdopen` calls to associate file pointers with these file descriptors so that you can use the Standard I/O functions (`fread` and `fwrite`).

Two separate file descriptors are used for reading from and writing to the pipe, but only one mailbox is used so some I/O synchronization is required. For example, assume that the parent writes a message to the pipe. If the parent is the first process to read from the pipe, then it will read its own message back as shown in Figure REF-1.

Note

For added UNIX portability, you can use the following feature logicals to control the behavior of the C RTL pipe implementation:

- Define the DECC\$STREAM_PIPE feature logical name to ENABLE to direct the pipe function to use stream I/O instead of record I/O.
 - Define the DECC\$POPEN_NO_CRLF_REC_ATTR feature logical to ENABLE to prevent CR/LF carriage control from being added to pipe records for pipes opened with the popen function. Be aware that enabling this feature might result in undesired behavior from other functions such as gets that rely on the carriage-return character.
-

Figure REF-1 Reading and Writing to a Pipe

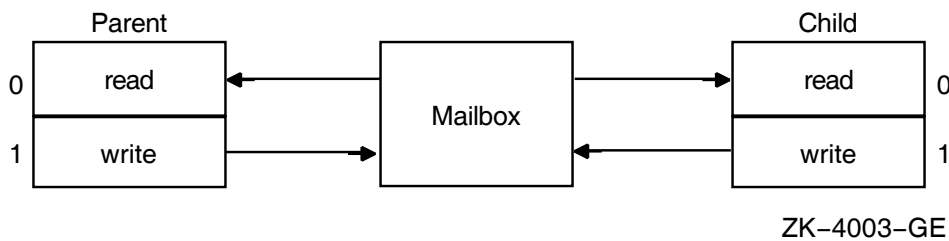

Return Values

0	Indicates success.
-1	Indicates an error.

poll (*Integrity servers, Alpha*)

Provides users with a mechanism for multiplexing input/output over a set of file descriptors that reference open streams.

Format

```
#include <poll.h>
int poll (struct pollfd filedes [], nfd_t nfds, int timeout);
```

Argument

filedes

Points to an array of pollfd structures, one for each file descriptor of interest. Each pollfd structure includes the following members:

- int *fd* – The file descriptor
- int *events* – The requested conditions
- int *revents* – The reported conditions

nfds

The number of pollfd structures in the *filedes* array.

timeout

The maximum length of time (in milliseconds) to wait for at least one of the specified events to occur.

Description

The poll function provides users with a mechanism for multiplexing input/output over a set of file descriptors that reference open streams. For each member of the array pointed to by *filedes*, poll examines the given file descriptor for the event(s) specified in *events*. The poll function identifies those streams on which an application can send or receive messages, or on which certain events have occurred.

The *filedes* parameter specifies the file descriptor to be examined and the events of interest for each file descriptor. It is a pointer to an array of pollfd structures. The *fd* member of each pollfd structure specifies an open file descriptor. The poll function uses the *events* member to determine what conditions to report for this file descriptor. If one or more of these conditions is true, the poll function sets the associated *revents* member.

The *events* and *revents* members of each pollfd structure are bitmasks. The calling process sets the events bitmask, and poll sets the revents bitmasks. These bitmasks contain inclusive ORed combinations of condition options. The following condition options are defined:

- POLLERR – An error has occurred on the file descriptor. This option is only valid in the revents bitmask; it is not used in the events member.

For STREAMS devices, if an error occurs on the file descriptor and the device is also disconnected, poll returns POLLERR; POLLERR takes precedence over POLLHUP.

POLLHUP – The device has been disconnected. This event is mutually exclusive with **POLLOUT**; a stream can never be writable if a hangup occurred. However, this event and **POLLIN**, **POLLRDNORM**, **POLLRDBAND** or **POLLPRI** are not mutually exclusive. This option is only valid in the *revents* bitmask; it is ignored in the *events* member.

POLLIN – Data other than high-priority data may be read without blocking. This option is set in *revents* even if the message is of zero length. In *revents*, this option is mutually exclusive with **POLLPRI**.

POLLNVAL – The value specified for *fd* is invalid. This option is only valid in the *revents* member; it is ignored in the *events* member.

POLLOUT – Normal (priority band equals 0) data may be written without blocking.

POLLPRI – High-priority data may be received without blocking. This option is set in *revents* even if the message is of zero length. In *revents*, this option is mutually exclusive with **POLLIN**.

POLLRDBAND – Data from a nonzero priority band may be read without blocking. This option is set in *revents* even if the message is of zero length.

POLLRDNORM – Normal data (priority band equals 0) may be read without blocking. This option is set in *revents* even if the message is of zero length.

POLLWRBAND – Priority data (priority band greater than 0) may be written. This event only examines bands that have been written to at least once.

POLLWRNORM – Same as **POLLOUT**.

The `poll` function ignores any `pollfd` structure whose *fd* member is less than 0 (zero). If the *fd* member of all `pollfd` structures is less than 0, the `poll` function will return 0 and have no other results.

The conditions indicated by **POLLNORM** and **POLLOUT** are true if and only if at least one byte of data can be read or written without blocking. There are two exceptions: regular files, which always poll true for **POLLNORM** and **POLLOUT**, and pipes, when the rules for the operation specify to return zero in order to indicate end-of-file.

The condition options **POLLERR**, **POLLHUP**, and **POLLNVAL** are always set in *revents* if the conditions they indicate are true for the specified file descriptor, whether or not these options are set in *events*.

For each call to the `poll` function, the set of reportable conditions for each file descriptor consists of those conditions that are always reported, together with any further conditions for which options are set in *events*. If any reportable condition is true for any file descriptor, the `poll` function will return with options set in *revents* for each true condition for that file descriptor.

If no reportable condition is true for any of the file descriptors, the `poll` function waits up to *timeout* milliseconds for a reportable condition to become true. If, in that time interval, a reportable condition becomes true for any of the file descriptors, `poll` reports the condition in the file descriptor's associated *revents* member and returns. If no reportable condition becomes true, `poll` returns without setting any *revents* bitmasks.

If the *timeout* parameter is a value of `-1`, the `poll` function does not return until at least one specified event has occurred. If the value of the *timeout* parameter is `0` (zero), the `poll` function does not wait for an event to occur but returns immediately, even if no specified event has occurred.

The behavior of the `poll` function is not affected by whether the `O_NONBLOCK` option is set on any of the specified file descriptors.

The `poll` function supports regular files, terminal and pseudo-terminal devices, STREAMS-based files, FIFOs, and pipes. The behavior of `poll` on elements of file descriptors that refer to other types of files is unspecified.

For sockets, a file descriptor for a socket that is listening for connections indicates it is ready for reading after connections are available. A file descriptor for a socket that is connecting asynchronously indicates it is ready for writing after a connection is established.

Return Values

<code>n</code>	Upon successful completion, a nonnegative value is returned, indicating the number of file descriptors for which <code>poll</code> has set the revents bitmask.
<code>0</code>	<code>poll</code> has timed out and has not set any of the revents bitmasks.
<code>-1</code>	An error occurred. <code>errno</code> is set to indicate the error: <ul style="list-style-type: none">• <code>EAGAIN</code> – Allocation of internal data structures failed. A later call to the <code>poll</code> function might complete successfully.• <code>EINTR</code> – A signal was intercepted during the <code>poll</code> function, and the signal handler was installed with an indication that functions are not to be restarted.• <code>EINVAL</code> – The <i>nfds</i> parameter is greater than <code>OPEN_MAX</code>, or one of the <i>fd</i> members refers to a stream or multiplexer that is linked (directly or indirectly) downstream from a multiplexer.

popen

Initiates a pipe to a process.

Format

```
#include <stdio.h>
FILE *popen (const char *command, const char *type);
```

Arguments

command

A pointer to a null-terminated string containing a shell command line.

type

A pointer to a null-terminated string containing an I/O mode. Because open files are shared, you can use a type *r* command as an input filter and a type *w* command as an output filter. Specify one of the following values for the *type* argument:

- *r*—the calling program can read from the standard output of the command by reading from the returned file stream.
- *w*—the calling program can write to the standard input of the command by writing to the returned file stream.

Description

The `popen` function creates a pipe between the calling program and a shell command awaiting execution. It returns a pointer to a `FILE` structure for the stream.

The `popen` function uses the value of the `DECC$PIPE_BUFFER_SIZE` feature logical to set the buffer size of the mailbox it creates for the pipe. You can specify a `DECC$PIPE_BUFFER_SIZE` value of 512 to 65024 bytes. If `DECC$PIPE_BUFFER_SIZE` is not specified, the default buffer size of 512 is used.

Notes

- When you use the `popen` function to invoke an output filter, beware of possible deadlock caused by output data remaining in the program buffer. You can avoid this by either using the `setvbuf` function to ensure that the output stream is unbuffered, or the `fflush` function to ensure that all buffered data is flushed before calling the `pclose` function.
- For added UNIX portability, you can use the following feature logicals to control the behavior of the C RTL pipe implementation:
 - Define the `DECC$STREAM_PIPE` feature logical name to `ENABLE` to direct the pipe function to use stream I/O instead of record I/O.

popen

- Define the DECC\$POPEN_NO_CRLF_REC_ATTR feature logical to ENABLE to prevent CR/LF carriage control from being added to pipe records for pipes opened with the popen function. Be aware that enabling this feature might result in undesired behavior from other functions such as gets that rely on the carriage-return character.
-

See also fflush, pclose, and setvbuf.

Return Values

x	A pointer to the FILE structure for the opened stream.
NULL	Indicates an error. Unable to create files or processes.

pow

Returns the first argument raised to the power of the second argument.

Format

```
#include <math.h>
double pow (double x, double y);
float powf (float x, float y); (Integrity servers, Alpha)
long double powl (long double x, long double y); (Integrity servers, Alpha)
```

Arguments

x
A floating-point base to be raised to an exponent y .

y
The exponent to which the base x is to be raised.

Description

The pow functions raise a floating-point base x to a floating-point exponent y . The value of $\text{pow}(x,y)$ is computed as $e^{*(y \ln(x))}$ for positive x .

If x is 0 and y is negative, $\pm\text{HUGE_VAL}$ is returned and `errno` is set to `ERANGE` or `EDOM`.

Return Values

<code>x</code>	The result of the first argument raised to the power of the second.
<code>1.0</code>	The base is 0 and the exponent is 0.
<code>HUGE_VAL</code>	The result overflowed; <code>errno</code> is set to <code>ERANGE</code> .
<code>±HUGE_VAL</code>	The base is 0 and the exponent is negative; <code>errno</code> is set to <code>ERANGE</code> or <code>EDOM</code> .

Example

```
#include <stdio.h>
#include <math.h>
#include <errno.h>

main()
{
    double x;
    errno = 0;
    x = pow(-3.0, 2.0);
    printf("%d, %f\n", errno, x);
}
```

This example program outputs the following:

```
0, 9.000000
```

pread (*Integrity servers, Alpha*)

Reads bytes from a given position within a file without changing the file pointer.

Format

```
#include <unistd.h>
ssize_t pread (int file_desc, void *buffer, size_t nbytes, off_t offset);
```

Arguments

file_desc

A file descriptor that refers to a file currently opened for reading.

buffer

The address of contiguous storage in which the input data is placed.

nbytes

The maximum number of bytes involved in the read operation.

offset

The offset for the desired position inside the file.

Description

The `pread` function performs the same action as `read`, except that it reads from a given position in the file without changing the file pointer. The first three arguments to `pread` are the same as for `read`, with the addition of a fourth argument *offset* for the desired position inside the file. An attempt to perform a `pread` on a file that is incapable of seeking results in an error.

Return Values

<code>n</code>	The number of bytes read.
<code>-1</code>	Upon failure, the file pointer remains unchanged and <code>pread</code> sets <i>errno</i> to one of the following values: <ul style="list-style-type: none">• <code>EINVAL</code> – The offset argument is invalid. The value is negative.• <code>EOVERFLOW</code> – The file is a regular file, and an attempt was made to read or write at or beyond the offset maximum associated with the file.• <code>ENXIO</code> – A request was outside the capabilities of the device.• <code>ESPIPE</code> – <i>file_desc</i> is associated with a pipe or FIFO.

printf

Performs formatted output from the standard output (stdout). See Chapter 2 for information on format specifiers.

Format

```
#include <stdio.h>
int printf (const char *format_spec, ... );
```

Arguments

format_spec

Characters to be written literally to the output or converted as specified in the ... arguments.

...

Optional expressions whose resultant types correspond to conversion specifications given in the format specification.

If no conversion specifications are given, you may omit the output sources. Otherwise, the function call must have exactly as many output sources as there are conversion specifications, and the conversion specifications must match the types of the output sources.

Conversion specifications are matched to output sources in left-to-right order. Excess output pointers, if any, are ignored.

Return Values

x	The number of bytes written.
Negative value	Indicates that an output error occurred. The function sets <code>errno</code> . For a list of <code>errno</code> values set by this function, see <code>fprintf</code> .

[w]printw

[w]printw

Perform a `printf` in the specified window, starting at the current position of the cursor. The `printw` function acts on the `stdscr` window.

Format

```
#include <curses.h>
printw (char *format_spec, ... );
int wprintw (WINDOW *win, char *format_spec, ... );
```

Arguments

win

A pointer to the window.

format_spec

A pointer to the format specification string.

...

Optional expressions whose resultant types correspond to conversion specifications given in the format specification.

If no conversion specifications are given, you may omit the output sources. Otherwise, the function call must have exactly as many output sources as there are conversion specifications, and the conversion specifications must match the types of the output sources.

Conversion specifications are matched to output sources in left-to-right order. Excess output pointers, if any, are ignored.

Description

The formatting specification (*format_spec*) and the other arguments are identical to those used with the `printf` function.

The `printw` and `wprintw` functions format and then print the resultant string to the window using the `addstr` function. For more information, see the `printf` and `scrollok` functions in this section. See Chapter 2 for information on format specifiers.

Return Values

OK	Indicates success.
ERR	Indicates that the function makes the window scroll illegally.

putc

The `putc` macro writes a single character to a specified file.

Format

```
#include <stdio.h>
int putc (int character, FILE *file_ptr);
```

Arguments

character

The character to be written.

file_ptr

A file pointer to the output stream.

Description

The `putc` macro writes the byte *character* (converted to an unsigned char) to the output specified by the *file_ptr* parameter. The byte is written at the position at which the file pointer is currently pointing (if defined) and advances the indicator appropriately. If the file cannot support positioning requests, or if the output stream was opened with append mode, the byte is appended to the output stream.

Since `putc` is a macro, a file pointer argument with side effects (for example, `putc (ch, *f++)`) might be evaluated incorrectly. In such a case, use the `fputc` function instead.

Compiling with the `__UNIX_PUTC` macro defined enables an optimization that uses a faster, inlined version of this function.

See also `putc_unlocked`.

Return Values

x	The character written to the file. Indicates success.
EOF	Indicates output errors.

putc_unlocked *(Integrity servers, Alpha)*

putc_unlocked *(Integrity servers, Alpha)*

Same as `putc`, except used only within a scope protected by `flockfile` and `funlockfile`.

Format

```
#include <stdio.h>

int putc_unlocked (int character, FILE *file_ptr);
```

Argument

character

The character to be written.

file_ptr

A file pointer to the output stream.

Description

The reentrant version of the `putc` macro is locked against multiple threads calling it simultaneously. This incurs overhead to ensure integrity of the stream. The unlocked version of this call, `putc_unlocked` can be used to avoid the overhead. The `putc_unlocked` macro is functionally identical to the `putc` macro, except that it is not required to be implemented in a thread-safe manner. The `putc_unlocked` macro can be safely used only within a scope that is protected by the `flockfile` and `funlockfile` functions used as a pair. The caller must ensure that the stream is locked before `putc_unlocked` is used.

Since `putc_unlocked` is a macro, a file pointer argument with side effects might be evaluated incorrectly. In such a case, use the `fputc_unlocked` function instead.

Compiling with the `__UNIX_PUTC` macro defined enables an optimization that uses a faster, inlined version of this function.

See also `flockfile`, `ftrylockfile`, and `funlockfile`.

Return Values

x	The character written to the file. Indicates success.
EOF	Indicates the end-of-file or an error.

putchar

Writes a single character to the standard output (stdout) and returns the character.

Format

```
#include <stdio.h>
int putchar (int character);
```

Argument

character
An object of type int.

Description

The putchar function is identical to `fputc (character, stdout)`.

Compiling with the `__UNIX_PUTC` macro defined enables an optimization that uses a faster, inlined version of this function.

Return Values

character	Indicates success.
EOF	Indicates output errors.

putchar_unlocked *(Integrity servers, Alpha)*

putchar_unlocked *(Integrity servers, Alpha)*

Same as putchar, except used only within a scope protected by flockfile and funlockfile.

Format

```
#include <stdio.h>
int putchar_unlocked (int character);
```

Argument

character
An object of type int.

Description

The reentrant version of the putchar function is locked against multiple threads calling it simultaneously. This incurs overhead to ensure integrity of the output stream. The unlocked version of this call, putchar_unlocked can be used to avoid the overhead. The putchar_unlocked function is functionally identical to the putchar function, except that it is not required to be implemented in a thread-safe manner. The putchar_unlocked function can be safely used only within a scope that is protected by the flockfile and funlockfile functions used as a pair. The caller must ensure that the stream is locked before putchar_unlocked is used.

Compiling with the `__UNIX_PUTC` macro defined enables an optimization that uses a faster, inlined version of this function.

See also flockfile, ftrylockfile, and funlockfile.

Return Values

x	The next character from stdin, converted to int.
EOF	Indicates the end-of-file or an error.

putenv

Sets an environmental variable.

Format

```
#include <stdlib.h>
int putenv (const char *string);
```

Argument

string

A pointer to a *name=value* string.

Description

The `putenv` function sets the value of an environment variable by altering an existing variable or by creating a new one. The *string* argument points to a string of the form *name=value*, where *name* is the environment variable and *value* is the new value for it.

The string pointed to by *string* becomes part of the environment, so altering the string changes the environment. When a new string-defining name is passed to `putenv`, the space used by *string* is no longer used.

Notes

- The `putenv` function manipulates the environment pointed to by the `environ` external variable, and can be used with `getenv`. However, the third argument to the main function (the environment pointer), is not changed.

The `putenv` function uses the `malloc` function to enlarge the environment.

A potential error is to call `putenv` with an automatic variable as the argument, then exit the calling function while *string* is still part of the environment.

- Do not use the `setenv`, `getenv`, and `putenv` functions to manipulate symbols and logicals. Instead, use the OpenVMS library calls `lib$set_logical`, `lib$get_logical`, `lib$set_symbol`, and `lib$get_symbol`. The `*env` functions deliberately provide UNIX behavior, and are not a substitute for these OpenVMS runtime library calls.

OpenVMS DCL symbols, not logical names, are the closest analog to environment variables on UNIX systems. While `getenv` is a mechanism to retrieve either a logical name or a symbol, it maintains an internal cache of values for use with `setenv` and subsequent `getenv` calls. The `setenv` function does not write or create DCL symbols or OpenVMS logical names.

This is consistent with UNIX behavior. On UNIX systems, `setenv` does not change or create any symbols that will be visible in the shell after the program exits.

putenv

Return Values

0	Indicates success.
-1	Indicates an error. <code>errno</code> is set to <code>ENOMEM</code> — Not enough memory available to expand the environment list.

Restriction

The `putenv` function cannot take a 64-bit address. See Section 1.9.

puts

Writes a character string to the standard output (stdout) followed by a new-line character.

Format

```
#include <stdio.h>
int puts (const char *str);
```

Argument

str
A pointer to a character string.

Description

The puts function does not copy the terminating null character to the output stream.

Return Values

Nonnegative value	Indicates success.
EOF	Indicates output errors.

putw

putw

Writes characters to a specified file.

Format

```
#include <stdio.h>
int putw (int integer, FILE *file_ptr);
```

Arguments

integer
An object of type int or long.

file_ptr
A file pointer.

Description

The putw function writes four characters to the output file as an int. No conversion is performed.

Return Values

integer	Indicates success.
EOF	Indicates output errors.

putwc

Converts a wide character to its corresponding multibyte value, and writes the result to a specified file.

Format

```
#include <wchar.h>
wint_t putwc (wint_t wc, FILE *file_ptr);
```

Arguments

wc
An object of type `wint_t`.

file_ptr
A file pointer.

Description

Since `putwc` might be implemented as a macro, a file pointer argument with side effects (for example `putwc (wc, *f++)`) might be evaluated incorrectly. In such a case, use the `fputwc` function instead.

See also `fputwc`.

Return Values

x	The character written to the file. Indicates success.
WEOF	Indicates an output error. The function sets <code>errno</code> . For a list of the <code>errno</code> values set by this function, see <code>fputwc</code> .

putwchar

putwchar

Writes a wide character to the standard output (stdout) and returns the character.

Format

```
#include <wchar.h>
wint_t putwchar (wint_t wc);
```

Arguments

wc
An object of type `wint_t`.

Description

The `putwchar` function is identical to `fputwc(wc, stdout)`.

Return Values

x	The character written to the file. Indicates success.
WEOF	Indicates an output error. The function sets <code>errno</code> . For a list of the <code>errno</code> values set by this function, see <code>fputwc</code> .

pwrite (*Integrity servers, Alpha*)

Writes into a given position within a file without changing the file pointer.

Format

```
#include <unistd.h>
ssize_t pwrite (int file_desc, const void *buffer, size_t nbytes, off_t offset);
```

Arguments

file_desc

A file descriptor that refers to a file currently opened for writing or updating.

buffer

The address of contiguous storage from which the output data is taken.

nbytes

The maximum number of bytes involved in the write operation.

offset

The offset for the desired position inside the file.

Description

The `pwrite` function performs the same action as `write`, except that it writes into a given position in the file without changing the file pointer. The first three arguments to `pwrite` are the same as for `write`, with the addition of a fourth argument *offset* for the desired position inside the file.

Return Values

<code>n</code>	The number of bytes written.
<code>-1</code>	Upon failure, the file pointer remains unchanged and <code>pwrite</code> sets <code>errno</code> to one of the following values: <ul style="list-style-type: none">• <code>EINVAL</code> – The offset argument is invalid. The value is negative.• <code>ESPIPE</code> – <code>file_desc</code> is associated with a pipe or FIFO.

qabs, llabs *(Integrity servers, Alpha)*

qabs, llabs *(Integrity servers, Alpha)*

Returns the absolute value of an integer as an `__int64`. `llabs` is a synonym for `qabs`.

Format

```
#include <stdlib.h>
__int64 qabs (__int64 j);
__int64 llabs (__int64 j);
```

Argument

j
A value of type `__int64`.

qdiv, lldiv *(Integrity servers, Alpha)*

Returns the quotient and the remainder after the division of its arguments. `lldiv` is a synonym for `qdiv`.

Format

```
#include <stdlib.h>
qdiv_t qdiv (__int64 numer, __int64 denom);
lldiv_t lldiv (__int64 numer, __int64 denom);
```

Arguments**numer**

A numerator of type `__int64`.

denom

A denominator of type `__int64`.

Description

The types `qdiv_t` and `lldiv_t` are defined in the `<stdlib.h>` header file as follows:

```
typedef struct
{
    __int64 quot, rem;
} qdiv_t, lldiv_t;
```

qsort

qsort

Sorts an array of objects in place. It implements the quick-sort algorithm.

Format

```
#include <stdlib.h>
```

```
void qsort (void *base, size_t nmem, size_t size, int (*compar) (const void *, const void *));
```

Function Variants

The `qsort` function has variants named `_qsort32` and `_qsort64` for use with 32-bit and 64-bit pointer sizes, respectively. See Section 1.9 for more information on using pointer-size-specific functions.

Arguments

base

A pointer to the first member of the array. The pointer should be of type pointer-to-element and cast to type pointer-to-character.

nmem

The number of objects in the array.

size

The size of an object, in bytes.

compar

A pointer to the comparison function.

Description

Two arguments are passed to the comparison function pointed to by `compar`. The two arguments point to the objects being compared. Depending on whether the first argument is less than, equal to, or greater than the second argument, the comparison function returns an integer less than, equal to, or greater than 0.

The comparison function `compar` need not compare every byte, so arbitrary data might be contained in the objects in addition to the values being compared.

The order in the output of two objects that compare as equal is unpredictable.

raise

Generates a specified software signal. Generating a signal causes the action routine established by the signal, `ssignal`, or `sigvec` function to be invoked.

Format

```
#include <signal.h>

int raise (int sig); (ANSI C)

int raise (int sig[, int sigcode]); (HP C Extension)
```

Arguments

sig

The signal to be generated.

sigcode

An optional signal code, available only when not compiling in strict ANSI C mode. For example, signal SIGFPE—the arithmetic trap signal—has 10 different codes, each representing a different type of arithmetic trap.

The signal codes can be represented by mnemonics or numbers. The arithmetic trap codes are represented by the numbers 1 to 10; the SIGILL codes are represented by the numbers 0 to 2. The code values are defined in the `<signal.h>` header file. See Table 4–4 for a list of signal mnemonics, codes, and corresponding OpenVMS exceptions.

Description

Calling the `raise` function has one of the following results:

- If `raise` specifies a *sig* argument that is outside the range defined in the `<signal.h>` header file, then the `raise` function returns 0, and the `errno` variable is set to `EINVAL`.
- If `signal`, `ssignal`, or `sigvec` establishes `SIG_DFL` (default action) for the signal, then the functions do not return. The image is exited with the OpenVMS error code corresponding to the signal.
- If `signal`, `ssignal`, or `sigvec` establishes `SIG_IGN` (ignore signal) as the action for the signal, then `raise` returns its argument, *sig*.
- `signal`, `ssignal`, or `sigvec` must establish an action function for the signal. That function is called and its return value is returned by `raise`.

See Chapter 4 for more information on signal processing.

See also `gsignal`, `signal`, `ssignal`, and `sigvec`.

Return Values

0	If successful.
nonzero	If unsuccessful.

[no]raw

[no]raw

Raw mode only works with the Curses input routines `[w]getch` and `[w]getstr`. Raw mode is not supported with the HP C RTL emulation of UNIX I/O, Terminal I/O, or Standard I/O.

Format

```
#include <curses.h>

raw()

noraw()
```

Description

Raw mode reads are satisfied on one of two conditions: after a minimum number (5) of characters are input at the terminal or after waiting a fixed time (10 seconds) from receipt of any characters from the terminal.

Example

```
/* Example of standard and raw input in Curses package. */
#include <curses.h>
main()
{
    WINDOW *win1;
    char vert = '.',
        hor = '.',
        str[80];

    /* Initialize standard screen, turn echo off. */
    initscr();
    noecho();

    /* Define a user window. */
    win1 = newwin(22, 78, 1, 1);
    leaveok(win1, TRUE);
    leaveok(stdscr, TRUE);
    box(stdscr, vert, hor);

    /* Reset the video, refresh(redraw) both windows. */
    mvwaddstr(win1, 2, 2, "Test line terminated input");
    wrefresh(win1);

    /* Do some input and output it. */
    nocrmode();
    wgetstr(win1, str);

    mvwaddstr(win1, 5, 5, str);
    mvwaddstr(win1, 7, 7, "Type something to clear screen");
    wrefresh(win1);

    /* Get another character then delete the window. */
    wgetch(win1);
    wclear(win1);

    mvwaddstr(win1, 2, 2, "Test raw input");
    wrefresh(win1);
}
```

```
/* Do some raw input 5 chars or timeout - and output it. */  
raw();  
getstr(str);  
noraw();  
mvwaddstr(win1, 5, 5, str);  
mvwaddstr(win1, 7, 7, "Raw input completed");  
wrefresh(win1);  
endwin();  
}
```

read

read

Reads bytes from a file and places them in a buffer.

Format

```
#include <unistd.h>
```

```
ssize_t read (int file_desc, void *buffer, size_t nbytes); (ISO POSIX-1)
```

```
int read (int file_desc, void *buffer, int nbytes); (Compatibility)
```

Arguments

file_desc

A file descriptor. The specified file descriptor must refer to a file currently opened for reading.

buffer

The address of contiguous storage in which the input data is placed.

nbytes

The maximum number of bytes involved in the read operation.

Description

The read function returns the number of bytes read. The return value does not necessarily equal *nbytes*. For example, if the input is from a terminal, at most one line of characters is read.

Note

The read function does not span record boundaries in a record file and, therefore, reads at most one record. A separate read must be done for each record.

Return Values

n	The number of bytes read.
-1	Indicates a read error, including physical input errors, illegal buffer addresses, protection violations, undefined file descriptors, and so forth.

Example

```
#include <unistd.h>
#include <stdlib.h>
#include <stdio.h>
#include <fcntl.h>

main()
{
    int fd,
        i;
    char buf[10];
    FILE *fp ;           /* Temporary STDIO file */
```

```
/* Create a dummy data file */
if ((fp = fopen("test.txt", "w+")) == NULL) {
    perror("open");
    exit(1);
}
fputs("XYZ\n",fp) ;
fclose(fp) ;
/* And now practice "read" */
if ((fd = open("test.txt", O_RDWR, 0, "shr=upd")) <= 0) {
    perror("open");
    exit(0);
}
/* Read 2 characters into buf. */
if ((i = read(fd, buf, 2)) < 0) {
    perror("read");
    exit(0);
}
/* Print out what was read. */
if (i > 0)
    printf("buf='%c%c'\n", buf[0], buf[1]);
close(fd);
}
```

readdir, readdir_r

readdir, readdir_r

Finds entries in a directory.

Format

```
#include <dirent.h>
struct dirent *readdir (DIR *dir_pointer);
int readdir_r (DIR *dir_pointer, struct dirent *entry, struct dirent **result);
```

Arguments

dir_pointer

A pointer to the `dir` structure of an open directory.

entry

A pointer to a `dirent` structure that will be initialized with the directory entry at the current position of the specified stream.

result

Upon successful completion, the location where a pointer to `entry` is stored.

Description

The `readdir` function returns a pointer to a structure representing the directory entry at the current position in the directory stream specified by `dir_pointer`, and positions the directory stream at the next entry. It returns a NULL pointer upon reaching the end of the directory stream. The `dirent` structure defined in the `<dirent.h>` header file describes a directory entry.

The type `DIR` defined in the `<dirent.h>` header file represents a directory stream. A directory stream is an ordered sequence of all the directory entries in a particular directory. Directory entries represent files. You can remove files from or add files to a directory asynchronously to the operation of the `readdir` function.

The pointer returned by the `readdir` function points to data that you can overwrite by another call to `readdir` on the same directory stream. This data is not overwritten by another call to `readdir` on a different directory stream.

If a file is removed from or added to the directory after the most recent call to the `opendir` or `rewinddir` function, a subsequent call to the `readdir` function might not return an entry for that file.

When it reaches the end of the directory, or when it detects an invalid `seekdir` operation, the `readdir` function returns the null value.

An attempt to seek to an invalid location causes the `readdir` function to return the null value the next time it is called. A previous `telldir` function call returns the position.

The `readdir_r` function is a reentrant version of `readdir`. In addition to `dir_pointer`, you must specify a pointer to a `dirent` structure in which the current directory entry of the specified stream is returned.

If the operation is successful, `readdir_r` returns 0 and stores one of the following two pointers in `result`:

- Pointer to `entry` if the entry was found

- NULL pointer if the end of the directory stream was reached

The storage pointed to by *entry* must be large enough for a `dirent` with an array of char `d_name` member containing at least `NAME_MAX + 1` elements.

If an error occurred, an error value is returned that indicates the cause of the error.

Applications wishing to check for error situations should set `errno` to 0 before calling `readdir`. If `errno` is set to nonzero on return, then an error occurred.

Example

See the description of `closedir` for an example.

Return Values

x	On successful completion of <code>readdir</code> , a pointer to an object of type <code>struct dirent</code> .
0	Successful completion of <code>readdir_r</code> .
x	On error, an error value (<code>readdir_r</code> only).
NULL	An error occurred or end of the directory stream (<code>readdir_r</code> only). If an error occurred, <code>errno</code> is set to a value indicating the cause.

readlink (*Integrity servers, Alpha*)

Reads the contents of the specified symbolic link and places them into a user-supplied buffer.

Format

```
#include <unistd.h>
ssize_t readlink (const char *restrict link_name, char *restrict user_buffer, size_t buffer_size);
```

Arguments

link_name

Pointer to the text string representing the name of the symbolic link file.

user_buffer

Pointer to the user buffer.

buffer_size

Size of the user buffer.

Description

The `readlink` function reads the contents of the specified symbolic link (*link_name*) and places them into a user-supplied buffer (*user_buffer*) of size (*buffer_size*).

See also `symlink`, `unlink`, `realpath`, `lchown`, and `lstat`.

Return Values

n	Upon successful completion, the count of bytes placed in the <i>user_buffer</i>
-1	Indicates an error. The buffer is unchanged, and <code>errno</code> is set to indicate the error: <ul style="list-style-type: none">• <code>EACCES</code> – Read permission is denied in the directory where the symbolic link is being read, or search permission is denied for a component of the path prefix of <i>link_name</i>.• <code>ENAMETOOLONG</code> – The length of the <i>link_name</i> argument exceeds <code>PATH_MAX</code>, or a pathname component is longer than <code>NAME_MAX</code>.• Any <code>errno</code> value from <code>close</code>, <code>open</code>, or <code>read</code>.

readv (Integrity servers, Alpha)

Reads from a file.

Format

```
#include <sys/uio.h>
ssize_t readv (int file_desc, const struct iovec *iov, int iovcnt);
ssize_t _readv64 (int file_desc, struct __iovec64 *iov, int iovcnt);
```

Function Variants

The `readv` function has variants named `_readv32` and `_readv64` for use with 32-bit and 64-bit pointer sizes, respectively. See Section 1.9 for more information on using pointer-size-specific functions.

Arguments**file_desc**

A file descriptor. A file descriptor that must refer to a file currently opened for reading.

iov

Array of `iovec` structures into which the input data is placed.

iovcnt

The number of buffers specified by the members of the `iov` array.

Description

The `readv` function is equivalent to `read`, but places the input data into the `iovcnt` buffers specified by the members of the `iov` array: `iov[0]`, `iov[1]`, ..., `iov[iovcnt-1]`. The `iovcnt` argument is valid if it is greater than 0 and less than or equal to `IOV_MAX`.

Each `iovec` entry specifies the base address and length of an area in memory where data should be placed. The `readv` function always fills an area completely before proceeding to the next.

Upon successful completion, `readv` marks for update the `st_atime` field of the file.

If the Synchronized Input and Output option is supported:

If the `O_DSYNC` and `O_RSYNC` bits have been set, read I/O operations on the file descriptor will complete as defined by synchronized I/O data integrity completion.

If the `O_SYNC` and `O_RSYNC` bits have been set, read I/O operations on the file descriptor will complete as defined by synchronized I/O file integrity completion.

If the Shared Memory Objects option is supported:

If `file_desc` refers to a shared memory object, the result of the `read` function is unspecified.

For regular files, no data transfer occurs past the offset maximum established in the open file description associated with `file_desc`.

Return Values

n

The number of bytes read.

−1

Indicates a read error. The function sets `errno` to one of the following values:

- **EAGAIN** – The `O_NONBLOCK` flag is set for the file descriptor, and the process would be delayed.
- **EBADF** – The *file_desc* argument is not a valid file descriptor open for reading.
- **EBADMSG** – The file is a `STREAM` file that is set to control-normal mode, and the message waiting to be read includes a control part.
- **EINTR** – The read operation was terminated because of the receipt of a signal, and no data was transferred.
- **EINVAL** – The `STREAM` or multiplexer referenced by *file_desc* is linked (directly or indirectly) downstream from a multiplexer.
OR
The sum of the `iov_len` values in the *iov* array overflowed an `ssize_t`.
- **EIO** – A physical I/O error has occurred.
OR
The process is a member of a background process attempting to read from its controlling terminal, the process is ignoring or blocking the `SIGTTIN` signal, or the process group is orphaned.
- **EISDIR** – The *file_desc* argument refers to a directory, and the implementation does not allow the directory to be read using `read`, `pread` or `readv`. Use the `readdir` function instead.
- **EOVERFLOW** – The file is a regular file, *nbyte* is greater than 0, and the starting position is before the end-of-file and is greater than or equal to the offset maximum established in the open file description associated with *file_desc*.

The `readv` function *may* fail if:

- **EINVAL** – The *iovcnt* argument was less than or equal to 0, or greater than `IOV_MAX`.

realloc

NULL

Indicates that space cannot be reallocated (for example, if there is not enough room).

realpath

Returns an absolute pathname from the POSIX root.

Format

```
#include <stdlib.h>

char realpath (const char *restrict file_name, char *restrict resolved_name);
```

Arguments

file_name

Pointer to the text string representing the name of the file for which you want the absolute path.

resolved name

Pointer to the generated absolute path stored as a null-terminated string.

Description

The `realpath` function returns an absolute pathname from the POSIX root. The generated pathname is stored as a null-terminated string, up to a maximum of `PATH_MAX` bytes, in the buffer pointed to by *resolved_name*.

The `realpath` function is supported only in POSIX-compliant modes (that is, with `DECC$POSIX_COMPLIANT_PATHNAMES` defined to one of the allowed values).

See also `symlink`, `unlink`, `readlink`, `lchown`, and `lstat`.

Return Values

x	Upon successful completion, a pointer to the <i>resolved_name</i> .
NULL	Indicates an error. A null pointer is returned, the contents of the buffer pointed to by <i>resolved_name</i> are undefined, and <code>errno</code> is set to indicate the error: <ul style="list-style-type: none">• <code>ENAMETOOLONG</code> – The length of the <i>file_name</i> argument exceeds <code>PATH_MAX</code>, or a pathname component is longer than <code>NAME_MAX</code>.• <code>ENOENT</code> – A component of <i>file_name</i> does not name an existing file, or <i>file_name</i> points to an empty string.• Any <code>errno</code> value from <code>chdir</code> or <code>stat</code>.

[w]refresh

[w]refresh

Repaint the specified window on the terminal screen. The refresh function acts on the `stdscr` window.

Format

```
#include <curses.h>
int refresh();
int wrefresh (WINDOW *win);
```

Argument

win
A pointer to the window.

Description

The result of this process is that the portion of the window not occluded by subwindows or other windows appears on the terminal screen. To see the entire occluded window on the terminal screen, call the `touchwin` function instead of the `refresh` or `wrefresh` function.

See also `touchwin`.

Return Values

OK	Indicates success.
ERR	Indicates an error.

remainder (Integrity servers, Alpha)

Returns the floating-point remainder $r = x - n*y$ when y is nonzero.

Format

```
#include <math.h>
```

```
double remainder (double x, double y);
```

```
float remainderf (float x, float y);
```

```
long double remainderl (long double x, long double y);
```

Argument

x

A real number.

y

A real number.

Description

These functions return the floating-point remainder $r = x - n*y$ when y is nonzero. The value n is the integral value nearest the exact value x/y . That is, $n = \text{rint}(x/y)$.

When $|n - x/y| = 1/2$, the value n is chosen to be even.

The behavior of the remainder function is independent of the rounding mode.

The remainder functions are functionally equivalent to the remquo functions.

Return Values

r

Upon successful completion, these functions return the floating-point remainder $r = x - ny$ when y is nonzero.

Nan

If x or y is Nan.

remquo (*Integrity servers, Alpha*)

remquo (*Integrity servers, Alpha*)

Returns the floating-point remainder $r = x - n*y$ when y is nonzero.

Format

```
#include <math.h>
```

```
double remquo (double x, double y, int * quo);
```

```
float remquof (float x, float y, int * quo);
```

```
long double remquol (long double x, long double y, int * quo);
```

Argument

x

A real number.

y

A real number.

quo

Description

The `remquo()`, `remquof()`, and `remquol()` functions compute the same remainder as the `remainder()`, `remainderf()`, and `remainderl()` functions, respectively. In the object pointed to by `quo`, they store a value whose sign is the sign of x/y and whose magnitude is congruent modulo $2n$ to the magnitude of the integral quotient of x/y , where n is an implementation-defined integer greater than or equal to 3.

The `remquo` functions are functionally equivalent to the `remainder` functions.

Return Values

<code>r</code>	Upon successful completion, these functions return the floating-point remainder $r = x - ny$ when y is nonzero.
<code>Nan</code>	If x or y is <code>Nan</code> .

remove

Deletes a file.

Format

```
#include <stdio.h>
int remove (const char *file_spec);
```

Argument

file_spec

A pointer to the string that is an OpenVMS or a UNIX style file specification. The file specification can include a wildcard in its version number. So, for example, files of the form *filename.txt;** can be deleted.

Description

If you specify a directory in the filename and it is a search list that contains an error, HP C for OpenVMS Systems interprets it as a file error.

Note

The DECC\$ALLOW_REMOVE_OPEN_FILES feature logical controls the behavior of the remove function on open files. Ordinarily, the operation fails. However, POSIX conformance dictates that the operation succeed.

With DECC\$ALLOW_REMOVE_OPEN_FILES enabled, this POSIX conformant behavior is achieved.

When remove is used to delete a symbolic link, the link itself is deleted, not the file to which it refers.

The remove and delete functions are functionally equivalent in the HP C RTL.

See also delete.

Return Values

0	Indicates success.
nonzero value	Indicates failure.

rename

rename

Gives a new name to an existing file.

Format

```
#include <stdio.h>

int rename (const char *old_file_spec, const char *new_file_spec);
```

Arguments

old_file_spec

A pointer to a string that is the existing name of the file to be renamed.

new_file_spec

A pointer to a string that is to be the new name of the file.

Description

If you try to rename a file that is currently open, the behavior is undefined. You cannot rename a file from one physical device to another. Both the old and new file specifications must reside on the same device.

If the *new_file_spec* does not contain a file extension, the file extension of *old_file_spec* is used. To rename a file to have no file extension, *new_file_spec* must contain a period (.) For example, the following renames SYS\$DISK:[]FILE.DAT to SYS\$DISK:[]FILE1.DAT:

```
rename("file.dat", "file1");
```

However, the following renames SYS\$DISK:[]FILE.DAT to SYS\$DISK:[]FILE1:

```
rename("file.dat", "file1.");
```

Note

Because the rename function does special processing of the file extension, the caller must be careful when specifying the name of the renamed file in a call to a C Run-Time Library function that accepts a file-name argument. For example, after the following call to the rename function, the new file should be opened as `fopen("bar.dat", ...)`:

```
rename("foo.dat", "bar");
```

The rename function is affected by the setting of the DECC\$RENAME_NO_INHERIT and DECC\$RENAME_ALLOW_DIR feature logicals as follows:

- DECC\$RENAME_NO_INHERIT provides more UNIX compliant behavior in rename, and affects whether or not the new name for the file inherits anything (like file type) from the old name or must be specified completely.
- DECC\$RENAME_ALLOW_DIR lets you choose between the previous OpenVMS behavior of allowing the renaming of a file from one directory to another, or the more UNIX compliant behavior of not allowing the renaming of a file to a directory.

See the `DECC$RENAME_NO_INHERIT` and `DECC$RENAME_ALLOW_DIR` descriptions in Section 1.5 for more information.

Return Values

0	Indicates success.
-1	Indicates failure. The function sets <code>errno</code> to one of the following values: <ul style="list-style-type: none">• <code>EISDIR</code> – The new argument points to a directory, and the old argument points to a file that is not a directory.• <code>EEXIST</code> – The new argument points to a directory that already exists.• <code>ENOTDIR</code> – The old argument names a directory, and new argument names a non-directory file.• <code>ENOENT</code> – The old argument points to a file, directory, or device that does not exist. Or the new argument points to a nonexistent directory path or device.

rewind

rewind

Sets the file to its beginning.

Format

```
#include <stdio.h>
void rewind (FILE *file_ptr); (ISO POSIX-1)
int rewind (FILE *file_ptr); (HP C Extension)
```

Argument

file_ptr
A file pointer.

Description

The `rewind` function is equivalent to `fseek (file_ptr, 0, SEEK_SET)`. You can use the `rewind` function with either record or stream files.

A successful call to `rewind` clears the error indicator for the file.

The ANSI C standard defines `rewind` as not returning a value; therefore, the function prototype for `rewind` is declared with a return type of `void`. However, since a `rewind` can fail, and since previous versions of the HP C RTL have declared `rewind` to return an `int`, the code for `rewind` does return 0 on success and -1 on failure.

See also `fseek`.

rewinddir

Resets the position of the specified directory stream to the beginning of a directory.

Format

```
#include <dirent.h>
void rewinddir (DIR *dir_pointer);
```

Argument

dir_pointer

A pointer to the `dir` structure of an open directory.

Description

The `rewinddir` function resets the position of the specified directory stream to the beginning of the directory. It also causes the directory stream to refer to the current state of the corresponding directory, the same as using the `opendir` function. If the *dir_pointer* argument does not refer to a directory stream, the effect is undefined.

The type `DIR`, defined in the `<dirent.h>` header file, represents a directory stream. A directory stream is an ordered sequence of all the directory entries in a particular directory. Directory entries represent files.

See also `opendir`.

rindex

rindex

Searches for a character in a string.

Format

```
#include <strings.h>
char *rindex (const char *s, int c);
```

Function Variants

The `rindex` function has variants named `_rindex32` and `_rindex64` for use with 32-bit and 64-bit pointer sizes, respectively. See Section 1.9 for more information on using pointer-size-specific functions.

Arguments

s
The string to search.

c
The character to search for.

Description

The `rindex` function is identical to the `strchr` function, and is provided for compatibility with some UNIX implementations.

rint (*Integrity servers, Alpha*)

Rounds its argument to an integral value according to the current IEEE rounding direction specified by the user.

Format

```
#include <math.h>
double rint (double x);
float rintf (float x);
long double rintl (long double x);
```

Argument

x
A real number.

Description

The `rint` functions return the nearest integral value to x in the direction of the current IEEE rounding mode specified on the `/ROUNDING_MODE` command-line qualifier.

If the current rounding mode rounds toward negative Infinity, then `rint` is identical to `floor`. If the current rounding mode rounds toward positive Infinity, then `rint` is identical to `ceil`.

If $|x| = \text{Infinity}$, `rint` returns x .

Return Values

<code>n</code>	The nearest integral value to x in the direction of the current IEEE rounding mode.
<code>NaN</code>	x is <code>NaN</code> ; <code>errno</code> is set to <code>EDOM</code> .

rmdir

rmdir

Removes a directory file.

Format

```
#include <unistd.h>
int rmdir (const char *path);
```

Argument

path
A directory pathname.

Description

The `rmdir` function removes a directory file whose name is specified in the *path* argument. The directory is removed only if it is empty.

If *path* names a symbolic link, then `rmdir` fails and sets `errno` to `ENOTDIR`.

Restriction

When using OpenVMS format names, the *path* argument must be in the form *directory.dir*.

Return Values

0	Indicates success.
-1	An error occurred; <code>errno</code> is set to indicate the error.

sbrk

Determines the lowest virtual address that is not used with the program.

Format

```
#include <unistd.h>
void *sbrk (long int incr);
```

Argument

incr

The number of bytes to add to the current break address.

Description

The `sbrk` function adds the number of bytes specified by its argument to the current break address and returns the old break address.

When a program is executed, the break address is set to the highest location defined by the program and data storage areas. Consequently, `sbrk` is needed only by programs that have growing data areas.

`sbrk(0)` returns the current break address.

Return Values

x	The old break address.
(void *)(-1)	Indicates that the program is requesting too much memory.

Restriction

Unlike other C library implementations, the HP C RTL memory allocation functions (such as `malloc`) do not rely on `brk` or `sbrk` to manage the program heap space. Consequently, on OpenVMS systems, calling `brk` or `sbrk` can interfere with memory allocation routines. The `brk` and `sbrk` functions are provided only for compatibility purposes.

scalb (*Integrity servers, Alpha*)

Returns the exponent of a floating-point number.

Format

```
#include <math.h>
double scalb (double x, double n);
float scalbf (float x, float n);
long double scalbl (long double x, long double n);
```

Arguments

x
A nonzero floating-point number.

n
An integer.

Description

The scalb functions return $x^{(2^{**}n)}$ for integer n .

Return Values

x	On successful completion, $x^{(2^{**}n)}$ is returned.
±HUGE_VAL	On overflow, scalb returns ±HUGE_VAL (according to the sign of x) and sets errno to ERANGE.
0	Underflow occurred; errno is set to ERANGE.
x	x is ±Infinity.
NaN	x or n is NaN; errno is set to EDOM.

scanf

Performs formatted input from the standard input (`stdin`), interpreting it according to the format specification. See Chapter 2 for information on format specifiers.

Format

```
#include <stdio.h>

int scanf (const char *format_spec, ... );
```

Arguments

format_spec

Pointer to a string containing the format specification. The format specification consists of characters to be taken literally from the input or converted and placed in memory at the specified input sources. For a list of conversion characters, see Chapter 2.

...

Optional expressions that are pointers to objects whose resultant types correspond to conversion specifications given in the format specification.

If no conversion specifications are given, you can omit these input pointers. Otherwise, the function call must have at least as many input pointers as there are conversion specifications, and the conversion specifications must match the types of the input pointers.

Conversion specifications are matched to input sources in left-to-right order. Excess input pointers, if any, are ignored.

Return Values

x	The number of successfully matched and assigned input items.
EOF	Indicates that a read error occurred prior to any successful conversions. The function sets <code>errno</code> . For a list of <code>errno</code> values set by this function, see <code>fscanf</code> .

[w]scanw

[w]scanw

Perform a scanf on the window. The scanw function acts on the stdscr window.

Format

```
#include <curses.h>
int scanw (char *format_spec, ... );
int wscanw (WINDOW *win, char *format_spec, ... );
```

Arguments

win

A pointer to the window.

format_spec

A pointer to the format specification string.

...

Optional expressions that are pointers to objects whose resultant types correspond to conversion specifications given in the format specification. If no conversion specifications are given, you may omit these input pointers.

Otherwise, the function call must have at least as many input pointers as there are conversion specifications, and the conversion specifications must match the types of the input pointers.

Conversion specifications are matched to input sources in left-to-right order. Excess input pointers, if any, are ignored.

Description

The formatting specification (*format_spec*) and the other arguments are identical to those used with the scanf function.

The scanw and wscanw functions accept, format, and return a line of text from the terminal screen. For more information, see the scrollok and scanf functions.

Return Values

OK	Indicates success.
ERR	Indicates that the function makes the screen scroll illegally or that the scan was unsuccessful.

scroll

Moves all the lines on the window up one line. The top line scrolls off the window and the bottom line becomes blank.

Format

```
#include <curses.h>
int scroll (WINDOW *win);
```

Argument

win
A pointer to the window.

Return Values

OK	Indicates success.
ERR	Indicates an error.

scrollok

scrollok

Sets the scroll flag for the specified window.

Format

```
#include <curses.h>
scrollok (WINDOW *win, bool boolf);
```

Arguments

win

A pointer to the window.

boolf

A Boolean TRUE or FALSE value. If *boolf* is FALSE, scrolling is not allowed. This is the default setting. The *bool* type is defined in the `<curses.h>` header file as follows:

```
#define bool int
```

seekdir

seekdir

Sets the position of a directory stream.

Format

```
#include <dirent.h>
void seekdir (DIR *dir_pointer, long int location);
```

Arguments

dir_pointer

A pointer to the `dir` structure of an open directory.

location

The number of an entry relative to the start of the directory.

Description

The `seekdir` function sets the position of the next `readdir` operation on the directory stream specified by *dir_pointer* to the position specified by *location*. The value of *location* should be returned from an earlier call to *telldir*.

If the value of *location* was not returned by a call to the `telldir` function, or if there was an intervening call to the `rewinddir` function on this directory stream, the effect is unspecified.

The type `DIR`, defined in the `<dirent.h>` header file, represents a directory stream. A directory stream is an ordered sequence of all the directory entries in a particular directory. Directory entries represent files. You can remove files from or add files to a directory asynchronously to the operation of the `readdir` function.

See `readdir`, `rewinddir`, and `telldir`.

sem_close (*Integrity servers, Alpha*)

Deallocates the specified named semaphore.

Format

```
#include <semaphore.h>
int sem_close (sem_t *sem);
```

Argument**sem**

The semaphore to be closed. Use the *sem* argument returned by the previous call to `sem_open`.

Description

The `sem_close` function makes a semaphore available for reuse by deallocating any system resources allocated for use by the current process for the named semaphore indicated by *sem*.

If the semaphore has not been removed with a call to `sem_unlink`, `sem_close` does not change the current state of the semaphore.

If the semaphore has been removed with a call to `sem_unlink` after the most recent call to `sem_open` with `O_CREAT`, the semaphore is no longer available after all processes that opened the semaphore close it.

Return Values

0	Successful completion.
-1	Indicates an error. The function sets <code>errno</code> to one of the following values: <ul style="list-style-type: none">• <code>EINVAL</code> – The <i>sem</i> argument is not a valid semaphore descriptor.• <code>ENOSYS</code> – The function is not implemented.• <code>EVMSError</code> – OpenVMS specific nontranslatable error code.

semctl (*Integrity servers, Alpha*)

Semaphore control operations.

Format

```
#include <sem.h>

int semctl (int semid, int semnum, int cmd, . . . );
```

Argument

semid

A semaphore set identifier, a positive integer. It is created by the `semget` function and used to identify the semaphore set on which to perform the control operation.

semnum

Semaphore number, a non-negative integer. It identifies a semaphore within the semaphore set on which to perform the control operation.

cmd

The control operation to perform on the semaphore.

. . .

Optional fourth argument of type union `semun`, which depends on the control operation requested in *cmd*.

Description

The `semctl` function provides a variety of semaphore control operations as specified by *cmd*. The fourth argument is optional and depends upon the operation requested. If required, it is of type union `semun`, which is explicitly declared as:

```
union semun {
    int val;
    struct semid_ds *buf;
    unsigned short *array;
} arg;
```

The following semaphore control operations as specified by *cmd* are executed with respect to the semaphore specified by *semid* and *semnum*. The level of permission required for each operation is shown with each command. The symbolic names for the values of *cmd* are defined in the `<sem.h>` header:

- **GETVAL**
Returns the value of *semval*. Requires read permission.
- **SETVAL**
Sets the value of *semval* to *arg.val*, where *arg* is the value of the fourth argument to `semctl`. When this command is successfully executed, the *semadj* value corresponding to the specified semaphore in all processes is cleared. Requires alter permission.
- **GETPID**
Returns the value of *sempid*; requires read permission.

- GETNCNT
Returns the value of *semncnt*; requires read permission.
- GETZCNT
Returns the value of *semzcnt*; requires read permission.

The following values of *cmd* operate on each *semval* in the set of semaphores:

- GETALL
Returns the value of *semval* for each semaphore in the semaphore set and places it into the array pointed to by *arg.array*, where *arg* is the fourth argument to *semctl*; requires read permission.
- SETALL
Sets the value of *semval* for each semaphore in the semaphore set according to the array pointed to by *arg.array*, where *arg* is the fourth argument to *semctl*. When this command is successfully executed, the *semadj* values corresponding to each specified semaphore in all processes are cleared. Requires alter permission.

The following values of *cmd* are also available:

- IPC_STAT
Places the current value of each member of the *semid_ds* data structure associated with *semid* into the structure pointed to by *arg.buf*, where *arg* is the fourth argument to *semctl*. The contents of this structure are defined in `<sem.h>`. Requires read permission.
- IPC_SET
Sets the value of the following members of the *semid_ds* data structure associated with *semid* to the corresponding value found in the structure pointed to by *arg.buf*, where *arg* is the fourth argument to *semctl*:

```
sem_perm.uid
sem_perm.gid
sem_perm.mode
```

The mode bits specified in *The Open Group Base Specifications* IPC General Description section are copied into the corresponding bits of the *sem_perm.mode* associated with *semid*. The stored values of any other bits are unspecified.

This command can only be executed by a process that has an effective user ID equal to either that of a process with appropriate privileges or to the value of *sem_perm.cuid* or *sem_perm.uid* in the *semid_ds* data structure associated with *semid*.
- IPC_RMID
Removes the semaphore identifier specified by *semid* from the system and destroys the set of semaphores and *semid_ds* data structure associated with it. This command can only be executed by a process that has an effective user ID equal to either that of a process with appropriate privileges or to the value of *sem_perm.cuid* or *sem_perm.uid* in the *semid_ds* data structure associated with *semid*.

Return Values

n or 0

Upon successful completion, the value returned by the function depends on *cmd* as follows:

- GETVAL - The value of *semval*
- GETPID - The value of *sempid*
- GETNCNT - The value of *semncnt*
- GETZCNT - The value of *semzcnt*
- All others - 0

-1

Indicates an error. The function sets *errno* to one of the following values:

- EACCES – Operation permission is denied to the calling process.
- EFAULT – The arguments passed to the function are not accessible.
- EINVAL – The value of *semid* is not a valid semaphore identifier, or the value of *semnum* is less than zero or greater than or equal to *sem_nsems*, or the value of *cmd* is not a valid command.
- EPERM – The argument *cmd* is equal to *IPC_RMID* or *IPC_SET* and the effective user ID of the calling process is not equal to that of a process with appropriate privileges and it is not equal to the value of *sem_perm.cuid* or *sem_perm.uid* in the data structure associated with *semid*.
- EVMSERR – OpenVMS specific nontranslatable error code.

sem_destroy (*Integrity servers, Alpha*)

Destroys an unnamed semaphore.

Format

```
#include <semaphore.h>
int sem_destroy (sem_t *sem);
```

Argument**sem**

The unnamed semaphore to be destroyed. Use the *sem* argument that was supplied to, and filled in by, the previous call to `sem_init`.

Description

The `sem_destroy` function destroys an unnamed semaphore indicated by *sem*. Only a semaphore created using `sem_init` may be destroyed using `sem_destroy`.

The potential for deadlock exists if a process calls `sem_destroy` for a semaphore while there is a pending `sem_wait`, because a process may be waiting for a poster that has not yet opened the semaphore.

Return Values

0	Successful completion.
-1	Indicates an error. The function sets <code>errno</code> to one of the following values, without destroying the semaphore indicated by the <i>sem</i> argument: <ul style="list-style-type: none">• <code>EINVAL</code> – The <i>sem</i> argument is not a valid semaphore.• <code>ENOSYS</code> – The function is not implemented.• <code>EVMSEERR</code> – OpenVMS specific nontranslatable error code.• <code>EBUSY</code> – The processes are blocked on the semaphore.

semget (*Integrity servers, Alpha*)

Gets a set of semaphores.

Format

```
#include <sem.h>

int semget (key_t key, int nsems, int semflg);
```

Argument

key

The key for which the associated semaphore identifier is returned.

nsems

Value used to initialize the *sem_nsems* member of the *semid_ds* data structure. See the description.

semflg

Flag used to initialize the low-order 9 bits of the *sem_perm.mode* member of the *semid_ds* data structure associated with the new semaphore. See the description.

value

The initial value to be given to the semaphore. This argument is used only when the semaphore is being created.

Description

The *semget* function returns the semaphore identifier associated with *key*.

A semaphore identifier with its associated *semid_ds* data structure and its associated set of *nsems* semaphores (see the `<sys/sem.h>` header file) is created for *key* if:

- The *key* argument does not already have a semaphore identifier associated with it and (*semflg* & `IPC_CREAT`) is nonzero.

When it is created, the *semid_ds* data structure associated with the new semaphore identifier is initialized as follows:

- In the operation permissions structure *sem_perm.cuid*, *sem_perm.uid*, *sem_perm.cgid*, and *sem_perm.gid* are set equal to the effective user ID and effective group ID, respectively, of the calling process.
- The low-order 9 bits of *sem_perm.mode* are set equal to the low-order 9 bits of the *semflg* argument.
- The variable *sem_nsems* is set equal to the value of the *nsems* argument.
- The variable *sem_otime* is set equal to 0 and the variable *sem_ctime* is set equal to the current time.
- The data structure associated with each semaphore in the set does not need to be initialized. You can use the *semctl* function with the command `SETVAL` or `SETALL` to initialize each semaphore.

Note

The *key* argument value IPC_PRIVATE is not supported.

Return Values

n	Successful completion. The function returns a non-negative integer semaphore identifier.
-1	Indicates an error. The function sets errno to one of the following values: <ul style="list-style-type: none"> • EACCES – A semaphore identifier exists for <i>key</i>, but operation permission as specified by the low-order 9 bits of <i>semflg</i> was not granted. • EEXIST – A semaphore identifier exists for key but ((<i>semflg</i> &IPC_CREAT) &&(semflg &IPC_EXCL)) is nonzero. • EFAULT – The arguments passed to the function are not accessible. • EINVAL – The value of <i>nsems</i> is either less than or equal to 0 or greater than the system-imposed limit, or a semaphore identifier exists for <i>key</i>, but the number of semaphores in the set associated with it is less than <i>nsems</i> and <i>nsems</i> is not equal to 0. • ENOENT – A semaphore identifier does not exist for <i>key</i> and (<i>semflg</i> &IPC_CREAT) is equal to 0. • ENOSPC – A semaphore identifier is to be created but the system-imposed limit on the maximum number of allowed semaphores system-wide will be exceeded. • EVMSERR – OpenVMS specific nontranslatable error code.

sem_getvalue (*Integrity servers, Alpha*)

sem_getvalue (*Integrity servers, Alpha*)

Gets the value of a specified semaphore.

Format

```
#include <semaphore.h>
int sem_getvalue (sem_t *sem, int *sval);
```

Argument

sem

The semaphore for which a value is to be returned.

sval

The location to be updated with the value of the semaphore indicated by the *sem* argument.

Description

The `sem_getvalue` function updates a location referenced by the *sval* argument with the value of semaphore *sem*. The updated value represents an actual semaphore value that occurred during the call, but may not be the actual value of the semaphore at the time that the value is returned to the calling process.

If the semaphore is locked, the value returned will either be zero or a negative number indicating the number of processes waiting for the semaphore at some time during the call.

Return Values

0	Successful completion.
-1	Indicates an error. The function sets <code>errno</code> to one of the following values: <ul style="list-style-type: none">• <code>EINVAL</code> – The <i>sem</i> argument is not a valid semaphore.• <code>EVMSEERR</code> – OpenVMS specific nontranslatable error code.

sem_init (*Integrity servers, Alpha*)

Initializes an unnamed semaphore.

Format

```
#include <semaphore.h>
int sem_init (sem_t *sem, int pshared, unsigned int value );
```

Argument**sem**

The location to receive the descriptor of the initialized semaphore.

pshared

A value indicating whether the semaphore should be sharable between the creating process and its descendants (nonzero value) or not (zero).

Note

The value for pshared must be zero between threads because this release does not support unnamed semaphores to be shared across processes.

value

The initial value to be given to the semaphore.

Description

The `sem_init` function creates a new counting semaphore with a specific value. A semaphore is used to limit access to a critical resource. When a process requires access to the resource without interference from other processes, it attempts to establish a connection with the associated semaphore. If the semaphore value is greater than zero, the connection is established and the semaphore value is decremented by one. If the semaphore value is less than or equal to zero, the process attempting to access the resource is blocked and must wait for another process to release the semaphore and increment the semaphore value.

The `sem_init` function establishes a connection between an unnamed semaphore and a process; the `sem_wait` and `sem_trywait` functions lock the semaphore; and the `sem_post` function unlocks the semaphore. Use the `sem_destroy` function to deallocate system resources allocated to the process for use with the semaphore. You can use the `sem_getvalue` function to obtain the value of a semaphore.

A semaphore created by a call to the `sem_init` function remains valid until the semaphore is removed by a call to the `sem_destroy` function.

sem_init (*Integrity servers, Alpha*)

Return Values

0

Successful completion.

-1

Indicates an error. The function sets `errno` to one of the following values:

- `EINVAL` – The value argument exceeds `{SEM_VALUE_MAX}`.
- `ENOSYS` – The function is not implemented.
- `EVMSEERR` – OpenVMS specific nontranslatable error code.

sem_open (Integrity servers, Alpha)

Opens/creates a named semaphore for use by a process.

Format

```
#include <semaphore.h>
sem_t *sem_open (const char *name, int option...);
```

Argument**name**

a string naming the semaphore object.

option

Specifies whether the semaphore is to be created (O_CREAT option bit set) or only opened (O_CREAT option bit clear). If O_CREAT is set, the O_EXCL option bit may additionally be set to specify that the call should fail if a semaphore of the same name already exists. The O_CREAT and O_EXCL options are defined in the <fcntl.h> header file.

mode

The semaphore's permission bits. This argument is used only when the semaphore is being created.

value

The initial value to be given to the semaphore. This argument is used only when the semaphore is being created.

Description

Use the `sem_open` function to establish the connection between a named semaphore and a process. Subsequently, the calling process can reference the semaphore by using the address returned from the call. The semaphore is available in subsequent calls to `sem_wait`, `sem_trywait`, `sem_post`, and `sem_getvalue` functions. The semaphore remains usable by the process until the semaphore is closed by a successful call to the `sem_close` function.

The O_CREAT option bit in the *option* parameter controls whether the semaphore is created or only opened by the call to `sem_open`.

A created semaphore's user ID is set to the user ID of the calling process and its group ID is set to a system default group or to the group ID of the process. The semaphore's permission bits are set to the value of the mode argument, except for those set in the file mode creation mask of the process.

After a semaphore is created, other processes can open the semaphore by calling `sem_open` with the same value for the name argument.

Return Values

<code>sem</code>	Successful completion. The function opens the semaphore and returns the semaphore's descriptor.
<code>sem_failed</code>	Indicates an error. The function sets <code>errno</code> to one of the following values: <ul style="list-style-type: none">• <code>EACCES</code>—The named semaphore exists and the permissions specified by <i>option</i> are denied, or the named semaphore does not exist and the permissions specified by <i>option</i> are denied.• <code>EEXIST</code>—<code>O_CREAT</code> and <code>O_EXCL</code> are set, and the named semaphore already exists.• <code>EINVAL</code>—The <code>sem_open</code> operation is not supported for the given name. Or, <code>O_CREAT</code> was specified in <i>option</i> and <i>value</i> was greater than <code>{SEM_VALUE_MAX}</code>.• <code>EMFILE</code>—Too many semaphore descriptors or file descriptors are currently in use by this process.• <code>ENAMETOOLONG</code>—The length of the <i>name</i> string exceeds <code>{PATH_MAX}</code>, or a pathname component is longer than <code>{NAME_MAX}</code> while <code>{_POSIX_NO_TRUNC}</code> is in effect.• <code>ENFILE</code>—Too many semaphores are currently open in the system. <code>ENOENT</code> <code>O_CREAT</code> is not set, and the named semaphore does not exist.• <code>ENOSPC</code>—Insufficient space exists for the creation of a new named semaphore.• <code>EVMSEERR</code>—OpenVMS specific nontranslatable error code.

semop (Integrity servers, Alpha)

Performs operations on semaphores in a semaphore set.

Format

```
#include <sem.h>

int semop (int semid, struct sembuf *sops, size_t nsops);
```

Argument**semid**

Semaphore set identifier.

sops

Pointer to a user-defined array of semaphore operation (sembuf) structures.

nsops

Number of sembuf structures in the sops array.

Description

The semop function performs operations on semaphores in the semaphore set specified by *semid*. These operations are supplied in a user-defined array of semaphore operation sembuf structures specified by *sops*. Each sembuf structure includes the following member variables:

```
struct sembuf {
    /* semaphore operation structure */
    unsigned short sem_num; /* semaphore number */
    short sem_op; /* semaphore operation */
    short sem_flg; /* operation flags SEM_UNDO and IPC_NOWAIT */
};
```

Each semaphore operation specified by the *sem_op* variable is performed on the corresponding semaphore specified by the *semid* function argument and the *sem_num* variable.

The *sem_op* variable specifies one of three semaphore operations:

1. If *sem_op* is a negative integer and the calling process has change permission, one of the following occurs:
 - If *semval* (see <sem.h>) is greater than or equal to the absolute value of *sem_op*, the absolute value of *sem_op* is subtracted from *semval*. Also, if (*sem_flg* & SEM_UNDO) is non-zero, the absolute value of *sem_op* is added to the calling process' *semadj* value for the specified semaphore.
 - If *semval* is less than the absolute value of *sem_op* and (*sem_flg* & IPC_NOWAIT) is nonzero, semop returns immediately.
 - If *semval* is less than the absolute value of *sem_op* and (*sem_flg* & IPC_NOWAIT) is 0, semop increments the *semncnt* associated with the specified semaphore and suspends execution of the calling thread until one of the following conditions occurs:
 - The value of *semval* becomes greater than or equal to the absolute value of *sem_op*. When this occurs, the value of *semncnt* associated with the specified semaphore is decremented, the absolute value of *sem_op* is subtracted from *semval* and, if (*sem_flg* & SEM_UNDO) is

- nonzero, the absolute value of *sem_op* is added to the calling process' *semadj* value for the specified semaphore.
- The *semid* for which the calling thread is awaiting action is removed from the system. When this occurs, *errno* is set equal to *EIDRM* and -1 is returned.
 - The calling thread receives a signal that is to be intercepted. When this occurs, the value of *semncnt* associated with the specified semaphore is decremented, and the calling thread resumes execution in the manner prescribed in *sigaction*.
2. If *sem_op* is a positive integer and the calling process has change permission, the value of *sem_op* is added to *semval* and, if (*sem_flg* & *SEM_UNDO*) is nonzero, the value of *sem_op* is subtracted from the calling process' *semadj* value for the specified semaphore.
3. If *sem_op* is 0 and the calling process has read permission, one of the following occurs:
- If *semval* is 0, *semop* returns immediately.
 - If *semval* is nonzero and (*sem_flg* & *IPC_NOWAIT*) is nonzero, *semop* returns immediately.
 - If *semval* is nonzero and (*sem_flg* & *IPC_NOWAIT*) is 0, *semop* increments the *semzcnt* associated with the specified semaphore and suspends execution of the calling thread until one of the following occurs:
 - The value of *semval* becomes 0, at which time the value of *semzcnt* associated with the specified semaphore is decremented.
 - The *semid* for which the calling thread is awaiting action is removed from the system. When this occurs, *errno* is set equal to *EIDRM* and -1 is returned.
 - The calling thread receives a signal that is to be intercepted. When this occurs, the value of *semzcnt* associated with the specified semaphore is decremented, and the calling thread resumes execution in the manner prescribed in *sigaction*.

On successful completion, the value of *sempid* for each semaphore specified in the array pointed to by *sops* is set equal to the process ID of the calling process.

Return Values

0	Successful completion.
-1	Indicates an error. The function sets <code>errno</code> to one of the following values: <ul style="list-style-type: none">• E2BIG – The value of <code>nsops</code> is greater than the system-imposed maximum.• EACCES – Operation permission is denied to the calling process.• EAGAIN – The operation would result in suspension of the calling process but (<code>sem_flg & IPC_NOWAIT</code>) is nonzero.• EFAULT – The arguments passed to the function are not accessible.• EFBIG – The value of <code>sem_num</code> is less than 0 or greater than or equal to the number of semaphores in the set associated with <code>semid</code>.• EIDRM – The semaphore identifier <code>semid</code> is removed from the system.• EINVAL – The value of <code>semid</code> is not a valid semaphore identifier, or the number of individual semaphores for which the calling process requests a SEM_UNDO would exceed the system-imposed limit.• EVMSERR – OpenVMS specific nontranslatable error code.

sem_post (*Integrity servers, Alpha*)

Unlocks a semaphore.

Format

```
#include <semaphore.h>
int sem_post (sem_t *sem);
```

Argument

sem
The semaphore to be unlocked.

Description

The `sem_post` function unlocks the specified semaphore by performing the semaphore unlock operation on that semaphore. The appropriate function (`sem_open` for named semaphores or `sem_init` for unnamed semaphores) must be called for a semaphore before you can call the locking and unlocking functions, `sem_wait`, `sem_trywait`, and `sem_post`.

If the semaphore value after a `sem_post` function is positive, no processes were blocked waiting for the semaphore to be unlocked; the semaphore value is incremented. If the semaphore value after a `sem_post` function is zero, one of the processes blocked waiting for the semaphore is allowed to return successfully from its call to `sem_wait`.

If more than one process is blocked while waiting for the semaphore, only one process is unblocked and the state of the semaphore remains unchanged when the `sem_post` function returns. The process to be unblocked is selected according to the scheduling policies and priorities of all blocked processes. If the scheduling policy is `SCHED_FIFO` or `SCHED_RR`, the highest-priority waiting process is unblocked. If more than one process of that priority is blocked, then the process that has waited the longest is unblocked.

The `sem_post` function can be called from a signal-catching function.

Return Values

- | | |
|----|---|
| 0 | Successful completion. The <code>sem_post</code> function performs a semaphore unlock operation, unblocking a process. |
| -1 | Indicates an error. The function sets <code>errno</code> to one of the following values: <ul style="list-style-type: none">• <code>EINVAL</code> – The <code>sem</code> argument is not a valid semaphore.• <code>EVMISERR</code> – OpenVMS specific nontranslatable error code. |

sem_timedwait (Integrity servers, Alpha)

Performs a semaphore lock.

Format

```
#include <semaphore.h>
#include <time.h>
int sem_timedwait (sem_t *sem, const struct timespec *abs_timeout);
```

Argument**sem**

The semaphore to be locked.

abs_timeout

The absolute time after which the timeout expires.

Description

The `sem_timedwait` function locks the semaphore referenced by `sem` as in the `sem_wait` function. But if the semaphore cannot be locked without waiting for another process or thread to unlock the semaphore by performing a `sem_post` function, this wait terminates when the specified timeout expires.

The timeout expires when the absolute time specified by `abs_timeout` passes, as measured by the clock on which timeouts are based (that is, when the value of that clock equals or exceeds `abs_timeout`, or if the absolute time specified by `abs_timeout` has already been passed at the time of the call.

The function will not fail with a timeout if the semaphore can be locked immediately. The validity of `abs_timeout` does not need to be checked if the semaphore can be locked immediately.

Return Values

0	Successful completion. The function executes the semaphore lock operation.
-1	Indicates an error. The function sets <code>errno</code> to one of the following values: <ul style="list-style-type: none">• <code>ETIMEDOUT</code> – The semaphore could not be locked before the specified timeout expired.• <code>EINVAL</code> – The <code>sem</code> argument does not refer to a valid semaphore. Or the process or thread would have blocked, and the <code>abs_timeout</code> parameter specified a nanoseconds field value less than zero or greater than or equal to 1000 million.• <code>EVMSEERR</code> – OpenVMS specific nontranslatable error code.

sem_trywait *(Integrity servers, Alpha)*

sem_trywait *(Integrity servers, Alpha)*

Conditionally performs a semaphore lock.

Format

```
#include <semaphore.h>
int sem_trywait (sem_t *sem);
```

Argument

sem
The semaphore to be locked.

Description

The `sem_trywait` function locks a semaphore only if the semaphore is currently not locked. If the semaphore value is zero, the `sem_trywait` function returns without locking the semaphore.

The `sem_wait` and `sem_trywait` functions help ensure that the resource associated with the semaphore cannot be accessed by other processes. The semaphore remains locked until the process unlocks it with a call to the `sem_post` function.

Use the `sem_wait` function instead of the `sem_trywait` function if the process should wait for access to the semaphore.

Return Values

0	Successful completion. The function executes the semaphore lock operation.
-1	Indicates an error. The function sets <code>errno</code> to one of the following values: <ul style="list-style-type: none">• <code>EAGAIN</code> – The semaphore was already locked and cannot be locked by the <code>sem_trywait</code> operation.• <code>EINVAL</code> – The <code>sem</code> argument does not refer to a valid semaphore.• <code>EVMSError</code> – OpenVMS specific nontranslatable error code.

sem_unlink (*Integrity servers, Alpha*)

Removes the specified named semaphore.

Format

```
#include <semaphore.h>
int sem_unlink (const char *name);
```

Argument

name
The name of the semaphore to remove.

Description

The `sem_unlink` function removes a semaphore named by the *name* string. If the semaphore is referenced by other processes, `sem_unlink` does not change the state of the semaphore.

If other processes have the semaphore open when `sem_unlink` is called, the semaphore is not destroyed until all references to the semaphore have been destroyed by calls to `sem_close`. The `sem_unlink` function returns immediately; it does not wait until all references have been destroyed.

Calls to `sem_open` to recreate or reconnect to the semaphore refer to a new semaphore after `sem_unlink` is called.

Return Values

- | | |
|----|--|
| 0 | Successful completion. The function executes the semaphore unlink operation. |
| -1 | Indicates an error. The function sets <code>errno</code> to one of the following values: <ul style="list-style-type: none">• <code>EACCESS</code> – Permission is denied to unlink the named semaphore.• <code>ENAMETOOLONG</code> – The length of the path name exceeds <code>PSEM_MAX_PATHNAME</code> defined in <code>semaphore.h</code>.• <code>ENOENT</code> – The named semaphore does not exist.• <code>EVMSEERR</code> – OpenVMS specific nontranslatable error code. |

sem_wait *(Integrity servers, Alpha)*

sem_wait *(Integrity servers, Alpha)*

Performs a semaphore lock.

Format

```
#include <semaphore.h>
int sem_wait (sem_t *sem);
```

Argument

sem
The semaphore to be locked.

Description

The `sem_wait` function locks the semaphore referenced by `sem` by performing a semaphore lock operation on it. If the semaphore value is zero, the `sem_wait` function blocks until it either locks the semaphore or is interrupted by a signal.

The `sem_wait` and `sem_trywait` functions help ensure that the resource associated with the semaphore cannot be accessed by other processes. The semaphore remains locked until the process unlocks it with a call to the `sem_post` function.

Use the `sem_wait` function instead of the `sem_trywait` function if the process should wait for access to the semaphore.

Return Values

- | | |
|----|--|
| 0 | Successful completion. The function executes the semaphore lock operation. |
| -1 | Indicates an error. The function sets <code>errno</code> to one of the following values: <ul style="list-style-type: none">• <code>EINTR</code> – A signal interrupted this function.• <code>EVMSEERR</code> – OpenVMS specific nontranslatable error code. |

[w]setattr

Activate the video display attribute *attr* within the window. The `setattr` function acts on the `stdscr` window.

Format

```
#include <curses.h>
int setattr (int attr);
int wsetattr (WINDOW *win, int attr);
```

Arguments

win

A pointer to the window.

attr

One of a set of video display attributes, which are blinking, boldface, reverse video, and underlining, and are represented by the defined constants `_BLINK`, `_BOLD`, `_REVERSE`, and `_UNDERLINE`, respectively. You can set multiple attributes by separating them with a bitwise OR operator (`|`) as follows:

```
setattr(_BLINK | _UNDERLINE);
```

Description

The `setattr` and `wsetattr` functions are specific to HP C for OpenVMS Systems and are not portable.

Return Values

OK	Indicates success.
ERR	Indicates an error.

setbuf

setbuf

Associates a new buffer with an input or output file and potentially modifies the buffering behavior.

Format

```
#include <stdio.h>

void setbuf (FILE *file_ptr, char *buffer);
```

Arguments

file_ptr

A file pointer.

buffer

A pointer to a character array or a NULL pointer.

Description

You can use the `setbuf` function after the specified file is opened but before any I/O operations are performed.

If *buffer* is a NULL pointer, then the call is equivalent to a call to `setvbuf` with the same *file_ptr*, a NULL *buffer* pointer, a buffering type of `_IONBF` (no buffering), and a buffer size of 0.

If *buffer* is not a NULL pointer, then the call is equivalent to a call to `setvbuf` with the same *file_ptr*, the same *buffer* pointer, a buffering type of `_IOFBF`, and a buffer size given by the value `BUFSIZ` (defined in `<stdio.h>`). Therefore, use `BUFSIZ` to allocate the *buffer* argument used in the call to `setbuf`. For example:

```
#include <stdio.h>
.
.
.
char my_buf[BUFSIZ];
.
.
.
setbuf(stdout, my_buf);
.
.
.
```

User programs must not depend on the contents of *buffer* once I/O has been performed on the stream. The HP C RTL might or might not use *buffer* for any given I/O operation.

The `setbuf` function originally allowed programmers to substitute larger buffers in place of the system default buffers in obsolete versions of UNIX. The large default buffer sizes in modern implementations of C make the use of this function unnecessary most of the time. The `setbuf` function is retained in the ANSI C standard for compatibility with old programs. New programs should use `setvbuf` instead, because it allows the programmer to bind the buffer size at run time instead of compile time, and it returns a result value that can be tested.

setenv

Inserts or resets the environment variable specified by *name* in the current environment list.

Format

```
#include <stdlib.h>

int setenv (const char *name, const char *value, int overwrite);
```

Arguments

name

A variable name in the environment variable list.

value

The value for the environment variable.

overwrite

A value of 0 or 1 indicating whether to reset the environment variable, if it exists.

Description

The `setenv` function inserts or resets the environment variable *name* in the current environment list. If the variable *name* does not exist in the list, it is inserted with the *value* argument. If the variable does exist, the *overwrite* argument is tested. When the *overwrite* argument value is:

- 0 then the variable is not reset.
- 1 then the variable is reset to *value*.

Note

Do not use the `setenv`, `getenv`, and `putenv` functions to manipulate symbols and logicals. Instead, use the OpenVMS library calls `lib$set_logical`, `lib$get_logical`, `lib$set_symbol`, and `lib$get_symbol`. The **env* functions deliberately provide UNIX behavior, and are not a substitute for these OpenVMS runtime library calls.

OpenVMS DCL symbols, not logical names, are the closest analog to environment variables on UNIX systems. While `getenv` is a mechanism to retrieve either a logical name or a symbol, it maintains an internal cache of values for use with `setenv` and subsequent `getenv` calls. The `setenv` function does not write or create DCL symbols or OpenVMS logical names.

This is consistent with UNIX behavior. On UNIX systems, `setenv` does not change or create any symbols that will be visible in the shell after the program exits.

setenv

Return Values

0	Indicates success.
-1	Indicates an error. <code>errno</code> is set to <code>ENOMEM</code> — Not enough memory available to expand the environment list.

seteuid (Integrity servers, Alpha)

Sets the process's effective user ID.

Format

```
#include <unistd.h>
int seteuid (uid_t eid);
```

Argument**eid**

The value to which you want the effective user ID set.

Description

If the process has the `IMPERSONATE` privilege, the `seteuid` function sets the process's effective user ID.

An unprivileged process can set the effective user ID only if the *eid* argument is equal to either the real, effective, or saved user ID of the process.

This function requires that long (32-bit) UID/GID support be enabled. See Section 1.4.8 for more information.

See also `getuid` to know how UIC is represented.

Return Values

0	Successful completion.
-1	Indicates an error. The function sets <code>errno</code> to one of the following values: <ul style="list-style-type: none">• <code>EINVAL</code> – The value of the <i>eid</i> argument is invalid and not supported.• <code>EPERM</code> – The process does not have the <code>IMPERSONATE</code> privilege, and <i>eid</i> does not match the real user ID or the saved set-user-ID.

setgid

setgid

With POSIX IDs disabled, `setgid` is implemented for program portability and serves no function. It returns 0 (to indicate success).

With POSIX IDs enabled, `setgid` sets the group IDs.

Format

```
#include <types.h>
#include <unistd.h>
int setgid (_gid_t gid); (_DECC_V4_SOURCE)
int setgid (gid_t gid); (not _DECC_V4_SOURCE)
```

Argument

gid

The value to which you want the group IDs set.

Description

The `setgid` function can be used with POSIX style identifiers enabled or disabled.

POSIX style IDs are supported on OpenVMS Version 7.3-2 and higher.

With POSIX IDs disabled, the `setgid` function is implemented for program portability and serves no function. It returns 0 (to indicate success).

With POSIX style IDs enabled:

- If the process has the IMPERSONATE privilege, the `setgid` function sets the real group ID, effective group ID, and the saved set-group-ID to *gid*.
- If the process does not have appropriate privileges but *gid* is equal to the real group ID or to the saved set-group-ID, then the `setgid` function sets the effective group ID to *gid*. The real group ID and saved set-group-ID remain unchanged.
- Any supplementary group IDs of the calling process remain unchanged.

To enable/disable POSIX style IDs, see Section 1.6.

Return Values

0	Successful completion.
-1	Indicates an error. The function sets <code>errno</code> to one of the following values: <ul style="list-style-type: none">• <code>EINVAL</code> – The value of the <i>gid</i> argument is invalid and not supported by the implementation.• <code>EPERM</code> – The process does not have appropriate privileges and <i>gid</i> does not match the real group ID or the saved set-group-ID.

setgrent (*Integrity servers, Alpha*)

Rewinds the group database.

Format

```
#include <grp.h>
void setgrent (void);
```

Description

The `setgrent` function effectively rewinds the group database to allow repeated searches.

This function is always successful. No value is returned, and `errno` is not set.

setitimer

setitimer

Sets the value of interval timers.

Format

```
#include <time.h>

int setitimer (int which, struct itimerval *value, struct itimerval *ovalue);
```

Arguments

which

The type of interval timer. The HP C RTL only supports ITIMER_REAL.

value

A pointer to an `itimerval` structure whose members specify a timer interval and the time left to the end of the interval.

ovalue

A pointer to an `itimerval` structure whose members specify a current timer interval and the time left to the end of the interval.

Description

The `setitimer` function sets the timer specified by *which* to the value specified by *value*, returning the previous value of the timer if *ovalue* is nonzero.

A timer value is defined by the `itimerval` structure:

```
struct itimerval {
    struct timeval it_interval;
    struct timeval it_value;
};
```

The value of the `itimerval` structure members are: as follows

itimerval Member Value	Meaning
<code>it_interval = 0</code>	Disables a timer after its next expiration (assumes <code>it_value</code> is nonzero).
<code>it_interval = nonzero</code>	Specifies a value used in reloading <code>it_value</code> when the timer expires.
<code>it_value = 0</code>	Disables a timer.
<code>it_value = nonzero</code>	Indicates the time to the next timer expiration.

Time values smaller than the resolution of the system clock are rounded up to this resolution.

The `getitimer` function provides one interval timer, defined in the `<time.h>` header file as `ITIMER_REAL`. This timer decrements in real time. When the timer expires, it delivers a `SIGALARM` signal.

Note

The interaction between `setitimer` and any of `alarm`, `sleep`, or `usleep` is unspecified.

Return Values

0	Indicates success.
-1	An error occurred; <code>errno</code> is set to indicate the error.

setjmp

setjmp

Provides a way to transfer control from a nested series of function invocations back to a predefined point without returning normally. It does not use a series of return statements. The `setjmp` function saves the context of the calling function in an environment buffer.

Format

```
#include <setjmp.h>

int setjmp (jmp_buf env);
```

Argument

env

The environment buffer, which must be an array of integers long enough to hold the register context of the calling function. The type `jmp_buf` is defined in the `<setjmp.h>` header file. The contents of the general-purpose registers, including the program counter (PC), are stored in the buffer.

Description

When `setjmp` is first called, it returns the value 0. If `longjmp` is then called, naming the same environment as the call to `setjmp`, control is returned to the `setjmp` call as if it had returned normally a second time. The return value of `setjmp` in this second return is the value supplied by you in the `longjmp` call. To preserve the true value of `setjmp`, the function calling `setjmp` must not be called again until the associated `longjmp` is called.

The `setjmp` function preserves the hardware general-purpose registers, and the `longjmp` function restores them. After a `longjmp`, all variables have their values as of the time of the `longjmp` except for local automatic variables not marked `volatile`. These variables have indeterminate values.

The `setjmp` and `longjmp` functions rely on the OpenVMS condition-handling facility to effect a nonlocal goto with a signal handler. The `longjmp` function is implemented by generating a HP C RTL specified signal that allows the OpenVMS condition-handling facility to unwind back to the desired destination.

The HP C RTL must be in control of signal handling for any HP C image. For HP C to be in control of signal handling, you must establish all exception handlers through a call to the `VAXC$ESTABLISH` function. See Section 4.2.5 and the `VAXC$ESTABLISH` function for more information.

Note

The C RTL provides nonstandard `decc$setjmp` and `decc$fast_longjmp` functions for Alpha and Integrity server systems. To use these nonstandard functions instead of the standard ones, a program must be compiled with `__FAST_SETJMP` or `__UNIX_SETJMP` macros defined.

Unlike the standard `longjmp` function, the `decc$fast_longjmp` function does not convert its second argument from 0 to 1. After a call to `decc$fast_longjmp`, a corresponding `setjmp` function returns with the

exact value of the second argument specified in the `decc$fast_longjmp` call.

Restrictions

You cannot invoke the `longjmp` function from an OpenVMS condition handler. However, you may invoke `longjmp` from a signal handler that has been established for any signal supported by the HP C RTL, subject to the following nesting restrictions:

- The `longjmp` function will not work if you invoke it from nested signal handlers. The result of the `longjmp` function, when invoked from a signal handler that has been entered as a result of an exception generated in another signal handler, is undefined.
- Do not invoke the `setjmp` function from a signal handler unless the associated `longjmp` is to be issued before the handling of that signal is completed.
- Do not invoke the `longjmp` function from within an exit handler (established with `atexit` or `SYS$DCLEXH`). Exit handlers are invoked after image tear-down, so the destination address of the `longjmp` no longer exists.
- Invoking `longjmp` from within a signal handler to return to the main thread of execution might leave your program in an inconsistent state. Possible side effects include the inability to perform I/O or to receive any more UNIX signals. Use `siglongjmp` instead.

Return Values

See the Description section.

setkey

setkey

Sets an encoding key for use by the encrypt function.

Format

```
#include <unistd.h>
#include <stdlib.h>
void setkey (const char *key);
```

Argument

key

A character array of length 64 containing 0s and 1s.

Description

The argument of setkey is a character array of length 64 containing only the characters with numerical value 0 and 1. If this string is divided into groups of 8, the low-order bit in each group is ignored, leading to a 56-bit key which is set into the machine.

No value is returned.

See also crypt and encrypt.

setlocale

Selects the appropriate portion of the program's locale as specified by the *category* and *locale* arguments. You can use this function to change or query one category or the program's entire current locale.

Format

```
#include <locale.h>

char *setlocale (int category, const char *locale);
```

Arguments

category

The name of the category. Specify LC_ALL to change or query the entire locale. Other valid category names are:

- LC_COLLATE
- LC_CTYPE
- LC_MESSAGES
- LC_MONETARY
- LC_NUMERIC
- LC_TIME

locale

Pointer to a string that specifies the locale.

Description

The setlocale function sets or queries the appropriate portion of the program's locale as specified by the *category* and *locale* arguments. Specifying LC_ALL for the category argument names the entire locale; specifying the other values name only a portion of the program's locale.

The *locale* argument points to a character string that identifies the locale to be used. This argument can be one of the following:

- Name of the public locale

Specifies the public locale in the following format:

```
language_country.codeset[@modifier]
```

The function searches for the public locale binary file in the location defined by the logical name SYS\$I18N_LOCALE. The file type defaults to .LOCALE. The period (.) and at-sign (@) characters in the name are replaced by an underscore (_).

For example, if the specified name is "zh_CN.dechanzi@radical", the function searches for the SYS\$I18N_LOCALE:ZH_CN_DECHANZI_RADICAL.LOCALE binary locale file.

- A file specification

setlocale

Specifies the binary locale file. It can be any valid file specification. If either the device or directory is omitted, the function first applies the current caller's device and directory as defaults for any missing component. If the file is not found, the function applies the device and directory defined by the SYS\$I18N_LOCALE logical name as defaults. The file type defaults to .LOCALE.

No wildcards are allowed. The binary locale file cannot reside on a remote node.

- "C"

Specifies the C locale. If a program does not call setlocale, the C locale is the default.

- "POSIX"

This is the same as the C locale.

- ""

Specifies that the locale is initialized from the setting of the international environment logical names. The function checks the following logical names in the order shown until it finds a logical that is defined:

1. LC_ALL
2. Logical names corresponding to the category. For example, if LC_NUMERIC is specified as the category, then the first logical name that setlocale checks is LC_NUMERIC.
3. LANG
4. SYS\$LC_ALL
5. The system default for the category, which is defined by the SYS\$LC_* logical names. For example, the default for the LC_NUMERIC category is defined by the SYS\$LC_NUMERIC logical name.
6. SYS\$LANG

If none of the logical names is defined, the C locale is used as the default. The SYS\$LC_* logical names are set up at the system startup time.

Like the *locale* argument, the equivalence name of the international environment logical name can be either the name of the public locale or the file specification. The setlocale function treats this equivalence name as if it were specified as the *locale* argument.

- NULL

Causes setlocale to query the current locale. The function returns a pointer to a string describing the portion of the program's locale associated with *category*. Specifying the LC_ALL category returns the string describing the entire locale. The locale is not changed.

- The string returned from the previous call to setlocale

Causes the function to restore the portion of the program's locale associated with *category*. If the string contains the description of the entire locale, the part of the string corresponding to *category* is used. If the string describes the portion of the program's locale for a single category, this locale is used. For example, this means that you can use the string returned from the call setlocale with the LC_COLLATE category to set the same locale for the LC_MESSAGES category.

If the specified locale is available, then `setlocale` returns a pointer to the string that describes the portion of the program's locale associated with *category*. For the `LC_ALL` category, the returned string describes the entire program's locale. If an error occurs, a `NULL` pointer is returned and the program's locale is not changed.

Subsequent calls to `setlocale` overwrite the returned string. If that part of the locale needs to be restored, the program should save the string. The calling program should make no assumptions about the format or length of the returned string.

Return Values

<code>x</code>	Pointer to a string describing the locale.
<code>NULL</code>	Indicates an error occurred; <code>errno</code> is set.

Example

```
#include <errno.h>
#include <stdio.h>
#include <locale.h>

/* This program calls setlocale() three times. The second call */
/* is for a nonexistent locale. The third call is for an      */
/* existing file that is not a locale file.                  */
main()
{
    char *ret_str;

    errno = 0;
    printf("setlocale (LC_ALL, \"POSIX\")");
    ret_str = (char *) setlocale(LC_ALL, "POSIX");

    if (ret_str == NULL)
        perror("setlocale error");
    else
        printf(" call was successful\n");

    errno = 0;
    printf("\n\nsetlocale (LC_ALL, \"junk.junk_codeset\")");
    ret_str = (char *) setlocale(LC_ALL, "junk.junk_codeset");

    if (ret_str == NULL)
        perror(" returned error");
    else
        printf(" call was successful\n");

    errno = 0;
    printf("\n\nsetlocale (LC_ALL, \"sys$login:login.com\")");
    ret_str = (char *) setlocale(LC_ALL, "sys$login:login.com");

    if (ret_str == NULL)
        perror(" returned error");
    else
        printf(" call was successful\n");
}
```

Running the example program produces the following result:

setlocale

```
setlocale (LC_ALL, "POSIX") call was successful
setlocale (LC_ALL, "junk.junk_codeset")
returned error: no such file or directory
setlocale (LC_ALL, "sys$login:login.com")
returned error: nontranslatable vms error code: 0x35C07C
%c-f-localebad, not a locale file
```

setpgid (*Integrity servers, Alpha*)

Sets the process group ID for job control.

Format

```
#include <unistd.h>
int setpgid (pid_t pid, pid_t pgid);
```

Arguments**pid**

The process ID for which the process group ID is to be set.

pgid

The value to which the process group ID is set.

Description

The `setpgid` function is used either to join an existing process group or create a new process group within the session of the calling process. The process group ID of a session leader will not change.

Upon successful completion, the process group ID of the process with a process ID of *pid* is set to *pgid*. As a special case, if *pid* is 0, the process ID of the calling process is used. Also, if *pgid* is 0, the process group ID of the indicated process is used.

This function requires that long (32-bit) UID/GID support be enabled. See Section 1.4.8 for more information.

Return Values

0

Successful completion.

-1

Indicates an error. The function sets `errno` to one of the following values:

- `EACCES` – The value of the *pid* argument matches the process ID of a child process of the calling process and the child process has successfully executed one of the `exec` functions.
- `EINVAL` – The value of the *pgid* argument is less than 0, or is not a value supported by the implementation.
- `EPERM` – The process indicated by the *pid* argument is a session leader. The value of the *pid* argument matches the process ID of a child process of the calling process, and the child process is not in the same session as the calling process. The value of the *pgid* argument is valid but does not match the process ID of the process indicated by the *pid* argument, and there is no process with a process group ID that matches the value of the *pgid* argument in the same session as the calling process.
- `ESRCH` – The value of the *pid* argument does not match the process ID of the calling process or of a child process of the calling process.

setpwent

setpwent

Rewinds the user database.

Format

```
#include <pwd.h>
void setpwent (void);
```

Description

The `setpwent` function effectively rewinds the user database to allow repeated searches.

No value is returned, but `errno` is set to `EIO` if an I/O error occurred.

See also `getpwent`.

setregid (Integrity servers, Alpha)

Sets the real and effective group IDs.

Format

```
#include <unistd.h>
int setregid (gid_t rgid, gid_t egid);
```

Arguments

rgid

The value to which you want the real group ID set.

egid

The value to which you want the effective group ID set.

Description

The `setregid` function is used to set the real and effective group IDs of the calling process. If `rgid` is `-1`, the real group ID is not changed; if `egid` is `-1`, the effective group ID is not changed. The real and effective group IDs can be set to different values in the same call.

Only a process with the `IMPERSONATE` privilege can set the real group ID and the effective group ID to any valid value.

A nonprivileged process can set either the real group ID to the saved set-group-ID from an `exec` function, or the effective group ID to the saved set-group-ID or the real group ID.

Any supplementary group IDs of the calling process remain unchanged.

If a set-group-ID process sets its effective group ID to its real group ID, it can still set its effective group ID back to the saved set-group-ID.

This function requires that long (32-bit) UID/GID support be enabled. See Section 1.4.8 for more information.

Return Values

0	Successful completion.
-1	Indicates an error. Neither of the group IDs is changed, and <code>errno</code> is set to one of the following values: <ul style="list-style-type: none">• <code>EINVAL</code> – The value of the <code>rgid</code> or <code>egid</code> argument is invalid or out-of-range.• <code>EPERM</code> – The process does not have the <code>IMPERSONATE</code> privilege, and a change other than changing the real group ID to the saved set-group-ID, or changing the effective group ID to the real group ID or the saved group ID, was requested.

setreuid (*Integrity servers, Alpha*)

Sets the user IDs.

Format

```
#include <unistd.h>
int setreuid (uid_t ruid, uid_t euid);
```

Arguments

ruid

The value to which you want the real user ID set.

euid

The value to which you want the effective user ID set.

Description

The `setreuid` function sets the real and effective user IDs of the current process to the values specified by the `ruid` and `euid` arguments. If `ruid` or `euid` is `-1`, the corresponding effective or real user ID of the current process is left unchanged.

A process with the `IMPERSONATE` privilege can set either ID to any value. An unprivileged process can set the effective user ID only if the `euid` argument is equal to either the real, effective, or saved user ID of the process.

It is unspecified whether a process without the `IMPERSONATE` privilege is permitted to change the real user ID to match the current real, effective, or saved user ID of the process.

This function requires that long (32-bit) UID/GID support be enabled. See Section 1.4.8 for more information.

See also `getuid` to know how UIC is represented.

Return Values

- | | |
|----|--|
| 0 | Successful completion. |
| -1 | Indicates an error. The function sets <code>errno</code> to one of the following values: <ul style="list-style-type: none">• <code>EINVAL</code> – The value of the <code>ruid</code> or <code>euid</code> argument is invalid or out of range.• <code>EPERM</code> – The current process does not have the <code>IMPERSONATE</code> privilege, and either an attempt was made to change the effective user ID to a value other than the real user ID or the saved set-user-ID, or an attempt was made to change the real user ID to a value not permitted by the implementation. |

setsid (*Integrity servers, Alpha*)

Creates a session and sets the process group ID.

Format

```
#include <unistd.h>
pid_t setsid (void);
```

Description

The `setsid` function creates a new session if the calling process is not a process group leader. Upon return, the calling process is the session leader of this new session and the process group leader of a new process group, and it has no controlling terminal. The process group ID of the calling process is set equal to the process ID of the calling process. The calling process is the only process in the new process group and the only process in the new session.

This function requires that long (32-bit) UID/GID support be enabled. See Section 1.4.8 for more information.

Return Values

<code>x</code>	The process group ID of the calling process.
<code>(pid_t)-1</code>	Indicates an error. The function sets <code>errno</code> to the following value: <ul style="list-style-type: none">• <code>EPERM</code> – The calling process is already a process group leader, or the process group ID of a process other than the calling process matches the process ID of the calling process.

setstate

setstate

Restarts and changes random-number generators.

Format

```
char *setstate (char *state;)
```

Argument

state

Points to the array of state information.

Description

The `setstate` function handles restarting and changing random-number generators.

Once you initialize a state, the `setstate` function allows rapid switching between state arrays. The array defined by *state* is used for further random-number generation until the `initstate` function is called or the `setstate` function is called again. The `setstate` function returns a pointer to the previous state array.

After initialization, you can restart a state array at a different point in one of two ways:

- Use the `initstate` function, with the desired *seed*, state array, and size of the array.
- Use the `setstate` function, with the desired state, followed by the `srandom` function with the desired seed. The advantage of using both functions is that you do not have to save the state array size once you initialize it.

See also `initstate`, `srandom`, and `random`.

Return Values

- | | |
|---|---|
| x | A pointer to the previous state array information. |
| 0 | Indicates an error. The state information is damaged, and <code>errno</code> is set to the following value: <ul style="list-style-type: none">• <code>EINVAL</code>—The <i>state</i> argument is invalid. |

setuid

With POSIX IDs disabled, implemented for program portability and serves no function. It returns 0 (to indicate success).

With POSIX IDs enabled, sets the user IDs.

Format

```
#include <types.h>
#include <unistd.h>
int setuid (_uid_t uid); (_DECC_V4_SOURCE)
uid_t setuid (uid_t uid); (not _DECC_V4_SOURCE)
```

Argument

uid

The value to which you want the user IDs set.

Description

The setuid function can be used with POSIX style identifiers enabled or disabled. POSIX style IDs are supported on OpenVMS Version 7.3-2 and higher.

With POSIX IDs disabled (the default), the setuid function is implemented for program portability and serves no function. It returns 0 (to indicate success).

With POSIX style IDs enabled:

- If the process has the IMPERSONATE privilege, the setuid function sets the real user ID, effective user ID, and the saved set-user-ID to *uid*.
- If the process does not have appropriate privileges but *uid* is equal to the real user ID or to the saved set-user-ID, then the setuid function sets the effective user ID to *uid*. The real user ID and saved set-user-ID remain unchanged.

See also getuid to know how UIC is represented.

To enable/disable POSIX style IDs, see Section 1.6.

Return Values

0	Successful completion.
-1	Indicates an error. The function sets errno to one of the following values: <ul style="list-style-type: none">• EINVAL – The value of the <i>uid</i> argument is invalid and not supported by the implementation.• EPERM – The process does not have appropriate privileges and <i>uid</i> does not match the real user ID or the saved set-user-ID.

setvbuf

setvbuf

Associates a buffer with an input or output file and potentially modifies the buffering behavior.

Format

```
#include <stdio.h>

int setvbuf (FILE *file_ptr, char *buffer, int type, size_t size);
```

Arguments

file_ptr

A pointer to a file.

buffer

A pointer to a character array, or a NULL pointer.

type

The buffering type. Use one of the following values defined in <stdio.h>: `_IOFBF` or `_IOLBF`.

size

The number of bytes to be used in *buffer* by the HP C RTL for buffering this file. The buffer size must be a minimum of 8192 bytes and a maximum of 32767 bytes.

Description

You can use the `setvbuf` function after the file is opened but before any I/O operations are performed.

The C RTL provides the following types of ANSI-conforming file buffering:

In line-buffered I/O, characters are buffered in an area of memory until a new-line character is seen, at which point the appropriate RMS routine is called to transmit the entire buffer. Line buffering is more efficient than unbuffered I/O since it reduces the system overhead, but it delays the availability of the data to the user or disk on output.

In fully buffered I/O, characters are buffered in an area of memory until the buffer is full, regardless of the presence of break characters. Full buffering is more efficient than line buffering or unbuffered I/O, but it delays the availability of output data even longer than line buffering.

Use the values `_IOLBF` and `_IOFBF` defined in <stdio.h> for the *type* argument to specify line-buffered and fully buffered I/O, respectively.

If *file_ptr* specifies a terminal device, the HP C RTL uses line-buffered I/O; otherwise, it uses fully buffered I/O.

Please note that the previously documented value `_IONBF` is not supported.

The HP C RTL automatically allocates a buffer to use for each I/O stream, so there are several buffer allocation possibilities:

- If *buffer* is not a NULL pointer and *size* is not smaller than the automatically allocated buffer, then `setvbuf` uses *buffer* as the file buffer.

- If *buffer* is a NULL pointer or *size* is smaller than the automatically allocated buffer, the automatically allocated buffer is used as the buffer area.
- If *buffer* is a NULL pointer and *size* is larger than the automatically allocated buffer, then `setvbuf` allocates a new buffer equal to the specified size and uses that as the file buffer.

User programs must not depend on the contents of *buffer* once I/O has been performed on the stream. The HP C RTL might or might not use *buffer* for any given I/O operation.

Generally, it is unnecessary to use `setvbuf` or `setbuf` to control the buffer size used by the HP C RTL. The automatically allocated buffer sizes are chosen for efficiency based on the kind of I/O operations performed and the device characteristics (such as terminal, disk, or socket).

The `setvbuf` and `setbuf` functions are useful to introduce buffering for improved performance when writing a large amount of text to the `stdout` stream. This stream is unbuffered by default when bound to a terminal device (the normal case), and therefore incurs a large number of OpenVMS buffered I/O operations unless HP C RTL buffering is introduced by a call to `setvbuf` or `setbuf`.

The `setvbuf` function is used only to control the buffering used by the HP C RTL, not the buffering used by the underlying RMS I/O operations. You can modify RMS default buffering behavior by specifying various values for the `ctx`, `fop`, `rat`, `gbc`, `mbc`, `mbf`, `rfm`, and `rop` RMS keywords when the file is opened by the `creat`, `freopen` or `open` functions.

Return Values

0	Indicates success.
nonzero value	Indicates that an invalid input value was specified for <i>type</i> or <i>file_ptr</i> , or because <i>file_ptr</i> is being used by another thread (see Section 1.8.1).

shm_open (*Integrity servers, Alpha*)

Opens a shared memory object.

Format

```
#include <sys/mman.h>
int shm_open (const char *name, int oflag, mode_t mode);
```

Argument

name

Pointer to a string naming a shared memory object.

oflag

Specifies options that define file status and file access modes. This argument is constructed from the bitwise inclusive OR of zero or more of the options defined in the `<fcntl.h>` header file.

mode

The shared memory object's permission bits. This argument is used only when the shared memory object is being created.

Description

The `shm_open` function establishes a connection between a shared memory object and a file descriptor. It creates an open file description that refers to the shared memory object and a file descriptor that refers to that open file description. The file descriptor is used by other functions to refer to that shared memory object. The `name` argument points to a string naming a shared memory object. The name can be a pathname, in which case other processes referring to the same pathname refer to the same shared memory object.

When a shared memory object is created, its state and all data associated with it persist until the shared memory is unlinked.

The `shm_open` function returns a file descriptor for the shared memory object that is the lowest numbered file descriptor not currently open for that process.

The file status flags and file access modes of the open file description are set according to the value of `oflag`, and can have zero or more of the following values:

`O_RDONLY` – Open for read access only.

`O_RDWR` – Open for read or write access.

`O_CREAT` – Create the shared memory if the memory object does not exist already. The user ID and group ID of the shared memory object are identical to those of the calling process. The shared memory object's permission bits are set to the value of `mode`, except those set in the file mode creation mask of the process.

`O_EXCL` – Prevent the opening of a shared memory object if `O_CREAT` is set and the shared memory object already exists. Use this option only in combination with `O_CREAT`.

O_TRUNC – Truncate the shared memory object to zero length if it is successfully opened for read or write access (O_RDWR).

The initial contents of the shared memory object are binary zeros.

Return Values

n	Upon success, a nonnegative integer representing the lowest numbered unused file descriptor. The file descriptor points to the shared memory object.
-1	Indicates failure. <code>errno</code> is set to indicate the error: <ul style="list-style-type: none">• EACCES – Permission to create the shared memory object is denied, or the shared memory object exists and the permissions specified by <i>oflag</i> are denied, or O_TRUNC is specified and write permission is denied.• EEXIST – O_CREAT and O_EXCL are set, but the named shared memory object already exists.• EINTR – A signal has interrupted the <code>shm_open</code> operation.• EINVAL – The <code>shm_open</code> operation is not supported for the given <i>name</i>.• EMFILE – Too many file descriptors are currently in use by this process.• ENAMETOOLONG – The length of the <i>name</i> argument exceeds PATH_MAX or a pathname component is longer than NAME_MAX.• ENFILE – Too many shared memory objects are currently open in the system.• ENOENT – O_CREAT is not set and the named shared memory object does not exist.• ENOSPC – Memory space for creation of the new shared memory object is insufficient.

shm_unlink (*Integrity servers, Alpha*)

Removes a shared memory object.

Format

```
#include <sys/mman.h>
int shm_unlink (const char *name);
```

Argument

name
Pointer to a string naming the shared memory object to remove.

Description

The `shm_unlink` function removes the name of the shared memory object named by the string pointed to by *name*.

If one or more references to the shared memory object exist when the object is unlinked, the name is removed before `shm_unlink` returns, but the removal of the memory object contents is postponed until all open and map references to the shared memory object have been removed.

Even if the object continues to exist after the last `shm_unlink`, reuse of the name subsequently causes `shm_unlink` to behave as if no shared memory object with this name exists (that is, `shm_open` will fail if `O_CREAT` is not set, or will create a new shared memory object if `O_CREAT` is set).

Return Values

- | | |
|----|--|
| 0 | Indicates success. |
| -1 | Indicates failure, the named shared memory object is not changed by the function call, and <code>errno</code> is set to indicate the error: <ul style="list-style-type: none">• <code>EACCES</code> – Permission is denied to unlink the named shared memory object.• <code>ENAMETOOLONG</code> – The length of the <i>name</i> argument exceeds <code>PATH_MAX</code> or a pathname component is longer than <code>NAME_MAX</code>.• <code>ENOENT</code> – The named shared memory object does not exist. |

sigaction

Specifies the action to take upon delivery of a signal.

Format

```
#include <signal.h>

int sigaction (int sig, const struct sigaction *action, struct sigaction *o_action);
```

Arguments

sig

The signal for which the action is to be taken.

action

A pointer to a `sigaction` structure that describes the action to take when you receive the signal specified by the `sig` argument.

o_action

A pointer to a `sigaction` structure. When the `sigaction` function returns from a call, the action previously attached to the specified signal is stored in this structure.

Description

When a process requests the `sigaction` function, the process can both examine and specify what action to perform when the specified signal is delivered. The arguments determine the behavior of the `sigaction` function as follows:

- Specifying the `sig` argument identifies the affected signal. Use any one of the signal values defined in the `<signal.h>` header file, except `SIGKILL`.
If `sig` is `SIGCHLD` and the `SA_NOCLDSTOP` flag is not set in `sa_flags`, then a `SIGCHLD` signal is generated for the calling process whenever any of its child processes stop. If `sig` is `SIGCHLD` and the `SA_NOCLDSTOP` flag is set in `sa_flags`, then `SIGCHLD` signal is not generated in this way.
- Specifying the `action` argument, if not null, points to a `sigaction` structure that defines what action to perform when the signal is received. If the `action` argument is null, signal handling remains unchanged, so you can use the call to inquire about the current handling of the signal.
- Specifying the `o_action` argument, if not null, points to a `sigaction` structure that contains the action previously attached to the specified signal.

The `sigaction` structure consists of the following members:

```
void          (*sa_handler)(int);
sigset_t      sa_mask;
int           sa_flags;
```

The `sigaction` structure members are defined as follows:

sigaction

<code>sa_handler</code>	This member can contain the following values: <ul style="list-style-type: none">• <code>SIG_DFL</code> – Specifies the default action taken when the signal is delivered.• <code>SIG_IGN</code> – Specifies that the signal has no effect on the receiving process.• Function pointer – Requests to catch the signal. The signal causes the function call.
<code>sa_mask</code>	This member can request that individual signals, in addition to those in the process signal mask, are blocked from delivery while the signal handler function specified by the <code>sa_handler</code> member is executing.
<code>sa_flags</code>	This member can set the flags to enable further control over the actions taken when a signal is delivered.

The `sa_flags` member of the `sigaction` structure has the following values:

<code>SA_ONSTACK</code>	Setting this bit causes the system to run the signal catching function on the signal stack specified by the <code>sigstack</code> function. If this bit is not set, the function runs on the stack of the process where the signal is delivered.
<code>SA_RESETHAND</code>	Setting this bit resets the signal to <code>SIG_DFL</code> . Be aware that you cannot automatically reset <code>SIGILL</code> and <code>SIGTRAP</code> .
<code>SA_NODEFER</code>	Setting this bit does not automatically block the signal as it is intercepted.
<code>SA_NOCLDSTOP</code>	If this bit is set and the <code>sig</code> argument is equal to <code>SIGCHLD</code> and a child process of the calling process stops, then a <code>SIGCHLD</code> signal is sent to the calling process only if <code>SA_NOCLDSTOP</code> is not set for <code>SIGCHLD</code> .

When a signal is intercepted by a signal-catching function installed by `sigaction`, a new signal mask is calculated and installed for the duration of the signal-catching function (or until a call to either `sigprocmask` or `sigsuspend` is made. This mask is formed by taking the union of the current signal mask and the value of the `sa_mask` for the signal being delivered unless `SA_NODEFER` or `SA_RESETHAND` is set, and then including the signal being delivered. If and when the user's signal handler returns normally, the original signal mask is restored.

Once an action is installed for a specific signal, it remains installed until another action is explicitly requested (by another call to `sigaction`), until the `SA_RESETHAND` flag causes resetting of the handler, or until one of the `exec` functions is called.

If the previous action for a specified signal had been established by `signal`, the values of the fields returned in the structure pointed to by the `o_action` argument of `sigaction` are unspecified, and in particular `o_action->sa_handler` is not necessarily the same value passed to `signal`. However, if a pointer to the same structure or a copy thereof is passed to a subsequent call to `sigaction` by means of the `action` argument of `sigaction`, the signal is handled as if the original call to `signal` were repeated.

If `sigaction` fails, no new signal handler is installed.

It is unspecified whether an attempt to set the action for a signal that cannot be intercepted or ignored to SIG_DFL is ignored or causes an error to be returned with `errno` set to `EINVAL`.

See Section 4.2 for more information on signal handling.

Note

The `sigvec` and `signal` functions are provided for compatibility to old UNIX systems; their function is a subset of that available with the `sigaction` function.

See also `sigvec`, `signal`, `wait`, `read`, and `write`.

Return Values

0	Indicates success.
-1	Indicates an error; A new signal handler is not installed. <code>errno</code> is set to one of the following values: <ul style="list-style-type: none">• <code>EFAULT</code> – The <i>action</i> or <i>o_action</i> argument points to a location outside of the allocated address space of the process.• <code>EINVAL</code> – The <i>sig</i> argument is not a valid signal number. Or an attempt was made to ignore or supply a handler for the <code>SIGKILL</code>, <code>SIGSTOP</code>, and <code>SIGCONT</code> signals.

sigaddset

sigaddset

Adds the specified individual signal.

Format

```
#include <signal.h>
int sigaddset (sigset_t *set, int sig_number);
```

Arguments

set
The signal set.

sig_number
The individual signal.

Description

The `sigaddset` function manipulates sets of signals. This function operates on data objects that you can address by the application, not on any set of signals known to the system. For example, this function does not operate on the set blocked from delivery to a process or the set pending for a process.

The `sigaddset` function adds the individual signal specified by `sig_number` from the signal set specified by `set`.

Example

The following example shows how to generate and use a signal mask that blocks only the SIGINT signal from delivery:

```
#include <signal.h>
int return_value;
sigset_t newset;
. . .
sigemptyset(&newset);
sigaddset(&newset, SIGINT);
return_value = sigprocmask (SIG_SETMASK, &newset, NULL);
```

Return Values

- | | |
|----|--|
| 0 | Indicates success. |
| -1 | Indicates an error; <code>errno</code> is set to the following value: <ul style="list-style-type: none">• <code>EINVAL</code> – The value of <code>sig_number</code> is not a valid signal number. |

sigdelset

sigdelset

Deletes a specified individual signal.

Format

```
#include <signal.h>
int sigdelset (sigset_t *set, int sig_number,)
```

Arguments

set
The signal set.

sig_number
The individual signal.

Description

The `sigdelset` function deletes the individual signal specified by *sig_number* from the signal set specified by *set*.

This function operates on data objects that you can address by the application, not on any set of signals known to the system. For example, this function does not operate on the set blocked from delivery to a process or the set pending for a process.

Return Values

- | | |
|----|--|
| 0 | Indicates success. |
| -1 | Indicates an error; <code>errno</code> is set to the following value: <ul style="list-style-type: none">• <code>EINVAL</code> – The value of <i>sig_number</i> is not a valid signal number. |

sigemptyset

Initializes the signal set to exclude all signals.

Format

```
#include <signal.h>
int sigemptyset (sigset_t *set);
```

Argument

set
The signal set.

Description

The `sigemptyset` function initializes the signal set pointed to by *set* such that you exclude all signals. A call to `sigemptyset` or `sigfillset` must be made at least once for each object of type `sigset_t` prior to any other use of that object.

This function operates on data objects that you can address by the application, not on any set of signals known to the system. For example, this function does not operate on the set blocked from delivery to a process or the set pending for a process.

See also `sigfillset`.

Example

The following example shows how to generate and use a signal mask that blocks only the SIGINT signal from delivery:

```
#include <signal.h>
int return_value;
sigset_t newset;
. . .
sigemptyset(&newset);
sigaddset(&newset, SIGINT);
return_value = sigprocmask (SIG_SETMASK, &newset, NULL);
```

Return Values

0	Indicates success.
-1	Indicates an error; the global <code>errno</code> is set to indicate the error.

sigfillset

sigfillset

Initializes the signal set to include all signals.

Format

```
#include <signal.h>
int sigfillset (sigset_t *set);
```

Argument

set
The signal set.

Description

The `sigfillset` function initializes the signal set pointed to by *set* such that you include all signals. A call to `sigemptyset` or `sigfillset` must be made at least once for each object of type `sigset_t` prior to any other use of that object.

This function operates on data objects that you can address by the application, not on any set of signals known to the system. For example, this function does not operate on the set blocked from delivery to a process or the set pending for a process.

See also `sigemptyset`.

Return Values

- | | |
|----|---|
| 0 | Indicates success. |
| -1 | Indicates an error; <code>errno</code> is set to the following value: <ul style="list-style-type: none">• <code>EINVAL</code> – The value of the <i>sig_number</i> argument is not a valid signal number. |

sighold (*Integrity servers, Alpha*)

Adds the specified signal to the calling process's signal mask.

Format

```
#include <signal.h>
int sighold (int signal);
```

Argument**signal**

The specified signal. The *signal* argument can be assigned any of the signals defined in the <signal.h> header file, except SIGKILL and SIGSTOP.

Description

The sighold, sigrelse, and sigignore functions provide simplified signal management:

- The sighold function adds *signal* to the calling process's signal mask.
- The sigrelse function removes *signal* from the calling process's signal mask.
- The sigignore function sets the disposition of *signal* to SIG_IGN.

The sighold function, in conjunction with sigrelse and sigpause, can be used to establish critical regions of code that require the delivery of a signal to be temporarily deferred.

Upon success, the sighold function returns a value of 0. Otherwise, a value of -1 is returned, and errno is set to indicate the error.

Note

These interfaces are provided for compatibility only. New programs should use sigaction and sigprocmask to control the disposition of signals.

Return Values

0	Indicates success.
-1	Indicates an error; errno is set to the following value: <ul style="list-style-type: none">• EINVAL – The value of the <i>signal</i> argument is either an invalid signal number or SIGKILL.

sigignore (*Integrity servers, Alpha*)

Sets the disposition of the specified signal to SIG_IGN.

Format

```
#include <signal.h>
int sigignore (int signal);
```

Argument

signal

The specified signal. The *signal* argument can be assigned any of the signals defined in the <signal.h> header file, except SIGKILL and SIGSTOP.

Description

The sighold, sigrelse, and sigignore functions provide simplified signal management:

- The sighold function adds *signal* to the calling process's signal mask.
- The sigrelse function removes *signal* from the calling process's signal mask.
- The sigignore function sets the disposition of *signal* to SIG_IGN.

The sighold function, in conjunction with sigrelse and sigpause, can be used to establish critical regions of code that require the delivery of a signal to be temporarily deferred.

Upon success, the sigignore function returns a value of 0. Otherwise, a value of -1 is returned, and errno is set to indicate the error.

Note

These interfaces are provided for compatibility only. New programs should use sigaction and sigprocmask to control the disposition of signals.

Return Values

- | | |
|----|---|
| 0 | Indicates success. |
| -1 | Indicates an error; errno is set to the following value: <ul style="list-style-type: none">• EINVAL – The value of the <i>signal</i> argument is either an invalid signal number or SIGKILL, or an attempt is made to catch a signal that cannot be intercepted or to ignore a signal that cannot be ignored. |

sigismember

Tests whether a specified signal is a member of the signal set.

Format

```
#include <signal.h>
int sigismember (const sigset_t *set, int sig_number);
```

Arguments

set

The signal set.

sig_number

The individual signal.

Description

The `sigismember` function tests whether *sig_number* is a member of the signal set pointed to by *set*.

This function operates on data objects that you can address by the application, not on any set of signals known to the system. For example, this function does not operate on the set blocked from delivery to a process or the set pending for a process.

Return Values

1	Indicates success. The specified signal is a member of the specified set.
0	Indicates an error. The specified signal is not a member of the specified set.

siglongjmp

siglongjmp

Nonlocal goto with signal handling.

Format

```
#include <setjmp.h>
void siglongjmp (sigjmp_buf env, int value);
```

Arguments

env

An address for a `sigjmp_buf` structure.

value

A nonzero value.

Description

The `siglongjmp` function restores the environment saved by the most recent call to `sigsetjmp` in the same process with the corresponding `sigjmp_buf` argument.

All accessible objects have values when `siglongjmp` is called, with one exception: values of objects of automatic storage duration that changed between the `sigsetjmp` call and `siglongjmp` call are indeterminate.

Because it bypasses the usual function call and return mechanisms, `siglongjmp` executes correctly during interrupts, signals, and any of their associated functions. However, if you invoke `siglongjmp` from a nested signal handler (for example, from a function invoked as a result of a signal raised during the handling of another signal), the behavior is undefined.

The `siglongjmp` function restores the saved signal mask only if you initialize the `env` argument by a call to `sigsetjmp` with a nonzero *savemask* argument.

After `siglongjmp` is completed, program execution continues as if the corresponding call of `sigsetjmp` just returned the value specified by *value*.

The `siglongjmp` function cannot cause `sigsetjmp` to return 0 (zero); if *value* is 0, `sigsetjmp` returns 1

See also `sigsetjmp`.

signal

signal

Allows you to specify the way in which the signal *sig* is to be handled: use the default handling for the signal, ignore the signal, or call the signal handler at the address specified.

Format

```
#include <signal.h>

void (*signal (int sig, void (*func) (int))) (int);
```

Arguments

sig

The number or mnemonic associated with a signal. This argument is usually one of the mnemonics defined in the `<signal.h>` header file.

func

Either the action to take when the signal is raised, or the address of a function needed to handle the signal.

Description

If *func* is the constant `SIG_DFL`, the action for the given signal is reset to the default action, which is to terminate the receiving process. If the argument is `SIG_IGN`, the signal is ignored. Not all signals can be ignored.

If *func* is neither `SIG_DFL` nor `SIG_IGN`, it specifies the address of a signal-handling function. When the signal is raised, the addressed function is called with *sig* as its argument. When the addressed function returns, the interrupted process continues at the point of interruption. (This is called catching a signal. Signals are reset to `SIG_DFL` after they are intercepted, except as shown in Chapter 4.)

You must call the signal function each time you want to catch a signal.

See Section 4.2 for more information on signal handling.

To cause an OpenVMS exception or a signal to generate a UNIX style signal, OpenVMS condition handlers must return `SS$_RESIGNAL` upon receiving any exception that they do not want to handle. Returning `SS$_CONTINUE` prevents the correct generation of a UNIX style signal. See Chapter 4 for a list of OpenVMS exceptions that correspond to UNIX signals.

Return Values

x	The address of the function previously established to handle the signal.
<code>SIG_ERR</code>	Indicates that the <i>sig</i> argument is out of range.

sigpause

Assigns *mask* to the current set of masked signals and then waits for a signal.

Format

```
#include <signal.h>  
int sigpause (int mask);
```

Argument

mask
The signals to be blocked.

Description

See the sigblock function for information about the *mask* argument.

When control returns to sigpause, the function restores the previous set of masked signals, sets `errno` to `EINTR`, and returns `-1` to indicate an interrupt. The value `EINTR` is defined in the `<errno.h>` header file.

Return Value

`-1` Indicates an interrupt. `errno` is set to `EINTR`.

sigpending

sigpending

Examines pending signals.

Format

```
#include <signal.h>
int sigpending (sigset_t *set);
```

Argument

set
A pointer to a `sigset_t` structure.

Description

The `sigpending` function stores the set of signals that are blocked from delivery and pending to the calling process in the location pointed to by the *set* argument.

Call either the `sigemptyset` or the `sigfillset` function at least once for each object of type `sigset_t` prior to any other use of that object. If you do not initialize an object in this way and supply an argument to the `sigpending` function, the result is undefined.

See also `sigemptyset` and `sigfillset` in this section.

Return Values

0	Indicates success.
-1	Indicates an error; <code>errno</code> is set to the following value: <ul style="list-style-type: none">• <code>SIGSEGV</code> – Bad mask argument.

sigprocmask

Sets the current signal mask.

Format

```
#include <signal.h>

int sigprocmask (int how, const sigset_t *set, sigset_t *o_set);
```

Arguments

how

An integer value that indicates how to change the set of masked signals. Use one of the following values:

SIG_BLOCK	The resulting set is the union of the current set and the signal set pointed to by the <i>set</i> argument.
SIG_UNBLOCK	The resulting set is the intersection of the current set and the complement of the signal set pointed to by the <i>set</i> argument.
SIG_SETMASK	The resulting set is the signal set pointed to by the <i>set</i> argument.

set

The signal set. If the value of the *set* argument is:

- Not NULL – It points to a set of signals used to change the currently blocked set.
- NULL – The value of the *how* argument is not significant, and the process signal mask is unchanged, so you can use the call to inquire about currently blocked signals.

o_set

A non-NULL pointer to the location where the signal mask in effect at the time of the call is stored.

Description

The `sigprocmask` function is used to examine or change the signal mask of the calling process.

Typically, use the `sigprocmask` `SIG_BLOCK` value to block signals during a critical section of code, then use the `sigprocmask` `SIG_SETMASK` value to restore the mask to the previous value returned by the `sigprocmask` `SIG_BLOCK` value.

If there are any unblocked signals pending after the call to the `sigprocmask` function, at least one of those signals is delivered before the `sigprocmask` function returns.

You cannot block `SIGKILL` or `SIGSTOP` signals with the `sigprocmask` function. If a program attempts to block one of these signals, the `sigprocmask` function gives no indication of the error.

sigprocmask

Example

The following example shows how to set the signal mask to block only the SIGINT signal from delivery:

```
#include <signal.h>
int return_value;
sigset_t newset;
. . .
sigemptyset(&newset);
sigaddset(&newset, SIGINT);
return_value = sigprocmask (SIG_SETMASK, &newset, NULL);
```

Return Values

0	Indicates success.
-1	Indicates an error. The signal mask of the process is unchanged. <code>errno</code> is set to one of the following values: <ul style="list-style-type: none">• <code>EINVAL</code> – The value of the <i>how</i> argument is not equal to one of the defined values.• <code>EFAULT</code> – The <i>set</i> or <i>o_set</i> argument points to a location outside the allocated address space of the process.

sigrelse (Integrity servers, Alpha)

Removes the specified signal from the calling process's signal mask.

Format

```
#include <signal.h>
int sigrelse (int signal);
```

Argument**signal**

The specified signal. The *signal* argument can be assigned any of the signals defined in the <signal.h> header file, except SIGKILL and SIGSTOP.

Description

The sighold, sigrelse, and sigignore functions provide simplified signal management:

- The sighold function adds *signal* to the calling process's signal mask.
- The sigrelse function removes *signal* from the calling process's signal mask.
- The sigignore function sets the disposition of *signal* to SIG_IGN.

The sighold function, in conjunction with sigrelse and sigpause, can be used to establish critical regions of code that require the delivery of a signal to be temporarily deferred.

Upon success, the sigrelse function returns a value of 0. Otherwise, a value of -1 is returned, and errno is set to indicate the error.

Note

These interfaces are provided for compatibility only. New programs should use sigaction and sigprocmask to control the disposition of signals.

Return Values

0	Indicates success.
-1	Indicates an error; errno is set to the following value: <ul style="list-style-type: none"> • EINVAL – The value of the <i>signal</i> argument is either an invalid signal number or SIGKILL.

sigsetjmp

sigsetjmp

Sets a jump point for a nonlocal goto.

Format

```
#include <setjmp.h>
init sigsetjmp (sigjmp_buf env, int savemask);
```

Arguments

env

An address for a `sigjmp_buf` structure.

savemask

An integer value that specifies whether you need to save the current signal mask.

Description

The `sigsetjmp` function saves its calling environment in its `env` argument for later use by the `siglongjmp` function.

If the value of `savemask` is not 0 (zero), `sigsetjmp` also saves the process's current signal mask as part of the calling environment.

See also `siglongjmp`.

Restrictions

You cannot invoke the `longjmp` function from an OpenVMS condition handler. However, you may invoke `longjmp` from a signal handler that has been established for any signal supported by the HP C RTL, subject to the following nesting restrictions:

- The `longjmp` function will not work if you invoke it from nested signal handlers. The result of the `longjmp` function, when invoked from a signal handler that has been entered as a result of an exception generated in another signal handler, is undefined.
- Do not invoke the `sigsetjmp` function from a signal handler unless the associated `longjmp` is to be issued before the handling of that signal is completed.
- Do not invoke the `longjmp` function from within an exit handler (established with `atexit` or `SYS$DCLEXH`). Exit handlers are invoked after image tear-down, so the destination address of the `longjmp` no longer exists.
- Invoking `longjmp` from within a signal handler to return to the main thread of execution might leave your program in an inconsistent state. Possible side effects include the inability to perform I/O or to receive any more UNIX signals. Use `siglongjmp` instead.

Return Values

0	Indicates success.
nonzero	The return is a call to the siglongjmp function.

sigsuspend

Atomically changes the set of blocked signals and waits for a signal.

Format

```
#include <signal.h>
int sigsuspend (const sigset_t *signal_mask);
```

Argument

signal_mask

A pointer to a set of signals.

Description

The sigsuspend function replaces the signal mask of the process with the set of signals pointed to by the *signal_mask* argument. Then it suspends execution of the process until delivery of a signal whose action is either to execute a signal catching function or to terminate the process. You cannot block the SIGKILL or SIGSTOP signals with the sigsuspend function. If a program attempts to block either of these signals, sigsuspend gives no indication of the error.

If delivery of a signal causes the process to terminate, sigsuspend does not return. If delivery of a signal causes a signal catching function to execute, sigsuspend returns after the signal catching function returns, with the signal mask restored to the set that existed prior to the call to sigsuspend.

The sigsuspend function sets the signal mask and waits for an unblocked signal as one atomic operation. This means that signals cannot occur between the operations of setting the mask and waiting for a signal. If a program invokes sigprocmask SIG_SETMASK and sigsuspend separately, a signal that occurs between these functions is often not noticed by sigsuspend.

In normal usage, a signal is blocked by using the sigprocmask function at the beginning of a critical section. The process then determines whether there is work for it to do. If there is no work, the process waits for work by calling sigsuspend with the mask previously returned by sigprocmask.

If a signal is intercepted by the calling process and control is returned from the signal handler, the calling process resumes execution after sigsuspend, which always returns a value of `-1` and sets `errno` to `EINTR`.

See also `sigpause` and `sigprocmask`.

sigtimedwait (*Integrity servers, Alpha*)

Suspends a calling thread and waits for queued signals to arrive.

Format

```
#include <signal.h>

int sigtimedwait (const sigset_t set, siginfo_t *info, const struct timespec *timeout);
```

Arguments

set

The set of signals to wait for.

info

Pointer to a siginfo structure that is receiving data describing the signal, including any application-defined data specified when the signal was posted.

timeout

A timeout for the wait. If *timeout* is NULL, the argument is ignored.

Description

The `sigtimedwait` function behaves the same as the `sigwaitinfo` function except that if none of the signals specified by *set* are pending, `sigtimedwait` waits for the time interval specified in the `timespec` structure referenced by *timeout*. If the `timespec` structure pointed to by *timeout* is zero-valued and if none of the signals specified by *set* are pending, then `sigtimedwait` returns immediately with an error.

See also `sigwait` and `sigwaitinfo`.

See Section 4.2 for more information on signal handling.

Return Values

x	Upon successful completion, the signal number selected is returned.
-1	Indicates that an error occurred; <code>errno</code> is set to one of the following values: <ul style="list-style-type: none">• <code>EINVAL</code> – The timeout argument specified a <code>tv_nsec</code> value less than 0 or greater than or equal to 1 billion.• <code>EINTR</code> – The wait was interrupted by an unblocked, intercepted signal.• <code>EAGAIN</code> – No signal specified by <i>set</i> was generated within the specified timeout period.

sigvec

Permanently assigns a handler for a specific signal.

Format

```
#include <signal.h>
int sigvec (int sigint, struct sigvec *sv, struct sigvec *osv);
```

Arguments

sigint

The signal identifier.

sv

Pointer to a sigvec structure (see the Description section).

osv

If *osv* is not NULL, the previous handling information for the signal is returned.

Description

If *sv* is not NULL, it specifies the address of a structure containing a pointer to a handler routine and mask to be used when delivering the specified signal, and a flag indicating whether the signal is to be processed on an alternative stack. If *sv*→*onstack* has a value of 1, the system delivers the signal to the process on a signal stack specified with sigstack.

The sigvec function establishes a handler that remains established until explicitly removed or until the image terminates.

The sigvec structure is defined in the <signal.h> header file:

```
struct sigvec
{
    int    (*handler)();
    int    mask;
    int    onstack;
};
```

See Section 4.2 for more information on signal handling.

Return Values

0	Indicates that the call succeeded.
-1	Indicates that an error occurred.

sigwait (*Integrity servers, Alpha*)

Suspends a calling thread and waits for queued signals to arrive.

Format

```
#include <signal.h>
int sigwait (const sigset_t set, int *sig);
```

Arguments

set
The set of signals to wait for.

sig
Returns the signal number of the selected signal.

Description

The `sigwait` function suspends the calling thread until at least one of the signals in the `set` argument is in the caller's set of pending signals. When this happens, one of those signals is automatically selected and removed from the set of pending signals. The signal number identifying that signal is then returned in the location referenced by `sig`.

The effect is unspecified if any signals in the `set` argument are not blocked when the `sigwait` function is called.

The `set` argument is created using the set manipulation functions `sigemptyset`, `sigfillset`, `sigaddset`, and `sigdelset`.

If, while the `sigwait` function is waiting, a signal occurs that is eligible for delivery (that is, not blocked by the signal mask), that signal is handled asynchronously and the wait is interrupted.

See also `sigtimedwait` and `sigwaitinfo`.

See Section 4.2 for more information on signal handling.

Return Values

- | | |
|---------|---|
| 0 | Upon successful completion, <code>sigwait</code> stores the signal number of the received signal at the location referenced by <code>sig</code> and returns 0. |
| nonzero | Indicates that an error occurred; <code>errno</code> is set to the following value: <ul style="list-style-type: none">• <code>EINVAL</code> – The <code>set</code> argument contains an invalid or unsupported signal number. |

sigwaitinfo (Integrity servers, Alpha)

Suspends a calling thread and waits for queued signals to arrive.

Format

```
#include <signal.h>
int sigwaitinfo (const sigset_t set, siginfo_t *info);
```

Arguments

set

The set of signals to wait for.

info

Pointer to a siginfo structure that is receiving data describing the signal, including any application-defined data specified when the signal was posted.

Description

The sigwaitinfo function behaves the same as the sigwait function if the *info* argument is NULL.

If the *info* argument is non-NULL, the sigwaitinfo function behaves the same as sigwait, except that the selected signal number is stored in the `si_signo` member of the siginfo structure, and the cause of the signal is stored in the `si_code` member. If any value is queued to the selected signal, the first such queued value is dequeued and the value is stored in the `si_value` member of *info*. The system resource used to queue the signal is released and made available to queue other signals. If no value is queued, the content of the `si_value` member is undefined. If no further signals are queued for the selected signal, the pending indication for that signal is reset.

See also sigtimedwait and sigwait.

See Section 4.2 for more information on signal handling.

Return Values

x	Upon successful completion, the signal number selected is returned.
-1	Indicates that an error occurred; errno is set to one of the following values: <ul style="list-style-type: none">• EINVAL – The <i>set</i> argument contains an invalid or unsupported signal number.• EINTR – The wait was interrupted by an unblocked, intercepted signal.

sin

sin

Returns the sine of its radian argument.

Format

```
#include <math.h>
double sin (double x);
float sinf (float x); (Integrity servers, Alpha)
long double sinl (long double x); (Integrity servers, Alpha)
double sind (double x); (Integrity servers, Alpha)
float sindf (float x); (Integrity servers, Alpha)
long double sindl (long double x); (Integrity servers, Alpha)
```

Argument

x
A radian expressed as a floating-point number.

Description

The `sin` functions compute the sine of x measured in radians.

The `sind` functions compute the sine of x measured in degrees.

Return Values

<code>x</code>	The sine of the argument.
<code>NaN</code>	$x = \pm\text{Infinity}$ or <code>NaN</code> ; <code>errno</code> is set to <code>EDOM</code> .
<code>0</code>	Underflow occurred; <code>errno</code> is set to <code>ERANGE</code> .

sinh

Returns the hyperbolic sine of its argument.

Format

```
#include <math.h>
double sinh (double x);
float sinhf (float x); (Integrity servers, Alpha)
long double sinhl (long double x); (Integrity servers, Alpha)
```

Argument

x
A real number.

Return Values

n	The hyperbolic sine of the argument.
HUGE_VAL	Overflow occurred; errno is set to ERANGE.
0	Underflow occurred; errno is set to ERANGE.
NaN	<i>x</i> is NaN; errno is set to EDOM.

sleep

sleep

Suspends the execution of the current process (or thread in a threaded program) for at least the number of seconds indicated by its argument.

Format

```
#include <unistd.h>
```

```
unsigned int sleep (unsigned seconds); (_DECC_V4_SOURCE)
```

```
int sleep (unsigned seconds); (not _DECC_V4_SOURCE)
```

Argument

seconds

The number of seconds.

Description

The sleep function sleeps for the specified number of seconds, or until a signal is received, or until the process (or thread in a threaded program) executes a call to SYS\$WAKE.

If a SIGALRM signal is generated, but blocked or ignored, the sleep function returns. For all other signals, a blocked or ignored signal does not cause sleep to return.

Return Values

x	The number of seconds that the process awoke early.
0	If the process slept the full number of seconds specified by <i>seconds</i> .

snprintf

Performs formatted output to a string in memory.

Format

```
#include <stdio.h>
```

```
int snprintf (char *str, size_t n, const char *format_spec, ... );
```

Arguments

str

The address of the string that will receive the formatted output.

n

The size of the buffer referred to by *str*.

format_spec

A pointer to a character string that contains the format specification. For more information about format specifications and conversion characters, see Chapter 2.

...

Optional expressions whose resultant types correspond to conversion specifications given in the format specification.

If no conversion specifications are given, you may omit the output sources.

Otherwise, the function calls must have at least as many output sources as there are conversion specifications, and the conversion specifications must match the types of the output sources.

Conversion specifications are matched to output sources in left-to-right order. Excess output pointers, if any, are ignored.

Description

The `snprintf` function is identical to the `sprintf` function with the addition of the *n* argument, which specifies the size of the buffer referred to by *str*.

On successful completion, `snprintf` returns the number of bytes (excluding the terminating null byte) that would be written to *str* if *n* is sufficiently large.

If *n* is 0, nothing is written, the number of bytes (excluding the terminating null) that would be written if *n* were sufficiently large are returned, and *str* might be a NULL pointer. Otherwise, output bytes beyond the *n* - 1st are discarded instead of being written to the array, and a null byte is written at the end of the bytes actually written into the array.

If an output error is encountered, a negative value is returned.

For a complete description of the format specification and the output source, see Chapter 2.

snprintf

Return Values

x	The number of bytes (excluding the terminating null byte) that would be written to <i>str</i> if <i>n</i> is sufficiently large.
Negative value	Indicates an output error occurred. The function sets <code>errno</code> . For a list of <code>errno</code> values set by this function, see <code>fprintf</code> .

sprintf

Performs formatted output to a string in memory.

Format

```
#include <stdio.h>

int sprintf (char *str, const char *format_spec, ... );
```

Arguments

str

The address of the string that will receive the formatted output. It is assumed that this string is large enough to hold the output.

format_spec

A pointer to a character string that contains the format specification. For more information about format specifications and conversion characters, see Chapter 2.

...

Optional expressions whose resultant types correspond to conversion specifications given in the format specification.

If no conversion specifications are given, you may omit the output sources. Otherwise, the function calls must have at least as many output sources as there are conversion specifications, and the conversion specifications must match the types of the output sources.

Conversion specifications are matched to output sources in left-to-right order. Excess output pointers, if any, are ignored.

Description

The `sprintf` function places output followed by the null character (`\0`) in consecutive bytes starting at `*str`. The user must ensure that enough space is available.

Consider the following example of a conversion specification:

```
#include <stdio.h>

main()
{
    int  temp = 4, temp2 = 17;
    char s[80];

    sprintf(s, "The answers are %d, and %d.", temp, temp2);
}
```

In this example, character string `s` has the following contents:

The answers are 4, and 17.

For a complete description of the format specification and the output source, see Chapter 2.

sprintf

Return Values

x

The number of characters placed in the output string, not including the final null character.

Negative value

Indicates an output error occurred. The function sets `errno`. For a list of `errno` values set by this function, see `fprintf`.

sqrt

Returns the square root of its argument.

Format

```
#include <math.h>
double sqrt (double x);
float sqrtf (float x); (Integrity servers, Alpha)
long double sqrtl (long double x); (Integrity servers, Alpha)
```

Argument

x
A real number.

Return Values

val	The square root of <i>x</i> , if <i>x</i> is nonnegative.
0	<i>x</i> is negative; errno is set to EDOM.
NaN	<i>x</i> is NaN; errno is set to EDOM.

srand

srand

Initializes the pseudorandom-number generator rand.

Format

```
#include <stdlib.h>
void srand (unsigned int seed);
```

Argument

seed
An unsigned integer.

Description

The `srand` function uses the argument as a seed for a new sequence of pseudorandom numbers to be returned by subsequent calls to `rand`.

If `srand` is then called with the same seed value, the sequence of pseudorandom numbers is repeated.

If `rand` is called before any calls to `srand`, the same sequence of pseudorandom numbers is generated as when `srand` is first called with a seed value of 1.

srand48

Initializes a 48-bit random-number generator.

Format

```
#include <stdlib.h>
void srand48 (long int seed_val);
```

Argument

seed_val

The initialization value to begin randomization. Changing this value changes the randomization pattern.

Description

The `srand48` function initializes the random-number generator. You can use this function in your program before calling the `drand48`, `lrand48`, or `mrand48` functions. (Although it is not recommended practice, constant default initializer values are automatically supplied if you call `drand48`, `lrand48`, or `mrand48` without calling an initialization function).

The function works by generating a sequence of 48-bit integer values, X_i , according to the linear congruential formula:

$$X_{n+1} = (aX_n + c) \bmod m \quad n \geq 0$$

The argument m equals 2^{48} , so 48-bit integer arithmetic is performed. Unless you invoke the `lcg48` function, the multiplier value a and the addend value c are:

$$\begin{aligned} a &= 5DEECE66D_{16} = 2736731631558 \\ c &= B_{16} = 138 \end{aligned}$$

The initializer function `srand48` sets the high-order 32 bits of X_i to the low-order 32 bits contained in its argument. The low-order 16 bits of X_i are set to the arbitrary value $330E_{16}$.

See also `drand48`, `lrand48`, and `mrand48`.

srandom

srandom

Initializes the pseudorandom-number generator `random`.

Format

```
#include <stdlib.h>
int srandom (unsigned seed);
```

Argument

seed
An initial seed value.

Description

The `srandom` function uses the argument as a seed for a new sequence of pseudorandom numbers to be returned by subsequent calls to `random`. This function has virtually the same calling sequence and initialization properties as the `srand` function, but produce sequences that are more random.

The `srandom` function initializes the current state with the initial seed value. The `srandom` function, unlike the `srand` function, does not return the old seed because the amount of state information used is more than a single word.

See also `rand`, `srand`, `random`, `setstate`, and `initstate`.

Return Values

0	Indicates success. Initializes the state <code>seed</code> .
-1	Indicates an error, further specified in the global <code>errno</code> .

sscanf

Reads input from a character string in memory, interpreting it according to the format specification.

Format

```
#include <stdio.h>

int sscanf (const char *str, const char *format_spec, ... );
```

Arguments

str

The address of the character string that provides the input text to sscanf.

format_spec

A pointer to a character string that contains the format specification. For more information about format specifications and conversion characters, see Chapter 2.

...

Optional expressions whose resultant types correspond to conversion specifications given in the format specification.

If no conversion specifications are given, you can omit the input pointers. Otherwise, the function calls must have at least as many input pointers as there are conversion specifications, and the conversion specifications must match the types of the input pointers.

Conversion specifications are matched to input sources in left-to-right order. Excess input pointers, if any, are ignored.

Description

The following is an example of a conversion specification:

```
main ()
{
    char str[] = "4 17";
    int  temp,
        temp2;

    sscanf(str, "%d %d", &temp, &temp2);
    printf("The answers are %d and %d.", temp, temp2);
}
```

This example produces the following output:

```
$ RUN EXAMPLE
The answers are 4 and 17.
```

For a complete description of the format specification and the input pointers, see Chapter 2.

sscanf

Return Values

x

The number of successfully matched and assigned input items.

EOF

Indicates that a read error occurred before any conversion. The function sets `errno`. For a list of the values set by this function, see `fscanf`.

ssignal

Allows you to specify the action to take when a particular signal is raised.

Format

```
#include <signal.h>

void (*ssignal (int sig, void (*func) (int, ... ))) (int, ... );
```

Arguments

sig

A number or mnemonic associated with a signal. The symbolic constants for signal values are defined in the `<signal.h>` header file (see Chapter 4).

func

The action to take when the signal is raised, or the address of a function that is executed when the signal is raised.

Description

The `ssignal` function is equivalent to the `signal` function except for the return value on error conditions.

Since the `signal` function is defined by the ANSI C standard and the `ssignal` function is not, use `signal` for greater portability.

See Section 4.2 for more information on signal handling.

Return Values

x	The address of the function previously established as the action for the signal. The address may be the value <code>SIG_DFL (0)</code> or <code>SIG_IGN (1)</code> .
0	Indicates errors. For this reason, there is no way to know whether a return status of 0 indicates failure, or whether it indicates that a previous action was <code>SIG_DFL (0)</code> .

[w]standend

[w]standend

Deactivate the boldface attribute for the specified window. The `standend` function operates on the `stdscr` window.

Format

```
#include <curses.h>
int standend (void);
int wstandend (WINDOW *win);
```

Argument

win
A pointer to the window.

Description

The `standend` and `wstandend` functions are equivalent to `clrattr` and `wclrattr` called with the attribute `_BOLD`.

Return Values

OK	Indicates success.
ERR	Indicates an error.

[w]standout

Activate the boldface attribute of the specified window. The `standout` function acts on the `stdscr` window.

Format

```
#include <curses.h>
int standout (void);
int wstandout (WINDOW *win);
```

Argument

win
A pointer to the window.

Description

The `standout` and `wstandout` functions are equivalent to `setattr` and `wsetattr` called with the attribute `_BOLD`.

Return Values

OK	Indicates success.
ERR	Indicates an error.

stat

stat

Accesses information about the specified file.

Format

```
#include <stat.h>
```

```
int stat (const char *file_spec, struct stat *buffer); (ISO POSIX-1)
```

```
int stat (const char *file_spec, struct stat *buffer, . . . ); (HP C Extension)
```

Function Variants

Compiling with the `_DECC_V4_SOURCE` and `_VMS_V6_SOURCE` feature-test macros defined enables a local-time-based entry point to the `stat` function that is equivalent to the behavior before OpenVMS Version 7.0.

Compiling with the `_USE_STD_STAT` feature-test macro defined enables a variant of the `stat` function that uses an X/Open standard-compliant definition of the `stat` structure. The `_USE_STD_STAT` feature-test macro is mutually exclusive with the `_DECC_V4_SOURCE` and `_VMS_V6_SOURCE` macros.

Arguments

file_spec

A valid OpenVMS or UNIX style file specification (no wildcards). Read, write, or execute permission of the named file is not required, but you must be able to reach all directories listed in the file specification leading to the file. For more information about UNIX style file specifications, see Chapter 1.

buffer

A pointer to a structure of type `stat`. For convenience, a typedef `stat_t` is defined as `struct stat` in the `<stat.h>` header file.

This argument receives information about the particular file. The members of the structure pointed to by *buffer* are described in the Description section.

. . .

An optional default file-name string.

This is the only optional RMS keyword that can be specified for the `stat` function. See the description of the `creat` function for the full list of optional RMS keywords and their values.

Description

When the `_USE_STD_STAT` feature-test macro is not enabled, the legacy `stat` structure is used. When `_USE_STD_STAT` is enabled, the X/Open standard-compliant `stat` structure is used.

Legacy stat Structure

With the `_USE_STD_STAT` feature-test macro defined to `DISABLE`, the following legacy `stat` structure is used:

Member	Type	Definition
<code>st_dev</code>	<code>dev_t</code>	Pointer to the physical device name
<code>st_ino[3]</code>	<code>ino_t</code>	Three words to receive the file ID
<code>st_mode</code>	<code>mode_t</code>	File “mode” (prot, dir, . . .)
<code>st_nlink</code>	<code>nlink_t</code>	For UNIX system compatibility only
<code>st_uid</code>	<code>uid_t</code>	Owner user ID
<code>st_gid</code>	<code>gid_t</code>	Group member: from <code>st_uid</code>
<code>st_rdev</code>	<code>dev_t</code>	UNIX system compatibility – always 0
<code>st_size</code>	<code>off_t</code>	File size, in bytes. For <code>st_size</code> to report a correct value, you need to flush both the C RTL and RMS buffers.
<code>st_atime</code>	<code>time_t</code>	File access time; always the same as <code>st_mtime</code>
<code>st_mtime</code>	<code>time_t</code>	Last modification time
<code>st_ctime</code>	<code>time_t</code>	File creation time
<code>st_fab_rfm</code>	<code>char</code>	Record format
<code>st_fab_rat</code>	<code>char</code>	Record attributes
<code>st_fab_fsz</code>	<code>char</code>	Fixed header size
<code>st_fab_mrs</code>	<code>unsigned</code>	Record size

The types `dev_t`, `ino_t`, `off_t`, `mode_t`, `nlink_t`, `uid_t`, `gid_t`, and `time_t`, are defined in the `<stat.h>` header file. However, when compiling for compatibility (`/DEFINE=_DECC_V4_SOURCE`), only `dev_t`, `ino_t`, and `off_t` are defined.

The `off_t` data type is either a 32-bit or 64-bit integer. The 64-bit interface allows for file sizes greater than 2 GB, and can be selected at compile time by defining the `_LARGEFILE` feature-test macro as follows:

```
CC/DEFINE=_LARGEFILE
```

As of OpenVMS Version 7.0, times are given in seconds since the Epoch (00:00:00 GMT, January 1, 1970).

The `st_mode` structure member is the status information mode defined in the `<stat.h>` header file. The `st_mode` bits are described as follows:

Bits	Constant	Definition
0170000	<code>S_IFMT</code>	Type of file
0040000	<code>S_IFDIR</code>	Directory
0020000	<code>S_IFCHR</code>	Character special
0060000	<code>S_IFBLK</code>	Block special
0100000	<code>S_IFREG</code>	Regular
0030000	<code>S_IFMPC</code>	Multiplexed char special
0070000	<code>S_IFMPB</code>	Multiplexed block special

stat

Bits	Constant	Definition
0004000	S_ISUID	Set user ID on execution
0002000	S_ISGID	Set group ID on execution
0001000	S_ISVTX	Save swapped text even after use
0000400	S_IREAD	Read permission, owner
0000200	S_IWRITE	Write permission, owner
0000100	S_IXEXEC	Execute/search permission, owner

The `stat` function does not work on remote network files.

If the file is a record file, the `st_size` field includes carriage-control information. Consequently, the `st_size` value will not correspond to the number of characters that can be read from the file.

Also be aware that for `st_size` to report a correct value, you need to flush both the C RTL and RMS buffers.

Standard-Compliant stat Structure

With OpenVMS Version 8.2, the `_USE_STD_STAT` feature-test macro and standard-compliant `stat` structure are introduced in support of UNIX compatibility.

With `_USE_STD_STAT` defined to `ENABLE`, you get the following behavior:

- Old struct `stat` definitions

Old definitions of struct `stat` are obsolete. You must recompile your applications to access the new features. Existing applications will continue to access the old definitions and functions unless they are recompiled to use the new features.
- Function variants

Calls to `stat`, `fstat`, `lstat`, and `ftw` accept pointers to structures of the new type. Calls to these functions are mapped to the new library entries `__std_stat`, `__std_fstat`, `__std_lstat`, and `__std_ftw`, respectively.
- Compatibilities with other feature macros

`_DECC_V4_SOURCE` source-code compatibility is not supported. You must not enable `_DECC_V4_SOURCE` and `_USE_STD_STAT` at the same time.

`_VMS_V6_SOURCE` binary compatibility is not supported. You must not enable `_VMS_V6_SOURCE` and `_USE_STD_STAT` at the same time. As a result, only UTC (rather than local-time) is supported for the `time_t` fields.
- Type changes

The following type changes are in effect:

 - 32-bit `gid_t` type `gid_t` is used. `_DECC_SHORT_GID_T` is unsupported.
 - `_LARGEFILE` offsets are used. `off_t` is forced to 64 bits.
 - Type `ino_t`, representing the file number, is an unsigned int quadword (64 bits). Previously, it was an unsigned short.
 - Type `dev_t`, representing the device id, is an unsigned int quadword (64 bits). Previously, it was a 32-bit character pointer. The new type is standard because it is arithmetic.

- Types `blksize_t` and `blkcnt_t` are added and defined as unsigned int quadwords (64 bits).
- Structure member Changes
 - Two members are added to struct `stat`:

```
blksize_t  st_blksize;
blkcnt_t   st_blocks;
```

According to the X/Open standard, `st_blksize` is the filesystem-specific preferred I/O blocksize for this file. On OpenVMS systems, `st_blksize` is set to the device buffer size multiplied by the disk cluster size. `st_blocks` is set to the allocated size of the file, in blocks. The blocksize used to calculate `st_blocks` is not necessarily the same as `st_blksize` and, in most cases, will not be the same.
 - In struct `stat`, member `st_ino` is of type `ino_t`. In previous C RTL versions, it was of type `ino_t [3]` (array of 3 `ino_t`). Since `ino_t` has changed from a word to a quadword, the size of this member has increased by one word. The principal significance of this change is that it makes `st_ino` a scalar, which is how most open source applications define it.
 - The new definition of `ino_t` also affects applications that include the `<dirent.h>` header file. In struct `dirent`, member `d_ino` changes in the same way as the `st_ino` member of struct `stat` in `<stat.h>`.
 - Several macros that are not part of any standard were introduced in `<stat.h>` to facilitate access to the constituent parts of `ino_t` values:
 - `S_INO_NUM(ino)`, `S_INO_SEQ(ino)`, and `S_INO_RVN(ino)` return the FILES-11 file number, sequence number, and relative volume number of `ino`, respectively, as unsigned shorts.
 - `S_INO_RVN_RVN(ino)` returns the byte of the RVN field containing the relative volume number;
 - `S_INO_RVN_NMX(ino)` returns the byte of the RVN field containing the file number extension.

Although individual components can be broken out like this, they are not part of the X/Open standard and should not be relied on in portable applications.
- Semantic changes

Values of type `dev_t` are now unique for each device across clusters. An algorithm based on device name and allocation class or `SCSSYSTEMID` (for single-pathed devices) calculates the device id value having these characteristics, an X/Open standard requirement. Typically, the combination of file number and device id uniquely identifies a file in a cluster.

This change affects `stat` structure members `st_dev` and `st_rdev`. For compatibility with previous releases, `st_rdev` is set to either 0 or `st_dev`.

Note *(Integrity servers, Alpha)*

On OpenVMS Alpha and Integrity server systems, the `stat`, `fstat`, `utime`, and `utimes` functions have been enhanced to take advantage of the new file-system support for POSIX compliant file timestamps.

stat

This support is available only on ODS-5 devices on OpenVMS Alpha systems beginning with a version of OpenVMS Alpha after Version 7.3.

Before this change, the `stat` and `fstat` functions were setting the values of the `st_ctime`, `st_mtime`, and `st_atime` fields based on the following file attributes:

```
st_ctime - ATR$C_CREDATE (file creation time)
st_mtime - ATR$C_REVDATE (file revision time)
st_atime - was always set to st_mtime because no support for file
access time was available
```

Also, for the file-modification time, `utime` and `utimes` were modifying the `ATR$C_REVDATE` file attribute, and ignoring the file-access-time argument.

After the change, for a file on an ODS-5 device, the `stat` and `fstat` functions set the values of the `st_ctime`, `st_mtime`, and `st_atime` fields based on the following new file attributes:

```
st_ctime - ATR$C_ATTDATE (last attribute modification time)
st_mtime - ATR$C_MODDATE (last data modification time)
st_atime - ATR$C_ACCDATE (last access time)
```

If `ATR$C_ACCDATE` is zero, as on an ODS-2 device, the `stat` and `fstat` functions set `st_atime` to `st_mtime`.

For the file-modification time, the `utime` and `utimes` functions modify both the `ATR$C_REVDATE` and `ATR$C_MODDATE` file attributes. For the file-access time, these functions modify the `ATR$C_ACCDATE` file attribute. Setting the `ATR$C_MODDATE` and `ATR$C_ACCDATE` file attributes on an ODS-2 device has no effect.

For compatibility, the old behavior of `stat`, `fstat`, `utime`, and `utimes` remains the default, regardless of the kind of device.

The new behavior must be explicitly enabled by defining the `DECC$EFS_FILE_TIMESTAMPS` logical name to `ENABLE` before invoking the application. Setting this logical does not affect the behavior of `stat`, `fstat`, `utime`, and `utimes` for files on an ODS-2 device.

Return Values

0	Indicates success.
-1	Indicates an error other than a privilege violation; <code>errno</code> is set to indicate the error.
-2	Indicates a privilege violation.

statvfs (Integrity servers, Alpha)

Gets information about a device containing the specified file.

Format

```
#include <statvfs.h>
int statvfs (const char *restrict path, struct statvfs *restrict buffer);
```

Arguments**path**

Any file on a mounted device.

buffer

Pointer to a `statvfs` structure to hold the returned information.

Description

The `statvfs` function returns descriptive information about the device containing the specified file. Read, write, or execute permission of the specified file is not required. The returned information is in the format of a `statvfs` structure, which is defined in the `<statvfs.h>` header file and contains the following members:

`unsigned long f_bsize` - Preferred block size.

`unsigned long f_frsize` - Fundamental block size.

`fsblkcnt_t f_blocks` - Total number of blocks in units of `f_frsize`.

`fsblkcnt_t f_bfree` - Total number of free blocks. If `f_bfree` would assume a meaningless value due to the misreporting of free block count by `$GETDVI` for a DFS disk, then `f_bfree` is set to the maximum block count.

`fsblkcnt_t f_bavail` - Number of free blocks available. Set to the unused portion of the caller's disk quota.

`fsfilcnt_t f_files` - Total number of file serial numbers (for example, inodes).

`fsfilcnt_t f_ffree` - Total number of free file serial numbers. For OpenVMS systems, this value is calculated as `freeblocks/clustersize`.

`fsfilcnt_t f_favail` - Number of file serial numbers available to a non-privileged process (0 for OpenVMS systems).

`unsigned long f_fsid` - File system identifier. This identifier is based on the allocation-class device name. This gives a unique value based on device, as long as the device is locally mounted.

`unsigned long f_flag` - Bit mask representing one or more of the following flags:

`ST_RDONLY` - The volume is read-only.

`ST_NOSUID` - The volume has protected subsystems enabled.

statvfs *(Integrity servers, Alpha)*

unsigned long f_namemax - Maximum length of a filename.
char f_basetype[64] - Device-type name.
char f_fstr[64] - Logical volume name.
char __reserved[64] - Media type name.

Upon successful completion, statvfs returns 0 (zero). Otherwise, it returns -1 and sets errno to indicate the error.

See also fstatvfs.

Return Value

0	Successful completion.
-1	Indicates an error. errno is set to one of the following: <ul style="list-style-type: none">• EACCES - Search permission is denied for a component of the path prefix.• EIO - An I/O error occurred while reading the device.• EINTR - A signal was intercepted during execution of the function.• EOVERFLOW - One of the values to be returned cannot be represented correctly in the structure pointed to by <i>buffer</i>.• ENAMETOOLONG - The length of a component of the path parameter exceeds NAME_MAX, or the length of the path parameter exceeds PATH_MAX.• ENOENT - A component of <i>path</i> does not name an existing file, or <i>path</i> is an empty string.• ENOTDIR - A component of the path prefix of the <i>path</i> parameter is not a directory.

strcasecmp

Does a case-insensitive comparison of two 7-bit ASCII strings.

Format

```
#include <strings.h>  
int strcasecmp (const char *s1, const char *s2);
```

Arguments

s1
The first of two strings to compare.

s2
The second of two strings to compare.

Description

The `strcasecmp` function is case-insensitive. The returned lexicographic difference reflects a conversion to lowercase.

The `strcasecmp` function works for 7-bit ASCII compares only. Do not use this function for internationalized applications.

Return Value

n An integer value greater than, equal to, or less than 0 (zero), depending on whether the *s1* string is greater than, equal to, or less than the *s2* string.

strcat

strcat

Concatenates *str_2*, including the terminating null character, to the end of *str_1*.

Format

```
#include <string.h>
char *strcat (char *str_1, const char *str_2);
```

Function Variants

The `strcat` function has variants named `_strcat32` and `_strcat64` for use with 32-bit and 64-bit pointer sizes, respectively. See Section 1.9 for more information on using pointer-size-specific functions.

Arguments

str_1, str_2
Pointers to null-terminated character strings.

Description

See `strncat`.

Return Value

x The address of the first argument, *str_1*, which is assumed to be large enough to hold the concatenated result.

Example

```
#include <string.h>
#include <stdio.h>

/* This program concatenates two strings using the strcat      */
/* function, and then manually compares the result of strcat  */
/* to the expected result.                                    */

#define S1LENGTH 10
#define S2LENGTH 8

main()
{
    static char s1buf[S1LENGTH + S2LENGTH] = "abcmnxyz";
    static char s2buf[] = " orthis";
    static char test1[] = "abcmnxyz orthis";

    int i;
    char *status;

    /* Take static buffer s1buf, concatenate static buffer      */
    /* s2buf to it, and compare the answer in s1buf with the    */
    /* static answer in test1.                                    */

    status = strcat(s1buf, s2buf);
    for (i = 0; i <= S1LENGTH + S2LENGTH - 2; i++) {
        /* Check for correct returned string.                    */

```



```
        if (test1[i] != slbuf[i])  
            printf("error in strcat");  
    }  
}
```

strchr

strchr

Returns the address of the first occurrence of a given character in a null-terminated string.

Format

```
#include <string.h>

char *strchr (const char *str, int character);
```

Function Variants

The `strchr` function has variants named `_strchr32` and `_strchr64` for use with 32-bit and 64-bit pointer sizes, respectively. See Section 1.9 for more information on using pointer-size-specific functions.

Arguments

str
A pointer to a null-terminated character string.

character
An object of type `int`.

Description

This function returns the address of the *first* occurrence of a given character in a null-terminated string. The terminating null character is considered to be part of the string.

Compare with `strrchr`, which returns the address of the *last* occurrence of a given character in a null-terminated string.

Return Values

x	The address of the first occurrence of the specified character.
NULL	Indicates that the character does not occur in the string.

Example

```
#include <stdio.h>
#include <string.h>

main()
{
    static char s1buf[] = "abcdefghijkl lkjihgfedcba";
    int i;
    char *status;

    /* This program checks the strchr function by incrementally */
    /* going through a string that ascends to the middle and then */
    /* descends towards the end. */

    for (i = 0; s1buf[i] != '\0' && s1buf[i] != ' '; i++) {
        status = strchr(s1buf, s1buf[i]);
```

```
/* Check for pointer to leftmost character - test 1.          */
    if (status != &slbuf[i])
        printf("error in strchr");
    }
}
```

strcmp

strcmp

Compares two ASCII character strings and returns a negative, 0, or positive integer, indicating that the ASCII values of the individual characters in the first string are less than, equal to, or greater than the values in the second string.

Format

```
#include <string.h>

int strcmp (const char *str_1, const char *str_2);
```

Arguments

str_1, str_2
Pointers to character strings.

Description

The strings are compared until a null character is encountered or until the strings differ.

Return Values

< 0	Indicates that <i>str_1</i> is less than <i>str_2</i> .
= 0	Indicates that <i>str_1</i> equals <i>str_2</i> .
> 0	Indicates that <i>str_1</i> is greater than <i>str_2</i> .

strcoll

Compares two strings and returns an integer that indicates if the strings differ and how they differ. The function uses the collating information in the LC_COLLATE category of the current locale to determine how the comparison is performed.

Format

```
#include <string.h>

int strcoll (const char *s1, const char *s2);
```

Arguments

s1, s2
Pointers to character strings.

Description

The strcoll function, unlike strcmp, compares two strings in a locale-dependent manner. Because no value is reserved for error indication, the application must check for one by setting errno to 0 before the function call and testing it after the call.

See also strxfrm.

Return Values

< 0	Indicates that <i>s1</i> is less than <i>s2</i> .
= 0	Indicates that the strings are equal.
> 0	Indicates that <i>s1</i> is greater than <i>s2</i> .

strcspn

Returns the length of the prefix of a string that consists entirely of characters not in a specified set of characters.

Format

```
#include <string.h>
size_t strcspn (const char *str, const char *charset);
```

Arguments

str

A pointer to a character string. If this character string is a null string, 0 is returned.

charset

A pointer to a character string containing the set of characters.

Description

The `strcspn` function scans the characters in the string, stops when it encounters a character found in *charset*, and returns the length of the string's initial segment formed by characters not found in *charset*.

If none of the characters match in the character strings pointed to by *str* and *charset*, `strcspn` returns the length of string.

Return Value

x	The length of the segment.
---	----------------------------

strdup

strdup

Duplicates the specified string.

Format

```
#include <string.h>
char *strdup (const char *s1);
```

Function Variants

The `strdup` function has variants named `_strdup32` and `_strdup64` for use with 32-bit and 64-bit pointer sizes, respectively. See Section 1.9 for more information on using pointer-size-specific functions.

Argument

s1
The string to be duplicated.

Description

The `strdup` function returns a pointer to a string that is an exact duplicate of the string pointed to by `s1`. The `malloc` function is used to allocate space for the new string. The `strdup` function is provided for compatibility with existing systems.

Return Values

x	A pointer to the resulting string.
NULL	Indicates an error.

strerror

Maps the error number in *error_code* to a locale-dependent error message string.

Format

```
#include <string.h>
```

```
char *strerror (int error_code); (ANSI C)
```

```
char *strerror (int error_code[], int vms_error_code); (HP C Extension)
```

Arguments

error_code

An error code.

vms_error_code

An OpenVMS error code.

Description

The `strerror` function uses the error number in *error_code* to retrieve the appropriate locale-dependent error message. The contents of the error message strings are determined by the `LC_MESSAGES` category of the program's current locale.

When a program is not compiled with any standards-related feature-test macros (see Section 1.4.1), `strerror` has a second argument (*vms_error_code*), which is used in the following way:

- If *error_code* is `EVMSEERR` and there is a second argument, then that second argument is used as the `vaxc$errno` value.
- If *error_code* is `EVMSEERR` and there is no second argument, look at `vaxc$errno` to get the OpenVMS error condition.

See the Example section.

Use of the second argument is not included in the ANSI C definition of `strerror` and is, therefore, not portable.

Because no return value is reserved to indicate an error, applications should set the value of `errno` to 0, call `strerror`, and then test the value of `errno`; a nonzero value indicates an error condition.

Return Value

x

A pointer to a buffer containing the appropriate error message. Do not modify this buffer in your programs. Moreover, calls to the `strerror` function may overwrite this buffer with a new message.

strerror

Example

```
#include <stdio.h>
#include <errno.h>
#include <string.h>
#include <stdlib.h>
#include <ssdef.h>

main()
{
    puts(strerror(EVMSERR));
    errno = EVMSERR;
    vaxc$errno = SS$_LINEXIT;
    puts(strerror(errno));
    puts(strerror(EVMSERR, SS$_ABORT));
    exit(1);
}
```

Running this example produces the following output:

```
nontranslatable vms error code: <none>
network partner exited
abort
```

strfmon

Converts a number of monetary values into a string. The conversion is controlled by a format string.

Format

```
#include <monetary.h>

ssize_t strfmon (char *s, size_t maxsize, const char *format, . . . );
```

Arguments

s

A pointer to the resultant string.

maxsize

The maximum number of bytes to be stored in the resultant string.

format

A pointer to a string that controls the format of the output string.

. . .

The monetary values of type double that are to be formatted for the output string. There should be as many values as there are conversion specifications in the format string pointed to by *format*. The function fails if there are insufficient values. Excess arguments are ignored.

Description

The `strfmon` function creates a string pointed to by *s*, using the monetary values supplied. A maximum of *maxsize* bytes is copied to *s*.

The format string pointed to by *format* consists of ordinary characters and conversion specifications. All ordinary characters are copied unchanged to the output string. A conversion specification defines how one of the monetary values supplied is formatted in the output string.

A conversion specification consists of a percent character (`%`), followed by a number of optional characters (see Table REF-5), and concluding with a conversion specifier (see Table REF-6).

If any of the optional characters listed in Table REF-5 is included in a conversion specification, they must appear in the order shown.

Table REF–5 Optional Characters in strfmon Conversion Specifications

Character	Meaning
<i>=character</i>	Use <i>character</i> as the numeric fill character if a left precision is specified. The default numeric fill character is the space character. The fill character must be representable as a single byte in order to work with precision and width count. This conversion specifier is ignored unless a left precision is specified, and it does not affect width filling, which always uses the space character.
^	Do not use separator characters to format the number. By default, the digits are grouped according to the <i>mon_grouping</i> field in the LC_MONETARY category of the current locale.
+	Add the string specified by the <i>positive_sign</i> or <i>negative_sign</i> fields in the current locale. If <i>p_sign_posn</i> or <i>n_sign_posn</i> is set to 0, then parentheses are used by default to indicate negative values. Otherwise, sign strings are used to indicate the sign of the value. You cannot use a + and a (in the same conversion specification.
(Enclose negative values within parentheses. The default is taken from the <i>p_sign_posn</i> and <i>n_sign_posn</i> fields in the current locale. If <i>p_sign_posn</i> or <i>n_sign_posn</i> is set to 0, then parentheses are used by default to indicate negative values. Otherwise, sign strings are used to indicate the sign of the value. You cannot use a + and (in the same conversion specification.
!	Suppress the currency symbol. By default, the currency symbol is included.
–	Left-justify the value within the field. By default, values are right-justified.
field width	A decimal integer that specifies the minimum field width in which to align the result of the conversion. The default field width is the smallest field that can contain the result.
#left_precision	A # followed by a decimal integer specifies the number of digits to the left of the radix character. Extra positions are filled by the fill character. By default the precision is the smallest required for the argument. If grouping is not suppressed with the ^ conversion specifier, and if grouping is defined for the current locale, grouping separators are inserted before any fill characters are added. Grouping separators are not applied to fill characters even if the fill character is defined as a digit.

(continued on next page)

Table REF–5 (Cont.) Optional Characters in strfmon Conversion Specifications

Character	Meaning
.right_precision	A period (.) followed by a decimal integer specifies the number of digits to the right of the radix character. Extra positions are filled with zeros. The amount is rounded to this number of decimal places. If the right precision is zero, the radix character is not included in the output. By default the right precision is defined by the <i>frac_digits</i> or <i>int_frac_digits</i> field of the current locale.

Table REF–6 strfmon Conversion Specifiers

Specifier	Meaning
i	Use the international currency symbol defined by the <i>int_currency_symbol</i> field in the current locale, unless the currency symbol has been suppressed.
n	Use the local currency symbol defined by the <i>currency_symbol</i> field in the current locale, unless the currency symbol has been suppressed.
%	Output a % character. The conversion specification must be %%; none of the optional characters is valid with this specifier.

Return Values

x	The number of bytes written to the string pointed to by s, not including the null-terminating character.
–1	Indicates an error. The function sets errno to one of the following values: <ul style="list-style-type: none"> • EINVAL – A conversion specification is syntactically incorrect. • E2BIG – Processing the complete format string would produce more than <i>maxsize</i> bytes.

Example

```
#include <stdlib.h>
#include <stdio.h>
#include <locale.h>
#include <monetary.h>
#include <errno.h>

#define MAX_BUF_SIZE 124

main()
{
    size_t ret;
    char buffer[MAX_BUF_SIZE];
    double amount = 102593421;

    /* Display a monetary amount using the en_US.ISO8859-1 */
    /* locale and a range of different display formats. */
}
```

strfmon

```
if (setlocale(LC_ALL, "en_US.ISO8859-1") == (char *) NULL) {
    perror("setlocale");
    exit(EXIT_FAILURE);
}
ret = strfmon(buffer, MAX_BUF_SIZE, "International: %i\n", amount);
printf(buffer);

ret = strfmon(buffer, MAX_BUF_SIZE, "National:      %n\n", amount);
printf(buffer);

ret = strfmon(buffer, MAX_BUF_SIZE, "National:      %=*#10n\n", amount);
printf(buffer);

ret = strfmon(buffer, MAX_BUF_SIZE, "National:      %(n\n", -1 * amount);
printf(buffer);

ret = strfmon(buffer, MAX_BUF_SIZE, "National:      %^!n\n", amount);
printf(buffer);
}
```

Running the example program produces the following result:

```
International: USD 102,593,421.00
National:      $102,593,421.00
National:      $**102,593,421.00
National:      ($102,593,421.00)
National:      102593421.00
```

strptime

Uses date and time information stored in a `tm` structure to create an output string. The format of the output string is controlled by a format string.

Format

```
#include <time.h>
```

```
size_t strptime (char *s, size_t maxsize, const char *format, const struct tm *timeptr);
```

Function Variants

Compiling with the `_DECC_V4_SOURCE` and `_VMS_V6_SOURCE` feature-test macros defined enables a local-time-based entry point to the `strptime` function that is equivalent to the behavior before OpenVMS Version 7.0.

Arguments

s

A pointer to the resultant string.

maxsize

The maximum number of bytes to be stored in the resultant string, including the null terminator.

format

A pointer to a string that controls the format of the output string.

timeptr

A pointer to the local time (`tm`) structure. The `tm` structure is defined in the `<time.h>` header file.

Description

The `strptime` function uses data in the structure pointed to by `timeptr` to create the string pointed to by `s`. A maximum of `maxsize` bytes is copied to `s`.

The format string consists of zero or more conversion specifications and ordinary characters. All ordinary characters (including the terminating null character) are copied unchanged into the output string. A conversion specification defines how data in the `tm` structure is formatted in the output string.

A conversion specification consists of a percent (`%`) character followed by one or more optional characters (see Table REF-7), and concluding with a conversion specifier (see Table REF-8). If any of the optional characters listed in Table REF-7 are specified, they must appear in the order shown in the table.

The `strptime` function behaves as if it called `tzset`.

Table REF–7 Optional Elements of strptime Conversion Specifications

Element	Meaning
–	Optional with the field width to specify that the field is left-justified and padded with spaces. This cannot be used with the 0 element.
0	Optional with the field width to specify that the field is right-justified and padded with zeros. This cannot be used with the – element.
field width	A decimal integer that specifies the maximum field width
.precision	A decimal integer that specifies the precision of data in a field. For the d, H, I, j, m, M, o, S, U, w, W, y, and Y conversion specifiers, the precision specifier is the minimum number of digits to appear in the field. If the conversion specification has fewer digits than that specified by the precision, leading zeros are added. For the a, A, b, B, c, D, E, h, n, N, p, r, t, T, x, X, Z, and % conversion specifiers, the precision specifier is the maximum number of characters to appear in the field. If the conversion specification has more characters than that specified by the precision, characters are truncated on the right. The default precision for the d, H, I, m, M, o, S, U, w, W, y and Y conversion specifiers is 2; the default precision for the j conversion specifier is 3.

Note that the list of conversion specifications in Table REF–7 are extensions to the XPG4 specification.

Table REF–8 lists the conversion specifiers. The `strptime` function uses fields in the `LC_TIME` category of the program's current locale to provide a value. For example, if `%B` is specified, the function accesses the `mon` field in `LC_TIME` to find the full month name for the month specified in the `tm` structure. The result of using invalid conversion specifiers is undefined.

Table REF–8 strptime Conversion Specifiers

Specifier	Replaced by
a	The locale's abbreviated weekday name
A	The locale's full weekday name
b	The locale's abbreviated month name
B	The locale's full month name
c	The locale's appropriate date and time representation
C	The century number (the year divided by 100 and truncated to an integer) as a decimal number (00 – 99)
d	The day of the month as a decimal number (01 – 31)
D	Same as <code>%m/%d/%y</code>
e	The day of the month as a decimal number (1 – 31) in a 2-digit field with the leading space character fill
Ec	The locale's alternative date and time representation

(continued on next page)

Table REF-8 (Cont.) strptime Conversion Specifiers

Specifier	Replaced by
EC	The name of the base year (period) in the locale's alternative representation
Ex	The locale's alternative date representation
EX	The locale's alternative time representation
Ey	The offset from the base year (%EC) in the locale's alternative representation
EY	The locale's full alternative year representation
h	Same as %b
H	The hour (24-hour clock) as a decimal number (00 – 23)
I	The hour (12-hour clock) as a decimal number (01 – 12)
j	The day of the year as a decimal number (001 – 366)
m	The month as a decimal number (01 – 12)
M	The minute as a decimal number (00 – 59)
n	The new-line character
Od	The day of the month using the locale's alternative numeric symbols
Oe	The date of the month using the locale's alternative numeric symbols
OH	The hour (24-hour clock) using the locale's alternative numeric symbols
OI	The hour (12-hour clock) using the locale's alternative numeric symbols
Om	The month using the locale's alternative numeric symbols
OM	The minutes using the locale's alternative numeric symbols
OS	The seconds using the locale's alternative numeric symbols
Ou	The weekday as a number in the locale's alternative representation (Monday=1)
OU	The week number of the year (Sunday as the first day of the week) using the locale's alternative numeric symbols
OV	The week number of the year (Monday as the first day of the week) as a decimal number (01 – 53) using the locale's alternative numeric symbols. If the week containing January 1 has four or more days in the new year, it is considered as week 1. Otherwise, it is considered as week 53 of the previous year, and the next week is week 1.
Ow	The weekday as a number (Sunday=0) using the locale's alternative numeric symbols
OW	The week number of the year (Monday as the first day of the week) using the locale's alternative numeric symbols
Oy	The year without the century using the locale's alternative numeric symbols

(continued on next page)

strptime

Table REF–8 (Cont.) strptime Conversion Specifiers

Specifier	Replaced by
p	The locale's equivalent of the AM/PM designations associated with a 12-hour clock
r	The time in AM/PM notation
R	The time in 24-hour notation (%H:%M)
S	The second as a decimal number (00 – 61)
t	The tab character
T	The time (%H:%M:%S)
u	The weekday as a decimal number between 1 and 7 (Monday=1)
U	The week number of the year (the first Sunday as the first day of week 1) as a decimal number (00 – 53)
V	The week number of the year (Monday as the first day of the week) as a decimal number (00 – 53). If the week containing January 1 has four or more days in the new year, it is considered as week 1. Otherwise, it is considered as week 53 of the previous year, and the next week is week 1.
w	The weekday as a decimal number (0 [Sunday] – 6)
W	The week number of the year (the first Monday as the first day of week 1) as a decimal number (00 – 53)
x	The locale's appropriate date representation
X	The locale's appropriate time representation
y	The year without century as a decimal number (00 – 99)
Y	The year with century as a decimal number
Z	Time-zone name or abbreviation. If time-zone information is not available, no character is output.
%	Literal % character.

Return Values

x	The number of characters placed into the array pointed to by <i>s</i> , not including the terminating null character.
0	Indicates an error occurred. The contents of the array are indeterminate.

Example

```
#include <stdlib.h>
#include <stdio.h>
#include <time.h>
#include <locale.h>
#include <errno.h>

#define NUM_OF_DATES 7
#define BUF_SIZE 256

/* This program formats a number of different dates, once */
/* using the C locale and then using the fr_FR.ISO8859-1 */
/* locale. Date and time formatting is done using strptime(). */
```

```

main()
{
    int count,
        i;
    char buffer[BUF_SIZE];
    struct tm *tm_ptr;
    time_t time_list[NUM_OF_DATES] =
        {500, 68200000, 694223999, 694224000,
         704900000, 705000000, 705900000};

    /* Display dates using the C locale */
    printf("\nUsing the C locale:\n\n");

    setlocale(LC_ALL, "C");

    for (i = 0; i < NUM_OF_DATES; i++) {
        /* Convert to a tm structure */
        tm_ptr = localtime(&time_list[i]);

        /* Format the date and time */
        count = strftime(buffer, BUF_SIZE,
            "Date: %A %d %B %Y%nTime: %T%n%n", tm_ptr);
        if (count == 0) {
            perror("strftime");
            exit(EXIT_FAILURE);
        }

        /* Print the result */
        printf(buffer);
    }

    /* Display dates using the fr_FR.ISO8859-1 locale */
    printf("\nUsing the fr_FR.ISO8859-1 locale:\n\n");

    setlocale(LC_ALL, "fr_FR.ISO8859-1");

    for (i = 0; i < NUM_OF_DATES; i++) {
        /* Convert to a tm structure */
        tm_ptr = localtime(&time_list[i]);

        /* Format the date and time */
        count = strftime(buffer, BUF_SIZE,
            "Date: %A %d %B %Y%nTime: %T%n%n", tm_ptr);
        if (count == 0) {
            perror("strftime");
            exit(EXIT_FAILURE);
        }

        /* Print the result */
        printf(buffer);
    }
}

```

Running the example program produces the following result:

Using the C locale:

Date: Thursday 01 January 1970
Time: 00:08:20

Date: Tuesday 29 February 1972
Time: 08:26:40

Date: Tuesday 31 December 1991
Time: 23:59:59

Date: Wednesday 01 January 1992
Time: 00:00:00

Date: Sunday 03 May 1992
Time: 13:33:20

strftime

Date: Monday 04 May 1992
Time: 17:20:00

Date: Friday 15 May 1992
Time: 03:20:00

Using the fr_FR.ISO8859-1 locale:

Date: jeudi 01 janvier 1970
Time: 00:08:20

Date: mardi 29 février 1972
Time: 08:26:40

Date: mardi 31 décembre 1991
Time: 23:59:59

Date: mercredi 01 janvier 1992
Time: 00:00:00

Date: dimanche 03 mai 1992
Time: 13:33:20

Date: lundi 04 mai 1992
Time: 17:20:00

Date: vendredi 15 mai 1992
Time: 03:20:00

strncasecmp

strncasecmp

Does a case-insensitive comparison between two 7-bit ASCII strings.

Format

```
#include <strings.h>
int strncasecmp (const char *s1, const char *s2, size_t n);
```

Arguments

s1

The first of two strings to compare.

s2

The second of two strings to compare.

n

The maximum number of bytes in a string to compare.

Description

The `strncasecmp` function is case-insensitive. The returned lexicographic difference reflects a conversion to lowercase. The `strncasecmp` function is similar to the `strcasecmp` function, but also compares size. If the size specified by *n* is read before a NULL, the comparison stops.

The `strcasecmp` function works for 7-bit ASCII compares only. Do not use this function for internationalized applications.

Return Value

n An integer value greater than, equal to, or less than 0 (zero), depending on whether *s1* is greater than, equal to, or less than *s2*.

strncat

Appends not more than *maxchar* characters from *str_2* to the end of *str_1*.

Format

```
#include <string.h>
```

```
char *strncat (char *str_1, const char *str_2, size_t maxchar);
```

Function Variants

The `strncat` function has variants named `_strncat32` and `_strncat64` for use with 32-bit and 64-bit pointer sizes, respectively. See Section 1.9 for more information on using pointer-size-specific functions.

Arguments

str_1, str_2

Pointers to null-terminated character strings.

maxchar

The number of characters to concatenate from *str_2*, unless `strncat` first encounters a null terminator in *str_2*. If *maxchar* is 0, no characters are copied from *str_2*.

Description

A null character is always appended to the result of the `strncat` function. If `strncat` reaches the specified maximum, it sets the next byte in *str_1* to the null character.

Return Value

x	The address of the first argument, <i>str_1</i> , which is assumed to be large enough to hold the concatenated result.
---	--

strncmp

strncmp

Compares not more than *maxchar* characters of two ASCII character strings and returns a negative, 0, or positive integer, indicating that the ASCII values of the individual characters in the first string are less than, equal to, or greater than the values in the second string.

Format

```
#include <string.h>

int strncmp (const char *str_1, const char *str_2, size_t maxchar);
```

Arguments

str_1, str_2

Pointers to character strings.

maxchar

The maximum number of characters (beginning with the first) to search in both *str_1* and *str_2*. If *maxchar* is 0, no comparison is performed and 0 is returned (the strings are considered equal).

Description

The `strncmp` function compares no more than *maxchar* characters from the string pointed to by *str_1* to the string pointed to by *str_2*. The strings are compared until a null character is encountered, the strings differ, or *maxchar* is reached. Characters that follow a difference or a null character are not compared.

Return Values

< 0	Indicates that <i>str_1</i> is less than <i>str_2</i> .
= 0	Indicates that <i>str_1</i> equals <i>str_2</i> .
> 0	Indicates that <i>str_1</i> is greater than <i>str_2</i> .

Examples

```
1. #include <string.h>
   #include <stdio.h>

   main()
   {
       printf( "%d\n", strncmp("abcde", "abc", 3));
   }
```

When linked and executed, this example returns 0, because the first 3 characters of the 2 strings are equal:

```
$ run tmp
0
```



```
2. #include <string.h>
   #include <stdio.h>
   main()
   {
     printf( "%d\n", strncmp("abcde", "abc", 4));
   }
```

When linked and executed, this example returns a value greater than 0 because the first 4 characters of the 2 strings are not equal (The "d" in the first string is not equal to the null character in the second):

```
$ run tmp
    100
```

strncpy

strncpy

Copies not more than *maxchar* characters from *source* into *dest*.

Format

```
#include <string.h>
char *strncpy (char *dest, const char *source, size_t maxchar);
```

Function Variants

The `strncpy` function has variants named `_strncpy32` and `_strncpy64` for use with 32-bit and 64-bit pointer sizes, respectively. See Section 1.9 for more information on using pointer-size-specific functions.

Arguments

dest

Pointer to the destination character string.

source

Pointer to the source character string.

maxchar

The maximum number of characters to copy from *source* to *dest* up to but not including the null terminator of *source*.

Description

The `strncpy` function copies no more than *maxchar* characters from *source* to *dest*, up to but not including the null terminator of *source*. If *source* contains less than *maxchar* characters, *dest* is padded with null characters. If *source* contains greater than or equal to *maxchar* characters, as many characters as possible are copied to *dest*. Be aware that the *dest* argument might not be terminated by a null character after a call to `strncpy`.

Return Value

x	The address of <i>dest</i> .
---	------------------------------

strnlen

Returns the number of bytes in a string.

Format

```
#include <string.h>
size_t strnlen (const char *s, size_t n);
```

Arguments

s
Pointer to the string.

n
The maximum number of characters to examine.

Description

The `strnlen` function returns the number of bytes in the string pointed to by `s`. The string length value does not include the terminating null character. The `strnlen` function counts bytes until the first null byte or until `n` bytes have been examined.

Return Value

`n` The length of the string.

strpbrk

strpbrk

Searches a string for the occurrence of one of a specified set of characters.

Format

```
#include <string.h>
char *strpbrk (const char *str, const char *charset);
```

Function Variants

The `strpbrk` function has variants named `_strpbrk32` and `_strpbrk64` for use with 32-bit and 64-bit pointer sizes, respectively. See Section 1.9 for more information on using pointer-size-specific functions.

Arguments

str

A pointer to a character string. If this character string is a null string, 0 is returned.

charset

A pointer to a character string containing the set of characters for which the function will search.

Description

The `strpbrk` function scans the characters in the string, stops when it encounters a character found in *charset*, and returns the address of the first character in the string that appears in the character set.

Return Values

x	The address of the first character in the string that is in the set.
NULL	Indicates that no character is in the set.

strptime

Converts a character string into date and time values that are stored in a `tm` structure. Conversion is controlled by a format string.

Format

```
#include <time.h>
```

```
char *strptime (const char *buf, const char *format, struct tm *timeptr);
```

Function Variants

The `strptime` function has variants named `_strptime32` and `_strptime64` for use with 32-bit and 64-bit pointer sizes, respectively. See Section 1.9 for more information on using pointer-size-specific functions.

Arguments

buf

A pointer to the character string to convert.

format

A pointer to the string that defines how the input string is converted.

timeptr

A pointer to the local time structure. The `tm` structure is defined in the `<time.h>` header file.

Description

The `strptime` function converts the string pointed to by *buf* into values that are stored in the structure pointed to by *timeptr*. The string pointed to by *format* defines how the conversion is performed.

The `strptime` function modifies only those fields in the `tm` structure that have corresponding conversion specifications in the format. In particular, `strptime` never sets the `tm_isdst` member of the `tm` structure.

The format string consists of zero or more directives. A directive is composed of one of the following:

- One or more white-space characters (as defined by the `isspace` function). This directive causes the function to read input up to the first character that is not a white-space character.
- Any character other than the percent character (`%`) or a white-space character. This directive causes the function to read the next character. The character read must be the same as the character that comprises the directive. If the character is different, the function fails.
- A conversion specification. A conversion specification defines how characters in the input string are interpreted as values that are then stored in the `tm` structure. A conversion specification consists of a percent (`%`) character followed by a conversion specifier. Table REF-9 lists the valid conversion specifications.

strptime

The `strptime` function uses fields in the `LC_TIME` category of the program's current locale to provide a value.

Note

To be compliant with X/Open CAE Specification System Interfaces and Headers Issue 5 (commonly known as XPG5), the `strptime` function processes the `"%y"` directive differently than in previous versions of the HP C RTL.

With Version 6.4 and higher of the C compiler, for a two-digit year within the century if no century is specified, `"%y"` directive values range from:

- 69 to 99 refer to years in the twentieth century (1969 to 1999 inclusive)
- 00 to 68 refer to years in the twenty-first century (2000 to 2068 inclusive)

In previous (XPG4-compliant) versions of the HP C RTL, `strptime` interpreted a two-digit year with no century specified as a year within the twentieth century.

The XPG5-compliant `strptime` is now the default version in the HP C RTL.

To obtain the old, XPG4-compliant `strptime` function behavior, specify one of the following:

- Define the `DECC$XPG4_STRPTIME` logical name as follows:

```
$ DEFINE DECC$XPG4_STRPTIME ENABLE
```

or:
- Call the XPG4 `strptime` directly as the function `decc$strptime_xpg4`.

To return to using the XPG5 `strptime` version, `DEASSIGN` the `DECC$XPG4_STRPTIME` logical name:

```
$ DEASSIGN DECC$XPG4_STRPTIME
```

Table REF–9 strptime Conversion Specifications

Specification	Replaced by
<code>%a</code>	The weekday name. This is either the abbreviated or the full name.
<code>%A</code>	Same as <code>%a</code> .
<code>%b</code>	The month name. This is either the abbreviated or the full name.
<code>%B</code>	Same as <code>%b</code> .
<code>%c</code>	The date and time using the locale's date format.
<code>%Ec</code>	The locale's alternative date and time representation.

(continued on next page)

Table REF–9 (Cont.) strptime Conversion Specifications

Specification	Replaced by
%C	The century number (the year divided by 100 and truncated to an integer) as a decimal number (00 – 99). Leading zeros are permitted.
%EC	The name of the base year (period) in the locale’s alternative representation.
%d	The day of the month as a decimal number (01 – 31). Leading zeros are permitted.
%Od	The day of the month using the locale’s alternative numeric symbols.
%D	Same as %m/%d/%y.
%e	Same as %d.
%Oe	The date of the month using the locale’s alternative numeric symbols.
%h	Same as %b.
%H	The hour (24-hour clock) as a decimal number (00 – 23). Leading zeros are permitted.
%OH	The hour (24-hour clock) using the locale’s alternative numeric symbols.
%I	The hour (12-hour clock) as a decimal number (01 – 12). Leading zeros are permitted.
%OI	The hour (12-hour clock) using the locale’s alternative numeric symbols.
%j	The day of the year as a decimal number (001 – 366).
%m	The month as a decimal number (01 – 12). Leading zeros are permitted.
%Om	The month using the locale’s alternative numeric symbols.
%M	The minute as a decimal number (00 – 59). Leading zeros are permitted.
%OM	The minutes using the locale’s alternative numeric symbols.
%n	Any white-space character.
%p	The locale’s equivalent of the AM/PM designations associated with a 12-hour clock.
%r	The time in AM/PM notation (%I:%M:%S %p).
%R	The time in 24-hour notation (%H:%M).
%S	The second as a decimal number (00 – 61). Leading zeros are permitted.
%OS	The seconds using the locale’s alternative numeric symbols.
%t	Any white-space character.
%T	The time (%H:%M:%S).

(continued on next page)

strptime

Table REF–9 (Cont.) strptime Conversion Specifications

Specification	Replaced by
%U	The week number of the year (the first Sunday as the first day of week 1) as a decimal number (00 – 53). Leading zeros are permitted.
%OU	The week number of the year (Sunday as the first day of the week) using the locale’s alternative numeric symbols.
%w	The weekday as a decimal number (0 [Sunday] – 6). Leading zeros are permitted.
%Ow	The weekday as a number (Sunday=0) using the locale’s alternative numeric symbols.
%W	The week number of the year (the first Monday as the first day of week 1) as a decimal number (00 – 53). Leading zeros are permitted.
%OW	The week number of the year (Monday as the first day of the week) using the locale’s alternative numeric symbols.
%x	The locale’s appropriate date representation.
%Ex	The locale’s alternative date representation.
%EX	The locale’s alternative time representation.
%X	The locale’s appropriate time representation.
%y	The year without century as a decimal number (00 – 99).
%Ey	The offset from the base year (%EC) in the locale’s alternative representation.
%Oy	The year without the century using the locale’s alternative numeric symbols.
%Y	The year with century as a decimal number.
%EY	The locale’s full alternative year representation.
%%	Literal % character.

Return Values

x	A pointer to the character following the last character parsed.
NULL	Indicates that an error occurred. The contents of the tm structure are undefined.

Example

```
#include <string.h>
#include <stdlib.h>
#include <stdio.h>
#include <time.h>
#include <locale.h>
#include <errno.h>

#define NUM_OF_DATES 7
#define BUF_SIZE 256
```



```

/* This program takes a number of date and time strings and */
/* converts them into tm structs using strptime(). These tm */
/* structs are then passed to strftime() which will reverse the */
/* process. The resulting strings are then compared with the */
/* originals and if a difference is found then an error is */
/* displayed. */

main()
{
    int count,
        i;
    char buffer[BUF_SIZE];
    char *ret_val;
    struct tm time_struct;
    char dates[NUM_OF_DATES][BUF_SIZE] =
    {
        "Thursday 01 January 1970 00:08:20",
        "Tuesday 29 February 1972 08:26:40",
        "Tuesday 31 December 1991 23:59:59",
        "Wednesday 01 January 1992 00:00:00",
        "Sunday 03 May 1992 13:33:20",
        "Monday 04 May 1992 17:20:00",
        "Friday 15 May 1992 03:20:00";

    for (i = 0; i < NUM_OF_DATES; i++) {
        /* Convert to a tm structure */
        ret_val = strptime(dates[i], "%A %d %B %Y %T", &time_struct);

        /* Check the return value */
        if (ret_val == (char *) NULL) {
            perror("strptime");
            exit(EXIT_FAILURE);
        }

        /* Convert the time structure back to a formatted string */
        count = strftime(buffer, BUF_SIZE, "%A %d %B %Y %T",&time_struct);

        /* Check the return value */
        if (count == 0) {
            perror("strftime");
            exit(EXIT_FAILURE);
        }

        /* Check the result */
        if (strcmp(buffer, dates[i]) != 0) {
            printf("Error: Converted string differs from the original\n");
        }
        else {
            printf("Successfully converted <%s>\n", dates[i]);
        }
    }
}

```

Running the example program produces the following result:

```

Successfully converted <Thursday 01 January 1970 00:08:20>
Successfully converted <Tuesday 29 February 1972 08:26:40>
Successfully converted <Tuesday 31 December 1991 23:59:59>
Successfully converted <Wednesday 01 January 1992 00:00:00>
Successfully converted <Sunday 03 May 1992 13:33:20>
Successfully converted <Monday 04 May 1992 17:20:00>
Successfully converted <Friday 15 May 1992 03:20:00>

```

strchr

strchr

Returns the address of the last occurrence of a given character in a null-terminated string.

Format

```
#include <string.h>
char *strchr (const char *str, int character);
```

Function Variants

The `strchr` function has variants named `_strchr32` and `_strchr64` for use with 32-bit and 64-bit pointer sizes, respectively. See Section 1.9 for more information on using pointer-size-specific functions.

Arguments

str
A pointer to a null-terminated character string.

character
An object of type `int`.

Description

This function returns the address of the *last* occurrence of a given character in a null-terminated string. The terminating null character is considered to be part of the string.

Compare with `strchr`, which returns the address of the *first* occurrence of a given character in a null-terminated string.

Return Values

x	The address of the last occurrence of the specified character.
NULL	Indicates that the character does not occur in the string.

strsep

Separates strings.

Format

```
#include <string.h>
char *strsep (char **stringp, char *delim);
```

Function Variants

The `strsep` function has variants named `_strsep32` and `_strsep64` for use with 32-bit and 64-bit pointer sizes, respectively. See Section 1.9 for more information on using pointer-size-specific functions.

Arguments

stringp

A pointer to a pointer to a character string.

delim

A pointer to a string containing characters to be used as delimiters.

Description

The `strsep` function locates in *stringp*, the first occurrence of any character in *delim* (or the terminating `'\0'` character) and replaces it with a `'\0'`. The location of the next character after the delimiter character (or `NULL`, if the end of the string is reached) is stored in the *stringp* argument. The original value of the *stringp* argument is returned.

You can detect an "empty" field; one caused by two adjacent delimiter characters, by comparing the location referenced by the pointer returned in the *stringp* argument to `'\0'`.

The *stringp* argument is initially `NULL`, `strsep` returns `NULL`.

Return Values

<code>x</code>	The address of the string pointed to by <i>stringp</i> .
<code>NULL</code>	Indicates that <i>stringp</i> is <code>NULL</code> .

Example

The following example uses `strsep` to parse a string, containing token delimited by white space, into an argument vector:

```
char **ap, **argv[10], *inputstring;
for (ap = argv; (*ap = strsep(&inputstring, " \t")) != NULL;)
    if (**ap != '\0')
        ++ap;
```

strspn

strspn

Returns the length of the prefix of a string that consists entirely of characters from a set of characters.

Format

```
#include <string.h>
size_t strspn (const char *str, const char *charset);
```

Arguments

str

A pointer to a character string. If this string is a null string, 0 is returned.

charset

A pointer to a character string containing the characters for which the function will search.

Description

The `strspn` function scans the characters in the string, stops when it encounters a character not found in *charset*, and returns the length of the string's initial segment formed by characters found in *charset*.

Return Value

x	The length of the segment.
---	----------------------------

strstr

Locates the first occurrence in the string pointed to by *s1* of the sequence of characters in the string pointed to by *s2*.

Format

```
#include <string.h>

char *strstr (const char *s1, const char *s2);
```

Function Variants

The `strstr` function has variants named `_strstr32` and `_strstr64` for use with 32-bit and 64-bit pointer sizes, respectively. See Section 1.9 for more information on using pointer-size-specific functions.

Arguments

s1, s2
Pointers to character strings.

Return Values

Pointer	A pointer to the located string.
NULL	Indicates that the string was not found.

Example

```
#include <stdlib.h>
#include <stdio.h>
#include <string.h>

main()
{
    static char lookin[]="that this is a test was at the end";
    putchar('\n');
    printf("String: %s\n", &lookin[0] );
    putchar('\n');
    printf("Addr: %s\n", &lookin[0] );
    printf("this: %s\n", strstr( &lookin[0] ,"this" ) );
    printf("that: %s\n", strstr( &lookin[0] ,"that" ) );
    printf("NULL: %s\n", strstr( &lookin[0] ,"" ) );
    printf("was: %s\n", strstr( &lookin[0] ,"was" ) );
    printf("at: %s\n", strstr( &lookin[0] ,"at" ) );
    printf("the end: %s\n", strstr( &lookin[0] ,"the end" ) );
    putchar('\n');
    exit(0);
}
```

This example produces the following results:

strstr

```
$ RUN STRSTR EXAMPLE
String: that this is a test was at the end
Addr: that this is a test was at the end
this: this is a test was at the end
that: that this is a test was at the end
NULL: that this is a test was at the end
was: was at the end
at: at this is a test was at the end
the end: the end
$
```

strtod

Converts a given string to a double-precision number.

Format

```
#include <stdlib.h>

double strtod (const char *nptr, char **endptr);
```

Function Variants

The `strtod` function has variants named `_strtod32` and `_strtod64` for use with 32-bit and 64-bit pointer sizes, respectively. See Section 1.9 for more information on using pointer-size-specific functions.

Arguments

nptr

A pointer to the character string to be converted to a double-precision number.

endptr

The address of an object where the function can store the address of the first unrecognized character that terminates the scan. If `endptr` is a NULL pointer, the address of the first unrecognized character is not retained.

Description

The `strtod` function recognizes an optional sequence of white-space characters (as defined by `isspace`), then an optional plus or minus sign, then a sequence of digits optionally containing a radix character, then an optional letter (e or E) followed by an optionally signed integer. The first unrecognized character ends the conversion.

The string is interpreted by the same rules used to interpret floating constants.

The radix character is defined the program's current locale (category `LC_NUMERIC`).

This function returns the converted value. For `strtod`, overflows are accounted for in the following manner:

- If the correct value causes an overflow, `HUGE_VAL` (with a plus or minus sign according to the sign of the value) is returned and `errno` is set to `ERANGE`.
- If the correct value causes an underflow, 0 is returned and `errno` is set to `ERANGE`.

If the string starts with an unrecognized character, then the conversion is not performed, `*endptr` is set to `nptr`, a 0 value is returned, and `errno` is set to `EINVAL`.)

strtod

Return Values

x	The converted string.
0	Indicates the conversion could not be performed. <code>errno</code> is set to one of the following: <ul style="list-style-type: none">• <code>EINVAL</code> - No conversion could be performed.• <code>ERANGE</code> - The value would cause an underflow.• <code>ENOMEM</code> - Not enough memory available for internal conversion buffer.
\pm HUGE_VAL	Overflow occurred; <code>errno</code> is set to <code>ERANGE</code> .

strtok, strtok_r

Split strings into tokens.

Format

```
#include <string.h>

char *strtok (char *s1, const char *s2);
char *strtok_r (char *s, const char *sep, char **lasts);
```

Function Variants

The `strtok` function has variants named `_strtok32` and `_strtok64` for use with 32-bit and 64-bit pointer sizes, respectively. Likewise, the `strtok_r` function has variants named `_strtok_r32` and `_strtok_r64`. See Section 1.9 for more information on using pointer-size-specific functions.

Arguments

s1

On the first call, a pointer to a string containing zero or more text tokens. On all subsequent calls for that string, a NULL pointer.

s2

A pointer to a separator string consisting of one or more characters. The separator string may differ from call to call.

s

A null-terminated string that is a sequence of zero or more text tokens separated by spans of one or more characters from the separator string *sep*.

sep

A null-terminated string of separator characters. This separator string can be different from call to call.

lasts

A pointer that points to a user-provided pointer to stored information needed for `strtok_r` to continue scanning the same string.

Description

The `strtok` function locates text tokens in a given string. The text tokens are delimited by one or more characters from a separator string that you specify. The function keeps track of its position in the string between calls and, as successive calls are made, the function works through the string, identifying the text token following the one identified by the previous call.

A token in *s1* starts at the first character that is not a character in the separator string *s2* and ends either at the end of the string or at (but not including) a separator character.

The first call to the `strtok` function returns a pointer to the first character in the first token and writes a null character into *s1* immediately following the returned token. Each subsequent call (with the value of the first argument remaining NULL) returns a pointer to a subsequent token in the string originally pointed

strtok, strtok_r

to by *s1*. When no tokens remain in the string, the `strtok` function returns a NULL pointer. (This can occur on the first call to `strtok` if the string is empty or contains only separator characters.)

Since `strtok` inserts null characters into *s1* to delimit tokens, *s1* cannot be a const object.

The `strtok_r` function is the reentrant version of `strtok`. The function `strtok_r` considers the null-terminated string *s* as a sequence of zero or more text tokens separated by spans of one or more characters from the separator string *sep*. The *lasts* argument points to a user-provided pointer to stored information needed for `strtok_r` to continue scanning the same string.

In the first call to `strtok_r`, *s* points to a null-terminated string, *sep* points to a null-terminated string of separator characters, and the value pointed to by *lasts* is ignored. The `strtok_r` function returns a pointer to the first character of the first token, writes a null character into *s* immediately following the returned token, and updates the pointer to which *lasts* points.

In subsequent calls, *s* is a NULL pointer and *lasts* is unchanged from the previous call so that subsequent calls move through the string *s*, returning successive tokens until no tokens remain. The separator string *sep* can be different from call to call. When no token remains in *s*, a NULL pointer is returned.

Return Values

x	A pointer to the first character of the parsed token in the string.
NULL	Indicates that there are no tokens remaining in the string.

Examples

```
1. #include <stdio.h>
   #include <string.h>

   main()
   {
       static char str[] = "...ab..cd,,ef.hi";

       printf("%s\n", strtok(str, "."));
       printf("%s\n", strtok(NULL, ","));
       printf("%s\n", strtok(NULL, ",."));
       printf("%s\n", strtok(NULL, ",."));
   }
```

Running this example program produces the following results:

```
$ RUN STRTOK_EXAMPLE1
|ab|
|.cd|
|ef|
|hi|
$
```

```
2. #include <stdio.h>
   #include <string.h>

   main()
   {
       char *ptr,
           string[30];

       /* The first character not in the string "-" is "A". The */
       /* token ends at "C." */
       strcpy(string, "ABC");
       ptr = strtok(string, "-");
       printf("|%s|\n", ptr);

       /* Returns NULL because no characters not in separator */
       /* string "-" were found (i.e. only separator characters */
       /* were found) */
       strcpy(string, "-");
       ptr = strtok(string, "-");
       if (ptr == NULL)
           printf("ptr is NULL\n");
   }
```

Running this example program produces the following results:

```
$ RUN STRTOK_EXAMPLE2
|abc|
ptr is NULL
$
```

strtol

strtol

Converts strings of ASCII characters to the appropriate numeric values.

Format

```
#include <stdlib.h>

long int strtol (const char *nptr, char **endptr, int base);
```

Function Variants

The `strtol` function has variants named `_strtol32` and `_strtol64` for use with 32-bit and 64-bit pointer sizes, respectively. See Section 1.9 for more information on using pointer-size-specific functions.

Arguments

nptr

A pointer to the character string to be converted to a long.

endptr

The address of an object where the function can store a pointer to the first unrecognized character encountered in the conversion process (that is, the character that follows the last character in the string being converted). If *endptr* is a NULL pointer, the address of the first unrecognized character is not retained.

base

The value, 2 through 36, to use as the base for the conversion.

Description

The `strtol` function recognizes strings in various formats, depending on the value of the base. This function ignores any leading white-space characters (as defined by `isspace` in `<ctype.h>`) in the given string. It recognizes an optional plus or minus sign, then a sequence of digits or letters that may represent an integer constant according to the value of the base. The first unrecognized character ends the conversion.

Leading zeros after the optional sign are ignored, and `0x` or `0X` is ignored if the base is 16.

If *base* is 0, the sequence of characters is interpreted by the same rules used to interpret an integer constant: after the optional sign, a leading 0 indicates octal conversion, a leading `0x` or `0X` indicates hexadecimal conversion, and any other combination of leading characters indicates decimal conversion.

Truncation from long to int can take place after assignment or by an explicit cast (arithmetic exceptions notwithstanding). The function call `atoi(str)` is equivalent to `strtol(str, (char**)NULL, 10)`.

Return Values

x	The converted value.
LONG_MAX or LONG_MIN	Indicates that the converted value would cause an overflow.
0	Indicates that the string starts with an unrecognized character or that the value for <i>base</i> is invalid. If the string starts with an unrecognized character, <i>*endptr</i> is set to <i>nptr</i> .

strtouq, strtoll *(Integrity servers, Alpha)*

strtouq, strtoll *(Integrity servers, Alpha)*

Convert strings of ASCII characters to the appropriate numeric values. `strtoll` is a synonym for `strtouq`.

Format

```
#include <stdlib.h>
__int64 strtouq (const char *nptr, char **endptr, int base);
__int64 strtoll (const char *nptr, char **endptr, int base);
```

Function Variants

These functions have variants named `_strtouq32`, `_strtoll32` and `_strtouq64`, `_strtoll64` for use with 32-bit and 64-bit pointer sizes, respectively. See Section 1.9 for more information on using pointer-size-specific functions.

Arguments

nptr

A pointer to the character string to be converted to an `__int64`.

endptr

The address of an object where the function can store a pointer to the first unrecognized character encountered in the conversion process (that is, the character that follows the last character in the string being converted). If `endptr` is a NULL pointer, the address of the first unrecognized character is not retained.

base

The value, 2 through 36, to use as the base for the conversion.

Description

The `strtouq` and `strtoll` functions recognize strings in various formats, depending on the value of the base. Any leading white-space characters (as defined by `isspace` in `<ctype.h>`) in the given string are ignored. The functions recognize an optional plus or minus sign, then a sequence of digits or letters that may represent an integer constant according to the value of the base. The first unrecognized character ends the conversion.

Leading zeros after the optional sign are ignored, and `0x` or `0X` is ignored if the base is 16.

If `base` is 0, the sequence of characters is interpreted by the same rules used to interpret an integer constant: after the optional sign, a leading 0 indicates octal conversion, a leading `0x` or `0X` indicates hexadecimal conversion, and any other combination of leading characters indicates decimal conversion.

The function call `atouq (str)` is equivalent to `strtouq (str, (char**)NULL, 10)`.

Return Values

x	The converted value.
__INT64_MAX or __INT64_MIN	Indicates that the converted value would cause an overflow.
0	Indicates that the string starts with an unrecognized character or that the value for <i>base</i> is invalid. If the string starts with an unrecognized character, <i>*endptr</i> is set to <i>nptr</i> .

strtoul

strtoul

Converts the initial portion of the string pointed to by *nptr* to an unsigned long integer.

Format

```
#include <stdlib.h>
```

```
unsigned long int strtoul (const char *nptr, char **endptr, int base);
```

Function Variants

The `strtoul` function has variants named `_strtoul32` and `_strtoul64` for use with 32-bit and 64-bit pointer sizes, respectively. See Section 1.9 for more information on using pointer-size-specific functions.

Arguments

nptr

A pointer to the character string to be converted to an unsigned long.

endptr

The address of an object where the function can store a pointer to a pointer to the first unrecognized character encountered in the conversion process (that is, the character that follows the last character in the string being converted). If *endptr* is a NULL pointer, the address of the first unrecognized character is not retained.

base

The value, 2 through 36, to use as the base for the conversion. Leading zeros after the optional sign are ignored, and 0x or 0X is ignored if the base is 16.

If the base is 0, the sequence of characters is interpreted by the same rules used to interpret an integer constant: after the optional sign, a leading 0 indicates octal conversion, a leading 0x or 0X indicates hexadecimal conversion, and any other combination of leading characters indicates decimal conversion.

Return Values

x	The converted value.
0	Indicates that the string starts with an unrecognized character or that the value for <i>base</i> is invalid. If the string starts with an unrecognized character, <i>*endptr</i> is set to <i>nptr</i> .
ULONG_MAX	Indicates that the converted value would cause an overflow.

strtoq, strtoull *(Integrity servers, Alpha)*

Convert the initial portion of the string pointed to by *nptr* to an unsigned `__int64` integer. `strtoull` is a synonym for `strtoq`.

Format

```
#include <stdlib.h>

unsigned __int64 strtoq (const char *nptr, char **endptr, int base);
unsigned __int64 strtoull (const char *nptr, char **endptr, int base);
```

Function Variants

These functions have variants named `_strtoq32`, `_strtoull32` and `_strtoq64`, `_strtoull64` for use with 32-bit and 64-bit pointer sizes, respectively. See Section 1.9 for more information on using pointer-size-specific functions.

Arguments**nptr**

A pointer to the character string to be converted to an unsigned `__int64`.

endptr

The address of an object where the function can store a pointer to a pointer to the first unrecognized character encountered in the conversion process (that is, the character that follows the last character in the string being converted). If *endptr* is a NULL pointer, the address of the first unrecognized character is not retained.

base

The value, 2 through 36, to use as the base for the conversion. Leading zeros after the optional sign are ignored, and 0x or 0X is ignored if the base is 16.

If the base is 0, the sequence of characters is interpreted by the same rules used to interpret an integer constant: after the optional sign, a leading 0 indicates octal conversion, a leading 0x or 0X indicates hexadecimal conversion, and any other combination of leading characters indicates decimal conversion.

Return Values

x	The converted value.
0	Indicates that the string starts with an unrecognized character or that the value for <i>base</i> is invalid. If the string starts with an unrecognized character, <i>*endptr</i> is set to <i>nptr</i> .
<code>__UINT64_MAX</code>	Indicates that the converted value would cause an overflow.

strxfrm

strxfrm

Changes a string such that the changed string can be passed to the `strcmp` function, and produce the same result as passing the unchanged string to the `strcoll` function.

Format

```
#include <string.h>

size_t strxfrm (char *s1, const char *s2, size_t maxchar);
```

Arguments

s1, s2

Pointers to character strings.

maxchar

The maximum number of bytes (including the null terminator) to be stored in *s1*.

Description

The *strxfrm* function transforms the string pointed to by *s2*, and stores the resulting string in the array pointed to by *s1*. No more than *maxchar* bytes, including the null terminator, are placed into the array pointed to by *s1*.

If the value of *maxchar* is less than the required size to store the transformed string (including the terminating null), the contents of the array pointed to by *s1* is indeterminate. In such a case, the function returns the size of the transformed string.

If *maxchar* is 0, then *s1* is allowed to be a NULL pointer, and the function returns the required size of the *s1* array before making the transformation.

The string comparison functions, `strcoll` and `strcmp`, can produce different results given the same two strings to compare. The reason for this is that `strcmp` does a straightforward comparison of the code point values of the characters in the strings, whereas `strcoll` uses the locale information to do the comparison. Depending on the locale, the `strcoll` comparison can be a multipass operation, which is slower than `strcmp`.

The purpose of the `strxfrm` function is to transform strings in such a way that if you pass two transformed strings to the `strcmp` function, the result is the same as passing the two original strings to the `strcoll` function. The `strxfrm` function is useful in applications that need to do a large number of comparisons on the same strings using `strcoll`. In this case, it might be more efficient (depending on the locale) to transform the strings once using `strxfrm`, and then do comparisons using `strcmp`.

Return Value

x Length of the resulting string pointed to by *s1*, not including the terminating null character. No return value is reserved for error indication. However, the function can set `errno` to `EINVAL` – The string pointed to by *s2* contains characters outside the domain of the collating sequence.

Example

```

/* This program verifies that two transformed strings when      */
/* passed through strxfrm and then compared, provide the same  */
/* result as if passed through strcoll without any             */
/* transformation.                                           */

#include <string.h>
#include <stdio.h>
#include <stdlib.h>
#include <locale.h>

#define BUFF_SIZE 256

main()
{
    char string1[BUFF_SIZE];
    char string2[BUFF_SIZE];
    int errno;
    int coll_result;
    int strcmp_result;
    size_t strxfrm_result1;
    size_t strxfrm_result2;

    /* setlocale to French locale */

    if (setlocale(LC_ALL, "fr_FR.ISO8859-1") == NULL) {
        perror("setlocale");
        exit(EXIT_FAILURE);
    }

    /* collate string 1 and string 2 and store the result */

    errno = 0;
    coll_result = strcoll("<a'>bcd", "abcz");
    if (errno) {
        perror("strcoll");
        exit(EXIT_FAILURE);
    }

    else {
        /* Transform the strings (using strxfrm) into string1  */
        /* and string2                                          */

        strxfrm_result1 = strxfrm(string1, "<a'>bcd", BUFF_SIZE);

        if (strxfrm_result1 == ((size_t) - 1)) {
            perror("strxfrm");
            exit(EXIT_FAILURE);
        }

        else if (strxfrm_result1 > BUFF_SIZE) {
            perror("\n** String is too long **\n");
            exit(EXIT_FAILURE);
        }
    }
}

```

strxfrm

```
else {
    strxfrm_result2 = strxfrm(string2, "abcz", BUFF_SIZE);
    if (strxfrm_result2 == ((size_t) - 1)) {
        perror("strxfrm");
        exit(EXIT_FAILURE);
    }
    else if (strxfrm_result2 > BUFF_SIZE) {
        perror("\n** String is too long **\n");
        exit(EXIT_FAILURE);
    }
    /* Compare the two transformed strings and verify */
    /* that the result is the same as the result from */
    /* strcoll on the original strings */
    else {
        strcmp_result = strcmp(string1, string2);
        if (strcmp_result == 0 && (coll_result == 0)) {
            printf("\nReturn value from strcoll() and "
                "return value from strcmp() are both zero.");
            printf("\nThe program was successful\n\n");
        }
        else if ((strcmp_result < 0) && (coll_result < 0)) {
            printf("\nReturn value from strcoll() and "
                "return value from strcmp() are less than zero.");
            printf("\nThe program successful\n\n");
        }
        else if ((strcmp_result > 0) && (coll_result > 0)) {
            printf("\nReturn value from strcoll() and "
                "return value from strcmp() are greater than zero.");
            printf("\nThe program was successful\n\n");
        }
        else {
            printf("** Error **\n");
            printf("\nReturn values are not of the same type");
        }
    }
}
}
```

Running the example program produces the following result:

```
Return value from strcoll() and return value
        from strcmp() are less than zero.
The program was successful
```

subwin

Creates a new subwindow with *numlines* lines and *numcols* columns starting at the coordinates (*begin_y*,*begin_x*) on the terminal screen.

Format

```
#include <curses.h>

WINDOW *subwin (WINDOW *win, int numlines, int numcols, int begin_y, int begin_x);
```

Arguments

win

A pointer to the parent window.

numlines

The number of lines in the subwindow. If *numlines* is 0, then the function sets that dimension to `LINES - begin_y`. To get a subwindow of dimensions `LINES` by `COLS`, use the following format:

```
subwin (win, 0, 0, 0, 0)
```

numcols

The number of columns in the subwindow. If *numcols* is 0, then the function sets that dimension to `COLS - begin_x`. To get a subwindow of dimensions `LINES` by `COLS`, use the following format:

```
subwin (win, 0, 0, 0, 0)
```

begin_y

A window coordinate at which the subwindow is to be created.

begin_x

A window coordinate at which the subwindow is to be created.

Description

When creating the subwindow, *begin_y* and *begin_x* are relative to the entire terminal screen. If either *numlines* or *numcols* is 0, then the subwin function sets that dimension to `(LINES - begin_y)` or `(COLS - begin_x)`, respectively.

The window pointed to by *win* must be large enough to contain the entire area of the subwindow. Any changes made to either window within the coordinates of the subwindow appear on both windows.

Return Values

window pointer	A pointer to an instance of the structure window corresponding to the newly created subwindow.
ERR	Indicates an error.

swab

swab

Swaps bytes.

Format

```
#include <unistd.h>
void swab (const void *src, void *dest, ssize_t nbytes);
```

Arguments

src

A pointer to the location of the string to copy.

dest

A pointer to where you want the results copied.

nbytes

The number of bytes to copy. Make this argument an even value. When it is an odd value, the swab function uses $nbytes - 1$ instead.

Description

The swab function copies the number of bytes specified by *nbytes* from the location pointed to by *src* to the array pointed to by *dest*. The function then exchanges adjacent bytes. If a copy takes place between objects that overlap, the result is undefined.

swprintf

Writes output to an array of wide characters under control of the wide-character format string.

Format

```
#include <wchar.h>

int swprintf (wchar_t *s, size_t n, const wchar_t *format, ... );
```

Arguments

s

A pointer to the resulting wide-character sequence.

n

The maximum number of wide characters that can be written to an array pointed to by *s*, including a terminating null wide character.

format

A pointer to a wide-character string containing the format specifications. For more information about format and conversion specifications and their corresponding arguments, see Chapter 2.

...

Optional expressions whose resultant types correspond to conversion specifications given in the format specification.

If no conversion specifications are given, the output sources can be omitted. Otherwise, the function calls must have exactly as many output sources as there are conversion specifications, and the conversion specifications must match the types of the output sources.

Conversion specifications are matched to output sources in left-to-right order. Excess output pointers, if any, are ignored.

Description

The `swprintf` function is equivalent to the `fwprintf` function, except that the first argument specifies an array of wide characters instead of a stream.

No more than *n* wide characters are written, including a terminating null wide character, which is always added (unless *n* is 0).

See also `fwprintf`.

Return Values

x	The number of wide characters written, not counting the terminating null wide character.
Negative value	Indicates an error. Either <i>n</i> or more wide characters were requested to be written, or a conversion error occurred, in which case <code>errno</code> is set to <code>EILSEQ</code> .

swscanf

Reads input from a wide-character string under control of the wide-character format string.

Format

```
#include <wchar.h>

int swscanf (const wchar_t *s, const wchar_t *format, ... );
```

Arguments

s

A pointer to a wide-character string from which the input is to be obtained.

format

A pointer to a wide-character string containing the format specifications. For more information about format and conversion specifications and their corresponding arguments, see Chapter 2.

...

Optional expressions whose results correspond to conversion specifications given in the format specification.

If no conversion specifications are given, you can omit the input pointers. Otherwise, the function calls must have exactly as many input pointers as there are conversion specifications, and the conversion specifications must match the types of the input pointers.

Conversion specifications are matched to input sources in left-to-right order. Excess input pointers, if any, are ignored.

Description

The `swscanf` function is equivalent to the `fwscanf` function, except that the first argument specifies a wide-character string rather than a stream. Reaching the end of the wide-character string is the same as encountering EOF for the `fwscanf` function.

See also `fwscanf`.

Return Values

x	The number of input items assigned, sometimes fewer than provided for, or even 0 in the event of an early matching failure.
EOF	Indicates an error. An input failure occurred before any conversion.

symlink *(Integrity servers, Alpha)*

Creates a symbolic link containing the specified contents.

Format

```
#include <unistd.h>
int symlink (const char *link_contents, const char *link_name);
```

Arguments**link_contents**

Contents of the symbolic link file, specified as a text string representing the pathname to which the symbolic link will point.

link_name

The text string representing the name of the symbolic link file.

Description

A symbolic link is a special kind of file that points to another file. It is a directory entry that associates a filename with a text string that is interpreted as a POSIX pathname when accessed by certain services. A symbolic link is implemented on OpenVMS systems as a file of organization SPECIAL and type SYMBOLIC_LINK.

The `symlink` function creates a symbolic link (*link_name*) containing the specified contents (*link_contents*). No attempt is made at link creation time to interpret the symbolic link contents.

See also `readlink`, `unlink`, `realpath`, `lchown`, and `lstat`.

Return Values

0	Successful completion
---	-----------------------

– 1

Indicates an error. `errno` is set to indicate the error:

- `EACCES` – Write permission is denied in the directory where the symbolic link is being created, or search permission is denied for a component of the path prefix of *link_name*.
- `EEXIST` – The *link_name* argument names an existing file or symbolic link.
- `ENAMETOOLONG` – The length of the *link_name* argument exceeds `PATH_MAX`, or a pathname component is longer than `NAME_MAX`, or the length of the *link_contents* argument is longer than `SYMLINK_MAX`.
- `ENOSPC` – The directory in which the entry for the new symbolic link is being placed cannot be extended because no space is left on the file system containing the directory, or the new symbolic link cannot be created because no space is left on the file system that would contain the link, or the file system is out of file-allocation resources.
- Any `errno` value from `creat`, `fsync`, `lstat`, or `write`.

sysconf

Gets configurable system variables.

Format

```
#include <unistd.h>
long int sysconf (int name);
```

Argument

name
Specifies the system variable to be queried.

Description

The `sysconf` function provides a method for determining the current value of a configurable system limit or whether optional features are supported.

You supply a symbolic constant in the *name* argument, and `sysconf` returns a value for the corresponding system variable:

- The symbolic constants defined in the `<unistd.h>` header file.
- The system variables are defined in the `<limits.h>` and `<unistd.h>` header files.

Table REF–10 lists the system variables returned by the `sysconf` function, and the symbolic constants that you can supply as the *name* value.

Table REF–10 sysconf Argument and Return Values

System Variable Returned	Symbolic Constant for <i>name</i>	Meaning
ISO POSIX-1		
ARG_MAX	_SC_ARG_MAX	The maximum length, in bytes, of the arguments for one of the <code>exec</code> functions, including environment data.
CHILD_MAX	_SC_CHILD_MAX	The maximum number of simultaneous processes for each real user ID.
CLK_TCK	_SC_CLK_TCK	The number of clock ticks per second. The value of <code>CLK_TCK</code> can be variable. Do not assume that <code>CLK_TCK</code> is a compile-time constant.
NGROUPS_MAX	_SC_NGROUPS_MAX	The maximum number of simultaneous supplementary group IDs for each process.
OPEN_MAX	_SC_OPEN_MAX	The maximum number of files that one process can have open at one time.

(continued on next page)

sysconf

Table REF–10 (Cont.) sysconf Argument and Return Values

System Variable Returned	Symbolic Constant for <i>name</i>	Meaning
ISO POSIX-1		
STREAM_MAX	_SC_STREAM_MAX	The number of streams that one process can have open at one time.
TZNAME_MAX	_SC_TZNAME_MAX	The maximum number of bytes supported for the name of a time zone (not the length of the TZ environmental variable).
_POSIX_JOB_CONTROL	_SC_JOB_CONTROL	This variable has a value of 1 if the system supports job control; otherwise, –1 is returned.
_POSIX_SAVED_IDS	_SC_SAVED_IDS	This variable has a value of 1 if each process has a saved set user ID and a saved set group ID; otherwise, –1 is returned.
_POSIX_VERSION	_SC_VERSION	The date of approval of the most current version of the POSIX-1 standard that the system supports. The date is a 6-digit number, with the first 4 digits signifying the year and the last 2 digits the month. If _POSIX_VERSION is not defined, –1 is returned. Different versions of the POSIX-1 standard are periodically approved by the IEEE Standards Board, and the date of approval is used to distinguish between different versions.
ISO POSIX-2		
BC_BASE_MAX	_SC_BC_BASE_MAX	The maximum value allowed for the obase variable with the bc command.
BC_DIM_MAX	_SC_BC_DIM_MAX	The maximum number of elements permitted in an array by the bc command.
BC_SCALE_MAX	_SC_BC_SCALE_MAX	The maximum value allowed for the scale variable with the bc command.
BC_STRING_MAX	_SC_BC_STRING_MAX	The maximum length of string constants accepted by the bc command.
COLL_WEIGHTS_MAX	_SC_COLL_WEIGHTS_MAX	The maximum number of weights that can be assigned to an entry in the LC_COLLATE locale-dependent information in a locale definition file.

(continued on next page)

Table REF-10 (Cont.) sysconf Argument and Return Values

System Variable Returned	Symbolic Constant for <i>name</i>	Meaning
ISO POSIX-2		
EXPR_NEST_MAX	_SC_EXPR_NEST_MAX	The maximum number of expressions that you can nest within parentheses by the <code>expr</code> command.
LINE_MAX	_SC_LINE_MAX	The maximum length, in bytes, of a command input line (either standard input or another file) when the utility is described as processing text files. The length includes room for the trailing new-line character.
RE_DUP_MAX	_SC_RE_DUP_MAX	The maximum number of repeated occurrences of a regular expression permitted when using the interval notation arguments, such as the <i>m</i> and <i>n</i> arguments with the <code>ed</code> command.
_POSIX2_CHAR_TERM	_SC_2_CHAR_TERM	This variable has a value of 1 if the system supports at least one terminal type; otherwise, -1 is returned.
_POSIX2_C_BIND	_SC_2_C_BIND	This variable has a value of 1 if the system supports the C language binding option; otherwise, -1 is returned.
_POSIX2_C_DEV	_SC_2_C_DEV	This variable has a value of 1 if the system supports the optional C Language Development Utilities from the ISO POSIX-2 standard; otherwise, -1 is returned.
_POSIX2_C_VERSION	_SC_2_C_VERSION	Integer value indicating the version of the ISO POSIX-2 standard (C language binding). It changes with each new version of the ISO POSIX-2 standard.
_POSIX2_VERSION	_SC_2_VERSION	Integer value indicating the version of the ISO POSIX-2 standard (Commands). It changes with each new version of the ISO POSIX-2 standard.
_POSIX2_FORT_DEV	_SC_2_FORT_DEV	The variable has a value of 1 if the system supports the Fortran Development Utilities Option from the ISO POSIX-2 standard; otherwise, -1 is returned.
_POSIX2_FORT_RUN	_SC_2_FORT_RUN	The variable has a value of 1 if the system supports the Fortran Runtime Utilities Option from the ISO POSIX-2 standard; otherwise, -1 is returned.

(continued on next page)

sysconf

Table REF–10 (Cont.) sysconf Argument and Return Values

System Variable Returned	Symbolic Constant for <i>name</i>	Meaning
ISO POSIX-2		
<code>_POSIX2_LOCALEDEF</code>	<code>_SC_2_LOCALEDEF</code>	The variable has a value of 1 if the system supports the creation of new locales with the <code>localedef</code> command; otherwise, <code>-1</code> is returned.
<code>_POSIX2_SW_DEV</code>	<code>_SC_2_SW_DEV</code>	The variable has a value of 1 if the system supports the Software Development Utilities Option from the ISO POSIX-2 standard; otherwise, <code>-1</code> is returned.
<code>_POSIX2_UPE</code>	<code>_SC_2_UPE</code>	The variable has a value of 1 if the system supports the User Portability Utilities Option; otherwise, <code>-1</code> is returned.
POSIX 1003.1c-1995		
<code>_POSIX_THREADS</code>	<code>_SC_THREADS</code>	This variable has a value of 1 if the system supports POSIX threads; otherwise, <code>-1</code> is returned.
<code>_POSIX_THREAD_ATTR_STACKSIZE</code>	<code>_SC_THREAD_ATTR_STACKSIZE</code>	This variable has a value of 1 if the system supports the POSIX threads stack size attribute; otherwise, <code>-1</code> is returned.
<code>_POSIX_THREAD_PRIORITY_SCHEDULING</code>	<code>_SC_THREAD_PRIORITY_SCHEDULING</code>	The 1003.1c implementation supports the realtime scheduling functions.
<code>_POSIX_THREAD_SAFE_FUNCTIONS</code>	<code>_SC_THREAD_SAFE_FUNCTIONS</code>	TRUE if the implementation supports the thread-safe ANSI C functions in POSIX 1003.1c.
<code>PTHREAD_DESTRUCTOR_ITERATIONS</code>	<code>_SC_THREAD_DESTRUCTOR_ITERATIONS</code>	When a thread terminates, <code>DECthreads</code> iterates through all non-NULL thread-specific data values in the thread, and calls a registered destructor routine (if any) for each. It is possible for a destructor routine to create new values for one or more thread-specific data keys. In that case, <code>DECthreads</code> goes through the entire process again. <code>_SC_THREAD_DESTRUCTOR_ITERATIONS</code> is the maximum number of times the implementation loops before it terminates the thread even if there are still non-NULL values.

(continued on next page)

Table REF-10 (Cont.) sysconf Argument and Return Values

System Variable Returned	Symbolic Constant for <i>name</i>	Meaning
POSIX 1003.1c-1995		
PTHREAD_KEYS_MAX	_SC_THREAD_KEYS_MAX	The maximum number of thread-specific data keys that an application can create.
PTHREAD_STACK_MIN	_SC_THREAD_STACK_MIN	The minimum allowed size of a stack for a new thread. Any lower value specified for the "stacksize" thread attribute is rounded up.
UINT_MAX	_SC_THREAD_THREADS_MAX	The maximum number of threads an application is allowed to create. Since DECthreads does not enforce any fixed limit, this value is -1.
X/Open		
_XOPEN_VERSION	_SC_XOPEN_VERSION	An integer indicating the most current version of the X/Open standard that the system supports.
PASS_MAX	_SC_PASS_MAX	Maximum number of significant bytes in a password (not including terminating null).
XOPEN_CRYPT	_SC_XOPEN_CRYPT	This variable has a value of 1 if the system supports the X/Open Encryption Feature Group; otherwise, -1 is returned.
XOPEN_ENH_I18N	_SC_XOPEN_ENH_I18N	This variable has a value of 1 if the system supports the X/Open enhanced Internationalization Feature Group; otherwise, -1 is returned.
XOPEN_SHM	_SC_XOPEN_SHM	This variable has a value of 1 if the system supports the X/Open Shared Memory Feature Group; otherwise, -1 is returned.
X/Open Extended		
ATEXIT_MAX	_SC_ATEXIT_MAX	The maximum number of functions that you can register with atexit per process.
PAGESIZE	_SC_PAGESIZE	Size, in bytes, of a page.
PAGE_SIZE	_SC_PAGE_SIZE	Same as PAGESIZE. If either PAGESIZE or PAGE_SIZE is defined, the other is defined with the same value.

(continued on next page)

sysconf

Table REF–10 (Cont.) sysconf Argument and Return Values

System Variable Returned	Symbolic Constant for <i>name</i>	Meaning
X/Open Extended		
IOV_MAX	_SC_IOV_MAX	Maximum number of iovec structures that one process has available for use with readv or writev.
XOPEN_UNIX	_SC_XOPEN_UNIX	This variable has a value of 1 if the system supports the X/Open CAE Specification, August 1994, System Interfaces and Headers, Issue 4, Version 2, (ISBN: 1-85912-037-7, C435); otherwise, –1 is returned.
Other		
N/A	_SC_CPU_CHIP_TYPE	Returns information for the processor type. See the description after this table.

For the _SC_CPU_CHIP_TYPE symbolic constant:

- On Alpha servers, sysconf returns the architecture type (2), as given by the \$GETSYI system service.
- Integrity processor information is stored in CPUID register 3. This register contains a 64-bit integer divided into 1-byte fields indicating version information related to the processor implementation. The sysconf function returns the low-order longword with the following information:

```

31      24 23      16 15      8 7      0
-----
| family | model | rev | number|
-----

```

These fields are described in the following table:

Field	Bits	Description
number	7:0	Index of the largest implemented CPUID register (one less than the number of implemented CPUID registers). This value will be at least 4.
rev	15:8	Processor revision number. An 8-bit value that represents the revision or stepping of this processor implementation within the processor model.
model	23:16	Processor model number. A unique 8-bit value representing the processor model within the processor family.
family	31:24	Processor family number. A unique 8-bit value representing the processor family.

Return Values

x

The current variable value on the system. The value does not change during the lifetime of the calling process.

-1

Indicates an error.

If the value of the *name* argument is invalid, `errno` is set to indicate the error.

If the value of the *name* argument is undefined, `errno` is unchanged.

system

system

Passes a given string to the host environment to be executed by a command processor. This function is nonreentrant.

Format

```
#include <stdlib.h>

int system (const char *string);
```

Argument

string

A pointer to the string to be executed. If *string* is NULL, a nonzero value is returned. The string is a DCL command, not the name of an image. To execute an image, use one of the exec routines.

Description

The system function spawns a subprocess and executes the command specified by *string* in that subprocess. The system function waits for the subprocess to complete before returning the subprocess status as the return value of the function.

The subprocess is spawned within the system call by a call to vfork. Because of this, a call to system should not be made after a call to vfork and before the corresponding call to an exec function.

For OpenVMS Version 7.0 and higher systems, if you include <stdlib.h> and compile with the _POSIX_EXIT feature-test macro set, then the system function returns the status as if it called waitpid to wait for the child. Therefore, use the WIFEXITED and WEXITSTATUS macros (described in the wait* routines) to retrieve the exit status in the range of 0 to 255.

You set the _POSIX_EXIT feature-test macro by using /DEFINE=_POSIX_EXIT or #define _POSIX_EXIT at the top of your file, before any file inclusions.

Return Value

nonzero value	If <i>string</i> is NULL, a value of 1 is returned, indicating that the system function is supported. If <i>string</i> is not NULL, the value is the subprocess OpenVMS return status.
---------------	--

Example

```
#include <stdlib.h>
#include <stdio.h>
#include <unistd.h>      /* write, close */
#include <fcntl.h>      /* Creat */

main()
{
    int status,
        fd;

    /* Creat a file we are sure is there */
}
```

```
fd = creat("system.test", 0);
write(fd, "this is an example of using system", 34);
close(fd);

if (system(NULL)) {
    status = system("DIR/NOHEAD/NOTRAIL/SIZE SYSTEM.TEST");
    printf("system status = %d\n", status);
}
else
    printf("system() not supported.\n");
}
```

Running this example program produces the following result:

```
DISK3$:[JONES.CRTL.2059.SRC]SYSTEM.TEST;1
1
system status = 1
```

tan

tan

Returns a double value that is the tangent of its radian argument.

Format

```
#include <math.h>
double tan (double x);
float tanf (float x); (Integrity servers, Alpha)
long double tanl (long double x); (Integrity servers, Alpha)
double tand (double x); (Integrity servers, Alpha)
float tandf (float x); (Integrity servers, Alpha)
long double tandl (long double x); (Integrity servers, Alpha)
```

Argument

x
A radian expressed as a real number.

Description

The tan functions compute the tangent of x , measured in radians.

The tand functions compute the tangent of x , measured in degrees.

Return Values

x	The tangent of the argument.
HUGE_VAL	x is a singular point (. . . $-3\pi/2, -\pi/2, \pi/2$. . .).
NaN	x is NaN; errno is set to EDOM.
0	x is \pm Infinity; errno is set to EDOM.
\pm HUGE_VAL	Overflow occurred; errno is set to ERANGE.
0	Underflow occurred; errno is set to ERANGE.

tanh

Returns the hyperbolic tangent of its argument.

Format

```
#include <math.h>
double tanh (double x);
float tanhf (float x); (Integrity servers, Alpha)
long double tanhl (long double x); (Integrity servers, Alpha)
```

Argument

x
A real number.

Description

The tanh functions return the hyperbolic tangent their argument, calculated as $(e^{**x} - e^{**(-x)}) / (e^{**x} + e^{**(-x)})$.

Return Values

n	The hyperbolic tangent of the argument.
HUGE_VAL	The argument is too large; errno is set to ERANGE.
NaN	<i>x</i> is NaN; errno is set to EDOM.
0	Underflow occurred; errno is set to ERANGE.

telldir

telldir

Returns the current location associated with a specified directory stream.
Performs operations on directories.

Format

```
#include <dirent.h>
long int telldir (DIR *dir_pointer);
```

Argument

dir_pointer
A pointer to the DIR structure of an open directory.

Description

The telldir function returns the current location associated with the specified directory stream.

Return Values

x	The current location.
-1	Indicates an error and is further specified in the global errno.

tempnam

Constructs the name for a temporary file.

Format

```
#include <stdio.h>
char *tempnam (const char *directory, const char *prefix, . . . ;)
```

Arguments

directory

A pointer to the pathname of the directory where you want to create a file.

prefix

A pointer to an initial character sequence of the filename. The *prefix* argument can be null, or it can point to a string of up to five characters used as the first characters of the temporary filename.

. . .

An optional argument that can be either 1 or 0. If you specify 1, tempnam returns the file specification in OpenVMS format. If you specify 0, tempnam returns the file specification in UNIX style format. For more information about UNIX style directory specifications, see Section 1.3.3.

Description

The tempnam function generates filenames for temporary files. It allows you to control the choice of a directory.

If the *directory* argument is null or points to a string that is not a pathname for an appropriate directory, the pathname defined as P_tmpdir in the <stdio.h> header file is used. For programs running under a detached process, the *directory* argument cannot be null.

You can bypass the selection of a pathname by providing the TMPDIR environment variable in the user environment. The value of the TMPDIR variable is a pathname for the desired temporary file directory.

Use the *prefix* argument to specify a prefix of up to five characters for the temporary filename.

The tempnam function returns a pointer to the generated pathname, suitable for use in a subsequent call to the free function.

See also free.

Note

In contrast to tmpnam, tempnam does not have to generate a different filename on each call. tempnam generates a new filename only if the file with the specified name exists. If you need a unique filename on each call, use tmpnam instead of tempnam.

tempnam

Return Values

x

A pointer to the generated pathname, suitable for use in a subsequent call to the free function.

NULL

An error occurred; errno is set to indicate the error.

tgamma (*Integrity servers, Alpha*)

Returns the gamma function of its argument.

Format

```
#include <math.h>
double tgamma (double x);
float tgammaf (float x);
long double tgamma1 (long double x);
```

Argument

x
A real value.

Description

The tgamma functions compute the gamma function of x .

Return Values

<code>n</code>	Upon success, the gamma function of x .
<code>-1</code>	If x is negative. <code>errno</code> is set to <code>EDOM</code> .
<code>±HUGE_VAL</code>	Overflow occurred or x is ± 0 . <code>errno</code> is set to <code>ERANGE</code> .
<code>NaN</code>	If x is <code>NaN</code> or $-\text{Inf}$. <code>errno</code> is set to <code>EDOM</code> .
<code>x</code>	If x is $+\text{Inf}$.

time

time

Returns the time (expressed as Universal Coordinated Time) elapsed since 00:00:00, January 1, 1970, in seconds.

Format

```
#include <time.h>
time_t time (time_t *time_location);
```

Function Variants

Compiling with the `_DECC_V4_SOURCE` and `_VMS_V6_SOURCE` feature-test macros defined enables a local-time-based entry point to the `time` function that is equivalent to the behavior before OpenVMS Version 7.0.

Argument

time_location

Either NULL or a pointer to the place where the returned time is also stored. The `time_t` type is defined in the `<time.h>` header file as follows:

```
typedef unsigned long int time_t;
```

Return Values

<code>x</code>	The time elapsed past the Epoch.
<code>(time_t)(-1)</code>	Indicates an error. If the value of <code>SYS\$TIMEZONE_DIFFERENTIAL</code> logical is wrong, the function will fail with <code>errno</code> set to <code>EINVAL</code> .

times

Passes back the accumulated times of the current process and its terminated child processes.

Format

```
#include <times.h>

clock_t times (struct tms *buffer); (OpenVMS 7.0 and higher)

void times (tbuffer_t *buffer); (pre OpenVMS 7.0)
```

Argument

buffer

A pointer to the terminal buffer.

Description

For both process and children times, the structure breaks down the time by user and system time. Since the OpenVMS system does not differentiate between system and user time, all system times are returned as 0. Accumulated CPU times are returned in 10-millisecond units.

Only the accumulated times for child processes running a C main program or a program that calls VAXC\$CRTL_INIT or DECC\$CRTL_INIT are included.

On OpenVMS Version 7.0 and higher systems, the times function returns the elapsed real time in clock ticks since an arbitrary reference time in the past (for example, system startup time). This reference time does not change from one times function call to another. The return value can overflow the possible range of type clock_t values. When times fails, it returns a value of -1. The HP C RTL uses system-boot time as its reference time.

Return Values

x	The elapsed real time in clock ticks since system-boot time.
(clock_t)(-1)	Indicates an error.

tmpfile

tmpfile

Creates a temporary file that is opened for update.

Format

```
#include <stdio.h>
FILE *tmpfile (void);
```

Description

The file exists only for the duration of the process, or until the file is closed and is preserved across calls to `vfork`.

Return Values

x	The address of a file pointer (defined in the <code><stdio.h></code> header file).
NULL	Indicates an error.

tolower

Converts a character to lowercase.

Format

```
#include <ctype.h>
int tolower (int character);
```

Argument

character

An object of type `int` representable as an unsigned `char` or the value of `EOF`. For any other value, the behavior is undefined.

Description

If the argument represents an uppercase letter, and there is a corresponding lowercase letter, as defined by character type information in the program locale category `LC_CTYPE`, the corresponding lowercase letter is returned.

If the argument is not an uppercase character, it is returned unchanged.

Return Value

x	The lowercase letter corresponding to the argument. Or, the unchanged argument, if it is not an uppercase character.
---	--

`_tolower`

`_tolower`

Converts an uppercase character to lowercase.

Format

```
#include <ctype.h>
int _tolower (int character);
```

Argument

character

This argument must be an uppercase letter.

Description

The `_tolower` macro is equivalent to the `tolower` function except that its argument *must* be an uppercase letter (not lowercase, not EOF).

As of OpenVMS Version 8.3 and to comply with the C99 ANSI standard and X/Open Specification, the `_tolower` macro by default does not evaluate its parameter more than once. It simply calls the `tolower` function. This avoids side effects (such as `i++` or function calls) where the user can tell how many times an expression is evaluated.

To keep the older, optimized `_tolower` macro behavior, compile with `/DEFINE=_FAST_TOUPPER`. Then, as in previous releases, `_tolower` optimizes the call to avoid the overhead of a runtime call. The parameters are checked to determine how to calculate the result, thereby creating unwanted side effects. Therefore, when compiling with `/DEFINE=_FAST_TOUPPER`, do not use the `_tolower` macro with arguments that contain side-effect operations. For instance, the following example will not return the expected result:

```
d = _tolower (C++);
```

Return Value

x	The lowercase letter corresponding to the argument.
---	---

touchwin

Places the most recently edited version of the specified window on the terminal screen.

Format

```
#include <curses.h>
int touchwin (WINDOW *win);
```

Argument

win
A pointer to the window.

Description

The touchwin function is normally used only to refresh overlapping windows.

Return Values

OK	Indicates success.
ERR	Indicates an error.

toupper

toupper

Converts a character to uppercase.

Format

```
#include <ctype.h>
int toupper (int character);
```

Argument

character

An object of type `int` representable as an unsigned `char` or the value of `EOF`. For any other value, the behavior is undefined.

Description

If the argument represents a lowercase letter, and there is a corresponding uppercase letter, as defined by character type information in the program locale category `LC_CTYPE`, the corresponding uppercase letter is returned.

If the argument is not a lowercase character, it is returned unchanged.

Return Value

x	The uppercase letter corresponding to the argument. Or, the unchanged argument, if the argument is not a lowercase character.
---	---

_toupper

Converts a lowercase character to uppercase.

Format

```
#include <ctype.h>
int _toupper (int character);
```

Argument

character

This argument must be a lowercase letter.

Description

The `_toupper` macro is equivalent to the `toupper` function except that its argument *must* be a lowercase letter (not uppercase, not EOF).

As of OpenVMS Version 8.3 and to comply with the C99 ANSI standard and X/Open Specification, the `_toupper` macro by default does not evaluate parameters more than once. It simply calls the `toupper` function. This avoids side effects (such as `i++` or function calls) where the user can tell how many times an expression is evaluated.

To keep the older, optimized `_toupper` macro behavior, compile with `/DEFINE=_FAST_TOUPPER`. Then, as in previous releases, `_toupper` optimizes the call to avoid the overhead of a runtime call. The parameters are checked to determine how to calculate the result, thereby creating unwanted side effects. So when compiling with `/DEFINE=_FAST_TOUPPER`, do not use the `_toupper` macro with arguments that contain side-effect operations. For instance, the following example will not return the expected result:

```
d = _toupper (c++);
```

Return Value

x	The uppercase letter corresponding to the argument.
---	---

towlower

Converts the argument, a wide-character code, to lowercase. If the argument is not an uppercase character, it is returned unchanged.

Format

```
#include <wctype.h> (ISO C)
```

```
#include <wchar.h> (XPG4)
```

```
int towlower (wint_t wc);
```

Argument

wc

An object of type `wint_t` representable as a valid wide character in the current locale, or the value of `WEOF`. For any other value, the behavior is undefined.

Description

If the argument is an uppercase wide character, the corresponding lowercase wide character (as defined in the `LC_CTYPE` category of the locale) is returned, if it exists. If it does not exist, the function returns the input argument unchanged.

towupper

towupper

Converts the argument, a wide character, to uppercase. If the argument is not a lowercase character, it is returned unchanged.

Format

```
#include <wctype.h> (ISO C)
#include <wchar.h> (XPG4)
int towupper (wint_t wc);
```

Argument

wc

An object of type `wint_t` representable as a valid wide character in the current locale, or the value of `WEOF`. For any other value, the behavior is undefined.

Description

If the argument is a lowercase wide character, the corresponding uppercase wide character (as defined in the `LC_CTYPE` category of the locale) is returned, if it exists. If it does not exist, the function returns the input argument unchanged.

truncate

truncate

Changes file length to a specified length, in bytes.

Format

```
#include <unistd.h>
int truncate (const char *path, off_t length);
```

Arguments

path

The name of a file that is to be truncated. This argument must point to a pathname that names a regular file for which the calling process has write permission.

length

The new length of the file, in bytes. The `off_t` type of *length* is either a 64-bit or 32-bit integer. The 64-bit interface allows for file sizes greater than 2 GB, and can be selected at compile time by defining the `_LARGEFILE` feature-test macro as follows:

```
CC/DEFINE=_LARGEFILE
```

Description

The `truncate` function changes the length of a file to the size, in bytes, specified by the *length* argument.

If the new length is less than the previous length, the function removes all data beyond *length* bytes from the specified file. All file data between the new End-of-File and the previous End-of-File is discarded.

For stream files, if the new length is greater than the previous length, new file data between the previous End-of-File and the new End-of-File is added, consisting of all zeros. (For record files, it is not possible to extend the file in this manner.)

Return Values

0	Indicates success.
-1	An error occurred; <code>errno</code> is set to indicate the error.

ttyname, ttyname_r

Find the pathname of a terminal.

Format

```
#include <unistd.h> (Compatibility)
char *ttyname (void); (Compatibility)

#include <unistd.h> (OpenVMS V7.3-2 and higher)
char *ttyname (int filedes); (OpenVMS V7.3-2 and higher)

int ttyname_r (int filedes, char name, size_t namesize); (OpenVMS V7.3-2 and higher),
                (Integrity servers, Alpha)
```

Arguments

filedes

An open file descriptor.

name

Pointer to a buffer in which the terminal name is stored.

namesize

The length of the buffer pointed to by the *name* argument.

Description

The implementation of the `ttyname` function that takes no argument is provided only for backward compatibility. This legacy implementation returns a pointer to the null-terminated name of the terminal device associated with file descriptor 0, the default input device (`stdin`). A value of 0 is returned if `SY$INPUT` is not a TTY device.

The `ttyname_r` function and the implementation of `ttyname` that takes a *filedes* argument are UNIX standard compliant and are available with only OpenVMS Version 7.3-2 and higher.

The standard compliant `ttyname` function returns a pointer to a string containing a null-terminated pathname of the terminal associated with file descriptor *filedes*. The return value might point to static data whose content is overwritten by each call. The `ttyname` interface need not be reentrant.

The `ttyname_r` function returns a pointer to store the null-terminated pathname of the terminal associated with the file descriptor *filedes* in the character array referenced by *name*. The array is *namesize* characters long and should have space for the name and the terminating null character. The maximum length of the terminal name is `TTY_NAME_MAX`.

If successful, `ttyname` returns a pointer to a string. Otherwise, a NULL pointer is returned and `errno` is set to indicate the error.

If successful, `ttyname_r` stores the terminal name as a null-terminated string in the buffer pointed to by *name* and returns 0. Otherwise, an error number is returned to indicate the error.

ttyname, ttyname_r

Return Values

x	Upon successful completion, <code>ttyname</code> returns a pointer to a null-terminated string.
NULL	Upon failure, <code>ttyname</code> returns a NULL pointer and sets <code>errno</code> to indicate the failure: <ul style="list-style-type: none">• <code>EBADF</code> – The <i>fdes</i> argument is not a valid file descriptor.• <code>ENOTTY</code> – The <i>fdes</i> argument does not refer to a terminal device.
0	Upon successful completion, <code>ttyname_r</code> returns 0.
n	Upon failure, <code>ttyname_r</code> sets <code>errno</code> to indicate the failure, and returns the same <code>errno</code> code: <ul style="list-style-type: none">• <code>EBADF</code> – The <i>fdes</i> argument is not a valid file descriptor.• <code>ENOTTY</code> – The <i>fdes</i> argument does not refer to a TTY device.• <code>ERANGE</code> – The value of <i>namesize</i> is smaller than the length of the string to be returned including the terminating null character.
0	For the legacy <code>ttyname</code> , indicates that <code>SYS\$INPUT</code> is not a TTY device.

tzset

Sets and accesses time-zone conversion.

Format

```
#include <time.h>

void tzset (void);

extern char *tzname[];

extern long int timezone;

extern int daylight;
```

Description

The `tzset` function initializes time-conversion information used by the `ctime`, `localtime`, `mktime`, `strftime`, and `wcsftime` functions.

The `tzset` function sets the following external variables:

- `tzname` is set as follows, where "std" is a 3-byte name for the standard time zone, and "dst" is a 3-byte name for the Daylight Savings Time zone:

```
tzname[0] = "std"
tzname[1] = "dst"
```

- `daylight` is set to 0 if Daylight Savings Time should never be applied to the time zone. Otherwise, `daylight` is set to 1.
- `timezone` is set to the difference between UTC and local standard time.

The environment variable `TZ` specifies how `tzset` initializes time conversion information:

- If `TZ` is absent from the environment, the implementation-dependent time-zone information is used, as follows:

The best available approximation to local wall-clock time is used, as defined by the `SYS$LOCALTIME` system logical, which points to a `tzfile` format file that describes default time-zone rules.

This system logical is set during the installation of OpenVMS Version 7.0 or higher to define a time-zone file based off the root directory `SYS$COMMON:[SYS$ZONEINFO.SYSTEM]`.¹

- If `TZ` appears in the environment but its value is a null string, Coordinated Universal Time (UTC) is used (without leap-second correction).

¹ The HP C RTL uses a public-domain, time-zone handling package that puts time-zone conversion rules in easily accessible and modifiable files. These files reside in the `SYS$COMMON:[SYS$ZONEINFO.SYSTEM.SOURCES]` directory. The time-zone compiler `zic` converts these files to a special format described by the `<tzfile.h>` header file. The converted files are created with a root directory of `SYS$COMMON:[SYS$ZONEINFO.SYSTEM]`, which is pointed to by the `SYS$TZDIR` system logical. This format is readable by the C library functions that handle time-zone information. For example, in the eastern United States, `SYS$LOCALTIME` is defined to be `SYS$COMMON:[SYS$ZONEINFO.SYSTEM.US]EASTERN`.

- If TZ appears in the environment and its value is not a null string, the value has one of three formats, as described in Table REF–11.

Table REF–11 Time-Zone Initialization Rules

TZ Format	Meaning
:	UTC is used.
:pathname	The characters following the colon specify the pathname of a tzfile format file from which to read the time-conversion information. A pathname beginning with a slash (/) represents an absolute pathname; otherwise, the pathname is relative to the system time-conversion information directory specified by SYS\$TZDIR, which by default is SYS\$COMMON:[SYS\$ZONEINFO.SYSTEM].
stdoffset[dst[offset] [,rule]]	<p>The value is first used as the pathname of a file (as described for the :pathname format) from which to read the time-conversion information.</p> <p>If that file cannot be read, the value is then interpreted as a direct specification of the time-conversion information, as follows:</p> <p><i>std</i> and <i>dst</i>—Three or more characters that are the designation for the time zone:</p> <ul style="list-style-type: none"> • <i>std</i>—Standard time zone. Required. • <i>dst</i>—Daylight Savings Time zone. Optional. If <i>dst</i> is omitted, Daylight Savings Time does not apply. <p>Uppercase and lowercase letters are explicitly allowed. Any characters are allowed, except the following:</p> <ul style="list-style-type: none"> • digits • leading colon (:) • comma (,) • minus (–) • plus (+) • ASCII null character <p><i>offset</i>—The value added to the local time to arrive at UTC. The offset has the following format:</p> <p><i>hh</i>[:<i>mm</i>[:<i>ss</i>]]</p> <p>In this format:</p> <ul style="list-style-type: none"> • <i>hh</i> (hours) is a one-or two-digit value of 0–24. • <i>mm</i> (minutes) is a value of 0–59. (optional) • <i>ss</i> (seconds) is a value of 0–59. (optional)

(continued on next page)

Table REF-11 (Cont.) Time-Zone Initialization Rules

TZ Format	Meaning
	<p>The offset following <i>std</i> is required. If no offset follows <i>dst</i>, summer time is assumed, one hour ahead of standard time. You can use one or more digits; the value is always interpreted as a decimal number.</p> <p>If the time zone is preceded by a minus sign (–), the time zone is East of Greenwich; otherwise, it is West, which can also be indicated by a preceding plus sign (+).</p> <p><i>rule</i>—Indicates when to change to and return from summer time. The rule has the form:</p> <p><i>start[/time], end[/time]</i></p> <p>where:</p> <ul style="list-style-type: none"> • <i>start</i> is the date when the change from standard time to summer time occurs. • <i>end</i> is the date for returning from summer time to standard time. <p>If <i>start</i> and <i>end</i> are omitted, the default is the US Daylight Savings Time start and end dates. The format for <i>start</i> and <i>end</i> must be one of the following:</p> <ul style="list-style-type: none"> • <i>Jn</i>—The Julian day <i>n</i> ($1 < n < 365$). Leap days are not counted. That is, in all years, including leap years, February 28 is day 59 and March 1 is day 60. You cannot explicitly refer to February 29. • <i>n</i>—The zero based Julian day ($0 < n < 365$). Leap days are counted, making it possible to refer to February 29. • <i>Mm.n.d</i>—The <i>n</i>th <i>d</i> day of month <i>m</i>, where: <ul style="list-style-type: none"> $0 < n < 5$ $0 < d < 6$ $1 < m < 12$ <p>When <i>n</i> is 5, it refers to the last <i>d</i> day of month <i>m</i>. Sunday is day 0.</p>

(continued on next page)

Table REF–11 (Cont.) Time-Zone Initialization Rules

TZ Format	Meaning
	<p><i>time</i>—The time when, in current time, the change to or return from summer time occurs. The <i>time</i> argument has the same format as <i>offset</i>, except that you cannot use a leading minus (–) or plus (+) sign. If <i>time</i> is not specified, the default is 02:00:00.</p> <p>If no rule is present in the TZ specification, the rules used are those specified by the tzfile format file defined by the SYS\$POSIXRULES system logical in the system time-conversion information directory, with the standard and summer time offsets from UTC replaced by those specified by the offset values in TZ.</p> <p>If TZ does not specify a tzfile format file and cannot be interpreted as a direct specification, UTC is used.</p>

Note

The UTC-based time functions, introduced in OpenVMS Version 7.0, had degraded performance compared with the non-UTC-based time functions.

OpenVMS Version 7.1 added a cache for time-zone files to improve performance. The size of the cache is determined by the logical name DECC\$TZ_CACHE_SIZE. To accommodate most countries changing the time twice per year, the default cache size is large enough to hold two time-zone files.

See also `ctime`, `localtime`, `mktime`, `strftime`, and `wcsftime`.

Sample TZ Specification

```
EST5EDT4,M4.1.0,M10.5.0
```

This sample TZ specification describes the rule defined in 1987 for the Eastern time zone in the US:

- EST (Eastern Standard Time) is the designation for standard time, which is 5 hours behind UTC.
- EDT (Eastern Daylight Time) is the designation for summer time, which is 4 hours behind UTC. EDT starts on the first Sunday in April and ends on the last Sunday in October.

Because *time* was not specified in either case, the changes occur at the default time, which is 2:00 A.M. The start and end dates did not need to be specified, because they are the defaults.

ualarm

Sets or changes the timeout of interval timers.

Format

```
#include <unistd.h>
useconds_t ualarm (useconds_t mseconds, useconds_t interval);
```

Arguments

mseconds

Specifies a number of real-time microseconds.

interval

Specifies the interval for repeating the timer.

Description

The `ualarm` function causes the SIGALRM signal to be generated for the calling process after the number of real-time microseconds specified by *useconds* has elapsed. When the *interval* argument is nonzero, repeated timeout notification occurs with a period in microseconds specified by *interval*. If the notification signal SIGALRM is not intercepted or is ignored, the calling process is terminated.

If you call a combination of `ualarm` and `setitimer` functions, and the AST status is disabled, the return value is invalid.

If you call a combination of `ualarm` and `setitimer` functions, and the AST status is enabled, the return value is valid.

This is because you cannot invoke an AST handler to clear the previous value of the timer when ASTs are disabled or invoked from a handler that was invoked at AST level.

Note

Interactions between `ualarm` and either `alarm`, or `sleep` are unspecified.

See also `setitimer`.

Return Values

n	The number of microseconds remaining from the previous <code>ualarm</code> or <code>setitimer</code> call.
0	No timeouts are pending or <code>ualarm</code> not previously called.
-1	Indicates an error.

umask

umask

Creates a file protection mask that is used when a new file is created, and returns the previous mask value.

Format

```
#include <stat.h>

mode_t umask (mode_t mode_complement);
```

Argument

mode_complement

Shows which bits to turn off when a new file is created. See the description of `chmod` to determine what the bits represent.

Description

Initially, the file protection mask is set from the current process's default file protection. This is done when the C main program starts up or when `DECC$CRTL_INIT` (or `VAXC$CRTL_INIT`) is called. You can change this for all files created by your program by calling `umask` or you can use `chmod` to change the file protection on individual files. The file protection of a file created by `open` or `creat` is the bitwise AND of the `open` and `creat` mode argument with the complement of the value passed to `umask` on the previous call.

Note

The way to create files with OpenVMS RMS default protections using the UNIX system-call functions `umask`, `mkdir`, `creat`, and `open` is to call `mkdir`, `creat`, and `open` with a file-protection mode argument of `0777` in a program that never specifically calls `umask`. These default protections include correctly establishing protections based on ACLs, previous versions of files, and so on.

In programs that do `vfork/exec` calls, the new process image inherits whether `umask` has ever been called or not from the calling process image. The `umask` setting and whether the `umask` function has ever been called are both inherited attributes.

Return Value

x	The old mask value.
---	---------------------

uname

Gets system identification information.

Format

```
#include <utsname.h>
int uname (struct utsname *name);
```

Argument

name
The current system identifier.

Description

The `uname` function stores null-terminated strings of information identifying the current system into the structure referenced by the *name* argument.

The `utsname` structure is defined in the `<utsname.h>` header file and contains the following members:

<code>sysname</code>	Name of the operating system implementation
<code>nodename</code>	Network name of this machine
<code>release</code>	Release level of the operating system
<code>version</code>	Version level of the operating system
<code>machine</code>	Machine hardware platform

Return Values

0	Indicates success.
-1	Indicates an error; <code>errno</code> or <code>vaxc\$errno</code> is set as appropriate.

ungetc

ungetc

Pushes a character back into the input stream and leaves the stream positioned before the character.

Format

```
#include <stdio.h>
int ungetc (int character, FILE *file_ptr);
```

Arguments

character

A value of type `int`.

file_ptr

A file pointer.

Description

When using the `ungetc` function, the character is pushed back onto the file indicated by *file_ptr*.

One push-back is guaranteed, even if there has been no previous activity on the file. The `fseek` function erases all memory of pushed-back characters. The pushed-back character is not written to the underlying file. If the character to be pushed back is EOF, the operation fails, the input stream is left unchanged, and EOF is returned.

See also `fseek` and `getc`.

Return Values

x	The push-back character.
EOF	Indicates it cannot push the character back.

ungetwc

Pushes a wide character back into the input stream.

Format

```
#include <wchar.h>
wint_t ungetwc (wint_t wc, FILE *file_ptr);
```

Arguments

wc
A value of type `wint_t`.

file_ptr
A file pointer.

Description

When using the `ungetwc` function, the wide character is pushed back onto the file indicated by *file_ptr*.

One push-back is guaranteed, even if there has been no previous activity on the file. If a file positioning function (such as `fseek`) is called before the pushed back character is read, the bytes representing the pushed back character are lost.

If the character to be pushed back is `WEOF`, the operation fails, the input stream is left unchanged, and `WEOF` is returned.

See also `getwc`.

Return Values

<code>x</code>	The push-back character.
<code>WEOF</code>	Indicates that the function cannot push the character back. <code>errno</code> is set to one of the following: <ul style="list-style-type: none">• <code>EBADF</code> – The file descriptor is not valid.• <code>EALREADY</code> – Operation is already in progress on the same file.• <code>EILSEQ</code> – Invalid wide-character code detected.

unlink (*Integrity servers, Alpha*)

unlink (*Integrity servers, Alpha*)

Deletes the specified symbolic link from the system.

Format

```
#include <unistd.h>
int unlink (const char *link_name);
```

Arguments

link_name
The name of the symbolic link to be deleted.

Description

The unlink function deletes the specified symbolic link (*link_name*) from the system. The contents of the symbolic link are not examined, and no action is performed on the file specified in the contents. For other files, the unlink function behaves the same as the C RTL remove function.

See also symlink, readlink, realpath, lchown, and lstat.

Return Values

0	Successful completion.
-1	Indicates an error. The named file (<i>link_name</i>) is unchanged, and errno is set to any errno value from remove.

unordered (*Integrity servers, Alpha*)

Returns the value 1 (TRUE) if either or both of the arguments is a NaN.
Otherwise, it returns the value 0 (FALSE).

Format

```
#include <math.h>
double unordered (double x, double y);
float unorderedf (float x, float y);
long double unorderedl (long double x, long double y);
```

Arguments

x
A real number.

y
A real number.

Return Values

1	Either or both of the arguments is a NaN.
0	Neither argument is a NaN.

unsetenv

unsetenv

Deletes all instances of the environment variable *name* from the environment list.

Format

```
#include <stdlib.h>
void unsetenv (const char *name);
```

Argument

name
The environment variable to delete from the environment list.

Description

The `unsetenv` function deletes all instances of the variable *name* pointed to by the *name* argument from the environment list.

usleep

Suspends execution for an interval.

Format

```
#include <unistd.h>
int usleep (unsigned int mseconds);
```

Argument

mseconds

The number of microseconds to suspend execution for.

Description

The `usleep` function suspends the current process from execution for the number of microseconds specified by the `mseconds` argument. This argument must be less than 1,000,000. However, if its value is 0, then the call has no effect.

Be aware that `usleep` time specifications are rounded up approximately to the next millisecond because that is the finest time interval granularity possible on OpenVMS systems.

There is one real-time interval timer for each process. The `usleep` function does not interfere with a previous setting of this timer. If the process set this timer before calling `usleep` and if the time specified by `mseconds` equals or exceeds the interval timer's prior setting, then the process is awakened shortly before the timer was set to expire.

Return Values

0	Indicates success.
-1	Indicates an error occurred; <code>errno</code> is set to <code>EINVAL</code> .

utime

utime

Sets file access and modification times.

Format

```
#include <utime.h>

int utime (const char *path, const struct utimbuf *times);
```

Arguments

path

A pointer to a file.

times

A NULL pointer or a pointer to a utimbuf structure.

Description

The `utime` function sets the access and modification times of the file named by the `path` argument. The file must be openable for write-access to use this function.

If `times` is a NULL pointer, the access and modification times of the file are set to the current time. To use `utime` in this way, the effective user ID of the process must match the owner of the file, or the process must have write permission to the file or have appropriate privileges.

If `times` is not a NULL pointer, it is interpreted as a pointer to a `utimbuf` structure, and the access and modification times are set to the values in the specified structure. Only a process with an effective user ID equal to the user ID of the file or a process with appropriate privileges can use `utime` this way.

The `utimbuf` structure is defined by the `<utime.h>` header. The times in the `utimbuf` structure are measured in seconds since the Epoch.

Upon successful completion, `utime` marks the time of the last file status change, `st_ctime`, to be updated. See the `<stat.h>` header file.

Note *(Integrity servers, Alpha)*

On OpenVMS Alpha and Integrity server systems, the `stat`, `fstat`, `utime`, and `utimes` functions have been enhanced to take advantage of the new file-system support for POSIX compliant file timestamps.

This support is available only on ODS-5 devices on OpenVMS Alpha systems beginning with a version of OpenVMS Alpha after Version 7.3.

Before this change, `stat` and `fstat` set the values of the `st_ctime`, `st_mtime`, and `st_atime` fields based on the following file attributes:

- `st_ctime` – `ATR$C_CREDATE` (file creation time)
- `st_mtime` – `ATR$C_REVDATE` (file revision time)
- `st_atime` – was always set to `st_mtime` because no support for file access time was available

Also, for the file-modification time, `utime` and `utimes` were modifying the `ATR$C_REVDATE` file attribute, and ignoring the file-access-time argument.

After the change, for a file on an ODS-5 device, the `stat` and `fstat` functions set the values of the `st_ctime`, `st_mtime`, and `st_atime` fields based on the following new file attributes:

```
st_ctime – ATR$C_ATTDATE (last attribute modification time)
st_mtime – ATR$C_MODDATE (last data modification time)
st_atime – ATR$C_ACCDATE (last access time)
```

If `ATR$C_ACCDATE` is 0, as on an ODS-2 device, the `stat` and `fstat` functions set `st_atime` to `st_mtime`.

For the file-modification time, the `utime` and `utimes` functions modify both the `ATR$C_REVDATE` and `ATR$C_MODDATE` file attributes. For the file-access time, these functions modify the `ATR$C_ACCDATE` file attribute. Setting the `ATR$C_MODDATE` and `ATR$C_ACCDATE` file attributes on an ODS-2 device has no effect.

For compatibility, the old behavior of `stat`, `fstat`, `utime`, and `utimes` remains the default, regardless of the kind of device.

The new behavior must be explicitly enabled by defining the `DECC$EFS_FILE_TIMESTAMPS` logical name to "ENABLE" before invoking the application. Setting this logical does not affect the behavior of `stat`, `fstat`, `utime`, and `utimes` for files on an ODS-2 device.

Return Values

0	Successful execution.
-1	Indicates an error. The function sets <code>errno</code> to one of the following values: The <code>utime</code> function <i>will</i> fail if: <ul style="list-style-type: none"> • <code>EACCES</code> – Search permission is denied by a component of the <i>path</i> prefix; or the <i>times</i> argument is a NULL pointer and the effective user ID of the process does not match the owner of the file and write access is denied. • <code>ELOOP</code> – Too many symbolic links were encountered in resolving <i>path</i>. • <code>ENAMETOOLONG</code> – The length of the <i>path</i> argument exceeds <code>PATH_MAX</code>, a pathname component is longer than <code>NAME_MAX</code>, or a pathname resolution of a symbolic link produced an intermediate result whose length exceeds <code>PATH_MAX</code>. • <code>ENOENT</code> – <i>path</i> does not name an existing file, or <i>path</i> is an empty string.

utime

- ENOTDIR – A component of the *path* prefix is not a directory.
- EPERM – *times* is not a NULL pointer and the calling process's effective user ID has write-access to the file but does not match the owner of the file, and the calling process does not have the appropriate privileges.
- EROFS – The file system containing the file is read-only.

utimes

Sets file access and modification times.

Format

```
#include <time.h>

int utimes (const char *path, const struct timeval times[2]);
```

Arguments

path

A pointer to a file.

times

an array of `timeval` structures. The first array member represents the date and time of last access, and the second member represents the date and time of last modification. The times in the `timeval` structure are measured in seconds and microseconds since the Epoch, although rounding toward the nearest second may occur.

Description

The `utimes` function sets the access and modification times of the file pointed to by the `path` argument to the value of the `times` argument. The `utimes` function allows time specifications accurate to the microsecond.

If the `times` argument is a NULL pointer, the access and modification times of the file are set to the current time. The effective user ID of the process must be the same as the owner of the file, or must have write access to the file or appropriate privileges to use this call in this manner.

Upon completion, `utimes` marks the time of the last file status change, `st_ctime`, for update.

Note *(Integrity servers, Alpha)*

On OpenVMS Alpha and Integrity server systems, the `stat`, `fstat`, `utime`, and `utimes` functions have been enhanced to take advantage of the new file-system support for POSIX compliant file timestamps.

This support is available only on ODS-5 devices on OpenVMS Alpha systems beginning with a version of OpenVMS Alpha after Version 7.3.

Before this change, the `stat` and `fstat` functions were setting the values of the `st_ctime`, `st_mtime`, and `st_atime` fields based on the following file attributes:

- `st_ctime` – `ATR$C_CREDATE` (file creation time)
- `st_mtime` – `ATR$C_REVDATE` (file revision time)
- `st_atime` – was always set to `st_mtime` because no support for file access time was available

Also, for the file-modification time, `utime` and `utimes` were modifying the `ATR$C_REVDATE` file attribute, and ignoring the file-access-time argument.

utimes

After the change, for a file on an ODS-5 device, the `stat` and `fstat` functions set the values of the `st_ctime`, `st_mtime`, and `st_atime` fields based on the following new file attributes:

```
st_ctime – ATR$C_ATTDATE (last attribute modification time)
st_mtime – ATR$C_MODDATE (last data modification time)
st_atime – ATR$C_ACCDATE (last access time)
```

If `ATR$C_ACCDATE` is 0, as on an ODS-2 device, the `stat` and `fstat` functions set `st_atime` to `st_mtime`.

For the file-modification time, the `utime` and `utimes` functions modify both the `ATR$C_REVDATE` and `ATR$C_MODDATE` file attributes. For the file-access time, these functions modify the `ATR$C_ACCDATE` file attribute. Setting the `ATR$C_MODDATE` and `ATR$C_ACCDATE` file attributes on an ODS-2 device has no effect.

For compatibility, the old behavior of `stat`, `fstat`, `utime`, and `utimes` remains the default, regardless of the kind of device.

The new behavior must be explicitly enabled by defining the `DECC$EFS_FILE_TIMESTAMPS` logical name to "ENABLE" before invoking the application. Setting this logical does not affect the behavior of `stat`, `fstat`, `utime`, and `utimes` for files on an ODS-2 device.

Return Values

0	Successful execution.
-1	Indicates an error. The file times do not change and the function sets <code>errno</code> to one of the following values: The <code>utimes</code> function <i>will</i> fail if: <ul style="list-style-type: none">• <code>EACCES</code> – Search permission is denied by a component of the <i>path</i> prefix; or the <i>times</i> argument is a NULL pointer and the effective user ID of the process does not match the owner of the file and write access is denied.• <code>ELOOP</code> – Too many symbolic links were encountered in resolving <i>path</i>.• <code>ENAMETOOLONG</code> – The length of the <i>path</i> argument exceeds <code>PATH_MAX</code>, a pathname component is longer than <code>NAME_MAX</code>, or a pathname resolution of a symbolic link produced an intermediate result whose length exceeds <code>PATH_MAX</code>.• <code>ENOENT</code> – A component of <i>path</i> does not name an existing file, or <i>path</i> is an empty string.

- ENOTDIR – A component of the *path* prefix is not a directory.
- EPERM –The *times* argument is not a NULL pointer and the calling process's effective user ID has write-access to the file but does not match the owner of the file and the calling process does not have the appropriate privileges.
- EROFS – The file system containing the file is read-only.

VAXC\$CRTL_INIT

VAXC\$CRTL_INIT

Allows you to call the HP C RTL from other languages or to use the HP C RTL when your main function is not in C. It initializes the run-time environment and establishes both an exit and condition handler. VAXC\$CRTL_INIT is a synonym for DECC\$CRTL_INIT. Either name invokes the same routine.

Format

```
#include <signal.h>
void VAXC$CRTL_INIT();
```

Description

The following example shows a Pascal program that calls the HP C RTL using the VAXC\$CRTL_INIT function:

On OpenVMS Alpha systems:

```
$ PASCAL EXAMPLE
$ LINK EXAMPLE,SYS$LIBRARY:VAXCRTL/LIB
$ TY EXAMPLE.PAS
PROGRAM TESTC(input, output);
PROCEDURE VAXC$CRTL_INIT; extern;
BEGIN
    VAXC$CRTL_INIT;
END
$
```

A shareable image need only call this function if it contains an HP C function for signal handling, environment variables, I/O, exit handling, a default file protection mask, or if it is a child process that should inherit context.

Although many of the initialization activities are performed only once, DECC\$CRTL_INIT can safely be called multiple times. On OpenVMS VAX systems, DECC\$CRTL_INIT establishes the HP C RTL internal OpenVMS exception handler in the frame of the routine that calls DECC\$CRTL_INIT each time DECC\$CRTL_INIT is called.

At least one frame in the current call stack must have that handler established for OpenVMS exceptions to get mapped to UNIX signals.

VAXC\$ESTABLISH

Used for establishing an OpenVMS exception handler for a particular routine. This function establishes a special HP C RTL exception handler in the routine that called it. This special handler catches all RTL-related exceptions that occur in later routines, and passes on all other exceptions to your handler.

Format

```
#include <signal.h>

void VAXC$ESTABLISH (unsigned int (*exception_handler)(void *sigarr, void *mecharr));
```

Arguments

exception_handler

The name of the function that you want to establish as an OpenVMS exception handler. You pass a pointer to this function as the parameter to VAXC\$ESTABLISH.

sigarr

A pointer to the signal array.

mecharr

A pointer to the mechanism array.

Description

VAXC\$ESTABLISH must be used in place of LIB\$ESTABLISH when programs use the HP C RTL routines setjmp or longjmp. See setjmp and longjmp, or sigsetjmp and siglongjmp.

You can only invoke the VAXC\$ESTABLISH function from an HP C for OpenVMS function, because it relies on the allocation of data space on the run-time stack by the HP C compiler. Calling the OpenVMS system library routine LIB\$ESTABLISH directly from an HP C function results in undefined behavior from the setjmp and longjmp functions.

To cause an OpenVMS exception to generate a UNIX style signal, user exception handlers must return SS\$_RESIGNAL upon receiving any exception that they do not want to handle. Returning SS\$_NORMAL prevents the generation of a UNIX style signal. UNIX signals are generated as if by an exception handler in the stack frame of the main C program. Not all OpenVMS exceptions correspond to UNIX signals. See Chapter 4 for more information on the interaction of OpenVMS exceptions and UNIX style signals.

Calling VAXC\$ESTABLISH with an argument of NULL cancels an existing handler in that routine.

Notes

On OpenVMS Alpha systems, VAXC\$ESTABLISH is implemented as a compiler built-in function, not as an HP C RTL function. *(Alpha only)*

va_arg

va_arg

Returns the next item in the argument list.

Format

```
#include <stdarg.h> (ANSI C)
```

```
#include <varargs.h> (HP C Extension)
```

```
type va_arg (va_list ap, type);
```

Arguments

ap

A variable list containing the next argument to be obtained.

type

A data type that is used to determine the size of the next item in the list. An argument list can contain items of varying sizes, but the calling routine must determine what type of argument is expected since it cannot be determined at run time.

Description

The `va_arg` function interprets the object at the address specified by the list incrementor according to type. If there is no corresponding argument, the behavior is undefined.

When using `va_arg` to write portable applications, include the `<stdarg.h>` header file (defined by the ANSI C standard), not the `<varargs.h>` header file, and use `va_arg` only in conjunction with other functions and macros defined in `<stdarg.h>`.

For an example of argument-list processing using the `<stdarg.h>` functions and definitions, see Example 3–6.

va_count

Returns the number of quadwords (*Alpha only*) in the argument list.

Format

```
#include <stdarg.h> (ANSI C)
```

```
#include <varargs.h> (HP C Extension)
```

```
void va_count (int count);
```

Argument

count

An integer variable name in which the number of quadwords (*Alpha only*) is returned.

Description

The `va_count` macro places the number of quadwords (*Alpha only*) in the argument list into `count`. The value returned in `count` is the number of quadwords (*Alpha only*) in the function argument block not counting the `count` field itself.

If the argument list contains items whose storage requirements are a quadword (*Alpha only*) of memory or less, the number in the `count` argument is also the number of arguments. However, if the argument list contains items that are longer than a quadword (*Alpha only*), `count` must be interpreted to obtain the number of arguments. Because a double is 8 bytes, it occupies one argument-list position on OpenVMS Alpha and Integrity server systems.

The `va_count` macro is specific to HP C for OpenVMS Systems and is not portable.

va_end

va_end

Finishes the `<varargs.h>` or `<stdarg.h>` session.

Format

```
#include <stdarg.h> (ANSI C)
```

```
#include <varargs.h> (HP C Extension)
```

```
void va_end (va_list ap);
```

Argument

ap

The object used to traverse the argument list length. You must declare and use the argument *ap* as shown in this format section.

Description

You can execute multiple traversals of the argument list, each delimited by `va_start . . . va_end`. The `va_end` function sets *ap* equal to `NULL`.

When using this function to write portable applications, include the `<stdarg.h>` header file (defined by the ANSI C standard), not the `<varargs.h>` header file, and use `va_end` only in conjunction with other routines defined in `<stdarg.h>`.

For an example of argument-list processing using the `<stdarg.h>` functions and definitions, see Example 3–6.

va_start, va_start_1

Used for initializing a variable to the beginning of the argument list.

Format

```
#include <varargs.h> (HP C Extension)
void va_start (va_list ap);
void va_start_1 (va_list ap, int offset);
```

Arguments

ap

An object pointer. You must declare and use the argument *ap* as shown in the format section.

offset

The number of bytes by which *ap* is to be incremented so that it points to a subsequent argument within the list (that is, not to the start of the argument list). Using a nonzero offset can initialize *ap* to the address of the first of the optional arguments that follow a number of fixed arguments.

Description

The `va_start` macro initializes the variable *ap* to the beginning of the argument list.

The `va_start_1` macro initializes *ap* to the address of an argument that is preceded by a known number of defined arguments. The `printf` function is an example of a HP C RTL function that contains a variable-length argument list offset from the beginning of the entire argument list. The variable-length argument list is offset by the address of the formatting string.

When determining the value of the offset argument used in `va_start_1`, the implications of the OpenVMS calling standard must be considered.

On OpenVMS Alpha and Integrity server systems, each argument item is a quadword.

Note

When accessing argument lists, especially those passed to a subroutine (written in C) by a program written in another programming language, consider the implications of the OpenVMS calling standard. For more information about the OpenVMS calling standard, see the *HP C User's Guide for OpenVMS Systems* or the *HP OpenVMS Calling Standard*.

The preceding version of `va_start` and `va_start_1` is specific to the HP C RTL, and is not portable.

The following syntax describes the `va_start` macro in the `<stdarg.h>` header file, as defined in the ANSI C standard:

va_start, va_start_1

Format

```
#include <stdarg.h> (ANSI C)
void va_start (va_list ap, parmN);
```

Arguments

ap

An object pointer. You must declare and use the argument *ap* as shown in the format section.

parmN

The name of the last of the known fixed arguments.

Description

The pointer *ap* is initialized to point to the first of the optional arguments that follow *parmN* in the argument list.

Always use this version of `va_start` in conjunction with functions that are declared and defined with function prototypes. Also use this version of `va_start` to write portable programs.

For an example of argument-list processing using the `<stdarg.h>` functions and definitions, see Example 3–6.

vfork

Creates an independent child process. This function is nonreentrant.

Format

```
#include <unistd.h>
int vfork (void); (_DECC_V4_SOURCE)
pid_t vfork (void); (not _DECC_V4_SOURCE)
```

Description

The `vfork` function provided by HP C for OpenVMS Systems differs from the `fork` function provided by other C implementations. Table REF-12 shows the two major differences.

Table REF-12 The `vfork` and `fork` Functions

The <code>vfork</code> Function	The <code>fork</code> Function
Used with the <code>exec</code> functions.	Can be used without an <code>exec</code> function for asynchronous processing.
Creates an independent child process that shares some of the parent's characteristics.	Creates an exact duplicate of the parent process that branches at the point where <code>vfork</code> is called, as if the parent and the child are the same process at different stages of execution.

The `vfork` function provides the setup necessary for a subsequent call to an `exec` function. Although no process is created by `vfork`, it performs the following steps:

- It saves the return address (the address of the `vfork` call) to be used later as the return address for the call to an `exec` function.
- It saves the current context.
- It returns the integer 0 the first time it is called (before the call to an `exec` function is made). After the corresponding `exec` function call is made, the `exec` function returns control to the parent process, at the point of the `vfork` call, and it returns the process ID of the child as the return value. Unless the `exec` function fails, control appears to return twice from `vfork` even though one call was made to `vfork` and one call was made to the `exec` function.

The behavior of the `vfork` function is similar to the behavior of the `setjmp` function. Both `vfork` and `setjmp` establish a return address for later use, both return the integer 0 when they are first called to set up this address, and both pass back the second return value as though it were returned by them rather than by their corresponding `exec` or `longjmp` function calls.

However, unlike `setjmp`, with `vfork`, all local automatic variables, even those with volatile-qualified type, can have indeterminate values if they are modified between the call to `vfork` and the corresponding call to an `exec` routine.

vfork

Return Values

0	Indicates successful creation of the context.
nonzero	Indicates the process ID (PID) of the child process.
-1	Indicates an error – failure to create the child process.

vfprintf

Prints formatted output based on an argument list.

Format

```
#include <stdio.h>
```

```
int vfprintf (FILE *file_ptr, const char *format, va_list ap);
```

Arguments

file_ptr

A pointer to the file to which the output is directed.

format

A pointer to a string containing the format specification. For more information about format and conversion specifications and their corresponding arguments, see Chapter 2.

ap

A list of expressions whose resultant types correspond to the conversion specifications given in the format specifications.

Description

See also `vprintf` and `vsprintf`.

Return Values

x	The number of bytes written.
Negative value	Indicates an output error. The function sets <code>errno</code> . For a list of possible <code>errno</code> values set, see <code>fprintf</code> .

vfscanf

Reads formatted input based on an argument list.

Format

```
#include <stdio.h>
int vfscanf (FILE *file_ptr, const char *format, va_list ap);
```

Arguments

file_ptr

A pointer to the file that provides input text.

format

A pointer to a string containing the format specification.

ap

A list of expressions whose resultant types correspond to the conversion specifications given in the format specifications.

Description

The `vfscanf` function is the same as the `fscanf` function except that instead of being called with a variable number of arguments, it is called with an argument list that has been initialized by `va_start` (and possibly subsequent `va_arg` calls).

If no conversion specifications are given, you can omit the input pointers. Otherwise, the function calls must have exactly as many input pointers as there are conversion specifications, and the conversion specifications must match the types of the input pointers.

Conversion specifications are matched to input sources in left-to-right order. Excess input pointers, if any, are ignored.

For more information about format and conversion specifications and their corresponding arguments, see Chapter 2.

This function returns the number of successfully matched and assigned input items.

See also `vscanf` and `vsscanf`.

Return Values

n	The number of successfully matched and assigned input items.
---	--

EOF

Indicates that the end-of-file was encountered or a read error occurred. If a read error occurs, the function sets `errno` to one of the following:

- `EILSEQ` – Invalid character detected.
- `EINVAL` – Insufficient arguments.
- `ENOMEM` – Not enough memory available for conversion.
- `ERANGE` – Floating-point calculations overflow.
- `EVMSEERR` – Nontranslatable OpenVMS error. `vaxc$errno` contains the OpenVMS error code. This can indicate that conversion to a numeric value failed due to overflow.

The function can also set `errno` to the following as a result of errors returned from the I/O subsystem:

- `EBADF` – The file descriptor is not valid.
- `EIO` – I/O error.
- `ENXIO` – Device does not exist.
- `EPIPE` – Broken pipe.
- `EVMSEERR` – Nontranslatable OpenVMS error. `vaxc$errno` contains the OpenVMS error code. This indicates that an I/O error occurred for which there is no equivalent C error code.

vfwprintf

vfwprintf

Writes output to the stream under control of the wide-character format string.

Format

```
#include <wchar.h>
```

```
int vfwprintf (FILE *stream, const wchar_t *format, va_list ap);
```

Arguments

stream

A file pointer.

format

A pointer to a wide-character string containing the format specifications. For more information about format and conversion specifications and their corresponding arguments, see Chapter 2.

ap

A variable list of the items needed for output.

Description

The `vfwprintf` function is equivalent to the `fwprintf` function, with the variable argument list replaced by the `ap` argument. Initialize `ap` with the `va_start` macro (and possibly with subsequent `va_arg` calls) from `<stdarg.h>`.

If the stream pointed to by `stream` has no orientation, `vfwprintf` makes the stream wide-oriented.

See also `fwprintf`.

Return Values

`n` The number of wide characters written.

Negative value

Indicates an error. The function sets `errno` to one of the following:

- `EILSEQ` – Invalid character detected.
- `EINVAL` – Insufficient arguments.
- `ENOMEM` – Not enough memory available for conversion.
- `ERANGE` – Floating-point calculations overflow.
- `EVMISERR` – Nontranslatable OpenVMS error. `vaxc$errno` contains the OpenVMS error code. This might indicate that conversion to a numeric value failed because of overflow.

The function can also set `errno` to the following as a result of errors returned from the I/O subsystem:

- `EBADF` – The file descriptor is not valid.
- `EIO` – I/O error.
- `ENOSPC` – No free space on the device containing the file.
- `ENXIO` – Device does not exist.
- `EPIPE` – Broken pipe.
- `ESPIPE` – Illegal seek in a file opened for append.
- `EVMISERR` – Nontranslatable OpenVMS error. `vaxc$errno` contains the OpenVMS error code. This indicates that an I/O error occurred for which there is no equivalent C error code.

Examples

The following example shows the use of the `vfwprintf` function in a general error reporting routine:

```
#include <stdarg.h>
#include <stdio.h>
#include <wchar.h>

void error(char *function_name, wchar_t *format, ... );
{
    va_list args;
    va_start(args, format);
    /*_print out name of function causing error */
    fwprintf(stderr, L"ERROR in %s: ", function_name);
    /*_print out remainder of message */
    vfwprintf(stderr, format, args);
    va_end(args);
}
```

vfwscanf

Reads input from the stream under control of a wide-character format string.

Format

```
#include <wchar.h>
```

```
int vfwscanf (FILE *stream, const wchar_t *format, va_list ap);
```

Arguments

stream

A file pointer.

format

A pointer to a wide-character string containing the format specifications.

ap

A list of expressions whose resultant types correspond to the conversion specifications given in the format specifications.

Description

The `vfwscanf` function is equivalent to the `fwscanf` function, except that instead of being called with a variable number of arguments, it is called with an argument list (*ap*) that has been initialized by `va_start` (and possibly with subsequent `va_arg` calls).

If the stream pointed to by *stream* has no orientation, `vfwscanf` makes the stream wide-oriented.

For more information about format and conversion specifications and their corresponding arguments, see Chapter 2.

Return Values

n	The number of successfully matched and assigned wide-character input items.
EOF	Indicates that a read error occurred before any conversion. The function sets <code>errno</code> . For a list of the values set by this function, see <code>vfscanf</code> .

vprintf

Prints formatted output based on an argument list.

This function is the same as the `printf` function except that instead of being called with a variable number of arguments, it is called with an argument list that has been initialized by the `va_start` macro (and possibly with subsequent `va_arg` calls) from `<stdarg.h>`.

Format

```
#include <stdio.h>
```

```
int vprintf (const char *format, va_list ap);
```

Arguments

format

A pointer to the string containing the format specification. For more information about format and conversion specifications and their corresponding arguments, see Chapter 2.

ap

A variable list of the items needed for output.

Description

See the `vfprintf` and `vsprintf` functions.

Return Values

x	The number of bytes written.
Negative value	Indicates an output error. The function sets <code>errno</code> . For a list of possible <code>errno</code> values set, see <code>fprintf</code> .

vscanf

vscanf

Reads formatted input based on an argument list.

Format

```
#include <stdio.h>
int vscanf (const char *format, va_list ap);
```

Arguments

format

A pointer to the string containing the format specification.

ap

A list of expressions whose resultant types correspond to the conversion specifications given in the format specifications.

Description

The `vscanf` function is the same as the `scanf` function except that instead of being called with a variable number of arguments, it is called with an argument list (*ap*) that has been initialized by the `va_start` macro (and possibly with subsequent `va_arg` calls).

For more information about format and conversion specifications and their corresponding arguments, see Chapter 2.

See also `scanf`, `vfscanf`, and `vsscanf`.

Return Values

n	The number of successfully matched and assigned input items.
EOF	Indicates that a read error occurred before any conversion. The function sets <code>errno</code> . For a list of the values set by this function, see <code>vfscanf</code> .

vsnprintf (Integrity servers, Alpha)

Prints formatted output based on an argument list.

Format

```
#include <stdio.h>

int vsnprintf (char *str, size_t n, const char *format, va_list ap);
```

Arguments**str**

A pointer to a string that will receive the formatted output.

format

A pointer to a character string that contains the format specification. For more information about format and conversion specifications and their corresponding arguments, see Chapter 2.

ap

A list of expressions whose resultant types correspond to the conversion specifications given in the format specifications.

Description

The `vsnprintf` function is the same as the `snprintf` function, but instead of being called with a variable number of arguments, it is called with an argument list that has been initialized by `va_start` (and possibly with subsequent `va_arg` calls).

This function does not invoke the `va_end` macro. Because the function invokes the `va_arg` macro, the value of `ap` after the return is unspecified.

Applications using `vsnprintf` should call `va_end(ap)` afterwards to clean up.

Return Values

x	The number of bytes (excluding the terminating null byte) that would be written to <code>str</code> if <code>n</code> is sufficiently large.
Negative value	Indicates an output error occurred. The function sets <code>errno</code> . For a list of possible <code>errno</code> values set, see <code>fprintf</code> .

vsprintf

vsprintf

Prints formatted output based on an argument list.

This function is the same as the `sprintf` function except that instead of being called with a variable number of arguments, it is called with an argument list that has been initialized by `va_start` (and possibly with subsequent `va_arg` calls).

Format

```
#include <stdio.h>

int vsprintf (char *str, const char *format, va_list ap);
```

Arguments

str

A pointer to a string that will receive the formatted output. This string is assumed to be large enough to hold the output.

format

A pointer to a character string that contains the format specification. For more information about format and conversion specifications and their corresponding arguments, see Chapter 2.

ap

A list of expressions whose resultant types correspond to the conversion specifications given in the format specifications.

Return Value

x	The number of bytes written.
Negative value	Indicates an output error occurred. The function sets <code>errno</code> . For a list of possible <code>errno</code> values set, see <code>fprintf</code> .

vsscanf

Reads formatted input based on an argument list.

Format

```
#include <stdio.h>
int vsscanf (char *str, const char *format, va_list ap);
```

Arguments

str

The address of the character string that provides the input text to sscanf.

format

A pointer to a character string that contains the format specification.

ap

A list of expressions whose resultant types correspond to the conversion specifications given in the format specifications.

Description

The vsscanf function is the same as the sscanf function except that instead of being called with a variable number of arguments, it is called with an argument list that has been initialized by va_start (and possibly with subsequent va_arg calls).

The vsscanf function is also equivalent to the vfscanf function, except that the first argument specifies a wide-character string rather than a stream. Reaching the end of the wide-character string is the same as encountering EOF for the vfscanf function.

For more information about format and conversion specifications and their corresponding arguments, see Chapter 2.

See also vsscanf and sscanf.

Return Values

n	The number of successfully matched and assigned input items.
EOF	Indicates that a read error occurred before any conversion. The function sets errno. For a list of the values set by this function, see vfscanf.

vswprintf

vswprintf

Writes output to the stream under control of the wide-character format string.

Format

```
#include <wchar.h>
```

```
int vswprintf (wchar_t *s, size_t n, const wchar_t *format, va_list ap);
```

Arguments

s

A pointer to a multibyte character sequence.

n

The maximum number of bytes that comprise the multibyte character.

format

A pointer to a wide-character string containing the format specifications. For more information about format and conversion specifications and their corresponding arguments, see Chapter 2.

ap

A variable list of the items needed for output.

Description

The `vswprintf` function is equivalent to the `swprintf` function, with the variable argument list replaced by the `ap` argument. Initialize `ap` with the `va_start` macro, and possibly with subsequent `va_arg` calls.

See also `swprintf`.

Return Values

`n` The number of wide characters written.

Negative value

Indicates an error. The function sets `errno` to one of the following:

- `EILSEQ` – Invalid character detected.
- `EINVAL` – Insufficient arguments.
- `ENOMEM` – Not enough memory available for conversion.
- `ERANGE` – Floating-point calculations overflow.
- `EVMSEERR` – Nontranslatable OpenVMS error. `vaxc$errno` contains the OpenVMS error code. This might indicate that conversion to a numeric value failed because of overflow.

The function can also set `errno` to the following as a result of errors returned from the I/O subsystem:

- `EBADF` – The file descriptor is not valid.
- `EIO` – I/O error.
- `ENOSPC` – No free space on the device containing the file.
- `ENXIO` – Device does not exist.
- `EPIPE` – Broken pipe.
- `ESPIPE` – Illegal seek in a file opened for append.
- `EVMSEERR` – Nontranslatable OpenVMS error. `vaxc$errno` contains the OpenVMS error code. This indicates that an I/O error occurred for which there is no equivalent C error code.

vswscanf

Reads input from the stream under control of the wide-character format string.

Format

```
#include <wchar.h>
int vswscanf (wchar_t *s, const wchar_t *format, va_list ap);
```

Arguments

s

A pointer to a wide-character string from which the input is to be obtained.

format

A pointer to a wide-character string containing the format specifications.

ap

A list of expressions whose results correspond to conversion specifications given in the format specification.

Description

The `vswscanf` function is equivalent to the `swscanf` function, except that instead of being called with a variable number of arguments, it is called with an argument list (*ap*) that has been initialized by `va_start` (and possibly with subsequent `va_arg` calls).

The `vswscanf` function is also equivalent to the `vfwscanf` function, except that the first argument specifies a wide-character string rather than a stream. Reaching the end of the wide-character string is the same as encountering EOF for the `vfwscanf` function.

For more information about format and conversion specifications and their corresponding arguments, see Chapter 2.

See also `vfwscanf` and `swscanf`.

Return Values

<code>n</code>	The number of wide characters read.
EOF	Indicates that a read error occurred before any conversion. The function sets <code>errno</code> . For a list of the values set by this function, see <code>vfscanf</code> .

vwprintf

Writes output to an array of wide characters under control of the wide-character format string.

Format

```
#include <wchar.h>
int vwprintf (const wchar_t *format, va_list ap);
```

Arguments

format

A pointer to a wide-character string containing the format specifications. For more information about format and conversion specifications and their corresponding arguments, see Chapter 2.

ap

The variable list of items needed for output.

Description

The `vwprintf` function is equivalent to the `wprintf` function, with the variable argument list replaced by the `ap` argument. Initialize `ap` with the `va_start` macro, and possibly with subsequent `va_arg` calls. The `vwprintf` function does not invoke the `va_end` macro.

See also `wprintf`.

Return Values

x	The number of wide characters written, not counting the terminating null wide character.
Negative value	Indicates an error. Either <i>n</i> or more wide characters were requested to be written, or a conversion error occurred, in which case <code>errno</code> is set to <code>EILSEQ</code> .

vwscanf

vwscanf

Reads input from an array of wide characters under control of a wide-character format string.

Format

```
#include <wchar.h>
int vwscanf (const wchar_t *format, va_list ap);
```

Arguments

format

A pointer to a wide-character string containing the format specifications.

ap

A list of expressions whose resultant types correspond to the conversion specifications given in the format specifications.

Description

The `vwscanf` function is equivalent to the `wscanf` function, except that instead of being called with a variable number of arguments, it is called with an argument list (*ap*) that has been initialized by `va_start` (and possibly with subsequent `va_arg` calls).

For more information about format and conversion specifications and their corresponding arguments, see Chapter 2.

See also `wscanf`.

Return Values

n	The number of wide characters read.
EOF	Indicates that a read error occurred before any conversion. The function sets <code>errno</code> . For a list of the values set by this function, see <code>vfscanf</code> .

wait

Checks the status of the child process before exiting. A child process is terminated when the parent process terminates.

Format

```
#include <wait.h>
pid_t wait (int *status);
```

Argument

status

The address of a location to receive the final status of the terminated child. The child can set the status with the `exit` function and the parent can retrieve this value by specifying *status*.

Description

The `wait` function suspends the parent process until the final status of a terminated child is returned from the child.

On OpenVMS Version 7.0 and higher systems, the `wait` function is equivalent to `waitpid(0, status, 0)` if you include `<wait.h>` and compile with the `_POSIX_EXIT` feature-test macro set (either with `/DEFINE=_POSIX_EXIT` or with `#define _POSIX_EXIT` at the top of your file, before any file inclusions).

Return Values

x	The process ID (PID) of the terminated child. If more than one child process was created, <code>wait</code> will return the PID of the terminated child that was most recently created. Subsequent calls will return the PID of the next most recently created, but terminated, child.
-1	No child process was spawned.

wait3

wait3

Waits for a child process to stop or terminate.

Format

```
#include <wait.h>
pid_t wait3 (int *status_location, int options, struct rusage *resource_usage);
```

Arguments

status_location

A pointer to a location that contains the termination status of the child process as defined in the `<wait.h>` header file.

Beginning with OpenVMS Version 7.2, when compiled with the `_VMS_WAIT` macro defined, the `wait3` function puts the OpenVMS completion code of the child process at the address specified in the `status_location` argument.

options

Flags that modify the behavior of the function. These flags are defined in the Description section.

resource_usage

The location of a structure that contains the resource utilization information for terminated child processes.

Description

The `wait3` function suspends the calling process until the request is completed, and redefines it so that only the calling thread is suspended.

The `options` argument modifies the behavior of the function. You can combine the flags for the `options` argument by specifying their bitwise inclusive OR. The flags are:

<code>WNOWAIT</code>	Specifies that the process whose status is returned in <code>status_location</code> is kept in a waitable state. You can wait for the process again with the same results.
<code>WNOHANG</code>	Prevents the suspension of the calling process. If there are child processes that stopped or terminated, one is chosen and the <code>waitpid</code> function returns its process ID, as when you do not specify the <code>WNOHANG</code> flag. If there are no terminated processes (that is, if <code>waitpid</code> suspends the calling process without the <code>WNOHANG</code> flag), 0 (zero) is returned. Because you can never wait for process 0, there is no confusion arising from this return.
<code>WUNTRACED</code>	Specifies that the call return additional information when the child processes of the current process stop because the child process received a <code>SIGTTIN</code> , <code>SIGTTOU</code> , <code>SIGSTOP</code> , or <code>SIGTSTOP</code> signal.

If the `wait3` function returns because the status of a child process is available, the process ID of the child process is returned. Information is stored in the location pointed to by `status_location`, if this pointer is not null.

The value stored in the location pointed to by *status_location* is 0 (zero) only if the status is returned from a terminated child process that did one of the following:

- Returned 0 from the main function.
- Passed 0 as the *status* argument to the `_exit` or `exit` function.

Regardless of the *status_location* value, you can define this information using the macros defined in the `<wait.h>` header file, which evaluate to integral expressions. In the following macro descriptions, the *status_value* argument is equal to the integer value pointed to by the *status_location* argument:

<code>WIFEXITED(status_value)</code>	Evaluates to a nonzero value if status was returned for a child process that terminated normally.
<code>WEXITSTATUS(status_value)</code>	If the value of <code>WIFEXITED(status_value)</code> is nonzero, this macro evaluates to the low-order 8 bits of the <i>status</i> argument that the child process passed to the <code>_exit</code> or <code>exit</code> function, or to the value the child process returned from the main function.
<code>WIFSIGNALED(status_value)</code>	Evaluates to a nonzero value if status was returned for a child process that terminated due to the receipt of a signal that was not intercepted.
<code>WTERMSIG(status_value)</code>	If the value of <code>WIFSIGNALED(status_value)</code> is nonzero, this macro evaluates to the number of the signal that caused the termination of the child process.
<code>WIFSTOPPED(status_value)</code>	Evaluates to a nonzero value if status was returned for a child process that is currently stopped.
<code>WSTOPSIG(status_value)</code>	If the value of <code>WIFSTOPPED(status_value)</code> is nonzero, this macro evaluates to the number of the signal that caused the child process to stop.
<code>WIFCONTINUED(status_value)</code>	Evaluates to a nonzero value if status was returned for a child process that has continued.

If the information stored at the location pointed to by *status_location* was stored there by a call to `wait3` that specified the `WUNTRACED` flag, one of the following macros evaluates to a nonzero value:

- `WIFEXITED(*status_value)`
- `WIFSIGNALED(*status_value)`
- `WIFSTOPPED(*status_value)`
- `WIFCONTINUED(*status_value)`

If the information stored in the location pointed to by *status_location* resulted from a call to `wait3` without the `WUNTRACED` flag specified, one of the following macros evaluates to a nonzero value:

- `WIFEXITED(*status_value)`
- `WIFSIGNALED(*status_value)`

wait3

The `wait3` function provides compatibility with BSD systems. The *resource_usage* argument points to a location that contains resource usage information for the child processes as defined in the `<resource.h>` header file.

If a parent process terminates without waiting for all of its child processes to terminate, the remaining child processes is assigned a parent process ID equal to the process ID of the `init` process.

See also `exit`, `-exit`, and `init`.

Return Values

0	Indicates success. There are no stopped or exited child processes, the <code>WNOHANG</code> option is specified.
x	The <i>process_id</i> of the child process. The status of a child process is available.
-1	Indicates an error; <code>errno</code> is set to one of the following values: <ul style="list-style-type: none">• <code>ECHILD</code> – There are no child processes to wait for.• <code>EINTR</code> – Terminated by receipt of a signal intercepted by the calling process.• <code>EFAULT</code> – The <i>status_location</i> or <i>resource_usage</i> argument points to a location outside of the address space of the process.• <code>EINVAL</code>— The value of the <i>options</i> argument is not valid.

wait4

Waits for a child process to stop or terminate.

Format

```
#include <wait.h>

pid_t wait4 (pid_t process_id, union wait *status_location, int options, struct rusage *resource_usage);
```

Arguments

status_location

A pointer to a location that contains the termination status of the child process as defined in the `<wait.h>` header file.

Beginning with OpenVMS Version 7.2, when compiled with the `_VMS_WAIT` macro defined, the `wait4` function puts the OpenVMS completion code of the child process at the address specified in the `status_location` argument.

process_id

The child process or set of child processes.

options

Flags that modify the behavior of the function. These flags are defined in the Description section.

resource_usage

The location of a structure that contains the resource utilization information for terminated child processes.

Description

The `wait4` function suspends the calling process until the request is completed.

The `process_id` argument allows the calling process to gather status from a specific set of child processes, according to the following rules:

If the <i>process_id</i> is	Then status is requested
Equal to <code>-1</code>	For any child process. In this respect, the <code>waitpid</code> function is equivalent to the <code>wait</code> function.
Greater than <code>0</code>	For a single child process and specifies the process ID.

The `wait4` function only returns the status of a child process from this set.

The `options` argument to the `wait4` function modifies the behavior of the function. You can combine the flags for the `options` argument by specifying their bitwise-inclusive OR. The flags are:

<code>WNOWAIT</code>	Specifies that the process whose status is returned in <code>status_location</code> is kept in a waitable state. You can wait for the process again with the same results.
----------------------	--

wait4

WNOHANG	Prevents the suspension of the calling process. If there are child processes that stopped or terminated, one is chosen and the <code>waitpid</code> function returns its process ID, as when you do not specify the WNOHANG flag. If there are no terminated processes (that is, if <code>waitpid</code> suspends the calling process without the WNOHANG flag), 0 is returned. Because you can never wait for process 0, there is no confusion arising from this return.
WUNTRACED	Specifies that the call return additional information when the child processes of the current process stop because the child process received a SIGTTIN, SIGTTOU, SIGSTOP, or SIGTSTOP signal.

If the `wait4` function returns because the status of a child process is available, the process ID of the child process is returned. Information is stored in the location pointed to by `status_location`, if this pointer is not null.

The value stored in the location pointed to by `status_location` is 0 only if the status is returned from a terminated child process that did one of the following:

- Returned 0 from the main function.
- Passed 0 as the `status` argument to the `_exit` or `exit` function.

Regardless of the `status_location` value, you can define this information using the macros defined in the `<wait.h>` header file, which evaluate to integral expressions. In the following macro descriptions, `status_value` is equal to the integer value pointed to by `status_location`:

<code>WIFEXITED(status_value)</code>	Evaluates to a nonzero value if status was returned for a child process that terminated normally.
<code>WEXITSTATUS(status_value)</code>	If the value of <code>WIFEXITED(status_value)</code> is nonzero, this macro evaluates to the low-order 8 bits of the <code>status</code> argument that the child process passed to the <code>_exit</code> or <code>exit</code> function, or to the value the child process returned from the main function.
<code>WIFSIGNALED(status_value)</code>	Evaluates to a nonzero value if status was returned for a child process that terminated due to the receipt of a signal that was not intercepted.
<code>WTERMSIG(status_value)</code>	If the value of <code>WIFSIGNALED(status_value)</code> is nonzero, this macro evaluates to the number of the signal that caused the termination of the child process.
<code>WIFSTOPPED(status_value)</code>	Evaluates to a nonzero value if status was returned for a child process that is currently stopped.
<code>WSTOPSIG(status_value)</code>	If the value of <code>WIFSTOPPED(status_value)</code> is nonzero, this macro evaluates to the number of the signal that caused the child process to stop.

WIFCONTINUED(*status_value*) Evaluates to a nonzero value if status was returned for a child process that has continued.

If the information stored at the location pointed to by *status_location* was stored there by a call to `wait4` that specified the `WUNTRACED` flag, one of the following macros evaluates to a nonzero value:

- WIFEXITED(**status_value*)
- WIFSIGNALED(**status_value*)
- WIFSTOPPED(**status_value*)
- WIFCONTINUED(**status_value*)

If the information stored in the location pointed to by *status_location* resulted from a call to `wait4` without the `WUNTRACED` flag specified, one of the following macros evaluates to a nonzero value:

- WIFEXITED(**status_value*)
- WIFSIGNALED(**status_value*)

The `wait4` function is similar to the `wait3` function. However, the `wait4` function waits for a specific child as indicated by the *process_id* argument. The *resource_usage* argument points to a location that contains resource usage information for the child processes as defined in the `<resource.h>` header file.

See also `exit` and `_exit`.

Return Values

0	Indicates success. There are no stopped or exited child processes, the <code>WNOHANG</code> option is specified.
x	The <i>process_id</i> of the child process. The status of a child process is available.
-1	Indicates an error; <code>errno</code> is set to one of the following values: <ul style="list-style-type: none"> • <code>ECHILD</code> – There are no child processes to wait for. • <code>EINTR</code> – Terminated by receipt of a signal intercepted by the calling process. • <code>EFAULT</code> – The <i>status_location</i> or <i>resource_usage</i> argument points to a location outside of the address space of the process. • <code>EINVAL</code>— The value of the <i>options</i> argument is not valid.

waitpid

waitpid

Waits for a child process to stop or terminate.

Format

```
#include <wait.h>
pid_t waitpid (pid_t process_id, int *status_location, int options);
```

Arguments

process_id

The child process or set of child processes.

status_location

A pointer to a location that contains the termination status of the child process as defined in the <wait.h> header file.

Beginning with OpenVMS Version 7.2, when compiled with the `_VMS_WAIT` macro defined, the `waitpid` function puts the OpenVMS completion code of the child process at the address specified in the `status_location` argument.

options

Flags that modify the behavior of the function. These flags are defined in the Description section.

Description

The `waitpid` function suspends the calling process until the request is completed. It is redefined so that only the calling thread is suspended.

If the `process_id` argument is `-1` and the `options` argument is `0`, the `waitpid` function behaves the same as the `wait` function. If these arguments have other values, the `waitpid` function is changed as specified by those values.

The `process_id` argument allows the calling process to gather status from a specific set of child processes, according to the following rules:

If the <code>process_id</code> is	Then status is requested
Equal to <code>-1</code>	For any child process. In this respect, the <code>waitpid</code> function is equivalent to the <code>wait</code> function.
Greater than <code>0</code>	For a single child process and specifies the process ID.

The `waitpid` function only returns the status of a child process from this set.

The `options` argument to the `waitpid` function modifies the behavior of the function. You can combine the flags for the `options` argument by specifying their bitwise-inclusive OR. The flags are:

<code>WCONTINUED</code>	Specifies that the following is reported to the calling process: the status of any continued child process specified by the <code>process_id</code> argument whose status is unreported since it continued.
-------------------------	---

WNOWAIT	Specifies that the process whose status is returned in <i>status_location</i> is kept in a waitable state. You can wait for the process again with the same results.
WNOHANG	Prevents the calling process from being suspended. If there are child processes that stopped or terminated, one is chosen and waitpid returns its PID, as when you do not specify the WNOHANG flag. If there are no terminated processes (that is, if waitpid suspends the calling process without the WNOHANG flag), 0 (zero) is returned. Because you can never wait for process 0, there is no confusion arising from this return.
WUNTRACED	Specifies that the call return additional information when the child processes of the current process stop because the child process received a SIGTTIN, SIGTTOU, SIGSTOP, or SIGTSTOP signal.

If the waitpid function returns because the status of a child process is available, the process ID of the child process is returned. Information is stored in the location pointed to by *status_location*, if this pointer is not null. The value stored in the location pointed to by *status_location* is 0 only if the status is returned from a terminated child process that did one of the following:

- Returned 0 from the main function.
- Passed 0 as the *status* argument to the `_exit` or `exit` function.

Regardless of the value of *status_location*, you can define this information using the macros defined in the `<wait.h>` header file, which evaluate to integral expressions. In the following function descriptions, *status_value* is equal to the integer value pointed to by *status_location*:

WIFEXITED(<i>status_value</i>)	Evaluates to a nonzero value if status was returned for a child process that terminated normally.
WEXITSTATUS(<i>status_value</i>)	If the value of WIFEXITED(<i>status_value</i>) is nonzero, this macro evaluates to the low-order 8 bits of the <i>status</i> argument that the child process passed to the <code>_exit</code> or <code>exit</code> function, or to the value the child process returned from the main function.
WIFSIGNALED(<i>status_value</i>)	Evaluates to a nonzero value if status returned for a child process that terminated due to the receipt of a signal not intercepted.
WTERMSIG(<i>status_value</i>)	If the value of WIFSIGNALED(<i>status_value</i>) is nonzero, this macro evaluates to the number of the signal that caused the termination of the child process.
WIFSTOPPED(<i>status_value</i>)	Evaluates to a nonzero value if status was returned for a child process that is currently stopped.

waitpid

<code>WSTOPSIG(status_value)</code>	If the value of <code>WIFSTOPPED(status_value)</code> is nonzero, this macro evaluates to the number of the signal that caused the child process to stop.
<code>WIFCONTINUED(status_value)</code>	Evaluates to a nonzero value if status returned for a child process that continued.

If the information stored at the location pointed to by *status_location* is stored there by a call to `waitpid` that specified the `WUNTRACED` flag, one of the following macros evaluates to a nonzero value:

- `WIFEXITED(*status_value)`
- `WIFSIGNALED(*status_value)`
- `WIFSTOPPED(*status_value)`
- `WIFCONTINUED(*status_value)`

If the information stored in the buffer pointed to by *status_location* resulted from a call to `waitpid` without the `WUNTRACED` flag specified, one of the following macros evaluates to a nonzero value:

- `WIFEXITED(*status_value)`
- `WIFSIGNALED(*status_value)`

If a parent process terminates without waiting for all of its child processes to terminate, the remaining child processes is assigned a parent process ID equal to the process ID of the init process.

See also `exit`, `_exit`, and `wait`.

Return Values

0	Indicates success. If the <code>WNOHANG</code> option was specified, and there are no stopped or exited child processes, the <code>waitpid</code> function also returns a value of 0.
---	---

-1

Indicates an error; `errno` is set to one of the following values:

- **ECHILD**—The calling process has no existing unwaited-for child processes. The process or process group ID specified by the *process_id* argument does not exist or is not a child process of the calling process.
- **EINTR**—The function was terminated by receipt of a signal.
If the `waitpid` function returns because the status of a child process is available, the process ID of the child is returned to the calling process. If they return because a signal was intercepted by the calling process, `-1` is returned.
- **EFAULT**— The *status_location* argument points to a location outside of the address space of the process.
- **EINVAL**— The value of the *options* argument is not valid.

wcrtomb

wcrtomb

Converts the wide character to its multibyte character representation.

Format

```
#include <wchar.h>
size_t wcrtomb (char *s, wchar_t wc, mbstate_t *ps);
```

Arguments

s
A pointer to the resulting multibyte character.

wc
A wide character.

ps
A pointer to the `mbstate_t` object. If a NULL pointer is specified, the function uses its internal `mbstate_t` object. `mbstate_t` is an opaque datatype intended to keep the conversion state for the state-dependent codesets.

Description

If *s* is a NULL pointer, the `wcrtomb` function is equivalent to the call:

```
wcrtomb (buf, L'\0', ps)
```

where *buf* is an internal buffer.

If *s* is not a NULL pointer, the `wcrtomb` function determines the number of bytes needed to represent the multibyte character that corresponds to the wide character specified by *wc* (including any shift sequences), and stores the resulting bytes in the array whose first element is pointed to by *s*. At most `MB_CUR_MAX` bytes are stored.

If *wc* is a null wide character, a null byte is stored preceded by any shift sequence needed to restore the initial shift state. The resulting state described is the initial conversion state.

Return Values

- | | |
|----|---|
| n | The number of bytes stored in the resulting array, including any shift sequences to represent the multibyte character. |
| -1 | Indicates an encoding error. The <i>wc</i> argument is not a valid wide character. The global <code>errno</code> is set to <code>EILSEQ</code> ; the conversion state is undefined. |

wcscat

Concatenates two wide-character strings.

Format

```
#include <wchar.h>

wchar_t *wcscat (wchar_t *wstr_1, const wchar_t *wstr_2);
```

Function Variants

The `wcscat` function has variants named `_wcscat32` and `_wcscat64` for use with 32-bit and 64-bit pointer sizes, respectively. See Section 1.9 for more information on using pointer-size-specific functions.

Arguments

wstr_1, wstr_2
Pointers to null-terminated wide-character strings.

Description

The `wcscat` function appends the wide-character string `wstr_2`, including the terminating null character, to the end of `wstr_1`.

See also `wcsncat`.

Return Value

x	The first argument, <code>wstr_1</code> , which is assumed to be large enough to hold the concatenated result.
---	--

Example

```
#include <stdlib.h>
#include <stdio.h>
#include <wchar.h>
#include <string.h>

/* This program concatenates two wide-character strings using */
/* the wcscat function, and then manually compares the result */
/* to the expected result */

#define S1LENGTH 10
#define S2LENGTH 8

main()
{
    int i;
    wchar_t s1buf[S1LENGTH + S2LENGTH];
    wchar_t s2buf[S2LENGTH];
    wchar_t test1[S1LENGTH + S2LENGTH];

    /* Initialize the three wide-character strings */

    if (mbstowcs(s1buf, "abcmnxyz", S1LENGTH) == (size_t)-1) {
        perror("mbstowcs");
        exit(EXIT_FAILURE);
    }
}
```

wcscat

```
if (mbstowcs(s2buf, " orthis", S2LENGTH) == (size_t)-1) {
    perror("mbstowcs");
    exit(EXIT_FAILURE);
}
if (mbstowcs(test1, "abcmnxyz orthis", S1LENGTH + S2LENGTH)
    == (size_t)-1) {
    perror("mbstowcs");
    exit(EXIT_FAILURE);
}
/* Concatenate s1buf with s2buf, placing the result
/* into * s1buf. Then compare s1buf with the expected
/* result in test1. */
wcscat(s1buf, s2buf);
for (i = 0; i < S1LENGTH + S2LENGTH - 2; i++) {
    /* Check that each character is correct */
    if (test1[i] != s1buf[i]) {
        printf("Error in wcscat\n");
        exit(EXIT_FAILURE);
    }
}
printf("Concatenated string: <%S>\n", s1buf);
}
```

Running the example produces the following result:

```
Concatenated string: <abcmnxyz orthis>
```

wcschr

Scans for a wide character in a specified wide-character string.

Format

```
#include <wchar.h>

wchar_t *wcschr (const wchar_t *wstr, wchar_t wc);
```

Function Variants

The `wcschr` function has variants named `_wcschr32` and `_wcschr64` for use with 32-bit and 64-bit pointer sizes, respectively. See Section 1.9 for more information on using pointer-size-specific functions.

Arguments

wstr
A pointer to a null-terminated wide-character string.

wc
A character of type `wchar_t`.

Description

The `wcschr` function returns the address of the first occurrence of a specified wide character in a null-terminated wide-character string. The terminating null character is considered to be part of the string.

See also `wcsrchr`.

Return Values

<code>x</code>	The address of the first occurrence of the specified wide character.
<code>NULL</code>	Indicates that the wide character does not occur in the string.

Example

```
#include <stdlib.h>
#include <stdio.h>
#include <wchar.h>
#include <string.h>

#define BUFF_SIZE 50

main()
{
    int i;
    wchar_t s1buf[BUFF_SIZE];
    wchar_t *status;

    /* Initialize the buffer */
    if (mbstowcs(s1buf, "abcdefghijkl lkjihgfedcba", BUFF_SIZE)
        == (size_t)-1) {
```

wcschr

```
        perror("mbstowcs");
        exit(EXIT_FAILURE);
    }
/* This program checks the wcschr function by incrementally */
/* going through a string that ascends to the middle and */
/* then descends towards the end. */
    for (i = 0; (slbuf[i] != '\0') && (slbuf[i] != ' '); i++) {
        status = wcschr(slbuf, slbuf[i]);
        /* Check for pointer to leftmost character - test 1. */
        if (status != &slbuf[i]) {
            printf("Error in wcschr\n");
            exit(EXIT_FAILURE);
        }
    }
    printf("Program completed successfully\n");
}
```

When this example program is run, it produces the following result:

```
Program completed successfully
```

wcscmp

Compares two wide-character strings. It returns an integer that indicates if the strings are different, and how they differ.

Format

```
#include <wchar.h>

int wcscmp (const wchar_t *wstr_1, const wchar_t *wstr_2);
```

Arguments

wstr_1, wstr_2
Pointers to null-terminated wide-character strings.

Description

The `wcscmp` function compares the wide characters in *wstr_1* with those in *wstr_2*. If the characters differ, the function returns:

- An integer less than 0, if the codepoint of the first differing character in *wstr_1* is less than the codepoint of the corresponding character in *wstr_2*
- An integer greater than 0, if the codepoint of the first differing character in *wstr_1* is greater than the codepoint of the corresponding character in *wstr_2*

If the wide-character strings are identical, the function returns 0.

Unlike the `wscoll` function, the `wcscmp` function compares the string based on the binary value of each wide character.

See also `wcsncmp`.

Return Values

< 0	Indicates that <i>wstr_1</i> is less than <i>wstr_2</i> .
= 0	Indicates that <i>wstr_1</i> equals <i>wstr_2</i> .
> 0	Indicates that <i>wstr_1</i> is greater than <i>wstr_2</i> .

wcscoll

wcscoll

Compares two wide-character strings and returns an integer that indicates if the strings differ, and how they differ. The function uses the collating information in the LC_COLLATE category of the current locale to determine how the comparison is performed.

Format

```
#include <wchar.h>

int wcscoll (const wchar_t *ws1, const wchar_t *ws2);
```

Arguments

ws1, ws2
Pointers to wide-character strings.

Description

The `wcscoll` function, unlike `wscmp`, compares two strings in a locale-dependent manner. Because no value is reserved for error indication, the application must check for one by setting `errno` to 0 before the function call and testing it after the call.

See also `wcsxfrm`.

Return Values

< 0	Indicates that <i>ws1</i> is less than <i>ws2</i> .
0	Indicates that the strings are equal.
> 0	Indicates that <i>ws1</i> is greater than <i>ws2</i> .

```
    if (mbstowcs(w_string, "jklmabcjklabcdehijklmno", STRING_SIZE)
        == (size_t)-1) {
        perror("mbstowcs");
        exit(EXIT_FAILURE);
    }
    /* Using wcscspn - work out the largest string in w_string */
    /* which consists entirely of characters NOT from buffer */
    result = wcscspn(w_string, buffer);
    printf("Longest segment NOT found in w_string is: %d", result);
}
```

Running the example program produces the following result:

```
Longest segment NOT found in w_string is: 4
```

wcsftime

wcsftime

Uses date and time information stored in a `tm` structure to create a wide-character output string. The format of the output string is controlled by a format string.

Format

```
#include <wchar.h>
```

```
size_t wcsftime (wchar_t *wcs, size_t maxsize, const char *format, const struct tm *timeptr); (XPG4)
```

```
size_t wcsftime (wchar_t *wcs, size_t maxsize, const wchar_t *format, const struct tm *timeptr); (ISO C)
```

Function Variants

Compiling with the `_DECC_V4_SOURCE` and `_VMS_V6_SOURCE` feature-test macros defined enables a local-time-based entry point to the `wcsftime` function that is equivalent to the behavior before OpenVMS Version 7.0.

Arguments

wcs

A pointer to the resultant wide-character string.

maxsize

The maximum number of wide characters to be stored in the resultant string.

format

A pointer to the string that controls the format of the output string. For the XPG4 interface, this argument is a pointer to a constant character string. For the ISO C interface, it is a pointer to a constant wide-character string.

timeptr

A pointer to the local time structure. The `tm` structure is defined in the `<time.h>` header file.

Description

The `wcsftime` function uses data in the structure pointed to by `timeptr` to create the wide-character string pointed to by `wcs`. A maximum of `maxsize` wide characters is copied to `wcs`.

The format string consists of zero or more conversion specifications and ordinary characters. All ordinary characters (including the terminating null character) are copied unchanged into the output string. A conversion specification defines how data in the `tm` structure is formatted in the output string.

A conversion specification consists of a percent (%) character followed by one or more optional characters (see Table REF-13), and ending with a conversion specifier (see Table REF-14). If any of the optional characters listed in Table REF-13 are specified, they must appear in the order shown in the table.

Table REF–13 Optional Elements of wcsftime Conversion Specifications

Element	Meaning
–	Optional with the field width to specify that the field is left-justified and padded with spaces. This cannot be used with the 0 element.
0	Optional with the field width to specify that the field is right-justified and padded with zeros. This cannot be used with the – element.
field width	A decimal integer that specifies the maximum field width
.precision	A decimal integer that specifies the precision of data in a field. For the d, H, I, j, m, M, o, S, U, w, W, y, and Y conversion specifiers, the precision specifier is the minimum number of digits to appear in the field. If the conversion specification has fewer digits than that specified by the precision, leading zeros are added. For the a, A, b, B, c, D, E, h, n, N, p, r, t, T, x, X, Z, and % conversion specifiers, the precision specifier is the maximum number of wide characters to appear in the field. If the conversion specification has more characters than that specified by the precision, characters are truncated on the right. The default precision for the d, H, I, m, M, o, S, U, w, W, y, and Y conversion specifiers is 2, and the default precision for the j conversion specifier is 3.

Note that the list of optional elements of conversion specifications from Table REF–13 are HP extensions to the XPG4 specification.

Table REF–14 lists the conversion specifiers. The wcsftime function uses fields in the LC_TIME category of the program’s current locale to provide a value. For example, if %B is specified, the function accesses the *mon* field in LC_TIME to find the full month name for the month specified in the tm structure. The result of using invalid conversion specifiers is undefined.

Table REF–14 wcsftime Conversion Specifiers

Specifier	Replaced by
a	The locale’s abbreviated weekday name.
A	The locale’s full weekday name.
b	The locale’s abbreviated month name.
B	The locale’s full month name.
c	The locale’s appropriate date and time representation.
C	The century number (the year divided by 100 and truncated to an integer) as a decimal number (00 – 99).
d	The day of the month as a decimal number (01 – 31).
D	Same as %m/%d/%y.
e	The day of the month as a decimal number (1 – 31) in a 2-digit field with the leading space character fill.
Ec	The locale’s alternative date and time representation.

(continued on next page)

Table REF–14 (Cont.) wcsftime Conversion Specifiers

Specifier	Replaced by
EC	The name of the base year (period) in the locale’s alternative representation.
Ex	The locale’s alternative date representation.
Ey	The offset from the base year (%EC) in the locale’s alternative representation.
EY	The locale’s full alternative year representation.
h	Same as %b.
H	The hour (24-hour clock) as a decimal number (00 – 23).
I	The hour (12-hour clock) as a decimal number (01 – 12).
j	The day of the year as a decimal number (001 – 366).
m	The month as a decimal number (01 – 12).
M	The minute as a decimal number (00 – 59).
n	The new-line character.
Od	The day of the month using the locale’s alternative numeric symbols.
Oe	The date of the month using the locale’s alternative numeric symbols.
OH	The hour (24-hour clock) using the locale’s alternative numeric symbols.
OI	The hour (12-hour clock) using the locale’s alternative numeric symbols.
Om	The month using the locale’s alternative numeric symbols.
OM	The minutes using the locale’s alternative numeric symbols.
OS	The seconds using the locale’s alternative numeric symbols.
Ou	The weekday as a number in the locale’s alternative representation (Monday=1).
OU	The week number of the year (Sunday as the first day of the week) using the locale’s alternative numeric symbols.
OV	The week number of the year (Monday as the first day of the week) as a decimal number (01 –53) using the locale’s alternative numeric symbols. If the week containing January 1 has four or more days in the new year, it is considered as week 1. Otherwise, it is considered as week 53 of the previous year, and the next week is week 1.
Ow	The weekday as a number (Sunday=0) using the locale’s alternative numeric symbols.
OW	The week number of the year (Monday as the first day of the week) using the locale’s alternative numeric symbols.
Oy	The year without the century using the locale’s alternative numeric symbols.

(continued on next page)

Table REF-14 (Cont.) wcsftime Conversion Specifiers

Specifier	Replaced by
p	The locale's equivalent of the AM/PM designations associated with a 12-hour clock.
r	The time in AM/PM notation.
R	The time in 24-hour notation (%H:%M).
S	The second as a decimal number (00 – 61).
t	The tab character.
T	The time (%H:%M:%S).
u	The weekday as a decimal number between 1 and 7 (Monday=1).
U	The week number of the year (the first Sunday as the first day of week 1) as a decimal number (00 – 53).
V	The week number of the year (Monday as the first day of the week) as a decimal number (00 – 53). If the week containing January 1 has four or more days in the new year, it is considered as week 1. Otherwise, it is considered as week 53 of the previous year, and the next week is week 1.
w	The weekday as a decimal number (0 [Sunday] – 6).
W	The week number of the year (the first Monday as the first day of week 1) as a decimal number (00 – 53).
x	The locale's appropriate date representation
X	The locale's appropriate time representation
y	The year without century as a decimal number (00 – 99).
Y	The year with century as a decimal number.
Z	Time-zone name or abbreviation. If time-zone information is not available, no character is output.
%	Literal % character.

Return Values

x	The number of wide characters placed into the array pointed to by <i>wcs</i> , not including the terminating null character.
0	Indicates an error occurred. The contents of the array are indeterminate.

Example

```

/* Exercise the wcsftime formatting routine.          */
/* NOTE: the format string is an "L" (or wide character) */
/*      string indicating that this call is NOT in      */
/*      the XPG4 format, but rather in ISO C format.    */
#include <stdlib.h>
#include <stdio.h>
#include <time.h>
#include <wchar.h>
#include <locale.h>
#include <errno.h>

```

wcsftime

```
#define NUM_OF_DATES 7
#define BUF_SIZE 256

/* This program formats a number of different dates, once using the
/* C locale and then using the fr_FR.ISO8859-1 locale. Date and time
/* formatting is done using wcsftime(). */

main()
{
    int count,
        i;
    wchar_t buffer[BUF_SIZE];
    struct tm *tm_ptr;
    time_t time_list[NUM_OF_DATES] =
    {500, 68200000, 694223999,
     694224000, 704900000, 705000000,
     705900000};

    /* Display dates using the C locale */
    printf("\nUsing the C locale:\n\n");
    setlocale(LC_ALL, "C");
    for (i = 0; i < NUM_OF_DATES; i++) {
        /* Convert to a tm structure */
        tm_ptr = localtime(&time_list[i]);
        /* Format the date and time */
        count = wcsftime(buffer, BUF_SIZE, L"Date: %A %d %B %Y\nTime: %T\n",
                        tm_ptr);
        if (count == 0) {
            perror("wcsftime");
            exit(EXIT_FAILURE);
        }
        /* Print the result */
        printf("%S", buffer);
    }

    /* Display dates using the fr_FR.ISO8859-1 locale */
    printf("\nUsing the fr_FR.ISO8859-1 locale:\n\n");
    setlocale(LC_ALL, "fr_FR.ISO8859-1");
    for (i = 0; i < NUM_OF_DATES; i++) {
        /* Convert to a tm structure */
        tm_ptr = localtime(&time_list[i]);
        /* Format the date and time */
        count = wcsftime(buffer, BUF_SIZE, L"Date: %A %d %B %Y\nTime: %T\n",
                        tm_ptr);
        if (count == 0) {
            perror("wcsftime");
            exit(EXIT_FAILURE);
        }
        /* Print the result */
        printf("%S", buffer);
    }
}
```

Running the example program produces the following result:

Using the C locale:

Date: Thursday 01 January 1970
Time: 00:08:20

Date: Tuesday 29 February 1972
Time: 08:26:40

Date: Tuesday 31 December 1991
Time: 23:59:59

Date: Wednesday 01 January 1992
Time: 00:00:00

Date: Sunday 03 May 1992
Time: 13:33:20

Date: Monday 04 May 1992
Time: 17:20:00

Date: Friday 15 May 1992
Time: 03:20:00

Using the fr_FR.ISO8859-1 locale:

Date: jeudi 01 janvier 1970
Time: 00:08:20

Date: mardi 29 février 1972
Time: 08:26:40

Date: mardi 31 décembre 1991
Time: 23:59:59

Date: mercredi 01 janvier 1992
Time: 00:00:00

Date: dimanche 03 mai 1992
Time: 13:33:20

Date: lundi 04 mai 1992
Time: 17:20:00

Date: vendredi 15 mai 1992
Time: 03:20:00

wcslen

wcslen

Returns the number of wide characters in a wide-character string. The returned length does not include the terminating null character.

Format

```
#include <wchar.h>
size_t wcslen (const wchar_t *wstr);
```

Argument

wstr
A pointer to a null-terminated wide-character string.

Return Value

x	The length of the wide-character string, excluding the terminating null wide character.
---	---

wcsncat

Concatenates a counted number of wide-characters from one string to another.

Format

```
#include <wchar.h>

wchar_t *wcsncat (wchar_t *wstr_1, const wchar_t *wstr_2, size_t maxchar);
```

Function Variants

The `wcsncat` function has variants named `_wcsncat32` and `_wcsncat64` for use with 32-bit and 64-bit pointer sizes, respectively. See Section 1.9 for more information on using pointer-size-specific functions.

Arguments

wstr_1, wstr_2

Pointers to null-terminated wide-character strings.

maxchar

The maximum number of wide characters from *wstr_2* that are copied to *wstr_1*. If *maxchar* is 0, no characters are copied from *wstr_2*.

Description

The `wcsncat` function appends wide characters from the wide-character string *wstr_2* to the end of *wstr_1*, up to a maximum of *maxchar* characters. A terminating null wide character is always appended to the result of the `wcsncat` function. Therefore, the maximum number of wide characters that can end up in *wstr_1* is `wcslen(wstr_1) + maxchar + 1`.

See also `wcscat`.

Return Value

x	The first argument, <i>wstr_1</i> , which is assumed to be large enough to hold the concatenated result.
---	--

Example

```
#include <stdlib.h>
#include <stdio.h>
#include <wchar.h>
#include <string.h>

/* This program concatenates two wide-character strings using */
/* the wcsncat function, and then manually compares the result */
/* to the expected result */

#define S1LENGTH 10
#define S2LENGTH 8
#define SIZE 3
```

wcsncat

```
main()
{
    int i;
    wchar_t s1buf[S1LENGTH + S2LENGTH];
    wchar_t s2buf[S2LENGTH];
    wchar_t test1[S1LENGTH + S2LENGTH];

    /* Initialize the three wide-character strings */

    if (mbstowcs(s1buf, "abcmnxyz", S1LENGTH) == (size_t)-1) {
        perror("mbstowcs");
        exit(EXIT_FAILURE);
    }

    if (mbstowcs(s2buf, " orthis", S2LENGTH) == (size_t)-1) {
        perror("mbstowcs");
        exit(EXIT_FAILURE);
    }

    if (mbstowcs(test1, "abcmnxyz orthis", S1LENGTH + SIZE)
        == (size_t)-1) {
        perror("mbstowcs");
        exit(EXIT_FAILURE);
    }

    /* Concatenate s1buf with SIZE characters from s2buf, */
    /* placing the result into s1buf. Then compare s1buf */
    /* with the expected result in test1. */
    wcsncat(s1buf, s2buf, SIZE);

    for (i = 0; i <= S1LENGTH + SIZE - 2; i++) {
        /* Check that each character is correct */
        if (test1[i] != s1buf[i]) {
            printf("Error in wcsncat\n");
            exit(EXIT_FAILURE);
        }
    }

    printf("Concatenated string: <%S>\n", s1buf);
}
```

Running the example produces the following result:

```
Concatenated string: <abcmnxyz or>
```

wcsncmp

Compares not more than *maxchar* characters of two wide-character strings. It returns an integer that indicates if the strings are different, and how they differ.

Format

```
#include <wchar.h>
```

```
int wcsncmp (const wchar_t *wstr_1, const wchar_t *wstr_2, size_t maxchar);
```

Arguments

wstr_1, wstr_2

Pointers to null-terminated wide-character strings.

maxchar

The maximum number of characters to search in both *wstr_1* and *wstr_2*. If *maxchar* is 0, no comparison is performed and 0 is returned (the strings are considered equal).

Description

The strings are compared until a null character is encountered, the strings differ, or *maxchar* is reached. If characters differ, *wcsncmp* returns:

- An integer less than 0 if the codepoint of the first differing character in *wstr_1* is less than the codepoint of the corresponding character in *wstr_2*
- An integer greater than 0 if the codepoint of the first differing character in *wstr_1* is greater than the codepoint of the corresponding character in *wstr_2*

If no differences are found after comparing *maxchar* characters, the function returns 0.

See also *wcscmp*.

Return Values

< 0	Indicates that <i>wstr_1</i> is less than <i>wstr_2</i> .
0	Indicates that <i>wstr_1</i> equals <i>wstr_2</i> .
> 0	Indicates that <i>wstr_1</i> is greater than <i>wstr_2</i> .

wcpbrk

Searches a wide-character string for the first occurrence of one of a specified set of wide characters.

Format

```
#include <wchar.h>
```

```
wchar_t *wcpbrk (const wchar_t *wstr, const wchar_t *charset);
```

Function Variants

The `wcpbrk` function has variants named `_wcpbrk32` and `_wcpbrk64` for use with 32-bit and 64-bit pointer sizes, respectively. See Section 1.9 for more information on using pointer-size-specific functions.

Arguments

wstr

A pointer to a wide-character string. If this is a null string, `NULL` is returned.

charset

A pointer to a wide-character string containing the set of wide characters for which the function will search.

Description

The `wcpbrk` function scans the wide characters in the string, stops when it encounters a wide character found in *charset*, and returns the address of the first character in the string that appears in the character set.

Return Values

x	The address of the first wide character in the string that is in the set.
NULL	Indicates that none of the characters are in <i>charset</i> .

wcsrchr

Scans for the last occurrence of a wide character in a given string.

Format

```
#include <wchar.h>
wchar_t *wcsrchr (const wchar_t *wstr, wchar_t wc);
```

Function Variants

The `wcsrchr` function has variants named `_wcsrchr32` and `_wcsrchr64` for use with 32-bit and 64-bit pointer sizes, respectively. See Section 1.9 for more information on using pointer-size-specific functions.

Arguments

wstr

A pointer to a null-terminated wide-character string.

wc

A character of type `wchar_t`.

Description

The `wcsrchr` function returns the address of the last occurrence of a given wide character in a null-terminated wide-character string. The terminating null character is considered to be part of the string.

See also `wcschr`.

Return Values

<code>x</code>	The address of the last occurrence of the specified wide character.
<code>NULL</code>	Indicates that the wide character does not occur in the string.

Example

```
#include <stdlib.h>
#include <stdio.h>
#include <wchar.h>
#include <string.h>

#define BUFF_SIZE 50
#define STRING_SIZE 6

main()
{
    int i;
    wchar_t s1buf[BUFF_SIZE],
            w_string[STRING_SIZE];
    wchar_t *status;
    wchar_t *pbuf = s1buf;

    /* Initialize the buffer */
    if (mbstowcs(s1buf, "hijklabcdefg ytuhiijklfedcba", BUFF_SIZE)
```



```

        == (size_t)-1) {
            perror("mbstowcs");
            exit(EXIT_FAILURE);
        }
        /* Initialize the string to be searched for */

        if (mbstowcs(w_string, "hijkl", STRING_SIZE) == (size_t)-1) {
            perror("mbstowcs");
            exit(EXIT_FAILURE);
        }
        /* This program checks the wcsrchr function by searching for */
        /* the last occurrence of a string in the buffer slbuf and */
        /* prints out the contents of slbuff from the location of */
        /* the string found. */
        status = wcsrchr(slbuf, w_string[0]);
        /* Check for pointer to start of rightmost character string. */
        if (status == pbuf) {
            printf("Error in wcsrchr\n");
            exit(EXIT_FAILURE);
        }

        printf("Program completed successfully\n");
        printf("String found : [%S]\n", status);
    }

```

Running the example produces the following result:

```

Program completed successfully
String found : [hijklfedcba]

```

wcsrtombs

Converts a sequence of wide characters into a sequence of corresponding multibyte characters.

Format

```
#include <wchar.h>
```

```
size_t wcsrtombs (char *dst, const wchar_t **src, size_t len, mbstate_t *ps);
```

Function Variants

The `wcsrtombs` function has variants named `_wcsrtombs32` and `_wcsrtombs64` for use with 32-bit and 64-bit pointer sizes, respectively. See Section 1.9 for more information on using pointer-size-specific functions.

Arguments

dst

A pointer to the destination array for converted multibyte character sequence.

src

An address of the pointer to an array containing the sequence of wide characters to be converted.

len

The maximum number of bytes that can be stored in the array pointed to by *dst*.

ps

A pointer to the `mbstate_t` object. If a NULL pointer is specified, the function uses its internal `mbstate_t` object. `mbstate_t` is an opaque datatype intended to keep the conversion state for the state-dependent codesets.

Description

The `wcsrtombs` function converts a sequence of wide characters from the array indirectly pointed to by *src* into a sequence of corresponding multibyte characters, beginning in the conversion state described by the object pointed to by *ps*.

If *dst* is not a NULL pointer, the converted characters are then stored into the array pointed to by *dst*. Conversion continues up to and including a terminating null wide character, which is also stored.

Conversion stops earlier in two cases:

- When a code is reached that does not correspond to a valid multibyte character
- If *dst* is not a NULL pointer, when the next multibyte character would exceed the limit of *len* total bytes to be stored into the array pointed to by *dst*

Each conversion takes place as if by a call to the `wcrtomb` function.

If *dst* is not a NULL pointer, the pointer object pointed to by *src* is assigned either a NULL pointer (if the conversion stopped because it reached a terminating null wide character) or the address just beyond the last wide character converted (if any). If conversion stopped because it reached a terminating null wide character, the resulting state described is the initial conversion state.

If the `wcsrtombs` function is called as a counting function, which means that `dst` is a `NULL` pointer, the value of the internal `mbstate_t` object will remain unchanged.

See also `wcrtomb`.

Return Values

- | | |
|-----------------|--|
| <code>x</code> | The number of bytes stored in the resulting array, not including the terminating null (if any). |
| <code>-1</code> | Indicates an encoding error—a character that does not correspond to a valid multibyte character was encountered; <code>errno</code> is set to <code>EILSEQ</code> ; the conversion state is undefined. |

```
/* Initialize the string */
if (mbstowcs(w_string, "abcdjklmabcjklabcdehijkl", STRING_SIZE)
    == (size_t)-1) {
    perror("mbstowcs");
    exit(EXIT_FAILURE);
}
/* Using wcsspn - work out the largest string in w_string */
/* that consists entirely of characters from buffer */
result = wcsspn(w_string, buffer);
printf("Longest segment found in w_string is: %d", result);
}
```

Running the example program produces the following result:

```
Longest segment found in w_string is: 5
```

wcsstr

wcsstr

Locates the first occurrence in the string pointed to by *s1* of the sequence of wide characters in the string pointed to by *s2*.

Format

```
#include <wchar.h>
wchar_t *wcsstr (const wchar_t *s1, const wchar_t *s2);
```

Function Variants

The `wcsstr` function has variants named `_wcsstr32` and `_wcsstr64` for use with 32-bit and 64-bit pointer sizes, respectively. See Section 1.9 for more information on using pointer-size-specific functions.

Arguments

s1, s2
Pointers to null-terminated, wide-character strings.

Description

If *s2* points to a wide-character string of 0 length, the `wcsstr` function returns *s1*.

Return Values

x	A pointer to the located string.
NULL	Indicates an error; the string was not found.

wcstod

0	Indicates the conversion could not be performed. The function sets errno to one of: <ul style="list-style-type: none">• <code>EINVAL</code> – No conversion could be performed.• <code>ERANGE</code> – The value would cause an underflow.• <code>ENOMEM</code> – Not enough memory available for internal conversion buffer.
<code>±HUGE_VAL</code>	Overflow occurred; errno is set to <code>ERANGE</code> .

wcstok

Locates text tokens in a given wide-character string.

Format

```
#include <wchar.h>
```

```
wchar_t *wcstok (wchar_t *ws1, const wchar_t *ws2); (XPG4)
```

```
wchar_t *wcstok (wchar_t *ws1, const wchar_t *ws2, wchar_t **ptr); (ISO C)
```

Function Variants

The `wcstok` function has variants named `_wcstok32` and `_wcstok64` for use with 32-bit and 64-bit pointer sizes, respectively. See Section 1.9 for more information on using pointer-size-specific functions.

Arguments

ws1

A pointer to a wide-character string containing zero or more text tokens.

ws2

A pointer to a separator string consisting of one or more wide characters. The separator string can differ from call to call.

ptr

ISO C Standard only. Used only when `ws1` is NULL, `ptr` is a caller-provided `wchar_t` pointer into which `wcstok` stores information necessary for it to continue scanning the same wide-character string.

Description

A sequence of calls to `wcstok` breaks the wide-character string pointed to by `ws1` into a sequence of tokens, each of which is delimited by a wide character from the wide-character string pointed to by `ws2`.

The `wcstok` function keeps track of its position in the wide-character string between calls and, as successive calls are made, the function works through the wide-character string, identifying the text token following the one identified by the previous call.

Tokens in `ws1` are delimited by null characters that `wcstok` inserts into `ws1`. Therefore, `ws1` cannot be a const object.

The following sections describe differences between the XPG4 Standard and ISO C Standard interface to `wcstok`.

XPG4 Standard Behavior

The first call to the `wcstok` function searches the wide-character string for the first character that is *not* found in the separator string pointed to by `ws2`. The first call returns a pointer to the first wide character in the first token and writes a null wide character into `ws1` immediately following the returned token.

wcstok

Subsequent calls to `wcstok` search for a wide character that *is* in the separator string pointed to by `ws2`. Each subsequent call (with the value of the first argument remaining `NULL`) returns a pointer to the next token in the string originally pointed to by `ws1`. When no tokens remain in the string, `wcstok` returns a `NULL` pointer.

ISO C Standard Behavior

For the first call in the sequence, `ws1` points to a wide-character string. In subsequent calls for the same string, `ws1` is `NULL`. When `ws1` is `NULL`, the value pointed to by `ptr` matches that stored by the previous call for the same wide-character string. Otherwise, the value pointed to by `ptr` is ignored.

The first call in the sequence searches the wide-character string pointed to by `ws1` for the first wide character that is *not* contained in the current separator wide-character string pointed to by `ws2`. If no such wide character is found, then there are no tokens in the wide-character string pointed to by `ws1`, and `wcstok` returns a `NULL` pointer.

The `wcstok` function then searches from there for a wide character that *is* contained in the current separator wide-character string. If no such wide character is found, the current token extends to the end of the wide-character string pointed to by `ws1`, and subsequent searches in the same wide-character string for a token return a `NULL` pointer. If such a wide character is found, it is overwritten by a null wide character, which terminates the current token.

In all cases, `wcstok` stores sufficient information in the pointer pointed to by `ptr` so that subsequent calls with a `NULL` pointer for `ws1` and the unmodified pointer value for `ptr` start searching just past the element overwritten by a null wide character (if any).

Return Values

<code>x</code>	A pointer to the first character of a token.
<code>NULL</code>	Indicates that no token was found.

Examples

```
1. /* XPG4 version of wcstok call */
   #include <wchar.h>
   #include <string.h>
   #include <stdio.h>

   main()
   {
       wchar_t str[] = L"...ab..cd,,ef.hi";

       printf("%S\n", wcstok(str, L"."));
       printf("%S\n", wcstok(NULL, L","));
       printf("%S\n", wcstok(NULL, L",."));
       printf("%S\n", wcstok(NULL, L",."));
   }
```

```

2. /* ISO C version of wcstok call */
#include <wchar.h>
#include <string.h>
#include <stdio.h>

main()
{
    wchar_t str[] = L"...ab..cd,,ef.hi";
    wchar_t *savgptr = NULL;

    printf("%S\n", wcstok(str, L".", &savgptr));
    printf("%S\n", wcstok(NULL, L",", &savgptr));
    printf("%S\n", wcstok(NULL, L".", &savgptr));
    printf("%S\n", wcstok(NULL, L",.", &savgptr));
}

```

Running this example produces the following results:

```

$ $ RUN WCSTOK_EXAMPLE
|ab|
|.cd|
|ef|
|hi|
$

```

wcstol

Converts a wide-character string in a specified base to a long integer value.

Format

```
#include <wchar.h>
```

```
long int wcstol (const wchar_t *nptr, wchar_t **endptr, int base);
```

Function Variants

The `wcstol` function has variants named `_wcstol32` and `_wcstol64` for use with 32-bit and 64-bit pointer sizes, respectively. See Section 1.9 for more information on using pointer-size-specific functions.

Arguments

nptr

A pointer to the wide-character string to be converted to a long integer.

endptr

The address of an object where the function can store a pointer to the first unrecognized character encountered in the conversion process (the character that follows the last character processed in the string being converted). If `endptr` is a NULL pointer, the address of the first unrecognized character is not retained.

base

The value, 2 through 36, to use as the base for the conversion.

If `base` is 16, leading zeros after the optional sign are ignored, and `0x` or `0X` is ignored.

If `base` is 0, the sequence of characters is interpreted by the same rules used to interpret an integer constant. After the optional sign:

- A leading 0 indicates octal conversion.
- A leading `0x` or `0X` indicates hexadecimal conversion.
- Any other combination of leading characters indicates decimal conversion.

Description

The `wcstol` function recognizes strings in various formats, depending on the value of the base. This function ignores any leading white-space characters (as defined by the `iswspace` function) in the given string. It recognizes an optional plus or minus sign, then a sequence of digits or letters that can represent an integer constant according to the value of the base. The first unrecognized character ends the conversion.

Return Values

x	The converted value.
0	Indicates that the string starts with an unrecognized wide character or that the value for <i>base</i> is invalid. If the string starts with an unrecognized wide character, <i>*endptr</i> is set to <i>nptr</i> . The function sets <i>errno</i> to <i>EINVAL</i> .
LONG_MAX or LONG_MIN	Indicates that the converted value would cause a positive or negative overflow, respectively. The function sets <i>errno</i> to <i>ERANGE</i> .

wcstombs

wcstombs

Converts a sequence of wide-character codes to a sequence of multibyte characters.

Format

```
#include <stdlib.h>

size_t wcstombs (char *s, const wchar_t *pwcs, size_t n);
```

Arguments

s

A pointer to the array containing the resulting multibyte characters.

pwcs

A pointer to the array containing the sequence of wide-character codes.

n

The maximum number of bytes to be stored in the array pointed to by *s*.

Description

The `wcstombs` function converts a sequence of codes corresponding to multibyte characters from the array pointed to by *pwcs* to a sequence of multibyte characters that are stored into the array pointed to by *s*, up to a maximum of *n* bytes. The value returned is equal to the number of characters converted or a `-1` if an error occurred.

This function is affected by the `LC_CTYPE` category of the program's current locale.

If *s* is `NULL`, this function call is a counting operation and *n* is ignored.

See also `wctomb`.

Return Values

x

The number of bytes stored in *s*, not including the null terminating byte. If *s* is `NULL`, `wcstombs` returns the number of bytes required for the multibyte character array.

`(size_t) -1`

Indicates an error occurred. The function sets `errno` to `EILSEQ` – invalid character sequence, or a wide-character code does not correspond to a valid character.

wcstoul

Converts the initial portion of the wide-character string pointed to by *nptr* to an unsigned long integer.

Format

```
#include <wchar.h>

unsigned long int wcstoul (const wchar_t *nptr, wchar_t **endptr, int base);
```

Function Variants

The `wcstoul` function has variants named `_wcstoul32` and `_wcstoul64` for use with 32-bit and 64-bit pointer sizes, respectively. See Section 1.9 for more information on using pointer-size-specific functions.

Arguments

nptr

A pointer to the wide-character string to be converted to an unsigned long.

endptr

The address of an object where the function can store the address of the first unrecognized character encountered in the conversion process (the character that follows the last character in the string being converted). If *endptr* is a NULL pointer, the address of the first unrecognized character is not retained.

base

The value, 2 through 36, to use as the base for the conversion.

If *base* is 16, leading zeros after the optional sign are ignored, and 0x or 0X is ignored.

If *base* is 0, the sequence of characters is interpreted by the same rules used to interpret an integer constant: after the optional sign, a leading 0 indicates octal conversion, a leading 0x or 0X indicates hexadecimal conversion, and any other combination of leading characters indicates decimal conversion.

Description

The `wcstoul` function recognizes strings in various formats, depending on the value of the base. It ignores any leading white-space characters (as defined by the `isspace` function) in the string. It recognizes an optional plus or minus sign, then a sequence of digits or letters that may represent an integer constant according to the value of the base. The first unrecognized wide character ends the conversion.

wcstoul

Return Values

x	The converted value.
0	Indicates that the string starts with an unrecognized wide character or that the value for <i>base</i> is invalid. If the string starts with an unrecognized wide character, <i>*endptr</i> is set to <i>nptr</i> . The function sets <i>errno</i> to <i>EINVAL</i> .
ULONG_MAX	Indicates that the converted value would cause an overflow. The function sets <i>errno</i> to <i>ERANGE</i> .

Example

```
#include <stdlib.h>
#include <stdio.h>
#include <wchar.h>
#include <errno.h>
#include <limits.h>

/* This test calls wcstoul() to convert a string to an      */
/* unsigned long integer. wcstoul outputs the resulting    */
/* integer and any characters that could not be converted. */

#define MAX_STRING 128

main()
{
    int base = 10,
        errno;
    char *input_string = "1234.56";
    wchar_t string_array[MAX_STRING],
        *ptr;
    size_t size;
    unsigned long int val;
    printf("base = [%d]\n", base);
    printf("String to convert = %s\n", input_string);
    if ((size = mbstowcs(string_array, input_string, MAX_STRING)) ==
        (size_t)-1) {
        perror("mbstowcs");
        exit(EXIT_FAILURE);
    }
    printf("wchar_t string is = [%S]\n", string_array);

    errno = 0;
    val = wcstoul(string_array, &ptr, base);
    if (errno == 0) {
        printf("returned unsigned long int from wcstoul = [%u]\n", val);
        printf("wide char terminating scan(ptr) = [%S]\n\n", ptr);
    }
    if (errno == ERANGE) {
        perror("error value is :");
        printf("ULONG_MAX = [%u]\n", ULONG_MAX);
        printf("wcstoul failed, val = [%d]\n\n", val);
    }
}
```

Running the example program produces the following result:

```
base = [10]
String to convert = 1234.56
wchar_t string is = [1234.56]
returned unsigned long int from wcstoul = [1234]
wide char terminating scan(ptr) = [.56]
```

WCSWCS

Locates the first occurrence in the string pointed to by *wstr1* of the sequence of wide characters in the string pointed to by *wstr2*.

Format

```
#include <wchar.h>

wchar_t *wcswcs (const wchar_t *wstr1, const wchar_t *wstr2);
```

Function Variants

The `wcswcs` function has variants named `_wcswcs32` and `_wcswcs64` for use with 32-bit and 64-bit pointer sizes, respectively. See Section 1.9 for more information on using pointer-size-specific functions.

Arguments

wstr1, wstr2
Pointers to null-terminated wide-character strings.

Return Values

Pointer	A pointer to the located wide-character string.
NULL	Indicates that the wide-character string was not found.

Example

```
#include <stdlib.h>
#include <stdio.h>
#include <wchar.h>

/* This test uses wcswcs() to find the occurrence of each */
/* subwide-character string, string1 and string2, within */
/* the main wide-character string, lookin. */

#define BUF_SIZE 50

main()
{
    static char lookin[] = "that this is a test was at the end";
    char string1[] = "this",
        string2[] = "the end";
    wchar_t buffer[BUF_SIZE],
        input_buffer[BUF_SIZE];

    /* Convert lookin to wide-character format. */
    /* Buffer and print it out. */

    if (mbstowcs(buffer, lookin, BUF_SIZE) == (size_t)-1) {
        perror("mbstowcs");
        exit(EXIT_FAILURE);
    }

    printf("Buffer to look in: %S\n", buffer);

    /* Convert string1 to wide-character format and use */
    /* wcswcs() to locate it within buffer */
}
```

```
if (mbstowcs(input_buffer, string1, BUF_SIZE) == (size_t)-1) {
    perror("mbstowcs");
    exit(EXIT_FAILURE);
}
printf("this: %S\n", wcs wcs(buffer, input_buffer));
/* Convert string2 to wide-character format and use */
/* wcs wcs() to locate it within buffer          */

if (mbstowcs(input_buffer, string2, BUF_SIZE) == (size_t)-1) {
    perror("mbstowcs");
    exit(EXIT_FAILURE);
}
printf("the end: %S\n", wcs wcs(buffer, input_buffer));
exit(1);
}
```

Running this example produces the following results:

```
Buffer to look in: that this is a test was at the end
this: this is a test was at the end
the end: the end
```

wcswidth

wcswidth

Determines the number of printing positions on a display device that are required for a wide-character string.

Format

```
#include <wchar.h>
int wcswidth (const wchar_t *pwcs, size_t n);
```

Arguments

pwcs
A pointer to a wide-character string.

n
The maximum number of characters in the string.

Description

The `wcswidth` function returns the number of printing positions required to display the first n characters of the string pointed to by `pwcs`. If there are less than n wide characters in the string, the function returns the number of positions required for the whole string.

Return Values

x	The number of printing positions required.
0	If <code>pwcs</code> is a null character.
-1	Indicates that one (or more) of the wide characters in the string pointed to by <code>pwcs</code> is not a printable character.

wcsxfrm

Changes a wide-character string such that the changed string can be passed to the `wcscmp` function and produce the same result as passing the unchanged string to the `wscoll` function.

Format

```
#include <wchar.h>

size_t wcsxfrm (wchar_t *ws1, const wchar_t *ws2, size_t maxchar);
```

Arguments

ws1, ws2

Pointers to wide-character strings.

maxchar

The maximum number of wide characters, including the null wide-character terminator, allowed to be stored in *s1*.

Description

The `wcsxfrm` function transforms the string pointed to by *ws2* and stores the resulting string in the array pointed to by *ws1*. No more than *maxchar* wide characters, including the null wide terminator, are placed into the array pointed to by *ws1*.

If the value of *maxchar* is less than the required size to store the transformed string (including the terminating null), the contents of the array pointed to by *ws1* is indeterminate. In such a case, the function returns the size of the transformed string.

If *maxchar* is 0, then, *ws1* is allowed to be a NULL pointer, and the function returns the required size of the *ws1* array before making the transformation.

The wide-character string comparison functions, `wscoll` and `wcscmp`, can produce different results given the same two wide-character strings to compare. This is because `wcscmp` does a straightforward comparison of the code point values of the characters in the strings, whereas `wscoll` uses the locale information to do the comparison. Depending on the locale, the `wscoll` comparison can be a multipass operation, which is slower than `wcscmp`.

The `wcsxfrm` function transforms wide-character strings in such a way that if you pass two transformed strings to the `wcscmp` function, the result is the same as passing the two original strings to the `wscoll` function. The `wcsxfrm` function is useful in applications that need to do a large number of comparisons on the same wide-character strings using `wscoll`. In this case, it may be more efficient (depending on the locale) to transform the strings once using `wcsxfrm` and then use the `wcscmp` function to do comparisons.

wcsxfrm

Return Values

x	Length of the resulting string pointed to by <i>ws1</i> , not including the terminating null character.
(size_t) - 1	Indicates that an error occurred. The function sets <i>errno</i> to <i>EINVAL</i> – The string pointed to by <i>ws2</i> contains characters outside the domain of the collating sequence.

Example

```
#include <wchar.h>
#include <stdio.h>
#include <stdlib.h>
#include <locale.h>

/* This program verifies that two transformed strings, */
/* when passed through wcsxfrm and then compared, provide */
/* the same result as if passed through wcscoll without */
/* any transformation. */

#define BUFF_SIZE 20

main()
{
    wchar_t w_string1[BUFF_SIZE];
    wchar_t w_string2[BUFF_SIZE];
    wchar_t w_string3[BUFF_SIZE];
    wchar_t w_string4[BUFF_SIZE];
    int errno;
    int coll_result;
    int wcscmp_result;
    size_t wcsxfrm_result1;
    size_t wcsxfrm_result2;

    /* setlocale to French locale */
    if (setlocale(LC_ALL, "fr_FR.ISO8859-1") == NULL) {
        perror("setlocale");
        exit(EXIT_FAILURE);
    }

    /* Convert each of the strings into wide-character format. */

    if (mbstowcs(w_string1, "<a'>bcd", BUFF_SIZE) == (size_t)-1) {
        perror("mbstowcs");
        exit(EXIT_FAILURE);
    }

    if (mbstowcs(w_string2, "abcz", BUFF_SIZE) == (size_t)-1) {
        perror("mbstowcs");
        exit(EXIT_FAILURE);
    }

    /* Collate string 1 and string 2 and store the result. */
    errno = 0;
    coll_result = wcscoll(w_string1, w_string2);
    if (errno) {
        perror("wcscoll");
        exit(EXIT_FAILURE);
    }
    else {
```

wctob

wctob

Determines if a wide character corresponds to a single-byte multibyte character and returns its multibyte character representation.

Format

```
#include <stdio.h>
#include <wchar.h>
int wctob (wint_t c);
```

Argument

c
The wide character to be converted to a single-byte multibyte character.

Description

The `wctob` function determines whether the specified wide character corresponds to a single-byte multibyte character when in the initial shift state and, if so, returns its multibyte character representation.

Return Values

x	The single-byte representation of the wide character specified.
EOF	Indicates an error. The wide character specified does not correspond to a single-byte multibyte character.

wctomb

Converts a wide character to its multibyte character representation.

Format

```
#include <stdlib.h>
int wctomb (char *s, wchar_t wchar);
```

Arguments

s

A pointer to the resulting multibyte character.

wchar

The code for the wide character.

Description

The `wctomb` function converts the wide character specified by *wchar* to its multibyte character representation. If *s* is `NULL`, then 0 is returned. Otherwise, the number of bytes comprising the multibyte character is returned. At most, `MB_CUR_MAX` bytes are stored in the array object pointed to by *s*.

This function is affected by the `LC_CTYPE` category of the program's current locale.

Return Values

x	The number of bytes comprising the multibyte character corresponding to <i>wchar</i> .
0	If <i>s</i> is <code>NULL</code> .
-1	If <i>wchar</i> is not a valid character.

wctrans

wctrans

Returns the description of a mapping, corresponding to specified property, that can later be used in a call to `towctrans`.

Format

```
#include <wctype.h>
wctrans_t wctrans (const char *property);
```

Argument

property

The name of the mapping. The following property names are defined for all locales:

- "toupper"
- "tolower"

Additional property names may also be defined in the `LC_CTYPE` category of the current locale.

Description

The `wctrans` function constructs a value with type `wctrans_t` that describes a mapping between wide characters identified by the *property* argument.

See also `towctrans`.

Return Values

nonzero	According to the <code>LC_CTYPE</code> category of the current program locale, the string specified as a property argument is the name of an existing character mapping. The value returned can be used in a call to the <code>towctrans</code> function.
0	Indicates an error. The property argument does not identify a character mapping in the current program's locale.

wctype

Used for defining a character class. The value returned by this function is used in calls to the `iswctype` function.

Format

```
#include <wctype.h> (ISO C)
#include <wchar.h> (XPG4)

wctype_t wctype (const char *char_class);
```

Argument

char_class

A pointer to a valid character class name.

Description

The `wctype` function converts a valid character class defined for the current locale to an object of type `wctype_t`. The following character class names are defined for all locales:

alnum	cntrl	lower	space
alpha	digit	print	upper
blank	graph	punct	xdigit

Additional character class names may also be defined in the `LC_CTYPE` category of the current locale.

See also `iswctype`.

Return Values

x	An object of type <code>wctype_t</code> that can be used in calls to the <code>iswctype</code> function.
0	If the character class name is not valid for the current locale.

Example

```
#include <locale.h>
#include <wchar.h>
#include <stdlib.h>
#include <stdio.h>
#include <string.h>
#include <ctype.h>

/* This test will set up a number of character class using wctype() */
/* and then verify whether calls to iswctype() using these classes */
/* produce the same results as calls to the is**** routines. */
main()
{
    wchar_t w_char;
    wctype_t ret_val;
    char *character = "A";
    /* Convert character to wide character format - w_char */
```

wctype

```
if (mbtowc(&w_char, character, 1) == -1) {
    perror("mbtowc");
    exit(EXIT_FAILURE);
}

/* Check if results from iswalnum() matches check on */
/* alnum character class */

if ((iswalnum((wint_t) w_char) &&
    (iswctype((wint_t) w_char, wctype("alnum"))))
    printf("[%C] is a member of the character class alnum\n", w_char);
else
    printf("[%C] is not a member of the character class alnum\n", w_char);

/* Check if results from iswalpha() matches check on */
/* alpha character class */

if ((iswalpha((wint_t) w_char) &&
    (iswctype((wint_t) w_char, wctype("alpha"))))
    printf("[%C] is a member of the character class alpha\n", w_char);
else
    printf("[%C] is not a member of the character class alpha\n", w_char);

/* Check if results from iswcntrl() matches check on */
/* cntrl character class */

if ((iswcntrl((wint_t) w_char) &&
    (iswctype((wint_t) w_char, wctype("cntrl"))))
    printf("[%C] is a member of the character class cntrl\n", w_char);
else
    printf("[%C] is not a member of the character class cntrl\n", w_char);

/* Check if results from iswdigit() matches check on */
/* digit character class */

if ((iswdigit((wint_t) w_char) &&
    (iswctype((wint_t) w_char, wctype("digit"))))
    printf("[%C] is a member of the character class digit\n", w_char);
else
    printf("[%C] is not a member of the character class digit\n", w_char);

/* Check if results from iswgraph() matches check on */
/* graph character class */

if ((iswgraph((wint_t) w_char) &&
    (iswctype((wint_t) w_char, wctype("graph"))))
    printf("[%C] is a member of the character class graph\n", w_char);
else
    printf("[%C] is not a member of the character class graph\n", w_char);

/* Check if results from iswlower() matches check on */
/* lower character class */

if ((iswlower((wint_t) w_char) &&
    (iswctype((wint_t) w_char, wctype("lower"))))
    printf("[%C] is a member of the character class lower\n", w_char);
else
    printf("[%C] is not a member of the character class lower\n", w_char);

/* Check if results from iswprint() matches check on */
/* print character class */

if ((iswprint((wint_t) w_char) &&
    (iswctype((wint_t) w_char, wctype("print"))))
    printf("[%C] is a member of the character class print\n", w_char);
else
    printf("[%C] is not a member of the character class print\n", w_char);

/* Check if results from iswpunct() matches check on */
/* punct character class */
```

```

if ((iswpunct((wint_t) w_char) &&
    (iswctype((wint_t) w_char, wctype("punct"))))
    printf("[%C] is a member of the character class punct\n", w_char);
else
    printf("[%C] is not a member of the character class punct\n", w_char);
/* Check if results from iswspace() matches check on */
/* space character class */
if ((iswspace((wint_t) w_char) &&
    (iswctype((wint_t) w_char, wctype("space"))))
    printf("[%C] is a member of the character class space\n", w_char);
else
    printf("[%C] is not a member of the character class space\n", w_char);
/* Check if results from iswupper() matches check on */
/* upper character class */
if ((iswupper((wint_t) w_char) &&
    (iswctype((wint_t) w_char, wctype("upper"))))
    printf("[%C] is a member of the character class upper\n", w_char);
else
    printf("[%C] is not a member of the character class upper\n", w_char);
/* Check if results from iswxdigit() matches check on */
/* xdigit character class */
if ((iswxdigit((wint_t) w_char) &&
    (iswctype((wint_t) w_char, wctype("xdigit"))))
    printf("[%C] is a member of the character class xdigit\n", w_char);
else
    printf("[%C] is not a member of the character class xdigit\n", w_char);
}

```

Running this example produces the following result:

```

[A] is a member of the character class alnum
[A] is a member of the character class alpha
[A] is not a member of the character class cntrl
[A] is not a member of the character class digit
[A] is a member of the character class graph
[A] is not a member of the character class lower
[A] is a member of the character class print
[A] is not a member of the character class punct
[A] is not a member of the character class space
[A] is a member of the character class upper
[A] is a member of the character class xdigit

```

wcwidth

wcwidth

Determines the number of printing positions on a display device required for the specified wide character.

Format

```
#include <wchar.h>
int wcwidth (wchar_t wc);
```

Argument

wc
A wide character.

Description

The `wcwidth` function determines the number of column positions needed for the specified wide character *wc*. The value of *wc* must be a valid wide character in the current locale.

Return Values

x	The number of printing positions required for <i>wc</i> .
0	If <i>wc</i> is a null character.
-1	Indicates that <i>wc</i> does not represent a valid printing wide character.

wmemchr

Locates the first occurrence of a specified wide character in an array of wide characters.

Format

```
#include <wchar.h>
wchar_t wmemchr (const wchar_t *s, wchar_t c, size_t n);
```

Function Variants

The `wmemchr` function has variants named `_wmemchr32` and `_wmemchr64` for use with 32-bit and 64-bit pointer sizes, respectively. See Section 1.9 for more information on using pointer-size-specific functions.

Arguments

s

A pointer to an array of wide characters to be searched.

c

The wide character value to search for.

n

The maximum number of wide characters in the array to be searched.

Description

The `wmemchr` function locates the first occurrence of the specified wide character in the initial n wide characters of the array pointed to by s .

Return Values

`x`

A pointer to the first occurrence of the wide character in the array.

`NULL`

The specified wide character does not occur in the array.

wmemcmp

wmemcmp

Compares two arrays of wide characters.

Format

```
#include <wchar.h>
```

```
int wmemcmp (const wchar_t *s1, const wchar_t *s2, size_t n);
```

Arguments

s1, s2

Pointers to wide-character arrays.

n

The maximum number of wide characters to be compared.

Description

The `wmemcmp` function compares the first n wide characters of the array pointed to by `s1` with the first n wide characters of the array pointed to by `s2`. The wide characters are compared not according to locale-dependent collation rules, but as integral objects of type `wchar_t`.

Return Values

0

Arrays are equal.

Positive value

The first array is greater than the second.

Negative value

The first array is less than the second.

wmemset

Sets a specified value to a specified number of wide characters in an array of wide characters.

Format

```
#include <wchar.h>
wchar_t wmemset (wchar_t *s, wchar_t c, size_t n);
```

Function Variants

The `wmemset` function has variants named `_wmemset32` and `_wmemset64` for use with 32-bit and 64-bit pointer sizes, respectively. See Section 1.9 for more information on using pointer-size-specific functions.

Arguments

s

A pointer to the array of wide characters.

c

The value to be placed in the first n wide characters of the array.

n

The number of wide characters to be set to the specified value c .

Description

The `wmemset` function copies the value of c into each of the first n wide characters of the array pointed to by s .

Return Value

x

The value of s .

wprintf

wprintf

Performs formatted output from the standard output (stdout). See Chapter 2 for information on format specifiers.

Format

```
#include <wchar.h>
int wprintf (const wchar_t *format, ... );
```

Arguments

format

A pointer to a wide-character string containing the format specifications. For more information about format and conversion specifications and their corresponding arguments, see Chapter 2.

...

Optional expressions whose resultant types correspond to conversion specifications given in the format specification.

If no conversion specifications are given, the output sources can be omitted. Otherwise, the function calls must have exactly as many output sources as there are conversion specifications, and the conversion specifications must match the types of the output sources.

Conversion specifications are matched to output sources in left-to-right order. Excess output pointers, if any, are ignored.

Description

The `wprintf` function is equivalent to the `fwprintf` function with the `stdout` argument interposed before the `wprintf` arguments.

Return Values

n	The number of wide characters written.
---	--

Negative value

Indicates an error. The function sets `errno` to one of the following:

- `EILSEQ` – Invalid character detected.
- `EINVAL` – Insufficient arguments.
- `ENOMEM` – Not enough memory available for conversion.
- `ERANGE` – Floating-point calculations overflow.
- `EVMSEERR` – Nontranslatable OpenVMS error. `vaxc$errno` contains the OpenVMS error code. This might indicate that conversion to a numeric value failed because of overflow.

The function can also set `errno` to the following as a result of errors returned from the I/O subsystem:

- `EBADF` – The file descriptor is not valid.
- `EIO` – I/O error.
- `ENOSPC` – No free space on the device containing the file.
- `ENXIO` – Device does not exist.
- `EPIPE` – Broken pipe.
- `ESPIPE` – Illegal seek in a file opened for append.
- `EVMSEERR` – Nontranslatable OpenVMS error. `vaxc$errno` contains the OpenVMS error code. This indicates that an I/O error occurred for which there is no equivalent C error code.

wrapok

wrapok

In the UNIX system environment, allows the wrapping of a word from the right border of the window to the beginning of the next line. This routine is provided only for UNIX software compatibility and serves no function in the OpenVMS environment.

Format

```
#include <curses.h>
wrapok (WINDOW *win, bool boolf);
```

Arguments

win

A pointer to the window.

boolf

A Boolean TRUE or FALSE value. If *boolf* is FALSE, scrolling is not allowed. This is the default setting. The bool type is defined in the <curses.h> header file as follows:

```
#define bool int
```

write

Writes a specified number of bytes from a buffer to a file.

Format

```
#include <unistd.h>
```

```
ssize_t write (int file_desc, void *buffer, size_t nbytes); (ISO POSIX-1)
```

```
int write (int file_desc, void *buffer, int nbytes); (Compatibility)
```

Arguments

file_desc

A file descriptor that refers to a file currently opened for writing or updating.

buffer

The address of contiguous storage from which the output data is taken.

nbytes

The maximum number of bytes involved in the write operation.

Description

If the write is to an RMS record file and the buffer contains embedded new-line characters, more than one record may be written to the file. Even if there are no embedded new-line characters, if *nbytes* is greater than the maximum record size for the file, more than one record will be written to the file. The write function always generates at least one record.

If the write is to a mailbox and the third argument, *nbytes*, specifies a length of 0, an end-of-file message is written to the mailbox. This occurs for mailboxes created by the application using SYS\$CREMBX, but not for mailboxes created to implement POSIX pipes. For more information, see Chapter 5.

Return Values

x	The number of bytes written.
-1	Indicates errors, including undefined file descriptors, illegal buffer addresses, and physical I/O errors.

writev

writev

Writes to a file.

Format

```
#include <uio.h>
ssize_t writev (int file_desc, const struct iovec *iov, int iovcnt);
ssize_t __writev64 (int file_desc, const struct __iovec64 *iov, int iovcnt); (Integrity servers, Alpha)
```

Function Variants

The `writev` function has variants named `_writev32` and `__writev64` for use with 32-bit and 64-bit pointer sizes, respectively. See Section 1.9 for more information on using pointer-size-specific functions.

Arguments

file_desc

A file descriptor that refers to a file currently opened for writing or updating.

iov

Array of `iovec` structures from which the output data is gathered.

iovcnt

The number of buffers specified by the members of the `iov` array.

Description

The `writev` function is equivalent to `write` but gathers the output data from the `iovcnt` buffers specified by the members of the `iov` array: `iov[0]`, `iov[1]`, ..., `iov[iovcnt-1]`. The `iovcnt` argument is valid if greater than 0 and less than or equal to `{IOV_MAX}`, defined in `<limits.h>`.

Each `iovec` entry specifies the base address and length of an area in memory from which data should be written. The `writev` function writes a complete area before proceeding to the next.

If `file_desc` refers to a regular file and all of the `iov_len` members in the array pointed to by `iov` are 0, `writev` returns 0 and has no other effect.

For other file types, the behavior is unspecified.

If the sum of the `iov_len` values is greater than `SSIZE_MAX`, the operation fails and no data is transferred.

Upon successful completion, `writev` returns the number of bytes actually written. Otherwise, it returns a value of `-1`, the file pointer remains unchanged, and `errno` is set to indicate an error.

Return Values

x

The number of bytes written.

-1

Indicates an error. The file times do not change, and the function sets `errno` to one of the following values:

- `EBADF` – The *file_desc* argument is not a valid file descriptor open for writing.
- `EINTR` – The write operation was terminated due to the receipt of a signal, and no data was transferred.
- `EINVAL` – The sum of the `iov_len` values in the *iov* array would overflow an `ssize_t`, or the *iovent* argument was less than or equal to 0, or greater than `{IOV_MAX}`.
- `EIO` – A physical I/O error has occurred.
- `ENOSPC` – There was no free space remaining on the device containing the file.
- `EPIPE` – An attempt is made to write to a pipe or FIFO that is not open for reading by any process, or that only has one end open. A `SIGPIPE` signal will also be sent to the thread.

wscanf

wscanf

Reads input from the standard input (`stdin`) under control of the wide-character format string.

Format

```
#include <wchar.h>
int wscanf (const wchar_t *format, ...);
```

Arguments

format

A pointer to a wide-character string containing the format specifications. For more information about format and conversion specifications and their corresponding arguments, see Chapter 2.

...

Optional expressions whose results correspond to conversion specifications given in the format specification.

If no conversion specifications are given, you can omit the input pointers. Otherwise, the function calls must have exactly as many input pointers as there are conversion specifications, and the conversion specifications must match the types of the input pointers.

Conversion specifications are matched to input sources in left-to-right order. Excess input pointers, if any, are ignored.

Description

The `wscanf` function is equivalent to the `fwscanf` function with the `stdin` arguments interposed before the `wscanf` arguments.

Return Values

n	The number of input items assigned. The number can be less than provided for, even zero, in the event of an early matching failure.
EOF	Indicates an error. An input failure occurred before any conversion.

y0, y1, yn (*Integrity servers, Alpha*)

Compute Bessel functions of the second kind.

Format

```
#include <math.h>
double y0 (double x);
float y0f (float x);
long double y0l (long double x);
double y1 (double x);
float y1f (float x);
long double y1l (long double x);
double yn (int n, double x);
float ynf (int n, float x);
long double ynl (int n, long double x);
```

Arguments

x
A positive, real value.

n
An integer.

Description

The *y0* functions return the value of the Bessel function of the second kind of order 0.

The *y1* functions return the value of the Bessel function of the second kind of order 1.

The *yn* functions return the value of the Bessel function of the second kind of order *n*.

Return Values

<i>x</i>	The relevant Bessel value of <i>x</i> of the second kind.
-HUGE_VAL	The <i>x</i> argument is 0.0; errno is set to ERANGE.
NaN	The <i>x</i> argument is negative or NaN; errno is set to EDOM.
0	Underflow occurred; errno is set to ERANGE.
HUGE_VAL	Overflow occurred; errno is set to ERANGE.

A

Version-Dependency Tables

New functions are added to the HP C Run-Time Library with each version of HP C. These functions are implemented and shipped with the OpenVMS operating system, while the documentation and header files containing their prototypes are shipped with versions of the HP C compiler.

You might have a newer version of HP C that has header files and documentation for functions that are not supported on your older OpenVMS system. For example, if your target operating system platform is OpenVMS Version 7.2, you cannot use HP C RTL functions introduced on OpenVMS Version 7.3, even though they are documented in this manual.

This appendix contains several tables that list what HP C RTL functions are supported on recent OpenVMS versions. This is helpful for determining the functions to avoid using on your target OpenVMS platforms.

A.1 Functions Available on all OpenVMS VAX, Alpha, and Integrity servers Versions

Table A-1 lists functions available on all OpenVMS VAX and OpenVMS Alpha versions.

Table A-1 Functions Available on All OpenVMS Systems

abort	abs	access	acos
alarm	asctime	asin	assert
atan2	atan	atexit	atof
atoi	atoll (Alpha)	atol	atoq (Alpha)
box	brk	bsearch	cabs
calloc	ceil	cfree	chdir
chmod	chown	clearerr	clock
close	cosh	cos	creat
ctermid	ctime	cuserid	decc\$ctrl_init
decc\$fix_time	decc\$from_vms	decc\$match_wild	decc\$record_read
decc\$record_write	decc\$set_reentrancy	decc\$to_vms	decc\$translate_vms
delete	delwin	difftime	div
dup2	dup	ecvt	endwin
execle	execlp	execl	execve
execvp	execv	exit	_exit

(continued on next page)

Table A-1 (Cont.) Functions Available on All OpenVMS Systems

exp	fabs	fclose	fcvt
fdopen	feof	ferror	fflush
fgetc	fgetname	fgetpos	fgets
fileno	floor	fmod	fopen
fprintf	fputc	fputs	fread
free	freopen	frexp	fscanf
fseek	fsetpos	fstat	fsync
ftell	ftime	fwait	fwrite
getc	getchar	getcwd	getc
getegid	getenv	geteuid	getgid
getname	getpid	getppid	gets
getuid	getw	gmtime	gsignal
hypot	initscr	isalnum	isalpha
isapipe	isascii	isatty	isctrl
isdigit	isgraph	islower	isprint
ispunct	isspace	isupper	isxdigit
kill	labs	ldexp	ldiv
llabs (Alpha)	lldiv (Alpha)	localeconv	localtime
log10	log	longjmp	longname
lseek	lwait	malloc	mblen
mbstowcs	mbtowc	memchr	memcmp
memcpy	memmove	memset	mkdir
mktemp	mktime	modf	mvwin
mv[w]addstr	newwin	nice	open
overlay	overwrite	pause	perror
pipe	pow	printf	putchar
putc	puts	putw	qabs (Alpha)
qdiv (Alpha)	qsort	raise	rand
read	realloc	remove	rename
rewind	sbrk	scanf	scroll
setbuf	setgid	setjmp	setlocale
setuid	setvbuf	sigblock	signal
sigpause	sigstack (VAX)	sigvec	sinh
sin	sleep	sprintf	sqrt
srand	sscanf	ssignal	stat
strcat	strchr	strcmp	strcoll
strcpy	strcspn	strerror	strftime
strlen	strncat	strncmp	strncpy
strpbrk	strrchr	strspn	strstr

(continued on next page)

Table A–1 (Cont.) Functions Available on All OpenVMS Systems

strtod	strtok	strtoll (Alpha)	strtol
strtoq (Alpha)	strtoull (Alpha)	strtoul	strtouq (Alpha)
strxfrm	subwin	system	tanh
tan	times	time	tmpfile
tmpnam	toascii	tolower	_tolower
touchwin	toupper	_toupper	ttyname
umask	ungetc	vaxc\$calloc_opt	vaxc\$cfree_opt
vaxc\$ctrl_init	vaxc\$establish	vaxc\$free_opt	vaxc\$malloc_opt
vaxc\$realloc_opt	va_arg	va_count	va_end
va_start	va_start_1	vfork	vfprintf
vprintf	vsprintf	wait	wcstombs
wctomb	write	[w]addch	[w]addstr
[w]clear	[w]clrattr	[w]clrtoeb	[w]clrtoeol
[w]delch	[w]deleteln	[w]erase	[w]getch
[w]getstr	[w]inch	[w]insch	[w]insertln
[w]insstr	[w]move	[w]printw	[w]refresh
[w]scanw	[w]setattr	[w]standend	[w]standout

A.2 Functions Available on OpenVMS Version 6.2 and Higher

Table A–2 lists additional functions available on OpenVMS VAX and OpenVMS Alpha Version 6.2 and higher.

Table A–2 Functions Added in OpenVMS Version 6.2

catclose	catgets	catopen	fgetwc
fgetws	fputwc	fputws	getopt
getwc	getwchar	iconv	iconv_close
iconv_open	iswalnum	iswalpha	iswcntrl
iswctype	iswdigit	iswgraph	iswlower
iswprint	iswpunct	iswspace	iswupper
iswxdigit	nl_langinfo	putwc	putwchar
strnlen	strptime	towlower	towupper
ungetwc	wscat	wcschr	wcscmp
wscoll	wscopy	wscspn	wcsftime
wcslen	wcsncat	wcsncmp	wcsncpy
wcspbrk	wcsrchr	wcsspn	wcstol
wcstoul	wcswcs	wcswidth	wcsxfrm
wcstod	wctype	wcwidth	wcstok

A.3 Functions Available on OpenVMS Version 7.0 and Higher

Table A–3 lists additional functions available on OpenVMS VAX and OpenVMS Alpha Version 7.0 and higher.

Table A–3 Functions Added in OpenVMS Version 7.0

basename	bcmp	bcopy	btowc
bzero	closedir	confstr	dirname
drand48	erand48	ffs	fpathconf
ftruncate	ftw	fwide	fwprintf
fwscanf	getclock	getdtablesize	getitimer
getlogin	getpagesize	getpwnam	getpwuid
gettimeofday	index	initstate	jrand48
lcong48	lrand48	mbrlen	mbrtowc
mbsinit	mbsrtowcs	memccpy	mkstemp
mmap	mprotect	rand48	msync
munmap	rand48	opendir	pathconf
pclose	popen	putenv	random
readdir	rewinddir	rindex	rmdir
seed48	seekdir	setenv	setitimer
setstate	sigaction	sigaddset	sigdelset
sigemptyset	sigfillset	sigismember	siglongjmp
sigpending	sigprocmask	sigsetjmp	sigsuspend
strand48	srandom	strcasecmp	strdup
strfmon	strncasecmp	strsep	swab
swprintf	swscanf	sysconf	telldir
tempnam	towctrans	truncate	tzset
ualarm	uname	unlink	unsetenv
usleep	vwprintf	vswprintf	vwprintf
wait3	wait4	waitpid	wcrtomb
wcsrtombs	wcsstr	wctob	wctrans
wmemchr	wmemcmp	wmemcpy	wmemmove
wmemset	wprintf	wscanf	

A.4 Functions Available on OpenVMS Alpha Version 7.0 and Higher

Table A–4 lists additional functions available on OpenVMS Alpha Version 7.0 and higher.

Table A–4 Functions Added in OpenVMS Alpha Version 7.0

_basename32	_basename64	_bsearch32	_bsearch64
_calloc32	_calloc64	_catgets32	_catgets64
_ctermid32	_ctermid64	_cuserid32	_cuserid64
_dirname32	_dirname64	_fgetname32	_fgetname64
_fgets32	_fgets64	_fgetws32	_fgetws64
_gcvt32	_gcvt64	_getcwd32	_getcwd64
_getname32	_getname64	_gets32	_gets64
_index32	_index64	_longname32	_longname64
_malloc32	_malloc64	_mbsrtowcs32	_mbsrtowcs64
_memccpy32	_memccpy64	_memchr32	_memchr64
_memcpy32	_memcpy64	_memmove32	_memmove64
_memset32	_memset64	_mktemp32	_mktemp64
_mmap32	_mmap64	_qsort32	_qsort64
_realloc32	_realloc64	_rindex32	_rindex64
_strcat32	_strcat64	_strchr32	_strchr64
_strcpy32	_strcpy64	_strdup32	_strdup64
_strncat32	_strncat64	_strncpy32	_strncpy64
_strpbrk32	_strpbrk64	_strptime32	_strptime64
_strrchr32	_strrchr64	_strsep32	_strsep64
_strstr32	_strstr64	_strtod32	_strtod64
_strtok32	_strtok64	_strtol32	_strtol64
_strtoll32	_strtoll64	_strtoq32	_strtoq64
_strtoul32	_strtoul64	_strtoull32	_strtoull64
_strtouq32	_strtouq64	_tmpnam32	_tmpnam64
_wscat32	_wscat64	_wchr32	_wchr64
_wscpy32	_wscpy64	_wscncat32	_wscncat64
_wscncpy32	_wscncpy64	_wspbrk32	_wspbrk64
_wscrchr32	_wscrchr64	_wcsrtombs32	_wcsrtombs64
_wcsstr32	_wcsstr64	_wcstok32	_wcstok64
_wcstol32	_wcstol64	_wcstoul32	_wcstoul64
_wswcs32	_wswcs64	_wmemchr32	_wmemchr64
_wmemcpy32	_wmemcpy64	_wmemmove32	_wmemmove64
_wmemset32	_wmemset64		

A.5 Functions Available on OpenVMS Version 7.2 and Higher

Table A-5 lists additional functions available on OpenVMS VAX and OpenVMS Alpha Version 7.2 and higher.

Table A-5 Functions Added in OpenVMS Version 7.2

asctime_r	dLError
ctime_r	dlopen
decc\$set_child_standard_streams	dlsym
decc\$validate_wchar	fcntl
decc\$write_eof_to_mbx	gmtime_r
dlclose	localtime_r

A.6 Functions Available on OpenVMS Version 7.3 and Higher

Table A-6 lists additional functions available on OpenVMS VAX and OpenVMS Alpha Version 7.3 and higher.

Table A-6 Functions Added in OpenVMS Version 7.3

fchown
link
utime
utimes
writev

A.7 Functions Available on OpenVMS Version 7.3-1 and Higher

Table A-7 lists additional functions available on OpenVMS Alpha Version 7.3-1 and higher.

Table A-7 Functions Added in OpenVMS Version 7.3-1

access	ftello
chmod	ftw
chown	readdir_r
decc\$feature_get_index	stat
decc\$feature_get_name	vfsconf
decc\$feature_get_value	vfwscanf
decc\$feature_set_value	vscanf
fseeko	vwscanf
fstat	vsscanf
	vswscanf

A.8 Functions Available on OpenVMS Version 7.3-2 and Higher

Table A–8 lists additional functions available on OpenVMS Alpha Version 7.3-2 and higher.

Table A–8 Functions Added in OpenVMS Version 7.3-2

a64l	clock_getres	clock_gettime	clock_settime
endgrent	getgrent	getgrgid	getgrgid_r
getgrnam	getgrnam_r	getpgid	getpgrp
_getpwnam64	getpwnam_r	_getpwnam_r64	_getpwent64
getpwuid	_getpwuid64	getpwuid_r	_getpwuid_r64
getsid	l64a	nanosleep	poll
pread	pwrite	rand_r	readv
_readv64	seteuid	setgrent	setpgid
setpgrp	setregid	setreuid	setsid
sighold	sigignore	sigrelse	sigtimedwait
sigwait	sigwaitinfo	snprintf	ttynam_r
vsnprintf	__writev64	decc\$set_child_ default_dir	

A.9 Functions Available on OpenVMS Version 8.2 and Higher

Table A–9 lists additional functions available on OpenVMS Alpha and Integrity servers Version 8.2 and higher.

Table A–9 Functions Added in OpenVMS Version 8.2

clearerr_unlocked	feof_unlocked
ferror_unlocked	fgetc_unlocked
fputc_unlocked	flockfile
ftrylockfile	funlockfile
getc_unlocked	getchar_unlocked
putc_unlocked	putchar_unlocked
statvfs	fstatvfs
_glob32	_glob64
_globfree32	_globfree64
socketpair	

A.10 Functions Available on OpenVMS Version 8.3 and Higher

Table A–10 lists additional functions available on OpenVMS Alpha and Integrity servers Version 8.3 and higher.

Table A–10 Functions Added in OpenVMS Version 8.3

crypt	readlink
encrypt	realpath
setkey	symlink
lchown	unlink
lstat	fchmod

A.11 Functions Available on OpenVMS Version 8.4 and Higher

Table A–11 lists additional functions available on OpenVMS Alpha and Integrity servers Version 8.4 and higher.

Table A–11 Functions Added in OpenVMS Version 8.4

ftok	sem_init
semctl	sem_open
semget	sem_post
semop	sem_timedwait
sem_close	sem_trywait
sem_destroy	sem_unlink
sem_getvalue	sem_wait

B

Prototypes Duplicated to Nonstandard Headers

The various standards dictate which header file must define each of the standard functions. This is the included header file documented with each function prototype in the Reference Section of this manual.

However, many of the functions defined by the standards already existed on several operating systems and were defined in different header files. This is especially true on OpenVMS systems with the header files <processes.h>, <unixio.h>, and <unixlib.h>.

So, to provide upward compatibility for these functions, their prototypes are duplicated in both the expected header file as well as the header file defined by the standards.

Table B-1 lists these functions.

Table B-1 Duplicated Prototypes

Function	Duplicated in	Standard says
access	<unixio.h>	<unistd.h>
alarm	<signal.h>	<unistd.h>
bcmp	<string.h>	<strings.h>
bcopy	<string.h>	<strings.h>
bzero	<string.h>	<strings.h>
chdir	<unixio.h>	<unistd.h>
chmod	<unixio.h>	<stat.h>
chown	<unixio.h>	<unistd.h>
close	<unixio.h>	<unistd.h>
creat	<unixio.h>	<fcntl.h>
ctermid	<stdio.h>	<unistd.h>
cuserid	<stdio.h>	<unistd.h>
dirname	<string.h>	<libgen.h>
dup	<unixio.h>	<unistd.h>
dup2	<unixio.h>	<unistd.h>
ecvt	<unixlib.h>	<stdlib.h>
execl	<processes.h>	<unistd.h>
execle	<processes.h>	<unistd.h>
execlp	<processes.h>	<unistd.h>

(continued on next page)

Table B–1 (Cont.) Duplicated Prototypes

Function	Duplicated in	Standard says
execv	<processes.h>	<unistd.h>
execve	<processes.h>	<unistd.h>
execvp	<processes.h>	<unistd.h>
_exit	<stdlib.h>	<unistd.h>
fcvt	<unixlib.h>	<stdlib.h>
ffs	<string.h>	<strings.h>
fsync	<stdio.h>	<unistd.h>
ftime	<time.h>	<timeb.h>
gcvt	<unixlib.h>	<stdlib.h>
getcwd	<unixlib.h>	<unistd.h>
getegid	<unixlib.h>	<unistd.h>
getenv	<unixlib.h>	<stdlib.h>
geteuid	<unixlib.h>	<unistd.h>
getgid	<unixlib.h>	<unistd.h>
getopt	<stdio.h>	<unistd.h>
getpid	<unixlib.h>	<unistd.h>
getppid	<unixlib.h>	<unistd.h>
getuid	<unixlib.h>	<unistd.h>
index	<string.h>	<strings.h>
isatty	<unixio.h>	<unistd.h>
lseek	<unixio.h>	<unistd.h>
mkdir	<unixlib.h>	<stat.h>
mktemp	<unixio.h>	<stdlib.h>
nice	<stdlib.h>	<unistd.h>
open	<unixio.h>	<fcntl.h>
pause	<signal.h>	<unistd.h>
pipe	<processes.h>	<unistd.h>
read	<unixio.h>	<unistd.h>
rindex	<string.h>	<strings.h>
sbrk	<stdlib.h>	<unistd.h>
setgid	<unixlib.h>	<unistd.h>
setuid	<unixlib.h>	<unistd.h>
sleep	<signal.h>	<unistd.h>
strcasecmp	<string.h>	<strings.h>
strncasecmp	<string.h>	<strings.h>
system	<processes.h>	<stdlib.h>
times	<time.h>	<times.h>
umask	<stdlib.h>	<stat.h>

(continued on next page)

Table B-1 (Cont.) Duplicated Prototypes

Function	Duplicated in	Standard says
vfork	<processes.h>	<unistd.h>
wait	<processes.h>	<wait.h>
write	<unixio.h>	<unistd.h>

A

a64l function, REF-3
abort function, 4-1, REF-5
abs function, REF-6
access function, REF-7
ACCVIO
 hardware error, 1-48
 sigbus signal, 4-10
 sigsegv signal, 4-10
acos function, REF-9
acosh function, REF-10
addch function, REF-11
addstr function, REF-12
alarm function, 4-1, 4-10, REF-13
 program example, 4-13
Allocate memory
 calloc function, REF-38
 malloc function, REF-390
 realloc function, REF-501
_ANSI_C_SOURCE macro, 1-11
Argument list functions, 3-9 to 3-12
Arguments
 variable-length lists, 3-9
ASCII
 table of values, 3-4
asctime function, REF-14
asctime_r function, REF-14
asin function, REF-16
asinh function, REF-17
asm calls, 1-49
assert function, REF-18
AST reentrancy, 1-50, REF-124
atan2 function, REF-20
atan function, REF-19
atanh function, REF-21
atexit function, REF-22
atof function, REF-23
atoi function, REF-24
atol function, REF-24
atoll function, REF-25
atofq function, REF-25

B

basename function, REF-26
bcmp function, REF-27
bcopy function, REF-28
64-bit pointer support, 1-53
32-bit UIDs, GIDs, 1-38
box function, REF-29
brk function, 8-1, REF-30
_BSD44_CURSES macro, 1-16
bsearch function, REF-31
btowc function, 10-10, REF-33
bzero function, REF-34

C

C\$_LONGJMP exception, 4-10
cabs function, REF-35
cacos function, REF-36
cacosh function, REF-37
calloc function, 8-1, REF-38, REF-56
carg function, REF-39
Carriage control
 Fortran, 1-44
 translation
 by HP C, 1-43 to 1-45
Case conversion functions, 10-9
casin function, REF-40
casinh function, REF-41
catan function, REF-42
catanh function, REF-43
catclose function, 10-5, REF-44
Categories
 locale, 10-3
Category
 LC_ALL, 10-4
 LC_COLLATE, 10-3
 LC_CTYPE, 10-3
 LC_MESSAGES, 10-3
 LC_MONETARY, 10-3
 LC_NUMERIC, 10-3
 LC_TIME, 10-3
catgets function, 10-5, REF-45
catopen function, 10-5, REF-48

- cbirt function, REF-51
- ccos function, REF-52
- ccosh function, REF-53
- ceil function, REF-54
- cexp function, REF-55
- cfree function, 8-1, REF-56
- Character-classification functions, 3-4 to 3-7, 10-9
 - isalnum, REF-331
 - isalpha, REF-332
 - isascii, REF-334
 - iscntrl, REF-336
 - isdigit, REF-337
 - isgraph, REF-338
 - islower, REF-339
 - isprint, REF-341
 - ispunct, REF-342
 - isspace, REF-343
 - isupper, REF-344
 - iswalnum, REF-345
 - iswalpha, REF-346
 - iswcntrl, REF-347
 - iswctype, REF-348
 - iswdigit, REF-350
 - iswgraph, REF-351
 - iswlower, REF-352
 - iswprint, REF-353
 - iswpunct, REF-354
 - iswspace, REF-355
 - iswupper, REF-356
 - iswxdigit, REF-357
 - isxdigit, REF-358
 - program example, 3-7
 - wctype, REF-819
- Character-conversion functions, 3-7 to 3-9
 - ecvt, REF-149
 - fcvt, REF-179
 - gcvt, REF-254
 - toascii, REF-702
 - tolower, REF-703
 - _tolower, REF-704
 - _toupper, REF-706
 - _toupper, REF-707
 - _tolower, REF-709
 - toupper, REF-710
 - wcswidth, REF-812
 - wcwidth, REF-822
- Character definition files
 - location of, 10-6
- Character set conversion functions
 - iconv, REF-317
 - iconv_close, REF-319
 - iconv_open, REF-320
- Character sets
 - converting between, 10-6
 - supported by HP C RTL, 10-6
- Character special files, 12-3
- Charmap file
 - location, 10-6
- chdir function, REF-57
- Child process
 - creating with vfork, REF-741
 - executing image
 - with exec functions, 5-3
 - implementation of, 5-2
 - introduction to, 5-1
 - program examples, 5-5
 - sharing data with pipe, 5-5, REF-462
 - synchronization with wait, 5-5
- chmod function, REF-58
- chown function, REF-59
- cimag function, REF-60
- C language
 - I/O background, 1-39
- clearerr function, REF-62
- clearerr_unlocked function, REF-63
- clear function, REF-61, REF-64
- clearok function, REF-64
- clock function, REF-65
- clock_getres function, REF-66
- clock_gettime function, REF-67
- clock_settime function, REF-68
- clog function, REF-70
- closedir function, REF-72
- close function, REF-71
- clratrr function, REF-74
- clratrr macro, 6-2
- clrrobot function, REF-75
- clrtoeol function, REF-76
- Codeset converter functions, 10-6
- Codesets, 10-6
- confstr function, REF-77
- conj function, REF-79
- Conversion specifications
 - for I/O functions, 2-7 to 2-19
 - input
 - table of conversion specifiers, 2-8
 - table of optional characters, 2-8
 - output
 - table of characters, 2-16
- Converter functions
 - filenaming conventions for, 10-6
- copysign function, REF-80
- cos function, REF-81
- cosh function, REF-82
- cot function, REF-83
- cpow function, REF-84
- cproj function, REF-85
- creal function, REF-86
- creat function, REF-87, REF-147, REF-173, REF-182
- crmode function, REF-93

C RTL

See Run-Time Library (RTL)

new features, xxix

POSIX Root, 1-23

crypt function, REF-94

csin function, REF-95

csinh function, REF-96

csqrt function, REF-97

ctan function, REF-98

ctanh function, REF-99

ctermid function, REF-100

ctime function, REF-14, REF-101

using with tzset function, REF-715

ctime_r function, REF-101

Cultural information

stored in locale, 10-7

curscr window, 6-5

Curses, 6-1 to 6-13

cursor movement, 6-10

getting started, 6-7 to 6-9

introduction to, 6-1

program example, 6-11

terminology, 6-4 to 6-7

 curscr, 6-5

 stdscr, 6-5

 windows, 6-5

using predefined variables and constants, 6-9

<curses.h> header file, 6-2

Curses functions

box, REF-29

clearok, REF-64

delwin, REF-137

endwin, REF-154

getyx, REF-306

initscr, REF-325

leaveok, REF-368

longname, REF-382

mvcur, REF-429

mvwin, REF-436

mv[w]addch, REF-427

mv[w]addstr, REF-428

mv[w]delch, REF-430

mv[w]getch, REF-431

mv[w]getstr, REF-432

mv[w]inch, REF-433

mv[w]insch, REF-434

mv[w]insstr, REF-435

newwin, REF-439

[no]crmode, REF-93

[no]echo, REF-148

[no]nl, REF-444

[no]raw, REF-492

overlay, REF-455

overwrite, REF-456

scroll, REF-519

scrollok, REF-520

subwin, REF-677

touchwin, REF-705

Curses functions (cont'd)

wrapok, REF-830

[w]addch, REF-11

[w]addstr, REF-12

[w]clear, REF-61

[w]clrattr, REF-74

[w]clrtoeol, REF-75

[w]clrtoeol, REF-76

[w]delch, REF-134

[w]deleteln, REF-136

[w]erase, REF-156

[w]getch, REF-258

[w]getstr, REF-300

[w]inch, REF-323

[w]insch, REF-328

[w]insertln, REF-329

[w]insstr, REF-330

[w]move, REF-420

[w]printw, REF-474

[w]refresh, REF-504

[w]scanw, REF-518

[w]setattr, REF-543

[w]standend, REF-614

[w]standout, REF-615

cuserid function, REF-103

D

Date/time

introduction to, 11-1

Date/time functions, 11-1 to 11-6

Date and time functions, 10-8

DCL

symbolic link support, 12-16

DEC/SHELL

See UNIX file specifications

DECC\$ACL_ACCESS_CHECK feature logical,

1-22

DECC\$ALLOW_REMOVE_OPEN_FILES feature

logical, 1-22

DECC\$ALLOW_UNPRIVILEGED_NICE feature

logical, 1-23, REF-442

DECC\$ARGV_PARSE_STYLE feature logical,

1-23

DECC\$CRTL_INIT function, REF-104, REF-720

DECC\$DECC\$PRINTF_USES_VAX_ROUND

feature logical, 1-33

DECC\$DEFAULT_LRL feature logical, 1-23

DECC\$DEFAULT_UDF_RECORD feature logical,

1-23

DECC\$DETACHED_CHILD_PROCESS feature

logical, 1-23

DECC\$DISABLE_POSIX_ROOT feature logical,

1-23

DECC\$DISABLE_TO_VMS_LOGNAME_

TRANSLATION feature logical, 1-24

DECC\$EFS_CASE_PRESERVE feature logical, 1-24
 DECC\$EFS_CASE_SPECIAL feature logical, 1-24
 DECC\$EFS_CHARSET feature logical, 1-25
 DECC\$EFS_FILE_TIMESTAMPS feature logical, 1-27
 DECC\$EFS_NO_DOTS_IN_DIRNAME feature logical, 1-27
 DECC\$ENABLE_GETENV_CACHE feature logical, 1-28
 DECC\$ENABLE_TO_VMS_LOGNAME_CACHE feature logical, 1-28
 DECC\$EXEC_FILEATTR_INHERITANCE feature logical, 1-28
 decc\$feature_get feature-setting routine, REF-105
 decc\$feature_get_index feature-setting routine, REF-106
 decc\$feature_get_name feature-setting routine, REF-107
 decc\$feature_get_value feature-setting routine, REF-108
 decc\$feature_set feature-setting routine, REF-109
 decc\$feature_set_value feature-setting routine, REF-110
 decc\$feature_show feature-setting routine, REF-111
 decc\$feature_show_all feature-setting routine, REF-112
 DECC\$FILENAME_ENCODING_UTF8 feature logical, 1-28
 DECC\$FILENAME_UNIX_NO_VERSION feature logical, 1-30
 DECC\$FILENAME_UNIX_ONLY feature logical, 1-29
 DECC\$FILENAME_UNIX_REPORT feature logical, 1-30
 DECC\$FILE_PERMISSION_UNIX feature logical, 1-30
 DECC\$FILE_SHARING feature logical, 1-30
 DECC\$FIXED_LENGTH_SEEK_TO_EOF feature logical, 1-30
 decc\$fix_time file specification conversion routine, 1-8, REF-113
 decc\$from_vms file specification conversion routine, 1-8, REF-114
 DECC\$GLOB_UNIX_STYLE feature logical, 1-30
 DECC\$LOCALE_CACHE_SIZE feature logical, 1-30
 DECC\$MAILBOX_CTX_STM feature logical, 1-30
 decc\$match_wild file specification conversion routine, 1-8, REF-116
 DECC\$NO_ROOTED_SEARCH_LISTS feature logical, 1-31
 DECC\$PIPE_BUFFER_QUOTA feature logical, 1-32, REF-463
 DECC\$PIPE_BUFFER_SIZE feature logical, 1-32, REF-463
 DECC\$POPEN_NO_CRLF_REC_ATTR feature logical, 1-32, REF-465
 DECC\$POSIX_COMPLIANT_PATHNAMES feature logical, 1-32, 12-1, 12-8
 DECC\$POSIX_SEEK_STREAM_FILE feature logical, 1-33
 DECC\$POSIX_STYLE_UID feature logical, 1-33
 DECC\$READDIR_DROPDOTNOTYPE feature logical, 1-33
 DECC\$READDIR_KEEPPOTDIR feature logical, 1-33
 decc\$record_read function, REF-117
 decc\$record_write function, REF-118
 DECC\$RENAME_ALLOW_DIR feature logical, 1-34
 DECC\$RENAME_NO_INHERIT feature logical, 1-33
 DECC\$SELECT_IGNORES_INVALID_FD feature logical, 1-35
 decc\$set_child_default_dir function, REF-119
 decc\$set_child_standard_streams function, REF-120
 decc\$set_reentrancy function, 1-50, REF-124
 DECC\$SHR.EXE, 1-3
 DECC\$STDIO_CTX_EOL feature logical, 1-35
 DECC\$STREAM_PIPE feature logical, 1-35, REF-465
 DECC\$STRTOL_ERANGE feature logical, 1-35
 DECC\$THREAD_DATA_AST_SAFE feature logical, 1-35
 decc\$to_vms file specification conversion routine, 1-8, REF-126
 decc\$translate_vms file specification conversion routine, 1-8, REF-128
 DECC\$TZ_CACHE_SIZE feature logical, 1-35
 DECC\$UMASK feature logical, 1-35
 DECC\$UNIX_LEVEL feature logical, 1-36
 DECC\$UNIX_PATH_BEFORE_LOGNAME feature logical, 1-37
 DECC\$USE_JPI\$_CREATOR feature logical, 1-37
 DECC\$USE_RAB64 feature logical, 1-37
 DECC\$V62_RECORD_GENERATION feature logical, 1-37
 DECC\$VALIDATE_SIGNAL_IN_KILL feature logical, 1-37
 decc\$validate_wchar function, REF-130
 decc\$write_eof_to_mbx function, REF-131
 DECC\$WRITE_SHORT_RECORDS feature logical, 1-38
 DECC\$XPG4_STRPTIME feature logical, 1-38

_DECC_SHORT_GID_T macro, 1-17
 _DECC_V4_SOURCE macro, 1-15
 delch function, REF-134
 delete function, REF-135, REF-507
 deleteIn function, REF-136
 delwin function, REF-137
 difftime function, REF-138
 dirname function, REF-139
 div function, REF-141
 dlclose function, REF-142
 dlerror function, REF-143
 dlopen function, REF-144
 dlsym function, REF-145
 drand48 function, REF-146

- using with lcong48 function, REF-365
- using with seed48 function, REF-521
- using with srand48 function, REF-609

 dup2 function, REF-147, REF-182, REF-464
 dup function, REF-147, REF-182

E

echo function, REF-148
 ecvt function, 3-7, REF-149
 edata global symbol, 1-48
 EFS, 1-10
 encrypt function, REF-151
 end global symbol, 1-48
 endgrent function, REF-152
 endpwent function, REF-153
 endwin function, REF-154
 erand48 function, REF-155
 erase function, REF-156
 erf function, REF-157
 <errno.h> header file, 4-2, 4-5
 <errnodef.h> header file, 4-10
 errno variable, 4-2, 4-5, 7-4
 Error-handling functions, 4-2

- abort, 4-1, 4-6, 4-10, REF-5
- error codes, 4-2
- exit, 4-1, 5-5, REF-165
- _exit, 4-1, 5-5, REF-165
- _perror, 4-1, REF-461
- strerror, 4-1, REF-633

 ERR predefined macro, 6-10
 etext global symbol, 1-48
 exec function, REF-463
 exec functions

- processing, 5-4

 exec functions, 5-3

- error conditions, 5-5

 execl function, REF-160
 execl function, REF-158
 execlp function, REF-161
 execve function, REF-163
 execv function, REF-162

execvp function, REF-164
 _exit function, 5-5
 _exit, _exit function

- using with wait3 function, REF-761
- using with wait4 function, REF-764
- using with waitpid function, REF-767

 exit function, 5-5, REF-165
 _exit function, REF-165
 exp2 function, REF-168
 exp function, REF-167
 Extended File Specifications, 1-10

F

fabs function, REF-169
 _FAST_TOUPPER, 1-18
 fchmod function, REF-170
 fchown function, REF-171
 fclose function, REF-172, REF-208
 fcntl function, REF-173
 fcvt function, 3-7, REF-179
 fdim function, REF-181
 fdopen function, REF-182, REF-464
 Feature logical names, 1-19
 Feature-setting routines

- decc\$feature_get, REF-105
- decc\$feature_get_index, REF-106
- decc\$feature_get_name, REF-107
- decc\$feature_get_value, REF-108
- decc\$feature_set, REF-109
- decc\$feature_set_value, REF-110
- decc\$feature_show, REF-111
- decc\$feature_show_all, REF-112

 Feature switches, 1-19
 Feature-test macros, 1-10
 feof function, REF-183
 feof_unlocked function, REF-184
 ferror function, REF-185
 ferror_unlocked function, REF-186
 fflush function, REF-187

- using with popen function, REF-469

 ffs function, REF-188
 fgetc function, REF-189
 fgetc_unlocked function, REF-190
 fgetname function, REF-191
 fgetpos function, REF-192
 fgets function, REF-194
 fgetwc function, REF-196
 fgetws function, REF-197
 File

- header, 1-1

 FILE, 2-5
 File descriptor, 2-5, 2-20

- HP C defaults
 - for OpenVMS logical names, 1-9

 fileno function, REF-199

File pointer, 2-5, 2-20

File protection, REF-58, REF-720

File specification conversion routines

- decc\$fix_time, REF-113
- decc\$from_vms, REF-114
- decc\$match_wild, REF-116
- decc\$to_vms, REF-126
- decc\$translate_vms, REF-128

finite function, REF-200

Fixed-length record files

- accessing in record mode, 1-46

Floating-point support, 1-4

flockfile function, REF-201

floor function, REF-202

fma function, REF-203

fmax function, REF-204

fmin function, REF-205

fmod function, REF-206

fopen function, REF-207

fork function, REF-741

Format

- specification string for input functions, 2-7
- specification string for output functions, 2-13

fpathconf function, REF-210

fprintf function, REF-212

fputc function, REF-214

fputc_unlocked function, REF-215

fputs function, REF-216

fputc function, REF-217

fputwc function, REF-219

fp_classf function, REF-209

fp_class function, REF-209

fp_classl function, REF-209

fread function, REF-220

free function, 8-1, REF-56, REF-221, REF-262

- using with tempnam function, REF-696

freopen function, REF-222

frexp function, REF-223

fscanf function, REF-225

fseek function, 1-42, REF-227, REF-722, REF-723

fseeko function, REF-229

fsetpos function, REF-230

fstat function, REF-231

fstatvfs function, REF-234

fsync function, REF-236

ftell function, REF-237

ftello function, REF-238

ftime function, REF-239

ftok function, REF-240

ftruncate function, REF-241

ftrylockfile function, REF-242

ftw function, REF-243

Function prototype, 1-6

Functions

- argument list-handling, 3-9
- case conversion, 10-9
- character classification, 10-9

Functions (cont'd)

- character-classification, 3-4
- character-conversion, 3-7, 3-8
- Curses, 6-1 to 6-4
- Date/time, 11-1 to 11-6
- error-handling, 4-2 to 4-5
- signal-handling, 4-5 to 4-13
- Standard I/O, 2-1, 2-5
- string-handling, 3-9
- Terminal I/O, 2-19
- Time, 11-1 to 11-6
- UNIX I/O, 2-5

funlockfile function, REF-246

fwait function, REF-247

fwide function, REF-248

fwprintf function, REF-249

fwrite function, REF-251

fwscanf function, REF-252

G

gcvt function, 3-7, REF-254

GENCAT command, 10-5

getc function, REF-256

getchar function, REF-259

getchar_unlocked function, REF-260

getch function, REF-258

getclock function, REF-261

getcwd function, REF-262

getc_unlocked function, REF-257

getdtablesize function, REF-263

getegid function, REF-264

getenv function, REF-265

- using with putenv function, REF-479

geteuid function, REF-267

getgid function, REF-268

getgrent function, REF-269

getgrgid function, REF-270

getgrgid_r function, REF-271

getgrnam function, REF-273

getgrnam_r function, REF-274

getgroups function, REF-276

getitimer function, REF-277

getlogin function, REF-279

getname function, REF-280, REF-463

getopt function, REF-281

getpagesize function, REF-284

getpgid function, REF-285

getpgrp function, REF-286

getpid function, REF-287

getppid function, REF-288

getpwent function, REF-289

getpwnam function, REF-291

getpwnam_r function, REF-291

getpwuid function, REF-295

getpwuid_r function, REF-295

gets function, REF-194, REF-298
getsid function, REF-299
getstr function, REF-300
gettimeofday function, REF-301
getuid function, REF-302
getwc function, REF-304
getwchar function, REF-305
getw function, REF-303
getyx function, REF-306
GIDs, 1-38
2-gigabyte files, 1-17
globfree function, REF-311
glob function, REF-307
gmtime function, REF-312
gmtime_r function, REF-312
GNV
 symbolic link support, 12-18
Group database functions
 endgrent, REF-152
 getgrent, REF-269
 getgrgid, REF-270
 getgrgid_r, REF-271
 getgrnam, REF-273
 getgrnam_r, REF-274
 setgrent, REF-549
Group Identifier, 1-38
gsignal function, 4-5, 4-10, REF-314

H

Header files, 1-1, 1-7
 displaying on Alpha or Integrity server systems,
 1-1
hypot function, REF-316

I

iconv function, 10-6, REF-317
iconv_close function, 10-6, REF-319
iconv_open function, 10-6, REF-320
ilogb function, REF-322
IMAGELIB.OLB, 1-3
inch function, REF-323
index function, REF-324
initscr function, REF-325
initstate function, REF-326
 using with setstate function, REF-566
Input and output (I/O), 1-39 to 1-45
 conversion specifications, 2-7 to 2-19
 format specification string, 2-7, 2-13
 OpenVMS system services, 1-39
 record access
 in HP C, 1-43
 Record Management Services (RMS), 1-39
 Standard, 1-39
 stream access
 in HP C, 1-43
 UNIX, 1-39

Input and output (I/O) (cont'd)

 Wide-character, 2-6
insch function, REF-328
insertln function, REF-329
insstr function, REF-330
insstr macro, 6-2
Internationalization support, 10-1
International software
 description of, 10-2
Interprocess communication, 5-1
isalnum function, REF-331
isalpha function, REF-332
isapipe function, REF-333
isascii function, REF-334
isatty function, REF-335
iscntrl function, REF-336
isdigit function, REF-337
isgraph function, REF-338
islower function, REF-339
isnan function, REF-340
isprint function, REF-341
ispunct function, REF-342
isspace function, REF-343
isupper function, REF-344
iswalnum function, REF-345
iswalphabet function, REF-346
iswcntrl function, REF-347
iswctype function, REF-348
iswdigit function, REF-350
iswgraph function, REF-351
iswlower function, REF-352
iswprint function, REF-353
iswpunct function, REF-354
iswspace function, REF-355
iswupper function, REF-356
iswxdigit function, REF-357
isxdigit function, REF-358
itimerval structure, REF-277, REF-550

J

j0 function, REF-359
j1 function, REF-359
jn function, REF-359
jrand48 function, REF-360

K

kill function, REF-361

L

l64a function, REF-362
labs function, REF-363
LANG logical name, 10-5
_LARGEFILE macro, 1-17

- Large files, 1–17
- lchown function, REF–364
- lcong48 function, REF–365
 - using with drand48 function, REF–146
 - using with lrand48 function, REF–383
 - using with mrand48 function, REF–423
- LC_ALL category, 10–4
- LC_ALL logical name, 10–5
- LC_CTYPE category, 10–9
- LC_NUMERIC logical name, 10–5
- ldexp function, REF–366
- ldiv function, REF–367
- leaveok function, REF–368
- lgamma function, REF–369
- LIB\$ESTABLISH function, 4–10, REF–735
- LIB\$SIGNAL, 4–10
- Library
 - main function, 1–2
- Linker
 - search libraries, 1–2
- link function, REF–370
- Linking
 - with RTL object libraries, 1–3
- Linking with the C RTL, 1–2
- List-handling functions
 - va_arg, REF–736
 - va_count macro, REF–737
 - va_end, REF–738
 - va_start, REF–739
 - va_start_1, REF–739
- llabs function, REF–486
- lldiv function, REF–487
- LNK\$LIBRARY logical name, 1–2
- Locale
 - categories, 10–3
 - description of, 10–3
 - extracting information from, 10–8
- localeconv function, 10–8, REF–371
- Locale support functions
 - localeconv, REF–371
 - nl_langinfo, REF–445
 - setlocale, REF–555
- localtime function, REF–375
 - using with tzset function, REF–715
- localtime_r function, REF–375
- log10 function, REF–377
- log1p function, REF–378
- logb function, REF–379
- log function, REF–377
- Logical name
 - for default locale, 10–5
 - for default locale categories, 10–5
 - for international environment, 10–5
 - for locale directory, 10–3
 - for system default locale, 10–5
 - LANG, 10–5
 - LC_ALL, 10–5
 - LC_NUMERIC, 10–5

- Logical name (cont'd)
 - SYS\$I18N_LOCALE, 10–3
 - SYS\$LANG, 10–5
 - SYS\$LC_ALL, 10–5
- Logical names
 - feature, 1–19
- longjmp function, 4–10, REF–380, REF–735, REF–741
- longjmp member
 - using with ftw function, REF–244
- longname function, REF–382
- lrand48 function, REF–383
 - using with lcong48 function, REF–365
 - using with seed48 function, REF–521
 - using with srand48 function, REF–609
- lrint function, REF–384
- lround function, REF–385
- lseek function, 1–42, REF–386
- lstat function, REF–388
- lwait function, REF–389

M

- Macros
 - feature-test, 1–10
- main function
 - using with wait3 function, REF–761
 - using with wait4 function, REF–764
 - using with waitpid function, REF–767
- Main function, 1–2, 4–10
 - main_program option, 1–2
- malloc function, 8–1, REF–56, REF–390
 - using with ftw function, REF–244
 - using with putenv function, REF–479
- Math functions, 7–1 to 7–6
 - abs, REF–6
 - acos, REF–9
 - acosh, REF–10
 - asin, REF–16
 - asinh, REF–17
 - atan, REF–19
 - atan2, REF–20
 - atanh, REF–21
 - cabs, REF–35
 - cacos, REF–36
 - cacosh, REF–37
 - carg, REF–39
 - casin, REF–40
 - casinh, REF–41
 - catan, REF–42
 - catanh, REF–43
 - cbrt, REF–51
 - ccos, REF–52
 - ccosh, REF–53
 - ceil, REF–54
 - cexp, REF–55
 - cimag, REF–60
 - clog, REF–70

Math functions (cont'd)

- conj, REF-79
- copysign, REF-80
- cos, REF-81
- cosh, REF-82
- cot, REF-83
- cpow, REF-84
- cproj, REF-85
- creal, REF-86
- csin, REF-95
- csinh, REF-96
- csqrt, REF-97
- ctan, REF-98
- ctanh, REF-99
- div, REF-141
- erf, REF-157
- errno values, 7-1
- exp, REF-167
- exp2, REF-168
- fabs, REF-169
- fdim, REF-181
- finite, REF-200
- floor, REF-202
- fma, REF-203
- fmax, REF-204
- fmin, REF-205
- fp_class, REF-209
- fp_classf, REF-209
- fp_classl, REF-209
- frexp, REF-223
- hypot, REF-316
- ilogb, REF-322
- isnan, REF-340
- j0, REF-359
- j1, REF-359
- jn, REF-359
- labs, REF-363
- ldexp, REF-366
- ldiv, REF-367
- lgamma, REF-369
- llabs, REF-486
- lldiv, REF-487
- log, REF-377
- log10, REF-377
- loglp, REF-378
- logb, REF-379
- lrint, REF-384
- lround, REF-385
- modf, REF-419
- nextafter, REF-440
- nexttoward, REF-441
- nint, REF-443
- pow, REF-471
- qabs, REF-486
- qdiv, REF-487
- rand, REF-490
- remainder, REF-505
- remquo, REF-506

Math functions (cont'd)

- rint, REF-513
- scalb, REF-516
- shm_open, REF-570
- shm_unlink, REF-572
- sin, REF-600
- sinh, REF-601
- sqrt, REF-607
- srand, REF-608
- tan, REF-692
- tanh, REF-693
- tgamma, REF-697
- trunc, REF-711
- unordered, REF-725
- y0, REF-835
- y1, REF-835
- yn, REF-835
- mblen function, REF-392
- mbrlen function, REF-393
- mbrtowc function, 3-7, 10-10, REF-394
- mbsinit function, REF-398
- mbsrtowcs function, 3-7, 10-10, REF-399
- mbstate_t, 10-10, REF-393, REF-394, REF-398, REF-399, REF-770, REF-794
- mbstowcs function, 10-10, REF-396
- mbtowc function, 3-7, 10-10, REF-397
- memccpy function, REF-401
- memchr function, REF-402
- memcmp function, REF-403
- memcpy function, REF-404
- memmove function, REF-405
- Memory allocation
 - introduction to, 8-1
 - program examples, 8-2
- Memory allocation functions
 - brk, REF-30
 - calloc, REF-38
 - cfree, REF-56
 - free, REF-221
 - malloc, REF-390
 - realloc, REF-501
 - sbrk, REF-515
- Memory reallocation, REF-221
- memset function, REF-406
- Message catalog, 10-3
 - creating, 10-5
- Messaging functions
 - catclose, REF-44
 - catgets, REF-45
 - catopen, REF-48
- mkdir function, REF-407
- mkstemp function, REF-410
- mktemp function, REF-411
- mktime function, REF-412
 - using with tzset function, REF-715
- mmap function, REF-414

modf function, REF-419
 Monetary formatting function
 strfmon, REF-635
 Monetary function, 10-8
 Mount points, 12-2, 12-15
 move function, REF-420
 mprotect function, REF-421
 rand48 function, REF-423
 using with lcong48 function, REF-365
 using with seed48 function, REF-521
 using with srand48 function, REF-609
 msync function, REF-424
 Multibyte character
 conversion to wide character, 10-10
 Multibyte character support
 btowc, REF-33
 mblen, REF-392
 mbrlen, REF-393
 mbrtowc, REF-394
 mbsinit, REF-398
 mbtowc, REF-397
 wrtomb, REF-770
 wctob, REF-816
 wctomb, REF-817
 Multibyte string support
 mbsrtowcs, REF-399
 mbstowcs, REF-396
 wcsrtombs, REF-794
 wcstombs, REF-806
 MULTITHREAD reentrancy, 1-50, REF-124
 Multithread Restrictions, 1-52
 munmap function, REF-426
 mvaddch function, REF-427
 mvaddstr function, REF-428
 mvcur function, REF-429
 mvdelch function, REF-430
 mvgetch function, REF-431
 mvgetstr function, REF-432
 mvinch function, REF-433
 mvinsch function, REF-434
 mvinsstr function, REF-435
 mvinsstr macro, 6-2
 mvwaddch function, REF-427
 mvwaddstr function, REF-428
 mvwdelch function, REF-430
 mvwgetch function, REF-431
 mvwgetstr function, REF-432
 mvwinch function, REF-433
 mvwin function, REF-436
 mvwinsch function, REF-434
 mvwinsstr function, REF-435
 mvwinsstr macro, 6-2

N

nanosleep function, REF-437
 New features, xxix
 newwin function, REF-439
 nextafter function, REF-440
 nexttoward function, REF-441
 NFS
 symbolic link support, 12-15
 nice function, REF-442
 nint function, REF-443
 nl function, REF-444
 nl_langinfo function, 10-8, REF-445
 noclrmode function, REF-93
 noecho function, REF-148
 NONE reentrancy, REF-124
 nonl function, REF-444
 Nonthread-safe functions, 1-52
 noraw function, REF-492
 nrand48 function, REF-449

O

Object libraries
 RTL, 1-3
 Object library
 VAXCRTLOLB, 1-4
 VAXCRTLOLD, 1-4
 VAXCRTLOLDX, 1-4
 VAXCRTLOLT, 1-4
 VAXCRTLOLTX, 1-4
 VAXCRTLOLX, 1-4
 Occlusion, 6-4
 ODS-5 volumes, 1-10
 opendir function, REF-453
 using with readdir function, REF-496
 using with rewinddir function, REF-511
 open function, REF-147, REF-173, REF-182,
 REF-450
 OpenVMS system services
 in HP C programs, 1-39
 OpenVMS versions, A-1
 Operating system version dependency, A-1
 overlay function, REF-29, REF-455
 overwrite function, REF-29, REF-456

P

passwd structure, REF-289, REF-292, REF-296
 Password encryption functions
 crypt, REF-94
 encrypt, REF-151
 setkey, REF-554
 pathconf function, REF-457
 pause function, REF-459

pclose function, REF-460
 using with popen function, REF-469
 perror function, 4-5, REF-461
 pipe function, REF-147, REF-173, REF-182, REF-462
 Pointers
 64-bit support, 1-53
 poll function, REF-466
 popen function, REF-469
 Portability concerns, 1-40
 arguments to mkdir, REF-407
 _exit function, REF-165
 _gsignal function, REF-314
 longname function, REF-382
 memory deallocation, REF-56
 mvscur function, 6-10
 mv[w]insstr functions, REF-435
 [no]nl functions, REF-444
 POSIX pathnames, 12-1
 radix conversion specifiers, 2-11
 raise function, REF-489
 specific
 list of, 1-48 to 1-50
 ssignal function, REF-613
 Symbolic links, 12-1
 ttyname function, REF-713
 ttyname_r function, REF-713
 UNIX file specifications, 1-7
 ambiguity of, 1-8
 variable-length argument lists, 3-9
 va_start_l macro, REF-739
 vfork versus fork function, REF-741
 [w]clrattr functions, REF-74
 [w]insstr functions, REF-330
 [w]setattr functions, REF-543
 POSIX pathnames, 1-10, 12-1 to 12-18
 POSIX root, 12-2
 POSIX Root Support, 1-23
 POSIX style identifiers, 1-38
 POSIX threads library, 1-50
 _POSIX_C_SOURCE macro, 1-11
 _POSIX_EXIT macro, 1-15, 1-16, 1-18
 pow function, REF-471
 pread function, REF-472
 Predefined macro
 ERR, 6-10
 Predefined variables and constants, 6-9
 printf function, REF-473
 printw function, REF-474
 Process permanent files, 2-19
 putc function, REF-475
 putchar function, REF-477
 putchar unlocked function, REF-478
 putc_unlocked function, REF-476
 putenv function, REF-479
 puts function, REF-481

putc function, REF-483
 putwchar function, REF-484
 putw function, REF-482
 pwrite function, REF-485

Q

qabs function, REF-486
 qdiv function, REF-487
 qsort function, REF-488
 Quotas
 affecting RTL, 5-1, 5-2, 5-5

R

raise function, 4-5, 4-10, REF-361, REF-489
 rand function, REF-490
 random function, REF-491
 raw function, REF-492
 readdir function, REF-496
 using with closedir function, REF-72
 readdir_r function, REF-496
 read function, REF-494
 readlink function, REF-498
 readv function, REF-499
 realloc function, 8-1, REF-501
 realpath function, REF-503
 Record
 access by HP C, 1-43
 I/O
 HP C handling of, 1-44
 Record files
 accessing in record mode, 1-43
 accessing in stream mode, 1-43
 Record Management Services (RMS)
 accessing files, 1-42
 file organization, 1-41
 in HP C programs, 1-39
 overview of, 1-41 to 1-45
 record access
 in HP C, 1-43
 record formats, 1-41
 stream access
 in HP C, 1-43
 Reentrancy, 1-50, REF-124
 AST, 1-50, REF-124
 MULTITHREAD, 1-50, REF-124
 NONE, REF-124
 Restrictions, 1-52
 TOLERANT, 1-50, REF-124
 Reentrancy function
 decc\$set reentrancy, 1-50, REF-124
 /REENTRANCY qualifier, 1-50
 refresh function, REF-64, REF-504
 remainder function, REF-505, REF-506
 remove function, REF-135, REF-507

remquo function, REF-505, REF-506
 rename function, REF-508
 Reserved POSIX filenames, 12-3
 rewinddir function
 using with readdir function, REF-496
 rewind function, REF-510
 rindex function, REF-512
 rint function, REF-513
 rmdir function, REF-514
 RMS
 file attributes, 2-4
 Root, POSIX, 12-2
 Run-Time Library (RTL)
 as shared images, 1-2
 Curses functions and macros, 6-1
 Date/time functions, 11-1
 header files, 1-7
 I/O, 1-39 to 1-45
 HP C handling of, 1-42 to 1-45
 interpreting syntax, 1-6
 introduction to, 1-1 to 1-63
 linking against RTL object libraries, 1-3
 linking against RTL shareable image, 1-3
 linking options explained, 1-2
 portability concerns, 1-40
 preprocessor directives, 1-7
 specific portability concerns, 1-48 to 1-50
 stream I/O, 1-43

S

sbrk function, 8-1, REF-515
 scalb function, REF-516
 scanf function, REF-517
 scanw function, REF-518
 Screen management
 Curses
 See Curses
 scroll function, REF-519
 scrollok function, REF-520
 Security/impersonation functions
 getegid, REF-264
 geteuid, REF-267
 getgid, REF-268
 getgroups, REF-276
 getpgid, REF-285
 getpgrp, REF-286
 getsid, REF-299
 getuid, REF-302
 seteuid, REF-547
 setgid, REF-548
 setpgid, REF-559
 setpgrp, REF-561
 setregid, REF-563
 setreuid, REF-564
 setsid, REF-565
 setuid, REF-567

seed48 function, REF-521
 using with drand48 function, REF-146
 using with lcong48 function, REF-365
 using with lrand48 function, REF-383
 using with mrand48 function, REF-423
 seekdir function, REF-522
 Semaphore functions
 ftok, REF-240
 semctl, REF-524
 semget, REF-528
 semop, REF-535
 sem_close, REF-523
 sem_destroy, REF-527
 sem_getvalue, REF-530
 sem_init, REF-531
 sem_open, REF-533
 sem_post, REF-538
 sem_timedwait, REF-539
 sem_trywait, REF-540
 sem_unlink, REF-541
 sem_wait, REF-542
 semctl function, REF-524
 semget function, REF-528
 semop function, REF-535
 sem_close function, REF-523
 sem_destroy function, REF-527
 sem_getvalue function, REF-530
 sem_init function, REF-531
 sem_open function, REF-533
 sem_post function, REF-538
 sem_timedwait function, REF-539
 sem_trywait function, REF-540
 sem_unlink function, REF-541
 sem_wait function, REF-542
 setattr function, REF-543
 setattr macro, 6-2
 setbuf function, REF-544
 setenv function, REF-545
 seteuid function, REF-547
 setgid function, REF-548
 setgrent function, REF-549
 setitimer function, REF-550
 using with ualarm function, REF-719
 setjmp function, 4-10, REF-380, REF-552,
 REF-735, REF-741
 setkey function, REF-554
 setlocale function, 10-4, REF-555
 setpgid function, REF-559
 setpgrp function, REF-561
 setpwent function, REF-562
 setregid function, REF-563
 setreuid function, REF-564
 setsid function, REF-565
 setstate function, REF-566
 using with initState function, REF-326
 setuid function, REF-567

- setvbuf function, REF-568
 - using with popen function, REF-469
- Shareable image, 1-3
- Shared image
 - HP C RTL, 1-2
- shm_open function, REF-570
- shm_unlink function, REF-572
- sigaction function, REF-573
- sigaction structure, REF-573
- sigaddset function, REF-576
- sigblock function, 4-7, REF-577, REF-587
- sigdelset function, REF-578
- sigemptyset function, REF-579
- sigfillset function, REF-580
- sighold function, REF-581
- sigignore function, REF-582
- sigismember function, REF-583
- siglongjmp function, REF-584
- sigmask function, REF-585
- <signal.h> header file, 4-6
- signal function, 4-7, 4-10, REF-314, REF-489, REF-586, REF-613
- Signal handler
 - calling interface, 4-7
- Signal-handling functions, 4-5
 - alarm, REF-13
 - gsignal, REF-314
 - kill, REF-361
 - longjmp, REF-380
 - OpenVMS exceptions, 4-10
 - pause, REF-459
 - program examples, 4-13
 - raise, REF-489
 - setjmp, REF-552
 - sigaction, REF-573
 - sigaddset, REF-576
 - sigblock, REF-577
 - sigdelset, REF-578
 - sigemptyset, REF-579
 - sigfillset, REF-580
 - sighold, REF-581
 - sigignore, REF-582
 - sigismember, REF-583
 - siglongjmp, REF-584
 - sigmask, REF-585
 - signal, REF-586
 - sigpause, REF-587
 - sigpending, REF-588
 - sigprocmask, REF-589
 - sigrelse, REF-591
 - sigsetjmp, REF-592
 - sigsetmask, REF-594
 - sigsuspend, REF-595
 - sigtimedwait, REF-596
 - sigvec, REF-597
 - sigwait, REF-598
 - sigwaitinfo, REF-599
 - sleep, REF-602
- Signal-handling functions (cont'd)
 - ssignal, REF-613
 - UNIX signals, 4-6
 - VAXC\$ESTABLISH, REF-735
- Signals, 4-5
 - sigpause function, REF-587
 - sigpending function, REF-588
 - sigprocmask function, REF-589
 - sigrelse function, REF-591
 - sigsetjmp function, REF-592
 - sigsetmask function, 4-7, REF-594
 - sigsuspend function, REF-595
 - sigtimedwait function, REF-596
 - sigvec function, 4-7, 4-10, REF-314, REF-489, REF-597
 - sigwait function, REF-598
 - sigwaitinfo function, REF-599
- sin function, REF-600
- sinh function, REF-601
- sleep function, REF-602
- snprintf function, REF-603
- _SOCKADDR_LEN macro, 1-16
- socket routines
 - documentation, xxv
 - help, xxv
- Special files, 12-3
- Specification delimiters
 - OpenVMS and UNIX, 1-8
- sprintf function, REF-605
- sqrt function, REF-607
- srand48 function, REF-609
 - using with drand48 function, REF-146
 - using with lcong48 function, REF-365
 - using with lrand48 function, REF-383
 - using with mrand48 function, REF-423
- srand function, REF-608
- random function, REF-610
 - using with random function, REF-491
- sscanf function, REF-611
- ssignal function, 4-7, REF-314, REF-489, REF-613
- Standard header file, 1-1
- Standard I/O, 1-39
 - file pointers, 2-5
 - introduction to, 2-1
 - program example, 2-22
 - wide character, 2-23
- Standard I/O functions
 - clearerr, REF-62
 - clearerr unlocked, REF-63
 - delete, REF-135, REF-507
 - dlclose, REF-142
 - dLError, REF-143
 - dlopen, REF-144
 - dlsym, REF-145
 - fclose, REF-172
 - fdopen, REF-182
 - feof, REF-183

Standard I/O functions (cont'd)

- feof_unlocked, REF-184
- ferror, REF-185
- ferror_unlocked, REF-186
- fflush, REF-187
- fgetc, REF-189
- fgetc_unlocked, REF-190
- fgetname, REF-191
- fgets, REF-194
- fgetwc, REF-196
- fgetws, REF-197
- flockfile, REF-201
- fopen, REF-207
- fprintf, REF-212
- fputc, REF-214
- fputc_unlocked, REF-215
- fputs, REF-216
- fputwc, REF-217
- fputws, REF-219
- fread, REF-220
- freopen, REF-222
- fscanf, REF-225
- fseek, REF-227
- fseeko, REF-229
- ftell, REF-237
- ftello, REF-238
- ftrylockfile, REF-242
- funlockfile, REF-246
- fwrite, REF-251
- getc, REF-256
- getchar_unlocked, REF-260
- getc_unlocked, REF-257
- getw, REF-303
- getwc, REF-304
- mktemp, REF-411
- putc, REF-475
- putchar_unlocked, REF-478
- putc_unlocked, REF-476
- putw, REF-482
- putwc, REF-483
- rewind, REF-510
- setbuf, REF-544
- setvbuf, REF-568
- snprintf, REF-603
- sprintf, REF-605
- sscanf, REF-611
- tmpfile, REF-700
- tmpnam, REF-701
- ungetc, REF-722
- ungetwc, REF-723

Standards

- listed, 1-10

- standend function, REF-614
- standout function, REF-615
- stat function, REF-616
 - using with ftw function, REF-243

- stat structure
 - using with ftw function, REF-243
- statvfs function, REF-621
- __STDC_VERSION__ macro, 1-11
- stderr, 2-20, REF-187, REF-222, REF-461, REF-464
- stdin, 2-20, REF-222, REF-464, REF-517
- <stdio.h> header file, 2-20
- stdout, 2-20, REF-222, REF-464, REF-473, REF-477, REF-481, REF-484
- stdscr window, 6-5
- strcasecmp function, REF-623
- strcat function, REF-624
- strchr function, REF-402, REF-626
- strcmp function, REF-403, REF-628
- strcmpn function, 1-49
- strcoll function, 10-11, REF-629
- strcpy function, REF-404, REF-630
- strcpyn function, 1-49
- strcspn function, REF-631
- strdup function, REF-632

Stream

- access by HP C, 1-43
- files, 2-1
- strerror function, 4-5, REF-633
- strfmon function, 10-8, REF-635
- strftime function, 10-8, REF-639
 - using with tzset function, REF-715

String comparison functions

- multipass collation, 10-11
- wcscoll, REF-776

String encoding functions

- crypt, REF-94
- encrypt, REF-151
- setkey, REF-554

String-handling functions, 3-9 to 3-10

- atof, REF-23
- atoi, REF-24
- atol, REF-24
- atoll, REF-25
- atoq, REF-25
- basename, REF-26
- bcmp, REF-27
- bcopy, REF-28
- bzero, REF-34
- dirname, REF-139
- ffs, REF-188
- index, REF-324
- memchr, REF-402
- memcmp, REF-403
- memcpy, REF-404
- memmove, REF-405
- memset, REF-406
- program examples, 3-10
- rindex, REF-512
- strcasecmp, REF-623
- strcat, REF-624
- strchr, REF-626

String-handling functions (cont'd)

- strcmp, REF-628
- strcoll, REF-629
- strcpy, REF-630
- strncpy, REF-631
- strdup, REF-632
- strlen, REF-645
- strncasecmp, REF-646
- strncat, REF-647
- strncmp, REF-648
- strncpy, REF-650
- strnlen, REF-651
- strpbrk, REF-652
- strrchr, REF-658
- strsep, REF-659
- strspn, REF-660
- strstr, REF-661
- strtod, REF-663
- strtok, REF-665
- strtok_r, REF-665
- strtol, REF-668
- strtoll, REF-670
- strtoq, REF-670
- strtoul, REF-672
- strtoull, REF-673
- strtouq, REF-673
- strxfrm, REF-674
- swab, REF-678
- wscat, REF-771
- wchr, REF-773
- wscmp, REF-775
- wscoll, REF-776
- wscopy, REF-777
- wscspn, REF-778
- wcslen, REF-786
- wcsncat, REF-787
- wcsncmp, REF-789
- wcsncpy, REF-790
- wcspbrk, REF-791
- wcsrchr, REF-792
- wcsspn, REF-796
- wcstok, REF-801
- wcstol, REF-804
- wcstoul, REF-807
- wcswcs, REF-810
- wcsxfrm, REF-813
- strlen function, REF-645
- strncasecmp function, REF-646
- strncat function, REF-647
- strncmp function, REF-648
- strncpy function, REF-650
- strnlen function, REF-651
- strpbrk function, REF-652
- strptime function, 10-8, REF-653
- strrchr function, REF-658
- strsep function, REF-659
- strspn function, REF-660
- strstr function, REF-661
- strtod function, 10-8, REF-23, REF-663
- strtok function, REF-665
- strtok_r function, REF-665
- strtol function, REF-24, REF-25, REF-668
- strtoll function, REF-670
- strtoq function, REF-670
- strtoul function, REF-672
- strtoull function, REF-673
- strtouq function, REF-673
- strxfrm function, 10-11, REF-674
- Subprocess, 5-1 to 5-11
 - executing image
 - with exec functions, 5-3
 - implementation of, 5-2
 - introduction to, 5-1
 - program examples, 5-5 to 5-11
 - sharing data with pipe, 5-5, REF-462
 - synchronization with wait, 5-5
- Subprocess functions
 - decc\$set_child_default_dir, REF-119
 - decc\$set_child_standard_streams, REF-120
 - decc\$validate wchar, REF-130
 - decc\$write_eof_to_mbx, REF-131
 - execl, REF-158
 - execle, REF-160
 - execlp, REF-161
 - execv, REF-162
 - execve, REF-163
 - execvp, REF-164
 - pipe, REF-462
 - vfork, REF-741
 - wait, REF-759
- subwin function, REF-677
- swab function, REF-678
- swprintf function, REF-679
- swscanf function, REF-680
- Symbolic link functions
 - lchown, REF-364
 - lstat, REF-388
 - readlink, REF-498
 - realpath, REF-503
 - symlink, REF-681
 - unlink, REF-724
- Symbolic links, 1-10, 12-1 to 12-18
- symlink function, REF-681
- Synchronizing processes, 5-5
- Syntax
 - of HP C RTL functions, 1-6
- SYS\$ERROR, 2-20
- SYS\$I18N_LOCALE logical name, 10-3
- SYS\$INPUT, 2-20
- SYS\$LANG logical name, 10-5
- SYS\$LC_ALL logical name, 10-5

SYS\$OUTPUT, 2-20
 SYS\$POSIX_ROOT, 1-23
 SYS\$WAKE, REF-13
 sysconf function, REF-683
 system function, REF-690
 System functions, 9-1 to 9-5
 asctime, REF-14
 asctime_r, REF-14
 assert, REF-18
 atexit, REF-22
 bsearch, REF-31
 chdir, REF-57
 chmod, REF-58
 chown, REF-59
 clock, REF-65
 ctermid, REF-100
 ctime, REF-101
 ctime_r, REF-101
 cuserid, REF-103
 difftime, REF-138
 fchmod, REF-170
 fchown, REF-171
 fmod, REF-206
 ftime, REF-239
 getcwd, REF-262
 getenv, REF-265
 getpid, REF-287
 getppid, REF-288
 gmtime, REF-312
 gmtime_r, REF-312
 introduction to, 9-3
 localtime, REF-375
 localtime_r, REF-375
 memset, REF-406
 mkdir, REF-407
 nice, REF-442
 program examples, 9-3
 qsort, REF-488
 remainder, REF-505
 remove, REF-135, REF-507
 remquo, REF-506
 rename, REF-508
 setbuf, REF-544
 setvbuf, REF-568
 strtod, REF-663
 strtok, REF-665
 strtok_r, REF-665
 system, REF-690
 time, REF-698
 times, REF-699
 umask, REF-720
 utime, REF-728
 utimes, REF-731
 vfprintf, REF-743
 vfscanf, REF-744
 vprintf, REF-749
 vscanf, REF-750
 vsprintf, REF-751

System functions (cont'd)
 vsprintf, REF-752
 vsscanf, REF-753
 wcstod, REF-799
 wcstok, REF-801
 writev, REF-832

T

tan function, REF-692
 tanh function, REF-693
 telldir function, REF-694
 tempnam function, REF-695
 Terminal I/O
 program examples, 2-20 to 2-25
 Terminal I/O functions
 getchar, REF-259
 gets, REF-298
 getwchar, REF-305
 printf, REF-473
 putchar, REF-477
 puts, REF-481
 putwchar, REF-484
 scanf, REF-517
 tgamma function, REF-697
 Thread-safety, 1-52
 Time
 introduction to, 11-1
 time function, REF-698
 Time functions, 11-1 to 11-6
 Time-related functions
 asctime, REF-14
 asctime_r, REF-14
 clock, REF-65
 clock_getres, REF-66
 clock_gettime, REF-67
 clock_settime, REF-68
 ctime, REF-101
 ctime_r, REF-101
 decc\$fix_time, REF-113
 difftime, REF-138
 ftime, REF-239
 getclock, REF-261
 getitimer, REF-277
 gettimeofday, REF-301
 gmtime, REF-312
 gmtime_r, REF-312
 localtime_r, REF-375
 mktime, REF-412
 nanosleep, REF-437
 setitimer, REF-550
 strftime, REF-639
 strptime, REF-653
 time, REF-698
 times, REF-699
 tzset, REF-715
 ualarm, REF-719
 usleep, REF-727

Time-related functions (cont'd)

- utime, REF-728
- utimes, REF-731
- wcsftime, REF-780

times function, REF-699

timespec structure, REF-261

Time-zone cache, REF-718

tmpfile function, REF-700

tmpnam function, REF-701

toascii function, 3-7, REF-702

TOLERANT reentrancy, 1-50, REF-124

_tolower macro, 3-7

_tolower function, REF-704

tolower function, 3-7, REF-703

touchwin function, REF-705

_toupper macro, 3-7

_toupper function, REF-707

toupper function, 3-7, REF-706

towctrans function, 3-7, 10-9, REF-708

towlower function, 10-9, REF-709

towupper function, 10-9, REF-710

truncate function, REF-712

trunc function, REF-711

ttyname function, REF-713

ttyname_r function, REF-713

tzset function, REF-715

U

ualarm function, REF-719

UIDs, 1-38

umask function, REF-720

umask value, 5-4

uname function, REF-721

ungetc function, REF-722

ungetwc function, REF-723

Unicode UTF-8 encoding, 1-28

UNIX

- file specification conversion functions, 1-8
- file specifications, 1-7 to 1-10
 - alternate translation, 1-9
 - compared to OpenVMS, 1-8
- Run-Time Library, 1-7
- use with HP C RTL, 1-7 to 1-10

UNIX I/O, 1-39

- file descriptors, 2-5
- functions
 - program example, 2-24

UNIX I/O functions

- close, REF-71
- creat, REF-87
- dup, REF-147
- dup2, REF-147
- fcntl, REF-173
- fileno, REF-199
- fstat, REF-231
- getname, REF-280
- getopt, REF-281

UNIX I/O functions (cont'd)

- isapipe, REF-333
- isatty, REF-335
- lseek, REF-386
- open, REF-450
- pread, REF-472
- pwrite, REF-485
- read, REF-494
- readv, REF-499
- stat, REF-616
- ttyname, REF-713
- ttyname_r, REF-713
- write, REF-831

UNIX style root, 1-23

__UNIX_PUTC macro, 1-18

unlink function, REF-724

unordered function, REF-725

unsetenv function, REF-726

User database functions

- endpwent, REF-153
- getpwuid, REF-295
- getpwuid_r, REF-295
- setpwent, REF-562

User Identifier, 1-38

_USE_STD_STAT macro, 1-18

usleep function, REF-727

utime function, REF-728

utimes function, REF-731

V

<varargs.h> header file, 3-9

Variable-length argument lists, 3-9

Variable-length record files

- accessing in record mode, 1-45

VAXC\$CRTL_INIT function, 4-10, REF-720, REF-734

vaxc\$errno external variable, 4-5

VAXC\$ESTABLISH function, 4-10, REF-380, REF-552, REF-735

VAXC\$EXECMBX logical name, 5-4

va_arg function, REF-736

va_count macro, REF-737

va_end function, REF-738

va_start macro, REF-739

va_start_1 macro, REF-739

Version-dependency of HP C RTL routines, A-1

vfork function, REF-463, REF-741

vfprintf function, REF-743

vfscanf function, REF-744

vfwprintf function, REF-746

vwscanf function, REF-748

_VMS_CURSES macro, 1-16

_VMS_V6_SOURCE macro, 1-15

__VMS_VER macro, 1-15

__VMS_VER_OVERRIDE macro, 1-15

vprintf function, REF-749
vscanf function, REF-750
vsnprintf function, REF-751
vsprintf function, REF-752
vsscanf function, REF-753
vswprintf function, REF-754
vswscanf function, REF-756
vwprintf function, REF-757
vwscanf function, REF-758

W

waddch function, REF-11
waddstr function, REF-12
wait3 function, REF-760
wait4 function, REF-763
wait function, REF-759
 using with waitpid function, REF-766
waitpid function, REF-766
wclear function, REF-61
wclratrr function, 6-2, REF-74
wclrtoeb function, REF-75
wclrtoeol function, REF-76
wcrtoeb function, 3-7, 10-10, REF-770
wscat function, REF-771
wchr function, REF-773
wscmp function, REF-775
wscoll function, 10-11, REF-776
wscpy function, REF-777
wscspn function, REF-778
wcsftime function, 10-8, REF-780
wcslen function, REF-786
wscncat function, REF-787
wscncmp function, REF-789
wscncpy function, REF-790
wspbrk function, REF-791
wscrchr function, REF-792
wscrtoeb function, 3-7, 10-10, REF-794
wcsspn function, REF-796
wcssstr function, REF-798
wcstod function, 10-8, REF-799
wcstok function, REF-801
wcstol function, REF-804
wcstombs function, 10-10, REF-806
wcstoul function, REF-807
wswcs function, REF-810
wswidth function, REF-812
wscxfrm function, 10-11, REF-813
wctob function, 10-10, REF-816
wctomb function, 10-10, REF-817
wctrans function, 3-7, 10-9, REF-818
wctype function, REF-819
wctype function, REF-822
wdelch function, REF-134
wdeleteln function, REF-136
werase function, REF-156

wgetch function, REF-148, REF-258
wgetstr function, REF-148, REF-300

Wide character

collating functions, 10-11
conversion to multibyte, 10-10
data type, 10-9
functions, 10-9
I/O functions, 10-10

Wide-character functions

btowc, REF-33
fgetwc, REF-196
fgetws, REF-197
fputwc, REF-217
fputws, REF-219
fwide, REF-248
fwprintf, REF-249
fwscanf, REF-252
getwc, REF-304
getwchar, REF-305
iswalnum, REF-345
iswalp, REF-346
iswcntrl, REF-347
iswctype, REF-348
iswdigit, REF-350
iswgraph, REF-351
iswlower, REF-352
iswprint, REF-353
iswpunct, REF-354
iswspace, REF-355
iswupper, REF-356
iswxdigit, REF-357
mbrlen, REF-393
mbrtowc, REF-394
mbsinit, REF-398
mbsrtowcs, REF-399
putwc, REF-483
putwchar, REF-484
swprintf, REF-679
swscanf, REF-680
towctrans, REF-708
tolower, REF-709
toupper, REF-710
ungetwc, REF-723
vfwprintf, REF-746
vwscanf, REF-748
vswprintf, REF-754
vswscanf, REF-756
vwprintf, REF-757
vwscanf, REF-758
wcrtoeb, REF-770
wscat, REF-771
wchr, REF-773
wscmp, REF-775
wscoll, REF-776
wscpy, REF-777
wscspn, REF-778
wcsftime, REF-780
wcslen, REF-786

Wide-character functions (cont'd)

wcsncat, REF-787
wcsncmp, REF-789
wcsncpy, REF-790
wspbrk, REF-791
wscrchr, REF-792
wstrtombs, REF-794
wcsspn, REF-796
wcssstr, REF-798
wcstod, REF-799
wcstok, REF-801
wcstol, REF-804
wcstoul, REF-807
wswcs, REF-810
wswidth, REF-812
wlsxfrm, REF-813
wctob, REF-816
wctrans, REF-818
wctype, REF-819
wcwidth, REF-822
wmemchr, REF-823
wmemcmp, REF-824
wmemcpy, REF-825
wmemmove, REF-826
wmemset, REF-827
wprintf, REF-828
wscanf, REF-834

Wide character I/O
 program example, 2-23

Wide-character I/O, 2-6

winch function, REF-323

winsch function, REF-328

winsertln function, REF-329

winsstr function, 6-2, REF-330

wmemchr function, REF-823

wmemcmp function, REF-824

wmemcpy function, REF-825

wmemmove function, REF-826

wmemset function, REF-827

wmove function, REF-420

wprintf function, REF-828

wprintw function, REF-474

wrapok function, REF-830

wrefresh function, REF-504

write function, REF-831

writew function, REF-832

wscanf function, REF-834

wscanw function, REF-518

wsetattr function, 6-2, REF-543

wstandend function, REF-614

wstandout function, REF-615

X

`_XOPEN_SOURCE` macro, 1-11

`_XOPEN_SOURCE_EXTENDED` macro, 1-11

Y

y0 function, REF-835

y1 function, REF-835

yn function, REF-835

