

DECnet-Plus

FTAM and Virtual Terminal Use and Management

Order Number: AA-Q78TD-TE

November 1996

This manual provides information about the FTAM and Virtual Terminal applications that are part of the DECnet-Plus product set.

Revision/Update Information:	This is a revised manual.
Operating Systems:	OpenVMS VAX Version 7.1 OpenVMS Alpha Version 7.1 Digital UNIX Version 4.0
Software Versions:	DECnet-Plus for OpenVMS Version 7.1 DECnet/OSI for Digital UNIX Version 4.0 FTAM Version 3.2 Virtual Terminal Version 2.1

Digital Equipment Corporation
Maynard, Massachusetts

November 1996

Digital Equipment Corporation makes no representations that the use of its products in the manner described in this publication will not infringe on existing or future patent rights, nor do the descriptions contained in this publication imply the granting of licenses to make, use, or sell equipment or software in accordance with the description.

Possession, use, or copying of the software described in this publication is authorized only pursuant to a valid written license from Digital or an authorized sublicensor.

Digital conducts its business in a manner that conserves the environment and protects the safety and health of its employees, customers, and the community.

© Digital Equipment Corporation 1996. All rights reserved.

The following are trademarks of Digital Equipment Corporation: Bookreader, DDCMP, DEC, DECdirect, DECnet, DECNIS, DECserver, DECsystem, DECwindows, Digital, DNA, InfoServer, OpenVMS, PATHWORKS, ULTRIX, VAX, VAX DOCUMENT, VAXcluster, VAXstation, VMS, VMScluster, and the DIGITAL logo.

The following are third-party trademarks:

Macintosh is a registered trademark of Apple Computer, Inc.

MS-DOS is a registered trademark of Microsoft Corporation.

OS/2 is a registered trademark of International Business Machines Corporation.

UNIX is a registered trademark in the United States and other countries, licensed exclusively through X/Open Co. Ltd.

All other trademarks and registered trademarks are the property of their respective holders.

Contents

Preface	xi
----------------------	----

Part I Introduction

1 OSI Applications Overview

1.1	FTAM Overview	1-1
1.2	FTAM Gateways	1-2
1.3	FTAM User Facilities	1-2
1.4	Virtual Terminal Overview	1-3
1.4.1	Virtual Terminal Interactions	1-3
1.4.2	Virtual Terminal Operation in a Network	1-4
1.4.3	Virtual Terminal Profiles	1-5
1.4.4	Virtual Terminal Repertoires	1-6

Part II Use

2 Using FTAM

2.1	FTAM File Specifications	2-1
2.1.1	File Specification Format for OpenVMS	2-2
2.1.1.1	FTAM Application Address	2-2
2.1.1.2	Security Information	2-3
2.1.1.3	Account Name	2-3
2.1.1.4	File Designation	2-3
2.1.1.5	Using Wildcards with the Directory Facility	2-4
2.1.2	File Specification Format for Digital UNIX	2-5
2.1.2.1	Application Address	2-5
2.1.2.2	Path Name	2-6
2.2	FTAM Commands	2-7
2.2.1	FTAM Responder Log File	2-8
2.2.2	Copying Files	2-8
2.2.2.1	Copying FTAM-2 Document Types	2-9
2.2.2.2	Copying Files With Records Larger Than 7168 Bytes	2-9
2.2.2.3	Copying FTAM Files	2-9
2.2.2.4	Copying Files with Confirmation	2-9
2.2.2.5	Copying Files With No Output File-Designation	2-10
2.2.3	Appending Files	2-10
2.2.3.1	Concatenating with the copy Command	2-11
2.2.3.2	Appending Files with the ocp Command	2-11
2.2.4	Deleting Files	2-12
2.2.5	Listing Files	2-12
2.2.6	Renaming Files	2-13

2.3	Recovering from Data Transfer Errors While Copying or Appending	2-14
2.4	File Protection Assignment Upon File Creation	2-16

3 Using the DAP-FTAM Gateway (OpenVMS)

3.1	Function of the DAP-FTAM Gateway	3-1
3.2	Invoking the DAP-FTAM Gateway from OpenVMS FTAM Nodes	3-1
3.3	Supported Qualifiers for OpenVMS Systems	3-2
3.4	Supported Document Types	3-3
3.5	Quoting File Names	3-3
3.6	DAP-FTAM Gateway Messages	3-3

4 Using the FTAM-FTP Gateway (Digital UNIX)

4.1	Gateway Functions and Sample Commands	4-1
4.2	Using the FTAM-FTP Gateway from an Internet Host	4-2
4.2.1	Invoking the FTAM-FTP Gateway from Internet Nodes	4-2
4.2.2	Specifying a Concatenation Character	4-2
4.2.3	Sample Internet Commands	4-4
4.2.4	Starting an FTP Session	4-5
4.2.5	Ending an FTP Session	4-5
4.2.6	Connecting to a Remote OSI Node	4-6
4.2.7	Disconnecting from a Remote OSI Node	4-6
4.2.8	Viewing Remote Directories	4-6
4.2.9	Displaying Remote Files	4-7
4.2.10	Setting the File Transfer Type	4-8
4.2.11	Copying Files Between Systems	4-8
4.3	Using the FTAM-FTP Gateway from an OSI Node	4-10
4.3.1	Invoking the FTAM-FTP Gateway from OpenVMS FTAM Nodes	4-10
4.3.2	Sample OpenVMS FTAM Commands	4-10
4.3.3	Viewing Remote Directories	4-11
4.3.4	Copying Files Between Systems	4-11
4.3.5	Deleting Remote Files	4-12
4.3.6	Renaming Files Between Systems	4-12
4.4	Special Considerations for Internet Systems	4-12
4.5	Special Considerations for Internet Systems Not Based on UNIX	4-12

5 Using Virtual Terminal

5.1	Accessing Remote Nodes	5-1
5.1.1	Starting a VT Association	5-1
5.1.2	Using VT in Command Mode	5-3
5.2	Using Gateways for Remote OSI Node Access	5-6
5.2.1	Using the LAT/VT Gateway	5-7
5.2.2	Using the OpenVMS VT/LAT Gateway	5-8
5.2.3	Using the Telnet/VT Gateway	5-9
5.2.4	Using the VT/Telnet Gateway	5-11
5.2.5	Using the Digital UNIX CTERM/VT Gateway	5-13
5.2.6	Using the Digital UNIX VT/CTERM Gateway	5-14
5.3	Interoperability Issues With Previous Versions	5-14
5.3.1	SEND SYNCH	5-15
5.3.2	VT-BREAK	5-15
5.3.3	Set Terminal	5-15
5.3.4	Telnet/VT Gateway	5-15

Part III Concepts

6 General OSI Concepts

6.1	Protocols	6-2
6.2	Dialogue	6-2
6.3	Entities	6-2
6.4	Services	6-3
6.4.1	Service Primitives	6-3
6.4.2	Service Access Points	6-4
6.4.3	Functional Units	6-6
6.5	Protocol Control Information (PCI)	6-6
6.6	Syntaxes	6-6
6.7	Protocol Data Units (PDUs)	6-7

7 The Application Layer: FTAM and ACSE

7.1	FTAM Application Processes and Entities	7-1
7.2	Overview of FTAM Operation	7-2
7.2.1	Basic Components of FTAM Communications	7-2
7.2.2	Virtual-Filestore Model	7-3
7.2.2.1	File Attributes	7-4
7.2.2.2	File Contents	7-4
7.2.2.3	File Structure	7-4
7.2.2.4	Access Contexts	7-7
7.2.2.5	Constraint Sets	7-7
7.2.2.6	Document Types	7-7
7.2.2.7	Activity Attributes	7-8
7.2.3	File-Service Model	7-8
7.2.3.1	Regimes	7-8
7.2.3.2	FTAM Services	7-9
7.2.3.3	Relationship of Services to Regimes	7-11
7.2.4	The FTAM File Protocol	7-12
7.2.5	Summary of the FTAM Operation Overview	7-13
7.3	Overview of ACSE	7-13
7.3.1	Establishing an Association	7-13
7.3.2	Terminating an Association	7-14
7.3.3	ACSE Services	7-14

8 Introduction to Presentation and Session Layers

8.1	Context Management (Presentation)	8-1
8.2	Connection Management (Presentation and Session)	8-1
8.3	Dialogue Control (Presentation and Session)	8-2
8.4	Information Transfer (Presentation and Session)	8-2
8.5	Presentation and Session Services	8-2

Part IV Management

9 The OSI Application-Entity Database

9.1	About The OSI Applications Database	9-1
9.1.1	Support For X.500 Directory Service	9-1
9.1.2	Updating isoapplications	9-2
9.2	Entry Formats in isoapplications	9-2
9.2.1	The Address Format	9-2
9.2.1.1	Using Transport Options	9-4
9.2.2	The Distinguished Name Format	9-5
9.2.3	The Pattern Format	9-6
9.3	Managing the OSI Applications Entity Database	9-7
9.4	How Entries in isoapplications Are Used	9-7
9.5	Usage Considerations	9-9
9.6	Determining Service Access Points Selectors for Application Addresses	9-9
9.6.1	Specifying PSEL, SSEL, and TSEL Values	9-11
9.6.2	Specifying NSAP Values	9-11
9.6.3	Specifying NSAP Values for X.25	9-11

10 Managing FTAM (OpenVMS)

10.1	Required System Resources	10-1
10.1.1	Quotas for Initializing FTAM Software	10-1
10.1.2	User Quotas	10-1
10.2	Required Privileges	10-1
10.3	The OSAKserver	10-2
10.4	Initializing the OSAKserver and FTAM	10-2
10.5	Event Logging to OPCOM Consoles	10-2
10.6	Downstream Processing Support	10-2
10.7	Controlling RMS Record I/O	10-3
10.8	Overview of FTAM Addressing	10-3
10.8.1	Application-Entity Titles (AE-titles)	10-4
10.9	Managing Inbound Addresses	10-4
10.9.1	The Local Application Address Format	10-4
10.9.2	File Designation	10-5
10.9.3	OpenVMS User Name	10-5
10.9.4	OpenVMS Login Password	10-5
10.9.5	OpenVMS Account	10-5
10.9.6	Transport Class	10-5
10.9.7	Transport Options	10-5
10.9.8	The FTAM Default Address	10-5
10.9.9	Example of Inbound Address Entry	10-6
10.9.10	The DAP-FTAM Gateway Default Account	10-6
10.10	Managing Outbound Addresses	10-7
10.11	Overview of FTAM Operations	10-7
10.11.1	Dynamics of Outbound Connections	10-9
10.11.2	Dynamics of Inbound Connections	10-10

11 Managing a VT Application (OpenVMS)

11.1	Managing the OSI Application Entity Database	11-1
11.2	Managing the VT Responder	11-1
11.3	Managing the VT Gateways	11-2
11.3.1	Telnet/VT Gateway	11-4
11.3.2	LAT/VT Gateway	11-5
11.4	Identifying Connection Problems	11-5

12 Managing FTAM and Virtual Terminal (Digital UNIX)

12.1	Managing the OSI Application Entity Database	12-1
12.2	Using the /usr/sbin/osiapplsetup Procedure	12-2
12.3	Managing Listeners	12-2
12.3.1	Using osi_applstartup to Start Listeners at System Startup	12-2
12.3.2	Listening on OSI and RFC 1006 Networks	12-3
12.3.3	Starting Listeners	12-4
12.3.4	Registering Listeners in X.500 Directory	12-5
12.4	Managing FTAM Virtual Filestore Information	12-5
12.5	Managing the FTAM-FTP Gateway	12-6
12.5.1	Invoking the FTAM Daemon	12-6
12.5.2	Invoking the FTP-FTAM Daemon	12-7
12.6	Managing the Virtual Terminal Gateways	12-7
12.6.1	Enabling The LAT/VT Gateway Service	12-8

13 Lower-Layer Addressing Information (OpenVMS)

13.1	Overview of Open-System Networks	13-1
13.2	OSI Transport Templates	13-2
13.3	OSI Transport Addresses	13-2
13.4	Gathering Lower-Layer Addressing Information	13-3
13.4.1	Selecting the OSI Transport Template Type	13-3
13.4.2	Addressing Requirements for Direct X.25 Access	13-4
13.4.2.1	Addressing Elements	13-5
13.4.2.2	Gathering Remote Addressing Information	13-7
13.4.2.3	Gathering Local Addressing Information	13-7
13.4.3	Addressing Requirements for Direct IEEE 802 Access	13-9
13.4.3.1	Gathering Remote Addressing Information	13-11
13.4.3.2	IEEE 802 OSI Transport Address Variables	13-11
13.4.4	Addressing Requirements for Internet Access	13-12
13.4.4.1	Gathering Remote Addressing Information	13-13
13.4.4.2	Gathering Local Addressing Information	13-14
13.5	Alternative Addressing Terminology	13-14

14 Lower-Layer Addressing Information (Digital UNIX)

14.1	Overview of Open-System Networks	14-1
14.2	OSI Transport Templates	14-2
14.3	Overview of OSI Lower-Layer Addressing	14-2
14.3.1	OSI Transport Addresses	14-3
14.3.2	Network Addresses	14-3
14.3.3	IEEE 802 LAN Addresses	14-3
14.3.4	X.25 Addressing Elements	14-3
14.4	Gathering Lower-Layer Addressing Information	14-4
14.4.1	Selecting the OSI Transport Template Type	14-4

14.4.2	Determining the Target System's NSAP Address	14-4
14.4.3	Addressing Requirements for Direct X.25 Access (CONS)	14-5
14.4.3.1	The Call Data Value and Call Mask	14-5
14.4.3.2	Gathering Remote Addressing Information for TP/CONS Configuration	14-7
14.4.3.3	Gathering Local Addressing Information	14-7
14.4.4	Gathering Remote Addressing Information for TP4/Null IP Configuration	14-10
14.4.5	Addressing Requirements for CLNS Access	14-10
14.4.5.1	Gathering Remote Addressing Information	14-11
14.4.5.2	Gathering Local Addressing Information	14-11
14.5	Alternative Addressing Terminology	14-11

Appendixes

A FTAM Command Summary (OpenVMS)

append	A-2
copy	A-3
delete	A-13
directory	A-15
rename	A-22

B FTAM Command Summary (Digital UNIX)

ocat	B-2
ocp	B-4
ols	B-11
omv	B-14
orm	B-16

C VT Command Summary (OpenVMS)

connect	C-2
set host/vtp (osi)	C-3
set host/vtp (lat)	C-5
set host/vtp (internet)	C-6
sethost	C-7
telnet	C-8

D VT Command Summary (Digital UNIX)

connect	D-2
ologin (osi)	D-3
ologin (telnet)	D-5
sethost	D-7
set host /lat	D-8
telnet	D-9

E Mapping of FTAM to RMS File Attributes (OpenVMS)

F Virtual Terminal Profile Mapping

G G0 C0 Character Table

H FTAM Error Messages

H.1	Error Messages in Alphabetical Order	H-1
H.2	Error Messages in Numerical Order	H-46

I Virtual Terminal Error Messages

Index

Examples

4-1	Using the CCAT Command	4-3
-----	------------------------------	-----

Figures

1-1	Components of a VT Interaction	1-4
6-1	Movement of Service Primitives Between Service Users and Providers	6-4
6-2	Relationship of a Service User, Service Provider, and SAP	6-5
6-3	SAP Nomenclature	6-5
6-4	Syntax Transformation	6-7
6-5	The Relationship Between PCI, PDUs, User Data, and SDUs	6-8
7-1	Relationship Among Filestores During Data Transfer	7-3
7-2	Schematic Representation of a File Tree	7-4
7-3	Relationship of File Data and Structural Nodes	7-5
7-4	Division of a File into File-Access Data Units (FADUs)	7-6
7-5	Examples of File Structures	7-7
7-6	Nesting of FTAM Regimes	7-9
7-7	Relationship of File Services to Regimes	7-12
G-1	G0 C0 Character Sets	G-1

Tables

2-1	File Specification Components	2-1
2-2	File Specification Format Variables	2-2
2-3	File Specification Variables	2-5
2-4	Application Address Components	2-6
2-5	FTAM Commands	2-7
3-1	Gateway Format Variables	3-2
4-1	Commands Supported Through the FTAM-FTP Gateway	4-1
4-2	Internet Gateway Command Variables	4-2

4-3	Sample Internet Commands and Their Functions	4-5
4-4	OpenVMS FTAM Gateway Command Variables	4-10
4-5	Sample OpenVMS FTAM Commands	4-10
5-1	Command Mode Commands	5-3
5-2	Control Characters	5-6
5-3	VT Gateways	5-6
5-4	LAT connect Command Variables	5-7
6-1	Summary of Principal ISO Standards Implemented	6-2
7-1	Supported Document Types	7-8
7-2	FTAM File Services	7-10
7-3	ACSE Services	7-14
8-1	Presentation and Session Services	8-2
9-1	ISO Application-Entity Database Address Format Components	9-3
11-1	Logical Names, Alias Names and Default Addresses	11-3
11-2	Logical Names and Default Limits	11-4
12-1	Listener Command Variables	12-4
13-1	X.25 Destination Address Variables	13-5
13-2	X.25 OSI Transport Address Variables	13-7
13-3	IEEE 802 OSI Transport Address Variables	13-11
13-4	OSI Transport Address Variables	13-13
13-5	Possible Variations in Addressing Terminology	13-14
14-1	OSI Transport Templates	14-2
14-2	OSI Transport Address Variables	14-11
14-3	Possible Variations in Addressing Terminology	14-12
A-1	DCL copy and append Command Qualifiers	A-10
E-1	Relationship of RMS Files and FTAM Document Types	E-1
E-2	Relationship of Fully Supported FTAM and RMS File Attributes	E-2
E-3	Mapping Between FTAM and RMS File Attributes (Kernel Group)	E-2
E-4	Mapping Between FTAM and RMS File Attributes (Storage Group)	E-4
E-5	Mapping Between FTAM and RMS File Attributes (Security Group)	E-5
E-6	Mapping Between FTAM and RMS File Attributes (Private Group)	E-5
F-1	Transparent and Binary Mode Telnet Profile Mapping	F-1
F-2	A-Mode Default Profile Mapping	F-2
F-3	Telnet (Non-Binary Mode) Profile Mapping	F-3

Preface

Intended Audience

The audiences for this manual are:

Parts I and II Users who need the FTAM (File Transfer, Access, and Management) functions to work with files on remote OSI systems, or Virtual Terminal functions to access remote OSI systems.

Parts III and IV System or network managers who need to manage the FTAM and Virtual Terminal software, or Digital Services representatives who require a basic understanding of the upper-layer standards that the FTAM and Virtual Terminal software implement.

Related Documents

The *DECnet-Plus FTAM Programming* document provides additional information on the FTAM software.

Read the *Release Notes* before you read any other document in this set.

For additional information on the DECnet-Plus products and services, access the Digital OpenVMS World Wide Web site. Use the following URL:

<http://www.openvms.digital.com>

Reader's Comments

Digital welcomes your comments on this manual or any of the DECnet-Plus documents. Send us your comments through any of the following channels:

Internet	openvmsdoc@zko.mts.dec.com
Fax	603 881-0120, Attention: OSSG Documentation, ZKO3-4/U08
Mail	OSSG Documentation Group, ZKO3-4/U08 110 Spit Brook Rd. Nashua, NH 03062-2698

How To Order Additional Documentation

Use the following table to order additional documentation or information. If you need help deciding which documentation best meets your needs, call 800-DIGITAL (800-344-4825).

Telephone and Direct Mail Orders

Location	Call	Fax	Write
U.S.A.	DECdirect 800-DIGITAL 800-344-4825	Fax: 800-234-2298	Digital Equipment Corporation P.O. Box CS2008 Nashua, NH 03061
Puerto Rico	809-781-0505	Fax: 809-749-8300	Digital Equipment Caribbean, Inc. 3 Digital Plaza, 1st Street, Suite 200 P.O. Box 11038 Metro Office Park San Juan, Puerto Rico 00910-2138
Canada	800-267-6215	Fax: 613-592-1946	Digital Equipment of Canada, Ltd. Box 13000 100 Herzberg Road Kanata, Ontario, Canada K2K 2A6 Attn: DECdirect Sales
International	—	—	Local Digital subsidiary or approved distributor
Internal Orders	DTN: 264-4446 603-884-4446	Fax: 603-884-3960	U.S. Software Supply Business Digital Equipment Corporation 8 Cotton Road Nashua, NH 03063-1260

ZK-7654A-GE

Conventions

This manual uses the following conventions.

Convention	Description
special type	Indicates a literal example of system output or user input. In text, indicates command names, keywords, node names, file names, directories, utilities, and tools. On a DECnet-Plus for OpenVMS, Digital UNIX, or ULTRIX™ system, enter the word or phrase in the exact case shown.
lowercase/ UPPERCASE	You can abbreviate command keywords to the smallest number of characters that OpenVMS, Digital UNIX, NCL, DECdns, DECdts, and the other utilities accept, usually three characters.
<i>lowercase italics</i>	Because Digital UNIX software is case sensitive, you must type all literal input in the case shown.
bold	Indicate a variable, for which either you or the system must specify a value.
bold	Introduces new terms defined in either the glossary or the related text.
Return	Indicates that you press the Return key.

Convention	Description
command()	Cross-references to specific command documentation include the section number in the reference manual where the commands are documented. For example: See the ocp(1) command. This indicates that you can find the material on the ocp command in Section 1 of the reference pages.
[]	Square brackets indicate optional arguments. Do not type the brackets.
...	Horizontal ellipsis points indicate that the preceding item can be repeated one or more times.
. . .	In examples, vertical ellipsis points represent either user input or system input that has been omitted to emphasize specific information.
%	The default user prompt in multiuser mode.
#	The default superuser prompt.
key	Indicates a key on your keyboard. Ctrl/key represents a CONTROL key sequence, where you press the CONTROL key at the same time as the specified key.

Note

The following conventions are for multiplatform documentation.

◆	Indicates the end of platform-specific information.
OpenVMS	Indicates information specific to DECnet-Plus for OpenVMS.
UNIX	Indicates information specific to DECnet-Plus for Digital UNIX.

Other conventions are:

- All numbers are decimal unless otherwise noted.
- All Ethernet addresses are hexadecimal.

Part I

Introduction

OSI Applications Overview

OSI Applications are tools you use to perform communication tasks, such as exchanging files, and logging on to remote systems. You can transfer files with **FTAM**, and access remote systems with **Virtual Terminal**.

1.1 FTAM Overview

FTAM software is an Open Systems Interconnection (OSI) product that implements the OSI File Transfer, Access and Management standard ISO 8571 developed by the International Organization for Standardization (ISO). This standard enables you to transfer, access, and manage files residing on other vendors' computer systems that have also implemented this standard. An **FTAM system** is any system containing an FTAM implementation that conforms to the FTAM standard and the necessary underlying OSI software.

FTAM software operates on both unstructured files (containing either binary or text data) and sequential text files.

The FTAM facilities (appending, copying, deleting, listing, and renaming) operate on files stored on both local FTAM systems (**local files**) and remote FTAM systems (**remote files**). Using FTAM, you can copy, append, delete, rename, and inspect the file attributes of local files, remote files, or both.

To create and manage local files on an OpenVMS system, FTAM uses the OpenVMS Record Management Services (**RMS**), while on a Digital UNIX system, FTAM uses the **UNIX File System**. Other types of FTAM systems use different methods of creating and managing files. (Refer to the documentation for each remote FTAM system for further information.)

OpenVMS

On OpenVMS, the FTAM facilities operate through a Digital Command Language (**DCL**) interface. To activate the FTAM facilities, the FTAM DCL interface requires a single command qualifier (`/application_protocol=ftam`), which operates with the FTAM facility commands. For convenience, this qualifier is abbreviated to `/app=ftam` in this document. The commands you can use are `append`, `copy`, `delete`, `directory` and `rename`. ♦

UNIX

On Digital UNIX, the commands you can use are `ols` (lists files), `ocp` (copies files), `orm` (deletes files), `omv` (renames files), and `ocat` (appends files). See Section 2.2 for more information on all the FTAM commands. ♦

Each FTAM system contains an FTAM application that implements the FTAM standard on the system. A distinct FTAM application name identifies a specific FTAM application. To access a remote file, you must identify both the remote file and the FTAM application on the remote FTAM system. An FTAM command causes FTAM to communicate with the FTAM applications you specify.

OSI Applications Overview

1.1 FTAM Overview

When you issue an FTAM command involving at least one remote file, the following series of events take place:

1. FTAM uses your process to perform the operation that you specify in your command.
2. From your process, FTAM initiates an **association** for each FTAM application that you specify in the command. (An association is a cooperative link between two OSI application processes.) The software that initiates an association for a user process is called the **initiator**.
3. The software that receives an initiator's request for an association is called a **responder**. If a responder accepts a request for an association, the responder's system may start up an application process to support the responder's side of the association.
4. The responder's process handles the requested file operation.
5. When the file operation completes, the FTAM initiator ends the association and returns the control of your process to your local system.

1.2 FTAM Gateways

FTAM also provides for the use of the following gateways:

- DAP-FTAM Gateway on OpenVMS systems
- FTAM-FTP Gateway on Digital UNIX systems

For more information on these gateways see Chapter 3 and Chapter 4.

1.3 FTAM User Facilities

The FTAM user facilities provide the following capabilities:

- **FTAM appending facility**
This facility allows you to append one or more input files to the end of a single output file, within local or between local and remote FTAM applications.
- **FTAM copying facility**
This facility allows you to copy one or more input files to a single output file, within local or between local and remote FTAM applications.
- **FTAM deletion facility**
This facility allows you to delete remote files.
- **FTAM directory facility**
This facility allows you to display file attributes for one or more remote files or directories.
- **FTAM renaming facility**
This facility allows you to rename remote files.

1.4 Virtual Terminal Overview

To take advantage of today's networking technology, terminals need access to applications on a variety of local and remote systems. In the single-vendor environment, this is rarely a problem. The difficulty arises in the multivendor environment when diverse systems need to communicate.

The OSI solution to this problem is the **Virtual Terminal (VT)**, an abstract representation of a real terminal, complete with terminal operations (reads text from the keyboard, writes text to the screen, moves the cursor, and so on). Using this model, any terminal connected to a system running VT can access any other system running VT, regardless of type. This type of access can also occur by using **gateways**, as discussed in Chapter 5.

The Virtual Terminal standard is made up of the service definition (ISO 9040) and the protocol (ISO 9041). The VT software adheres to these standards, and enables applications and systems supporting different types of terminals to interact with each other.

1.4.1 Virtual Terminal Interactions

VT interactions involve two systems: the system that initiates the interaction and the system that responds. These two systems are often referred to as the **terminal implementation** and the **host implementation**.

With some VT software, terminal and host implementations can both initiate an interaction, or respond to one. With the DECnet-Plus VT software, the terminal implementation can only initiate an interaction, and the host implementation can only respond. Therefore, the documentation refers to these systems as the initiator and the responder.

When an initiator requests a connection to a responder and the responder accepts the request, this is referred to as negotiating an association. Both systems must then agree on the context in which the virtual terminal will exist. This context, the **virtual terminal environment (VTE)**, is a set of predefined values both sides use to translate information (by means of local mapping) that the virtual terminal transfers to both systems. These predefined values describe the capabilities of the Virtual Terminal, such as cursor addressing, forms processing, and color capabilities.

OSI Applications Overview

1.4 Virtual Terminal Overview

In a virtual terminal association, the initiator and responder communicate by sharing information about changes to a data store called the **conceptual communications area**. This data store contains different types of data structures called objects, including:

- **Display objects** — to model a terminal's display and keyboard operations.
- **Control objects** — to model a terminal's control sequences (such as one that rings the bell on a terminal).
- **Device objects** — to model characteristics of real devices and help map display objects.

The systems only communicate changes to the conceptual communications area; both sides of the virtual terminal association assume that the rest of the data store's contents remain unchanged. A virtual terminal protocol machine on each side of the virtual terminal association maintains a separate copy of the conceptual communications area.

Figure 1–1 shows the components of a VT interaction.

Figure 1–1 Components of a VT Interaction

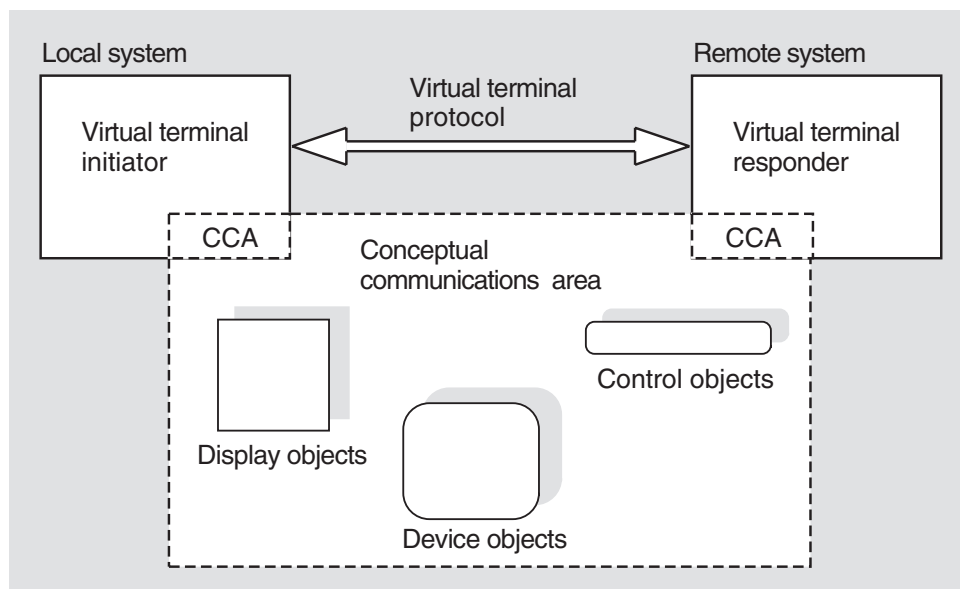

LKG-5490-93R

1.4.2 Virtual Terminal Operation in a Network

The following process occurs during a virtual terminal association between two systems:

1. The initiator requests an association with a remote responder. Both systems must agree on the VTE for the virtual terminal.
2. After the association takes place, the initiator maps the keyboard operations that a user can enter to specific virtual terminal representations as defined by the VTE.

For example, pressing Return on a Digital UNIX system results in a line feed character. VT maps the line feed character to a protocol message that says "go to a new line."

3. The initiator then transfers this information across the network to the responder.
4. The responder then maps the virtual terminal information to local commands that its software understands.

For example, an OpenVMS system receiving the "go to a new line" message translates it to a carriage return sequence, the sequence generated by pressing Return on an OpenVMS system.

5. The responder performs the operation requested by the initiator. If the request generates a response, this information is mapped to the appropriate VT operation. The responder then sends this information across the network to the initiator.
The OpenVMS system echoes the carriage return-linefeed sequence. VT maps this new character sequence to a second "go to a new line" message.
6. The initiator receives the virtual terminal information from the responder and maps this information to commands that the terminal understands. The Digital UNIX system maps the "go to a new line" message to a carriage return-linefeed sequence.

The user sees no difference between the behavior of VT and that of a terminal directly connected to a responder.

1.4.3 Virtual Terminal Profiles

A terminal's needs vary with the application. Virtual terminals meet these needs in virtual terminal environments (VTEs) called **profiles**.

Each profile has a unique character **map**, or translation of characters and keys. See Appendix F for a description of the individual character maps.

Each profile also has a unique name that the initiator sends to the responder to establish a context for data transfer. If the responder supports the specified profile, an association is established; otherwise the responder returns an error message.

The VT software supports the ISO profile:

- **A-mode Default**

The Virtual Terminal standard supports two modes of communication:

- A-mode (asynchronous mode)
- S-mode (synchronous mode)

All OSI-based Virtual Terminal products that support A-mode communication must support the A-mode Default profile. It provides a scrolled display of lines up to 80 characters in length, with no paging.

The VT software also supports the following National Institute of Standards and Technology (NIST) profiles:

- **Telnet, or Telnet-1988**

This profile supports limited TELNET¹ operations, a Telnet interface, and characteristics such as:

- Ability to send TELNET commands across the network.

¹ When the word TELNET appears in uppercase, it refers to the TCP/IP TELNET protocol, and not the VT profile of the same name.

OSI Applications Overview

1.4 Virtual Terminal Overview

- Ability to control local terminal characteristics such as echoing (displaying typed characters).
- Ability to transmit raw binary data, which is a necessary characteristic for sending control characters embedded in a block of text.

- **Generalized Telnet**

This profile supports features contained within the Telnet-1988 profile, plus:

- Ability to negotiate up to 256 separate options.
- Ability to perform TELNET suboption negotiations.

The features of the Generalized Telnet protocol resemble those of Internet TELNET, more so than do the features of Telnet-1988.

- **Transparent**

This profile allows the exchange of uninterpreted sequences of characters. It does not provide a model of what is displayed on the initiator's virtual terminal. Data is simply transmitted in the form of octet (8-bit) strings and is not interpreted by Virtual Terminal software. Users who want to control terminals directly through the use of embedded control characters and escape sequences specify this profile. For example, if you are using a full-screen editor on a responder, you would specify this profile.

Note

You need to know which profile to select when using your VT software to access applications on remote OSI systems. See your system administrator for this information.

1.4.4 Virtual Terminal Repertoires

A **repertoire** contains a set of representations of symbols such as numeric, graphic, and control characters. When you specify a profile during a virtual terminal association, it uses a specific repertoire. An example of a repertoire is the American Standard Code for Information Interchange (ASCII) character set. A repertoire could also be a subset of the ASCII character set.

Your VT software supports the following repertoires:

- The ASCII graphics (G0) character set, used with the A-mode default profile.¹
- The full U.S. ASCII (G0 and C0) character set, used with the Telnet-1988 and Generalized Telnet profiles.¹
- The Transparent repertoire, used with the profile of the same name. When the Transparent repertoire is active, the software does not interpret the data transmitted by the initiator or responder node.

¹ See Appendix G for a G0 C0 character set table.

Part II

Use

This chapter introduces the FTAM file specifications and commands for the following operations:

- Listing file attributes
- Copying files
- Deleting files
- Renaming files
- Concatenating and displaying files

2.1 FTAM File Specifications

The FTAM user facilities require you to supply one or more file specifications for each operation. An FTAM file specification is a unique string of characters that an FTAM application uses to create or select a file stored on an FTAM system in the same network.

With FTAM software, as with the UNIX File System or Record Management Service (RMS), you need to include only essential information in your FTAM file specification. For example, directory information is necessary for a local file only when the file is outside your working directory. For a remote file, the sort of device or directory information required depends on the remote system's implementation of FTAM and its internal file management software.

Table 2-1 shows the file specification components for OpenVMS and Digital UNIX:

Table 2-1 File Specification Components

OpenVMS	Digital UNIX
application address	application address
security information	pathname
account name	
file designation	

Using FTAM

2.1 FTAM File Specifications

2.1.1 File Specification Format for OpenVMS

OpenVMS

FTAM provides a series of file-specification formats. Select one that meets the needs of a particular situation. The formats are:

```

rms-file-designation
apl-address::rms-file-designation
apl-address:"non-rms-file-designation"
apl-address"initiator-id password account":rms-file-designation
apl-address"initiator-id password account"::"non-rms-file-designation"

```

Table 2–2 describes the variables in these format statements.

Table 2–2 File Specification Format Variables

Variable	Explanation
<i>apl-address</i>	An FTAM application address that corresponds to the FTAM responder of an FTAM system. An FTAM responder handles incoming requests for files from FTAM users.
<i>initiator-id</i>	A character string that identifies an initiator ID on the specified FTAM node. If you specify this string in a local file specification, FTAM uses the initiator ID as an OpenVMS user name.
<i>password</i>	A string that identifies an FTAM filestore password. If you specify this string in a local file specification, FTAM uses the filestore password as the login password for the OpenVMS user name identified by the initiator ID.
<i>account</i>	A string that identifies an FTAM account name. If you specify this string in a local file specification, FTAM uses it as an OpenVMS account name. To specify an account, you must also specify both a user name and a password.
<i>rms-file-designation</i>	A standard Record Management Services (RMS) file specification, which contains one or more components in the following format: <i>device-name:[directory-name]file-name.file-extension;version-number</i> Except for the file name or file name delimiter (.), all the components are optional. Note that the DIRECTORY command supports the use of standard DCL wildcards. See Section 2.1.1.5 for more information about DCL wildcards.
<i>non-rms-file-designation</i>	A file designation whose format RMS cannot interpret. A non-RMS file designation contains whatever information the remote FTAM system requires for locating a remote file. Enclosing non-RMS file designations between double quotation marks (" <i>non-rms-file-designation</i> ") causes RMS to accept the enclosed designation without trying to parse it. Failing to enclose non-RMS file designations within double quotation marks causes an error. Note that FTAM cannot handle a remote file designation that contains one or more double quotation marks among its characters.

The following sections describe the file specification components. ♦

2.1.1.1 FTAM Application Address

OpenVMS

The FTAM **application address** defines the unique location of an FTAM responder on a specific FTAM system. For a remote file, you must include an application address in the file specification. For a local file, you need the local FTAM application address only if you want to include security information.

Alternatively, when specifying files on your local system, you can substitute your system's DECnet node name for a local application address using the standard DECnet-Plus format. For more information, refer to your DECnet-Plus management documentation.

An FTAM system manager creates an FTAM alias to define an application address for each FTAM responder that you can access using FTAM commands. All FTAM aliases must be defined in the `sys$system:isoapplications.dat` file. For more information on the alias database and how to check an alias, see Chapter 9.

For a list of available FTAM systems and aliases that define their application addresses, see your system manager. ♦

2.1.1.2 Security Information

OpenVMS

Security information includes an initiator identity (initiator ID) and, optionally, a filestore password. The **initiator identity** parameter is an FTAM parameter whose usual purpose is to identify the calling user. The **filestore password** is an FTAM parameter whose usual purpose is to convey a password for authenticating the initiator to the responder. However, the interpretation of FTAM parameters varies among the responders of different vendors. Therefore, the significance of security information passed in FTAM file specifications depends on how a given responder interprets the initiator ID and filestore password. For information on how a remote responder interprets this parameter, refer to the appropriate documentation for that responder.

On an FTAM system, security information permits you to access directories in OpenVMS accounts other than the one in which you are working. The FTAM responder uses an incoming initiator ID as an OpenVMS user name and an incoming filestore password as a login password. The FTAM responder gives the user name and password to OpenVMS, which attempts to create a user process with them. If the combined user name and login password are valid for an OpenVMS account, FTAM logs into that account and gains owner's privileges for the duration of that FTAM association.

The FTAM initiator passes values for the initiator ID and filestore password only if you specify them on your command line. If a remote responder requires a specific initiator ID and filestore password, you must specify them. If you specify a value that is unacceptable to the responder, your connection attempt fails. ♦

2.1.1.3 Account Name

OpenVMS

An **account name** is an FTAM parameter whose usual purpose is to identify an FTAM account. However, the local interpretation of FTAM accounts varies among the responders of different vendors. For information on how a remote responder interprets this parameter, refer to the appropriate documentation for that responder. The OpenVMS FTAM responder equates the FTAM account name to an OpenVMS account name (which is a meaningless value to OpenVMS).

To specify an account, you must also specify an initiator ID and a filestore password. ♦

2.1.1.4 File Designation

OpenVMS

A **file designation** is unique system-specific information that identifies a file within its storage system. A file designation typically includes the device, directory, and file information a given FTAM system requires to identify the targeted file. Successful operation of FTAM facilities requires that you use file designations that are native to the remote FTAM system. For information on the types of information and the format you need to identify a remote file, refer to the user documentation for the remote FTAM machine's storage system.

Using FTAM

2.1 FTAM File Specifications

For a local file, a file designation can include a device name, a directory name, a file name, and either a file extension, version number, or both in a specific format. For example:

device-name:[directory-name]file-name.file-extension;version-number

Note that a local file designation minimally requires a file name or a file-name delimiter (.).

FTAM supports RMS file designations and passes on other forms of file designations, as long as a designation that deviates from the standard RMS format (that is, a **non-RMS file designation**) is enclosed within double quotation marks ("*non-rms-file-designation*"). Furthermore, such non-RMS file designations may not contain embedded quotation marks ("). If a remote file-designation format is compatible with the RMS format, the double quotation marks are unnecessary.

Note

It is important to understand that the responding FTAM system can alter a remote file designation specified in an FTAM DCL command. To see whether a remote FTAM system has altered a given file designation, use the `directory/app=ftam` command. As a precaution against losing a file because of a mismatch between input and real file designations, include the `/confirm` qualifier in the `copy/app=ftam` and `delete/app=ftam` commands. The confirmation message contains the file specification that the remote system is actually using.

File designations equate to FTAM file names. An FTAM file name is a text string that identifies a file to an FTAM system. The FTAM system requesting a file (the initiator) supplies an FTAM file name to the FTAM system accepting the file request (the responder).

FTAM treats FTAM file specifications as follows:

- When you request a remote file, the FTAM initiator separates the FTAM application address from the file designation. The application address translates into the address of an FTAM application on a particular remote FTAM system. The file designation includes everything to the right of the double colons (::).
- When processing an incoming file request, the FTAM responder treats whatever string it receives for the FTAM file name as an RMS file designation. ♦

2.1.1.5 Using Wildcards with the Directory Facility

OpenVMS

Wildcards provide a method for generalizing a file designation to encompass a set of files. Standard DCL wildcard techniques work for both local (RMS) files and remote files for those remote FTAM systems that support the NBS-9 document type. If using wildcard techniques with remote FTAM systems does not work, you should use the complete file designation.

The supported wildcard characters include an asterisk (*) to represent a text string, a percent sign (%) to represent a single character, or empty brackets ([]) to represent all files in the local default RMS directory. ♦

2.1.2 File Specification Format for Digital UNIX

UNIX

On Digital UNIX, the FTAM file-specification format has two components: an application address and a path name. Its syntax is:

application-address::pathname

The FTAM software provides a series of file-specification formats. Select one that meets the needs of a particular situation. The valid formats are:

unix-file-designation

application-address::unix-file-designation

application-address::'non-unix-file-designation'

Table 2–3 describes the variables in these format statements.

Table 2–3 File Specification Variables

Variable	Explanation
<i>unix-file-designation</i>	A standard UNIX file specification, containing one or more components in the following format: <i>/directory-name/file-name</i> Except for the file name, all the components are optional.
<i>application-address</i>	An FTAM application address corresponding to the location of the FTAM responder on an FTAM system. An FTAM responder handles incoming requests for files from FTAM users. Section 2.1.2.1 describes the format of the application address.
<i>non-unix-file-designation</i>	A file designation whose format UNIX cannot or should not interpret. A non-UNIX file designation contains whatever information the remote FTAM system requires for locating a remote file. Enclosing non-UNIX file designations between single quotation marks (<i>'non-unix-file-designation'</i>) tells the shell to accept the enclosed designation without trying to parse it. Failing to enclose non-UNIX file designations within single quotation marks causes an error. Note that the FTAM software cannot handle a remote file designation containing one or more single quotation marks among its characters.

The following sections describe the file specification components. ♦

2.1.2.1 Application Address

UNIX

On Digital UNIX, the **application address** identifies an alias in */etc/isoapplications* that defines the location of the responder on a remote FTAM system. Chapter 9 describes the various types of aliases that can be used. For a remote file, you must include an application address in the file specification. Otherwise, the application assumes you are referring to a local file.

An FTAM system manager creates an FTAM alias for each application address, defining a unique FTAM responder that you can access. For a list of available FTAM systems and their aliases, see your system manager. The */etc/isoapplications* file lists all available aliases. Section 9.1 describes how to add aliases to the */etc/isoapplications* file.

Included as part of the application address are user account and security information. The format of an application address is:

alias/user/password/account

Using FTAM

2.1 FTAM File Specifications

Table 2–4 describes each component in the application address.

Table 2–4 Application Address Components

Component	Explanation
<i>alias</i>	Defined in the <code>/etc/isoapplications</code> file. The alias defines the address of the remote FTAM application. See Chapter 9 for more information on this format.
<i>user</i>	The remote login ID. This value is optional for some responders, but is required for the FTAM responder.
<i>password</i>	The password for the remote login ID. If you specify <i>user</i> without specifying <i>password</i> , you are prompted for a password. If the password contains shell metacharacters, such as a dollar sign (\$), it must be entered from the password prompt. If the password is a hexadecimal number, it must be preceded by the characters <code>%x</code> or <code>%X</code> . This value is optional for some responders, but is required for the FTAM responder. If no password is required, press Return.
<i>account</i>	The FTAM account name. This value is optional.

The interpretation of FTAM parameters varies among the responders of different vendors. Therefore, the significance of security information passed in FTAM file specifications depends on how a given responder interprets the remote login ID and its password. For information on how a remote responder interprets these parameters, refer to the appropriate documentation for that responder.

On an FTAM system, security information permits you to access files on remote systems. The FTAM responder uses an incoming remote login ID as a Digital UNIX user ID and an incoming remote login password as a login password. The FTAM responder gives the user ID and password to the Digital UNIX operating system, which attempts to create a user process with them. If the combined user ID and login password are valid for a Digital UNIX account, FTAM logs in to that account and gains owner's privileges for the duration of that FTAM association.

The FTAM initiator passes values for the remote login ID and its password only if you specify them on your command line. If a remote responder requires a specific login ID and password, you must specify them. If you specify a value that is unacceptable to the responder, your connection attempt fails. ♦

2.1.2.2 Path Name

UNIX

On Digital UNIX, a **path name** can be either a file name by itself or a file name preceded by a directory name. It is unique system-specific information that identifies a file to its storage system. A path name should include whatever directory or file information a given FTAM system requires to identify the targeted file. Successful operation of FTAM facilities requires you to use an appropriate path name for each remote FTAM system. For information on the types of information and the format you need to identify a remote file, refer to the user documentation of the file's storage system.

The FTAM software supports UNIX File System file designations. The FTAM software passes on other forms of file designations as well, as long as a designation that deviates from the standard UNIX format (that is, a **non-UNIX file designation**) is enclosed within single quotation marks (*'non-UNIX-file-designation'*). The FTAM software rejects non-UNIX file designations that contain embedded quotation marks ('). If a remote file-designation format is compatible with the UNIX format, the single quotation marks are unnecessary.

Note

It is important to understand that the responding remote FTAM system can alter a remote file designation specified in an FTAM command. To see whether a remote FTAM system has altered a given file designation, use the directory facility to list the file.

File designations equate to FTAM file names. An FTAM file name is a text string that identifies a file to an FTAM system. The FTAM system requesting a file (the initiator) supplies an FTAM file name to the FTAM system accepting the file request (the responder).

The FTAM software treats FTAM file specifications as follows:

- When you request a remote file, the FTAM initiator separates the FTAM application address from the file designation. The application address translates into the presentation address (p-address), and optionally the remote login information of an FTAM application on a particular FTAM system. See Table 2–3 for additional details.

See also Section 6.4.2 for additional information on the p-address.

The file designation includes everything to the right of the double colons (::) except for single quotation marks that enclose an FTAM file designation. It serves unchanged as an FTAM file name.

- When processing an incoming file request, the FTAM responder treats whatever string it receives for the FTAM file name as an UNIX file designation.

See Section 12.4 for managing virtual filestore information. ♦

2.2 FTAM Commands

Table 2–5 shows the FTAM commands used with OpenVMS and Digital UNIX.

Table 2–5 FTAM Commands

Task	OpenVMS	Digital UNIX
Listing	directory	ols
Copying	copy	ocp
Deleting	delete	orm
Renaming	rename	omv
Concatenating	append	ocat

Note

If a remote file is specified as part of the input/output file specifications, the actions taken by the command and its qualifiers depend on the remote FTAM responder functionalities and support.

The following sections describe these commands.

Using FTAM

2.2 FTAM Commands

2.2.1 FTAM Responder Log File

OpenVMS

On OpenVMS, when the FTAM responder is activated, a log file is created in the home directory of the user specified by the FTAM operation. The name of the log file is OSIF\$RESPONDER.LOG.

The OSIF\$RESPONDER.LOG log file contains any errors that may be generated by the FTAM responder. It also contains a list of all files that are accessed by an F-OPEN-REQUEST, including the processing mode of the access.

You can use the OSIF\$RESPONDER.LOG file to check the status of an FTAM operation. For example, issue the following FTAM command on an OpenVMS system to another OpenVMS system, amiguita:

```
$ copy/app=ftam test.dat amiguita"fencer thrust":test.dat
```

On system amiguita, in the home directory of user fencer, there is an OSIF\$RESPONDER.LOG file corresponding to the operation that you can use to check on the status of the copy command. ♦

2.2.2 Copying Files

The copying facility allows you to copy a single input file to a single output file, within or between FTAM systems.

The FTAM copying facility operates on any combination of local-to-remote files, remote-to-local files, and remote-to-remote files. However, local-to-local file copies are only supported by the OpenVMS copy command.

OpenVMS

On OpenVMS, the copy command has the following format:

```
copy/app=ftam [/qualifier(s)] input-file-spec [,...] output-file-spec
```

The following example copies the single local file test.dat to \dir\file on amiguita:

```
$ copy/app=ftam test.dat amiguita::"dir\file" 
```

Note that without the double quotation marks (" ") enclosing \dir\file, RMS would generate the following error:

```
%COPY-F-OPENIN, error opening AMIGUITA::\DIR\FILE as input
-RMS-F-SYN, file specification syntax error
```

For a complete description of the copy command and its qualifiers, see Appendix A. ♦

UNIX

On Digital UNIX, the ocp command has the following format:

```
ocp [options...] [application-address:]file1 [application-address:]file2
```

The following example copies the local Digital UNIX file test.dat to an OpenVMS file called test.dat;25 on lesamies.

```
% ocp test.dat lesamies::'test.dat;25' 
```

Note that because the output-file designation is enclosed in single quotation marks ('), the characters entered in the command are retained in the output-file designation sent to the remote FTAM system.

For a complete description of the ocp command and its options, see Appendix B. ♦

2.2.2.1 Copying FTAM-2 Document Types

OpenVMS

FTAM maps an RMS file to a single FTAM document type, based on the record format and record attributes of the RMS file. In previous versions of FTAM, if the responding FTAM implementation did not support the abstract syntax required for our FTAM document type, the file could not be transferred. This situation was seen most commonly when the `copy` command attempted to transfer an RMS file with a variable record format (which FTAM maps to the FTAM-2 (sequential text file) document type) to an implementation that cannot support the FTAM-2 document type.

If this situation occurs with FTAM, the FTAM initiator automatically attempts to transfer the local FTAM-2 file to the responder as an FTAM-1 (unstructured text file) document type and FTAM sends you an informational message that the file was transferred as an FTAM-1 file.

For more information on FTAM document types, see Section 7.2.2.6. For specific information on the relationship of RMS files to FTAM document types, see Appendix E. ♦

2.2.2.2 Copying Files With Records Larger Than 7168 Bytes

Due to the size restrictions specified in NIST Phase 2 and Phase 3 agreements and ISO/IEC ISP 10607-3, you cannot send files using FTAM with fixed-length records longer than 7168 bytes, because fixed-length records cannot be segmented.

Before you can send such a file using FTAM—for example, an OpenVMS save set that has a block size greater than 7168 bytes—you must first unwind the file and rewind it with a block size of less than 7168 bytes.

2.2.2.3 Copying FTAM Files

UNIX

On Digital UNIX, other options of the `ocp` command let you specify certain properties specific to FTAM files. For example, to copy an FTAM file with the properties of a particular document type, you can use a command that resembles the following:

```
% ocp -D FTAM-1 -C General -M 512 petrie::ftam.tst ftam.txt 
```

This command specifies that the source file is to be opened as an FTAM-1 file with a universal class number of `GeneralString` and a maximum string length of 512. The characteristics you specify must match those of the source file. This command also specifies that the destination file is created with the same attributes as the source file.

Note

The FTAM responder on Digital UNIX does not properly handle any attempt to transfer a non-fixed record length file as a fixed length. ♦

2.2.2.4 Copying Files with Confirmation

OpenVMS

If you want the system to query you about copying files when using the `copy` command, use the `/confirm` option with your command, as in the following example:

```
$ copy/confirm/app=ftam test.dat amiguita::"dir\file"   
COPY TEST.DAT to AMIQUITA::"DIR\FILE"?
```

If you type `y` and press `Return`, the output file is copied. Otherwise, the file is not copied. ♦

Using FTAM

2.2 FTAM Commands

UNIX

On Digital UNIX, if you want the system to query you about overwriting existing files when using the `ocp` command, use the `-i` option with your command, as in the following example:

```
% ocp -i petrie::'user2:[ami]ftam.tst' ftam.txt Return
ocp: overwrite ftam.txt?
```

If you type `y` and press Return, the output file is overwritten. Otherwise, the file is not copied. ♦

2.2.2.5 Copying Files With No Output File-Designation

OpenVMS

On OpenVMS, you may copy a local file to a remote FTAM system without specifying the file-designation on the output-file-spec. This use of the `copy` command has one of the following formats:

```
copy/app=ftam [/qualifier(s)] input-file-spec[,...] appl-address::
copy/app=ftam [/qualifier(s)] input-file-spec[,...] appl-address"initiator-id password account"::
```

For example:

```
$ copy/app=ftam ftam.txt amiguita::
```

The name of the file that is created on the remote FTAM system is the same as the name of the local file to be copied (FTAM.TXT in this example). Note that if the remote FTAM system is case-sensitive (for example, a Digital UNIX system), the remote file name is in uppercase even if you typed it in lowercase because OpenVMS file names are always uppercase. ♦

2.2.3 Appending Files

The FTAM append facility can append multiple input files together to form a new output file through **concatenation**. Concatenation takes each input file in its input order and appends its contents to the end of the output file. The output file is a new file.

The append facility also allows you to append an input file to a single output file, and concatenate two or more input files to a single output file. (When using FTAM on a Digital UNIX system, the output file must be local.)

OpenVMS

On an OpenVMS system, if the output-file designation identifies an existing local file, the new output file receives the next highest version by default. ♦

UNIX

On a Digital UNIX system, the new output file overwrites the existing file. When concatenating to a remote output file, the effect of specifying an existing remote file name depends on the file management procedures of the remote operating system. ♦

Concatenation primarily affects three RMS file attributes: file organization, record format, and record attributes. Use the `directory` command to display these attributes for any local or remote file (see Section 2.2.5). Taken together, these RMS file attributes equate to an FTAM file attribute called **contents type**.

During concatenation, the appending facility monitors the contents type of the first input file to determine the contents type of the output file. If the input-file list begins with a wildcard file designation, the output contents type is determined by the file whose file specification is first alphabetically. Note that using wildcards for the local input file succeeds only if the local file designation is compatible with the file-designation format of the remote system. (For an explanation of wildcards, see Section 2.1.1.5.)

OpenVMS

On OpenVMS, the `append` command has the following format:

```
append/app=ftam [/qualifier(s)] input-file-spec [,...] output-file-spec
```

The following example appends the input file, `^vol>main>file.ext`, from `freunde`, and the local input file, `test.dat` (assuming the files have a single contents type), into the local output file, `targetest.dat`:

```
$ append/app=ftam/new_ver freunde:"^vol>main>file.ext",- Return  
_ $ test.dat targetest.dat Return
```

Note that without the double quotation marks (" ") enclosing the file designation `^vol>main>file.ext`, DCL interprets the symbol `^` as a parameter delimiter and generates the following error:

```
%DCL-W-PARMDEL, invalid parameter delimiter - check ...  
  \^VOL\
```

For a complete description of the `append` command and its qualifiers, see Appendix A. ♦

UNIX

On Digital UNIX, the `ocat` command has the following format:

```
ocat [options...] application-address::file [application-  
address::file...]
```

The following example displays and appends the contents of the remote file, `/usr/user1/file1`, on `freunden`, to the local file `file2` on the local standard output:

```
% ocat freunden/fencer/thrust::/usr/user1/file1 > file2 Return
```

Note the use of user name `fencer`, and password `thrust` in the application address of the remote Digital UNIX responder.

The contents of remote files can only be appended by redirecting the output to a local file. You must specify whatever type of information the remote FTAM system requires for specifying files. (Refer to the user documentation for the remote FTAM system.)

For a complete description of the `ocat` command and its options, see Appendix B. ♦

2.2.3.1 Concatenating with the `copy` Command

OpenVMS

The copying facility can also concatenate input files that have an identical contents type to an output file with the same contents type. This is similar to the `append` facility described in Section 2.2.3. For input files with non-identical contents types, the concatenated output file has the contents type of the first input file. With non-identical contents types, a warning message occurs that informs you of the incompatible attributes.

To concatenate files with the `copy` command, you must use the `/concatenate` qualifier, as in the following example:

```
$ copy/concatenate/app=ftam *.dat freunde::newfile.dat Return ♦
```

2.2.3.2 Appending Files with the `ocp` Command

UNIX

On Digital UNIX, the `ocp` command has a `-A` option that allows you to append files within or between FTAM systems. For example, you might use the following command to append the remote file `ftam.tst` to the local file `ftam.txt`:

```
%ocp -A petrie::'user2:[ami]ftam.tst' ftam.txt Return ♦
```

Using FTAM

2.2 FTAM Commands

2.2.4 Deleting Files

The delete facility allows you to delete any combination of local or remote files. For local OpenVMS files, you must specify a version number. For remote files, you must specify whatever type of information the remote FTAM system requires for deleting files. (Refer to the user documentation for the remote FTAM system.)

OpenVMS

On OpenVMS, the delete command has the following format:

```
delete/app=ftam [/qualifier(s)] file-spec[,...]
```

For example, the following command deletes the file /main/sub/file/ext:

```
$ delete/app=ftam amiguita:="/main/sub/file/ext" 
```

For a complete description of the delete command and its qualifiers, see Appendix A. ♦

UNIX

On Digital UNIX, the orm command has the following format:

```
orm [options...] application-address::file [application-address::file...]
```

For example, if you want to be asked whether or not to delete a file, use the `-i` option with your command, as in the following example:

```
% orm -i petrie::ftam.txt   
orm: remove ftam.txt?
```

If you type `y` followed by any other character, the file is deleted. Otherwise, the file is not removed.

For a complete description of the orm command and its associated options, see Appendix B. ♦

2.2.5 Listing Files

Each file has a set of file attributes. **File attributes** are characteristics whose values identify and describe a file and record its history. The FTAM directory facility allows you to display FTAM file attributes for remote files. You can produce a minimal display containing only the FTAM application address and the file designation, or a full display, containing information on all the supported FTAM file attributes.

OpenVMS

On OpenVMS, the directory command has the following format:

```
directory/app=ftam [/qualifier(s)] file-spec [,...]
```

For example, the following command produces the standard RMS full directory display, for the remote directory `\dir\file\ext`, and for the local file `test.dat`.

```
$ directory/app=ftam amiguita:="\dir\file\ext",test.dat 
```

In the output for the preceding example, the most recent version of the file is `test.dat;7`. The output resembles the following:

```
Directory AMIGUITA::  
\DIR\FILE\EXT  
Total of 1 file  
Directory USER$75:[USERNAME]  
TEST.DAT;7  
Total of 1 file
```

Grand total of 2 directories, 2 files.

Note

The directory facility in previous versions of FTAM allowed you to display the file attributes for one file only. Now that FTAM supports the NBS-9 document type, you can use the `directory` command to display the file attributes of multiple files in a specified directory, assuming the peer FTAM system also supports the NBS-9 document type.

To use this capability, use the `directory/app=ftam` command and specify a directory as the `file-spec` parameter. The output that appears is a listing of the file attributes for the files in that directory. You can use the DCL wildcard characters in this command.

For a complete description of the `directory` command and its qualifiers, see Appendix A. ♦

UNIX

On Digital UNIX, the `ols` command has the following format:

```
ols [options...] application-address::file [application-address::file...]
```

For example, the following command produces a display for the root directory of a UNIX system:

```
% ols freuden::/ 
```

The output resembles the following:

```
NBS-9 dr-----          512      Jan 25 14:01 /.
NBS-9 dr-----          512      Jan 25 14:01 ../
NBS-9 dr-----         2048      Jul 30 1996 /bin
NBS-9 dr-----          4608     Jan 28 13:21 /etc
NBS-9 drw-----          512      Jan 30 09:57 /tmp
NBS-9 dr-----          512      Jan 25 15:31 /usr
NBS-9 dr-----          2560     Jan 24 13:01 /dev
FTAM-3 -r-----        3418740   Jan  4 16:11 /vmutex
FTAM-3 -r-----          512      May 23 1996 /var
FTAM-1 -r-----          172      Apr  5 1996 /.profile
FTAM-3 -r-----          512      May 23 1996 /sys
NBS-9 dr-----          512      May 23 1996 /opr
FTAM-3 -r-----          2560     Jan 28 13:27 /lib
FTAM-1 -r-----          89       Apr  1 1996 /.login
FTAM-1 -r-----          241      Apr  1 1996 /.cshrc
```

For a complete description of the `ols` command and its associated options, see Appendix B. ♦

2.2.6 Renaming Files

The FTAM renaming facility allows you to rename any combination of files. You can change the directory specification, file name, file type, or file version of an existing file. For remote files, you must specify whatever type of information the remote FTAM system requires for specifying files. (Refer to the user documentation for the remote FTAM system.)

Using FTAM

2.2 FTAM Commands

OpenVMS

On OpenVMS, the rename command has the following format:

```
rename/app=ftam [/qualifier] input-file-spec[,...] output-file-spec
```

In the following example, the remote file /main/file located on the system called ami is renamed to the remote file /new/file on the same system:

```
$ rename/app=ftam ami::"/main/file" "/new/file" 
```

Note that it is not necessary to include the name of the remote system (ami) in the output file specification because it must be the same system as that of the input file specification.

For a complete description of the rename command and its qualifiers, see Appendix A. ♦

UNIX

On Digital UNIX, the omv command has the following format:

```
omv [options...] application-address::file1 file2
```

In the following example, the remote system is a Digital UNIX responder, so you must enter the user name and password as part of the application address. The command renames the remote file /user1/file2, on freunden (username fencer, password thrust) to file1 in the user's default directory on that same remote system:

```
% omv freunden/fencer/thrust::/user1/file2 file1 
```

For a complete description of the omv command and its associated options, see Appendix B. ♦

2.3 Recovering from Data Transfer Errors While Copying or Appending

FTAM supports the Restart and Recovery functionality for Class-1, Class-2, and Class-3 errors as detailed in ISO 8571-4. This functionality is supported in both the DEC FTAM initiator and in the DEC FTAM responder.

To use the Restart and Recovery related functionality, both the initiating and the responding entities must support Restart and Recovery.

OpenVMS

On OpenVMS, the /journal qualifier is added to either the copy or append command to request that the Restart and Recovery function be proposed. ♦

UNIX

On Digital UNIX, the -R option is added to the ocp command to request the Restart and Recovery function be proposed. ♦

For both OpenVMS and Digital UNIX, the FTAM responder will negotiate (support) the Restart and Recovery functionality when it is requested by an initiator.

When the Restart and Recovery function is negotiated:

- FTAM creates and maintains a docket to contain the Restart and Recovery related information needed by the FTAM association.
- For OpenVMS, the docket information is maintained in the file: `sys$scratch:osif$recovery.dat`. This file should be truncated or deleted periodically by the FTAM user. This file maintenance should be done when no active FTAM responders are being used as part of FTAM associations.

For Digital UNIX, the docket information is maintained in the file: `/etc/ftam_recovery.dat`.

2.3 Recovering from Data Transfer Errors While Copying or Appending

- The sender of FTAM data inserts checkpoints in the data transfer.

If a recoverable error is detected by the internal FTAM file service:

- FTAM returns an informational message stating that either a Restart or a Recovery is in progress.
- FTAM uses the Recovery information in the docket to recover the association (Class-3 error).
- FTAM uses the checkpoints, which were inserted into the data flow, to restart the data transfer at a point agreed upon by both the initiating and responding entities (Class-1 and Class-2 errors).

For Class-3 recoveries, the user has the option of defining logicals to customize recovery-related functionality. The logicals and their defaults are listed as follows:

Logicals	Defaults
OSIF_REINIT_MAX_RETRY	Default is 5. The number of times that the initiating entity will "retry" to re-establish the association with the responding entity after a Class-3 failure. On Digital UNIX, this value may also be set via the ocp -K option.
OSIF_REINIT_SLEEP	Default is 180 seconds. The number of seconds that the initiating entity will "sleep" or wait after a Class-3 error is received and before attempting to recover the association. On Digital UNIX, this value may also be set via the ocp -B option.
OSIF_REINIT_TIMEOUT	Default is 120 seconds. The number of seconds that the initiating entity will wait for a response from the responding entity after attempting to recover the association by sending an f-initialize-request. On Digital UNIX, this value may also be set via the ocp -W option.
OSIF_REDIRECT_TIMEOUT	Default is 1500 seconds. The number of seconds that the responding entity will wait for the initiating entity to recover the association before timing out and exiting. On Digital UNIX, this value may also be set via the ftamd -W option.

If an error is detected by the internal FTAM file service and either the initiating or responding entity is unable to complete the Restart and Recovery, FTAM prints a message and terminates the association.

Except for specifying the command line qualifier /journal on OpenVMS, or command line option -R on Digital UNIX, all other Restart and Recovery related operations and procedures are completely transparent to the user.

Note

If the responder image (on OpenVMS) or executable (on Digital UNIX) exits, a Restart or Recovery is no longer possible for that FTAM association.

Using FTAM

2.4 File Protection Assignment Upon File Creation

2.4 File Protection Assignment Upon File Creation

OpenVMS

OpenVMS FTAM assigns file protection to files that it creates in the following way. FTAM does not assign values for WORLD, GROUP, or SYSTEM access. FTAM maps the `permitted_actions` attribute of the F-CREATE-REQUEST against OWNER access as follows:

FTAM Permitted Action	OWNER Protection
read	read
read-attribute	read
traversal	read
reverse-traversal	read
random-order	read
insert	write
replace	write
extend	write
erase	write
change-attribute	write
delete-file	delete ♦

Using the DAP–FTAM Gateway (OpenVMS)

Note

While the DAP–FTAM Gateway only resides on an OpenVMS system, it can still be accessed from other OSI systems, providing you can access the remote OpenVMS system where the gateway resides.

The DAP–FTAM Gateway software allows any DECnet node to participate in an OSI network, provided that the node has DECnet access to the DAP–FTAM Gateway node.

3.1 Function of the DAP–FTAM Gateway

The DAP–FTAM Gateway resembles a server, in that it receives Data Access Protocol (DAP) messages through DECnet software and uses that information to establish and maintain a connection with a remote FTAM system.

The main advantage of the DAP–FTAM Gateway is that it simplifies communications capabilities for DECnet nodes because users can use system commands to communicate with remote OSI systems through the gateway. For the DCL user or Digital UNIX shell user, this means that communication with a remote FTAM application is handled the same as any DECnet dialogue.

3.2 Invoking the DAP–FTAM Gateway from OpenVMS FTAM Nodes

To invoke the gateway, use the following file-specification format:

```
gtwysystem"OSIGTWY password>::remote-alias["initiator-id [password [account]]"]::filename
```

Table 3–1 describes the gateway format variables in this format statement.

Table 2–2 describes the `initiator-id`, `password` and `account` variables. These variables apply to the `remote-alias` node (the OSI system), while the `OSIGTWY` account applies to the gateway system. The installation procedure creates the `OSIGTWY` account and provides a list of computer-generated passwords from which to choose.

Using the DAP–FTAM Gateway (OpenVMS)

3.2 Invoking the DAP–FTAM Gateway from OpenVMS FTAM Nodes

Table 3–1 Gateway Format Variables

Variable	Explanation
<i>gtwysystem</i>	The name of the node where the DAP–FTAM Gateway software is installed.
<i>OSIGTWY password</i>	Your DAP–FTAM Gateway user name and password.
<i>remote-alias</i>	The alias of the remote OSI system running FTAM that you want to access.
<i>filename</i>	The full file designation for the remote OSI system, supplied in its native file name conventions.

If you invoke the DAP–FTAM Gateway from other OSI nodes, use the normal syntax for the command and a file-specification format similar to the one described here for OpenVMS. For example, a directory command on a Digital UNIX system would resemble the following:

```
% dls gtwysystem/osigtwy/password::'remote-alias["initiator-id [password [account]]"]::filename'
```

In the following example, a DCL directory command initiated on node1 (an OpenVMS system) brings up the DAP–FTAM Gateway on node2 (an OpenVMS system) which converts the message from DAP protocol to FTAM protocol and then establishes a connection with remote FTAM system *osisys*. On *osisys*, FTAM requests the file attributes of the file *data.out*.

```
$ directory node2"OSIGTWY password"::osisys::"/files/data.out" Return
```

In this example, the user on node1 typed the directory command, followed by the node name of the system that has the DAP–FTAM Gateway installed (node2). To use the DAP–FTAM Gateway, the user must supply the correct password for the OSIGTWY account to invoke the DAP–FTAM Gateway on system node2.

Then, the user typed two colons (::), followed by the alias of the remote FTAM system. This was followed by two colons (:), and then the full file designation for the pertinent file contained in the remote filestore.

Note that the alias of the remote FTAM system must be known by the gateway system (i.e., it must be defined in *isoapplications.dat* on the gateway system).

Refer to your installation and configuration documentation for additional information on gateway user names and passwords for the DAP–FTAM Gateway.

3.3 Supported Qualifiers for OpenVMS Systems

OpenVMS users who are communicating through the DAP–FTAM Gateway to a remote OSI system can use the following qualifiers with their DCL commands. (Users on other DECnet systems can use their equivalent commands that utilize features similar to the DAP and FTAM protocols.)

Command	Qualifiers Supported
<i>append/copy</i>	<i>/allocation</i> , <i>/concatenate</i> , <i>/confirm</i> , <i>/log</i> , <i>/new_version</i> , <i>/replace</i>
<i>delete</i>	<i>/confirm</i> , <i>/log</i>
<i>directory</i>	<i>/date</i> , <i>/full</i> , <i>/owner</i> , <i>/size †</i>

†These are the only qualifiers that could have significance for *directory* commands passing through the Gateway.

Using the DAP–FTAM Gateway (OpenVMS)

3.3 Supported Qualifiers for OpenVMS Systems

Command	Qualifiers Supported
rename	/confirm, /log

3.4 Supported Document Types

The DAP–FTAM Gateway supports these document types with the following restrictions:

Document Type	String Significance
FTAM-1	Not significant
FTAM-2	Not significant
FTAM-3	Not significant

For more information on document types, see Section 7.2.2.6.

3.5 Quoting File Names

When using the DAP–FTAM Gateway, you should use double quotation marks around file names in order to avoid the possibility of system software adding any additional information to the file name. For example, an unquoted file name might be appended with a semicolon (;). In addition, using quotation marks preserves the case of the file name.

3.6 DAP–FTAM Gateway Messages

Most of the FTAM messages detailed in Appendix H are mapped to the following DAP error message:

```
DAP MICCODE: 250          [NETFAIL]
```

To an OpenVMS system, this is equivalent to the error RMS\$_NETFAIL. If you receive this message when using the gateway, ask your system manager to obtain a trace of the protocol exchange between the gateway and the remote FTAM node as a way to find the problem. Refer to *DECnet-Plus Problem Solving* for information on how to use the tracing utility to trace gateway connections automatically.

Using the FTAM–FTP Gateway (Digital UNIX)

Note

Although the FTAM–FTP Gateway only resides on a Digital UNIX system, it can still be accessed from other OSI systems. For more information see Section 4.3.

The FTAM–FTP Gateway software provides bidirectional access between OSI systems and Internet systems (such as those based on Berkeley 4.2/4.3 BSD TCP/IP implementations). The FTAM–FTP Gateway software lets you exchange files between these systems.

OSI end systems and Internet systems that communicate through the FTAM–FTP Gateway do not need special software, and remote users do not have to establish accounts on the gateway system. The FTAM installation procedure installs the FTAM–FTP Gateway software. For a complete description of the installation procedure, see your FTAM installation documentation.

4.1 Gateway Functions and Sample Commands

Table 4–1 shows the commands that the FTAM–FTP Gateway software supports.

Table 4–1 Commands Supported Through the FTAM–FTP Gateway

Gateway Function	FTAM Command	FTP Command
Change directory	—	cd
Display directory	ols	ls
	ols -l	dir
Delete files	orm	delete
Display files	ocat	get <i>file</i> - recv <i>file</i> -
Transfer files	ocp	recv get send put
	ocp-a	append
Rename files	omv	rename

If you log in to an Internet system (such as a UNIX system) and use the FTAM–FTP Gateway to access OSI systems, see Section 4.2 for instructions.

Using the FTAM–FTP Gateway (Digital UNIX)

4.1 Gateway Functions and Sample Commands

If you log in to an OSI system (such as a DECnet/OSI for Digital UNIX system) and use the FTAM–FTP Gateway to access Internet systems, see Section 4.3 for instructions.

4.2 Using the FTAM–FTP Gateway from an Internet Host

This section tells you how to work with files on a remote OSI node from an Internet host.

Note that the examples in this section assume that your Internet host is a Digital UNIX system. If your Internet host is a non-Digital Internet system based on Berkeley 4.2/4.3 BSD TCP/IP implementations, you might need different commands to perform the tasks described in this section.

4.2.1 Invoking the FTAM–FTP Gateway from Internet Nodes

To invoke the gateway from an Internet node, use the following ftp command sequence:

```
% ftp gateway-node
Name (gateway-node): alias::user
Password (alias::user): password
```

Table 4–2 describes the variables in this command.

Table 4–2 Internet Gateway Command Variables

Variable	Explanation
<i>gateway-node</i>	The name of the Internet node where the FTAM–FTP Gateway is installed.
<i>user</i>	The login name of the user on the FTAM system.
<i>alias</i>	The alias of the FTAM system to which you want to connect.
<i>password</i>	The password for the user on the FTAM system.

The name of the user who initiated the FTP session appears next to the gateway node name when the system prompts you for the login name on the FTAM system. The password is not displayed on the screen.

The DECnet–Internet Gateway invokes the FTAM–FTP Gateway if you supply an alias at the username prompt that is in the `/etc/isoapplications` file, regardless of the application (FTAM or VT) for which the alias is defined.

4.2.2 Specifying a Concatenation Character

Different operating systems use different syntax for path names. A **path name** is the order in which a directory is concatenated to a subdirectory and then concatenated to a file. The **syntax** is the concatenation character (or characters) used to represent the concatenation.

For example, Digital UNIX uses the slash (/) between components of a path name as a concatenation character, as in the following example:

```
/usr/users/smith/bin
```

MS–DOS however, uses the backslash (\) as the concatenation character as in the following example:

```
\usr\users\smith\bin
```

Using the FTAM-FTP Gateway (Digital UNIX)

4.2 Using the FTAM-FTP Gateway from an Internet Host

The FTAM-FTP Gateway always requires an argument to the `append`, `delete`, `get`, `put`, `recv`, `rename`, `send`, and `cd` commands. An argument is also required for the `ls` and `dir` commands until you specify a path name using the `cd` command.

To perform FTAM operations on a remote system, you must use a syntax the remote operating system understands. Since the FTAM-FTP Gateway software has no knowledge of what operating system or path name syntax the remote system uses, you must specify which concatenation character (syntax) you will use. This must be done with the `quote CCAT` command before using any FTAM-FTP command that requires or makes use of an argument.

The FTAM-FTP Gateway uses the concatenation character to concatenate the argument on the command line to the current working directory you specify with the `cd` command.

Note

Operating systems using a more complex syntax for concatenating file names to directories (such as OpenVMS) are not supported by the `CCAT` command.

The format of the `quote CCAT` command is:

```
quote CCAT character
```

The *character* argument is the concatenation character. For example, the command:

```
ftp> quote CCAT /
```

specifies that the slash (/) is used as the concatenation character.

Example 4-1 shows an association where a person named Smith attempts to perform FTAM operations without first using the `cd` command, and then without specifying the concatenation character. Smith then specifies the concatenation character and the FTAM operations are successful.

Example 4-1 Using the CCAT Command

```
1 $ ftp snozar
   Connected to snozar.nac.dec.com.
   220 snozar.nac.dec.com FTP server (Version 4.1 Thu Dec 5 19:16:40 EST 1996) ready.
   Name (snozar:smith): snozar_regtster::smith
   331 Password required for FTAM Gateway access to snozar_regtster.
   Password:
   230 User smith logged in.

2 ftp> pwd
   257 "(null)" is current directory.
   ftp> ls
   200 PORT command successful.
   501 Directory path must be specified via the CWD command.

3 ftp> cd /tmp
   250 CWD command successful.

4 ftp> cd /
   501 Concatenation character must be specified via the quote CCAT
   command.
```

(continued on next page)

Using the FTAM–FTP Gateway (Digital UNIX)

4.2 Using the FTAM–FTP Gateway from an Internet Host

Example 4–1 (Cont.) Using the CCAT Command

```
5 ftp> quote CCAT /
   200 Concatenation character is set to '/'.

6 ftp> cd /usr/users/smith
   250 CWD command successful.
   ftp> pwd
   257 "/usr/users/smith" is current directory.

7 ftp> ls utils
   200 PORT command successful.
   150 Opening data connection for /usr/users/smith/utils
   (16.20.0.89,1180) (0 bytes).
   /usr/users/smith/utils
   /usr/users/smith/utils/.
   /usr/users/smith/utils/..
   /usr/users/smith/utils/orm_dir
   /usr/users/smith/utils/omv_dir
   /usr/users/smith/utils/ocat_dir
   /usr/users/smith/utils/ocp_dir
   /usr/users/smith/utils/ols_dir
   /usr/users/smith/utils/lis
   /usr/users/smith/utils/ftamd
   226 Transfer complete.
   remote: utils
   316 bytes received in 0.63 seconds (0.49 Kbytes/s)

8 ftp> bye
   221 Goodbye.
```

- 1 Smith invokes the FTAM–FTP Gateway.
- 2 Smith attempts to list the contents of a directory without using the `cd` command. The directory path is unknown.
- 3 Smith uses the `cd` command for the first time and succeeds because the software assumes the path specification is absolute.
- 4 Smith attempts to change the directory again without specifying the concatenation character. This attempt fails because the software cannot determine if the directory specification is absolute or relative, so no action is taken.
- 5 Smith specifies the concatenation character as `/`.
- 6 Smith is now able to change directories.
- 7 Smith is now able to list the contents of a directory.
- 8 Smith closes the FTP session.

4.2.3 Sample Internet Commands

You can use common Internet commands to work with files and directories on remote OSI nodes. The FTAM–FTP Gateway only supports the common Internet commands shown in Table 4–3, which are discussed in the following sections and in *DECnet-Plus Network Control Language Reference*, Section 1.

Using the FTAM–FTP Gateway (Digital UNIX)

4.2 Using the FTAM–FTP Gateway from an Internet Host

Table 4–3 Sample Internet Commands and Their Functions

Command	Function
%ftp	Starts an FTP session.
ftp> append	Copies a local file to the end of a remote file.
ftp> ascii	Sets the file transfer type to ASCII mode (FTAM-1 file).
ftp> binary	Sets the file transfer type to binary image mode (FTAM-3 file).
ftp> bye	Closes an FTP session.
ftp> cd	Changes the current remote directory.
ftp> close	Terminates a connection to a remote node.
ftp> delete	Deletes a single remote file.
ftp> dir	Lists the contents (in long form) of a remote directory.
ftp> disconnect	Terminates a connection to a remote node.
ftp> get	Copies a remote file to the local directory (same as ftp> recv).
ftp> ls	Displays the names of files in the remote directory.
ftp> put	Copies a local file to the remote directory (same as ftp> send).
ftp> quit	Closes an FTP session.
ftp> recv	Copies a remote file to the local directory (same as ftp> get).
ftp> rename	Renames a remote file to another file.
ftp> send	Copies a local file to the remote directory (same as ftp> put).
ftp> user	Identifies the user to the remote FTP server.

To use FTP, start an FTP session by issuing the `ftp` command. The session lasts until you end it with either the `quit`, `close`, `bye`, or `disconnect` command. During an FTP session, you see the `ftp>` prompt. You also establish a connection with the remote OSI node that you want to access. Once connected, you can use FTP commands to manipulate files and directories on that node.

The following sections describe specific tasks you can perform using FTP commands.

4.2.4 Starting an FTP Session

To start an FTP session, type `ftp` at the system prompt. For example:

```
% ftp 
ftp>
```

4.2.5 Ending an FTP Session

To end an FTP session, type `bye` or `quit` at the `ftp>` prompt. For example:

```
ftp> bye 
%
```

Using the FTAM–FTP Gateway (Digital UNIX)

4.2 Using the FTAM–FTP Gateway from an Internet Host

4.2.6 Connecting to a Remote OSI Node

To access files on a remote OSI node using FTP, you first need to establish a connection to that node. Once you are connected to a node, you can use FTP commands to work with files and directories on that node.

You can connect to a node when starting the FTP session by using the same command sequence used to invoke the FTAM–FTP Gateway (described in Section 4.2.1). In this example, the gateway system (Internet node) is boston:

```
% ftp boston 
```

When the gateway prompts you for a user name, specify the alias of the FTAM system to which you want to connect and your login name on that system. Enter the information in this format:

```
alias::user
```

In this example, boston is the Internet system where the gateway is installed and doe is the name of the user who initiated the FTP session; freunde is the FTAM alias representing the destination FTAM system; and smith is the login name of the user on the FTAM system.

```
Name (boston::doe): freunde::smith 
```

Finally, enter the password at the Password prompt. The password does not appear on your screen, or echo, when you type it. For example:

```
Password (freunde::smith): secret 
```

Here is an example of the complete connection process. The gateway system is boston, the target FTAM system is freunde, the user is smith, and the password is secret.

```
% ftp boston   
Connected to boston.  
220 boston FTP server (Version 4.1 Fri Feb 15 19:42:25 EDT 1996) ready.  
Name (boston::doe): freunde::smith   
Password (freunde::smith): secret   
331 Password required for FTAM gateway access freunde::smith.  
230 User smith logged in.  
ftp>
```

4.2.7 Disconnecting from a Remote OSI Node

To end your connection to a remote OSI node, type the close or disconnect command at the ftp> prompt. For example:

```
ftp> close   
221 Goodbye.  
ftp>
```

Note that the close command does not end the FTP session. The Internet connection is still in effect, but the FTAM association is terminated.

4.2.8 Viewing Remote Directories

While connected to a remote OSI node, you can view different directories on that node, as follows:

To change the current remote directory, type the cd command followed by the name of the directory. Enter the complete path name of the remote directory in the syntax expected by the remote system. If you do not specify the directory name with the cd command, the system prompts you for one. For example:

Using the FTAM-FTP Gateway (Digital UNIX)

4.2 Using the FTAM-FTP Gateway from an Internet Host

```
ftp> cd /usr/users/smith/memos   
250 CWD command successful.  
ftp>
```

or

```
ftp> cd   
(remote-directory) /usr/user/smith/memos   
250 CWD command successful.  
ftp>
```

To return to the home directory after accessing a subdirectory in FTP, specify the full path name and the correct directory syntax with the `cd` command. You should use the `cd` command to set your default directory when opening your connection. Doing so allows you to use the `ls` and `dir` commands without an argument.

To display the names of the remote files and directories, type the `ls` command. For example:

```
ftp> ls /smith/memos/tasks   
200 PORT command successful.  
150 Opening data connection for /smith/memos/tasks (123.45.6).  
bc.txt  
status.sdml  
tips.txt  
226 TRANSFER COMPLETE.  
  
54 bytes received in 0.83 seconds (0.064 Kbytes/s)  
ftp>
```

For an expanded display, type the `dir` command. For example:

```
ftp> dir tasks   
200 PORT command successful.  
150 Opening data connection for /smith/memos/tasks (123.45.6).  
FTAM-1 -rwx-----      29266 Mar 13 1996 bc.txt  
FTAM-1 -rw-----       6534 Apr 19 1996 status.sdml  
FTAM-1 -rwx-----       7718 May 15 12:55 tips.txt  
226 TRANSFER COMPLETE.  
300 bytes received in 0.71 seconds (0.41 Kbytes/s)  
ftp>
```

4.2.9 Displaying Remote Files

To display a remote file, type the `get` command followed by the name of the remote file and a hyphen. For example:

```
ftp> get team.txt -   
200 PORT command successful.  
150 Opening data connection for  
    /smith/memos/team.txt (123.45.6)  
This file lists all the reviewers for the book:  
Donna  
Geeta  
John  
Larry  
Michael  
Ravi  
Scott  
Tracy  
226 Transfer complete.  
remote: team.txt  
111 bytes received in 0.15 seconds (0.72 Kbytes/s)  
ftp>
```

Using the FTAM–FTP Gateway (Digital UNIX)

4.2 Using the FTAM–FTP Gateway from an Internet Host

The hyphen indicates that you want the file displayed at the terminal. If you omit the hyphen, the system copies the remote file to your current working directory, without displaying anything.

The `recv` command works exactly like `get`.

4.2.10 Setting the File Transfer Type

You can transfer, or copy, ASCII and binary files using `ftp` commands. Set the FTAM–FTP Gateway file transfer type to ASCII when you transfer ASCII files (FTAM-1 files) and to binary (image mode) when you transfer binary files (FTAM-3 files). ASCII is the default.

You can set the file transfer type using the FTP commands shown in the following examples.

To set the file transfer type to ASCII, enter the `ascii` command. For example:

```
ftp> ascii   
200 Type set to A.  
ftp>
```

To set the file transfer type to binary image mode, type the `binary` command. For example:

```
ftp> binary   
200 Type set to I.  
ftp>
```

To display the current settings of the FTP variables, use the `status` command.

4.2.11 Copying Files Between Systems

When connected to a remote OSI node, you can copy files to and from that node. To copy a remote file, type either the `get` or `recv` command, followed by the remote file name. If you want the local file to have a different name, also specify a local file name. The `get` and `recv` commands are interchangeable.

The following examples illustrate the different ways you can copy files with FTP commands.

- In the following example of the `recv` command, a local file name is not specified, so `ftp` creates a local file with the same name as the remote file:

```
ftp> recv games.lis   
200 PORT command successful.  
150 Opening data connection for  
    /smith/memos/games.lis (123.45.6)  
226 Transfer complete.  
local: games.lis remote:games.lis  
6010 bytes received in 0.8 seconds (7.3 Kbytes/s)  
ftp>
```

- In the following example of the `get` command, a local file name is specified:

Using the FTAM-FTP Gateway (Digital UNIX)

4.2 Using the FTAM-FTP Gateway from an Internet Host

```
ftp> get games.lis games 
200 PORT command successful.
150 Opening data connection for
    /smith/memos/games.lis (123.45.6)
226 Transfer complete.
local: games remote:games.lis
6010 bytes received in 0.41 seconds (14 Kbytes/s)
ftp>
```

Note

If you use the `get` or `recv` command and type a hyphen instead of specifying a local file name for the file, the file is displayed on your terminal without being copied to the local system.

- To copy a local file to a remote file, type the `put` command, followed by the local file name and the remote file name (optional). For example:

```
ftp> put team.txt newteam.txt 
200 PORT command successful.
150 Opening data connection for
    /smith/memos/team.txt (123.45.6)
226 Transfer complete.
local: team.txt remote: newteam.txt
6010 bytes sent in 0.4 seconds (42 Kbytes/s)
ftp>
```

- To copy a local file to the end of a remote file, type the `append` command followed by the local file name and the remote file name. The following example appends the local file `team.txt` to the remote file `scores`:

```
ftp> append team.txt scores 
200 PORT command successful.
150 Opening data connection for
    /smith/memos/scores (123.45.6)
226 Transfer complete.
local: team.txt remote: scores
9398 bytes sent in 0.59 seconds (16 Kbytes/s)
ftp>
```

You cannot use the `append` command to copy a remote file to the end of a local file.

- To delete a single remote file, type the `delete` command followed by the file name. For example:

```
ftp> delete team.txt 
250 DELE command successful.
ftp>
```

If you do not specify the file name after the `delete` command, the system prompts you for the file name. For example:

```
ftp> delete 
(remote-file) team.txt 
250 DELE command successful.
ftp>
```

Using the FTAM–FTP Gateway (Digital UNIX)

4.3 Using the FTAM–FTP Gateway from an OSI Node

4.3 Using the FTAM–FTP Gateway from an OSI Node

This section tells you how to work with files on an Internet host while logged on to an OSI node.

Note that the examples in this chapter assume that your OSI node is an OpenVMS FTAM system. If your OSI node is from another vendor, you might need different commands to perform the tasks described in this section.

4.3.1 Invoking the FTAM–FTP Gateway from OpenVMS FTAM Nodes

To invoke the gateway using the commands described in this section, use the following file-specification format:

```
gateway-alias"user@node password"::"filename"
```

Table 4–4 explains each component in the file specification.

Table 4–4 OpenVMS FTAM Gateway Command Variables

Component	Explanation
<i>gateway-alias</i>	The alias of the node where the FTAM–FTP Gateway is installed.
<i>user</i>	The name of the user on the remote Internet node.
<i>node</i>	The name of the Internet node where you want to connect.
<i>password</i>	The password for the user on the target node.
<i>filename</i>	The name of the file to be accessed.

Note that the file name is enclosed within quotation marks to ensure that the Internet host receives the file name in lowercase letters as required.

If you invoke the FTAM–FTP Gateway from other OSI nodes, use the normal syntax for the FTAM command and a file-specification format similar to the one described here. The important point to remember is that the *user* and the *node* values must be separated by the "at sign" (@). For example, an FTAM directory command on a Digital UNIX system would resemble the following:

```
% ols gateway-alias/user@node/password::filename
```

where the format is the same as for OpenVMS, except that the conventions of the Digital UNIX operating system are followed.

4.3.2 Sample OpenVMS FTAM Commands

Table 4–5 shows common OpenVMS FTAM commands you can use through the gateway. You can abbreviate the qualifier `/application_protocol=ftam` to `/appl=ftam`, as used throughout the rest of this section.

Table 4–5 Sample OpenVMS FTAM Commands

Command	Function
<code>append/appl=ftam</code>	Copies a remote file to the end of a local file.
<code>copy/appl=ftam</code>	Transfers a file to or from an Internet host.
<code>delete/appl=ftam</code>	Deletes a file.

(continued on next page)

Using the FTAM–FTP Gateway (Digital UNIX)

4.3 Using the FTAM–FTP Gateway from an OSI Node

Table 4–5 (Cont.) Sample OpenVMS FTAM Commands

Command	Function
directory/appl=ftam	Displays the file names in an Internet directory.
rename/appl=ftam	Renames a file to or from an Internet system.

From your OpenVMS system prompt, you can use five OpenVMS FTAM commands to work with files and directories on an Internet host: `append`, `copy`, `delete`, `directory`, and `rename`. The following sections on gateway-supported OpenVMS FTAM commands explain how to type command lines and which tasks you can perform with these commands.

4.3.3 Viewing Remote Directories

To list the file names in remote Internet directories, type the `directory` command and specify the directory and files (optional) you want displayed. For example:

```
$ directory/appl=ftam boston"a_lima@bean topsecret": 
Directory BOSTON"a_lima@bean password":
Message1          dnetcheck.rnd      doctype.txt      inventory
tasks.s           team.txt
Total of 6 files.
$
```

Note

Due to the nature of the File Transfer Protocol (FTP), this command lists only the file names within specific directories; information about file protections, dates, or sizes does not pass through the FTAM–FTP Gateway.

4.3.4 Copying Files Between Systems

To copy a remote file to your local system, type the `copy` command followed by the remote file name and the local file name. For example:

```
$ copy/appl=ftam boston"a_lima@bean secret": "tasks.s" tasks.lis 
```

To copy a local file to a remote system, type the `copy` command followed by the local file name and the remote file name. For example:

```
$ copy/appl=ftam notes.lis boston"a_lima@bean secret": "notes.lis" 
```

To copy the contents of a remote file to the end of a local file, type the `append` command followed by the remote file name and the local file name. In the following example, the phone numbers in the remote file `phones.txt` are copied to the end of the local file `team.txt`:

```
$ append/appl=ftam boston"a_lima@bean secret": "phones.txt" team.txt 
```

Using the FTAM–FTP Gateway (Digital UNIX)

4.3 Using the FTAM–FTP Gateway from an OSI Node

4.3.5 Deleting Remote Files

To delete a remote file, type the delete command followed by the name of the remote file to be deleted. For example, the following command removes the file report.1 from the kiko account on the Internet host tokyo. The password is secret; the Gateway node name is boston.

```
$ delete/appl=ftam boston"kiko@tokyo secret"::"report.1" Return
```

Notice that the file name must be in lowercase type enclosed within quotation marks to ensure that the Internet host receives the file name in lowercase letters as required.

4.3.6 Renaming Files Between Systems

To rename a remote file to your local system, type the rename command followed by the remote file name and the local file name. For example:

```
$ rename/appl=ftam boston"a_lima@bean secret"::"team.txt" team.lis Return
```

To rename a local file to a remote system, type the rename command followed by the local file name and the remote file name. For example:

```
$ rename/appl=ftam notes.lis boston"a_lima@bean secret"::"notes.lis" Return
```

Note that the file name is enclosed within quotation marks to ensure that the Internet host receives the file name in lowercase letters as required.

4.4 Special Considerations for Internet Systems

If you are transferring text files from an Internet system, note the following:

- The /etc/isoapplications file must be present on the gateway system. See Chapter 12 for more information on managing the FTAM–FTP Gateway and the /etc/isoapplications file.
- An FTAM responder must be running on the FTAM system. It must be listening on the FTAM alias named in the gateway connection. See Chapter 12 for more information on managing the FTAM–FTP Gateway and the FTAM listener.
- Upon establishing the FTAM association, the default directory name is still unknown to the FTP process. Until the FTP user specifies a directory with the cd command, use of the ls command without an argument results in failure.

4.5 Special Considerations for Internet Systems Not Based on UNIX

If you are transferring text files from an Internet system that is not running on UNIX, watch for the following:

- A file you transfer appears on your system with no end-of-line terminators.
- The file transfer fails, and an error message indicates that the record was too large for your buffer.

These problems may indicate that the FTAM–FTP Gateway's default data transfer mode is inappropriate for transferring files from other types of Internet systems. Contact your system administrator.

Using Virtual Terminal

5.1 Accessing Remote Nodes

Virtual Terminal (VT) provides services to log in to remote systems.

You can use the following commands to connect between two OSI systems:

OpenVMS	Digital UNIX
set host/vtp command	ologin command

You can use the following gateways to connect between OSI and non-OSI systems:

OpenVMS	Digital UNIX
LAT/VT Gateway	LAT/VT Gateway
VT/LAT Gateway	
Telnet/VT Gateway	Telnet/VT Gateway
VT/Telnet Gateway	VT/Telnet Gateway
	CTERM/VT Gateway
	VT/CTERM Gateway

5.1.1 Starting a VT Association

To access any remote OSI node in your network that supports OSI Virtual Terminal operations, you must first establish a VT association with that node. An OSI Virtual Terminal responder must already be running on the remote system in order to establish the VT association.

Use the appropriate command to establish a VT association with a remote VT application.

OpenVMS

```
set host/vtp application [qualifiers]
```

application specifies an alias listed in the `sys$system:isoapplications.dat` file, or an X.500 Distinguished Name. If you supply an X.500 Distinguished Name, you must enclose it in quotes.

If you do not enter a value for *application*, the software prompts you to do so. See Appendix C for a complete list of the command qualifiers. ♦

Using Virtual Terminal

5.1 Accessing Remote Nodes

UNIX

```
ologin application [options]
```

application specifies an alias listed in the `/etc/isoapplications` file, or an X.500 Distinguished Name.

If you do not supply a value for *application*, then the software displays an error and exits. See Appendix D for a complete list of the command options. ♦

Contact your system administrator for the aliases available to you.

If the input is an alias, then it is looked up in the `isoapplications` file. See Chapter 9 for additional information on aliases and the `isoapplications` file.

If the input is an X.500 Distinguished Name, then the X.500 Directory is queried for the presentation address associated with the X.500 Directory entry specified by the input. If the query is successful, then the returned presentation address establishes a Virtual Terminal association with the remote application.

Note

Agreements in International OSI Implementors groups regarding the storage of Form2 AE-titles in the X.500 Directory are still in draft form. Therefore, the FTAM and VT software will only request the value of the presentation address attribute of the object identified by the X.500 Distinguished Name, and only the presentation address will be used to establish the Virtual Terminal connection.

OpenVMS

On OpenVMS, the following examples show the `set host/vtp` command being used to establish a VT association with the VT applications specified by the alias `rnode` in `sys$system:isoapplications.dat`, and the Distinguished Name `/c=us/o=abacus/cn=rnode/cn=vtp`.

In the second example, the default transport template is used when establishing the connection. In the last example, the transport template `my_template` is used.

```
$ set host/vtp rnode /log=myfile.out Return
```

```
$ set host/vtp "/c=us/o=abacus/cn=rnode/cn=vtp:" /log=myfile.out Return
```

```
$ set host/vtp "template=my_template:/c=us/o=abacus/cn=rnode/cn=vtp:" /log=myfile.out Return ♦
```

UNIX

On Digital UNIX, the following examples show the `ologin` command being used to establish a VT association with the VT applications specified by the alias `rnode` in `/etc/isoapplications`, and the Distinguished Name `/c=us/o=abacus/cn=rnode/cn=vtp`.

In the second example, the default transport template is used when establishing the connection. In the last example, the transport template `my_template` is used.

```
% ologin rnode -o myfile.out Return
```

```
% ologin /c=us/o=abacus/cn=rnode/cn=vtp: -o myfile.out Return
```

```
% ologin template=my_template:/c=us/o=abacus/cn=rnode/cn=vtp: -o myfile.out Return ♦
```

5.1.2 Using VT in Command Mode

Once you have accessed the remote node, you can enter command mode and issue commands to control and monitor the association. Press the appropriate key sequence to enter command mode.

On OpenVMS, enter Ctrl/@, and VT_PAD> appears as the prompt.

On Digital UNIX, enter Ctrl/], and ologin appears as the prompt.

To exit command mode, press Return, or enter resume.

Table 5–1 describes the commands you can use while in command mode.

Table 5–1 Command Mode Commands

Command	Description
abort	Sends a vt-abort message to the remote host.
exit	Sends a vt-release message to the remote host.
quit	Same as exit.
toggle	(Available only with Telnet-1988 and Generalized Telnet profiles.) Toggles between true and false the flags that control how the VT initiator responds to events. After you issue the toggle command, VT automatically exits command mode. You can display the current value of these flags with the display command. Valid arguments are: <ul style="list-style-type: none"> • binary — Allows 8-bit data to be both sent and received. The binary argument also examines inbinary and outbinary to determine their state. If either or both are false, then the appropriate value is toggled to true. If both are true, then both are toggled false. • inbinary — Allows 8-bit data to be received. • outbinary — Allows 8-bit data to be sent. • ? — Displays the valid toggle arguments.
help [<i>command</i>]	Accesses online help. Entering help with no argument displays a list of command topics on which help is available. Selecting a topic provides an explanation of that topic, along with subtopics you can select for more information. You can also use the question mark (?) to access online help.
resume	Exits command mode and resumes your VT association.

(continued on next page)

Using Virtual Terminal

5.1 Accessing Remote Nodes

Table 5–1 (Cont.) Command Mode Commands

Command	Description
<code>send [item]</code>	<p>Sends one or more special character sequences to the remote host. After you issue the <code>send</code> command, VT automatically exits command mode. Valid arguments are:</p> <ul style="list-style-type: none"> • <code>ao</code> — (Available only with Telnet-1988 and Generalized Telnet profiles.) Sends the telnet <code>ao</code> (Abort Output) sequence, which causes the remote system to alternately suspend and resume the sending of output to the user's terminal. The <code>ao</code> sequence does not affect the processing of the remote system. • <code>ayt</code> — (Available only with Telnet-1988 and Generalized Telnet profiles.) Sends the telnet <code>ayt</code> (Are You There) sequence. The remote system may or may not respond. • <code>brk</code> — (Available only with Telnet-1988 and Generalized Telnet profiles.) Sends the telnet <code>brk</code> (Break) sequence, which may have significance to the remote system. • <code>break</code> — Sends the current VT break character, initially <code>Ctrl /</code> for OpenVMS and <code>Ctrl/^</code> for Digital UNIX. • <code>command</code> — Sends the current VT initiator command character, initially <code>Ctrl/@</code> for OpenVMS and <code>Ctrl/ </code> for Digital UNIX. The <code>send</code> command option is useful when the command character has some meaning to the remote process. Normally, entering the character invokes the Command Line Interface. Using the <code>send</code> command option will send the character sequence to the remote host to be processed. • <code>ec</code> — (Available only with Telnet-1988 and Generalized Telnet profiles.) Sends the <code>ec</code> (Erase Character) sequence, which causes the remote system to erase the last character entered. • <code>e1</code> — (Available only with Telnet-1988 and Generalized Telnet profiles.) Sends the <code>e1</code> (Erase Line) sequence, which causes the remote system to erase the line currently being entered. • <code>escape</code> — Same as <code>command</code>. • <code>disconnect</code> — Sends the current disconnect character, initially <code>Ctrl/ \</code> for OpenVMS and <code>Ctrl/_</code> for Digital UNIX. • <code>ga</code> — (Available only with Telnet-1988 and Generalized Telnet profiles.) Sends the telnet <code>ga</code> (Go Ahead) sequence. Often this sequence has no significance to the remote system. • <code>ip</code> — (Available only with Telnet-1988 and Generalized Telnet profiles.) Sends the telnet <code>ip</code> (Interrupt Process) sequence, which causes the remote system to abort the currently running process. • <code>synch</code> — (Available only with Telnet-1988 and Generalized Telnet profiles.) Sends the telnet <code>synch</code> sequence. This sequence causes the remote system to discard input that was previously entered but that it has not yet read. • <code>vtbreak</code> — Sends a <code>vt-break</code> message. This is similar in concept to the telnet <code>synch</code> sequence. • <code>?</code> — Prints out help information for the <code>send</code> command.

(continued on next page)

Table 5–1 (Cont.) Command Mode Commands

Command	Description
<code>display [item]</code>	Entering <code>display</code> with no argument displays all set and toggle values, as well as the current profile, and any negotiated profile information. If you include an item as an argument, the software displays information about that item only.
<code>show [item]</code>	Same as <code>display</code> .
<code>set item</code>	<p>Sets a VT initiator variable to a specific value. The <code>off</code> value turns off the function associated with the variable. Be careful when choosing values for the variables to set, because this command overrides any previous settings for the variable.</p> <p>You can display the current values of variables with the <code>display</code> or <code>show</code> commands. Valid arguments are:</p> <ul style="list-style-type: none"> • <code>break</code> — Sends a <code>vt-break</code> message to the remote host. For OpenVMS, the value is initially <code>Ctrl/]</code>. For Digital UNIX, the value is initially <code>Ctrl/^</code>. • <code>disconnect</code> — Sends a <code>vt-release</code> message to the responder, and terminates the virtual terminal association. For OpenVMS, the value is initially <code>Ctrl/\</code>. For Digital UNIX, the value is initially <code>Ctrl/_</code>. • <code>command</code> — Enters the VT initiator command mode while you are connected to a remote system. For OpenVMS, the value is initially <code>Ctrl/@</code>. For Digital UNIX, the value is initially <code>Ctrl/]</code>. • <code>escape</code> — Same as <code>command</code>. • <code>binary</code>, <code>inbinary</code> and <code>outbinary</code> — Sets <code>item</code> to true. See <code>toggle</code> command. <p>With the <code>set</code> command you can also set the value of a flag that controls how the initiator responds to events to true. Valid arguments are the same as those for <code>toggle</code>.</p>
<code>unset item</code>	Sets a VT initiator variable to <code>off</code> , or the value of a flag that controls how the VT initiator responds to events to false. Valid arguments are the same as those for <code>set</code> .
<code>mode type</code>	(Available only with Telnet-1988 and Generalized Telnet profiles.) Enters either <code>line</code> , for line-by-line mode, or <code>character</code> , for character-by-character mode. The local host asks the remote host for permission to go into one or the other mode. The remote host enters the requested mode, if capable.
<code>show profile</code>	Displays the current profile and any negotiated profile information. Note that the <code>show profile</code> command does not have the equivalent <code>set profile</code> , as with other <code>show</code> and <code>display</code> commands.

Note

Not all commands or command options are available for all profiles. For example, commands that send a telnet equivalent command, such as `send ayt`, will only work for the Telnet and Generalized Telnet profiles. See Section 1.4.3 for more information on profiles.

Using Virtual Terminal

5.1 Accessing Remote Nodes

Table 5–2 describes the control characters for both Digital UNIX and OpenVMS systems.

Table 5–2 Control Characters

Function	Digital UNIX	OpenVMS
Disconnect	Ctrl/_	Ctrl/\
Command* Escape*	Ctrl/]	Ctrl/@
Break	Ctrl/^	Ctrl/]
Are You There†		Ctrl/T
Interrupt Process†	Ctrl/C	Ctrl/C
Abort Output†	Ctrl/O	Ctrl/O

*The command and escape functions are the same.

†Applies only to Telnet and Generalized Telnet profiles.

Note

To set the Ctrl/@ key to be the break, command, or disconnect character, you must enter it using the circumflex-character notation (i.e., by entering the "^" character, followed by the "@" character.

5.2 Using Gateways for Remote OSI Node Access

The VT Gateways support communication to and from non-OSI systems by means of LAT, CTERM, and Telnet.

Table 5–3 shows the supported gateways for each supported platform.

Table 5–3 VT Gateways

OpenVMS	Digital UNIX
LAT/VT Gateway	LAT/VT Gateway
VT/LAT Gateway	
Telnet/VT Gateway	Telnet/VT Gateway
VT/Telnet Gateway	VT/Telnet Gateway CTERM/VT Gateway VT/CTERM Gateway

For the LAT/VT, Telnet/VT, and CTERM/VT Gateways, the profile you use in an association is always Generalized Telnet. The VT/LAT, VT/Telnet, and VT/CTERM Gateways accept associations for any supported profile, such as A-mode Default, Telnet-1988, Generalized Telnet, and Transparent.

Using Virtual Terminal

5.2 Using Gateways for Remote OSI Node Access

5.2.1 Using the LAT/VT Gateway

If your network has one or more LAT/VT Gateways enabled, you can use any terminal server or system that supports Digital's local area transport (LAT) protocol to access a remote OSI system that has a Virtual Terminal responder installed. Examples of terminals and systems that support LAT are:

- Any computer terminal
- Any personal computer running MS-DOS, OS/2, or Macintosh
- Any OpenVMS or VMS Version 5.5 (or later) system
- Any VMS Version 5.4 (or later) system, running the optional LAT software

From a terminal connected to a terminal server, use the LAT connect command to connect to the LAT/VT Gateway system:

```
Local> connect service-name [node node-name [destination port-name]]
```

Table 5-4 describes the variables in the connect command format.

Table 5-4 LAT connect Command Variables

<i>service-name</i>	The name of the LAT service for the gateway. System administrators assign this name when they enable a LAT /VT Gateway. The local system uses this name to determine which gateway node to use for the connection.
<i>node-name</i>	The name of the gateway node.
<i>port-name</i>	The alias of the remote OSI system you want to access. (For Digital UNIX gateway nodes only.)

If you do not specify the gateway node name, the system connects to the first available node that is announcing the LAT/VT Gateway service.

For Digital UNIX, if you specify a remote node name *port-name* without specifying a gateway node-name, you receive an error message.

See Appendix C and Appendix D for more information on the connect command.

In the following examples, two gateway systems (systems where the LAT/VT Gateways reside) are used. The name of the OpenVMS gateway system is *intrpd*, and the name of the Digital UNIX gateway system is *discvr*. The name of the LAT service for the LAT/VT Gateways is *LAT_VT_GTWY*.

From a terminal server, use the following command to connect to the OpenVMS gateway system:

```
Local> connect lat_vt_gtwy node intrpd
```

Use the following command to connect through the Digital UNIX gateway system to remote OSI system *serchr*:

```
Local> connect lat_vt_gtwy node discvr destination serchr
```

Using Virtual Terminal

5.2 Using Gateways for Remote OSI Node Access

OpenVMS

From an OpenVMS system, use the following command to connect to the OpenVMS gateway system:

```
$ set host/lat lat_vt_gtwy/node=intrpd
```

Use the following command to connect to the Digital UNIX gateway system (you can use the `/destination_port` qualifier to specify the remote OSI node alias):

```
$ set host/lat lat_vt_gtwy/node=discvr
```

See Appendix D or enter `help set host /lat` for more information on the `set host/lat` command. ♦

See also Appendix C and Appendix D for information on the `sethost` command to access the LAT/VT Gateway from a PC.

A successful LAT connection command to an OpenVMS gateway system or to a Digital UNIX gateway system with no remote node name specified on the connection command results in a prompt for the remote alias name as shown in the following example:

```
Welcome to the LAT/VT gateway on INTRPD
```

```
Enter remote alias name:
```

At the gateway prompt, enter the alias or the X.500 Distinguished Name of the remote OSI system you want to access. The alias must be known by the gateway system (i.e., it must be defined in the `isoapplications.dat` file on the gateway system). If you enter an X.500 Distinguished Name, be sure to terminate it with a colon (:). After the VT connection is established to the remote system, it prompts you to log in as usual.

UNIX

A successful LAT connection command to a Digital UNIX gateway system with a remote OSI node alias supplied on the connection command results in the LAT/VT gateway automatically attempting to establish a VT connection with the alias specified. Note that unlike at the gateway prompt, you cannot specify an X.500 Distinguished Name on the LAT connection command; only aliases are accepted.

The gateway prints out something similar to the following:

```
Welcome to the LAT/VT gateway on discvr.org.com  
Connecting to serchr
```

After the VT connection is established to the remote system, it prompts you to log in as usual. ♦

5.2.2 Using the OpenVMS VT/LAT Gateway

Note

The VT/LAT Gateway is not available on Digital UNIX; that is, a Digital UNIX node cannot act as a VT-to-LAT gateway node, only as a LAT-to-VT gateway node. A Digital UNIX user can use the VT/LAT Gateway on an OpenVMS system by using the `ologin` command.

If your network has one or more VT/LAT Gateways enabled, you can access a remote system that supports the LAT protocol from an OSI system.

The gateway system administrator assigns a unique OSI address to the VT/LAT Gateway and creates an alias pointing to the gateway. To access the gateway, specify the gateway alias on the VT connect command.

Using Virtual Terminal

5.2 Using Gateways for Remote OSI Node Access

In the following examples, `intrpd` is the name of the OpenVMS gateway system (system where the VT/LAT Gateway resides). The alias defined for the VT/LAT Gateway on the `intrpd` system is `intrpd$lat`.

From an OpenVMS system, use the following command to connect to the VT/LAT Gateway:

```
$ set host/vtp intrpd$lat 
```

See Appendix C for more information on the `set host` command.

UNIX

From a Digital UNIX system, use the following command to connect to the VT/LAT Gateway:

```
% ologin intrpd$lat 
```

See Appendix D for more information on the `ologin` command. ♦

A successful VT connection to the VT/LAT Gateway application results in a prompt for the LAT service name as shown in the following example:

```
Welcome to the VT/LAT gateway on INTRPD
```

```
Enter LAT service name:
```

At the gateway prompt, enter the LAT service name of the remote LAT system you want to access. After the LAT connection is established to the remote system, it prompts you to log in as usual.

5.2.3 Using the Telnet/VT Gateway

If your network has one or more Telnet/VT Gateways enabled, you can use the `telnet` command from an Internet system to access a remote OSI system that has a Virtual Terminal responder installed.

If the gateway system is an OpenVMS system, you may need to specify the port number. The default port number on OpenVMS is 30324. If the gateway system is a Digital UNIX system, you do not need to specify the port number.

OpenVMS

Note

To use the Telnet/VT Gateway, your local OpenVMS system must have the Digital TCP/IP Services for OpenVMS product installed. ♦

In the following examples, two gateway systems (systems where the Telnet/VT Gateways reside) are used. The name of the OpenVMS gateway system is `intrpd`, and the name of the Digital UNIX gateway system is `discvr`.

OpenVMS

From an OpenVMS system, use one of the following commands to connect to the OpenVMS gateway system (in this case the port number is specified):

```
$ telnet intrpd/port=30324   
$ telnet intrpd 30324 
```

Use the following command to connect to the Digital UNIX gateway system:

```
$ telnet discvr 
```

See Appendix C or enter `help telnet` for more information on the `telnet` command. ♦

Using Virtual Terminal

5.2 Using Gateways for Remote OSI Node Access

UNIX

From a Digital UNIX system, use the following command to connect to the OpenVMS gateway system (in this case the port number is specified):

```
% telnet intrpd 30324 
```

Use the following command to connect through the Digital UNIX gateway system to remote OSI system serchr:

```
% telnet discvr -l serchr:: 
```

The `-l` option on the `telnet` command specifies the input to the login prompt (see below). The `-l` option is required on the `telnet` command if you are logged in to a Digital UNIX system and you want to use the Telnet/VT Gateway that is installed on another Digital UNIX system. Otherwise, `telnet` automatically specifies your user name at the login prompt.

See Appendix D or the `telnet(1c)` reference page for more information on the `telnet` command. ♦

OpenVMS

A successful `telnet` command to an OpenVMS gateway system results in a prompt for the remote alias name as shown in the following example:

```
Trying...16.63.96.230
Connected to INTRPD
Escape character is '^]'.

```

```
Welcome to the Telnet/VT gateway on INTRPD
```

```
Enter remote alias name:
```

At the gateway prompt, enter the alias or X.500 Distinguished Name of the remote OSI system you want to access. The alias must be known by the gateway system (i.e., it must be defined in the `isoapplications.dat` file on the gateway system). If you enter an X.500 Distinguished Name, be sure to terminate it with a colon (:). After the VT connection is established to the remote system, you are prompted to log in as usual. ♦

UNIX

If you are connecting from an OpenVMS system, a successful `telnet` command to a Digital UNIX gateway system results in a login prompt as shown in the following example:

```
Trying...16.62.96.231
Connected to DISCVR.
Escape character is '^]'.

```

```
Digital UNIX (discvr.org.com) (ttyp4)
```

```
login:
```

If you are connecting from a Digital UNIX system, you must supply your response to the login prompt via the `-l` option on the `telnet` command. All of the information presented here about the alias entered at the login prompt also applies to the alias entered at the `-l` option.

At the login prompt (or at the `-l`), enter the alias of the remote OSI system you want to access, followed by a double colon (::). The alias must be defined on the gateway system. The double colon indicates that you want to connect using the DECnet–Internet Gateway.

The DECnet–Internet Gateway invokes the Telnet/VT Gateway if you supply an alias that is in the `/etc/isoapplications` file on the gateway system, regardless of the application (FTAM or VT) for which the alias is defined.

Using Virtual Terminal

5.2 Using Gateways for Remote OSI Node Access

If you supply an alias that does not exist in the `/etc/isoapplications` file, then the gateway software attempts to establish a CTERM connection with the system specified.

After the VT connection is established to the remote system, it prompts you to log in as usual. The following example shows a user named `nobel` on an OpenVMS system accessing a remote Digital UNIX system with alias `serchr` from the Digital UNIX gateway system `discvr`:

```
$ telnet discvr 
Trying...16.62.96.231
Connected to DISCVR.
Escape character is '^]'.
Digital UNIX (discvr.org.com) (ttyp4)
Login: serchr:: 
Digital UNIX (serchr.org.com) (ttyp1)
Login: nobel 
Password: password  ◆
```

5.2.4 Using the VT/Telnet Gateway

If your network has one or more VT/Telnet Gateways enabled, you can access a remote Internet system that supports the telnet protocol from an OSI system.

OpenVMS

For OpenVMS, the gateway system administrator assigns a unique OSI address to the VT/Telnet Gateway and creates an alias pointing to the gateway. To access the gateway, specify the gateway alias on the VT connect command. ◆

In the following examples, two gateway systems (systems where the VT/Telnet Gateways reside) are used. The name of the OpenVMS gateway system is `intrpd`, and the name of the Digital UNIX gateway system is `discvr`. The alias defined for the VT/Telnet Gateway on the `intrpd` system is `intrpd$telnet`.

OpenVMS

From an OpenVMS system, use the following command to connect to the VT/Telnet Gateway on the OpenVMS gateway system:

```
$ set host/vtp intrpd$telnet 
```

Use the following command to connect to the Digital UNIX gateway system:

```
$ set host/vtp discvr 
```

See Appendix C for more information on the `set host/vtp` command. ◆

UNIX

From a Digital UNIX system, use the following command to connect to the VT/Telnet Gateway on the OpenVMS gateway system:

```
% ologin intrpd$telnet 
```

Use the following command to connect to the Digital UNIX gateway system:

```
% ologin discvr 
```

See Appendix D for more information on the `ologin` command. ◆

Using Virtual Terminal

5.2 Using Gateways for Remote OSI Node Access

OpenVMS

A successful VT connection to the VT/Telnet Gateway application on a OpenVMS gateway system results in a prompt for the remote host name as shown in the following example:

```
Welcome to the VT/Telnet gateway on INTRPD
Enter remote host name:
```

At the gateway prompt, enter the host name of the remote Internet system you want to access. After the telnet connection is established to the remote system, it prompts you to log in as usual. ♦

UNIX

A successful VT connection to a Digital UNIX gateway system results in a login prompt as shown in the following example:

```
Digital UNIX (discvr.org.com) (ttyp4)
login:
```

At the login prompt, enter an "at sign" (@), followed by the host name of the remote Internet system you want to access. The "at sign" indicates that you want to connect using the Telnet Gateway. After the telnet connection is established to the remote system, it prompts you to log in as usual.

Note

The Telnet implementation on Digital UNIX attempts to supply your login ID to the remote Telnet system. This is done on the assumption that a Telnet user would have the same account name on multiple systems.

When the VT/Telnet Gateway makes a Telnet connection to a system that can respond to this feature (for example, another Digital UNIX system), the login ID of the gateway process (usually root or daemon) is sent to the remote system and the first prompt the user sees is for the password. The desired action is that the destination system should prompt for the user ID.

To work around this problem, simply press Return at the password prompt. This causes the destination system to prompt for the login ID again.

The following example shows a user named nobel on a Digital UNIX system accessing a remote Digital UNIX system called serchr from a Digital UNIX gateway system called discvr:

```
% ologin discvr 
Digital UNIX (discvr.org.com) (ttyp4)
Login: @serchr 
Trying...16.63.96.230
Connected to serchr.org.com
Escape character is '^]'.
Digital UNIX (serchr.org.com) (ttyp1)
Login: root
Password: 
root login refused on this terminal.
Login incorrect
Login: nobel 
Password: password  ♦
```

5.2.5 Using the Digital UNIX CTERM/VT Gateway

Note

The CTERM/VT Gateway is not available on OpenVMS; that is, an OpenVMS node cannot act as a CTERM/VT Gateway node. An OpenVMS user can use the CTERM/VT Gateway on a Digital UNIX system by using the set host command.

If your network has one or more CTERM/VT Gateways enabled, you can access a remote OSI system that has a Virtual Terminal responder installed from a DECnet system.

In the following examples, discvr is the name of the Digital UNIX gateway system (system where the CTERM/VT Gateway resides).

OpenVMS

From an OpenVMS system, use the following command to connect to the gateway system:

```
$ set host discvr  ◆
```

From a Digital UNIX system, use the following command to connect to the gateway system:

```
% dlogin discvr 
```

Refer to online help for more information on the set host command and see the dlogin(1dn) reference page for more information on the dlogin command.

A successful CTERM connection command to the gateway system results in a login prompt as shown in the following example:

```
Digital UNIX (discvr.org.com) (tty4)  
login:
```

At the login prompt, enter the alias of the remote OSI system you want to access, followed by a double colon (::). The alias must be defined on the gateway system.

The CTERM/VT Gateway is invoked if you supply an alias at the login prompt that is in the /etc/isoapplications file, regardless of the application (FTAM or VT) for which the alias is defined.

If you supply an alias that does not exist in the /etc/isoapplications file, then the gateway software attempts to establish a CTERM connection with the system specified.

After the VT connection is established to the remote system, it prompts you to log in as usual. The following example shows a user named nobel on an OpenVMS system accessing a remote Digital UNIX system with alias serchr from the Digital UNIX gateway system discvr:

```
$ set host discvr   
Digital UNIX (discvr.org.com) (tty4)  
Login: serchr::  
Digital UNIX (serchr.org.com) (tty1)  
Login: nobel   
Password: password  ◆
```

Using Virtual Terminal

5.2 Using Gateways for Remote OSI Node Access

5.2.6 Using the Digital UNIX VT/CTERM Gateway

Note

The VT/CTERM Gateway is not available on OpenVMS; that is, an OpenVMS node cannot act as a VT/CTERM Gateway node. An OpenVMS user can use the VT/CTERM Gateway on a Digital UNIX system by using the `set host/vtp` command.

If your network has one or more VT/CTERM Gateways enabled, you can access a remote DECnet system from an OSI system.

In the following examples, `discvr` is the name of the Digital UNIX gateway system (the system where the CTERM/VT Gateway resides).

OpenVMS

From an OpenVMS system, use the following command to connect to the gateway system:

```
$ set host/vtp discvr 
```

See Appendix C for more information on the `set host/vtp` command. ♦

From a Digital UNIX system, use the following command to connect to the gateway system:

```
% ologin discvr 
```

See Appendix D for more information on the `ologin` command.

A successful VT connection command to the gateway system results in a login prompt as shown in the following example:

```
Digital UNIX (discvr.org.com) (ttyp4)
login:
```

At the login prompt, enter the node name of the remote DECnet system that you want to access, followed by a double colon (::). After the CTERM connection is established to the remote system, it prompts you to log in as usual.

The following example shows a user named `nobel` on an OpenVMS system accessing a remote Digital UNIX system with node name `serchr` from the Digital UNIX gateway system `discvr`:

```
$ set host/vtp discvr 
Digital UNIX (discvr.org.com) (ttyp4)
Login: serchr::
Digital UNIX (serchr.org.com) (ttyp1)
Login: nobel 
Password: password 
```

5.3 Interoperability Issues With Previous Versions

The following sections discuss interoperability issues with previous versions of Virtual Terminal.

Using Virtual Terminal

5.3 Interoperability Issues With Previous Versions

5.3.1 SEND SYNCH

DECnet-Plus Virtual Terminal Version 1.0 for VAX ULTRIX and for OpenVMS VAX do not properly handle updates to the SY control object, such as with the SEND SYNCH command. The Version 1.0 responder either aborts the Virtual Terminal connection or gives an error if it receives an SY control object update.

5.3.2 VT-BREAK

DECnet-Plus Virtual Terminal Version 1.0 for OpenVMS VAX and for RISC ULTRIX does not support the VT-BREAK service as a responder. The Version 1.0 responder aborts the Virtual Terminal association if it receives a VT-BREAK indication.

DECnet-Plus Virtual Terminal Version 1.0 for VAX ULTRIX does not properly support the VT-BREAK service as a responder. Once the VT-BREAK request has been issued, the VT connection hangs if you attempt to log out. You can terminate the Virtual Terminal association by issuing the quit command from local command mode.

5.3.3 Set Terminal

UNIX

When interoperating with DECnet-Plus Virtual Terminal Version 1.0 for OpenVMS, you must use the DCL `set terminal` command to successfully switch between line mode and character mode, as well to switch into binary mode.

When using the Digital UNIX initiator to communicate with the OpenVMS Version 1.0 responder and when entering the following:

- Line mode, enter the DCL command `set terminal/noecho`
- Binary mode, enter the DCL command `set terminal/eightbit`

When using the OpenVMS Version 1.0 initiator to communicate with the Digital UNIX responder, enter the DCL command `set terminal/eightbit` before entering the `set host/vtp` command. ♦

5.3.4 Telnet/VT Gateway

UNIX

The Telnet/VT Gateway uses the Generalized Telnet profile. This profile is not supported by DECnet-Plus Virtual Terminal for ULTRIX. ♦

Part III

Concepts

General OSI Concepts

Open Systems Interconnection (OSI) is an architecture containing a set of protocols for computer communications. This set of protocols provides rules for behavior that allows computer systems from different manufacturers to communicate. A document called the OSI Reference Model defines the OSI architecture.

An open system is a computer system that contains implementations of the seven layers of the OSI Reference Model.

The FTAM and Virtual Terminal software conforms to all seven layers of the OSI model and contains the top three layers, as follows:

- The Application layer

The Application layer contains the application programs and supporting protocols that use the lower layers in performing different functions. The functions, or **service elements**, that are important for the FTAM and VT software are:

- The File Transfer, Access and Management (FTAM) service element

The FTAM service element views files in standard terms that allow open systems to transfer, access, and manage remote files.

- The Virtual Terminal service element

The VT service element allows communication between terminals of different types through the use of local mapping.

- The Association Control Service Element (ACSE)

ACSE starts and stops communications links (called associations) between corresponding processes on open systems. ACSE operates on behalf of specific application service elements, including the FTAM and VT service elements.

- The Presentation layer

The Presentation layer organizes the encoding of information being sent and the decoding of information being received.

- The Session layer

The Session layer structures and controls communications and data transfer.

OSI communications depend on international standards that are developed under the auspices of the International Organization for Standardization (ISO). Each OSI standard defines a protocol (a set of rules for communication), a set of services (for specific functions), or both within a functional layer of the OSI Reference Model. Table 6–1 identifies the OSI standards that the FTAM and VT software implements.

General OSI Concepts

Table 6–1 Summary of Principal ISO Standards Implemented

OSI Component	ISO Identifier	Topic of Standard
FTAM	ISO 8571	FTAM concepts, virtual-filestore model, services, and protocol
Virtual Terminal	ISO 9040	VT services
	ISO 9041	VT protocol
ACSE	ISO 8649	ACSE services
	ISO 8650	ACSE protocol
Presentation	ISO 8822	Presentation services
	ISO 8823	Presentation protocol
Session	ISO 8326	Session services
	ISO 8327	Session protocol

The remainder of this chapter introduces a number of general OSI concepts.

6.1 Protocols

A **protocol** is a set of operational rules and procedures for communication. Protocols govern the behavior of open systems at each layer. Some layers, including the Application layer, have several protocols.

The software that implements a protocol is called a **protocol machine**. The application software contains either the FTAM or VT protocol machines. Both are dependent upon OSAK (OSI Application Kernel) for the following underlying protocol machine components: ACSE, Presentation, and Session.

6.2 Dialogue

Much as diplomatic protocols aid human communications, OSI protocol machines ensure that open systems can establish message exchanges called **dialogues**. Though many dialogues can occur simultaneously, each dialogue is independent of other dialogues. Protocol machines cooperate to conduct a dialogue through a predictable sequence of states. The portion of a dialogue conducted at the Application layer is called an **association**; the portions of dialogues conducted at other layers are called **connections**.

6.3 Entities

Protocol machines operate within system-specific processes. For every dialogue, one or more processes activate the protocol machines of each layer independently. An instance of such protocol-machine activity is called an **entity**. The relationship between processes and entities is implementation specific.

Each entity communicates with equivalent entities on different systems. Such equivalent entities are called **peer entities**.

6.4 Services

A **service** is an interface provided by a service element or a layer for accessing one or more OSI functions. The service element or layer that provides a specific set of services is called the **service provider**. An application program, service element, or layer that uses those services is called the **service user**. A service provider is always on the same system as its service users. In some cases, a service user and its service provider reside in separate layers; for example, the Presentation layer is a service provider for the FTAM service element. In other cases, a service user and its service provider reside within the same layer; for example, ACSE is also a service provider for the FTAM service element.

Each service supports a set of parameters whose values control the functions accessed by the service. Two types of services exist: confirmed and unconfirmed. A **confirmed service** is a service where the service user receives a confirmation service primitive to acknowledge that the service has been performed. The confirmation service primitive might contain information regarding the results of that action. An **unconfirmed service** is a service where the service user does not receive a confirmation service primitive and has no knowledge that the service has been performed.

Each service provider offers a set of services that allows its users to perform communications roles and related responsibilities. For example, FTAM file services perform file transfer, access, and management functions for application processes. Communications services often provide access to the supporting functions of underlying layers. For example, ACSE provides a service for establishing associations (A-ASSOCIATE) to its service users, including FTAM; the A-ASSOCIATE service then accesses the underlying connection services for the ACSE service user. The descriptions of the components in later chapters list the specific services of each component.

6.4.1 Service Primitives

To request or receive indications of a service, peer entities exchange messages called **service primitives**. A service primitive carries parameter values for a specific service. There are two pairs of service primitives: request and indication primitives and response and confirm primitives. The request and indication primitives exist for all services. The response and confirm primitives, however, exist only for confirmed services. Each pair of service primitives generates only one unit of user data (a protocol data unit or PDU).

Request and response primitives originate with service users, which use those primitives to request services and negotiate parameter values. Indication and confirm primitives originate with service providers, which use those primitives to pass on information that comes in for their users.

The service primitives of each service are interdependent and together form that service. Each type of service has a standard set of primitives, which always occur in a standard order. The following descriptions of service primitives appear in the order of their occurrence. The number beside each primitive reflects the order of its origin. The type of the entity (service user or service provider) that generates a primitive appears alongside the primitive.

Both unconfirmed and confirmed services have the following primitives:

1. **Request primitive** — The service user requesting a service (**requestor**) issues a request primitive to a peer service user (the **acceptor**) on another

General OSI Concepts

6.4 Services

open system. This results in the exchange of information between the peer entities.

2. **Indication primitive** — On encountering an incoming request, the acceptor's service provider generates an indication primitive to pass the request on to the acceptor.

Only confirmed services have the following service primitives:

3. **Response primitive** — For a confirmed service, an acceptor issues a response primitive to the requestor confirming the information that the acceptor will accept or decline to perform a service.
4. **Confirm primitive** — On encountering an incoming response primitive, the responder's service provider generates a confirm primitive to pass the response on to the requestor.

Figure 6–1 illustrates the movement of the service primitives between service users and providers.

Figure 6–1 Movement of Service Primitives Between Service Users and Providers

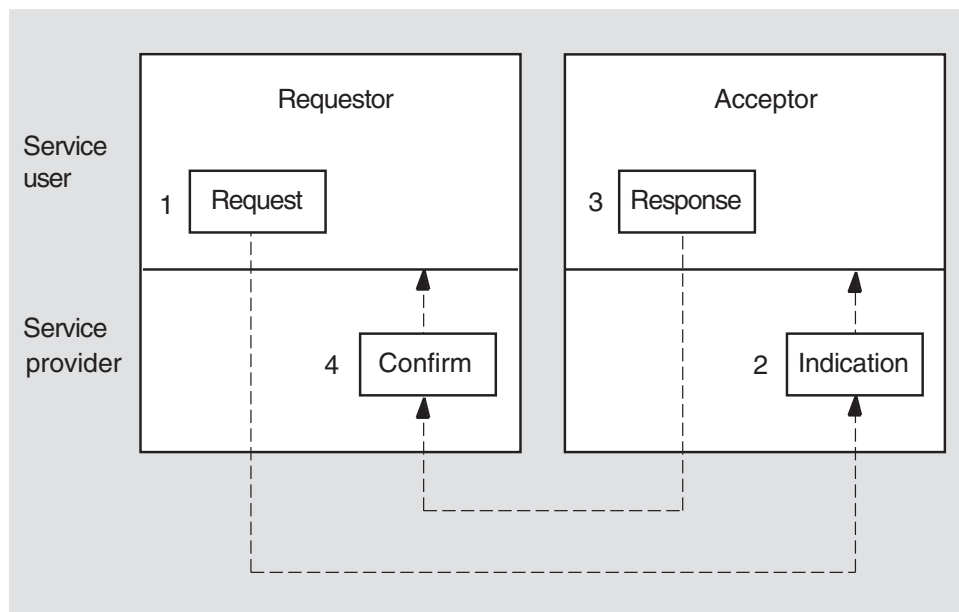

LKG-4435-93R

Before passing parameter values to a protocol machine, a service implementation verifies whether the parameter values proposed by its service user conform to constraints created by the service definition and the current dialogue.

6.4.2 Service Access Points

A service provider delivers services to a service user at an interface called a **service access point (SAP)**. Figure 6–2 illustrates the relationship of a service user, a service provider, and a SAP.

Figure 6–2 Relationship of a Service User, Service Provider, and SAP

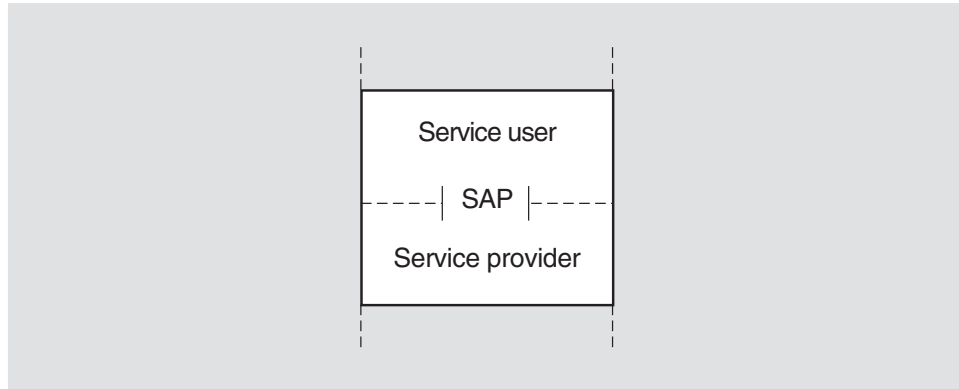

LKG-4436-93R

Except for the Application and Physical layers, SAPs exist at the boundaries of all OSI layers. SAPs are designated by using the name of their layer; for example, any SAP that the Presentation layer provides is called a Presentation SAP (PSAP). Figure 6–3 illustrates SAP nomenclature.

Figure 6–3 SAP Nomenclature

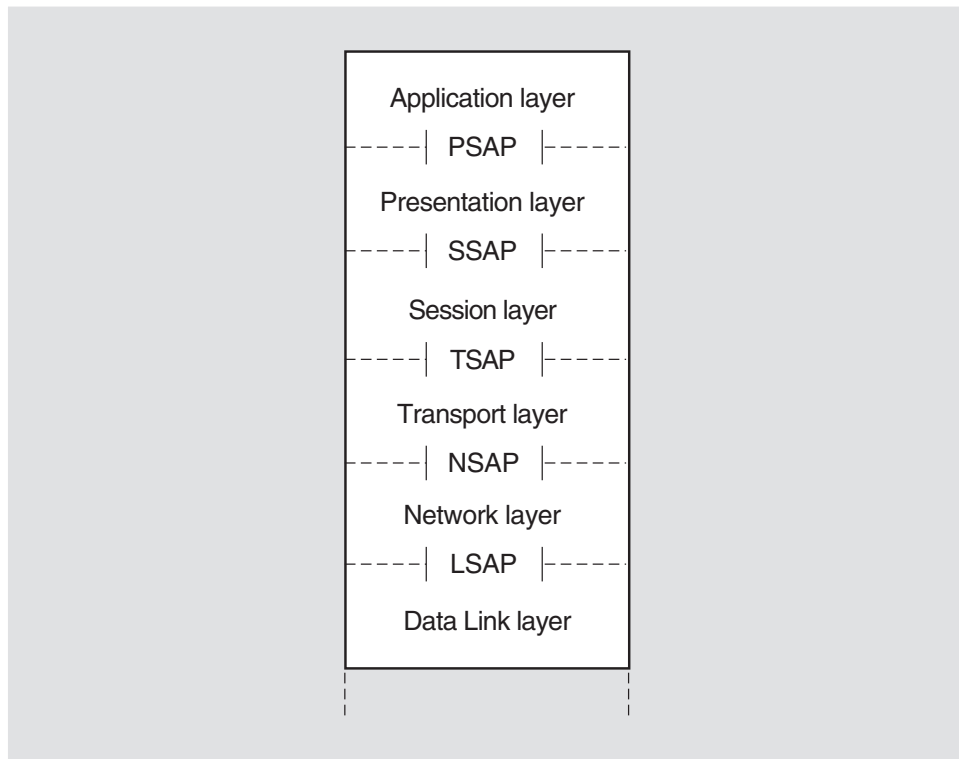

LKG-4437-93R

General OSI Concepts

6.4 Services

SAPs are logical constructs defined by an identifier called a SAP selector. To create a SAP, a system manager or application user defines a unique SAP selector for a specific layer. SAP selectors are the building blocks of the addresses. A given address takes the name of the uppermost SAP that contributes a selector to the address. For example, a presentation address accesses the Application layer. A **presentation address** (p-address) contains one or more SAP selectors at the upper layers. The composition of a given address depends on the purpose of the address. For example, an address that allows the Transport layer to access the Application layer contains SAPs at three layers: Transport, Session, and Presentation. A p-address is used for upper-layer addressing and contains SAPs at four layers: Network, Transport, Session, and Presentation.

6.4.3 Functional Units

To help negotiate services between peer entities, service elements or layers classify their services into functional units. A **functional unit** is a predefined set of interdependent services, which together perform a high-level function such as transferring data. Session, Presentation, ACSE, VT, and FTAM all have functional units. When establishing connections or associations, an entity requests one or more specific functional units of a peer entity. The peer can accept requests only for functional units that it supports.

6.5 Protocol Control Information (PCI)

For each layer or service element, service definitions describe the parameters of each primitive and the valid values for each parameter. The protocol describes the rules and procedures for using service primitives. A protocol machine ensures that a dialogue progresses along the predictable, controlled course that is defined in the state tables of the protocol specification. The parameters in a service primitive are conveyed as **protocol control information** (PCI), which determines how a service operates. Exchanging PCI allows peer entities to specify services and establish their parameter values.

6.6 Syntaxes

Local descriptions of data vary among different systems. For example, some systems use ASCII to represent text, while others use EBCDIC. Overcoming differences between local data descriptions requires an intermediate descriptive method that can transform local data into a commonly understood format. Syntaxes fulfill this requirement for open systems using applications such as FTAM.

A **syntax** is a form of description. Exchanging data between open systems requires two types of syntaxes: abstract syntaxes and transfer syntaxes.

- An **abstract syntax** is a high-level description written in a descriptive language called **abstract syntax notation**, which provides a standard means of describing concepts and data types. The FTAM standard, for example, formally describes FTAM file structure and protocol as abstract syntaxes.
- A **transfer syntax** is a set of rules and, possibly, conditions for formatting data for transmission between systems. For example, it specifies how text is represented when sent as protocol control information.

Transferring data requires applying the rules of abstract and transfer syntaxes to encode and decode data between a local and a transformed format. **Local data** includes any data stored locally by a system; for example, file data or the system information that maps to ISO service parameters. **Transformed data** is a stream of octets (bytes) that can pass over the communications line as a pattern of bits that a peer entity can interpret correctly.

Whenever two application entities use an abstract syntax, they must agree on a specific transfer syntax. The resulting pair of abstract and transfer syntaxes is called a **presentation context**. A presentation context controls how peer entities transform data. A given association can use several presentation contexts to transfer different types of PCI and file data.

In an operation called **syntax transformation**, Presentation uses the rules of the negotiated presentation context (abstract and transfer syntaxes) to interpret incoming data and encode outgoing data.

Figure 6–4 illustrates the encoding and decoding phases of syntax transformation.

Figure 6–4 Syntax Transformation

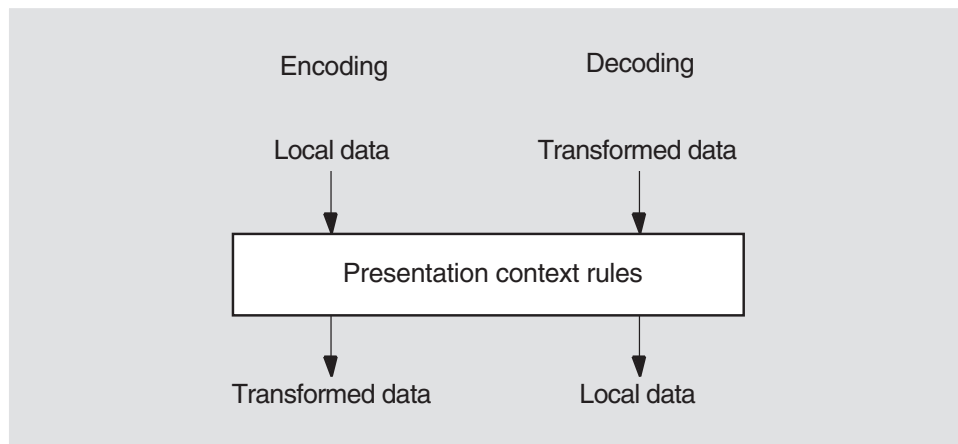

LKG-4438-93R

For writing abstract syntaxes, ISO has a standard notation called **Abstract Syntax Notation One (ASN.1)**. ASN.1 provides a set of data types (for example, boolean and integers) and the means to arrange them into finite constructions such as bounded sequences and sets. ASN.1 has a corresponding transfer syntax named the **Basic Encoding Rules for ASN.1**.

Other abstract-syntax notations or transfer syntaxes are potentially possible, but the FTAM and VT software uses only ASN.1 and its encoding rules.

6.7 Protocol Data Units (PDUs)

A protocol machine places the PCI for a service into a protocol data unit (PDU). A **protocol data unit (PDU)** is information made up of PCI from the current layer and, possibly, user data from above. PDUs are exchanged between peer protocol machines using service primitives. A given service primitive can correspond to zero, one, or more PDUs. The integrity and identity of a PDU remains intact while it is being exchanged.

General OSI Concepts

6.7 Protocol Data Units (PDUs)

The underlying layer places each PDU received from the above layer into a **service data unit** (SDU). The SDU becomes user data in the PDU of its underlying layer. PDUs remain intact until they arrive at the protocol machine of the peer entity. The peer's protocol machine separates the PCI from user data and processes the PCI. Figure 6–5 shows the relationships among the PCI, user data, SDUs, and PDUs.

Figure 6–5 The Relationship Between PCI, PDUs, User Data, and SDUs

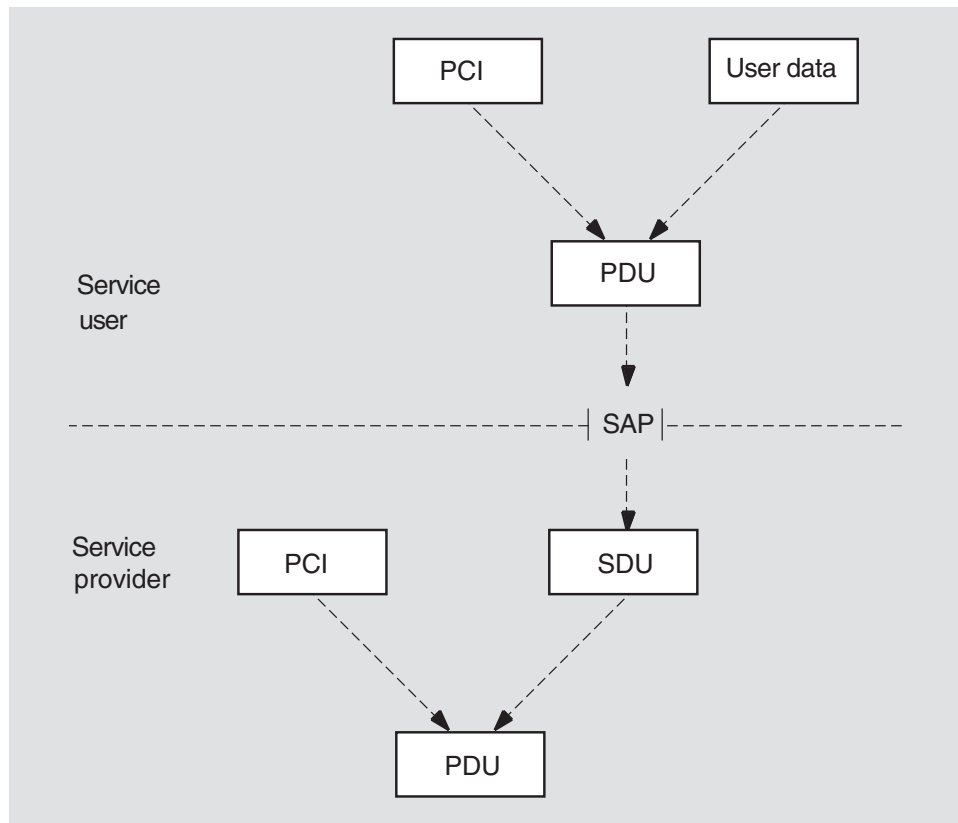

LKG-4439-93R

The Application Layer: FTAM and ACSE

The OSI Application layer consists of application service elements. An **application service element** is an open-system component that provides an application-level function. FTAM is one such service element, and ACSE is another.

7.1 FTAM Application Processes and Entities

Open-system functions occur within the context of system-specific processes. At the Application layer, such processes are called application processes. An **application process** is an interface between an operating system and one or more protocol machines of the Application layer and, possibly, of other layers. An entity involving one or more protocol machines of the Application layer is called an **application entity**.

FTAM defines two basic types of application processes: initiators and responders.

- An **initiator** is an application process that receives requests from users for FTAM functions and activates its system's FTAM and ACSE protocol machines to start FTAM communications.
- A **responder** is an application process that receives incoming communications from an initiator and activates its system's FTAM and ACSE protocol machines to answer.

The FTAM implementation uses one responder and five initiators. The responder handles all incoming FTAM requests. Each of the initiators supports a single type of file operation (append, copy, delete, directory, or rename).

The communications link that occurs at the Application layer between an initiator and a responder is called an **association**. For each association, the initiator and the responder invoke a separate FTAM application entity (FTAM entity). An **FTAM entity** is an instance of activating and using the FTAM and ACSE protocol machines. Within an FTAM entity, the rules and procedures of the FTAM protocol machine control the operation of the ACSE protocol machine.

Each time a user requires an FTAM association, an initiator on the user's system invokes an FTAM entity to request the association. The targeted responder invokes another FTAM entity to answer the initiator's request. Once an association exists, the initiator can request the responder to perform one or more file actions, such as reading or writing file data. The responder handles each request according to its capabilities. An initiator and responder maintain communicating FTAM entities until their association terminates.

For each association, an application process (whether an initiator or responder) invokes a distinct FTAM entity.

The Application Layer: FTAM and ACSE

7.1 FTAM Application Processes and Entities

FTAM entities are identified by an **application-entity title (AE-title)**. As defined for ACSE, an AE-title is an identifier constructed of two other identifiers: an **application-process title (AP-title)** and a unique **application-entity qualifier (AE-qualifier)**. The AP-title identifies an application such as FTAM on the network. The AE-qualifier identifies a specific invocation of that application.

The FTAM software follows the recommendations of the U.S. National Institute of Standards and Technology (NIST) that specify that the AP-title should be an object identifier and the AE-qualifier should be an integer containing up to 255 decimal digits.

7.2 Overview of FTAM Operation

The FTAM service element allows file transfer between, access to, and management of open systems. The File Transfer, Access and Management (FTAM) International Standard (ISO 8571) — the **FTAM standard** — is one of the OSI standards for specific application needs. The FTAM standard specifies structures, functions, services, and communications rules for the FTAM service element.

This section considers the following aspects of the FTAM service element:

1. Basic features of FTAM communications
2. The virtual-filestore model
3. The file-service model
4. The basic file protocol

Manipulating files depends on the interrelated virtual-filestore and file-service models. The basic file protocol controls FTAM services.

7.2.1 Basic Components of FTAM Communications

Two basic asymmetries characterize the roles of FTAM entities during an association: initiator/responder pairs and sender/receiver pairs. The FTAM standard allows FTAM implementations to support either or both of the roles in each pair. The FTAM implementation supports all four roles.

These roles are as follows:

- Initiator/responder pairs

Each association involves one initiator and one responder, each of which invokes and maintains an FTAM entity specifically for that association.

- Sender/receiver pairs

At a given moment during data transfer, file data flows in a single direction. Data transfer requires that when one FTAM entity sends file data, another receives that data. An FTAM entity that is currently writing (sending) part or all of the contents of a file is called the **sender**. An FTAM entity that is currently reading (receiving) all or part of a file's contents is called the **receiver**.

Assuming that an implementation supports both sender and receiver roles, any FTAM entity performs either role. Therefore, both initiators and responders can write and read files. For example, when a user copies a file to another system, the initiator acts as sender; when the user copies a file from another system, the initiator acts as receiver.

7.2.2 Virtual-Filestore Model

A fundamental goal of FTAM is to accommodate a wide variety of file structures and possible actions on files. However, different vendors' file systems often differ substantially in how they organize, store, and access files. The **virtual-filestore model** masks local differences by applying a common generalized description of the structure and attributes of files and the actions on them. By describing a file in terms of the virtual-filestore model, an initiator and a responder can establish a common view of any file. This involves each entity establishing a **virtual filestore**, which is an idealized filestore defined by the virtual-filestore model.

Virtual filestores are mapped to the real filestore of each FTAM system. A **real filestore** is the actual method of data storage and access on a particular system. For example, the real filestore on a Digital UNIX system is provided by the UNIX File System, and for OpenVMS, by the Record Management Service (RMS).

The relationship among the filestores during data transfer is as follows:

1. The sender, using a system-specific portion of its application process, translates the information requested from its system's real filestore into the equivalent structures and file attributes of the virtual filestore.
2. The receiver, reversing the procedure, translates the information from the virtual filestore into whatever equivalent structures and file attributes are meaningful in its system's real filestore.

Figure 7-1 illustrates the relationship among the filestores during data transfer. The sender's real filestore is mapped to a virtual filestore before being sent to the receiver. Once sent, the receiver then maps the virtual filestore to its own entity-specific real filestore format.

Figure 7-1 Relationship Among Filestores During Data Transfer

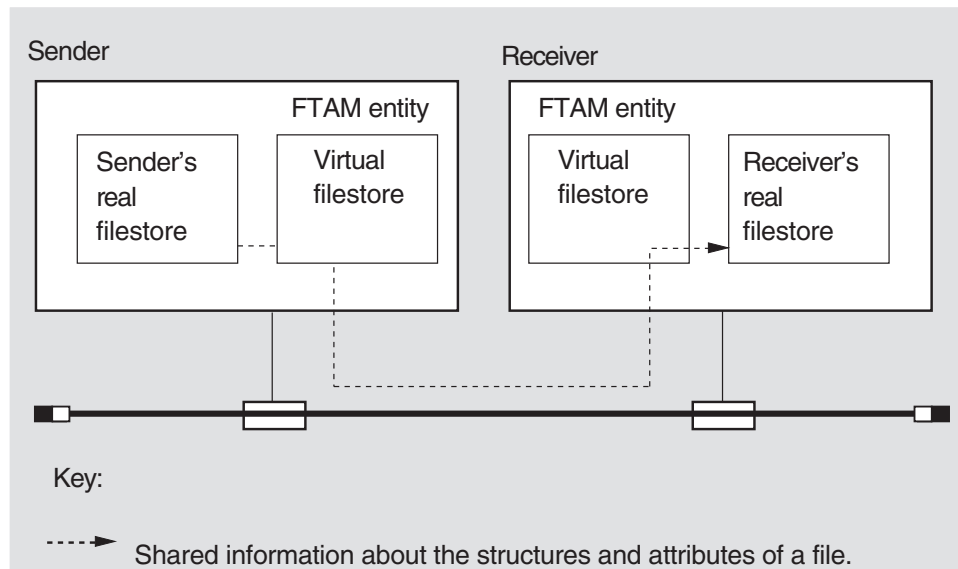

LKG-4441-93R

The virtual-filestore model describes an idealized hierarchical file structure together with its formal properties (file attributes) and possible types of file data (file contents). The model also describes the possible actions on a file (filestore actions). For selecting among these possibilities, the model provides several descriptive mechanisms (access contexts, constraint sets, and document

The Application Layer: FTAM and ACSE

7.2 Overview of FTAM Operation

types). For conveying current information about a file and an association, the model provides a set of descriptive properties (activity attributes). The following sections briefly describe each of these elements of the virtual-filestore model.

7.2.2.1 File Attributes

In the virtual filestore, a file possesses formal properties called **file attributes**, which at a given moment are identical for all users. FTAM file attributes include a range of properties, such as unique file name, access-control specifications, size, history, and structure. The FTAM software partially supports those FTAM file attributes that correspond to UNIX file attributes.

7.2.2.2 File Contents

File contents consist of file data of one or more types. The types of file data most likely to be supported by FTAM implementations are text and binary data — as defined in the FTAM standard and referenced in the U.S. National Institute of Standards and Technology (NIST) OSI implementation agreements. Forming an association or opening a file requires negotiating an abstract syntax and a corresponding transfer syntax for each type of file data. Currently, ASN.1 and Basic Encoding Rules (BER) are the only abstract-syntax notation and transfer syntax required for FTAM implementations.

Actions performed on files within a virtual filestore are called **filestore actions**. Filestore actions are divided between actions on complete files and their attributes (whole-file actions) and actions for accessing file contents (access actions). Whole-file actions operate on files as a unit and allow file selection, file management, and file opening. File-access actions operate on the contents of files, as, for example, reading or writing data during data exchange.

7.2.2.3 File Structure

The virtual-filestore model defines an idealized file structure called the **hierarchical file model**. The hierarchical file model recognizes structural elements called **nodes**, which are ordered into a generalized tree structure. Schematically, this structure is represented as an upside-down tree, with a root node at the top and levels of subordinate nodes beneath. Figure 7–2 shows the schematic structure of a small 3-level tree structure.

Figure 7–2 Schematic Representation of a File Tree

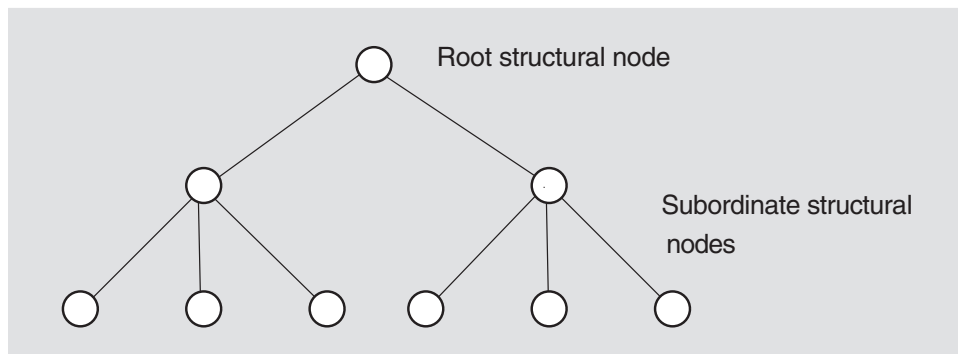

LKG-4442-93R

The hierarchical file model describes file data as being organized into file-contents data units. A **file-contents data unit** is a collection of file data that is associated with a specific node in a file. (Not all nodes, however, have associated file-contents

The Application Layer: FTAM and ACSE

7.2 Overview of FTAM Operation

data units.) A given file contains zero or more file-contents data units. Figure 7–3 illustrates the relation of file-contents data units to structural nodes.

Figure 7–3 Relationship of File Data and Structural Nodes

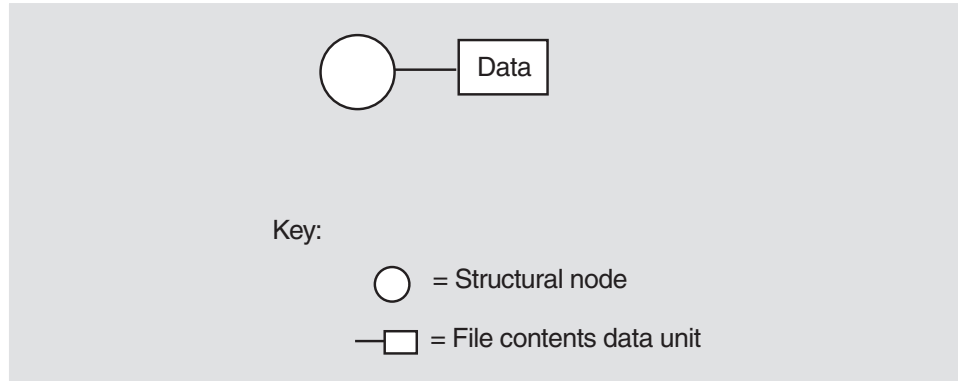

LKG-4443-93R

Files are divided into units called file-access data units. A **file-access data unit (FADU)** is a data structure that is made up of one or more nodes and their associated file-contents data units. A FADU includes either a whole file tree or a specific segment of a file tree (subtree). Potentially, any node can be the entry point of a FADU that encompasses the entry node and all of its subordinate nodes. Figure 7–4 illustrates a possible segmentation of nodes (and their associated file-contents data units) into series of FADUs of decreasing size.

The Application Layer: FTAM and ACSE

7.2 Overview of FTAM Operation

Figure 7–4 Division of a File into File-Access Data Units (FADUs)

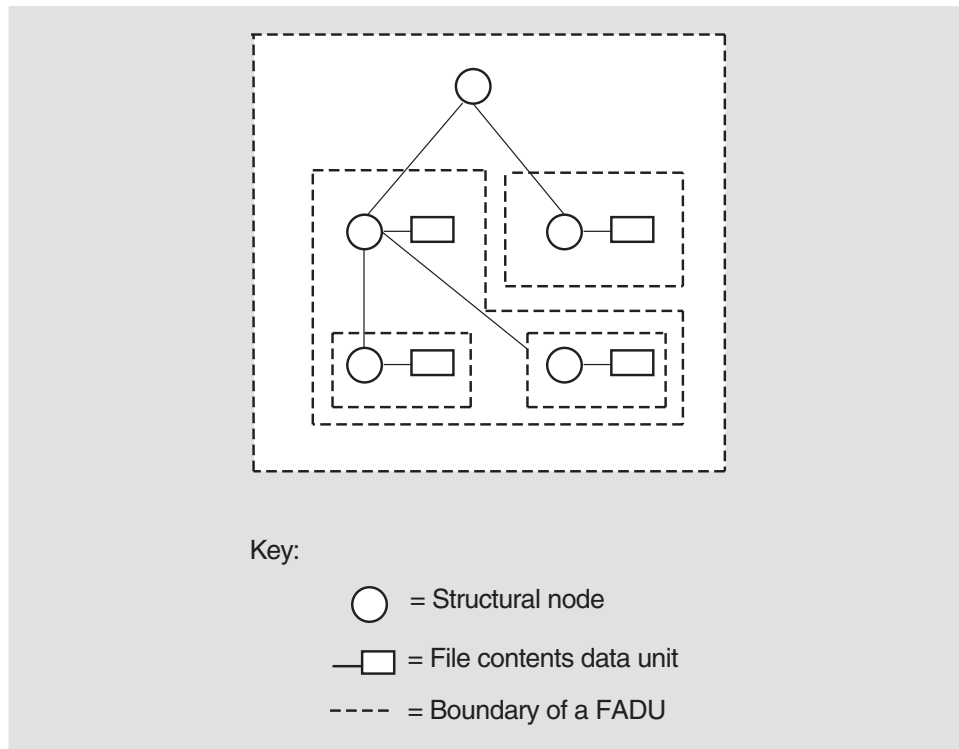

LKG-4444-93R

As the examples of file structures in Figure 7–5 show, the hierarchical file model accommodates a wide range of actual file structures: for example, unstructured, sequential, and hierarchical file structures. An unstructured file has a single node; binary files are often unstructured. A sequential file has an entry node and, directly below it, one or more subordinate nodes; for example, text files are often sequential and each node could represent a separate text record. A hierarchical file has two or more levels of subordinate nodes below its root node.

Figure 7-5 Examples of File Structures

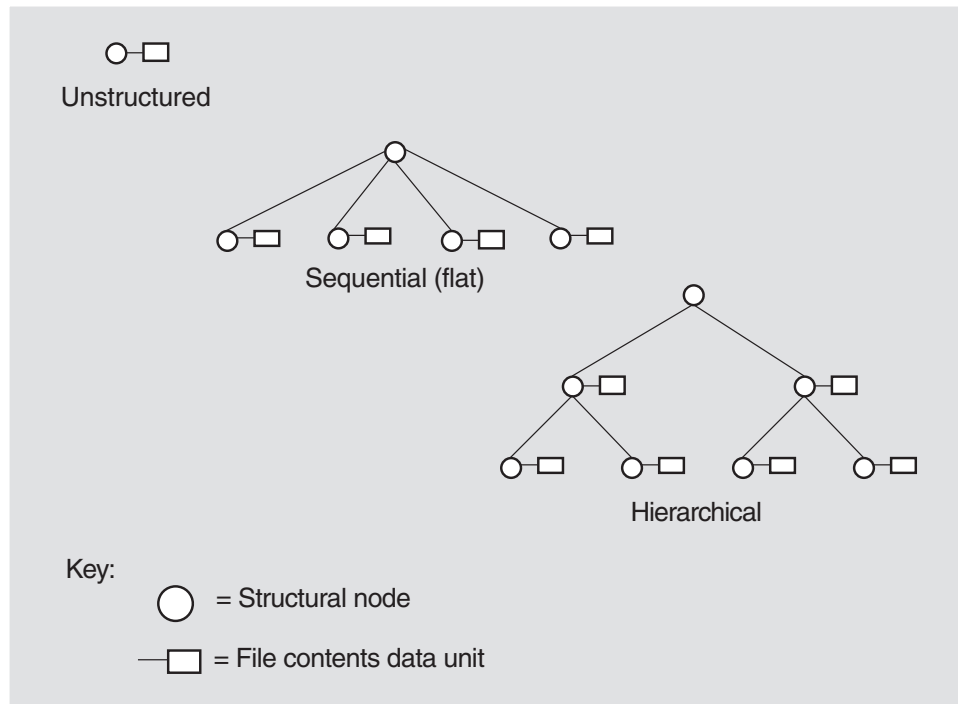

LKG-4445-93R

7.2.2.4 Access Contexts

To provide alternative views of a particular file structure during file reading, the virtual filestore model defines a series of access contexts. An **access context** is a statement of what structural elements (nodes) and associated file data (file-contents data units) are currently needed for reading or writing. Specifying an access context lets an initiator limit the types of information that a sender must handle. Access contexts thereby avoid wasted effort for the sender. For example, you can send the data units from a flat file without the node information by specifying the appropriate access context.

7.2.2.5 Constraint Sets

A **constraint set** is a set of related statements delimiting how filestore actions can proceed and how FTAM entities view file structure and contents during those actions. Among other things, constraint sets, as defined by both ISO 8571 and the NIST OSI Implementors Workshop (OIW) FTAM agreements, specify available access contexts and possible file-access actions (see the next section). Opening a file requires the initiator to specify a constraint set by selecting either a contents type (an abstract syntax and constraint set pair) or a document type (see the next section). The FTAM software uses document types exclusively.

7.2.2.6 Document Types

A **document type** is an officially registered definition of a file type. The FTAM software uses the convention of FTAM document types to describe a file. Document types have been defined by both ISO 8571 and the NIST OSI implementation agreements. The division of an actual file into FADUs depends on the file's document type and on the current access context.

The Application Layer: FTAM and ACSE

7.2 Overview of FTAM Operation

Document type definitions reflect the virtual-filestore model. Each document type consists of a set of related statements about the structure and contents of a file and about the available access procedures. Some of the statements relate to the intended use of the file; others describe factors such as its structure, scope, abstract syntax for file data, a constraint set to be used with the file, qualifications placed on filestore actions, and so forth.

According to its structure and contents, each file has a specific document type, which never changes. Declaration of a document type compensates for the absence of a common FTAM file-description language. The FTAM software supports a subset of the document types defined in the FTAM standard (ISO 8571-2) and the NIST implementation agreements. Table 7-1 shows the supported document types.

Table 7-1 Supported Document Types

Name	Description
FTAM-1	Unstructured text files
FTAM-2	Sequential text files
FTAM-3	Unstructured binary files
NBS-9	NBS file directories
INTAP-1	INTAP record files *

*OpenVMS only.

7.2.2.7 Activity Attributes

Activity attributes are descriptive properties whose values portray the conditions of an association. As conditions change, the values of activity attributes change.

Activity attributes assign values to FTAM properties that express FTAM concepts. The value of any activity attribute is meaningful on a given open system only if that attribute corresponds to an actual property of the system's real filestore. Some activity attributes convey information about the initiator: for example, its identity and address. Some activity attributes define a specific instance of the virtual-filestore model: for example, the current value of file attributes. Still other activity attributes convey current information about the regime (and any nested regime): for example, the current location.

7.2.3 File-Service Model

The **file-service model** is a description of the communications features that support filestore actions. The file-service model defines services. (For an overview of service concepts, see Section 7.2.3.2.) The model also defines intervals of FTAM communications called regimes, each of which accommodates a distinct set of file services.

7.2.3.1 Regimes

A **regime** is an interval during which communicating FTAM entities share a common state that accommodates a distinct set of file services. FTAM regimes and their purposes are as follows:

1. The **FTAM regime** controls the binding of two FTAM entities to an association.

The Application Layer: FTAM and ACSE

7.2 Overview of FTAM Operation

2. The **file-selection regime** describes the procedure by which an initiator selects and deselects a file. The selection process allows an initiator to create a file and then select it. The deselection process allows an initiator to deselect or delete a file.

An initiator can select only one file at a time. However, after deselecting a file, the initiator may be able to select another file during an ongoing FTAM regime. Where available, this capability enables manipulation of a series of files during a single FTAM regime. Note that for the FTAM software, each FTAM command initiates a unique association and file-selection regime.

3. The **file-open regime** controls access to the contents of a currently selected file.
4. The **data-transfer regime** controls data transfer. A sequence of read, write, or both read and write data-transfer regimes is possible during a given open regime.

Regimes are nested within one another in the same order in which they have just been listed. Figure 7–6 illustrates this nesting order.

Figure 7–6 Nesting of FTAM Regimes

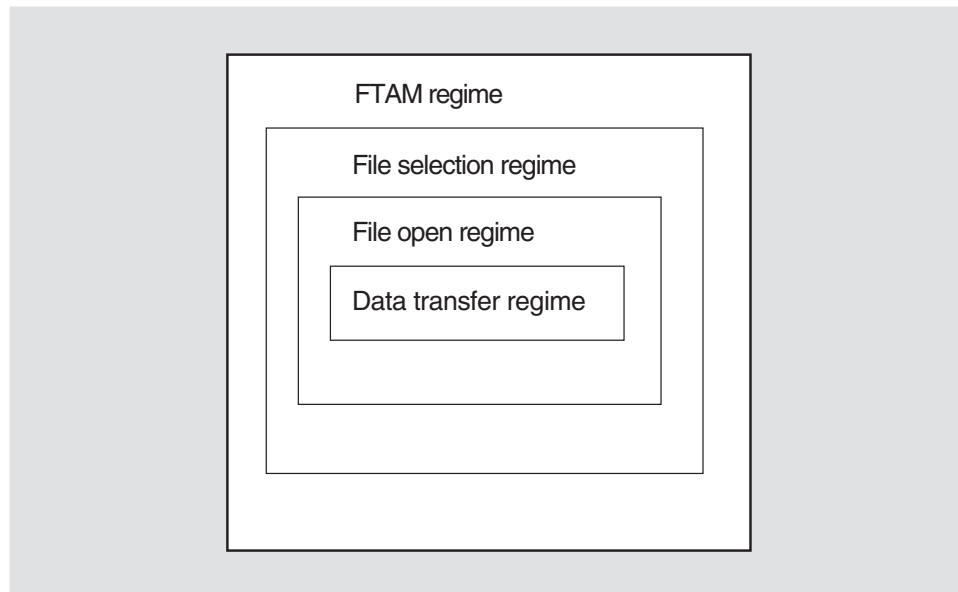

LKG-4446-93R

An FTAM regime is always the first to be formed and the last to be terminated. Normally, each regime persists until any nested regime ceases, thereby ensuring that files receive predictable and orderly treatment.

7.2.3.2 FTAM Services

FTAM services are interfaces that access functions of FTAM's service providers and of peer FTAM entities. The FTAM standard defines services both for basic communications functions (such as starting or stopping data-transfer activities) and for filestore services (such as opening and closing files, reading file attributes, and reading or writing data).

The Application Layer: FTAM and ACSE

7.2 Overview of FTAM Operation

Table 7–2 shows the FTAM services. Some FTAM services are optional for FTAM implementations.

Table 7–2 FTAM File Services

FTAM File Service*	Source	Type†	Explanation
F-BEGIN-GROUP	Initiator	Conf.	Signals the beginning of a set of grouped service primitives within a regime that the responder must process together.
F-CANCEL	Either‡, as sender or receiver	Conf.	Cancels a data-transfer activity.
F-CHANGE-ATTRIBUTE	Initiator	Conf.	Modifies the file attributes of a selected file.
F-CLOSE	Initiator	Conf.	Releases the regime established by the F-OPEN service.
F-CREATE	Initiator	Conf.	Either creates a specified file and then selects that file or selects an existing file; also binds the selected file to the FTAM regime.
F-DATA	Either†, as sender	Unconf.	Transmits bulk file data from an opened file.
F-DATA-END	Either†, as sender	Unconf.	Indicates completion of a data transfer (by sender).
F-DELETE	Initiator	Conf.	Releases the binding between an FTAM regime and a specified file in such a way that the selected file ceases to exist.
F-DESELECT	Initiator	Conf.	Releases the binding between an FTAM regime and a specified file.
F-END-GROUP	Initiator	Conf.	Signals the end of a set of grouped services. The responder begins processing the grouped services after receiving an F-END-GROUP indication.
F-ERASE	Initiator	Conf.	Removes a specified FADU from an opened file.
F-INITIALIZE	Initiator	Conf.	Creates and binds an FTAM regime to an association between two FTAM entities.
F-LOCATE	Initiator	Conf.	Locates a specified FADU of an opened file.
F-OPEN	Initiator	Conf.	Establishes the processing mode, presentation contexts, and concurrency controls for data transfer or access for a selected file.
F-P-ABORT	Any service provider	Unconf.	Dissolves unconditionally an FTAM regime and its binding to an association.
F-READ	Initiator	Unconf.	Initiates a bulk data transfer from the responder (in the role of sender) to the initiator (in the role of receiver).

*For information on which services are supported, refer to the conformance statement in the Software Product Description.

†Confirmed or unconfirmed.

‡Initiator or responder.

(continued on next page)

The Application Layer: FTAM and ACSE

7.2 Overview of FTAM Operation

Table 7–2 (Cont.) FTAM File Services

FTAM File Service*	Source	Type†	Explanation
F-READ-ATTRIBUTE	Initiator	Conf.	Reads the file attributes of the currently selected file.
F-SELECT	Initiator	Conf.	Selects an existing file and binds it to the FTAM regime.
F-TERMINATE	Initiator	Conf.	Gracefully dissolves an FTAM regime and unbinds it from its association.
F-TRANSFER-END	Initiator	Conf.	Confirms completion of a data transfer.
F-U-ABORT	Initiator or responder	Unconf.	Dissolves unconditionally an FTAM regime and its binding to an association.
F-WRITE	Initiator	Unconf.	Initiates a bulk data transfer from the initiator (in the role of sender) to the responder (in the role of receiver).

*For information on which services are supported, refer to the conformance statement in the Software Product Description.

†Confirmed or unconfirmed.

When negotiating a service, FTAM entities exchange FTAM service primitives that carry FTAM PCI data as parameters. Some parameters carry association-specific information, such as the identities of the FTAM entities or action results. Other parameters carry protocol-specific information, such as the active values for file attributes and permitted filestore actions (both for the initiator and for concurrent users).

7.2.3.3 Relationship of Services to Regimes

Except for the grouping services, each service always occurs within a single type of regime. Furthermore, each constituent service of a regime occurs during a specific phase of the regime. The only other exceptions are the F-P-ABORT and F-U-ABORT services, which can occur at any time once the FTAM regime is established. Figure 7–7 shows the general relationship of services to their regimes.

The Application Layer: FTAM and ACSE

7.2 Overview of FTAM Operation

Figure 7-7 Relationship of File Services to Regimes

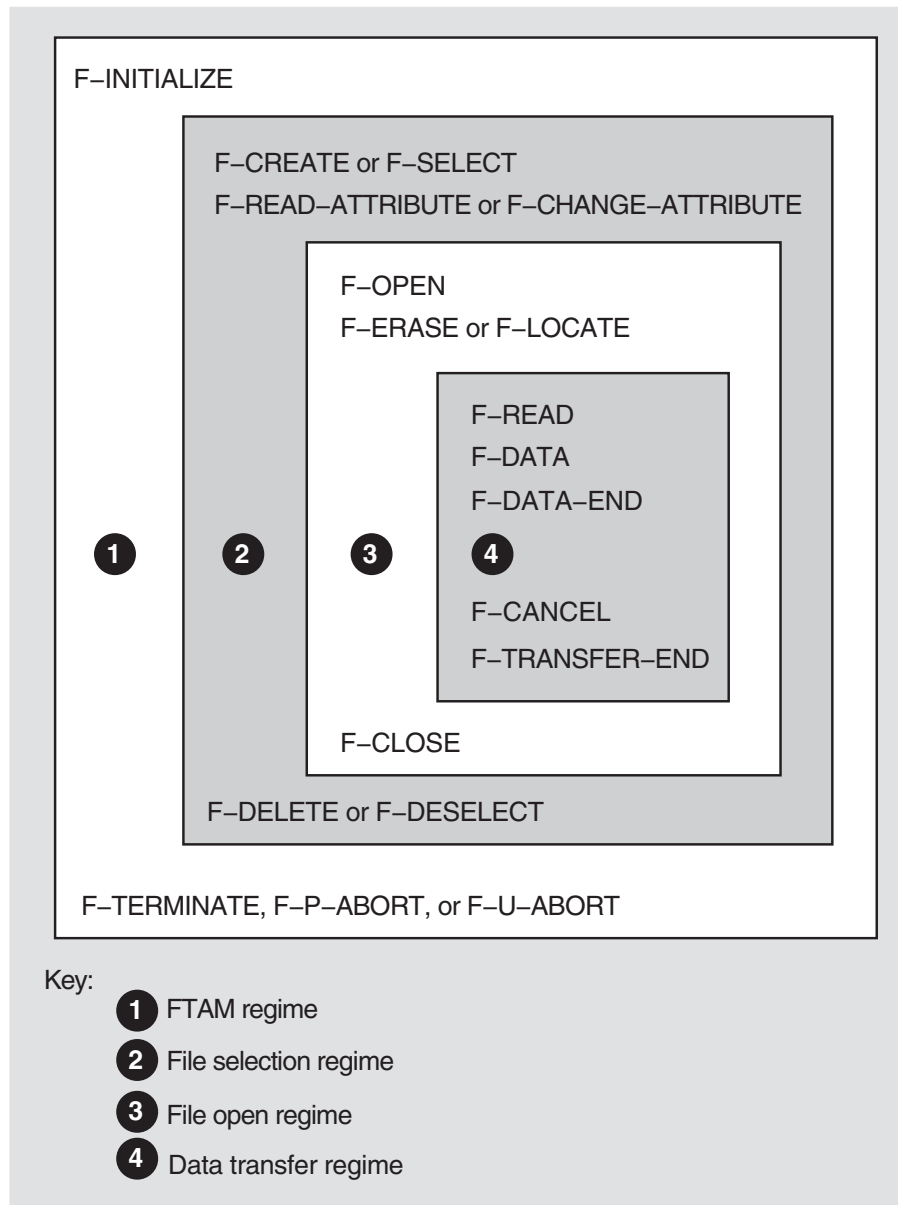

LKG-4447-90R

7.2.4 The FTAM File Protocol

The FTAM file protocol implements a series of operational rules that govern the FTAM communications and the operations of file services during an association. These rules are implemented by the FTAM protocol machine (FPM). Acting for an initiator, the FPM issues request service primitives, and acting for a responder, the FPM issues indication service primitives.

The FPM ensures that a requested progression of valid file services occurs.

7.2.5 Summary of the FTAM Operation Overview

In summary, FTAM associations involve asymmetrical communication between two FTAM entities (an initiator and a responder). The initiator and responder implement the virtual-filestore and file-service models to communicate about and manipulate files. The basic elements of each model are as follows:

- Virtual-filestore model

The virtual-filestore model defines a hierarchical file model with its essential file structures and a set of possible filestore actions. Document types help FTAM entities communicate about file structures and filestore actions.

- File-service model

The file-service model defines the available FTAM services, the service parameters carried by each service primitive, the sequencing of file services into standard regimes, and the activity attributes that dynamically describe the current conditions of a regime, a file, the virtual filestore, and the initiator.

- The file protocol

The file protocol defines the communications rules that permit the exchange of file information between open systems. These rules are implemented by software called the FTAM protocol machine (FPM).

The interplay among the elements of the virtual-filestore and file-service models and the protocol machines allows open systems to build common views of each other's files and to act on each other's files in controlled, mutually understood ways.

7.3 Overview of ACSE

The Association Control Service Element (ACSE) contributes to every FTAM entity. ACSE is a service provider to the FTAM service element. The ACSE protocol and services provide facilities for establishing and releasing associations between any application entities.

7.3.1 Establishing an Association

For each association, ACSE establishes an application context. An **application context** is an explicitly identified set of one or more application service elements (in this case, FTAM), related options, and any other necessary information or rules for an association.

When requesting an association, the FTAM protocol machine supplies the information that the FTAM regime requires. Using an association-establishment service (A-ASSOCIATE), ACSE passes this information down to the Presentation layer as user information in a connection request. Presentation then specifies it as user information to Session.

The resulting presentation and session connections have a one-to-one correspondence to the association. A-ASSOCIATE also carries parameters that affect the behavior of Presentation and Session for the current connection. For example, A-ASSOCIATE negotiates which Session functional units are available during a connection.

The Application Layer: FTAM and ACSE

7.3 Overview of ACSE

7.3.2 Terminating an Association

When the FTAM initiator issues an F-TERMINATE request, ACSE submits an A-RELEASE request to the Presentation release (P-RELEASE) service. This is a confirmed service. If the negotiated-release functional unit is negotiated, the acceptor can refuse the release. Data in transit is preserved.

7.3.3 ACSE Services

As a very specialized service element, ACSE has only four services, which deal exclusively with starting and stopping associations. Table 7–3 lists these services.

Table 7–3 ACSE Services

ACSE Service	Type*	Explanation
A-ASSOCIATE	Conf.	Initiates an association by those application-service-element (ASE) procedures identified by the application-context-name parameter; submits requests to the underlying presentation connection service (P-CONNECT).
A-RELEASE	Conf.	If successful, causes the completion of the use of an association using those ASE procedures identified by the application context. Preserves the data during transit.
A-ABORT	Unconf.	Causes the abnormal release of the association with the possible loss of information in transit; submits requests to the underlying presentation-user abort service (P-U-ABORT).
A-P-ABORT	Unconf.	Indicates the abnormal release of the association as a result of action by the underlying presentation service with the possible loss of information in transit; receives indications from the underlying presentation-provider abort service (P-P-ABORT).

*Confirmed or unconfirmed.

Introduction to Presentation and Session Layers

Presentation and session entities provide the presentation and session connections. To form an association, FTAM and Virtual Terminal entities require a corresponding presentation entity and session entity. For the FTAM and VT software, these presentation and session entities occur within the same process as the FTAM and VT entities.

The combined effect of the presentation and session entities is to manage data transfer for application entities. For OSI applications, such as FTAM or VT, Presentation handles syntax transformation. Presentation also establishes presentation contexts and manages them if necessary. Presentation and Session both perform connection management functions for their own connections. Session also transfers information and manages each dialogue between peer application entities. Presentation supports this use of Session services by providing the Application layer with a set of services that correspond to the data-transfer and dialogue-management services of the Session layer.

This chapter considers each of these tasks and the services that perform them.

8.1 Context Management (Presentation)

Before data exchange can occur, a connection must have at least one presentation context. A **presentation context** is a pair of abstract and transfer syntax names. An initiator specifies the names of one or more abstract syntaxes. Presentation then negotiates the name of the transfer syntax to be used with each instance of an abstract syntax in a specific presentation context. The FTAM and VT software requires the Basic Encoding Rules for ASN.1 as its transfer syntax.

If a connection has multiple presentation contexts, they can be nested. To ensure the integrity of each presentation context, Presentation offers context-management functions to coordinate negotiations for new presentation contexts during a connection. Note that the FTAM and VT software always establish all of their presentation contexts when establishing an association and do not use context-management functions.

8.2 Connection Management (Presentation and Session)

Both Presentation and Session possess their own connection-establishment and connection-termination services. For each association, the Presentation and Session layers require connections. When forming a connection, ACSE activates the presentation connection-establishment service. In turn, Presentation activates the session connection-establishment service. When negotiating its connection, Presentation also negotiates specialized sets of services (functional units) for both its own connection and for the underlying Session connection.

Introduction to Presentation and Session Layers

8.2 Connection Management (Presentation and Session)

Note that the session-requirements parameter of A-ASSOCIATE determines the functional units that Presentation negotiates.

8.3 Dialogue Control (Presentation and Session)

Session services perform the actual dialogue control. Session segments a dialogue into a series of activities. An **activity** is a specific period during which data exchange can occur. However, the corresponding Presentation services determine the parameter values for a given association. Requests to Presentation for service primitives to manage an association's dialogue invoke a corresponding primitive at the Session layer.

8.4 Information Transfer (Presentation and Session)

Presentation transforms data and sends the transformed data to Session. Session services then manage the actual information transfer.

8.5 Presentation and Session Services

Table 8–1 lists the Presentation and Session services according to the type of function that each service accesses.

Table 8–1 Presentation and Session Services

Service*	Type†	Explanation
Connection Management		
P/S-U-ABORT	Unconf.	Generates a user-initiated abort.
P/S-CONNECT	Conf.	Establishes a connection.
P/S-RELEASE	Conf.	Releases a connection with an orderly (negotiated) end.
P/S-P-ABORT	Unconf.	Generates a provider-initiated abort.
Context Management		
P-ALTER-CONTEXT‡	Conf.	Manages presentation contexts by deleting old contexts, negotiating additional contexts, or both.
Dialogue Control		
P/S-ACTIVITY-DISCARD	Conf.	Allows an activity to be abnormally terminated with the implication that the work so far achieved will be discarded and cannot be resumed; controlled by the major activity token; can cause the loss of session service data units (SDUs).
P/S-ACTIVITY-END	Conf.	Ends an activity and can set a major synchronization point; controlled by the major activity token.

*P/S indicates paired Presentation and Session services; for example, P/S-P-ABORT indicates that both P-P-ABORT (Presentation layer) and S-P-ABORT (Session layer) exist.

†Confirmed or unconfirmed.

‡ P-ALTER-CONTEXT is the only nonpaired service in the Presentation and Session layers.

(continued on next page)

Introduction to Presentation and Session Layers

8.5 Presentation and Session Services

Table 8–1 (Cont.) Presentation and Session Services

Service*	Type†	Explanation
Dialogue Control		
P/S-ACTIVITY-INTERRUPT	Conf.	Allows an activity to be terminated abnormally with the implication that the work so far achieved will be retained and can be resumed; use is controlled by the major activity token; can cause the loss of session SDUs.
P/S-ACTIVITY-RESUME	Unconf.	Indicates that a previously interrupted activity is reentered; use is controlled by the major activity token.
P/S-ACTIVITY-START	Unconf.	Indicates entering a new activity; use is controlled by the major activity token.
P/S-CONTROL-GIVE	Unconf.	Allows a session-service user to surrender all available tokens to a peer session-service user.
P/S-P/S-EXCEPTION-REPORT	Unconf.	Reports unexpected events and possible errors that originate at that layer.
P/S-RESYNCHRONIZE	Conf.	Resynchronizes connections.
P/S-SYNC-MAJOR	Conf.	Uses major synchronization points to restore the appropriate active contexts when the connection is resynchronized or interrupted.
P/S-SYNC-MINOR	Conf.	Uses minor synchronization points to restore the appropriate active contexts when the connection is resynchronized or interrupted.
P/S-TOKEN-GIVE	Unconf.	Relinquishes one or more specific tokens for accessing and employing the corresponding services.
P/S-TOKEN-PLEASE	Conf.	Requests one or more specific tokens for accessing and employing the corresponding services.
P/S-U-EXCEPTION-REPORT	Unconf.	Reports unexpected events and possible errors for a service user.
Information Transfer		
P/S-CAPABILITY-DATA	Conf.	Sends data outside of an activity.
P/S-DATA	Unconf.	Sends user data as normal data that can be subject to token control.
P/S-EXPEDITED-DATA	Unconf.	Sends data that has a higher priority than normal.
P/S-TYPED-DATA	Unconf.	Sends data even when the requestor lacks a normally required token.
<p>*P/S indicates paired Presentation and Session services; for example, P/S-P-ABORT indicates that both P-P-ABORT (Presentation layer) and S-P-ABORT (Session layer) exist.</p> <p>†Confirmed or unconfirmed.</p>		

Part IV

Management

The OSI Application-Entity Database

The FTAM and Virtual Terminal applications require you to manage the OSI application-entity database. This database stores addressing information for aliases that represent FTAM and VT applications and listeners.

9.1 About The OSI Applications Database

OpenVMS

On OpenVMS systems, the location of this file is:

`sys$system:isoapplications.dat` ◆

UNIX

On Digital UNIX systems, the location of this file is:

`/etc/isoapplications` ◆

Two types of information can be stored in the `isoapplications` file:

1. Addressing information about remote applications, local listeners, and source aliases.
2. Information that allows retrieval of the necessary addressing information from the X.500 Directory.

The `isoapplications` file can contain information exclusively from the first category, information exclusively from the second category, or information from both categories.

9.1.1 Support For X.500 Directory Service

The addresses of the local FTAM and VT applications can be registered in the X.500 Directory by means of `dxim`, the DEC X.500 Administration Facility. On Digital UNIX, you can do this by means of the `/usr/sbin/osiapplsetup` procedure. On OpenVMS, you must register these applications manually.

If you want to configure the FTAM and Virtual Terminal software to work in conjunction with the X.500 Directory, then you must have the base component of the DEC X.500 Directory Service product installed on your system.

OpenVMS

On OpenVMS, you must choose the "base kit" component from the DEC X.500 Installation menu. ◆

UNIX

On Digital UNIX, you must install the `DXDATABASE nnn` (DEC X.500 base) subset, where nnn is the product version number. ◆

Configuring FTAM and VT to retrieve addressing information from the X.500 Directory is optional. The FTAM and VT software does not require that the DEC X.500 Directory Service software be installed for FTAM and VT to work properly.

The rest of the documentation assumes that you are familiar with basic X.500 concepts and terminology. For additional information on the X.500 Directory, or Digital's X.500 Directory Service, refer to *DEC X.500 Directory Service Management*.

The OSI Application-Entity Database

9.1 About The OSI Applications Database

9.1.2 Updating isoapplications

The `isoapplications` file is readable by all, but it can be written to only by a privileged user. The database entries can be modified using any text editor, or on Digital UNIX you can use the `/usr/sbin/osiapplsetup` procedure. For information on the `/usr/sbin/osiapplsetup` procedure, see Chapter 12.

The entries in the `isoapplications` database must conform to the Address, Distinguished Name, or Pattern formats. See Section 9.2 for information on these formats.

9.2 Entry Formats in isoapplications

Every entry in `isoapplications` has one of three formats:

- Address format
- Distinguished Name format
- Pattern format

Each format of entry contains an alias field and an application-name field. An **alias** is a short name that refers to an instance of FTAM or VT on a particular system. In the `isoapplications` file, the alias expands either to a full OSI address, or to an X.500 Distinguished Name. Aliases do not have to be unique in `isoapplications`.

The aliases used in `isoapplications` do not have to correspond to node names since they are already references to applications that reside on a node. Also, users specify these aliases within commands; therefore, a brief alias name is easier to use.

The order of the entries in `isoapplications` is significant. Section 9.4 describes in detail how the entries are used to generate an address for a local listener or remote FTAM or VT application.

Aliases may not contain the following characters:

```
# - pound sign
\ - backslash
/ - slash
: - colon
```

The value of the application-name field indicates the OSI Application with which the entry is associated. The value of this field is either FTAM or VT.

9.2.1 The Address Format

Entries of the Address format support the first category of information mentioned in Section 9.1.

Entries of the Address format take the following form:

```
alias :application-name:ap-title:ae-qualifier:psel.ssel.tsel.nsap,transport_options;
                                           nsap,transport_options;
                                           :
                                           nsap,transport_options:
```

A field that is not required can be omitted, but the delimiters (:) must be included. For example, if `ap-title` is not required, the following entry for FTAM can be specified:

```
remote_system :FTAM:::psap.ssap.tsap.%x4145418715004108002B0DC29621:
```

The OSI Application-Entity Database 9.2 Entry Formats in isoapplications

For VT, the following entry can be specified:

```
remote_system :VT:::psap.ssap.tsap.%x4145418715004108002B0DC29621:
```

The following characters have special purposes in the database:

- The pound sign (#) is used for comments and can be located anywhere in the file.
- The backslash (\) is used at the end of a line as a continuation character.

Table 9–1 describes each component in the Address format entry.

Table 9–1 ISO Application-Entity Database Address Format Components

Component	Explanation
<i>alias</i>	Name of the alias that you intend to use when referring to a system. The alias must be delimited from the other fields with a colon. This field is mandatory.
<i>application-name</i>	Name of the OSI application that will use the address. This component of the entry allows the same alias to be used for multiple applications. Thus, the alias <i>serchr</i> could appear twice in the <i>isoapplications</i> file, once for FTAM and once for Virtual Terminal. The <i>application-name</i> is FTAM for FTAM, and VT for Virtual Terminal.
<i>ap-title</i>	Application-process title by which the remote application is known (FTAM or VT). This field is optional. Object identifier values are the valid values for this field.
<i>ae-qualifier</i>	Application-entity qualifier that helps to further distinguish the AP-title. This optional field is an integer field.
<i>psel</i>	Presentation service access point selector. This optional value can be any string or hexadecimal value.
<i>ssel</i>	Session service access point selector. This optional value can be any string or hexadecimal value.
<i>tssel</i>	Transport service access point selector. For aliases representing remote systems, this value can be any string or hexadecimal value. The TSEL <i>must</i> be unique for each responder on the local system.
<i>nsap</i>	Network service access point. The NSAP can be either an OSI address or an Internet address. If you use an Internet address, use a 4-byte address followed by a port number. For example, the address could be 120.0.0.1.102, where 120.0.0.1 is the 4-byte address and 102 is the port number. You can find additional information on Internet addresses and port designations in the <i>Digital UNIX System and Network Management Guide</i> . For a remote system, you must ask the manager of the remote system or the network manager for this information. For the local system, use the <code>ncl show osi transport local nsap</code> command as explained in your DECnet-Plus NCL documentation. There is no limitation on the number of NSAPs allowed per alias; however you must specify at least one NSAP per alias.

(continued on next page)

The OSI Application-Entity Database

9.2 Entry Formats in isoapplications

Table 9–1 (Cont.) ISO Application-Entity Database Address Format Components

Component	Explanation									
<i>transport-options</i>	Selectable transport options for each NSAP specified in the database entry. Including transport options information is optional. Enter all transport option names in lowercase letters. The transport options are:									
	<table border="1"> <thead> <tr> <th>Option</th> <th>Value</th> <th>Default</th> </tr> </thead> <tbody> <tr> <td><i>transport-provider</i></td> <td>Either <i>osi</i> or <i>rfc1006</i>. If you specify <i>rfc1006</i>, you must use an Internet address for the NSAP.</td> <td><i>osi</i></td> </tr> <tr> <td><i>transport-template</i></td> <td>The name of the transport characteristics, such as <i>CONS</i>, <i>CLNS</i>, or <i>default</i>.</td> <td><i>default</i></td> </tr> </tbody> </table>	Option	Value	Default	<i>transport-provider</i>	Either <i>osi</i> or <i>rfc1006</i> . If you specify <i>rfc1006</i> , you must use an Internet address for the NSAP.	<i>osi</i>	<i>transport-template</i>	The name of the transport characteristics, such as <i>CONS</i> , <i>CLNS</i> , or <i>default</i> .	<i>default</i>
Option	Value	Default								
<i>transport-provider</i>	Either <i>osi</i> or <i>rfc1006</i> . If you specify <i>rfc1006</i> , you must use an Internet address for the NSAP.	<i>osi</i>								
<i>transport-template</i>	The name of the transport characteristics, such as <i>CONS</i> , <i>CLNS</i> , or <i>default</i> .	<i>default</i>								

Note

The value for the SAP selectors can include character strings or hexadecimal strings. Hexadecimal strings must be preceded by *%x* or *%X* (for example, *%X1010*).

If a particular selector is not required, the delimiter (.) must still be included. For example, if the SSEL is not required, then the format of SAP selectors can resemble the following:

```
PSAP..TSAP.NSAP
```

9.2.1.1 Using Transport Options

FTAM and Virtual Terminal each use the transport options information in the following ways:

- If you specify more than one NSAP with transport options, FTAM and VT attempt to make remote connections to the NSAP and its transport options in the order in which they appear in the ISO application-entity database.
- If you specify a transport template, remember that it points to a network template. It is important that your templates are properly configured. Refer to your Network Management documentation for information about creating templates.

Note

Use the Network Control Language (NCL) *osi transport template* entity to create and manage transport templates.

The following example shows how you can use the *nsap* and *transport-options* components to specify multiple addresses and transport options for a remote FTAM application:

```
remote_system :FTAM::psap.ssap.%x0001.%x4945418715004108002B0DC29621,\  
provider=osi,template=default;%x47004AA000400351121,provider=osi,template=cons;\  
120.0.0.1.102,provider=rfc1006:
```

And for a remote VT application:

```
remote_system :VT::psap.ssap.%x0002.%x4945418715004108002B0DC29621,\  
provider=osi,template=default;%x47004AA000400351121,provider=osi,template=cons;\  
120.0.0.1.102,provider=rfc1006:
```

The following occurs in these examples:

1. The OSI application (FTAM or VT) uses the selectors `psap.ssap.tsap.%x4945418715004108002B0DC29621` over the `osi` provider using the default template to attempt a remote connection.
2. If the connection request fails, the application makes a second remote connection request using `psap.ssap.tsap.%x47004AA000400351121` over the `osi` provider using the `CONS` template.
3. If this second request fails, the application attempts a third remote connection request using address `psap.ssap.tsap.120.0.0.1.102` over the `rfc1006` provider.
4. If this request fails, the application stops making connection requests since there are no other NSAPs specified for the alias.

9.2.2 The Distinguished Name Format

Entries of the Distinguished Name format support the second category of information mentioned in Section 9.1.

Entries of the Distinguished Name format take the following form:

```
alias :application-name:transport_template_list:x500_distinguished_name:
```

The *application-name* field contains the name of the application associated with the entry. The value of this field can be either FTAM or VT.

The value of the *transport_template_list* field lists the names of the transport templates to use when communicating with the application identified by the X.500 Distinguished Name. The *transport_template_list* takes the following form:

```
template=template1,template2,...:
```

The *x500_distinguished_name* field contains an X.500 Distinguished Name of a particular FTAM or Virtual Terminal application. In the X.500 Directory, the object entry identified by this Distinguished Name is associated with a presentation address. The X.500 Distinguished Name is used to query the X.500 Directory for the presentation address of the FTAM or VT application in question.

The colon (:) at the end of the Distinguished Name denotes the end of the Distinguished Name. It is not considered to be a part of the Distinguished Name.

The templates are used in conjunction with the presentation address of the application, as returned by the X.500 Directory. For example, the presentation address of the application may contain more than one NSAP. In establishing a connection with the application, the first template is used with the first NSAP in the presentation address. If the connection attempt fails, then the first

The OSI Application-Entity Database

9.2 Entry Formats in isoapplications

template is used with the next NSAP in the presentation address. If there are no more NSAPs to try, the next template in the list of templates is used with the first NSAP in the presentation address, and so on, until either a connection is established with the application or you run out of templates.

For example, a Distinguished Name entry in isoapplications may look like this:

```
foo :VT:template=template1,template2:/c=us/o=widgetco/cn=alias/cn=vt:
```

If the presentation address of application foo were:

```
psel.ssel.tsel.nsap1,nsap2,nsap3
```

then the following sequence of templates and presentation addresses would be used to attempt to establish a connection with application foo:

```
template1, psel.ssel.tsel.nsap1
template1, psel.ssel.tsel.nsap2
template1, psel.ssel.tsel.nsap3
template2, psel.ssel.tsel.nsap1
template2, psel.ssel.tsel.nsap2
template2, psel.ssel.tsel.nsap3
```

9.2.3 The Pattern Format

Entries of the Pattern format support the second category of information mentioned in Section 9.1.

Entries of the Pattern format take the following form:

```
* :application-name:transport_template_list:incomplete_distinguished_name:
```

The asterisk (*) is a special form of the alias. It is considered to match all input provided to the FTAM and VT commands.

The *application-name* field contains the name of the application associated with the entry. The value of this field can be either FTAM or VT.

The *incomplete_distinguished_name* also contains one or more asterisks (*). At run time, each asterisk is replaced by the input provided to the FTAM and VT commands, thereby creating a complete X.500 Distinguished Name. For FTAM, user names and passwords are not included in any of the substitutions.

The *x500_distinguished_name* field contains the X.500 Distinguished Name of a particular FTAM or Virtual Terminal application. In the X.500 Directory, the object entry identified by this Distinguished Name is associated with a presentation address. The X.500 Distinguished Name is used to query the X.500 Directory for the presentation address of the FTAM or VT application in question.

The colon (:) at the end of the Distinguished Name denotes the end of the Distinguished Name. It is not considered to be a part of the Distinguished Name.

The value of the *transport_template_list* field lists the transport templates to use when communicating with the application identified by the X.500 Distinguished Name. The *transport_template_list* takes the following form:

```
template=template1,template2,...:
```

See the description in Section 9.2.2 to understand how templates used in conjunction with the presentation address of the application.

For example, a Pattern entry in isoapplications may look like the following:

```
*      :VT:template=default:/c=us/o=widgetco/cn=*/cn=vt:
```

Note

At the time of this writing, ISO documents regarding the storage of Form2 (Object Identifier) AE-titles in the X.500 Directory are in draft form. Therefore, the FTAM and Virtual Terminal software will only query the X.500 Directory for the value of the presentation address attribute of the object identified by the X.500 Distinguished Name.

If a particular end system implementation requires that a Form2 AE-title be sent, you cannot use the X.500 Directory, but must instead use an Address Format entry in the isoapplications file.

The FTAM and Virtual Terminal software do not currently support specification or transmission of Form1 (Directory Name) AE-titles.

9.3 Managing the OSI Applications Entity Database

You can edit the isoapplications file directly, using a text editor. See Section 9.2 for information on the entry formats in the file.

UNIX

On Digital UNIX, you can run the `/usr/sbin/osiapplsetup` procedure to configure addressing information that allows the local FTAM and VT initiators to communicate with local listeners or remote applications. This procedure adds addressing information to the isoapplications file.

By default, the FTAM and Virtual Terminal configuration procedure adds entries to the isoapplications file in the following order: Distinguished Name format, Address format, and Pattern format.

See Section 12.1 for information on running the `/usr/sbin/osiapplsetup` procedure. ♦

9.4 How Entries in isoapplications Are Used

Each entry in isoapplications can be considered to be a rule. The first rule that matches the user's input alias and application (FTAM or VT) is applied to retrieve the required addressing information. If applying the rule does not produce complete and syntactically correct information, then the search in isoapplications continues until there are no more rules, or until complete and syntactically correct addressing information is retrieved. Thus, the order of entries in isoapplications is significant.

Consider the following entries in a hypothetical isoapplications file:

```
*      :VT:template=default:/c=us/o=org1/cn=*/cn=vt:  
remote_alias :VT:template=default:/c=us/o=org1/ou=docs/cn=remote_alias/cn=vt:  
remote_alias :VT::psap.ssap.tsap.%x4145418715004108002b0dc29621:
```

The OSI Application-Entity Database

9.4 How Entries in isoapplications Are Used

OpenVMS

On OpenVMS, if the user enters the following at the DCL prompt:

```
$ set host/vtp remote_alias ◆
```

or

UNIX

On Digital UNIX, if the user enters the following at the shell prompt:

```
% ologin remote_alias ◆
```

the following will happen:

The user's input, `remote_alias`, will be compared to the text in the alias part of the first entry. Since the text in the alias part of the first entry is an asterisk, it is considered to be a match. The value of the application-name field in the entry, VT, is also a match. Therefore, all asterisks in the Pattern in the first entry are replaced with `remote_alias`, producing the following Distinguished Name:

```
/c=us/o=org1/cn=remote_alias/cn=vt
```

The X.500 Directory is queried for the presentation address associated with the X.500 Directory entry specified by the Distinguished Name. If the query is successful and a complete and syntactically correct address is returned, then the address is used by VT to establish a Virtual Terminal association with the remote application.

If the query fails, then the search continues in the `isoapplications` file. The second entry in the file matches the user's alias and application. The X.500 Directory is queried for the presentation address associated with the X.500 Directory entry specified by the Distinguished Name. If the query is successful and a complete and syntactically correct address is returned, then the address is used by VT to establish a Virtual Terminal association with the remote application.

If the second query fails, then the search continues in the `isoapplications` file. The final entry in the file matches the user's alias and application. The provided address in the entry establishes a Virtual Terminal association with the remote application.

OpenVMS

Note

The FTAM and VT software uses information in the file to bind to an X.500 Directory System Agent. On OpenVMS, this file is:
`dxd$directory:dxd$dua_defaults.dat ◆`

UNIX

Note

The FTAM and VT software uses information in the file to bind to an X.500 Directory System Agent. On Digital UNIX, this file is:
`/etc/dua.defaults ◆`

9.5 Usage Considerations

You should consider the following when deciding what types of entry formats to include in isoapplications:

- Using Pattern format entries to retrieve addressing information solely from the X.500 Directory may allow you to store less information in isoapplications, depending on the Distinguished Names of the remote applications on your network.

For example, if the naming scheme for your network spans a single organization and country, you may be able to store one or two entries in isoapplications:

```
* :FTAM:template=default:/c=country_name/o=organization_name/cn=*/cn=ftam:  
* :VT:template=default:/c=country_name/o=organization_name/cn=*/cn=vt:
```

- If the naming scheme is stable for your network, then you could use the Pattern or Distinguished Name entry formats. This can eliminate having to add or change entries to isoapplications when new nodes are added to your network, or if addressing information on your network changes.
- If you can assume that the addresses of the remote applications on your network have been stored in the X.500 Directory, and you choose to include only Pattern or Distinguished Name format entries in isoapplications, then you will not need to obtain the presentation addresses of the remote applications in order to add Address format entries for the remote applications to isoapplications.
- To retrieve addressing information from the X.500 Directory, a connection must first be made with an X.500 Directory System Agent. Based on the order of entries in isoapplications, some time may be lost in communicating with the X.500 Directory System Agent, especially if any queries to the X.500 Directory fail.

For frequently accessed applications, consider using the Address format for your entries and placing these entries at the top or close to the top of the isoapplications file. This should decrease the time required for FTAM/VT to retrieve a valid application address.

- If some applications are rarely used, then the time factor mentioned previously may not be an issue and the Distinguished Name format may be preferable for these applications.
- You may want to consider placing Pattern format entries at the end of the isoapplications file, to provide X.500 lookup for those applications that do not have an explicit entry in the file.

9.6 Determining Service Access Points Selectors for Application Addresses

Before you configure FTAM and VT, you should have the presentation address (also called the upper_layer address) of each remote FTAM and VT application that you expect to access.

The OSI Application-Entity Database

9.6 Determining Service Access Points Selectors for Application Addresses

OpenVMS

On OpenVMS, the installation of FTAM, VT, or both, automatically places an `sys$system:isoapplications.dat` file on your system. This file contains aliases for:

- The local VT responder
- The local VT/Telnet gateway
- The local VT/LAT gateway
- The local FTAM responder ♦

UNIX

On Digital UNIX, before you begin the installation, you should have the appropriate information for configuring your system. The installation procedure asks you for presentation addresses (also called upper-layer addresses) for each remote FTAM and VT application that you expect to use. If you choose to manually configure your system, you must also supply information for the FTAM and VT applications on the local system.

Note

If you choose the autoconfigure option during installation, the installation procedure assigns values to each address component for the local FTAM and VT applications. ♦

The FTAM and VT software uses these presentation addresses to differentiate between responders. You also use this information when you manage the ISO application-entity database, which stores addressing information about local and remote FTAM and VT applications or listeners.

The FTAM and VT presentation addresses are used for upper-layer addressing and contain a sequence of service access points (SAPs) in the form of *PSEL.SSEL.TSEL.NSAP* (the `.` delimits each value in the address). Each of these values in the application address represents the selector for the Presentation, Session, Transport, and Network Service access points, respectively.

Note

The U.S. GOSIP (Government OSI Profile) standard (Version 1.0) specifies that SAP values should be two octets in length.

If a particular service access point selector in the application address is not required, the delimiter `.` is still included. For example, if the Session selector (SSEL) is not required, then the application address might resemble the following:

```
PSEL..local.%X490004AA000400351121
```

In this example, the PSEL is PSEL followed by its delimiter and the SSEL's delimiter, the TSEL is `local` and the NSAP is `%X490004AA000400351121`.

The following sections explain how to specify each component of the application address. If you are unfamiliar with SAPs, see Chapter 6 and Chapter 10 before proceeding with the installation.

9.6 Determining Service Access Points Selectors for Application Addresses

9.6.1 Specifying PSEL, SSEL, and TSEL Values

The PSEL and SSEL values in the application address are optional and can be any string, including a hexadecimal string. A hexadecimal string is preceded by %x (or %X). You specify the TSEL value in the same way as the PSEL and SSEL values; however, the TSEL value must be unique for each responder or alias that resides on the same system as another responder or alias. Using the same TSEL value for another alias on the same system can cause addressing problems.

9.6.2 Specifying NSAP Values

To get the NSAP value for remote systems, ask the system manager or the network manager of the remote system for this information. To get the NSAP value for a local system, use the `ncl show osi transport local nsap` command.

The following example shows the output from this command. When you use this command, choose one of the values next to the Name field in the output display as the NSAP value for the Application address.

```
ncl> show osi transport local nsap * name

Node 0 OSI Transport Local NSAP %X490004AA000400351121
      AT 1991-06-26-16:11:03.775-04:00I0.138

Identifiers

Name                               = %X490004AA000400351121

-----

Node 0 OSI Transport Local NSAP %X4145418715004108002B0DA48721
      AT 1991-06-26-16:11:03.815-04:00I0.138

Identifiers

Name                               = %X4145418715004108002B0DA4872

-----
```

9.6.3 Specifying NSAP Values for X.25

OpenVMS

The X.25 Access module can be set up such that either X.25 NSAPs or X.25 DTE addresses are passed to it. If X.25 NSAPs are passed to the X.25 Access module, specify the NSAP in the alias definition in `isoapplications.dat` in the normal NSAP location.

For example:

```
local_ftam_nsap :FTAM:::RMS.FTAM.OSIF.%x103631346175551111,provider=osi,template=osit$loop_cons:
```

If DTE addresses are passed to the X.25 Access module, you must define a logical name in the `OSIT$NAMES` logical name table for the DTE of the remote system. You then specify this logical name in the NSAP field of the alias definition in `isoapplications.dat`.

For example, you can define a logical name `REMOTE_DTE` in the `OSIT$NAMES` table, as follows:

```
$ define/table=OSIT$NAMES REMOTE_DTE 031346175551111
```

The OSI Application-Entity Database

9.6 Determining Service Access Points Selectors for Application Addresses

Then you can use this logical name in an alias definition as follows:

```
local_ftam_dte :FTAM:::RMS.FTAM.OSIF.REMOTE_DTE,provider=osi,template=osit$loop_cons:
```

◆

Managing FTAM (OpenVMS)

You will need to perform certain management tasks in order to set up and manage an FTAM system environment. This chapter considers the relationship of the FTAM software and an OpenVMS system, and explains the required tasks.

10.1 Required System Resources

10.1.1 Quotas for Initializing FTAM Software

The DECnet-Plus for OpenVMS distribution kit requires that the OpenVMS OSI default account (whose default name is `osit$default`) has approximately 20,000 units of BYTLM. The FTAM installation procedure locates or creates this default account and ensures that it has sufficient BYTLM.

Refer to your OSAK installation documentation for the required BYTLM quotas.

10.1.2 User Quotas

Each time you enter an FTAM DCL command, the command uses its own OSI connection. Each concurrent connection requires a set amount of system resources. You must ensure that all users have the following system resources on their accounts to accommodate the following quotas:

- The BYTLM quota requires at least 12,288 bytes. (The typical value for the BYTLM quota of each OpenVMS user process is 8,192.)
- The ASTLM (AST queue limit) quota requires a value of at least 8. (The typical value for the ASTLM quota of each OpenVMS user process is 24.)
- The FILLM (open file limit) quota requires a value of at least 10. (The typical value for the FILLM quota of each OpenVMS user process is 20.)

10.2 Required Privileges

You need to activate certain privileges for certain users, depending on what FTAM tasks they perform. The following list summarizes these tasks, and the privileges required to perform them.

- Starting FTAM by executing `osif$startup.com` requires a number of privileges, which exist in the system account. Therefore, start FTAM from the system account.
- Using FTAM DCL commands and enabling the FTAM tracing facility requires only TMPMBX and NETMBX privileges.
- Displaying event messages requires OPER privileges for defining network operator consoles.

Managing FTAM (OpenVMS)

10.3 The OSAKserver

10.3 The OSAKserver

The OSAKserver is a background process responsible for handing over association indications to addressed OSI applications.

The OSAKserver contains a database of addresses it compares to the address in an incoming A-ASSOCIATE indication PDU. If these addresses match, the OSAKserver starts an appropriate application process. Refer to your OSAK documentation for more information on the OSAKserver.

10.4 Initializing the OSAKserver and FTAM

You must start the OSAKserver before FTAM can run. Start the OSAKserver by executing the startup procedure called `osak$start.com` in `sys$startup`.

Start FTAM by executing `sys$startup:osif$startup.com`.

The installation procedure executes the startup procedure when you choose to run the installation verification procedure (IVP). However, restarting FTAM automatically whenever the system reboots requires that the system startup command file execute `osif$startup.com`. To enable automatic restart, edit the network startup file (`sys$manager:systartup_vms.com`) and add a command to execute `osak$start.com` and `osif$startup.com` as follows:

```
$ @sys$startup:osak$start.com ! osak start-up command file
$ @sys$startup:osif$startup.com ! FTAM start-up command file
```

You can stop the OSAKserver at any time from the system account (or any account with SETPRV privileges) by entering the following command:

```
$ @sys$startup:osak$stop.com 
```

10.5 Event Logging to OPCOM Consoles

FTAM logs significant events by sending event messages to the OpenVMS OPCOM utility. OPCOM forwards each event message to all network operator consoles on the local system. A network operator console is a terminal that is enabled for network replies using the DCL `reply/enable=network` command. For full information on the `reply` command, see the *OpenVMS DCL Dictionary*.

For example:

```
%%%%%%%%%% OPCOM 31-MAR-1996 09:00:00.00 %%%%%%%%%%%
message from user SYSTEM on OSIVAX
OSI upper layer event detected, PID = 00000046
%OSIS-E-NOADDRCONN, no address found for inbound connect
```

The preceding message indicates that the OSAKserver did not find the inbound local application address in the OSAK application database.

10.6 Downstream Processing Support

The FTAM responder includes the following support for downstream file processing. The FTAM responder creates a logical name, `OSIF$FILEINFO`, in the process logical name table of the FTAM responder process.

For example:

```
$ SHOW LOGICAL OSIF$FILEINFO
"OSIF$FILEINFO" [super] = "DKA500:[TMP]FILE1.TXT;1/48" (LNM$PROCESS_TABLE)
= "DKA500:[TMP]TMP.TMP;9/48"
```

This logical name may have multiple translations, one translation for each file that was opened during the FTAM association by an FTAM F-OPEN-REQUEST. The information currently available includes the local RMS file name and the FTAM processing mode for the file. Additional information may be provided with future releases. Each piece of information is delimited by a slash ("/").

The processing mode is represented as a decimal number. This is a bit mask, representing the processing mode bits that were set when the file was opened. The meanings for these bits are documented in SYS\$LIBRARY:OSIF.H and ISO 8571.

SYS\$SYSTEM:OSIF\$RESPONDER.COM, the FTAM responder command procedure, contains DCL code demonstrating how this information can be parsed and used. OSIF\$RESPONDER.COM uses the information in OSIF\$FILEINFO to print out the file information into the OSIF\$RESPONDER.LOG log file.

10.7 Controlling RMS Record I/O

The FTAM responder on OpenVMS recognizes the following logical names (shown in the following table) which allow the system manager to supply default values for initial file creation size and extend size for RMS to use during record-oriented I/O. These logical names apply when the FTAM responder is the receiver of the data.

Logical Name	Controls	Unit
OSIF_FILE_ALQ	initial file allocation size	blocks
OSIF_FILE_DEQ	extension size	blocks

Proper setting of these logical names can enhance the performance of RMS during record-oriented I/O. These logical names are most useful when you know in advance that files received typically exceed a given size.

The values specified in these logical names are used as defaults for the case when the `future_filesize` parameter is not supplied in the F-CREATE-REQUEST. If the `future_filesize` parameter is not supplied and these logical names are not defined, the FTAM responder uses the RMS defaults for the device (cluster size and extend quantity).

The FTAM responder command procedure, SYS\$SYSTEM:OSIF\$RESPONDER.COM, contains DCL code demonstrating how these logical names can be defined. For example:

```
$ DEFINE OSIF_FILE_ALQ 500 ! initial size 500 blocks  
$ DEFINE OSIF_FILE_DEQ 500 ! extend by 500 blocks
```

The initial file allocation size and extension size can be controlled on the initiator side by using the `/ALLOCATION=n` and `/EXTENSION=n` qualifiers on the copy or append command.

10.8 Overview of FTAM Addressing

You need to understand addressing information in order to manage an FTAM system. There are two types of communications, outbound and inbound, and each requires a different type of address.

Managing FTAM (OpenVMS)

10.8 Overview of FTAM Addressing

An address for outbound communications (a **remote application address**) requires a presentation address (p-address), which consists of an upper-layer address and an OSI Transport address. An address for inbound communications (a **local application address**) consists only of an upper-layer address, which is a p-address without the NSAP or DTE.

10.8.1 Application-Entity Titles (AE-titles)

An **application-entity title (AE-title)** uniquely identifies a specific application on a given open system. An AE-title consists of two parameters: an application-process title and an application-entity qualifier.

- An **application-process title (AP-title)** is a value that identifies an OSI application process.
- An **application-entity qualifier (AE-qualifier)** is a value that identifies an application entity, such as FTAM, within an application process.

For a general description of application processes and entities, see Section 7.1.

AE-titles for inbound connections are not supported by the OSAK upper-layer software. AE-titles for inbound connections are therefore meaningless to this implementation and consequently cannot be defined in NCL. AE-titles for outbound connections may, however, be meaningful to a remote OSI implementation.

AE-titles for outbound connections may be specified by including the AE-title specification in the `sys$system:isoapplications.dat` file as part of the alias definition.

For outbound connections, see Chapter 9 for a description on how to define an AE-title.

10.9 Managing Inbound Addresses

The FTAM application requires a system manager or a designated support person to be responsible for maintaining the osak application database.

The osak application database holds addressing information for inbound connections to FTAM. The OSAKserver uses this information in managing inbound OSI communications for processes in the upper layers.

Section 10.9.10 explains DAP-FTAM Gateway management.

10.9.1 The Local Application Address Format

The local application address is an upper-layer address that contains transport, session, and presentation selectors. Upper-layer addresses take the following format:

p-selector. s-selector. t-selector.

Any of these selectors could be null.

Together, the service access point (SAP) selectors form an upper-layer address for the local FTAM responder. You can create a new address for each remote application by adding it to the osak application database. You can also locate an existing address within this database that you want a remote system to use. Give the selected upper-layer address to the system manager of the remote system. Note that you must also give your system's NSAP to that system manager. For additional information on upper-layer addresses, see Chapter 9.

10.9.2 File Designation

This is the name of the FTAM responder command file that is to be executed by the OSAKserver upon receiving an inbound FTAM connection request. A responder command file is mandatory. The installation verification procedure (IVP) creates a responder command file for FTAM called `sys$system:osif$responder.com`, which you can use in its original form or copy to another file name and adapt to your needs. For example, to research interoperability issues, you might want to modify your `osif$responder.com` file to enable tracing only under testing conditions.

10.9.3 OpenVMS User Name

This is the user name of the OpenVMS account in which inbound connections reside. The responder has owner privileges whenever it runs in a user's account. By default, owner privileges allow complete access to files, which allows the responder to read, write, and delete files. You can restrict these privileges for a given file or directory by using the DCL `set protection` command.

10.9.4 OpenVMS Login Password

This is the login password associated with the specified user name. If the user's account is password protected, accessing the FTAM responder requires that both the password and the user name reside in the address database. If the user's account lacks password protection, omit this parameter from the address database.

10.9.5 OpenVMS Account

This is the OpenVMS account name corresponding to the user name. You can specify an account name for billing purposes. Note that OpenVMS ignores the account name. For information about accounts on OpenVMS systems, refer to the DECnet-Plus management documentation.

10.9.6 Transport Class

The OSI standards define five different protocol classes for the Transport layer. These protocol classes are labeled 0, 1, 2, 3, and 4. OSI Transport implements three transport classes (0, 2, and 4). All three classes are available for negotiation at connection time. The class selected is negotiated based on the classes supported by the peer user. In negotiation, the highest class supported by both entities is selected.

10.9.7 Transport Options

The transport options that are available to FTAM include checksums, expedited, extended format, and flow control. You can specify any combination of these options. For more information, refer to your DECnet-Plus management documentation.

10.9.8 The FTAM Default Address

Remote file access for FTAM is equivalent to remote file access on a DECnet node. The OpenVMS OSI default account serves the same functions as the DECnet default account. The default name of the OpenVMS OSI default account is `osit$default`.

On OpenVMS operating systems for Version 5.7 and later, you need a password to access the `osit$default` account.

Managing FTAM (OpenVMS)

10.9 Managing Inbound Addresses

The FTAM IVP creates a default address, `rms.ftam.osif.`, which uses the account `osit$default`. If this account name is nonexistent on your system, then the default address will not work. The default address has the following information in the address database.

Item	Default Value
Address	<code>rms.ftam.osif.</code>
Service	<code>acse</code>
File	<code>sys\$system:osif\$responder.com</code>
User	<code>osit\$default</code> ¹
Password	<i>There is no default password</i>

¹ `osit$default` is the original user name of the OpenVMS OSI default account but the OSI Transport installer may use a different account. In that case, attempts to use the IVP's default local application address fail unless it is deleted and recreated with a valid user name and password.

10.9.9 Example of Inbound Address Entry

You can specify inbound FTAM addresses in the OSAK application database with the following commands:

```
$ ncl create osak application ""RMS""/"FTAM""/"OSIF""/NS+,CLNS"
$ ncl create osak application ""RMS""/"FTAM""/"OSIF""/NS+,CLNS" -
  invocation [ap = -1, ae = -1]
$ ncl set osak application ""RMS""/"FTAM""/"OSIF""/NS+,CLNS" -
  invocation [ap = -1, ae = -1] startup information -
  "user=OSIT$DEFAULT,file=SYS$SYSTEM:OSIF$RESPONDER.COM"
$ ncl set osak applic ""RMS""/"FTAM""/"OSIF""/NS+,CLNS" startup policy
```

To create an address with a NULL PSAP, use the following command:

```
$ ncl create osak application """"/"FTAM""/"OSIF""/NS+,CLNS"
```

10.9.10 The DAP-FTAM Gateway Default Account

When the DAP-FTAM Gateway (also referred to as the gateway) is installed, the installation procedure creates the gateway account. The name of the default gateway account is `osigtwy` and the name of the default directory is `[OSIF$GTWY]`.

Account Parameters

When the gateway account is created, several critical flags and UAF (User Authorization File) fields are set by the installation procedure. For the DAP-FTAM Gateway to function effectively, these should not be modified.

The specified flags are:

- `nocaptive`
- `restricted`
- `defcli`
- `nodisuser`
- `lockpwd`
- `dismail`
- `disctly`

The following table contains the critical values for the UAF fields.

Critical UAF Values for the Gateway Account	
Field	Value
fillm	25
biolm	20
bytlm	20000
wsextent	3072

The FAL Session Control Application

The Network Control Language (NCL) database contains a number of session control applications. One of the objects in the NCL database is the file access listener (FAL), which is the target for requests made by remote nodes. A command file (`sys$system:fal.exe`) is associated with the FAL. This file contains the program or procedure used to start the FAL object.

When FTAM is installed, a file (`sys$system:osif$gtwy.com`) is created which replaces `sys$system:fal.exe` in the NCL database. The old file name (`sys$system:fal.exe`) is then assigned to a symbol that is stored in `sys$system:osif$gtwy.com`. In the Gateway account's `login.com`, another symbol is assigned to point to `sys$system:osif$gtwy.com`.

When a request is directed to the Gateway account, the symbol is redefined to execute the DAP-FTAM Gateway image. However, if the incoming request was directed to any other account, the symbol does not get changed and the old file (`sys$system:fal.exe`) is executed.

10.10 Managing Outbound Addresses

The FTAM application requires that a system manager or designated support person be responsible for maintaining the OSI application entity database (`sys$system:isoapplications.dat`) and the DAP-FTAM Gateway. You must also manage other components of the software, depending on the application in use.

See Chapter 9 for additional information on managing the `sys$system:isoapplications.dat` file.

10.11 Overview of FTAM Operations

The purpose of this section is to help you understand FTAM operations sufficiently to manage FTAM communications effectively. FTAM uses different sorts of processes for initiating connections and for responding to connection requests. This section considers the operation of FTAM processes in both situations.

This discussion assumes that you are familiar with the concepts discussed in Chapter 7 and Chapter 8.

The FTAM protocol allows for a limited form of security through FTAM access information. Remote FTAM applications can request any combination of FTAM's initiator ID, filestore password, and filestore account attributes.

For a remote file specification, an FTAM user refers to the remote FTAM application by its application name (alias), plus any required FTAM access information. This application information precedes a file designation, as follows:

Managing FTAM (OpenVMS)

10.11 Overview of FTAM Operations

alias" *initiator-id filestore-password account*" :: *file-designation*

The following table explains the variables in the remote file specification.

Variable	Explanation
<i>initiator-id</i>	The initiator ID required by a remote FTAM application or null.
<i>filestore-password</i>	The filestore password required by a remote FTAM application or null.
<i>account</i>	The filestore account required by a remote FTAM application or null.
<i>file-designation</i>	The unique system-specific information that identifies a remote file using whatever information (device, directory, file name, and so forth) that the remote FTAM application requires to locate that file in its system's real filestore.

When accessing RMS files for an FTAM application, FTAM equates FTAM access information to OpenVMS parameters as follows:

FTAM Attribute	OpenVMS Parameter
Initiator ID	OpenVMS user name
Filestore password	OpenVMS login password
FTAM account	OpenVMS account †

†The OpenVMS account is currently a meaningless parameter on OpenVMS.

Examples

In the following examples, *a\$ftam* and *b\$ftam* represent remote FTAM applications residing on system A and system B, respectively. The file names are *src.file* and *dst.file*.

```
$ directory/app=ftam/full a$ftam"anon secret"::src.file Return
```

This command uses the addressing information associated with alias *a\$ftam* to access a remote FTAM application. The command supplies *anon* as the initiator identity and *secret* as the filestore password; it supplies no account name. The command requests the remote FTAM application to return the characteristics of the remote file *src.file*.

```
$ copy/app=ftam a$ftam"anon secret account"::src.file Return
_ $ b$ftam::dst.file Return
```

This command accesses the remote FTAM applications identified by the addressing information associated with aliases *a\$ftam* and *b\$ftam*. The command supplies FTAM application *a\$ftam* with the initiator identity *anon*, the filestore password *secret*, and the account name *account*. The command supplies no access information to *b\$ftam*. The command requests that the file *src.file* from system A be copied to *dst.file* on system B.

For further information about the FTAM file-specification format and commands, see Chapter 2.

10.11.1 Dynamics of Outbound Connections

To send an outbound connection request to a remote system, an FTAM initiator must successfully complete the following sequence of steps. Failure of any step causes the attempted connection to fail.

1. FTAM initiates connections in response to an FTAM DCL command issued by a user; for example:

```
$ delete/app=ftam freunde:."^vol>dir>file.ext" Return
```

2. DCL's Command Language Interpreter (CLI) parses an FTAM DCL command and maps it to an initiator image file: `osif$append.exe`, `osif$copy.exe`, `osif$delete.exe`, `osif$dir.exe`, or `osif$rename.exe` (in the `sys$system:[sysexe]` directory).

The CLI activates the initiator by running the appropriate initiator image file in the OpenVMS user process, which activates the FTAM shareable images for its own use.

3. The initiator parses the command's file specifications for application names. Then the initiator compares the application names to the entries in the alias file. For example, the preceding `delete/app=ftam` command specifies an FTAM application named `freunde`, so the initiator looks for the alias `freunde`.

The outcome of this parsing determines how the initiator continues, as follows:

- a. If none of the specified names exist in the alias file, the initiator attempts to access the files using RMS.
 - b. If an alias matches any specified application name, then the initiator uses the FTAM protocol to access all of the files.
4. On finding the necessary alias, the initiator reads the alias database entry. For example, for the sample alias, `freunde`, the database information might include the information shown in the following table:

FTAM Alias Database Entry for FREUNDE	
Item	Value
Alias (application name)	FREUNDE
Remote application address	a.b.c.X25%3130608555000013
AP-title	{1 3 9999 1 7}
AE-qualifier	1
Session versions	1,2

5. The initiator issues a service request for the F-INITIALIZE service. That service then uses information from the alias database to make service requests for A-ASSOCIATE, P-CONNECT, S-CONNECT, and T-CONNECT. The addressing information from the alias database entry is used as follows:
 - a. The ACSE element of the FTAM entity uses the AP-title and AE-qualifier values (if any).
 - b. The presentation entity uses the presentation selector.
 - c. The session entity uses the session version (if any) and the session selector.

Managing FTAM (OpenVMS)

10.11 Overview of FTAM Operations

6. The session entity passes the transport selector and OSI Transport address downward to OSI Transport for processing. For information on OSI Transport operations, refer to the your DECnet-Plus management documentation.
7. On completing the user's file operation, the initiator image exits. By entering another FTAM DCL command, the user can reactivate the initiator, which establishes a new set of connections from within the same OpenVMS user process.

10.11.2 Dynamics of Inbound Connections

To accept an inbound connection request, FTAM must successfully complete the following sequence of steps. Failure of any step causes the attempted connection to fail.

1. The OSAKserver declares itself to OSI Transport as the target for all TSAPs defined in the NCL Session Control module. When a transport connection arrives for one of those TSAPs, the OSAKserver accepts the transport connection.
2. Each inbound connection request asks for a specific local application address. If that address resides in the OSAK application database in NCL, the OSAKserver retrieves that entry.

For example, the entry for the IVP's default local application address, `rms.ftam.osif.`, provides the OSAKserver with the values in the following table:

FTAM Address Database Entry for RMS.FTAM.OSIF.	
Item	Value
Service name	ACSE
File name	sys\$common:osif\$responder.com
User name	osit\$default
Login password	<i>There is no password for this entity</i>

3. If the called AP-title or called AE-qualifier is absent from the inbound request, the OSAKserver ignores those parameters.
4. If the OpenVMS user name, password, and account are valid, the OSAKserver creates an OpenVMS process using the specified user name and password. If the values are invalid, the connection is rejected.
5. The OSAKserver executes the specified responder command file in that OpenVMS process; the distribution version of this command file is named `sys$system:osif$responder.com`. The command file activates the FTAM responder image, which then takes over the transport connection from the OSAKserver.
6. The responder image then establishes an FTAM association and the session and presentation connections. When the connections and association terminate, the responder process waits for the next connect request directed to the same process. The OSAKserver process continues.

Managing a VT Application (OpenVMS)

The DECnet-Plus Virtual Terminal application requires you to manage the OSI application entity database. You must also manage other components of the software, such as:

- The Virtual Terminal responder
- The LAT/VT and Telnet/VT Gateways

The OSI application entity database stores addressing information for aliases that represent VT applications.

11.1 Managing the OSI Application Entity Database

The `sys$system:isoapplications.dat` file is the local database for storing all the addressing information about remote and local VT applications or listeners. The aliases used in this file do not have to correspond to node names because they may also be references to applications. Since users specify these aliases within commands, a brief alias name is easier to use.

The `sys$system:isoapplications.dat` file is readable by all, but it can be written to only by a privileged user. The database entries can be modified using any text editor, and the entries must conform to the formats described in Chapter 9.

11.2 Managing the VT Responder

The VT responder executes as a detached process and waits for inbound association requests. When the responder receives and verifies the application-context-name for an association request, OpenVMS creates a detached process that provides the interactive process context for the remote VT user.

Communication between the VT responder and the detached process is by a pseudoterminal device driver (FTDRIVER). The responder is responsible for all encoding and decoding of data, and interfacing with the OSAK software.

Site-specific requirements should be maintained in the file `sys$startup:vt_systart.com`.

Note

The `sys$startup:vt_start.com` procedure should be invoked **after** you start the OSAK software.

The VT startup procedure `sys$startup:vt_start.com` creates the `vt$names` logical name table, and defines a set of logical names within this table for use by the VT software. The `vt$names` logical name table is not deleted when VT is shut down.

Managing a VT Application (OpenVMS)

11.2 Managing the VT Responder

The VT responder listens on the alias specified by the logical name VT\$VT_LOCAL_ALIAS. By default, this logical name translates to the alias LOCAL_VTP, which is then looked up in sys\$system:isoapplications.dat. By default, the LOCAL_VTP alias in sys\$system:isoapplications.dat is specified as:

```
LOCAL_VTP      :VT::%x0001.%x0001.%x0002.%x21, \
                provider=osi,template=osit$loop_clns:
```

osit\$loop_clns is the name of a template that is created automatically by DECnet-Plus when OSI Transport is started.

To change the alias that the responder listens on, modify the definition of VT\$VT_LOCAL_ALIAS in the file sys\$startup:vt_systart.com. To change the address that the alias translates to, modify the definition of the alias in the file sys\$system:isoapplications.dat.

The VT responder can only listen on one address. The transport service access point (TSAP) used by the responder cannot be shared by any other OSI application (such as FTAM).

The number of concurrent associations the VT responder will support is controlled by the logical name VT\$VT_RJOBLIM. The default value of VT\$VT_RJOBLIM is 8. If you want to change this value, you can modify the definition in the file sys\$startup:vt_systart.com. The value is not dynamic; the responder only examines the value of VT\$VT_RJOBLIM when it initially starts up.

If you want a change to take effect after the VT responder has been started, you must stop and restart the responder by using the following commands:

```
@ sys$manager:vt_stop.com responder
@ sys$manager:vt_start.com responder
```

When the sys\$startup:vt_start.com procedure is executed, it will compute the needed resources for the VT responder process. However, the responder also requires some system resources, the most important of which is nonpaged dynamic memory (NPAGEDYN). For the default value of VT\$VT_RJOBLIM (8), the VT responder requires a minimum of 14,512 bytes of NPAGEDYN. The formula for computing minimum NPAGEDYN requirements is:

```
VT$VT_RJOBLIM * 1696 + 944 = minimum npagedyn
```

You can start and stop the VT responder without affecting the gateways by using the sys\$startup:vt_start.com and sys\$manager:vt_stop.com files. Specify RESPONDER as parameter P1. For example:

```
Lnode $ @sys$startup:vt_start responder
%RUN-S-PROC_ID, identification of created process is 0000022E

Lnode $ @sys$manager:vt_stop responder
%%% VT_RESPONDER is running in process 0000022E
%%% Process will be stopped
```

Stopping the VT responder terminates any current interactive associations.

11.3 Managing the VT Gateways

The VT software supports communication by LAT/VT and Telnet/VT Gateways. Both gateways are bidirectional. The LAT/VT Gateway provides communication from a LAT environment to a VT environment, or a VT environment to a LAT environment. The Telnet/VT Gateway provides communication from an Internet system to a remote OSI system, or from an OSI system to a remote Internet system.

Managing a VT Application (OpenVMS) 11.3 Managing the VT Gateways

If you have an Extended Function license installed on your system, the `sys$startup:vt_start.com` procedure automatically starts both gateways. To utilize the Telnet/VT Gateway, you must also install the Digital TCP/IP Services for OpenVMS product.

Note

If you intend to use the Telnet/VT Gateway, you should execute the `sys$startup:vt_start.com` **after** you start the Digital TCP/IP Services for OpenVMS product.

If you intend to utilize the LAT/VT Gateway, you should execute the `sys$startup:vt_start.com` **after** you start the LAT service.

Like the VT responder, each gateway has a specific logical name to determine which alias is used to listen on. The LAT/VT Gateway uses the logical name `VT$LAT_LOCAL_ALIAS`, which defaults to the alias `LOCAL_VTP_LAT`, which defaults to the following address:

```
LOCAL_VTP_LAT :VT::%x0001.%x0001.%x0003.%x21, \  
              provider=osi,template=osit$loop_clns:
```

The Telnet/VT Gateway uses the logical name `VT$TELNET_LOCAL_ALIAS` which defaults to the alias `LOCAL_VTP_TELNET`, which defaults to the following address:

```
LOCAL_VTP_TELNET :VT::%x0001.%x0001.%x0004.%x21, \  
                provider=osi,template=osit$loop_clns:
```

If the logical name is not defined, or if the alias does not exist in `sys$system:isoapplications.dat`, then the gateway is not started. Table 11–1 shows each logical name, default alias name, who uses it, and the default address associated with that alias name.

Table 11–1 Logical Names, Alias Names and Default Addresses

Logical Name	Alias Name	Used by	Default Address
<code>VT\$VT_LOCAL_ALIAS</code>	<code>LOCAL_VTP</code>	VT Responder	<code>%x0001.%x0001.%x0002</code>
<code>VT\$LAT_LOCAL_ALIAS</code>	<code>LOCAL_VTP_LAT</code>	LAT/VT Gateway	<code>%x0001.%x0001.%x0003</code>
<code>VT\$TELNET_LOCAL_ALIAS</code>	<code>LOCAL_VTP_TELNET</code>	Telnet/VT Gateway	<code>%x0001.%x0001.%x0004</code>

Note

All responder and gateway aliases must have unique TSAP names in the address. See Chapter 6 and Chapter 13 for more information on the Transport layer.

You can change the alias used by the responder or by one of the gateways, by editing `sys$startup:vt_systart.com` and changing the value of the corresponding logical name. You can change the address associated with each alias by editing `sys$system:isoapplications.dat`.

Managing a VT Application (OpenVMS)

11.3 Managing the VT Gateways

The gateways also use a logical name to determine the maximum number of concurrent associations, as shown in Table 11–2:

Table 11–2 Logical Names and Default Limits

Logical Name	Used by	Default Limit
VT\$VT_RJOBLIM	Virtual Terminal responder	8
VT\$LAT_RJOBLIM	LAT/VT Gateway	4
VT\$TELNET_RJOBLIM	Telnet/VT Gateway	4

To disable a gateway, simply change the value of the appropriate logical name to 0 (zero). You can also use the `sys$manager:vt_stop.com` procedure to stop a specific gateway (see below).

As with the VT responder, the gateways also consume NPAGEDYN, based on the maximum number of concurrent associations allowed. Using the default values and the same formula as the responder, each gateway needs a minimum of 7,728 bytes of NPAGEDYN.

Both gateways specify the Generalized Telnet profile when initiating an association to another OSI VT system. When accepting an association from a remote OSI VT system, the gateways accept any supported profile (Amode_Default, Telnet or Transparent) specified by the remote OSI system.

You can start and stop the LAT and Telnet gateways individually by using the `sys$startup:vt_start.com` and `sys$manager:vt_stop.com` files. Specify either LAT or Telnet as parameter P1. For example:

```
Lnode $ @sys$startup:vt_start telnet
%RUN-S-PROC_ID, identification of created process is 000000B5
%RUN-S-PROC_ID, identification of created process is 000000B6

Lnode $ @sys$manager:vt_stop lat
%%% VT_LAT_GTWY is running in process 0000012B
%%% Process will be stopped
%%% LAT_VT_GTWY is running in process 0000012C
%%% Process will be stopped
```

11.3.1 Telnet/VT Gateway

The Telnet/VT Gateway has an additional logical name `VT$TELNET_PORT`, which specifies the Internet port it listens on for incoming Telnet connections. By default, the port number is 30324. Internet users who want to use the Telnet/VT Gateway must know both the IP address of the gateway and the port number. If the logical name is not defined, the gateway does not listen for inbound Telnet connections.

Note

The Telnet/VT Gateway does not support all possible Telnet options, but only supports those necessary to support the VT Telnet and Generalized Telnet profiles.

Managing a VT Application (OpenVMS)

11.3 Managing the VT Gateways

It is possible to have the Telnet/VT Gateway listen on the "well-known" Telnet port number 23. To do so, you must first disable the Telnet service offered by the Digital TCP/IP Services for OpenVMS product. If the Telnet/VT Gateway has already been started, you must also restart the gateway. The following example shows the commands you need to to perform this procedure:

```
Lnode $ ucx
UCX> stop service telnet
UCX> exit
Lnode $ define/table=vt$names/supervisor/log vt$telnet_port 23
Lnode $ @sys$manager:vt_stop telnet
%%% VT_TELNET_GATE is running in process 00000129
%%% Process will be stopped
%%% TELNET_VT_GTWY is running in process 0000012A
%%% Process will be stopped
Lnode $ @sys$startup:vt_start telnet
%DCL-I-TABSUPER, previous table VT$NAMES has been superseded
%DCL-I-SUPERSEDE, previous value of VT$INPUT has been superseded
%DCL-I-SUPERSEDE, previous value of VT$OUTPUT has been superseded
%RUN-S-PROC_ID, identification of created process is 000000B5
%RUN-S-PROC_ID, identification of created process is 000000B6
```

To permanently change the port, edit the `sys$startup:vt_systart.com` file, changing the value assigned to `VT$TELNET_PORT`.

Note

If you choose to have the Telnet/VT Gateway listen on the "well-known" Telnet port, you cannot also allow incoming interactive Telnet connections.

11.3.2 LAT/VT Gateway

The LAT/VT Gateway has two additional logical names: `VT$LAT_SERVICE` and `VT$LAT_SERVICE_IDENT`. `VT$LAT_SERVICE` specifies the name of the LAT service offered for incoming LAT connections. By default, the service name is `LAT_VT_GTWY`. `VT$LAT_SERVICE_IDENT` specifies the identification string for the LAT service. By default, the identification string is "LAT/VT Gateway".

If you want to change these values, you may edit the `sys$startup:vt_systart.com` file. If the logical name `VT$LAT_SERVICE` is not defined, the gateway will not allow incoming LAT connections.

The LAT/VT Gateway does not support any LAT options for initiating a LAT connection from the VT environment. If you need special options, you must log in interactively and issue the appropriate `set host/lat` command.

11.4 Identifying Connection Problems

You can use the OSAK software's trace utility to identify problems with the VT software. This trace utility helps you examine the VT connections to other OSI systems and is fully explained in *DECnet-Plus Problem Solving*. The VT software also generates error messages that can help identify problems. For the initiator, these messages appear on the user's terminal. For the responder and gateways, the error messages are logged to OPCOM.

Appendix I describes how to interpret these error messages.

Managing FTAM and Virtual Terminal (Digital UNIX)

The FTAM and Virtual Terminal applications require you to manage the OSI application entity database. You must also manage other components of the software, depending on the application in use.

The FTAM application requires you to manage:

- The FTAM listeners
- Virtual filestore information
- The FTAM–FTP Gateway

The Virtual Terminal application requires you to manage:

- The VT listeners
- The LAT/VT Gateways
- The Telnet/VT Gateways
- The CTERM/VT Gateways

Each of these managed pieces serves an important function. The OSI application entity database stores addressing information for aliases that represent FTAM and VT applications and listeners. The listeners wait for incoming connection requests. The virtual filestore information addresses problems with file attributes that do not match the default values. The FTAM–FTP, LAT/VT, Telnet/VT, and CTERM/VT Gateways allow remote access and file exchange among systems implementing OSI, Internet, LAT, and CTERM protocols.

12.1 Managing the OSI Application Entity Database

Once you install the FTAM and Virtual Terminal software, you need to configure addressing information that allows the local FTAM and VT initiators to communicate with local listeners or remote applications.

The `/etc/isoapplications` file is the local database for storing all the addressing information about remote and local VT applications or listeners. The aliases used in this file do not have to correspond to node names because they may also be references to applications. Since users specify these aliases within commands, a brief alias name is easier to use.

The `/etc/isoapplications` file is readable by all, but it can be written to only by a privileged user. You can modify the database entries with any text editor, and you can use the `/usr/sbin/osiapplsetup` procedure to add new entries to the file. All entries must conform to the formats described in Chapter 9.

See Chapter 9 for information about the `/etc/isoapplications` file.

Managing FTAM and Virtual Terminal (Digital UNIX)

12.2 Using the /usr/sbin/osiapplsetup Procedure

12.2 Using the /usr/sbin/osiapplsetup Procedure

Refer to *DECnet/OSI for Digital UNIX Installation and Configuration*, Chapter 7, for information about running the /usr/sbin/osiapplsetup procedure. The osiapplsetup procedure allows you to perform the following functions:

1. Add aliases to /etc/isoapplications for local listeners (OSI Transport and RFC 1006 Transport).
2. Add source aliases to /etc/isoapplications ("local_ftam" and "local_vtp").
3. Register the local listeners in X.500 Directory and add corresponding Distinguished Name format aliases to /etc/isoapplications.
4. Add commands to start local listeners at system startup to /sbin/osi_applstartup.
5. Start local listeners.
6. Run the FTAM and VT IVPs.
7. Add aliases for remote FTAM and VT applications to /etc/isoapplications in Distinguished Name, Address, and Pattern formats.

The /usr/sbin/osiapplsetup procedure adds information to the /etc/isoapplications file, the /sbin/osi_applstartup file, or to X.500 Directory by prompting the user for the appropriate information.

12.3 Managing Listeners

The following sections describe how to manage listeners.

12.3.1 Using osi_applstartup to Start Listeners at System Startup

When you configure local addresses via either the autoconfiguration or manual configuration procedure (refer to *DECnet/OSI for Digital UNIX Installation and Configuration*, Chapter 7), you have the option of adding the FTAM and VT listeners to the /sbin/osi_applstartup file and of starting up those listeners.

The /sbin/osi_applstartup file is executed automatically at system startup time. When executed, the /sbin/osi_applstartup file enables local listeners that wait for incoming connection requests at that particular alias' transport address.

The following is an example of an /sbin/osi_applstartup file:

```
# %ftamvtSTART%
echo 'OSI Application Listeners:\c' >/dev/console
[ -f /usr/sbin/ftam_listener ] &&
{
    echo ' FTAM...\c'
    /usr/sbin/ftam_listener -q 10 serchr >/dev/console 2>&1
}
[ -f /usr/sbin/vt_listener ] &&
{
    echo ' VT...\c'
    /usr/sbin/vt_listener -q 10 serchr >/dev/console 2>&1
}
echo ' done.'
# %ftamvtEND%
```

If you want to start more listeners on your system after completing the installation, you can edit the /sbin/osi_applstartup file by using a text editor, or you can use the /usr/sbin/osiapplsetup procedure to update the file.

Managing FTAM and Virtual Terminal (Digital UNIX)

12.3 Managing Listeners

If you use `osiapplsetup`, run the procedure and select option 4, "Add Commands to Start Listeners to `/sbin/osi_applstartup`". In response to the prompts, enter the FTAM and VT aliases for the local listeners that you want to add with a queue length for each one. The procedure also asks you if you want to start the listeners. Refer to *DECnet/OSI for Digital UNIX Installation and Configuration*, Chapter 7, for more information about running `osiapplsetup`.

If you edit `/sbin/osi_applstartup` directly, duplicate the lines that invoke the listeners, replace the aliases with the new aliases you want to enable, and rerun the file.

If you want to remove listeners, edit `/sbin/osi_applstartup` and delete or comment out the lines in the `/sbin/osi_applstartup` file that invoke the listeners you want to remove.

Note

You must be a superuser to modify the `/sbin/osi_applstartup` file.

Do not remove the `%ftamvtSTART%` or `%ftamvtEND%` lines. Doing so will cause the installation procedure to fail and probably corrupt your `/sbin/osi_applstartup` file.

12.3.2 Listening on OSI and RFC 1006 Networks

For FTAM, VT, and their listeners to accept inbound connections over both OSI and RFC 1006 networks, you must start separate FTAM and VT listeners for OSI Transport and RFC 1006 Transport.

Use the `/usr/sbin/osiapplsetup` procedure to configure the OSI and RFC 1006 Transport aliases for the local listeners. With both the autoconfiguration and manual configuration procedures, you have the option of defining aliases in `/etc/isoapplications` for both OSI Transport listeners and RFC 1006 Transport listeners. Refer to *DECnet/OSI for Digital UNIX Installation and Configuration*, Chapter 7, for more information.

The alias name provided to the OSI Transport listeners must contain an OSI NSAP. The OSI Transport listeners will accept connections from both CLNS and CONS/X.25. The alias name provided to the RFC 1006 Transport listeners must contain an NSAP address in the form of an Internet address. See Section 9.1 for more information about NSAP and Internet addresses.

Check to see if the `rfc1006d` process is running on your system if you receive the following error when you start up the RFC 1006 Transport listeners:

```
Error during call to XTI service t_close
Connection refused
```

For more information on managing the RFC 1006 daemon, refer to your DECnet-Plus programming documentation.

Managing FTAM and Virtual Terminal (Digital UNIX)

12.3 Managing Listeners

12.3.3 Starting Listeners

You may start local FTAM and VT listeners by either running the `/usr/sbin/osiapplsetup` procedure or by executing listener commands directly.

If you use `osiapplsetup`, run the procedure, choose option 2, "Manually Configure Local Addresses" from the main menu, and then choose option 5, "Start Listeners" from the manual configuration menu. In response to the prompts, enter the FTAM and VT aliases for the listeners that you want to start with a queue length for each one.

If you want to execute the listener commands directly, the format of the FTAM listener command is:

```
/usr/sbin/ftam_listener [-q queue-length] [-r responder [-T trace-file]] alias
```

The format for VT is:

```
/usr/sbin/vt_listener [-q queue-length] [-r responder] alias
```

Table 12–1 explains each variable in this command.

Table 12–1 Listener Command Variables

Variable	Explanation
<code>-q queue-length</code>	Maximum queue length for outstanding transport connect indications. This value determines the number of connect indications that can be received and not responded to by the listener before further connect indications are rejected. The default value is 10.
<code>-r responder</code>	Name of the responder to start when a transport connect request arrives. By default, <code>/usr/sbin/ftamd</code> is the responder name for FTAM, and <code>/usr/sbin/ologind</code> , is the responder name for VT.
<code>-T trace-file</code>	Name of the trace file to be created. You must use the <code>ositrace</code> command to analyze this trace file (refer to <i>DECnet-Plus Problem Solving</i>). This option may only be specified when the <code>-r</code> option is used.
<code>alias</code>	Alias from the <code>/etc/isoapplications</code> file. The FTAM and VT listeners passively listen on the corresponding TSEL listed in the local alias entry or the X.500 Directory in the <code>/etc/isoapplications</code> file.

If you are a superuser, you can start and stop the listener by issuing commands on the command line. To start a listener, issue the listener command with the appropriate options as follows.

For an FTAM listener:

```
# /usr/sbin/ftam_listener [-q queue-length] [-r responder] alias
```

For a VT listener:

```
# /usr/sbin/vt_listener [-q queue-length] [-r responder] alias
```

The FTAM or VT listener may pause before you are returned to the shell prompt. The listener is ready to accept incoming connections only after you are returned to the shell prompt.

To stop a listener, you need to determine its process identifier (PID) and then terminate that process by using the following commands.

For FTAM:

```
% ps axuw | grep ftam_listener
.
.
.
# kill pid
```

For VT:

```
% ps axuw | grep vt_listener
.
.
.
# kill pid
```

Where the `pid` is the PID of the listener that you want to stop.

12.3.4 Registering Listeners in X.500 Directory

If you have the DEC X.500 Directory Service product installed on your system, you may register the addresses of the local FTAM and VT listeners in the X.500 Directory. Do this by either running the `/usr/sbin/osiapplsetup` procedure or by executing DEC X.500 Administration Facility (`dxim`) commands manually.

If you use `osiapplsetup`, run the procedure, choose option 2, "Manually Configure Local Addresses" from the main menu, and then choose option 4, "Register Listeners in X.500 Directory" from the manual configuration menu. In response to the prompts, enter the information needed to complete the X.500 Distinguished Names for the listeners. The `osiapplsetup` procedure also asks if you want to add aliases to `/etc/isoapplications` for the X.500 entries of the local listeners.

If you want to register the listeners in X.500 Directory manually via `dxim`, refer to the DEC X.500 Administration Facility documentation. For example, the commands may look like the following:

```
dxim create entry /c=country/o=org/ou=org_unit/cn=node attributes \
  objectclass=applicationProcess
dxim create entry /c=country/o=org/ou=org_unit/cn=node/cn=ftam attributes \
  objectclass=applicationEntity, \
  presentationaddress="'0001'H/'0001'H/'0001'H/NS+4700240408002BBC4EC321"
dxim create entry /c=country/o=org/ou=org_unit/cn=node/cn=vt attributes \
  objectclass=applicationEntity, \
  presentationaddress="'0001'H/'0001'H/'0002'H/NS+4700240408002BBC4EC321"
```

12.4 Managing FTAM Virtual Filestore Information

The FTAM responder must maintain certain FTAM file attributes with a file when it is stored on the local system. Some of the FTAM file attributes can be mapped directly to UNIX File System attributes, such as `filename` and `filesize`. Other attributes, such as `contents type`, cannot be mapped directly and must be stored with the file.

The FTAM responder maintains virtual filestore information about FTAM files in a file header. This header is created and appended to the beginning of a file that is created by the responder only if the `contents type` of the file does not match the default `contents type` specified by the FTAM responder. If you create a file with a header, it is called an FTAM file. See Section 7.2.2 for more information about virtual filestores and other FTAM concepts.

Managing FTAM and Virtual Terminal (Digital UNIX)

12.4 Managing FTAM Virtual Filestore Information

FTAM files retain their virtual filestore attributes across Network File System (NFS) networks and during local actions, such as copy, move, or backup and restore. The size of the FTAM file is increased by the size of the FTAM header, if its attributes are read locally or remotely.

- For FTAM-1 files, the default is a maximum string length of unlimited, string significance of not significant, and universal class number of GeneralString.
- For FTAM-2 files, the default is a maximum string length of unlimited, string significance of not significant, and universal class number of GraphicString.
- For FTAM-3 files, the default is a maximum string length of 512 and string significance of not significant.

If an initiator creates a file that does not match these parameters, an FTAM file header is appended to the beginning of the file. Then, if users copy a file to the FTAM responder and they want to use it locally, the header must be stripped off. The initiator using the FTAM responder receives the file without the header when it reads the file.

To strip the FTAM file header from the file, use the following command:

```
ftamconvert file
```

The *file* is the name of the file from which you strip the header.

Users can determine the contents type of an FTAM file by using the `file` command. See `file(1)` in the Digital UNIX reference pages for more information. For example, if the `file` command is used on a file that was transferred with FTAM, the following can appear:

```
FTAM-1 (header V1) string-significance=not significant msl=134  
UCN=IA5String
```

The responder also uses the `file` command to determine the document type for a transferred file. For example, C program text is transferred as an FTAM-1 file with the default maximum string length of unlimited, string significance of not significant, and universal class number of GeneralString. Files determined to be data are transferred as FTAM-3 files.

12.5 Managing the FTAM–FTP Gateway

The FTAM–FTP Gateway allows nodes on OSI or Internet networks to exchange files with each other by interpreting FTAM or FTP protocol messages and translating them into FTP or FTAM protocol messages. Because the gateway is bidirectional, there are two parts to manage. See Chapter 4 for information on how to use the FTAM–FTP Gateway from Internet or OSI nodes.

12.5.1 Invoking the FTAM Daemon

The part of the gateway that translates FTAM protocol messages into FTP protocol messages is invoked by the FTAM daemon (`/usr/sbin/ftam2ftpd`). Start the FTAM daemon as follows:

```
/usr/sbin/ftam_listener -r /usr/sbin/ftam2ftpd alias
```

The *alias* is the name you use to represent the gateway host system. This entry must be in the `/etc/isoapplications` file.

12.5.2 Invoking the FTP–FTAM Daemon

The part of the FTAM–FTP Gateway that translates FTP protocol messages into FTAM protocol messages is the FTP–FTAM daemon (`/usr/sbin/ftp2ftamd`). The FTAM–FTP Gateway is an integral part of the DECnet–Internet Gateway and provides transparent access to OSI networks from the Internet. The DECnet–Internet Gateway examines login information specified by the FTP client and determines which gateway is invoked. The DECnet–Internet Gateway supports Internet File Transfer Protocol (FTP), DECnet Data Access Protocol (DAP), and OSI File Transfer, Access, and Management (FTAM) protocols.

Because the format of the FTAM–FTP Gateway file specification is the same as that of the DECnet–Internet Gateway, this information determines the protocol that should be supported. If the specified login information does not contain a pair of colons (`::`), then an FTP daemon is started for the user. If colons are included, the DECnet–Internet Gateway searches for the name to the left of the colons in the `/etc/isoapplications` file. If the name is not found in the file, the name is a DECnet node name and the DECnet–Internet daemon is started. If the name is in the file, the name is an FTAM alias and the FTP–FTAM daemon is started.

Before attempting to use the FTP–FTAM daemon, note the following:

- An `/etc/isoapplications` file containing the desired FTAM aliases must exist on the system running the DECnet–Internet daemon.
If this file does not exist, all file specifications are assumed to be for the DECnet–Internet Gateway.
- On the target FTAM system, an FTAM responder must be listening on the address specified by the alias on the gateway system.
If an FTAM responder is not listening on the target system, all attempts to establish an FTAM association will fail.
- If an alias exists in the `/etc/isoapplications` file, the DECnet–Internet daemon cannot be accessed for the duration of the Internet connection to the FTAM system. The user must close the connection by typing the `bye` command and restart FTP to connect to either a DECnet or Internet system.
- If an alias exists in the `/etc/isoapplications` and it is a synonym for a DECnet node, it will be used to connect to an OSI network. Make sure your aliases are unique if you want to avoid this problem.
- Make sure that the FTP–FTAM daemon has been properly configured on your system by verifying that the `/etc/inetd.conf` file contains the following lines:

```
#ftp      stream tcp      nowait root    /usr/sbin/ftpd      ftpd
ftp       stream tcp      nowait root    /usr/sbin/ftpd.gw   ftpd
```

12.6 Managing the Virtual Terminal Gateways

The VT Gateways support communication to non-OSI systems by means of Telnet and CTERM, and support communication from non-OSI systems by means of LAT, Telnet, and CTERM.

Managing FTAM and Virtual Terminal (Digital UNIX)

12.6 Managing the Virtual Terminal Gateways

The VT/Telnet and VT/CTERM Gateways are enabled when the installation of the OSI Applications Gateways subset is complete, and both the DECnet and OSI applications have been configured. The Telnet/VT and CTERM/VT Gateways are enabled when the installation of the DECnet-Internet Gateway and the OSI applications base subset is complete and both DECnet and the OSI applications have been configured.

If the Telnet/VT gateway is invoked with an alias that does not exist in `/etc/isoapplications`, then a CTERM connection is attempted to the DECnet system identified by the input alias.

Before users can access the LAT/VT Gateway, you need to announce the gateway service.

12.6.1 Enabling The LAT/VT Gateway Service

To set up the LAT/VT Gateway, perform the following steps:

1. Define the LAT/VT service.

Use the `latcp` command to define the LAT/VT service. For example:

```
/usr/sbin/latcp -A -a vt -i "LAT/VT gateway" -o
```

The `-o` flag specifies that this service is an optional service. Optional services are not like default services. They cannot be used to connect to the Digital UNIX local LAT host through `getty` routines spawned in the `/etc/inittab` file.

You can include this command in the `/etc/latstartup.conf` file to have this service automatically defined at system startup. Note that you must create the `/etc/latstartup.conf` file if it does not already exist.

2. Edit the `/etc/inittab` file.

Select the LAT terminals to dedicate to the gateway, for example: `tty30`, `tty31`, and `tty32`. The number of terminals selected determines the maximum number of simultaneous LAT/VT Gateway sessions the system can deliver.

Edit the system's `/etc/inittab` file to include entries to spawn `lat2vtd` on the select devices. For example:

```
lat30:3:respawn:/usr/sbin/lat2vtd tty30 vt
lat31:3:respawn:/usr/sbin/lat2vtd tty31 vt
lat32:3:respawn:/usr/sbin/lat2vtd tty32 vt
```

Note that in the previous example, the last entry in each line (`vt`) is the name of the optional service defined in step 1.

3. Start up the gateway.

Use the `init q` command to make the changes take effect to start up the gateway, as follows:

```
# init q
```

Use the `ps(1)` command to verify that the `lat2vtd` process has started.

Note that the `lat2vtd` program uses the `syslog(3)` mechanism to log messages to the `/var/adm/syslog.dated/*/daemon.log` file. Check this file to verify that no error messages have been generated.

Use the `/usr/sbin/latcp -s` command to ensure that a multicast for the new service has been sent.

You can now to connect to the LAT/VT Gateway.

Lower-Layer Addressing Information (OpenVMS)

Open-systems communication requires you to share addressing information with the managers of other systems. You must be able to identify and gather lower-layer addressing information for each type of network access: X.25, IEEE 802, and Internet.

This chapter assumes that your system's lower-layer addresses are already properly configured. Therefore, ensure that your system's OSI Transport templates, X.25 services, and IEEE 802 services, are correctly configured and operational.

13.1 Overview of Open-System Networks

Open systems communicate within or between subnetworks. A **subnetwork** is a communications medium in which all participating systems use a common addressing format; for example, an IEEE 802 LAN or an X.25 network. Sometimes, for subnetworks with compatible addressing formats, it is possible to combine two or more subnetworks to form a single, extended subnetwork. Thus, X.25 network vendors can agree to allow communication between their networks to create an extended X.25 subnetwork. Similarly, a bridge can connect two or more IEEE 802 LANs to make a single subnetwork from an extended LAN.

In addition to communicating within a single subnetwork, open systems can often communicate between multiple subnetworks. The **Internet service** spans subnetworks that have distinct addressing rules and communication protocols. Internet allows the system that creates a message (the **source system**) to route messages between subnetworks. Internet uses one or more intermediate systems to reach a target system on a remote subnetwork. An **intermediate system** can receive messages from a system on one subnetwork and pass them on to a system on another subnetwork. The **target system** is the intended destination of the messages and, thus, the final system in a routing sequence.

The first system to receive a message in the routing sequence is called an **adjacent system** in OpenVMS usage. An adjacent system must share a subnetwork with the source system. An adjacent system can be either an intermediate system spanning two subnetworks or a target system that shares a subnetwork with the source system. If an adjacent system is an intermediate system, it relays messages to a system on another subnetwork. If the adjacent system is the target system, it keeps the incoming messages.

The addressing information required to reach a target system depends on the network service to be accessed. Your OSI application can communicate with any other compatible OSI application that shares an X.25 or IEEE 802 subnetwork with your system. Using the OSI Transport Internet service, your system can

Lower-Layer Addressing Information (OpenVMS)

13.1 Overview of Open-System Networks

also communicate with systems on remote subnetworks that are linked by a series of intermediate systems.

13.2 OSI Transport Templates

For a given network service, your network manager configures the network parameters by associating them with a unique **OSI Transport template**. The OSI Transport template is an NCL database entry that manages network access. The OSI Transport template stores some information and may reference information located elsewhere. This OSI Transport template exists in the OSI Transport database.

Each OSI Transport template corresponds to a specific type of network service to which OSI Transport can direct outbound messages and from which it can receive inbound messages. OSI Transport supports three network services: Internet, X.25 CONS, and IEEE 802 with inactive (null) Internet. The following table summarizes the relationship between network services and OSI Transport template types.

Network Service	OSI Transport Template Type
Internet	Internet OSI Template
Direct X.25	X.25 OSI Template
Direct IEEE 802	Null OSI Template

13.3 OSI Transport Addresses

Accessing any target system from an OpenVMS system requires an OSI Transport address. An OSI Transport address, which forms part of each remote-application address in your alias database, allows you to select a type of network access. OSI Transport addresses contain an OSI Transport template name from the local FTAM system and the address of the target system.

The target system's address can be an X.25, physical, or NSAP address:

- An **X.25 address** is the address of a specific piece of data terminal equipment (DTE) that allows network access on an X.25 network.
- A **physical address** is the unique address of a specific system on any IEEE 802 network.
- An **NSAP address** is the address of the network service access point (NSAP) of an Internet system; this address identifies a transport implementation that uses Internet.

The following table summarizes the relationship between the different types of OSI Transport templates and destination addresses:

OSI Transport Template Type	Destination Address Type
Internet OSI Template (CLNS)	NSAP address
X.25 OSI Template (CONS)	X.25 address or NSAP
Null OSI Template	Physical address

13.4 Gathering Lower-Layer Addressing Information

This section discusses how to identify and gather the necessary addressing information for communicating with another system.

The lower-layer addressing information that you need depends on the type of network service that you select: X.25, IEEE 802, or Internet. To access target systems within a local subnetwork, you can select your X.25, IEEE 802, or Internet network service. To access target systems on other subnetworks, you must use the Internet service.

13.4.1 Selecting the OSI Transport Template Type

The following description of how to select an OSI Transport template type assumes that your local OSI Transport template database is correctly configured as described in your DECnet-Plus management documentation. The Network Control Language (NCL) allows you to display information about the OSI Templates on your system. For convenience, you can define your NCL foreign command to `mcr ncl` by placing the following line in your login command file:

```
$ ncl := mcr ncl Return
```

You can activate NCL and display all local OSI Transport templates, as follows:

```
$ ncl Return  
ncl> sho osi transport template * all Return
```

Determine from the following chart which network service to use. Then you must either request that your system manager create a transport template for that service, or use `NET$CONFIGURE` to create the template yourself.

Lower-Layer Addressing Information (OpenVMS)

13.4 Gathering Lower-Layer Addressing Information

1. **Does the target system share a subnetwork with your system?**

If NO

Use an Internet OSI Template and one or more intermediate systems for routing.

If YES

2. **Does the target system require Internet?**

If YES

Use an Internet OSI Template and use the target system as the adjacent system (that is, the first and only system in the routing sequence).

If NO

3. **Does the target system lack Internet support?**

If YES

Use an X.25 or null OSI Template for direct access over your common subnetwork.

If NO

4. **Do you prefer Internet to direct access?**

If YES

Use an Internet OSI Template with the target system as the adjacent system.

If NO

Use an X.25 or null OSI Template for direct access to your common subnetwork.

13.4.2 Addressing Requirements for Direct X.25 Access

Direct X.25 access between your system and another system requires that the systems share an X.25 network. For both inbound and outbound X.25 communications, each system requires a X.25 CONS OSI Template for that network. If your system uses more than one X.25 network, identify the OSI Transport template of the network shared by your system and the target system. If your system lacks the appropriate OSI Template, refer to your DECnet-Plus management documentation for information on setting up X.25 OSI Templates.

Note

For your system to use X.25, both OSI Transport and X.25 must be properly configured as described in your DECnet-Plus management documentation and the *X.25 Management* manual. Also, both OSI Transport and X.25 must be running.

Lower-Layer Addressing Information (OpenVMS)

13.4 Gathering Lower-Layer Addressing Information

13.4.2.1 Addressing Elements

X.25 addressing involves the following elements.

X.25 DTE Destination Addresses

The destination address associated with an X.25 OSI Template is an X.25 address (that is, the **X.25 destination address**). An X.25 destination address always contains a DTE address, which identifies the target system on an X.25 subnetwork. In addition, the destination X.25 address may contain a Transport subaddress.

- **The DTE Address**

The DTE address identifies a system as a unique termination point on an X.25 network. The DTE address of the target system is assigned by its X.25 network vendor. A DTE address is a number containing from 1 to 15 digits.

- **The Transport Subaddress**

The Transport subaddress (if used) identifies the target Transport service provider within the target system. The subaddress consists of either two or four digits.

An X.25 destination address has the following format:

*DTE-ADDRESS*transport-subaddress

Table 13–1 describes the variables of the X.25 destination address.

Table 13–1 X.25 Destination Address Variables

<i>DTE-ADDRESS</i>	The target system's DTE address (supplied by the X.25 network vendor).
<i>transport-subaddress</i>	The subaddress of the target system's Transport service provider, or null.

For example:

Address Component	Value
DTE address	3130608555194
Transport subaddress	10
X.25 destination address	3130608555194 + 10 → 313060855519410

The Call Value and Call Mask

Your X.25 subnetwork may also require a call value to identify the peer Transport service provider for an X.25 connection. For an ISO connection-oriented Network layer specification (CONS) connection, this value is usually 03010100, but not all OSI implementations use that value. Also, some X.25 network vendors lack support for sending call values on connection requests. For more information on call values, see Section 13.4.2, and refer to your DECnet-Plus X.25 Management documentation.

Ensure that the call value and call mask of the target system reflect the agreements regulating your X.25 network by answering the following question:

Do the system managers of your subnetwork have an established call value?

Lower-Layer Addressing Information (OpenVMS)

13.4 Gathering Lower-Layer Addressing Information

If YES

Ensure that your local X.25 Access Template uses the established call data value. If the values in the OSI Template display are incorrect, you can use the `ncl set x25 access template` command to reset them, as follows:

```
ncl> set x25 access template template-name call data '03010100'h Return
```

If NO

No user action required.

The following form is intended to help you gather X.25 addressing information. The sections following the form provide you with information on how to gather the information.

X.25 NETWORK ADDRESSING INFORMATION

Network name	Date
Source system:	Target system:
Manager(s):	

OSI Transport Address for Remote-Application Addresses

Source's X.25 OSI Template name	
Target's X.25 destination address	
	<i>DTE-ADDRESS</i> transport-subaddress

Target System's Network Address Components

DTE address [1 - 15 digits]	
Transport subaddress [2/4 digits, if set]	

Call Information

call mask [FFFFFFFF / other value / not set]	
call value [03010100 / other value / not set]	

Target System's Upper-Layer Address

PSAP:	. SSAP:	. TSAP:	
AP-title (if used):	AE-qualifier (if used):		

Lower-Layer Addressing Information (OpenVMS)

13.4 Gathering Lower-Layer Addressing Information

13.4.2.2 Gathering Remote Addressing Information

This section summarizes the information you need for accessing a remote system directly over an X.25 network. Refer to your DECnet-Plus X.25 management documentation for more information on configuring X.25.

The X.25 OSI Transport Address

Accessing a remote X.25 network service requires an OSI Transport address that contains the local X.25 OSI Transport template name and the X.25 destination address of the target system.

- **OSI Transport template name**

From the OSI Transport template database, choose the Transport template that points to the X.25 Access Template for use with the subnetwork shared by your system and the target system. If the necessary OSI Transport template is lacking on your system, refer to your DECnet-Plus management documentation for information on setting up OSI Transport templates.

- **Destination address**

Use the destination address of the target system in the OSI Transport address for X.25 network access (the X.25 OSI Transport address). To form the X.25 destination address, obtain the target system's DTE address and the shared network's transport subaddress (if used).

Use this destination address in the OSI Transport address for X.25 network access (the X.25 OSI Transport address).

X.25 OSI Transport Address Format Variables

Table 13-2 describes the variables in the OSI Transport address.

Table 13-2 X.25 OSI Transport Address Variables

Variable	Explanation
<i>x.25-transport_template-name</i>	The name of the X.25 OSI template selected from the OSI Transport template database.
<i>x.25-destination-address</i>	The target system's X.25 destination address.

For more information on X.25 OSI Transport templates, see Section 13.4.1.

Call Value and Call Mask

You must also ensure that the call value and call mask of the target system reflect the agreements regulating your X.25 subnetwork. For information on call values, see Section 13.4.2 and your DECnet-Plus management documentation.

13.4.2.3 Gathering Local Addressing Information

You may need to provide a remote system manager with your system's X.25 destination address to allow direct X.25 access to your system. You also need to ensure that your call values agree. Part or all of the local addressing information resides in the OSI Transport template, or X.25 Access template databases. Identify the OSI Transport template of the X.25 network shared by your system and the target system. If the necessary OSI Transport template is lacking on your system, see your DECnet-Plus management documentation for information on setting up OSI Transport templates.

Lower-Layer Addressing Information (OpenVMS)

13.4 Gathering Lower-Layer Addressing Information

After using the `net$configure` command procedure to configure an OSI Transport template, you can display the template information using the `show osi transport template` command. The following example shows the information for a sample OSI Transport template named `x25`.

```
NCL>show osi transport template x25 all

Node 0 OSI Transport Template x25
at 1994-04-20-10:48:19.777-06:00I0.555

Identifiers
  1 Name = x25

Characteristics
  Keepalive Time = 60
  Retransmit Threshold = 8
  Initial Retransmit Time = 5
  CR Timeout = 30
  ER Timeout = 30
  2 Network Service = CONS
  Security = <Default value>
  Classes =
    {
      0 ,
      2 ,
      4
    }
  Checksums = False
  Maximum NSDU Size = 2048
  Expedited Data = True
  3 CONS Template = "OSI Transport"
  Use CLNS Error Reports = False
  Acknowledgement Delay Time = 1
  Local NSAP = <Default value>
  CLNS Inactive Area Address =
    {
    }
  Inbound = True
  Loopback = False
  Send Implementation Id = True
  Extended Format = True
  Network Priority = 0
  Send Preferred maximum TPDU size = True
  Send Request Acknowledgement = True
```

- 1 Simple name assigned to the template when it is created.
- 2 Type of network service.
- 3 Name of the X.25 Access template to be used when establishing a network connection over the CONS. This characteristic points to the X.25 Access template called `osi transport` (shown in the next example).

Notes

Refer to your DECnet-Plus management documentation for more information on CONS and CLNS network services, and X.25 Access templates.

Refer to *DECnet-Plus Network Control Language Reference* for a full description of the characteristics for the OSI Transport template.

Lower-Layer Addressing Information (OpenVMS)

13.4 Gathering Lower-Layer Addressing Information

The following sample display shows the X.25 Access template called OSI Transport. This is the template pointed to by the CONS template characteristic of the OSI Transport template in the previous example.

```
NCL>show x25 access template "OSI Transport" all

Node 0 X25 Access Template "OSI Transport"
at 1994-04-20-10:50:25.227-06:00I0.568

Identifiers
    Name                               = "OSI Transport"

Characteristics
    DTE Class                           = accunet
    1 Destination DTE Address            =
    Call Data                            = '03010100'H
    Local Subaddress                      =
    Selected Group                        = ""
    Packet Size                           = 0
    Window Size                           = 0
    Throughput Class Request              = [0..0]
    Reverse Charging                      = False
    Fast Select                           = Not Specified
    Network User Identity                 = 'H
    Charging Information                   = False
    RPOA Sequence                         =
    {
    }
    Transit Delay Selection                = 2
    Calling Address Extension              = /00
    Target Address Extension                = /00
    End-to-End Delay                      = [0..0]
    Expedited Data                        = Not Specified
    NSAP Mapping                          = False
    Local Facilities                       = 'H
    Quality Of Service                     = 'H
```

1 Address of the remote DTE, including the remote subaddress (if any), to which the call is directed.

Note

Refer to *DECnet-Plus Network Control Language Reference* for a full description of the characteristics for the X.25 Access Template.

13.4.3 Addressing Requirements for Direct IEEE 802 Access

Your system can establish direct IEEE 802 access to systems that support the null Internet protocol and share an IEEE 802 subnetwork with your system. For both inbound and outbound communications that directly use an IEEE 802 network service, your system requires a null OSI Transport template for that service. If your system uses more than one IEEE 802 network, identify the OSI Transport template of the network shared by your system and the target system. If your system lacks a properly configured OSI Template for that network, see your DECnet-Plus management documentation for information on setting up null OSI Transport templates.

Lower-Layer Addressing Information (OpenVMS)

13.4 Gathering Lower-Layer Addressing Information

13.4.3.1 Gathering Remote Addressing Information

For direct IEEE 802 access, the OSI Transport address includes the null OSI Template name and the target system's physical address:

- **OSI Transport template name**

The OSI Transport template name must belong to the null OSI Transport template of the IEEE 802 network shared by your system and the target system. If the necessary OSI Transport template is lacking on your system, Refer to your DECnet-Plus management documentation for information on setting up OSI Transport templates.

- **Destination address**

The destination address associated with a null OSI Transport template is a physical address (that is, the **physical destination address**). To form the physical destination address, obtain the target system's physical address, which contains six pairs of hexadecimal digits.

Use the null OSI Transport template name and physical destination address in the OSI Transport address for IEEE 802 network access (the IEEE 802 OSI Transport address).

13.4.3.2 IEEE 802 OSI Transport Address Variables

null-transport-template%physical-destination-address

Table 13–3 describes the variables of the IEEE 802 OSI Transport address.

Table 13–3 IEEE 802 OSI Transport Address Variables

Variable	Explanation
<i>null-transport-template</i>	The name of the null OSI Transport template selected from the OSI Transport template database.
<i>physical-destination-address</i>	The target system's physical address, which consists of six pairs of hexadecimal digits.

For more information on IEEE 802 OSI Transport addresses, see Section 13.4.1.

The following example shows the information for a sample OSI Transport template named lan, used for 802 connections. It uses the CLNS service so there is no CONS template specified.

```
NCL>show osi transport template lan all
Node 0 OSI Transport Template lan
at 1994-04-20-11:05:10.817-06:00I0.646

Identifiers
    Name                               = lan

Characteristics
```

Lower-Layer Addressing Information (OpenVMS)

13.4 Gathering Lower-Layer Addressing Information

```
Keepalive Time           = 60
Retransmit Threshold     = 8
Initial Retransmit Time  = 5
CR Timeout               = 30
ER Timeout               = 30
Network Service          = CLNS
Security                 = <Default value>
Classes                  =
  {
    4
  }
Checksums                = False
Maximum NSDU Size        = 2048
Expedited Data           = True
CONS Template            = "OSI Transport"
Use CLNS Error Reports   = False
Acknowledgement Delay Time = 1
Local NSAP                = <Default value>
CLNS Inactive Area Address =
  {
    49::FF-00
  }
Inbound                  = True
Loopback                 = False
Send Implementation Id   = True
Extended Format           = True
Network Priority          = 0
Send Preferred maximum TPDU size = True
Send Request Acknowledgement = True
```

13.4.4 Addressing Requirements for Internet Access

Internet adds only a small amount of overhead. Therefore, even when the local and target system are on a common subnetwork, it is reasonable to use Internet for addressing consistency. Alternatively, you can create a separate alias to access each OSI Template type and allow users to choose the type of access they prefer.

Accessing a given Internet service provider requires its NSAP address. When an Internet service provider receives a message for its local NSAP address, the service provider passes the message to the local Transport implementation. For information on the components of NSAP addresses, see your DECnet-Plus management documentation.

The following form is intended to help you gather Internet addressing information. The sections following the form provide you with information on how to gather the information.

Lower-Layer Addressing Information (OpenVMS)

13.4 Gathering Lower-Layer Addressing Information

INTERNET NETWORK ADDRESSING INFORMATION

Network name	Date
Source system:	Target system:
Manager(s):	

OSI Transport Address for Remote-Application Addresses

Source's Internet OSI Template name	
Target's NSAP address	

Target System's Upper-Layer Address

PSAP:	. SSAP:	. TSAP:	.
AP-title (if used):	AE-qualifier (if used):		

13.4.4.1 Gathering Remote Addressing Information

For Internet access, the OSI Transport address includes the OSI Transport template name and the target system's NSAP address:

- **OSI Transport template name**

Identify the Internet OSI Template of your system. If the necessary OSI Template is lacking on your system, see your DECnet-Plus management documentation for information on setting up OSI Transport templates.

- **Destination address**

The destination address associated with an Internet OSI Template is the target system's NSAP address (that is, the **NSAP destination address**).

When getting an NSAP address from other system managers, you must ensure that you get all of its components. See your DECnet-Plus management documentation for a description of the components of the NSAP address.

Use the Internet OSI Template name and the NSAP destination address in the OSI Transport address for Internet network access (the Internet OSI Transport address).

Internet OSI Transport Address Variables

Table 13–4 describes the variables in the OSI Transport address.

Table 13–4 OSI Transport Address Variables

Variable	Explanation
<i>transport-template</i>	The name of your system's Internet OSI Template.

(continued on next page)

Lower-Layer Addressing Information (OpenVMS)

13.4 Gathering Lower-Layer Addressing Information

Table 13–4 (Cont.) OSI Transport Address Variables

Variable	Explanation
<i>nsap-address</i>	The target system's NSAP address, which consists of up to 15 pairs of hexadecimal digits that uniquely identify the target system within the entire OSI network*.

*For OSI Transport, an NSAP address requires a routing record that specifies an adjacency address for the adjacent system.

For more information on Internet OSI Transport addresses, see Section 13.4.1.

13.4.4.2 Gathering Local Addressing Information

You may need to provide a remote system manager with the Internet address of your system. Internet addressing information is in the OSI Transport template display. Determine your Internet address by using the `ncl show node 0 address` command. This section assumes that an Internet OSI Template is already defined by the OSI Transport system manager. If the necessary OSI Transport template is lacking on your system, see your DECnet-Plus management documentation for information on creating Internet OSI Templates.

13.5 Alternative Addressing Terminology

One of the difficulties in communicating with other system managers about OSI addresses is the wide variation in terminology. If differences in terminology inhibit sharing addressing information, you can use Table 13–5 to compare addressing concepts to the corresponding OpenVMS OSI term and possible alternative terms.

Table 13–5 Possible Variations in Addressing Terminology

Addressing Concepts	OpenVMS OSI Term	Possible Alternative Terms *
The address of a specific piece of data terminal equipment (DTE) that allows network access on X.25 networks	X.25 address	DTE address NTN address
The unique address of a single system on any IEEE 802 network	Physical address	IEEE address 802.3 address 802 address Device address (OSI Transport) Ethernet address Hardware address MAC address
An address that identifies the network service access point (NSAP) of an Internet system	NSAP address	Internet address IP address

*Often the alternative terms are not true synonyms of the OpenVMS OSI terms; therefore, you should use the OpenVMS OSI terminology whenever possible.

(continued on next page)

Lower-Layer Addressing Information (OpenVMS)

13.5 Alternative Addressing Terminology

Table 13–5 (Cont.) Possible Variations in Addressing Terminology

Addressing Concepts	OpenVMS OSI Term	Possible Alternative Terms *
A string that identifies a transport service access point (SAP)†	Transport selector	T selector Transport address Transport ID TSAP TSEL
A string that identifies a session SAP†	Session selector	S selector Session address Session ID SSAP SSEL
A string that identifies a presentation SAP†	Presentation selector	P selector Presentation address Presentation ID PSAP PSEL

*Often the alternative terms are not true synonyms of the OpenVMS OSI terms; therefore, you should use the OpenVMS OSI terminology whenever possible.

†See Chapter 9 for more information on SAP selector formats.

Lower-Layer Addressing Information (Digital UNIX)

Open-systems communication requires you to share addressing information with the managers of other systems. You must be able to identify and gather lower-layer addressing information for each type of network access: X.25, IEEE 802, and Internet.

This chapter assumes that you understand the basic concepts of transport selectors, NSAP addresses, and that your system's lower-layer addresses are already properly configured. Therefore, ensure that your system's OSI Transport templates are correctly configured, and ensure that your X.25 services, IEEE 802 services, or both are correctly configured and operational. For more information, refer to *DECnet-Plus Network Control Language Reference*.

14.1 Overview of Open-System Networks

Open systems communicate within or between subnetworks. A **subnetwork** is a communications medium in which all participating systems use a common addressing format. For example, an IEEE 802 LAN, and an X.25 network are two examples of subnetworks. Sometimes, for subnetworks with compatible addressing formats, it is possible to combine two or more subnetworks to form a single, extended subnetwork. Thus, X.25 network vendors can agree to allow communication between their networks to create an extended X.25 subnetwork. Similarly, a bridge can connect two or more IEEE 802 LANs to make a single subnetwork from an extended LAN.

In addition to communicating within a single subnetwork, open systems can often communicate between multiple subnetworks. This function is provided by the network layer. The **OSI Connectionless Network Service (CLNS)** spans subnetworks that have distinct addressing rules and communication protocols. CLNS allows the system that creates a message (the **source system**) to route messages between subnetworks. CLNS uses one or more intermediate systems to reach a target system on a remote subnetwork. An **intermediate system** can receive messages from a system on one subnetwork and pass them to a system on another subnetwork. The **target system** is the intended destination of the messages and, thus, is the final system in a routing path.

The routing layer on DECnet/OSI for Digital UNIX end system transmits data PDUs to an adjacent system. The adjacent system must share a subnetwork with the source system. An adjacent system can be either an intermediate system spanning two subnetworks or a target system. If an adjacent system is an intermediate system, it relays messages to a system on another subnetwork. If the adjacent system is the target end system, it keeps the incoming message and passes it up to the transport layer.

Lower-Layer Addressing Information (Digital UNIX)

14.1 Overview of Open-System Networks

OSI Transport provides end-to-end communication, and guarantees data integrity. It makes sure that all messages are passed between the applications in the correct order. This service is called **Class-4**. A Class-4 service is needed because CLNS is only a data gram service, and does not guarantee that each data message will be delivered. However, OSI Transport has the capability of operating directly over X.25 through the **Connection-Orientated Network Service (CONS)**. When configured to do so, the OSI Transport can operate with a subset of its functions, relying on X.25 to guarantee data integrity. OSI Transport **Class-2** provides message sequencing and flow control, while **Class-0** relies only on X.25 for data integrity.

The addressing information required to reach a target system depends on the network service to be accessed. Your FTAM system can communicate with any compatible FTAM system that shares one or more of the same network configurations supported by DECnet/OSI for Digital UNIX. These services are selected by specifying the name of a template (discussed in Section 14.2). You must also specify a transport address (TSEL) and a network address (NSAP) (discussed in Section 14.3.1).

14.2 OSI Transport Templates

For a given network service, the DECnet/OSI for Digital UNIX configures the network parameters by associating them with a unique **OSI Transport Template**. The OSI Transport Template is an NCL database entry that manages network access, and contains information describing how to make a transport connection. The installation procedure creates three templates named default, CONS, and any.

The default template is used to establish OSI Transport Class-4 connections operating over CLNS.

The CONS template is used to create OSI Transport Class-2, or Class-0 connections operating over CONS/X.25.

The any template can be specified by a listener to accept incoming connections over either CLNS or CONS/X.25 network services. Note that this template cannot be used for outgoing connections.

Table 14–1 summarizes these templates.

Table 14–1 OSI Transport Templates

Transport Class	Network Service	OSI Transport Template
4	CLNS	default
0, 2, 4	CONS/X.25	cons
4, 2, 0 (listener only)	CLNS, CONS/X.25	any

14.3 Overview of OSI Lower-Layer Addressing

OSI lower-layer addressing involves several types of addresses: OSI Transport addresses, NSAP addresses, LAN or DTE addresses. Along with these addresses, the name of an OSI Transport Template may be passed by the application to the transport layer. If no template name is passed, OSI transport uses the default template when establishing the connection.

Lower-Layer Addressing Information (Digital UNIX)

14.3 Overview of OSI Lower-Layer Addressing

14.3.1 OSI Transport Addresses

Accessing any target system requires an OSI Transport address or *T-selector* (*TSEL*). The TSEL is used by transport to specify the transport client (in this case FTAM), and can be from 0 to 32 bytes long.

14.3.2 Network Addresses

The target system's network address is an **NSAP address**. An NSAP address is the address of the network service access point (NSAP) of an OSI system. This address identifies a specific transport implementation that is a client of the network service. The NSAP address can be up to 20 octets, or bytes long. NSAP addresses are always used regardless of the underlying network service (CONS or CLNS).

14.3.3 IEEE 802 LAN Addresses

If your end system is attached to a LAN, then it will have a 6 octet data link address assigned to it. The address will either be the hardware address assigned to the device by the manufacturer, or it will be Phase IV style LAN address created when DECnet is installed and Phase IV backward compatibility is required. The normal configuration does not require the OSI application to know about LAN addresses. CLNs will automatically determine the correct LAN address to use when it forwards a PDU.

The one exception is when an application wants to use a subset, or null internet. In this case, the destination NSAPs must be derived by concatenating the inactive area address, the target's LAN address, and its network selector, for example: 0x21. For more information on the inactive subset, and inactive area address, refer to *DECnet-Plus Network Control Language Reference*.

14.3.4 X.25 Addressing Elements

If OSI Transport is configured to operate directly over CONS/X.25, then you must configure your system to use DTE addresses to access the remote X.25 system. The DTE address identifies a system or a unique termination point on an X.25 network. It is usually supplied by the X.25 network vendor providing access to the system, and it can contain from 1 to 15 digits.

DTE addresses can be passed in one of three ways:

- By using an X.121 NSAP address which contains the DTE address (X.25 Address Extension Facility supported).
- By using an X.121 NSAP address which contains the DTE address (X.25 Address Extension Facility not supported).
- By creating X.25 Access Reachable Address entries that map non X.121 NSAP address to DTE addresses.

Also, if CLNS is configured over X.25, you must use DTE addresses to access the remote X.25 system. This can be done in one of two ways:

- By using an X.121 NSAP address
- By creating a Routing Circuit Reachable address that maps NSAP addresses to DTE addresses.

Section 14.4 explains these addresses and shows examples.

For additional information, refer to the X.25 documentation.

Lower-Layer Addressing Information (Digital UNIX)

14.4 Gathering Lower-Layer Addressing Information

14.4 Gathering Lower-Layer Addressing Information

This section discusses how to identify and gather the necessary addressing information for communicating with another system.

14.4.1 Selecting the OSI Transport Template Type

The following description of how to select an OSI Transport Template type assumes that your local OSI Transport Template database is correctly configured as described in the DECnet/OSI for Digital UNIX management documentation. The Network Control Language (NCL) allows you to display information about the OSI Templates on your system.

You can activate NCL and display all local OSI Transport Templates, as follows:

```
$ ncl   
ncl> sho osi transport template * all 
```

Determine from the following chart which network service to use. If none of the available templates meet your needs, you must create a transport template for that service.

1. **Does the target system require TP4 using CLNS?**¹

If YES

Use the default OSI Transport Template.

If NO

2. **Does the target system require TP0, TP2, or TP4 using CONS/X.25 support?**

If YES

Use CONS OSI Transport Template for direct access over your X.25 network.

14.4.2 Determining the Target System's NSAP Address

If connectivity to the target system requires full CLNS support you will need that system's NSAP address. Contact the target system manager for this information.

If you are using the inactive subset support provided by CLNS, the target system's NSAP address is divided by concatenating the inactive area address with the target system's LAN address and network selector.

You can obtain the inactive area address by entering the following command to the routing circuit entity adjacent to the target system:

```
ncl> show routing circuit circuit-1 inactive area address 
```

To obtain the target system LAN address and network selector, contact the target system manager.

If connectivity to the target system requires OSI Transport over CONS/X.25, contact the target system manager to obtain the NSAP or DTE address.

¹ Note that CLNS provides support for the inactive subset.

Lower-Layer Addressing Information (Digital UNIX)

14.4 Gathering Lower-Layer Addressing Information

14.4.3 Addressing Requirements for Direct X.25 Access (CONS)

Direct X.25 access between your system and another system requires that the systems share an X.25 network. For both inbound and outbound X.25 communications, each system requires a CONS template for that network. If your system uses more than one X.25 network, identify the OSI Transport Template of the network shared by your system and the target system. If your system lacks the appropriate OSI Template, refer to the DECnet-Plus management documentation for information on setting up additional CONS templates.

Note

For your system to use X.25, both OSI Transport and X.25 access must be properly configured as described in your installation and configuration documentation. Also, both OSI Transport and X.25 must be running.

14.4.3.1 The Call Data Value and Call Mask

Your X.25 subnetwork may also require a call data value to identify the peer transport service provider for an X.25 connection. This call data value can be found in the X.25 access template used for outgoing calls, and the X.25 access filter used for incoming calls.

The ISO Connectionless Network layer (CLNS) specification (ISO 8473) defines this value as 0X81, and CONS defines this value as 03010100. Some X.25 network vendors lack support for sending call data values on connection requests.

For more information on call data values, refer to your DECnet-Plus management documentation.

Ensure that the call data value and call mask of the target system reflect the agreements regulating your X.25 network by answering the following question:

Do the system managers of your subnetwork have an established call data value?

If YES

Ensure that your local X.25 Access Template and filter uses the established call data value. Also, ensure that the X.25 Access filter call mask agrees with the instructions in the *DECnet-Plus Network Control Language Reference* documentation. If the values in the Template display are incorrect, you can use the NCL set x25 access template command to set them, as follows:

```
ncl> disable x25 access template template-name 
ncl> set x25 access template template-name call_data 
      (need a value for call_data & example of call mask)
ncl> enable x25 access template template-name 
```

If NO

Clear your local X.25 Access Template's call data value and call mask fields, as follows:

```
ncl> disable x25 access template template-name 
ncl> clear x25 access template template-name CALL_VALUE 
ncl> enable x25 access template template-name 
```

Lower-Layer Addressing Information (Digital UNIX)

14.4 Gathering Lower-Layer Addressing Information

Clearing a call data value or call mask causes its value to appear as "not set" on a display.

Note

X.25 Access Templates and filters must be enabled to be used. If the display indicates that the "State" is "Disabled", enable them by entering the `ncl enable x25 access template template-name` and `ncl enable x25 access filter filter-name` commands.

The following form is intended to help you gather X.25 addressing information on remote systems. The sections following the form provide you with more information on performing this task.

X.25 NETWORK ADDRESSING INFORMATION

Network name	Date
Source system:	Target system:
Manager(s):	

Target System's Upper-Layer Address

PSAP:	. SSAP:	. TSAP:	.
AP-title (if used):	AE-qualifier (if used):		

OSI Transport Address for Remote-Application Addresses

OSI Transport address	
Source's CONS OSI Template name	
Target's NSAP destination address (if available)	

Target System's Network Address Components

DTE address [1 - 15 digits]	
-----------------------------	--

Call Information

call mask [FF / other value / not set]	
call data value [00 / other value / not set]	

Lower-Layer Addressing Information (Digital UNIX)

14.4 Gathering Lower-Layer Addressing Information

14.4.3.2 Gathering Remote Addressing Information for TP/CONS Configuration

This section summarizes the information you need for accessing a remote system directly over an X.25 network. Refer to the DECnet-Plus management documentation for more information on configuring X.25.

The X.25 OSI Transport Address

Accessing a remote X.25 network service over CONS requires a local CONS OSI Transport Template name, and either the NSAP destination address of the target system, the DTE destination address of the target system, or both.

- **OSI Transport Template name**

From the OSI Transport Template database, choose the OSI Transport Template to be used with the subnetwork shared by your system and the target system. If the necessary OSI Transport Template is not on your system, refer to the DECnet-Plus management documentation for information on setting up OSI Templates.

- **NSAP Destination address**

Use the destination NSAP address of the target system in the OSI Transport address for X.25 network access (the X.25 OSI Transport address).

14.4.3.3 Gathering Local Addressing Information

You may need to provide a remote system manager with your system's X.25 DTE and NSAP addresses to allow direct X.25 access to your system. You also need to ensure that your call data values agree. Part or all of the local addressing information resides in the OSI Transport Template, and the X.25 Access and X.25 protocol DTE databases. Identify the OSI Transport Template of the X.25 network shared by your system and the target system. If the necessary OSI Transport Template is not on your system, refer to the DECnet-Plus management documentation for information on setting up OSI Transport Templates.

You can display the Template information using the `show osi transport template` command. The following example shows the information for a sample OSI Transport Template named `cons`.

```
ncl> show osi transport template cons all Return
Show Node 0 OSI Transport Template cons
  at 1992-04-14-08:09:00.69049 + 00:00 I 00.00000
Identifiers
1 Name = cons
```

Lower-Layer Addressing Information (Digital UNIX)

14.4 Gathering Lower-Layer Addressing Information

```
Characteristics
  Keepalive Time = 60
  Retransmit Threshold = 8
  Initial Retransmit Time = 5
  CR Timeout = 30
  ER Timeout = 30
  2 Network Service = CONS
  Security = %X
  Classes = {0, 2, 4}
  Checksums = False
  Maximum NSDU Size = 2048
  Expedited Data = True
  3 CONS Template = "osi transport"
  Use CLNS Error Reports = False
  Acknowledgement Delay Time = 1
  Local NSAP
  CLNS Inactive Area Address = {}
  Inbound = True
  Loopback = False
```

- 1 Simple name assigned to the template when it is created.
- 2 Type of network service.
- 3 Name of the X.25 Access module template to be used when establishing a network connection over CONS. This characteristic points to an X.25 Access module's template called OSI Transport (shown in the next example).

Notes

Refer to your DECnet-Plus Management documentation for more information on CONS and CLNS network services, and X.25 Access module templates.

Refer to your DECnet-Plus Network Control Language documentation for a full description of the characteristics for the OSI Transport Template.

The following sample display shows the X.25 Access Template called OSI Transport. This is the template pointed to by the CONS Template characteristic of the OSI Transport Template in the previous example.

```
ncl>sho x25 access template * all

Show Node 0 X25 Access Template "osi transport"
  at 1992-04-14-08:09:16.96049 + 00:00 I 00.00000

Identifiers
  Name = "osi transport"
```

Lower-Layer Addressing Information (Digital UNIX)

14.4 Gathering Lower-Layer Addressing Information

```
Characteristics
1 DTE Class = "accunet"
  Destination DTE Address =
  Call Data = %X03010100
  Local Subaddress =
  Selected Group = ""
  Packet Size = 0
  Window Size = 0
  Throughput Class Request = [0..0]
  Reverse Charging = False
  Fast Select = Not Specified
  Network User Identity = %X
  Charging Information = False
  RPOA Sequence = {}
  Transit Delay Selection = [0..0]
  Calling Address Extension
  Target Address Extension
  End-to-End Delay = [0..0]
  Expedited Data = Not Specified
  NSAP Mapping = False
  Local Facilities = %X
  Quality Of Service = %X
```

1 DTE Class is a required field.

Note

Refer to your DECnet-Plus Network Control Language documentation for a full description of the characteristics for the X.25 Access template and protocol DTE Class.

The following form is intended to help you gather IEEE 802 networking information. The sections following the form provide you with information on how to gather the information.

IEEE 802 NETWORK ADDRESSING INFORMATION

Network name

Date

Source system:

Target system:

Manager(s):

OSI Transport Address for Remote-Application Addresses

OSI Transport address

default

Source's null OSI Template name

Target's physical address

Lower-Layer Addressing Information (Digital UNIX)

14.4 Gathering Lower-Layer Addressing Information

14.4.5.1 Gathering Remote Addressing Information

For CLNS access, the default OSI Transport Template is automatically used, and need not be specified. However you must specify the target system's NSAP address.

When getting an NSAP address from other system managers, you must ensure that you get all of its components. Table 14–2 describes the variables in the OSI Transport address.

Table 14–2 OSI Transport Address Variables

Variable	Explanation
<i>transport-template</i>	The default template
<i>nsap-address</i>	The target system's NSAP address, which consists of up to 20 pairs of hexadecimal digits that uniquely identify the target system within the entire OSI network

14.4.5.2 Gathering Local Addressing Information

You may need to provide a remote system manager with the NSAP addresses of your system. These addresses are used in the following protocols:

- Full CLNP header
- Null IP

To determine the values in use on your system, use the following NCL command:

```
ncl> show address 
```

The values labeled `DNA_OSInetwork` are the system's NSAPs. For example:

```
(  
  [ DNA_CMIP-MICE ] ,  
  [ DNA_SessionControlV3 , number=19 ] ,  
  [ DNA_OSIttransportV1 , 'DEC0'H ] ,  
  [ DNA_OSInetwork , 41:45418715:00-41:08-00-2B-37-65-51:21 ]  
) ,
```

14.5 Alternative Addressing Terminology

One of the difficulties in communicating with other system managers about OSI addresses is the wide variation in terminology. If differences in terminology inhibit sharing addressing information, you can use Table 14–3 to compare addressing concepts to the corresponding OSI term and possible alternative terms.

Lower-Layer Addressing Information (Digital UNIX)

14.5 Alternative Addressing Terminology

Table 14–3 Possible Variations in Addressing Terminology

Addressing Concepts	OSI Term	Possible Alternative Terms *
The address of a specific piece of data terminal equipment (DTE) that allows network access on X.25 networks	X.25 address	DTE address NTN address
The unique address of a single system on any IEEE 802 network	Physical address	IEEE address 802.3 address 802 address Device address (OSI Transport) Ethernet address Hardware address MAC address
An address that identifies the network service access point (NSAP) of an Internet system	NSAP address	Internet address IP address
A string that identifies a transport service access point (SAP)†	Transport selector	T selector Transport address Transport ID TSAP TSEL
A string that identifies a session SAP†	Session selector	S selector Session address Session ID SSAP SSEL
A string that identifies a presentation SAP†	Presentation selector	P selector Presentation address Presentation ID PSAP PSEL

*Often the alternative terms are not true synonyms of the OSI terms; therefore, you should use the OSI terminology whenever possible.

†See Chapter 9 for more information on SAP selector formats.

Appendixes

FTAM Command Summary (OpenVMS)

This appendix describes the OpenVMS FTAM commands in detail. The commands appear in alphabetical order. The following table summarizes the functions of the FTAM commands.

Command	Function
append	Concatenate file data.
copy	Copy file data.
delete	Remove file data.
directory	List files.
rename	Change the name of a file.

Note

If a remote file is specified as part of the input/output file specifications, the actions taken by the command and its qualifiers depend on the remote FTAM responder functionalities and support.

append

append

Name

append — append file data

Syntax

```
append/app=ftam [/qualifier(s)] input-file-spec [,...] output-file-spec
```

See the `copy` command summary for a description of the `append` command variables and qualifiers.

Description

The `append` command appends files from a remote system to a local system, from a local system to a remote system, or from a remote system to another remote system.

Restriction

See the `copy` command summary for a description of the `append` command restrictions.

Multiple input files are not currently supported.

Example

```
$ append/app=ftam/new_ver freunde::"^\vol>main>file.ext"-   
_ $ ,test.dat targetest.dat 
```

This command appends the input file, `^\vol>main>file.ext`, from `freunde`, and the local input file, `test.dat` (assuming the files have a single contents type), to the local output file, `targetest.dat`.

Note that without the double quotation marks (" ") enclosing the file designation `^\vol>main>file.ext`, DCL would interpret the symbol `^` as a parameter delimiter and would generate the following error:

```
%DCL-W-PARMDEL, invalid parameter delimiter - check ...  
  \^VOL\
```

copy
Name

copy — copy file data

Syntax

```
copy/app=ftam [/qualifier(s)] input-file-spec [,...] output-file-spec
```

The command variables are:

<i>/qualifier</i>	A qualifier of the command.
<i>input-file-spec</i>	A file specification of an input (source) file, which can be either local or remote.
<i>[, ...]</i>	A list of file specifications for one or more additional input files. Within a list, you must precede each additional file specification with a comma (,) or a plus sign (+) with or without a space. To end an input file list, omit the comma or plus sign between the last input file specification and the output file specification, or press Return. Input files can be from the same or different FTAM systems, or from the local system.
<i>output-file-spec</i>	The name of an output file. Because FTAM always creates only one output file, both the copy and append commands accept only one output-file specification. For local output files, copying or appending a file into a local directory is controlled by the same rules that control the RMS copy and append utilities. If you specify no directory, the utility places the output file in your default directory. If you specify another local directory for which you have write privileges, the utility places the output file in that directory. For remote output files, always specify the full file designation. For information on where a remote FTAM system places an output file that is created remotely using FTAM, see the documentation of the remote system.

copy

The qualifiers are:

`/allocation[=n]`

This qualifier sets the initial allocation for the output file to the number of 512-byte blocks specified by *n*. If you omit a number, the allocation equals the size of the input file.

The allocated blocks are equated to the FTAM file attribute of `future-filesize`. The number of 512-byte blocks specified with the `/allocation` qualifier maps to the FTAM `future-filesize` parameter on `F-CREATE` request. The implementation of the `future-filesize` parameter is a local matter and is beyond the scope of FTAM.

The FTAM responder does not allocate files based on the `future-filesize` parameter received on `F-CREATE-REQUEST`. Instead, the FTAM responder saves this parameter in the ACL of the created file. When the FTAM COPY facility is used to transfer a file from a remote FTAM system, it receives the `future-filesize` parameter from the `F-READ-ATTRIB-RESPONSE` and saves it in the ACL of the created file.

FTAM always allocates files based on the `filesize` parameter of the `F-CREATE-REQUEST` and `F-READ-ATTRIB-RESPONSE` primitives.

Default value: Size of input file

`/backup`

This qualifier works only with `/before` or `/since` to select files according to whether they were backed up before or since a given date. The `/backup` qualifier is mutually exclusive with `/created`, `/expired`, and `/modified`.

Default date: `/created`

`/before[=time]`

This qualifier selects only those files that are dated before the value specified for *time*, which is specified using absolute or combination time. Associated qualifiers are `/backup`, `/created`, `/expired`, or `/modified`.

Default value: `=today`

`/by_owner[=uic]`

This qualifier selects only files whose user identification code (UIC) is specified for the *uic* value.

Default value: UIC of current process

`/character_set=`

This qualifier specifies which character set the file data belongs to, and instructs FTAM to encode the data accordingly. For example, to copy file data of the Japanese character sets Kanji and Katakana, the user must supply the `character_set=` qualifier with the value `JP_INTAP2`.

Default action: No character set specified

/concatenate /noconcatenate	(For copy command only.) This qualifier controls whether multiple input files create corresponding multiple output files or create a single output file containing the concatenated contents of all the input files. Concatenation, which is the default, involves combining multiple input files (in their input order) into a single output file. For concatenation, all the input files must have identical file organization, record format, and record attributes. Creating multiple output files, which requires local input files, requires the /noconcatenate qualifier.
/confirm /noconfirm	<p>Default action: concatenate</p> <p>This qualifier controls whether the copying or appending facilities ask you to copy or append each input file. For each input file, the FTAM either queries: "Copy <i>filename</i>? [N]" or "Append <i>filename</i> to <i>filename</i>? [N]". Issue one of the following responses:</p> <ul style="list-style-type: none"> • To affirm copying/appending a specific file, enter <i>yes</i>, <i>true</i>, or <i>1</i>. • To prevent copying/appending a specific file, enter <i>no</i>, <i>false</i>, <i>0</i> or press Return. • To continue copying/appending without further confirmations, enter <i>all</i>. • To stop all copying/appending, enter <i>quit</i> or press Ctrl/Z.
/contiguous /nocontiguous	<p>Abbreviations and any mixture of uppercase and lowercase letters are acceptable for responses.</p> <p>Default action: /noconfirm</p> <p>This qualifier indicates whether the output file must occupy consecutive physical disk blocks. For the append command, this qualifier is only relevant with the /new_version qualifier.</p>
/created	<p>Default action: /nocontiguous (not the RMS default)</p> <p>This qualifier works only with /before or /since to select files according to whether they were created before or since a given date. The /created qualifier is mutually exclusive with /backup, /expired, and /modified.</p>
/delete /nodelete	<p>Default date: /created</p> <p>(For copy command only.) This qualifier causes the copying facility to delete the input file(s) after the input file(s) have been copied to the output file.</p> <p>Default action: /nodelete</p>

copy

<code>/exclude=(file-spec)[,...]</code>	<p>This qualifier causes the copying or appending facilities to ignore any file whose file specification matches an excluded file specification. When excluding a single file, you can omit the parentheses. Device names and version numbers are unsupported. Using wildcards for file name and type is permitted.</p> <p>Default action: No exclusion; all input files are copied.</p>
<code>/expired</code>	<p>This qualifier works only with <code>/before</code> or <code>/since</code> to select files according to whether they will expire before or since (after) a given date. The <code>/expired</code> qualifier is mutually exclusive with <code>/backup</code>, <code>/created</code>, and <code>/modified</code>.</p> <p>Default date: <code>/created</code></p>
<code>/extension=n</code>	<p>This qualifier specifies the number of blocks (<i>n</i>) to be added to the output file whenever it is extended. For the append command, this qualifier is only relevant with the <code>/new_version</code> qualifier.</p> <p>Default value: The default extension for the local system — usually 3 (not the RMS default)</p>
<code>/journal</code>	<p>This qualifier controls whether you want the FTAM service provider to negotiate Recovery and Restart with the peer FTAM entity (if it supports Recovery). When the <code>/journal</code> qualifier is present, FTAM inserts checkpoints within the data and maintains a docket that contains Recovery-related information.</p> <p>If an error occurs during data transfer and the image has not exited, the FTAM protocol machine attempts to recover from the error, using the information in the docket.</p> <p>Default action: No journaling</p>
<code>/log</code> <code>/nolog</code>	<p>This qualifier controls whether the copying or appending facility displays the input and output file designations of each copied (or appended) file. The <code>/log</code> qualifier displays the following information:</p> <ul style="list-style-type: none">• The file designations of each affected file• The number of blocks or records affected• The total number of affected files <p>Default action: <code>/nolog</code></p>
<code>/modified</code>	<p>This qualifier works only with <code>/before</code> or <code>/since</code> to select files according to whether they were last modified before or since a given date. The <code>/modified</code> qualifier is mutually exclusive with <code>/backup</code>, <code>/created</code>, and <code>/expired</code>.</p> <p>Default action: <code>/created</code></p>

`/new_version`
`/nonew_version` (For append command only.) This qualifier controls whether the FTAM appending facility creates a new output file, if the specified output file does not exist. If the specified output file does exist, the `/new_version` qualifier is ignored and the input file is appended to the output file.

Default action: `/nonew_version`

`/parameter=concurrency_control=parameter:value`
`[,parameter:value...]`

This qualifier gives users the ability to specify the file-locking parameters and values that are defined in ISO standard 8571. The possible file-locking parameters are: `read`, `insert`, `replace`, `extend`, `erase`, `read_attribute`, `change_attribute`, and `delete_file`.

The allowed values for these file-locking parameters are: `not-required`, `shared`, `exclusive`, or `no-access`. (The FTAM responder does not support the `no-access` value.)

The file-locking value of `not-required` will be supplied for any file-locking parameters that do not appear on the command line.

Default action: No `concurrency_control` is used

`/parameter=create_password=(password)`

This qualifier gives users the ability to pass a password value, if the responding FTAM entity (an FTAM listener) **requires** a password in order for anyone to create a file on its file system. This file system password is not the same as a password for logging into an account.

Default action: No `create_password` used

`/parameter=security=(action=(access-request[,access-request...]),`
`[concurrency=(ca-name:ca-key[,ca-name:ca-key...])],`
`[password=(apwd-name:apwd-string[,apwd-name:apwd-string...])],`
`[identity=user-identity-string],`
`[legal=legal-qual-string])`

This qualifier allows the user to implement FTAM security group functions. These functions only apply for local to remote, or remote to remote file copying.

The string list specified on the command line must be enclosed within single or double quotes. All white space appearing within these quotes is ignored.

The entire security string must be enclosed within parentheses, and multiple entries within the parentheses must be separated by commas.

You can abbreviate parameter values as long as there are enough characters for a unique value.

copy

You can use a dash (-) to continue any portion of the security group specification onto a new line.

You can specify more than one security group; however you must flag each new group list element with its own /parameter=security qualifier. Note that the legal qualification parameter can only be specified once.

The action=(*access-request*) is mandatory. concurrency, password, identity, and legal are optional.

The allowed values for access-request, ca-name, and apwd-name are read, insert, replace, extend, erase change-attribute, read-attribute, and delete-file.

The allowed values for ca-key are not-required, shared, exclusive, and no-access.

The expected input for apwd-string, user-identity, and legal-qual-string is GraphicString.

Default action: No security is used

/replace
/noreplace

(For copy command only) This qualifier determines how the copy operation responds when the file specification requested for an output file already exists. By default, when an output file specification duplicates the specification for a file that already exists, the command generates an error condition and no output file is created.

The /replace qualifier, however, causes a copy command to replace the pre-existing file. The new file has the same file specification as the pre-existing file. Usually, it is best to use the complete file specification of the file being replaced as your output-file specification.

Default action: /noreplace

/since[=*time*]

This qualifier selects only those files that are dated after the specified value, *time*, which is specified using absolute or combination time. Associated qualifiers are /backup, /created, /expired, or /modified.

Default value: =today

/volume=*n*

(For copy command only.) This qualifier directs an entire output file to a specified relative volume number (*n*) of a multivolume set of disks.

Default value: Arbitrary position within multivolume set

Description

The `copy` command copies files from a remote system to a local system, from a local system to a remote system, or from a remote system to another remote system.

Restrictions

Multiple input files are not currently supported.

The following table identifies the null qualifiers of the `copy` and `append` commands.

Null Qualifier	FTAM Functioning for Remote Files
<code>/[no]overlay</code>	FTAM writes an output file onto newly allocated disk space for FTAM-1 and FTAM-3 document types. For an FTAM-2 document type, FTAM creates a new file.
<code>/protection=(code)</code>	FTAM specifies the protection of the output file as the current default protection.
<code>/[no]read_check</code> <code>/[no]write_check</code>	FTAM does not check for differences between an input and an output file; instead, it relies on the underlying OSI layers to ensure the integrity of user data.
<code>/[no]truncate</code>	Unless you allocate extra blocks using the <code>/allocation</code> qualifier, FTAM always truncates the output file. If one or more input files contain unused blocks, the facility reduces the file size of the output file to the number of blocks that actually hold file data.

Support for RMS `copy` and `append` command qualifiers varies substantially for local and remote files. For local files, the facilities support most of the DCL command qualifiers. However, for remote FTAM files, the copying and appending facilities support only a few of those qualifiers. This section describes the qualifiers that are supported for each type of file. For a summary of supported DCL `copy` qualifiers, see Table A-1. For an explanation of the qualifiers supported by the DAP-FTAM Gateway, see Section 3.3. More detailed descriptions of supported qualifiers follow the summary.

Note

The FTAM copying facility generally implements standard RMS defaults, with the exception of the `/[no]contiguous`, `/created`, `/expired`, `/extension=n` and `/modified` qualifiers, which have a nonstandard (non-RMS) default value or action with the `copy` command.

Table A-1 DCL copy and append Command Qualifiers

Qualifier	Qualifier Type	DAP-FTAM Gateway	Support for FTAM Files	
			Remote Files	Local Files
<code>/allocation[=n]</code>	Output	y	y	y
<code>/backup*</code>	Input			y
<code>/before[=time]</code>	Input			y
<code>/by_owner[=uic]</code>	Input			y
<code>/character_set=</code>	Output		y	
<code>/[no]concatenate †</code>	Output	y	y	y
<code>/[no]confirm</code>	Global‡	y	y	y
<code>/[no]contiguous</code>	Output			y
<code>/created*</code>	Input			y
<code>/[no]delete†</code>	Global‡		y	y
<code>/exclude=(file-spec[,...])</code>	Input			y
<code>/expired*</code>	Input			y
<code>/extension=n</code>	Output			y
<code>/journal</code>	Global‡		y	
<code>/[no]log</code>	Global‡	y	y	y
<code>/modified*</code>	Input			y
<code>/[no]new_version\$</code>	Output	y	y	y
<code>/parameter=concurrency_control</code>	Global‡		y	
<code>/parameter=create_password</code>	Global‡		y	
<code>/parameter=security</code>	Global‡		y	
<code>/[no]replace†</code>	Output	y	y	y
<code>/since[=time]</code>	Input			y
<code>/volume=n†</code>	Output			y

*The `/backup`, `/created`, `/expired`, and `/modified` qualifiers, which work only with the `/before` or the `/since` qualifier, are mutually exclusive.

\$This qualifier applies **only** to the `append` command.

†This qualifier applies **only** to the `copy` command.

‡Global indicates that a qualifier operates independently of the input and output files.

Examples

```
$ copy/app=ftam test.dat amiguita::"\dir\file" 
```

This command copies the single local file `test.dat` to `\dir\file` on `amiguita`.

Note that without the double quotation marks (" ") enclosing `\dir\file`, RMS would generate the following error:

```
%COPY-F-OPENIN, error opening AMIGUITA::\DIR\FILE as input
-RMS-F-SYN, file specification syntax error
```

```
$ copy/app=ftam test.dat lesamies::"test.dat" 
```

This command copies the single local file `test.dat` to `test.dat` on `lesamies`. Because the output-file designation is enclosed in double quotation marks (" "), the lowercase characters entered in the command are retained in the output-file designation sent to the remote FTAM system.

```
$ copy/concat/app=ftam *.dat freunde::newfile.dat 
```

This command alphabetically concatenates the `.dat` files in the local default directory into `newfile.dat` on system `freunde`. Concatenation ceases if any file differs in file organization, record format, or record attributes from those of the first `.dat` file listed in the directory.

```
$ copy/app=ftam mitra::file.dat [main.sub] 
```

This command copies the remote file `file.dat` to the local RMS directory `[main.sub]`. The resulting file specification is `[main.sub]file.dat`.

```
$ copy/app=ftam mala::"\dir\file" mala::"\new\file" 
```

This command copies the file `\dir\file` on `mala` to the output file `\new\file` on the same system. Note that the file passes through the local FTAM system but is not opened or stored locally.

```
$ copy/app=ftam test.dat lente::"/dir/sub/test/dat"- 
_ $ /alloc=90 
```

This command sets the future file size of `/dir/sub/test/dat` on remote node `lente` to 90 blocks.

Note that without the double quotation marks (" ") enclosing the file designation `/dir/sub/test/dat`, DCL would interpret `/dir` as a qualifier and would generate the following error:

```
%DCL-W-IVQUAL, unrecognized qualifier - check ...
\DIR\
```

```
$ copy/app=ftam/confirm pungyo::file.dat file.dat 
Copy PUNGYO::FILE.DAT? [N] Y 
```

This command requires confirmation. After you enter `y`, it copies the file `file.dat` from the system `pungyo` to the local system.

copy

```
$ copy/concat/app=ftam /exclude=(*.dir,*.log) [...] - Return  
_ $ pungyo::"dir/sub/file.ext" Return
```

This command concatenates all files in the local default directory except those having the extensions `.dir` or `.log`. The output file is a remote file `dir/sub/file.ext` on the remote FTAM system `pungyo`.

```
$ copy/app=ftam /replace lente::"/dir/file/ext" file.dat;5 Return
```

This command causes the contents of a remote file, `/dir/file/ext`, from the remote FTAM system `lente`, to replace the contents of a local file, `file.dat;5`. The local file retains the original file name, `file.dat;5`.

```
$ copy/app=ftam/param=concurrency_control=(read:shared,- Return  
_ $ read_attribute:shared,erase:not-required) - Return  
_ $ /param=create_password=myspassword- Return  
_ $ amiguita::"/dir/file/ext" amiguita::"file_a.dat" Return
```

This command copies the contents of the remote file, `/dir/file/ext` on remote FTAM system `amiguita` to another remote file named `file_a.dat`. It specifies three concurrency control (file-locking) parameters on the input file, `/dir/file/ext`, during this operation and provides a file-creation password to the FTAM listener.

```
$ copy/app=ftam/delete remote_system::remote_file.dat mydata.dat Return
```

The file `remote_file.dat` is copied from the alias `remote_system` to a local file named `mydata.dat`. After the copy operation is complete, FTAM deletes the remote file `remote_file.dat`.

delete

Name

delete — delete file data

Syntax

```
delete/app=ftam [/qualifier(s)] file-spec [, ...]
```

The command variables are:

<i>/qualifier</i>	A qualifier for the delete command.
<i>file-spec</i>	A file specification for a local or remote file.
[, ...]	One or more additional local or remote file specifications, each of which is separated from the preceding file specification by a comma (,) or a plus sign (+).

The qualifiers are:

<i>/confirm</i>	This qualifier controls whether the facility asks you to confirm the deletion of each file. The local system prompts you by asking, "Delete <i>filename?</i> [N]." Issue one of the following responses:
<i>/noconfirm</i>	

- To affirm deleting a specific file, enter *yes*, *true*, or *1*.
- To prevent deleting a specific file, enter *no*, *false*, *0*, or press Return.
- To continue deleting without further confirmation, enter *all*.
- To stop all deletions, enter *quit* or press *Ctrl/Z*.

A responding FTAM system can alter the file name specified in an FTAM DCL command. Therefore, the file actually selected by the remote FTAM system may not be the intended target. It is recommended that you use the */confirm* qualifier to be sure you are deleting the correct file.

Default value: */noconfirm*

<i>/log</i>	This qualifier controls whether the FTAM deletion facility displays the file specification of each deleted file.
<i>/nolog</i>	

Default value: */nolog*

delete

Description

The delete command deletes files from both remote and local systems.

Restrictions

FTAM does not support certain qualifiers when the delete command operates on remote files. These null qualifiers for the delete command are:

```
/backup  
/before  
/by_owner  
/created  
/erase  
/exclude  
/expired  
/modified  
/since
```

Examples

```
$ delete/app=ftam /confirm amiguita:="/main/sub/file/ext"   
Delete AMIGUITA:="/MAIN/SUB/FILE/EXT"? [N] 
```

This command allows you to review your deletion request before it is executed. In this example, confirmation is not given, so the file is not deleted.

```
$ delete/app=ftam/log/confirm amor:"^vol>main>file.ext",-   
_$_ test.dat;4 
```

```
Delete AMOR:"^VOL>MAIN>FILE.EXT"? [N] Y   
%DELETE-I-FILDEL, AMOR:"^VOL>MAIN>FILE.EXT" deleted (98 blocks)  
%Delete TEST.DAT;4? [N] N 
```

This command requests confirmation about deleting the remote file ^vol>main>file.ext on amor and, receiving a positive response (Y), deletes that file. The command then requests confirmation about deleting the local file test.dat;4 and, receiving a negative response (N), leaves that file intact.

directory

Name

directory — display directory data

Syntax

```
directory/app=ftam [/qualifier(s)] file-spec [,...]
```

The command variables are:

<i>/qualifier</i>	A qualifier for the directory command.
<i>file-spec</i>	The file specification for a local or remote file.

The qualifiers are:

<i>/brief</i>	This qualifier produces a brief directory display. The brief display format is the default display format for the directory command. Unless you specify otherwise, the brief directory display contains only the FTAM application name and the file designation for each specified file. You can expand the information in a brief display by specifying any combination of the <i>/size</i> , <i>/owner</i> , and <i>/date</i> qualifiers.
---------------	---

For additional information about a file, use the */full* qualifier.

Default value: *brief*

<i>/columns</i>	This qualifier controls the number of columns in a brief directory display, which has four columns by default. In practice, the number of columns displayed depends on the interplay of column widths and display widths (controlled by the <i>/width</i> qualifier) and the width of the output device (controlled by the <code>set terminal/width=n</code> command). A display contains as many of the specified number of columns as fit within the display width or the screen width (whichever is narrowest).
-----------------	--

The */columns* and */full* qualifiers are mutually incompatible.

Default value: A four-column display

directory

<code>/date[=<i>option</i>]</code> <code>/nodate</code>	<p>This qualifier displays either the creation or modification date of the specified files according to the date option that you specify. The available date options and their effects are as follows:</p> <p>created Displays the creation date of a file. modified Displays the last modification date of a file (that is, when it was last written to).</p> <p>The FTAM directory facility does not support the other date options of RMS. To select the modification date, specify <code>modified</code>. To select the creation date, either specify <code>created</code> or use the <code>/date</code> qualifier without specifying either type.</p> <p>Default format: <code>/nodate</code></p>
<code>/full</code>	<p>This qualifier generates a complete display of supported file attributes in a standard DCL full directory format.</p> <p>Default format: <code>/brief</code></p>
<code>/grand_total</code>	<p>This qualifier suppresses both individual file listings and individual directory totals when multiple directories are involved. The <code>/grand_total</code> qualifier displays the total number of targeted directories and files. (See the <code>/trailing</code> qualifier for information on suppressing directory totals.)</p> <p>Default format: Both file attributes and directory totals displayed</p>
<code>/heading</code> <code>/noheading</code>	<p>This qualifier controls whether a header consisting of an FTAM application name is displayed separately from file designations. Each FTAM system specified in a <code>directory</code> command generates a separate directory header. The default display format includes a heading. When you specify <code>/noheading</code>, full file specifications appear in single-column format. The <code>/columns</code> qualifier has no effect when used with the <code>/noheading</code> qualifier. You may find the combination of the <code>/noheading</code> and <code>/notrailing</code> qualifiers useful in command procedures where you want to create a list of complete file specifications for later operations.</p> <p>Default format: <code>/heading</code></p>
<code>/output[=<i>file</i>]</code> <code>/nooutput</code>	<p>This qualifier controls where the output of the command goes. The <code>/nooutput</code> qualifier suppresses output. The <code>/output=<i>file</i></code> qualifier accepts a nonwildcard local file designation to which the directory facility sends its output. Specifying a directory name alone for the <i>file</i> parameter causes the output to be sent to a file named <code>directory.lis</code> in the specified directory.</p> <p>Default action: <code>/output=sys\$output</code> <code>sys\$output</code> is the logical name for the default output stream or device of the current process.</p>

<p>/owner /noowner</p>	<p>This qualifier controls whether the file owner's UIC is listed.</p> <p>The OpenVMS file owner corresponds to the FTAM file attribute "identity of creator."</p> <p>The default size of the owner field is 20 characters. If the owner information exceeds the length of the owner field, the directory facility truncates the owner information.</p> <p>To alter the width of the owner field use the /width=(owner=n) qualifier.</p> <p>Default format: /noowner</p>						
<p>/printer</p>	<p>This qualifier places the directory output into a temporary output file for printing on the default printer used by the local system. By default, the output file is called <code>directory.lis</code>. However, you can specify a different output file name by using the /output=<i>filename</i> qualifier. The /printer qualifier automatically queues the output file for printing and deletes it afterwards.</p> <p>Default action: No printing</p>						
<p>/size[=<i>option</i>] /nosize</p>	<p>This qualifier provides the file size in blocks used, allocated, or both, for each specified file. The default option for size is the blocks already used. However, you can use the /size=<i>option</i> format to control the type of information displayed. The available /size options and their effects are as follows:</p> <table border="0" style="margin-left: 20px;"> <tr> <td style="padding-right: 20px;">all</td> <td>Displays the file size both in blocks used and blocks allocated.</td> </tr> <tr> <td>allocation</td> <td>Displays the file size in blocks allocated. Blocks allocated equates to the FTAM attribute "future file size."</td> </tr> <tr> <td>used</td> <td>Displays the file size in blocks used (default measurement). Blocks used equates to the FTAM attribute "file size."</td> </tr> </table> <p>You can alter the width of the display field for file size by including the /width=(size=n) qualifier on the command line.</p>	all	Displays the file size both in blocks used and blocks allocated.	allocation	Displays the file size in blocks allocated. Blocks allocated equates to the FTAM attribute "future file size."	used	Displays the file size in blocks used (default measurement). Blocks used equates to the FTAM attribute "file size."
all	Displays the file size both in blocks used and blocks allocated.						
allocation	Displays the file size in blocks allocated. Blocks allocated equates to the FTAM attribute "future file size."						
used	Displays the file size in blocks used (default measurement). Blocks used equates to the FTAM attribute "file size."						
<p>/total</p>	<p>This qualifier suppresses individual file listings and displays only the summary information that is described under the /trailing qualifier. (See the /trailing qualifier for information on suppressing directory totals.)</p> <p>Default format: Information about individual files displayed</p>						

directory

`/trailing`
`/notrailing`

This qualifier controls whether summary information (totals) appears in a trailing line at the end of a directory display. By default, the summary information appears. Totals include some or all of the following:

- Number of files listed per directory
- Number of directories (if the command specifies multiple directories)
- Total number of blocks from each directory (if the command contains the `/size` or the `/full` qualifier)

Default format: `/trailing`

`/width[(option
[,...])]`

This qualifier allows you to control the display width allotted to four elements: the entire display, file name, owner information, and file size. If you specify only one display-element option, you can omit the parentheses. The display-element options are:

`display[=n]` Controls the total width for a directory display. The default value for *n* is 0, which matches the display width to the terminal width. You can change the width from 1 through 255 spaces. However, if the total width of the display exceeds the terminal width, the directory facility truncates the display on the right side.

`filename[=n]` Controls the width of the file-name field for a brief directory display. The default width is 19 characters. By default, if you request additional information (such as owner), a file name that exceeds the file-name width appears in full and the additional information appears on the following line. However, when you request additional information and also request multiple columns (using the `/columns=n` qualifier), the directory facility truncates file names that exceed the column width on the right side and places a vertical bar (|) at the right-hand edge of the column.

`owner[=n]` Controls the width of the owner field for a brief directory display. The default width is 20 characters. If the owner information exceeds the length of the owner field, the directory facility truncates the owner information on the right side.

`size[=n]` Controls the width of the size field for a brief directory display. The default width is 6 characters for each type of size (blocks used and blocks allocated). If the number of blocks exceeds the width of the size field, the directory facility substitutes a string of asterisks (*) in place of a single type of size. If you use the `/size=all` qualifier, the facility replaces the numeral representing the blocks used with an asterisk and truncates the numeral representing the blocks allocated.

directory

Description

The `directory` command displays local and remote directories. For remote files, the directory facility replaces the directory with the application name.

Restrictions

FTAM does not support certain qualifiers when the `directory` command operates on remote files. These null qualifiers for the `directory` command are:

- /acl
- /backup
- /before
- /by_owner
- /created
- /exclude
- /expired
- /file_id
- /modified
- /protection
- /security
- /select
- /since
- /versions

Examples

```
$ directory/app=ftam amiguita:."\dir\file\ext",test.datReturn
```

First, this command produces a display with the FTAM application name, amiguita, and the file name \dir\file\ext. Next, the command produces a standard OpenVMS directory display with the local directory and device information and the local file designation. In this example, the most recent version of the file is test.dat;7. The output resembles the following:

```
Directory AMIGUITA::
\DIR\FILE\EXT
Total of 1 file
Directory USER$75:[USERNAME]
TEST.DAT;7
Total of 1 file
Grand total of 2 directories, 2 files.
```

```
$ directory/app=ftam /full hava::test.dat Return
```

This command produces a full directory display for the remote file test.dat. The full directory display for such a remote file resembles the following:

```
Directory HAVA::
TEST.DAT                               File ID: None
Size:          1/3                      Owner:   <Unknown>
Created:       25-FEB-1996 11:36
Revised:       25-FEB-1996 11:36
Expires:       <None specified>
Backup:        <No backup done>
File organization: Sequential
File attributes: Allocation: 3, Extend: 0, Global buffer count: 0
                No version limit
Record format:  Variable length
Record attributes: Carriage return carriage control
Journaling enabled: None
File protection: System: , Owner: , Group: , World:
Access Cntrl List: None
Total of 1 file, 1/3 blocks.
```

rename

rename

Name

rename — rename remote or local files

Syntax

```
rename/app=ftam [/qualifier] input-file-spec[,...] output-file-spec
```

The command variables are:

<i>/qualifier</i>	A qualifier for the rename command.
<i>input-file-spec</i>	A file specification of an input (source) file, which can be local or remote.
<i>[, ...]</i>	A file list containing file specifications for one or more additional input files. Within a file list, you must precede each additional file specification with a comma (,) or a plus sign (+) with or without a space. To end an input file list, either omit the comma or plus sign between the last input file specification and the output file specification, or press Return. Input files can be from the same or different FTAM systems.
<i>output-file-spec</i>	The name of an output file. Because FTAM always creates only one output file, the rename command accepts only one output-file specification. For local output files, renaming a file to a local directory is controlled by the same rules that control the RMS renaming utility. If you do not specify a directory, the utility places the output file in your default directory. If you specify another local directory for which you have write privileges, the utility places the output file in the specified directory. For remote output files, always specify the file designation. For information on where a remote FTAM system places an output file that is created remotely using FTAM, see the documentation for the remote system.

The qualifiers are:

/confirm /noconfirm	<p>This qualifier controls whether the facility asks you to confirm the renaming of each file. The local system prompts you by asking, "<i>filename</i> → <i>filename?</i> (Y,N,Q,All):." These are the first letters of the valid responses: Yes, No, Quit, and All.</p> <p>A responding FTAM system can alter the file name specified in a VAX FTAM DCL command. Therefore, the file actually selected by the remote FTAM system may not be the intended target. You should use the /confirm qualifier with the rename command.</p> <p>Default value: /noconfirm</p>
/log /nolog	<p>This qualifier controls whether the FTAM renaming facility displays the file specification of each renamed file.</p> <p>Default value: /nolog</p>

Description

The rename command renames files that reside on the same remote system, or local files that reside on the same device.

Restrictions

The rename command works only when both the input files and the output files reside on the same remote system **or** on the same device, for local files. Therefore, you may omit the name of the remote system before the output file specification, because it must be the same as that for the input file specification. For example:

```
$ rename/app=ftam remote:="/file1.ext" "/file2.ext" 
```

will function just like

```
$ rename/app=ftam remote:="/file1.ext" remote:="/file2.ext" 
```

FTAM does not support certain qualifiers when the rename command operates on remote files. These null qualifiers for the rename command are:

```
/backup
/before
/by_owner
/created
/exclude
/expired
/modified
/new_version
/since
```

rename

Examples

```
$ rename/app=ftam /confirm ami::"/main/file"-   
_$_ "/new/file"   
AMI::"/MAIN/FILE" --> AMI::"/NEW/FILE"? (Y,N,Q,All): Y 
```

This command allows you to review your renaming request before it is executed. In this example, the remote file /main/file is renamed to the remote file /new/file on the same system after the system receives a positive response (Y). Note that it is not necessary to include the name of the remote system (AMI) in the output file specification because it must be the same system as that of the input file specification.

```
$ rename/app=ftam/log/confirm freund::"^vol>main>file.ext" -   
_$_ test.dat   
FREUND::"^VOL>MAIN>FILE.EXT" --> TEST.DAT ? (Y,N,Q,All): Y   
%RENAME-I-RENAMED, FREUND::"^VOL>MAIN>FILE.EXT" renamed to TEST.DAT
```

This command requests confirmation about renaming the remote file called ^vol>main>file.ext on freund. After receiving a positive response (Y), the system renames the file to test.dat. The informational message is displayed because the /log qualifier is used.

FTAM Command Summary (Digital UNIX)

This appendix describes the Digital UNIX FTAM commands in alphabetical order. The following table summarizes the commands.

Command	Function
ocat	Concatenate and print data.
ocp	Copy file data.
ols	List and generate statistics for files.
omv	Move or rename files.
orm	Remove files.

ocat

ocat

Name

ocat — concatenate and print data

Syntax

```
ocat [options] application-address::file [application-address::file...]
```

The command variables are:

<i>application-address</i>	Specifies the FTAM system on which the remote files are located. See Section 2.1.2.1 for additional details on application-addresses. The format of an application address is <i>alias/user/password/account</i> , where:
<i>alias</i>	defines a remote system and maps to a specific application-entity (AE) title and service access point (SAP) selectors. Valid aliases are stored in the ISO application entity database, <i>/etc/isoapplications</i> .
<i>user</i>	is the remote login ID. This value is optional for some responders but is required for the Digital UNIX FTAM responder.
<i>password</i>	is the password for the remote login ID. If you specify <i>user</i> without specifying <i>password</i> , the software prompts you for a password. If the password contains shell meta characters such as a dollar sign (\$), it must be entered from the password prompt. If the password is a hexadecimal number, it must be preceded by the characters %x or %X. If no password is required, press Return.
<i>account</i>	is the FTAM account name. This value is optional.
<i>file</i>	Specifies the remote files to be concatenated or printed.

The options are:

-b	Ignores blank lines and precedes each output line with its line number.
-e	Displays a dollar sign (\$) at the end of each output line.
-n	Precedes all output lines (including blank lines) with line numbers.
-s	Squeezes adjacent blank lines from output and single spaces output.
-t	Displays nonprinting characters (including tabs) in output. In addition to those representations used with the -v option, all tab characters are displayed as ^I.
-u	Unbuffers output.

- v Displays nonprinting characters (excluding tabs). For example, Ctrl/X displays on the screen as ^X. The delete character (octal 0177) displays as ^?. Non-ASCII characters (with the high bit set) display as M- (which is the meta character) followed by the low 7 bits.
- T *trace-file* Creates a trace file with the indicated file name. You must use the `ositrace` command described in *DECnet-Plus Problem Solving* to analyze this trace file.

Description

The `ocat` command reads a remote file and displays its contents on the standard output.

You can only append the contents of remote files by redirecting the output to a local file.

Restriction

The `ocat` command does not print local files.

Examples

```
% ocat petrie/username/password::/users/amis/tester
```

This command displays on the standard output the file called `tester` located on the remote Digital UNIX system `petrie`.

```
% ocat LESAMIES::test.dat
```

This command displays on the standard output the file `test.dat` on the remote OpenVMS system `LESAMIES`.

ocp

ocp

Name

ocp — copy file data

Syntax

```
ocp [options] [application-address] file1 [application-address] file2
```

The command variables are:

<i>application-address</i>	Specifies the FTAM system on which the remote files are located. See Section 2.1.2.1 for additional details on application-addresses. The format of an application address is <i>alias/user/password/account</i> , where: <ul style="list-style-type: none"><i>alias</i> defines a remote system and maps to a specific application-entity (AE) title and service access point (SAP) selectors. Valid aliases are stored in the ISO application entity database, <i>/etc/isoapplications</i>.<i>user</i> is the remote login ID. This value is optional for some responders but is required for the Digital UNIX FTAM responder.<i>password</i> is the password for the remote login ID. If you specify <i>user</i> without specifying <i>password</i>, the software prompts you for a password. If the password contains shell meta characters such as a dollar sign (\$), it must be entered from the password prompt. If the password is a hexadecimal number, it must be preceded by the characters <i>%x</i> or <i>%X</i>. If no password is required, press Return.<i>account</i> is the FTAM account name. This value is optional.
<i>file1</i>	Specifies the file to be copied. If it is a remote file, the application address must be included as part of the file specification.
<i>file2</i>	Specifies the file to which the input file is to be copied. If it is a remote file, the application address must be included as part of the file specification.

The options are:

<i>-f</i>	Forces existing destination path names to be removed before copying, without prompting for confirmation. The <i>-i</i> option is ignored if the <i>-f</i> option is specified. This option is the default.
<i>-i</i>	Prompts users with the name of a file whenever the copy causes an old file to be overwritten. A <i>yes</i> answer causes <i>ocp</i> to continue. Any other answer prevents it from overwriting the file.

-D <i>document-type</i>	<p>Allows the user to specify a document type of one of the following flags. Note that these flags are not case-sensitive.</p> <p>FTAM-1 Indicates that the FTAM-1 document type should be used.</p> <p>FTAM-2 Indicates that the FTAM-2 document type should be used.</p> <p>FTAM-3 Indicates that the FTAM-3 document type should be used.</p> <p>Table 7–1 describes these document types.</p>
-C <i>universal-class</i>	<p>Allows the user to override the default file contents (universal class number parameter). General is the default value if the FTAM-1 document type is specified. The default value is graphic if the FTAM-2 document type is specified. The following flags are possible. Note that these flags are not case sensitive.</p> <p>IA5</p> <p>graphic</p> <p>visible</p> <p>General</p> <p>Printable</p>
-S <i>string-significance</i>	<p>Allows the user to override the default string significance parameter of n using any of the following flags. Note that these flags are not case sensitive.</p> <p>v Specifies that string significance is variable.</p> <p>f Specifies that string significance is fixed.</p> <p>n Specifies that string significance is not significant.</p>
-M <i>max-string-length</i>	<p>Allows the user to override the default maximum string length parameter of unlimited for FTAM-1 and FTAM-2 files and 512 for FTAM-3 files.</p>
-X <i>create-password</i>	<p>Specifies the password that an FTAM responder might require before creating a file on its file system. It is used by an FTAM responder to validate that the specified user has permission to create files on the current file system.</p>
-T <i>trace-file</i>	<p>Creates a trace file with the indicated file name.</p> <p>The syntax for the -T option is:</p> <p style="margin-left: 40px;"><code>ocp -Ttrace-file remote-src-spec remote-dest-spec</code></p>
-A	<p>Specifies that <i>file1</i> be appended to <i>file2</i>.</p>
-B <i>sleep</i>	<p>Default is 180 seconds. The number of seconds that the initiating entity will "sleep" or wait after a Class-3 error is received and before attempting to recover the association. This reinitialize sleep value may alternatively be set via the OSIF_REINIT_SLEEP environmental variable.</p>

ocp

- K max-retry Default is 5. The number of times that the initiating entity will "retry" to establish the association with the responding entity after a Class-3 failure. This value indicating the maximum number of reinitialize attempts may alternatively be set via the OSIF_REINIT_MAX_RETRY environmental variable.
- W timeout Default is 120 seconds. The number of seconds that initiating entity will wait for a response from the responding entity after attempting to recover the association. This value indicating the wait for reinitialize response may alternatively be set via the OSIF_REINIT_TIMEOUT environmental variable.
- N Allows the user to create a file with deferred availability.
- I Allows the user to create a file with immediate availability. Note that if both options -N and -I are specified, the second option overrides the first.
- s Allows the user to implement FTAM security group functions. These functions only apply for local to remote, or remote to remote file copying.

The syntax for the `-s` option is:

```
-s '(action-list=(access-request [,access-request...]);
[concurrency=(ca-name:ca-key[,ca-name:ca-key...]);]
[passwords=(apwd-name:apwd-string[,apwd-name:apwd-string...]);]

[identity=user-identity-string;]
[legal-qual=legal-qual-string;])'
```

The following list explains the `-s` syntax rules:

- You can enter the security group parameters as a string list on the command line, or you can create a file containing your security group parameters, and enter this file name as an argument to the `-s` option.
- If you specify the security group as a string list on the command line, it must be enclosed within single or double quotes. All white space then appearing within these quotes is ignored.
- The entire security string must be enclosed within parentheses, and multiple entries within the parentheses must be separated by commas.
- You can abbreviate parameter values as long as there are enough characters for a unique value.
- You can use a backslash (`\`) to continue any portion of the security group specification onto a new line. This applies to both when the security options are specified as a string list on the command line, and when the security options are specified from within a file.
- You can specify more than one security group; however, you must flag each new group list element with its own `-s` option. Note that the legal qualification parameter can only be specified once.

The following list describes the valid parameters for the security group options:

- The *access-request* list is mandatory. All other security group parameters must be a sublist of the action list. Valid *access-request* names are *read*, *insert*, *replace*, *extend*, *erase*, *read-attribute*, *change-attribute*, and *delete-file*.
- The concurrency access names (*ca-name*) are optional, but when used must be separated from the concurrency key by a colon. If you have more than one concurrency access and key parameter pair, separate each pair with a comma. Valid *ca-name* names are *read*, *insert*, *replace*, *extend*, *erase*, *read-attribute*, *change-attribute*, and *delete-file*.
- Valid *ca-key* names are *not-required*, *shared*, *exclusive*, and *no-access*.
- The access password (*apwd-name*) name is optional, but when used must be separated from the password string by a colon. Valid *apwd-name* names are *read*, *insert*, *replace*, *extend*, *erase*, *read-attribute*, *change-attribute*, and *delete*.
- Access password strings (*apwd-string*) can be entered as either graphic strings or octet strings. See the explanation for password in the *application-address* command variable.
- Identity of user (*user-identity-string*) must be a graphic string. See the explanation for user in the *application-address* command variable.
- *legal-qual-string* conveys information about the legal status of the file and its use (must be a graphic string).

-F <i>future-file-size</i>	Specifies the maximum size, in bytes, of the output file.
-m	Allows the user to rename (move) files from one remote system to a different remote system. The input file is deleted after the operation completes.
-R	This option controls whether you want the FTAM service provider to negotiate Recovery and Restart with the peer FTAM entity (if it supports Recovery). When the <i>/-R</i> option is present, FTAM inserts checkpoints within the data and maintains a docket that contains Recovery-related information.

`-c`
'(concurrency-control:lock)'

Specifies concurrency control and lock parameter pairs for concurrency control. If you use spaces between the parenthesis, enclose the parameter values within quotation marks. If you have more than one concurrency control and lock parameter pair, separate each pair with a comma. You can abbreviate parameter values as long as there are enough characters for a unique value. The default value for the lock parameter is `not-required` for all concurrency control parameters. You can change the default by using the following values for concurrency access and lock.

Concurrency Control	Lock
read	not-required
insert	shared
replace	exclusive
extend	no-access
erase	
read-attribute	
change-attribute	
delete-file	

Description

The `ocp` command copies files from a remote system to a local system, from a local system to a remote system, or from a remote system to a remote system. The remote systems specified in the last case may be the same or different systems.

Notes

Unlike the DECnet-Plus `dcp` command, the FTAM `ocp` command does not use ASCII, binary, or image as terms to describe FTAM file types. Instead, FTAM describes these characteristics in terms of document types that are specified using the `-D` option. The `-a` and `-i` options of the DECnet-Plus `dcp` command will be supported through the new document type option by specifying FTAM-1 for stream text files (ASCII) and FTAM-3 for stream binary files (binary or image).

If the `-D`, `-C`, `-S`, and `-M` options are not specified by the user, the `ocp` command determines the correct document type.

If the `-D` is specified without the other FTAM file type options, then the default values for those other options are:

- For FTAM-1 files (any stream text files): the universal class number is `GeneralString`, the maximum string length is unlimited, and the string significance is not significant.
- For FTAM-2 files (any stream text files): the universal class number is `GraphicString`, the maximum string length is unlimited, and the string significance is not significant.
- For FTAM-3 files (any files that are not stream text files): the maximum string length is 512 and the string significance is not significant.

You can use the `-D`, `-C`, `-S`, and `-M` options to override the default file options. However, you can specify the `-C`, `-S`, and `-M` options only if you also specify the `-D` option.

ocp

Restriction

The `ocp` command does not copy a local file onto the local system.

Examples

```
% ocp test.dat AMIGUITA::'\DIR\FILE'
```

This command copies the local file `test.dat` to `\DIR\FILE` on `AMIGUITA`. Note that without the single quotation marks (') enclosing `\DIR\FILE`, UNIX File System would treat this as a normal UNIX specification and ignore the backslashes as part of the file name.

```
% ocp TEST.DAT LESAMIES::'test.dat;25'
```

This command copies the local file `TEST.DAT` to `test.dat;25` on `LESAMIES`. Because the output-file designation is enclosed in single quotation marks ('), the characters entered in the command are retained in the output-file designation sent to the remote FTAM system.

```
% ocp MITRA::FILE.DAT /MAIN/SUB
```

This command copies the remote file `FILE.DAT` to the local UNIX directory `/MAIN/SUB`. The resulting file specification is `/MAIN/SUB/FILE.DAT`.

```
% ocp AMIGUITA::'\DIR\FILE' AMIGUITA::'\NEWMAIN\FILE'
```

This command copies the file `\DIR\FILE` on `AMIGUITA` to the output file `\NEWMAIN\FILE` on the same remote system. The single quotation marks indicate that the enclosed characters are retained in the output-file designation sent to the remote FTAM system.

```
% ocp -i PUNGYO::FILE.DAT FILE.DAT   
overwrite PUNGYO::FILE.DAT? y 
```

After you confirm the command, it copies the file `FILE.DAT` from the system `PUNGYO` to the local system.

ols
Name

ols — list and generate statistics for files

Syntax

```
ols [options] application-address::file [application-address::file...]
```

The command variables are:

<i>application-address</i>	Specifies the FTAM system on which the remote files are located. See Section 2.1.2.1 for additional details on application-addresses. The format of an application address is <i>alias/user/password/account</i> where:
<i>alias</i>	defines a remote system and maps to a specific application-entity (AE) title and service access point (SAP) selectors. Valid aliases are stored in the ISO application entity database, <i>/etc/isoapplications</i> .
<i>user</i>	is the remote login ID. This value is optional for some responders but is required for the Digital UNIX FTAM responder.
<i>password</i>	is the password for the remote login ID. If you specify <i>user</i> without specifying <i>password</i> , the software prompts you for a password. If the password contains shell meta characters such as a dollar sign (\$), it must be entered from the password prompt. If the password is a hexadecimal number, it must be preceded by the characters %x or %X. If no password is required, press Return.
<i>account</i>	is the FTAM account name. This value is optional.
<i>file</i>	Specifies a remote file.

The options are:

-A	Gives all the information available on the remote file. This information includes the file's permitted actions, storage account, FTAM document type, maximum string length, string significance, universal class number, creation and revision dates, date last read, date last revised, identity of creator, identity of last modifier, identity of last reader, identity of last attribute modifier, file availability, file size, future filesize, access control, and legal qualification. Note that the constraint set name and abstract syntax name pair could be printed instead of the FTAM document type, the maximum string length, the string significance, and the universal class number attributes.
----	--

ols

- a Displays all entries including those beginning with a period (.). This option is the default.
- l Lists the document type, owner, size in bytes, and time of last modification for each file.
The document type field indicates the file's document type (FTAM-1, FTAM-2, FTAM-3, or NBS-9).
The next field contains ten characters. The first character indicates whether the file is a directory (d) or a regular file (-). The remaining characters are interpreted as three sets of three characters each. The first set of three characters refers to file-access permissions for the user; the next set, for the user group; and the last set, for all others. You will see only the permissions for the user. The other permissions and those that are unsupported are indicated by a dash (-). The permissions are indicated as follows:
 - r if the file is readable.
 - w if the file is writeable.
 - x if the file is executable.
 - if the indicated permission is not granted.
- 1 Displays one entry per line. This is the default when output is not to a terminal.
- d Displays names of directories only, not contents. Use this option with -l to get the status of a directory.
- f Displays names in the order they exist in a directory. See `dir(5)` for further information. Entries beginning with a period (.) are also listed. This option is the default.
- T *trace-file* Creates a trace file with the indicated file name. You must use the `ositrace` command described in *DECnet-Plus Problem Solving* to analyze this trace file.

Description

Each file has a set of file attributes. **File attributes** are characteristics whose values identify and describe a file and record its history. The FTAM directory utility allows you to display FTAM file attributes for files by using the `ols` command. The basic `ols` command produces a minimal display containing only the file designation as it appears on the remote system. The `-A` option produces a full directory display, which contains information on all the supported FTAM file attributes.

Restriction

The `ols` command does not list local file attributes.

Examples

```
% ols petrie/username/password::/
```

This command produces a display with the FTAM application address and file name for each of the remote files. The output resembles the following:

```
NBS-9 dr-----      512      Jan 25 14:01 /.
NBS-9 dr-----      512      Jan 25 14:01 ../
NBS-9 dr-----     2048      Jul 30 1996 /bin
NBS-9 dr-----     4608      Jan 28 13:21 /etc
NBS-9 drw-----     512      Jan 30 09:57 /tmp
NBS-9 dr-----     512      Jan 25 15:31 /usr
NBS-9 dr-----     2560      Jan 24 13:01 /dev
FTAM-3 -r-----    3418740   Jan  4 16:11 /vmunix
FTAM-3 -r-----     512      May 23 1996 /var
FTAM-1 -r-----     172      Apr  5 1996 /.profile
FTAM-3 -r-----     512      May 23 1996 /sys
NBS-9 dr-----     512      May 23 1996 /opr
FTAM-3 -r-----     2560      Jan 28 13:27 /lib
FTAM-1 -r-----      89      Apr  1 1996 /.login
FTAM-1 -r-----     241      Apr  1 1996 /.cshrc
```

```
% ols -A hava::test.dat
```

This command produces a full directory display for the remote file test.dat that resembles the following:

```
Filename: TEST.DAT;1
Permitted actions:      read, replace, extend, erase,
                        read attributes, change attributes,
                        delete, traversal
Storage account:       <Not supported>
FTAM doc-type:        FTAM-3
Max string length:    <Not supported>
String significance:  Not significant
Universal class number: <Not supported>
Created:              Tue May  4 10:59:43 1996
Revised:              Tue May  6 11:59:44 1996
Last read:            <Not supported>
Last attrib revised:  <Not supported>
Identity of creator:   <Not supported>
Identity of last modifier: <Not supported>
Identity of last reader: <Not supported>
Identity of last attrib modifier: <Not supported>
File availability:    Immediate
File size:            315 Bytes
Future filesize:     1536 Bytes
```

omv

omv

Name

omv — move or rename files

Syntax

```
omv [options] application-address::file1 file2
```

The command variables are:

<i>application-address</i>	Specifies the FTAM system on which the remote files are located. See Section 2.1.2.1 for additional details on application-addresses. The format of an application address is <i>alias/user/password/account</i> where:
<i>alias</i>	defines a remote system and maps to a specific application-entity (AE) title and service access point (SAP) selectors. Valid aliases are stored in the ISO application entity database, <i>/etc/isoapplications</i> .
<i>user</i>	is the remote login ID. This value is optional for some responders but is required for the Digital UNIX FTAM responder.
<i>password</i>	is the password for the remote login ID. If you specify <i>user</i> without specifying <i>password</i> , the software prompts you for a password. If the password contains shell meta characters such as a dollar sign (\$), it must be entered from the password prompt. If the password is a hexadecimal number, it must be preceded by the characters %x or %X. If no password is required, press Return.
<i>account</i>	is the FTAM account name. This value is optional.
<i>file1</i>	Specifies the remote file to be renamed or moved.
<i>file2</i>	Specifies the new name of the file on the same remote system.

The options are:

-f	Force. This option overrides any mode restrictions or the -i switch. This option is the default.
-i	Interactive mode. Whenever a move is to supersede an existing file, the user is prompted by the name of the file followed by a question mark. If the user answers with a line starting with 'y', the move continues. Any other reply prevents the move from occurring.
-	Interprets all following arguments as file names to allow file names starting with a minus sign.

`-T trace-file` Creates a trace file with the indicated file name. You must use the `ositrace` command described in *DECnet-Plus Problem Solving* to analyze this trace file.

Description

The `omv` command moves (changes the name of) the remote file specified by `file1` to `file2` on that same remote system.

If the `-i` has been specified and `file2` already exists, the `omv` command prompts for confirmation before overwriting the file if the user does not have write permission on `file2`.

Restriction

The `omv` command does not move or rename a local file on a local system or across systems.

Example

```
% omv -i amigo::'/main/file/ext' '/new/file'   
omv: rename amigo::'/main/file/ext'? y 
```

This command allows you to review your renaming request before it is executed. In this example, the remote file `/main/file/ext` is renamed to the remote file `/new/file` on the same system after the system receives a positive response (y).

orm

orm

Name

orm — remove (unlink) files

Syntax

```
orm [options] application-address::file [application-address::file...]
```

The command variables are:

<i>application-address</i>	Specifies the FTAM system on which the remote files are located. See Section 2.1.2.1 for additional details on application-addresses. The format of an application address is <i>alias/user/password/account</i> where:
<i>alias</i>	defines a remote system and maps to a specific application-entity (AE) title and service access point (SAP) selectors. Valid aliases are stored in the ISO application entity database, <i>/etc/isoapplications</i> .
<i>user</i>	is the remote login ID. This value is optional for some responders but is required for the Digital UNIX FTAM responder.
<i>password</i>	is the password for the remote login ID. If you specify <i>user</i> without specifying <i>password</i> , the software prompts you for a password. If the password contains shell meta characters such as a dollar sign (\$), it must be entered from the password prompt. If the password is a hexadecimal number, it must be preceded by the characters %x or %X. If no password is required, press Return.
<i>account</i>	is the FTAM account name. This value is optional.
<i>file</i>	Specifies the file to be removed. This variable must specify a file and not a directory.

The options are:

-f	Forces the removal of a file or directory without first requesting confirmation. Only system or usage messages are displayed. This option is the default.
-i	Prompts for a yes or no response before removing each entry. Does not ask when combined with the -f option. If you type a y, followed by any combination of characters, a yes response is assumed.
-T <i>trace-file</i>	Creates a trace file with the indicated file name. You must use the <i>ositrace</i> command described in <i>DECnet-Plus Problem Solving</i> to analyze this trace file.

- Specifies that the named arguments have aliases beginning with a minus sign (for example `-alias`). If you specify more than one option, this option must be the last option specified.

Description

The `orm` command removes or deletes from the remote system each of the remote files specified.

Restriction

The `orm` command does not remove a local file from the local system.

Examples

```
% orm petrie/username/password::/users/freunden/myfile
```

The example shows how to remove the file `myfile` from the remote system `petrie`.

```
% orm - -gorp/username/password::/usr/users/robin/nester
```

This example shows the use of the null option to remove a file specification beginning with a minus sign.

```
% orm -i petrie/username/password::/users/amigos/testfile   
orm: remove /users/amigos/testfile? y 
```

This example shows how confirmation is requested for overwriting an existing file.

VT Command Summary (OpenVMS)

This appendix describes the OpenVMS VT commands in detail. The commands appear in alphabetical order. The following table summarizes the functions of the VT commands.

Command	Function
connect	Accesses a remote system through a terminal server and LAT/VT Gateway.
set host/vtp	Starts a remote OSI association.
set host/vtp	Accesses a LAT environment through a VT/LAT Gateway.
set host/vtp	Accesses a remote Internet system through a VT/Telnet Gateway.
sethost	Access a remote system from a PC through the LAT/VT Gateway.
telnet	Accesses a remote system through a Telnet/VT Gateway.

connect

connect

Name

`connect` — Access a remote system through a terminal server and LAT/VT Gateway

Syntax

```
connect service-name [node node-name [destination port-name]]
```

The command variables are:

<i>service-name</i>	The name of the gateway service. System administrators assign this name when they enable a LAT/VT Gateway. The local system uses this name to determine which gateway node to use for the connection.
<i>node-name</i>	The name of the local node.
<i>port-name</i>	The name of the remote OSI system you want to access.

The `connect` command has no qualifiers.

Description

The `connect` command connects with a remote OSI system through a terminal server by using the LAT/VT Gateway.

Restrictions

Your network must have one or more LAT/VT or VT/LAT Gateways enabled on a system that runs Digital's Local Area Transport (LAT) protocol. Also, the remote system must have a Virtual Terminal responder enabled.

Example

```
local> connect vt node serchr dest discvr
```

This command connects from a local node called `serchr` to a remote OSI system called `discvr` on a gateway service called `vt`. A successful LAT connect command results in a login prompt from the specified destination system, followed by a password prompt.

set host/vtp (osi)

Name

set host/vtp — Start a remote association

Syntax

set host/vtp *alias* [*qualifiers*]

where *alias* is the name of the remote node with which the VT initiator negotiates an association.

The qualifiers are:

/break=break-character This qualifier sets the break character. When you type this character, a VT-BREAK message is sent to the responder. The break character can be any ASCII character between @ and z, except c, m, q, s, y, the left bracket ([]) and any character already defined as the command or escape characters.

Default character: Ctrl/]

/command=command-character

This qualifier sets the command character. When you type this character, you gain access to VT command mode. The default character can be any ASCII character between @ and z, including the alphabetic characters in both uppercase and lowercase, the right bracket (]), circumflex (^), underscore (_), and grave accent (`), but not a character already defined as the break or escape character.

Default character: Ctrl/@

/disconnect=disconnect-character

This qualifier sets the escape character. When you type this character, a VT-RELEASE message is sent to the responder. The default for this character can be any ASCII character between @ and z, including the alphabetic characters in both uppercase and lowercase, the right bracket (]), circumflex (^), underscore (_), and grave accent (`), but not a character already defined as the command or break character.

Default character: Ctrl^

/log[=filespec]

This qualifier saves the entire screen output of the current DECnet-Plus Virtual Terminal association in a specified file. The default is /nolog. If you use the /log qualifier without specifying a filespec, the software uses the default filespec of sethost.log. Digital recommends that you use FTAM to transfer files in an OSI environment.

Default action: /nolog

set host/vtp (osi)

<code>/profile=profile-name</code>	<p>This qualifier selects the desired Virtual Terminal Protocol profile to be used. The default profile is Generalized Telnet, but can be one of the following:</p> <ul style="list-style-type: none">• <code>telnet</code> — for Telnet-1988 profile• <code>transparent</code> — for Transparent profile• <code>amode_default</code> — for A-mode Default profile <p>Default profile: Generalized Telnet</p>
<code>/statistics</code>	<p>This qualifier displays the Virtual Terminal association statistics when the association is terminated.</p> <p>Default: <code>/nostatistics</code></p>

Description

The `set host/vtp` command tells the Virtual Terminal initiator to start an association with the specified remote OSI system.

Restriction

An OSI-compliant Virtual Terminal responder must reside on the remote system.

Example

```
$ set host/vtp rnode /log= myfile.out Return
```

This command invokes a Virtual Terminal association with the remote host node called `rnode`, and stores the screen output in the file called `myfile.out`.

set host/vtp (lat)**Name**

set host/vtp — Access a LAT environment through a VT/LAT Gateway

Syntax

```
set host/vtp gateway-alias
```

where *gateway-alias* is the name of the remote gateway.

The set host/vtp command has no qualifiers.

Description

The set host/vtp command accesses a LAT environment through the VT/LAT Gateway.

Restrictions

You must know both the alias of the gateway and the LAT service name of the destination system.

Example

```
$ set host/vtp smaug$lat_gateway
Welcome to the VT/LAT gateway on smaug
Enter LAT Service Name: LATVAX
```

This example shows a user on a remote OpenVMS VT system accessing a gateway called smaug\$lat_gateway, and then connecting to a LAT service called latvax.

At the login prompt, enter your name and password as you would on your local system. The password is not echoed to the display.

set host/vtp (internet)

set host/vtp (internet)

Name

set host/vtp — Access a remote Internet system

Syntax

```
set host/vtp gateway-alias-name
```

where *gateway-alias-name* is the name of the VT/Telnet Gateway.

The set host/vtp command has no qualifiers.

Description

The set host/vtp command accesses a remote Internet system from a local OSI system, even if the remote Internet system does not have a VTP implementation.

Restriction

Your network must have one or more enabled VT/Telnet Gateways.

Example

```
$ set host/vtp intrpd$telnet
```

This command accesses a remote Internet system on the VT/Telnet Gateway called intrpd\$telnet. At the gateway prompt, enter the host name of the remote Internet system to which you want to connect. In this example, the host name is serchr:

```
    Welcome to the VT/Telnet gateway on intrpd
    Enter Remote Host Name: serchr
```

Enter your name and password at the user prompt as you would on your local system.

sethost

Name

sethost — Access a remote system from a PC through the LAT/VT Gateway

Syntax

```
sethost service-name
```

where *service-name* is the name of the gateway service. System administrators assign this name when they enable a LAT/VT Gateway.

The sethost command has no qualifiers.

Description

The sethost command from a PC, accesses a remote OSI system by means of the LAT/VT Gateway.

Restriction

You cannot use the LAT/VT Gateway to access a remote LAT system from an OSI system.

Example

```
c:> sethost vt
```

This command connects from a PC to a remote OSI system on a gateway service called vt.

telnet

telnet

Name

telnet — Access a remote OSI system through the Telnet/VT Gateway

Syntax

```
telnet gateway-host-name
```

where *gateway-host-name* is the name of the system on which the Telnet/VT Gateway resides.

The telnet command has no qualifiers.

Description

The telnet command accesses a remote system by means of the Telnet/VT Gateway. If the gateway system is an OpenVMS system, you may need to specify the port number. The default port number on OpenVMS is 30324. If the gateway system is Digital UNIX, you do not need to specify the port.

Restriction

To use the Telnet/VT Gateway, your local OpenVMS system must have the Digital TCP/IP Services for OpenVMS product installed.

Example

```
$ telnet intrpd 30324
```

This command connects to a gateway host called *intrpd* on an OpenVMS system. At the gateway prompt, enter the alias of the remote OSI system to which you want to connect, as shown:

```
Trying...16.63.96.230
connected to INTRPD
Escape character is '^]'.

No data to write to network

Welcome to the Telnet/VT gateway on intrpd
Enter Remote Alias Name: serchr
Welcome to VAX/VMS 5.5 on node SERCHR

Username:
```

At the user-name prompt, enter your name and password as you would on your local system.

D

VT Command Summary (Digital UNIX)

This appendix describes the Digital UNIX Virtual Terminal commands in alphabetical order. The following table summarizes the commands.

Command	Function
connect	Access a remote system through a terminal server through the LAT/VT Gateway.
ologin	Start a remote association.
ologin	Access an Internet system from a remote system through the VT/Telnet Gateway.
sethost	Access a remote system from a PC through the LAT/VT Gateway.
set host	Access a remote system through LAT on VMS by way of the LAT/VT Gateway.
telnet	Access a remote system from an Internet system through the Telnet/VT Gateway.

connect

connect

Name

`connect` — Access a remote system through a terminal server through the LAT/VT Gateway

Syntax

```
connect service-name [node node-name [destination port-name]]
```

The command variables are:

<i>service-name</i>	The name of the gateway service. System administrators assign this name when they enable a LAT/VT Gateway. The local system uses this name to determine which gateway node to use for the connection.
<i>node-name</i>	The name of the local node. If you do not specify <i>node-name</i> , the terminal server uses the first system it finds offering this service.
<i>port-name</i>	The name of the remote OSI system that you want to access. If you specify <i>port-name</i> , you must also specify <i>node-name</i> . If you do not specify <i>port-name</i> , the software prompts you for a destination.

Description

The `connect` command accesses a remote OSI system through a terminal server, by means of the LAT/VT Gateway.

Note

The LAT/VT Gateway operates in one direction only; from a LAT system to a remote OSI system.

Restriction

You cannot use the LAT/VT Gateway to access a remote LAT system from an OSI system.

Example

```
local> c vt node serchr dest discvr
```

This command connects from a local node called `serchr` to a remote OSI system called `discvr` on a gateway service called `vt`.

ologin (osi)

Name

ologin — Start a remote association

Syntax

ologin *application* [*options*]

where *application* specifies an alias listed in the `/etc/isoapplications` file, or an X.500 Distinguished Name.

If the input is an alias, then it is looked up in the `/etc/isoapplications` file.

If the input is a Distinguished Name, then an X.500 Directory System Agent is queried for the presentation address associated with the entry specified by the input Distinguished Name. If the query is successful and a complete and syntactically correct address is returned, then the address is used by VT to establish a Virtual Terminal association with the remote application. If the query fails, then the FTAM or Virtual Terminal operation has failed.

The options are:

- b Sets the break character. When this character is typed, a VT-BREAK message is sent to the responder. This message causes all messages that have been received, but not processed, to be discarded. The default for this character is Ctrl/6, which appears on the display as a double circumflex (^ ^).
- e Sets the escape character. When this character is typed, ologin escapes to command mode. The default for this character is Ctrl/], which appears on the display as a circumflex and right bracket (^]).
- h Displays the usage of the DECnet-Plus Virtual Terminal initiator command.
- o *output-* Saves the entire screen output of the current DECnet-Plus
file Virtual Terminal association in a specified file.
- p *profile-* Tells DECnet-Plus Virtual Terminal to specify the *profile-name*
name profile when negotiating an association with a responder node. The default profile is *telnet*; however, the *profile-name* can be one of the following:

a-default	for A-mode Default profile
telnet	for Telnet profile
transparent	for Transparent profile
generalized_telnet	for Generalized Telnet profile

Description

The ologin command tells the Virtual Terminal initiator to start an association with the specified remote OSI system.

ologin (osi)

Restrictions

An OSI-compliant Virtual Terminal responder must reside on the remote system.

If you are using the `ologin` command in a DECterm window and you wish to enable sending and receiving of 8-bit data by specifying the Telnet or Generalized Telnet profile and using the `set binary` command in command mode, you must set the DECterm's terminal mode to VT300 with 7-bit controls.

On a loopback connection, 8-bit data is not properly sent or received when the Transparent profile is used.

On a loopback connection, the terminal characteristics may be set incorrectly. They may indicate a value for the rows characteristic, which is incorrect. This problem manifests itself when any shell command or program makes use of this characteristic. You can fix the problem by entering the following command at the shell prompt:

```
% stty rows <correct number of rows>
```

Examples

```
% ologin discvr -o myfile.out
```

This command invokes a Virtual Terminal association with the remote host node called `discvr`, and stores the screen output in the file called `myfile.out`.

```
% ologin /c=us/o=remotel/cn=serchr/cn=vt:
```

This command invokes a VT association with the remote VT application identified by the Distinguished Name `/c=us/o=remotel/cn=serchr/cn=vt`, and uses the transport template "default".

```
% ologin template=my_template:/c=us/o=abacus/cn=rnode/cn=vtp:
```

This command invokes a VT association with the remote VT application identified by the Distinguished Name `/c=us/o=abacus/cn=rnode/cn=vtp` and uses the transport template `my_template`.

ologin (telnet)

Name

ologin — Access an Internet system from a remote system through the VT/Telnet Gateway.

Syntax

```
ologin gateway-host-name
```

where *gateway-host-name* specifies an alias listed in the */etc/isoapplications* file, or an X.500 Distinguished Name.

If the input is an alias, then it is looked up in the */etc/isoapplications* file.

If the input is a Distinguished Name, then an X.500 Directory System Agent is queried for the presentation address associated with the entry specified by the input Distinguished Name. If the query is successful and a complete and syntactically correct address is returned, then the address is used by VT to establish a Virtual Terminal association with the remote application. If the query fails, then the FTAM or Virtual Terminal operation has failed.

Description

Use the *ologin* command from a remote OSI system to access an Internet system that has a Virtual Terminal responder installed.

Restriction

Your network must have one or more VT/Telnet Gateways enabled.

Examples

```
% ologin discvr
```

This example shows a user accessing a gateway on the system called *discvr*.

At the login prompt, enter the alias of the remote Internet system to which you want to connect, followed by a single colon (:). In the following example the alias of the remote Internet system is *serchr*:

```
Login: serchr:
```

At the second login prompt, enter your name and password as you would on your local system. The password is not echoed to the display.

```
% ologin /c=us/o=remotel/cn=serchr/cn=vt:
```

This command invokes a VT association with the remote VT/Telnet Gateway identified by the Distinguished Name */c=us/o=remotel/cn=serchr/cn=vt*, and uses the transport template "default".

At the login prompt, enter the alias of the remote Internet system to which you want to connect, followed by a single colon (:). In the following example the alias of the remote Internet system is *serchr*:

ologin (telnet)

Login: serchr:

At the second login prompt, enter your name and password as you would on your local system. The password is not echoed to the display.

```
% ologin template=my_template:/c=us/o=abacus/cn=rnode/cn=vtp:
```

This command invokes a VT association with the remote VT/Telnet Gateway identified by the Distinguished Name /c=us/o=abacus/cn=rnode/cn=vtp and uses the transport template my_template.

At the login prompt, enter the alias of the remote Internet system to which you want to connect, followed by a single colon (:). In the following example the alias of the remote Internet system is serchr:

Login: serchr:

At the second login prompt, enter your name and password as you would on your local system. The password is not echoed to the display.

sethost**Name**

`sethost` — Access a remote system from a PC through the LAT/VT Gateway

Syntax

`sethost service-name`

where *service-name* is the name of the gateway service. System administrators assign this name when they enable a LAT/VT Gateway.

Description

The `sethost` command from a PC accesses a remote OSI system by means of the LAT/VT Gateway.

Restriction

You cannot use the LAT/VT Gateway to access a remote LAT system from a Digital UNIX system.

Example

```
c:> sethost vt
```

This command connects from a PC to a remote OSI system on a gateway service called `vt`.

set host /lat

set host /lat

Name

`set host` — Access a remote system through LAT on OpenVMS by way of the LAT/VT Gateway

Syntax

```
set host /lat [/node=node-name] [/destination_port=port-name] service-name
```

The command variables are:

<i>node-name</i>	The name of the local node. If you do not specify <i>node-name</i> , the terminal server uses the first system it finds offering this service.
<i>port-name</i>	The name of the remote OSI system you want to access. If you specify <i>port-name</i> , you must also specify <i>node-name</i> . If you do not specify <i>port-name</i> , the software prompts you for a destination.
<i>service-name</i>	The name of the gateway service.

Description

Use the `set host` command to access a remote system by means of the LAT/VT Gateway.

Restriction

You cannot use the LAT/VT Gateway to access a remote LAT system from an OSI system.

Example

```
$ set host /lat /node=serchr /dest_port=discvr vt
```

This command connects from a local node called `serchr` to a remote OSI system called `discvr` on a gateway service called `vt`.

telnet

Name

telnet — Access a remote system from an Internet system through the Telnet/VT Gateway

Syntax

```
telnet gateway-host-name
```

where *gateway-host-name* is the name of the system on which the Telnet/VT Gateway resides. (See `telnet(1c)` for more information about the `telnet` command.)

Description

Use the `telnet` command to access a remote system by means of the Telnet/VT Gateway.

Note

Unlike the LAT/VT Gateway, the Telnet/VT Gateway operates in two directions: from an Internet system to a remote OSI system (Telnet/VT) or from a remote OSI system to an Internet system (VT/Telnet).

Restriction

Your network must have one or more Telnet/VT Gateways enabled.

Examples

```
% telnet discvr
```

This example shows a user accessing a gateway on the system called `discvr`.

At the login prompt, enter the alias of the remote OSI system to which you want to connect, followed by a double colon (::). In the following example the alias of the the remote OSI system is `serchr`:

```
Login: serchr::
```

At the second login prompt, enter your name and password as you would on your local system. The password is not echoed to the display.

Mapping of FTAM to RMS File Attributes (OpenVMS)

This appendix summarizes the way OpenVMS FTAM handles FTAM file attributes. OpenVMS FTAM supports FTAM attributes that directly or indirectly map to existing RMS file attributes. Table E-1 shows the relationship between RMS file attributes and FTAM document types. The first three columns show RMS file attributes; the last four columns give parameters for FTAM document types.

Table E-1 Relationship of RMS Files and FTAM Document Types

RMS File Attributes			FTAM Document Types			
RMS File Org.*	RFM	RAT†	Name	Parameters		
			FTAM Doc. Type	Class No.	String Length‡	String Significance
SEQ	Stream	CR	FTAM-1	22, 27	<any> or <null>	Not signif.
SEQ	Stream with max string length	CR	FTAM-1	22, 25, 26, 27	<n>	Variable
SEQ	Fixed length records	CR	FTAM-1	22, 25, 26, 27	<n>	Fixed
SEQ	Variable	CR	FTAM-2	25, 26	<any> or <null>	Not signif.
SEQ	Undefined with max string length	None	FTAM-3	—	<any> or <null>	Not signif.
SEQ	Fixed length records	None	FTAM-3	—	<n>	Fixed
SEQ	Variable with max string length 512	NOCC	NBS-9	—	—	—

*Other RMS file types are only partially supported by OpenVMS FTAM. The OpenVMS FTAM responder treats unsupported files as FTAM-3 files, which can change the original file structure.

†Record attribute.

‡ <any>, as a description of string length, is actually $\leq 32,767$, which is the maximum record size for SEQ files. <n>, as a description of string length, is actually $\leq 6,143$.

Mapping of FTAM to RMS File Attributes (OpenVMS)

Table E-2 summarizes the relationship between fully supported FTAM file attributes and RMS file attributes.

Table E-2 Relationship of Fully Supported FTAM and RMS File Attributes

FTAM File Attributes	RMS File Attributes
File name	File specification
Contents type	File organization Record format Record attributes
Date/time creation	Date of creation
Date/time last modification	Date of revision
Permitted actions	Derived from contents type and system restrictions
File size	The number of bytes to which a file can grow
Future file size	The actual number of bytes in the file (highest block count and block size)

Table E-3 describes the mapping of FTAM file attributes to RMS file attributes for the kernel group. Table E-4 describes the mapping of FTAM file attributes to RMS file attributes for the storage group. Table E-5 describes the mapping of FTAM file attributes to RMS file attributes for the security group. Table E-6 describes the mapping of FTAM file attributes to RMS file attributes for the private group.

Table E-3 Mapping Between FTAM and RMS File Attributes (Kernel Group)

FTAM Attributes	OpenVMS FTAM Mapping
File name	The file name received on an F-SELECT or F-CREATE resides in the FAB\$L_FNA/FAB\$B_FNSRMS fields. After opening or creating the file, the responder returns one of the following: <ol style="list-style-type: none"> 1. The resultant string in the NAM block (NAM\$L_RSA/NAM\$L_RSL), which the responder fills in after successfully opening or creating the file. The responder also returns this value on a READ-ATTRIBUTES response. 2. The expanded string in the NAM block (NAM\$L_ESA/NAM\$B_ESL), which the responder fills in after failing to open or create the file. 3. If both of these fields are empty (that is, the request failed before opening or creating the file), then the responder returns the original string from the FAB\$L_FNA/FAB\$B_FNS fields.
Permitted actions	The responder ignores permitted actions on a CREATE request. For FTAM-2 files, the responder always returns the value "read, insert, read-attribute, delete-file, and traversal." It always returns the value "read, replace, extend, read-attribute, delete-file, and traversal" for FTAM-1 and FTAM-3 files on the CREATE and READ-ATTRIBUTE responses. The actions actually allowed on the file are further restricted by local filestore security.

(continued on next page)

Mapping of FTAM to RMS File Attributes (OpenVMS)

**Table E-3 (Cont.) Mapping Between FTAM and RMS File Attributes
(Kernel Group)**

FTAM Attributes	OpenVMS FTAM Mapping							
Contents type	On a CREATE request, the RMS attributes stored for the contents-type attribute are as follows:							
	DocType	StrSig	Max	CharSet	ORG	RFM	RAT	MRS
	FTAM-1	Not	any	GeneralString, IA5String	SEQ	STM	CR	None
	FTAM-1	VAR	n	GeneralString, IA5String, GraphicString, VisibleString	SEQ	VAR	CR	n
	FTAM-1	FIX	n	GeneralString, IA5String, GraphicString, VisibleString	SEQ	FIX	CR	n
	FTAM-2	Not	any	GraphicString	SEQ	VAR	CR	None
	FTAM-3	Not	any	Not applicable	SEQ	UDF	None	None
	FTAM-3	FIX	n	Not applicable	SEQ	FIX	None	n

In the preceding table, a maximum string length of "any" means an integer less than or equal to 32,767 and "n" means an integer less than or equal to 6,143. For information on character sets, see the Note at the end of this table.

The responder rejects a request to create a file with any other document type (or other parameters).

OpenVMS FTAM stores document-type parameters that do not map directly to any RMS fields. When retrieved using FTAM, the file has its original document-type parameters.

In the following table, the document-type parameters are the defaults returned for a file that was created locally. Files created by OpenVMS FTAM store the document-type parameters, and these are returned if present. All other types of local files (including other organizations such as IDX, REL; other RFMs such as FIX, STMCR, STMLF, and so forth; and other record-attributes such as PRN) are treated as FTAM-3 files, with the same default parameters listed here.

By default, on a READ-ATTRIBUTES and OPEN response, the document type and its parameters are returned as follows:

ORG	RFM	RAT	DocType	StrSig	MAX	CharSet
SEQ	UDF	any	FTAM-3	Not	None	Not applicable
SEQ	STM	CR	FTAM-1	Not	None	GeneralString
SEQ	VAR	CR, FTN	FTAM-2	Not	None	GraphicString

Mapping of FTAM to RMS File Attributes (OpenVMS)

Note

In Table E-3, the terms listed under the heading CharSet refer to the following character sets:

An **IA5String** is a string of characters from the IA5 character set. This 7-bit character set contains both graphic characters (printable) and control characters (nonprintable format-affecting characters).

A **GeneralString** is a string composed of a definable character set; by default, a GeneralString is an IA5String. OpenVMS FTAM defines a GeneralString as being a string of characters from the ISO 8859 character set, which is an 8-bit character set containing both graphic characters and control characters.

A **GraphicString** is a string of printable characters taken from the GeneralString character set.

A **VisibleString** is a string composed of a definable character set that includes alphanumeric characters, punctuation, and graphics.

Table E-4 Mapping Between FTAM and RMS File Attributes (Storage Group)

FTAM Attributes	OpenVMS FTAM Mapping
Storage account	This parameter does not map to any RMS attribute; the responder ignores it in a CREATE indication, and the responder always returns, "No value available" in a CREATE or READ-ATTRIBUTE response.
Date and time of creation	This parameter maps to the RMS file creation date and time attribute (XAB\$Q_CDT), which contains the local system date and time when the file was created. The responder always returns this value as a Generalized Time.
Date and time of last modification	This parameter maps to the RMS file revision date and time attribute (XAB\$Q_RDT), which contains the local system date and time when the file was last modified. The responder always returns this value as a Generalized Time.
Date and time of last read access	This parameter does not map to any RMS attribute; the responder always returns, "No value available."
Date and time of last attribute modification	This parameter does not map to any RMS attribute; the responder always returns, "No value available."
Identity of creator	This parameter does not map to any RMS attribute; the responder always returns, "No value available."
Identity of last modifier	This parameter does not map to any RMS attribute; the responder always returns, "No value available."
Identity of last reader	This parameter does not map to any RMS attribute; the responder always returns, "No value available."

(continued on next page)

Mapping of FTAM to RMS File Attributes (OpenVMS)

Table E-4 (Cont.) Mapping Between FTAM and RMS File Attributes (Storage Group)

FTAM Attributes	OpenVMS FTAM Mapping
Identity of last attribute modifier	This parameter does not map to any RMS attribute; the responder always returns, "No value available."
File availability	File availability is only partially supported. The responder ignores it in a CREATE indication. The responder always returns the value, "Immediate availability" in a CREATE or READ-ATTRIBUTE response.
File size	This attribute is readable only by using the READ-ATTRIBUTES request. The value returned is the actual number of bytes in the file, which is determined as follows: $\text{filesize} = (\text{XAB\$L_EBK} - 1) * 512 + \text{XAB\W_FFB}
Future file size	This attribute maps to the RMS FAB\$L_ALQ field. For a CREATE request, the RMS allocation quantity is rounded up to the next block boundary as follows: $\text{FAB\$L_ALQ} = (\text{future-filesize} + 511) / 512$ <p>For the CREATE or READ-ATTRIBUTES response, the value returned is the number of bytes in the quantity of blocks allocated:</p> $\text{future-filesize} = \text{FAB\$L_ALQ} * 512$

Table E-5 Mapping Between FTAM and RMS File Attributes (Security Group)

FTAM Attributes	OpenVMS FTAM Mapping
Access control	Security group attributes are unsupported.
Legal qualification	Security group attributes are unsupported.

Table E-6 Mapping Between FTAM and RMS File Attributes (Private Group)

FTAM Attributes	OpenVMS FTAM Mapping
Private use	The private group attribute is unsupported.

Some FTAM document-type parameters do not map directly to RMS file attributes. For instance, RMS cannot store the character-set parameter on FTAM-1 files. Also, direct mapping between the RMS maximum record size (MRS) attribute and the maximum-string-size document-type parameter is sometimes absent.

When creating a file, the OpenVMS FTAM responder uses access control elements (ACEs) to hold FTAM document-type parameters that do not map to RMS file attributes. An ACE is part of an access control list (ACL) that is attached to an object such as a file. OpenVMS FTAM uses an application-independent ACE, which has a fixed portion containing flags, type indicator, length, and an application mask, followed by information that is specific to an application.

Mapping of FTAM to RMS File Attributes (OpenVMS)

FTAM ACEs must remain intact, because deleting an FTAM ACE can erase the values of document-type parameters. Modifying the information in an FTAM ACE can cause FTAM protocol errors such as access violations.

A DCL user without the SECURITY privilege cannot display a file's FTAM ACEs. However, a user whose process has the SECURITY privilege enabled can display FTAM ACEs by entering the DCL `directory/full` or `directory/acl` commands. The FTAM ACEs are application specific, so OpenVMS does not interpret the information and displays it as hexadecimal bytes. This section describes the FTAM ACE to help you recognize it in directory displays.

Several constant values occur in all FTAM ACEs. To identify an FTAM ACE, look for the following values in the directory display:

- The *ace* type (first word in an ACE display) is always `application`.
- The value of *flags* is always `%X0600`.
- The value of *access* is always `%X000002E2` (which is the FTAM facility code and is unique to FTAM ACEs).

Note that the values of *size* and *data* vary from file to file.

In the following examples of a brief and a full directory display for the file `file.dat`, the constant values are in **bold** type.

FTAM ACE in a Brief Directory Display

```
$ directory /acl file.dat Return
```

```
Directory USER$1:[USERNAME]
```

```
FILE.DAT;1
```

```
APPLICATION, SIZE=%D44, FLAGS=%X0600,  
ACCESS=%X000002E2, DATA=%X00130024, %X0014000C,  
%X54460006, %X312D4D41, %X006B0014, %X006C0008, %X0000001B, %X006E0008, %X00000002
```

```
Total of 1 file.
```

FTAM ACE in a Full Directory Display

```
$ directory /full file.dat Return
```

```
Directory USER$1:[USERNAME]
```

```
FILE.DAT;1
```

```
Size:           4/6           File ID:  (3293,8,0)  
Owner:         [GRP,USERNAME]
```

```
Created: 28-MAR-1996 13:04:52.83
```

```
Revised: 28-MAR-1996 13:04:55.16 (1)
```

```
Expires: <None specified>
```

```
Backup: 29-MAR-1996 00:32:19.77
```

```
File organization: Sequential
```

```
File attributes: Allocation: 6, Extend: 0, Global buffer count: 0, No version  
limit
```

```
Record format: Stream
```

```
Record attributes: Carriage return carriage control
```

```
RMS attributes: None
```

```
Journaling enabled: None
```

```
File protection: System:RWED, Owner:RWED, Group:RE, World:
```

```
Access Cntrl List: (APPLICATION, SIZE=%D44, FLAGS=
```

```
%X0600, ACCESS=%X000002E2, DATA=%X00130024,  
%X0014000C, %X544600 06, %X312D4D41, %X006B0014, %X006C0008, %X0000001B, %X006E0008, %X  
00000002)
```

```
Total of 1 file, 4/6 blocks.
```

Virtual Terminal Profile Mapping

Profiles are used with VT to establish a common context for data transfer. Both the initiator and responder must agree on this context (profile) before establishing an association. (See Chapter 1.)

Mapping refers to how each profile translates characters from one system to another. Mapping occurs in a directional flow. That is, a local system sends a character to a VT where it is translated within the context of the profile in use, and the VT then updates a display object (local to virtual). The same happens when a character is sent from the display object to the VT and then back to the local system (virtual to local). In addition, the effect of mapping is often different if you are using a terminal implementation, or a host implementation.

For example, on a host implementation, the key sequence <CR><LF> sent in a local to VT direction, might be translated to a VT NEXT-X-ARRAY operation. While on a terminal implementation, it would be typical to see a <CR> character by itself map to a VT NEXT-X-ARRAY operation.

Sending data in the other direction (virtual to local) on an OpenVMS host, NEXT-X-ARRAY might translate to the <CR> character, and a terminal implementation might translate NEXT-X-ARRAY to a <CR><LF> key sequence.

The amount of mapping that occurs is determined by the profile in use, and each profile has its own character translation as shown in Table F-1, Table F-2, and Table F-3.

Table F-1 Transparent and Binary Mode Telnet Profile Mapping

System	Character/VT Operation	Maps to:
Host (local to virtual)	All characters	TEXT
Host (virtual to local)	TEXT	character
Terminal (local to virtual)	All characters	TEXT
Terminal (virtual to local)	TEXT	characters

Virtual Terminal Profile Mapping

Table F-2 A-Mode Default Profile Mapping

System	Character/VT Operation	Maps to:
Host (local to virtual)	<CR><LF>	NEXT-X-ARRAY
	<LF><CR>*	NEXT-X-ARRAY
	<FF>	PTR-RELATIVE Y:=Y+24
	<HT>	PTR-RELATIVE to next tab stop. X:=x+8 - (X mod 8)
	<VT>	PTR-RELATIVE Y:=Y+3
	G0 characters	TEXT
	All other characters are removed prior to transmission.	
Host (virtual to local)	NEXT-X-ARRAY	<CR>
	TEXT	characters
	PTR-RELATIVE X:=X+x	<SPACE>s
	PTR-RELATIVE Y:=Y+y	<LF>
Terminal (local to virtual)	<CR>	NEXT-X-ARRAY
	<LF>	NEXT-X-ARRAY
	<FF>	PTR-RELATIVE Y:=Y+24
	<HT>	PTR-RELATIVE to next tab stop. X:=X+8 - (X mod 8)
	<VT>	PTR-RELATIVE Y:=Y+3
All other characters are removed prior to transmission.		
Terminal (virtual to local)	NEXT-X-ARRAY	<CR><LF>
	TEXT	characters
	PTR-RELATIVE X:=X+x	<SPACE>s
	PTR-RELATIVE Y:=Y+y	<LF>s

*DECnet-Plus for OpenVMS only.

TEXT — an OCTET string of uninterpreted data
 PTR-RELATIVE — change the X or Y coordinates (or both)
 PTR-ABSOLUTE — set the X or Y coordinates (or both)
 ERASE — an Erasure operation with the specified extent
 NEXT-X-ARRAY — a change in X and Y: (y:=y+1,x=Xmin)
 <BS> — back space
 <CR> — carriage return
 <FF> — form feed
 <LF> — line feed
 <SPACE> — space bar
 <HT> — horizontal tab
 <VT> — vertical tab
 G0 — the 7-bit graphic characters of the US ASCII character set
 C0 — the 7-bit control characters of the US ASCII character set

Table F-3 Telnet (Non-Binary Mode) Profile Mapping

System	Character/VT Operation	Maps to:
Host (local to virtual)	<CR><LF>	NEXT-X-ARRAY
	<LF><CR>*	NEXT-X-ARRAY
	<BS><SPACE><BS>*	PTR-RELATIVE X:=X-1/ERASE (current)
	All other characters†	TEXT
Host (virtual to local)	NEXT-X-ARRAY	<CR>
	PTR-RELATIVE X:=X-1 /ERASE (current)	<DELETE>
	ERASE (startx, (Yc, Xc-1)) /PTR-ABSOLUTE (X:=1)	Ctrl/U
	TEXT	Characters
Terminal (local to virtual)	<CR>	NEXT-X-ARRAY
	<DELETE>	PTR-RELATIVE X:=X-1/ERASE (current)
	Ctrl/U	ERASE (startx, (Yc, Xc-1))/PTR-ABSOLUTE (X:=1)
	Ctrl/O	Telnet AO
	Ctrl/C	Telnet IP
	Ctrl/T *	Telnet AYT
	All other characters†	TEXT
Terminal (virtual to local)	NEXT-X-ARRAY	<CR><LF>
	PTR-RELATIVE X:=X-1 /ERASE (current)	<BS><SPACE><BS>
	TEXT	Characters
	ERASE (startx, (Yc, Xc-1)) /PTR-ABSOLUTE (X:=1)	<BS><SPACE><BS>
Telnet (binary mode)	See Transparent	

*DECnet-Plus for OpenVMS only.

†If the G0 character set is selected (versus the G0 and C0), then only the C0 characters are discarded before transmission.

TEXT — an OCTET string of uninterpreted data
 PTR-RELATIVE — change the X or Y coordinates (or both)
 PTR-ABSOLUTE — set the X or Y coordinates (or both)
 ERASE — an Erasure operation with the specified extent
 NEXT-X-ARRAY — a change in X and Y: (y:=y+1,x=Xmin)
 <BS> — back space
 <CR> — carriage return
 <LF> — line feed
 <SPACE> — space bar
 Yc — current value of the Y coordinate
 Xc — current value of the X coordinate

G0 C0 Character Table

Figure G–1 shows the G0 and C0 character sets.

Figure G–1 G0 C0 Character Sets

					C0				G0				
					b7	0	1	0	0	1	1	1	1
					b6	0	0	1	1	0	0	1	1
					b5	0	0	0	1	0	1	0	1
b4	b3	b2	b1		0	1	2	3	4	5	6	7	
0	0	0	0	0		DLE	SP	0	@	P	'	p	
0	0	0	1	1	SOH	DC1	!	1	A	Q	a	q	
0	0	1	0	2	STX	DC2	"	2	B	R	b	r	
0	0	1	1	3	ETX	DC3	#	3	C	S	c	s	
0	1	0	0	4	EOT	DC4	\$	4	D	T	d	t	
0	1	0	1	5	ENQ	NAK	%	5	E	U	e	u	
0	1	1	0	6	ACK	SYN	&	6	F	V	f	v	
0	1	1	1	7	BEL	ETB	'	7	G	W	g	w	
1	0	0	0	8	BS	CAN	(8	H	X	h	x	
1	0	0	1	9	HT	EM)	9	I	Y	i	y	
1	0	1	0	10	LF	SUB	*	:	J	Z	j	z	
1	0	1	1	11	VT	ESC	+	;	K	[k	{	
1	1	0	0	12	FF	FS	,	<	L	\	l		
1	1	0	1	13	CR	GS	-	=	M]	m	}	
1	1	1	0	14	SO	RS	.	>	N	^	n	~	
1	1	1	1	15	SI	US	/	?	O	_	o		

LKG-6137-93R

FTAM Error Messages

This appendix describes the FTAM error messages. They are listed alphabetically in Section H.1 and numerically in Section H.2.

H.1 Error Messages in Alphabetical Order

A provider ABORT has been received

Explanation: A lower-level service provider aborted, which severed the connection.

User Action: Investigate the status of the lower-level services and act accordingly.

Abort diagnostic: *code*

Explanation: The responder aborted with the specified diagnostic code.

User Action: The *code* will describe the reason for the abort. Enable tracing, retry the failed request, and study the trace file.

Access context not available

Explanation: The requested access context is unavailable.

FTAM diagnostic identifier: 5024

User Action: None.

Access context not supported

Explanation: The requested access context is not supported.

FTAM diagnostic identifier: 5025

User Action: None.

Access control inconsistent

Explanation: The requested access control is inconsistent.

FTAM diagnostic identifier: 3016 or 6015

User Action: Enable tracing, retry the failed request, and check the trace file to determine the source of the inconsistency between the access control parameters and the requested access or permitted actions parameters.

Access control not available

Explanation: The requested access control is unavailable.

FTAM diagnostic identifier: 3014 or 6013

User Action: Disable the sending of access control parameters and retry the failed request.

FTAM Error Messages

H.1 Error Messages in Alphabetical Order

Access control not supported

Explanation: The requested access control is not supported.

FTAM diagnostic identifier: 3015 or 6014

User Action: Disable the sending of access control parameters and retry the failed request.

Access request violates VFS security

Explanation: The requested file access has violated virtual filestore security.

FTAM diagnostic identifier: 10

User Action: Compare protection on the file and the privileges of the requestor's account.

Access request violates local security

Explanation: The requested access violates the security checks of the responding system.

FTAM diagnostic identifier: 11

User Action: Check access allowed to the account or file in question.

ACSE — Application name absent

Explanation: The ACSE layer could not find the application name.

User Action: None.

ACSE — Bad diagnostic code

Explanation: The ACSE layer encountered a bad diagnostic code.

User Action: None.

ACSE — Error decoding APDU

Explanation: The ACSE layer encountered an error when decoding the application protocol data unit.

User Action: Enable tracing, retry the failed request, and check the trace file to determine the bad APDU.

ACSE — Error generating an ABORT event

Explanation: The ACSE layer encountered an error when generating an ABORT event.

User Action: Enable tracing, retry the failed request, and check the trace file to determine the bad APDU.

ACSE — Invalid access code

Explanation: The ACSE layer encountered an invalid access code.

User Action: Collect as much pertinent information as possible to identify the error message, describe the error and conditions preceding it, then contact your Digital support representative.

ACSE — Invalid connection block

Explanation: The ACSE layer encountered an invalid connection block.

User Action: Collect as much pertinent information as possible to identify the error message, describe the error and conditions preceding it, then contact your Digital support representative.

FTAM Error Messages

H.1 Error Messages in Alphabetical Order

Activity no longer exists

Explanation: The requested activity no longer exists.

FTAM diagnostic identifier: 6003

User Action: None.

Activity not recognized

Explanation: The requested activity is not recognized.

FTAM diagnostic identifier: 6004

User Action: None.

Activity not unique

Explanation: The requested activity is not unique.

FTAM diagnostic identifier: 6001

User Action: None.

Alias not specified for remote file

Explanation: The initiator did not specify an alias for the remote file.

User Action: Specify an alias for the remote file.

Ambiguous file specification

Explanation: The file specification is ambiguous.

FTAM diagnostic identifier: 3024

User Action: Check the file specification on the command line.

An error occurred while saving negotiated FTAM association information

Explanation: An error occurred while trying to process one of the following negotiated responses: service class, functional units, storage groups, contents type list.

User Action: Check trace for more information.

An F-CANCEL has been received

Explanation: A cancel request arrived before expected file data. The data transfer is incomplete.

User Action: Enable tracing, retry the failed request, and check the trace file to determine the reason for the F-CANCEL.

Association management (unspecific)

Explanation: An association-management problem occurred for an unknown reason. Either the problem or its cause is unknown.

FTAM diagnostic identifier: 2008

User Action: Collect as much pertinent information as possible to identify the error message, describe the error and conditions preceding it, then contact your Digital support representative.

FTAM Error Messages

H.1 Error Messages in Alphabetical Order

Association management — bad account

Explanation: A bad account was specified for the association. Association establishment failed.

FTAM diagnostic identifier: 2010

User Action: Specify a valid initiator ID, filestore password, and account combination on the command line.

Association management — bad address

Explanation: A bad address was specified for the association. Association establishment failed.

FTAM diagnostic identifier: 2009

User Action: Look for incorrect addressing information in the alias database file. Ask the system manager to correct the error.

Association with user not allowed

Explanation: The association with the remote system was denied.

FTAM diagnostic identifier: 2000

User Action: Check factors that can affect association establishment: for example, the system protection of the target system (that is, the user ID and password), the remote application address, or the security information in a file specification.

at least one argument must be remote

Explanation: Neither argument was a remote file.

User Action: Reissue the command, specifying a remote system.

At least one byte of the end-of-contents string is not zero

Explanation: The ASN.1 component found at least one byte of the end-of-contents string that was not zero.

User Action: Enable tracing, retry the failed request, and check the trace file to determine the bad PDU.

Attribute cannot be changed

Explanation: The real filestore cannot alter a specified attribute.

FTAM diagnostic identifier: 4002

User Action: None.

Attribute cannot be read

Explanation: The real filestore cannot read the requested attribute.

FTAM diagnostic identifier: 4001

User Action: None.

Attribute group error (unspecific)

Explanation: An attribute-group error occurred for an unknown reason.

FTAM diagnostic identifier: 2004

User Action: None.

FTAM Error Messages

H.1 Error Messages in Alphabetical Order

Attribute group not allowed

Explanation: A requested attribute group is prohibited.

FTAM diagnostic identifier: 2006

User Action: None.

Attribute group not supported

Explanation: The responder does not support a requested attribute group.

FTAM diagnostic identifier: 2005

User Action: None.

Attribute non-existent

Explanation: The requested attribute does not exist.

FTAM diagnostic identifier: 4000

User Action: None.

Attribute not supported

Explanation: The real filestore does not support a requested attribute.

FTAM diagnostic identifier: 4003

User Action: None.

Bad account

Explanation: A bad account is being used to establish an association.

FTAM diagnostic identifier: 2007 or 3019

User Action: Use the correct account along with the correct initiator ID and filestore password pair on the command line.

Bad attribute name

Explanation: An attribute name specified in a read-attribute request is invalid.

FTAM diagnostic identifier: 3003 or 4004

User Action: None.

Bad attribute value

Explanation: A bad value exists for one or more file attributes.

FTAM diagnostic identifier: 3027 or 4005

User Action: None.

Bad checkpoint (unspecific)

Explanation: A checkpoint is bad for unknown reasons.

FTAM diagnostic identifier: 6000

User Action: None.

Bad data element type

Explanation: An incorrect data-element type occurred.

FTAM diagnostic identifier: 5014

User Action: This message is returned by another vendor's responder. Check that vendor's FTAM documentation for information about the error.

FTAM Error Messages

H.1 Error Messages in Alphabetical Order

Bad FADU (unspecific)

Explanation: A file-access data unit (FADU) is bad for unknown reasons.

FTAM diagnostic identifier: 5000

User Action: None.

Bad FADU — bad location

Explanation: The specified file-access data unit (FADU) location is incorrect.

FTAM diagnostic identifier: 5004

User Action: None.

Bad FADU — poorly specified

Explanation: The requested file-access data unit (FADU) is improperly specified.

FTAM diagnostic identifier: 5003

User Action: None.

Bad FADU — size error

Explanation: The specified record size is incorrect.

FTAM diagnostic identifier: 5001

User Action: None.

Bad FADU — type error

Explanation: The specified file-access data unit (FADU) type is incorrect.

FTAM diagnostic identifier: 5002

User Action: None.

Bad open flags *flag-value*

Explanation: The responder encountered the specified bad flag value.

User Action: Collect as much pertinent information as possible to identify the error message, describe the error and conditions preceding it, then contact your Digital support representative.

Bad read (unspecific)

Explanation: An attempt to read data from the specified file failed for an unknown reason.

FTAM diagnostic identifier: 5027

User Action: None.

Bad recovery point

Explanation: A recovery point is bad.

FTAM diagnostic identifier: 6008

User Action: None.

FTAM Error Messages

H.1 Error Messages in Alphabetical Order

Bad write (unspecific)

Explanation: An attempt to write data into the specified file failed for an unknown reason.

FTAM diagnostic identifier: 5026

User Action: None.

Buffer too small

Explanation: The received data is greater than 7K. The remote implementation has sent a buffer greater than the 7K maximum suggested by NIST.

User Action: Notify the vendor.

BUGCHECK at line *line* in module *module/reason*

Explanation: A BUGCHECK was found at the specified line in the specified module. The specific reason is given on the next line.

User Action: Collect as much pertinent information as possible to identify the error message, describe the error and conditions preceding it, then contact your Digital support representative.

Cancel received during data transfer

Explanation: The peer system has canceled the data transfer.

User Action: None.

cannot open local file *file-name*

Explanation: The specified local file could not be opened using this command.

User Action: None.

cannot open remote file *file-name*

Explanation: The specified remote file could not be opened using this command.

User Action: None.

Cannot simplify contents type

Explanation: The FTAM initiator can simplify files in this hierarchy:

FTAM-2 → FTAM-1

FTAM-1 → FTAM-3

No simplification path exists for this file to a file type supported by the remote responder.

User Action: None.

cannot specify unlimited string length for fixed length files

Explanation: Fixed length files require a string length.

User Action: Reissue the command with the -M option.

Checkpoint outside of window

Explanation: The checkpoint is outside of the window.

FTAM diagnostic identifier: 6002

User Action: None.

FTAM Error Messages

H.1 Error Messages in Alphabetical Order

Checkpoint window error — too large

Explanation: The checkpoint is too large for the window.

FTAM diagnostic identifier: 2011

User Action: None.

Checkpoint window error — too small

Explanation: The checkpoint is too small for the window.

FTAM diagnostic identifier: 2012

User Action: None.

Checkpoint window error — unsupported

Explanation: The checkpoint is unsupported.

FTAM diagnostic identifier: 2013

User Action: None.

Communications QoS not supported

Explanation: The requested communications quality of service is unsupported.

FTAM diagnostic identifier: 2014

User Action: None.

Concurrency control inconsistent

Explanation: Concurrency control is inconsistent.

FTAM diagnostic identifier: 5020

User Action: Retry without concurrency control parameters.

Concurrency control not available

Explanation: Concurrency control is unavailable.

FTAM diagnostic identifier: 3008 or 5018

User Action: Retry without concurrency control parameters.

Concurrency control not possible

Explanation: Concurrency control is not possible.

FTAM diagnostic identifier: 3010

User Action: Retry without concurrency control parameters.

Concurrency control not supported

Explanation: Concurrency control is not supported.

FTAM diagnostic identifier: 3009 or 5019

User Action: Retry without concurrency control parameters.

Conflicting parameter values

Explanation: An internal software error occurred.

FTAM diagnostic identifier: 1000

User Action: Collect as much pertinent information as possible to identify the error message, describe the error and conditions preceding it, then contact your Digital support representative.

FTAM Error Messages

H.1 Error Messages in Alphabetical Order

Contents type inconsistent

Explanation: The requested contents type violates the negotiation rules or is inconsistent with the real contents type of the file.

FTAM diagnostic identifier: 5036 or 6016

User Action: Retry the copy command with the correct document type parameters.

Contents type list cut by initiator

Explanation: Presentation cut or reduced the requested contents type list. Some document types might not be supported.

FTAM diagnostic identifier: 2019

User Action: None.

Contents type list cut by responder

Explanation: The responding FTAM entity cut the requested list of contents types. Some requested document types might not be supported.

FTAM diagnostic identifier: 2018

User Action: None.

Contents type simplified

Explanation: The initiator opened the file with a simplified contents type, which the responder accepted. Simplification can involve the document type, the parameters, or both.

FTAM diagnostic identifier: 5037 or 6017

User Action: None.

Context management refused

Explanation: The requested presentation-context management was invalid. Once an FTAM regime exists, you cannot change the negotiated presentation context.

FTAM diagnostic identifier: 2016

User Action: None.

Corrupt docket

Explanation: The docket is corrupt.

FTAM diagnostic identifier: 6006

User Action: None.

Damage to select/open regime

Explanation: The select or open regime was damaged for an unknown reason.

FTAM diagnostic identifier: 5039

User Action: None.

FTAM Error Messages

H.1 Error Messages in Alphabetical Order

Decoded length larger than amount of remaining data in PDU

Explanation: The ASN.1 component found a decoded length that is larger than the amount of remaining data in the protocol data unit.

User Action: Enable tracing, retry the failed request, and check the trace file for the bad PDU.

Decoded length won't fit into an unsigned longword

Explanation: The ASN.1 component found a decoded length that does not fit into an unsigned longword.

User Action: Enable tracing, retry the failed request, and check the trace file for the bad PDU.

Delay may be encountered

Explanation: The action may take more time than usual.

FTAM diagnostic identifier: 6

User Action: None.

directory copies are not supported

Explanation: FTAM does not support copying a directory file.

User Action: Do not try to copy a directory file.

document type must be specified when specifying universal class number, string significance, or maximum string length

Explanation: The document type must be specified when specifying universal class number, string significance, or maximum string length using this command.

User Action: Reissue the command with a document type.

Duplicate FADU name

Explanation: A duplicate record has been detected.

FTAM diagnostic identifier: 5038

User Action: None.

Duplicated parameter

Explanation: A parameter in an FTAM PDU has been specified twice.

FTAM diagnostic identifier: 1004

User Action: Collect as much pertinent information as possible to identify the error message, describe the error and conditions preceding it, then contact your Digital support representative.

Encoded integer value too long

Explanation: The ASN.1 component found an encoded integer value that is too long.

User Action: Enable tracing, retry the failed request, and check the trace file for the bad PDU.

FTAM Error Messages

H.1 Error Messages in Alphabetical Order

End of transition list reached without a state change

Explanation: FTAM reached the end of the transition list without a state change.

User Action: Collect as much pertinent information as possible to identify the error message, describe the error and conditions preceding it, then contact your Digital support representative.

Ending guard zone of block *address* has been modified

The block was created in *module-name* at line *line-number*

CMN_DEALLOCATE was called from *module-name* at line *line-number*

Explanation: The ending guard zone of the specified block address has been modified. The block was created at the specified line of the specified module. CMN_DEALLOCATE was called from the specified line of the specified module.

User Action: Collect as much pertinent information as possible to identify the error message, describe the error and conditions preceding it, then contact your Digital support representative.

Error allocating connect block

Explanation: The responder encountered an error when allocating the connect block.

User Action: Collect as much pertinent information as possible to identify the error message, describe the error and conditions preceding it, then contact your Digital support representative.

Error allocating parameter block

Explanation: The responder encountered an error when allocating the parameter block.

User Action: Collect as much pertinent information as possible to identify the error message, describe the error and conditions preceding it, then contact your Digital support representative.

Error allocating space for *type* information

Explanation: FTAM encountered an error when allocating space for the specified information, which is either a contents type list or a file name.

User Action: Collect as much pertinent information as possible to identify the error message, describe the error and conditions preceding it, then contact your Digital support representative.

Error calling state machine action routine

Explanation: FTAM encountered an error when calling the state machine action routine.

User Action: Collect as much pertinent information as possible to identify the error message, describe the error and conditions preceding it, then contact your Digital support representative.

Error closing trace file *file-name*

Explanation: An error was encountered when closing the specified trace file.

User Action: Check for a full file system or file protection.

FTAM Error Messages

H.1 Error Messages in Alphabetical Order

Error decoding FTAM PDU

Explanation: The initiator encountered an error while decoding the FTAM protocol data unit.

User Action: Enable tracing, retry the failed request, and check the trace file for the bad PDU.

Error decoding length

Explanation: The ASN.1 component encountered an error when decoding the length.

User Action: Enable tracing, retry the failed request, and check the trace file for the bad PDU.

Error decoding nested value within SEQUENCE '*ASN.1-field-name*'

Explanation: The ASN.1 component encountered an error when decoding a nested value within the specified SEQUENCE field.

User Action: Enable tracing, retry the failed request, and check the trace file for the bad PDU. Subsequent messages will describe the bad element in the sequence.

Error decoding nested value within SET '*ASN.1-field-name*'

Explanation: The ASN.1 component encountered an error when decoding a nesting value within the specified SET field.

User Action: Enable tracing, retry the failed request, and check the trace file for the bad PDU. Subsequent messages will describe the bad element in the set.

Error decoding nested value within tagged value '*ASN.1-field-name*'

Explanation: The ASN.1 component encountered an error when decoding a nesting value within the specified tagged value.

User Action: Enable tracing, retry the failed request, and check the trace file for the bad PDU. Subsequent messages will describe the bad element in the tagged value.

Error decoding parameter '*ASN.1-field-name*'

Explanation: The ASN.1 component encountered an error decoding the specified parameter.

User Action: Enable tracing, retry the failed request, and check the trace file for the bad parameter. Subsequent messages will describe the problem.

Error decoding tag value

Explanation: The ASN.1 component encountered an error when decoding a tag value.

User Action: Enable tracing, retry the failed request, and check the trace file for the tag value. Subsequent messages will describe the problem.

Error encoding nested value within SEQUENCE '*ASN.1-field-name*'

Explanation: The ASN.1 component encountered an error when encoding a nesting value within the specified SEQUENCE field.

User Action: Enable tracing, retry the failed request, and check the trace file for the bad value in the sequence. Subsequent messages will describe the problem.

FTAM Error Messages

H.1 Error Messages in Alphabetical Order

Error encoding nested value within SET '*ASN.1-field-name*'

Explanation: The ASN.1 component encountered an error when encoding a nesting value within the specified SET field.

User Action: Enable tracing, retry the failed request, and check the trace file for the bad value in the set. Subsequent messages will describe the problem.

Error encoding nested value within tagged value '*ASN.1-field-name*'

Explanation: The ASN.1 component encountered an error when encoding a nesting value within the specified tagged value.

User Action: Enable tracing, retry the failed request, and check the trace file for the bad value. Subsequent messages will describe the problem.

Error encoding parameter '*ASN.1-field-name*'

Explanation: The ASN.1 component encountered an error when encoding the specified parameter.

User Action: Collect as much pertinent information as possible to identify the error message, describe the error and conditions preceding it, then contact your Digital support representative.

Error encoding tag for parameter '*ASN.1-field-name*'

Explanation: The ASN.1 component encountered an error when encoding a tag for the specified parameter.

User Action: Collect as much pertinent information as possible to identify the error message, describe the error and conditions preceding it, then contact your Digital support representative.

Error encoding universal class type for parameter '*ASN.1-field-name*'

Explanation: The ASN.1 component encountered an error when encoding the universal class type for the specified parameter.

User Action: Collect as much pertinent information as possible to identify the error message, describe the error and conditions preceding it, then contact your Digital support representative.

Error logging in

Explanation: The responder encountered an error when logging in.

User Action: None.

Error logging out

Explanation: The responder encountered an error when logging out.

User Action: None.

Error looking up current directory

Explanation: The responder encountered an error looking up the current directory.

User Action: The directory might not exist. Check the user's home directory and the protection or availability of the file.

Error occurred while trying to assign an API port

Explanation: FTAM encountered an error while trying to assign a port for the Application Programming Interface.

User Action: See further messages for more details.

FTAM Error Messages

H.1 Error Messages in Alphabetical Order

Error occurred while trying to receive an API event

Explanation: FTAM encountered an error while trying to receive an event from the Application Programming Interface. Subsequent error messages will describe the error.

User Action: None.

Error opening trace file *file-name*

Explanation: An error was encountered when opening the specified trace file.

User Action: Check for full file system or file protections.

Error reading attributes

Explanation: The responder or the initiator encountered an error when reading attributes.

User Action: None.

Error sending a PDU, return code is XXXXX

Explanation: No response was received for the named parameter requested in either an f-read-attributes request or the f-open request FTAM PDU (protocol data unit).

FTAM diagnostic identifier: See `osif.h` for text that describes the named return code.

User Action: Check trace for more information.

Error sending a PDU, return code is *osif-error-code*

Explanation: The responder encountered an error with the specified return code when sending a protocol data unit.

User Action: Enable tracing and retry the failed request. If you cannot find the problem, collect as much pertinent information as possible to identify the error message, describe the error and conditions preceding it, then contact your Digital support representative.

Error sending an F-BEGIN-GROUP request

Explanation: The initiator encountered an error sending an F-BEGIN-GROUP request.

User Action: Enable tracing and retry the failed request. If you cannot find the problem, collect as much pertinent information as possible to identify the error message, describe the error and conditions preceding it, then contact your Digital support representative.

Error sending an F-CANCEL request

Explanation: The initiator encountered an error sending an F-CANCEL request.

User Action: Enable tracing and retry the failed request. If you cannot find the problem, collect as much pertinent information as possible to identify the error message, describe the error and conditions preceding it, then contact your Digital support representative.

FTAM Error Messages

H.1 Error Messages in Alphabetical Order

Error sending an F-CHANGE-ATTRIBUTE request

Explanation: The initiator encountered an error sending an F-CHANGE-ATTRIBUTE request.

User Action: Enable tracing and retry the failed request. If you cannot find the problem, collect as much pertinent information as possible to identify the error message, describe the error and conditions preceding it, then contact your Digital support representative.

Error sending an F-CLOSE request

Explanation: The initiator encountered an error sending an F-CLOSE request.

User Action: Enable tracing and retry the failed request. If you cannot find the problem, collect as much pertinent information as possible to identify the error message, describe the error and conditions preceding it, then contact your Digital support representative.

Error sending an F-CREATE request

Explanation: The initiator encountered an error sending an F-CREATE request.

User Action: Enable tracing and retry the failed request. If you cannot find the problem, collect as much pertinent information as possible to identify the error message, describe the error and conditions preceding it, then contact your Digital support representative.

Error sending an F-DATA request

Explanation: The initiator encountered an error sending an F-DATA request.

User Action: Enable tracing and retry the failed request. If you cannot find the problem, collect as much pertinent information as possible to identify the error message, describe the error and conditions preceding it, then contact your Digital support representative.

Error sending an F-DATA-END request

Explanation: The initiator encountered an error sending an F-DATA-END request.

User Action: Enable tracing and retry the failed request. If you cannot find the problem, collect as much pertinent information as possible to identify the error message, describe the error and conditions preceding it, then contact your Digital support representative.

Error sending an F-DELETE request

Explanation: The initiator encountered an error sending an F-DELETE request.

User Action: Enable tracing and retry the failed request. If you cannot find the problem, collect as much pertinent information as possible to identify the error message, describe the error and conditions preceding it, then contact your Digital support representative.

FTAM Error Messages

H.1 Error Messages in Alphabetical Order

Error sending an F-DESELECT request

Explanation: The initiator encountered an error sending an F-DESELECT request.

User Action: Enable tracing and retry the failed request. If you cannot find the problem, collect as much pertinent information as possible to identify the error message, describe the error and conditions preceding it, then contact your Digital support representative.

Error sending an F-END-GROUP request

Explanation: The initiator encountered an error sending an F-END-GROUP request.

User Action: Enable tracing and retry the failed request. If you cannot find the problem, collect as much pertinent information as possible to identify the error message, describe the error and conditions preceding it, then contact your Digital support representative.

Error sending an F-OPEN request

Explanation: The initiator encountered an error sending an F-OPEN request.

User Action: Enable tracing and retry the failed request. If you cannot find the problem, collect as much pertinent information as possible to identify the error message, describe the error and conditions preceding it, then contact your Digital support representative.

Error sending an F-READ request

Explanation: The initiator encountered an error sending an F-READ request.

User Action: Enable tracing and retry the failed request. If you cannot find the problem, collect as much pertinent information as possible to identify the error message, describe the error and conditions preceding it, then contact your Digital support representative.

Error sending an F-READ-ATTRIBUTE request

Explanation: The initiator encountered an error sending an F-READ-ATTRIBUTE request.

User Action: Enable tracing and retry the failed request. If you cannot find the problem, collect as much pertinent information as possible to identify the error message, describe the error and conditions preceding it, then contact your Digital support representative.

Error sending an F-SELECT request

Explanation: The initiator encountered an error sending an F-SELECT request.

User Action: Enable tracing and retry the failed request. If you cannot find the problem, collect as much pertinent information as possible to identify the error message, describe the error and conditions preceding it, then contact your Digital support representative.

FTAM Error Messages

H.1 Error Messages in Alphabetical Order

Error sending an F-TERMINATE request

Explanation: The initiator encountered an error sending an F-TERMINATE request.

User Action: Enable tracing and retry the failed request. If you cannot find the problem, collect as much pertinent information as possible to identify the error message, describe the error and conditions preceding it, then contact your Digital support representative.

Error sending an F-TRANSFER-END request

Explanation: The initiator encountered an error sending an F-TRANSFER-END request.

User Action: Enable tracing and retry the failed request. If you cannot find the problem, collect as much pertinent information as possible to identify the error message, describe the error and conditions preceding it, then contact your Digital support representative.

Error sending an F-WRITE request

Explanation: The initiator encountered an error sending an F-WRITE request.

User Action: Enable tracing and retry the failed request. If you cannot find the problem, collect as much pertinent information as possible to identify the error message, describe the error and conditions preceding it, then contact your Digital support representative.

Error sending node descriptor data element for FTAM-2 file

Explanation: The initiator encountered an error when sending a node descriptor data element for an FTAM-2 file.

User Action: Enable tracing and retry the failed request. If you cannot find the problem, collect as much pertinent information as possible to identify the error message, describe the error and conditions preceding it, then contact your Digital support representative.

Error translating transport address *address*

Explanation: The listener encountered an error when translating the specified transport address.

User Action: None.

Error trying to allocate an API buffer

Explanation: FTAM encountered an error when trying to allocate an API buffer.

User Action: Collect as much pertinent information as possible to identify the error message, describe the error and conditions preceding it, then contact your Digital support representative.

FADU cannot be inserted

Explanation: The real filestore cannot insert a file-access data unit (FADU) at the current location.

FTAM diagnostic identifier: 5011

User Action: None.

FTAM Error Messages

H.1 Error Messages in Alphabetical Order

FADU cannot be located

Explanation: The record identified by the the file-access data unit (FADU) ID could not be found.

FTAM diagnostic identifier: 5013

User Action: None.

FADU cannot be replaced

Explanation: The real filestore cannot replace the file-access data unit (FADU) at the current location.

FTAM diagnostic identifier: 5012

User Action: None.

FADU does not exist

Explanation: The requested file-access data unit (FADU) is nonexistent.

FTAM diagnostic identifier: 5005

User Action: None.

FADU locking not available on file

Explanation: The file system does not support record locking.

FTAM diagnostic identifier: 5040

User Action: None.

FADU not available for erasure

Explanation: The record could not be erased.

FTAM diagnostic identifier: 5010

User Action: None.

FADU not available for location

Explanation: The record could not be located.

FTAM diagnostic identifier: 5009

User Action: None.

FADU not available for reading

Explanation: The requested file-access data unit (FADU) is unavailable for reading.

FTAM diagnostic identifier: 5007

User Action: None.

FADU not available for writing

Explanation: The requested file-access data unit (FADU) is unavailable for writing.

FTAM diagnostic identifier: 5008

User Action: None.

FTAM Error Messages

H.1 Error Messages in Alphabetical Order

FADU not available (unspecific)

Explanation: The requested file-access data unit (FADU) is unavailable for an unknown reason.

FTAM diagnostic identifier: 5006

User Action: None.

File already exists

Explanation: The file being created already exists, and an override was not requested.

FTAM diagnostic identifier: 3005

User Action: None.

File busy

Explanation: Another user has locked the specified file.

FTAM diagnostic identifier: 3012

User Action: Try later.

File cannot be created

Explanation: The file cannot be created.

FTAM diagnostic identifier: 3006

User Action: None.

File cannot be deleted

Explanation: The file cannot be deleted.

FTAM diagnostic identifier: 3007

User Action: None.

File created but not selected

Explanation: The file is created, but it is not selected.

FTAM diagnostic identifier: 3030

User Action: None.

file names are identical

Explanation: Identical file names were found using this command.

User Action: Reissue the command with a different name for the destination file.

File not available

Explanation: The requested file is unavailable to the initiator.

FTAM diagnostic identifier: 3013

User Action: None.

File waiting restart

Explanation: The file is waiting for restart.

FTAM diagnostic identifier: 6007

User Action: None.

FTAM Error Messages

H.1 Error Messages in Alphabetical Order

file-name: permission denied

Explanation: Permission to access the specified file was denied while using this command.

User Action: Check the protection on the file and try again.

Filename not found

Explanation: The file name was not found.

FTAM diagnostic identifier: 3000

User Action: None.

Filename truncated

Explanation: The file name specified on the command line was too long and was truncated by the responder.

FTAM diagnostic identifier: 3017

User Action: Use a shorter file name.

filename was not supplied by the remote system

Explanation: The requested file name was not returned by the remote system.

User Action: Report the problem to the other vendor.

FTAM — Bad Parameter

Explanation: The FTAM layer found a bad parameter.

User Action: Enable tracing and retry the failed request. If you cannot find the problem, collect as much pertinent information as possible to identify the error message, describe the error and conditions preceding it, then contact your Digital support representative.

FTAM—Can't create the contents type database

Explanation: An error occurred while trying to process the information found in the /ftamoids file.

User Action: Refer to other messages displayed for more information.

FTAM—Can't open file contents_type_database file

Explanation: Can't open /ftamoids file.

User Action: Verify that the /ftamoids exists and is readable.

FTAM — Contents Type invalid

Explanation: The FTAM layer found an invalid contents type.

User Action: Enable tracing and retry the failed request. If you cannot find the problem, collect as much pertinent information as possible to identify the error message, describe the error and conditions preceding it, then contact your Digital support representative.

FTAM Error Messages

H.1 Error Messages in Alphabetical Order

FTAM — CTDB context not negotiated

Explanation: The FTAM layer did not negotiate the contents type database context.

User Action: Enable tracing and retry the failed request. If you cannot find the problem, collect as much pertinent information as possible to identify the error message, describe the error and conditions preceding it, then contact your Digital support representative.

FTAM — Extra Contents Type

Explanation: The FTAM layer found an extra contents type.

User Action: Enable tracing and retry the failed request. If you cannot find the problem, collect as much pertinent information as possible to identify the error message, describe the error and conditions preceding it, then contact your Digital support representative.

FTAM — FTAM quality of service not provided

Explanation: The FTAM layer did not provide the FTAM quality of service.

User Action: Notify the vendor of the problem.

FTAM — Functionality not supported

Explanation: The FTAM layer does not support this functionality.

User Action: None.

FTAM — Group threshold violations

Explanation: The FTAM layer found grouping threshold violations.

User Action: Enable tracing and retry the failed request. If you cannot find the problem, notify the vendor.

FTAM—Invalid abstract syntax reference

Explanation: An abstract syntax, associated with a document type definition in the /ftamoids file, is not defined.

User Action: An abstract syntax used to define a document type must be defined before it can be referenced in a document type definition.

FTAM—Invalid constraint set reference

Explanation: A constraint set, associated with a document type definition in the /ftamoids file, is not defined.

User Action: A constraint set used to define a document type must be defined before it can be referenced in a document type definition.

FTAM—Invalid constraint set handler reference

Explanation: An unknown constraint set handler was specified in the /ftamoids file.

User Action: Valid constraint set handler references are: osif_user_cs_handler.

FTAM — Invalid context identifiers

Explanation: The FTAM layer found invalid context identifiers.

User Action: Enable tracing and retry the failed request. If you cannot find the problem, notify the vendor.

FTAM Error Messages

H.1 Error Messages in Alphabetical Order

FTAM—Invalid document type handler reference

Explanation: A unknown document type handler was specified in the /ftamoids file.

User Action: Valid document type handler references are: osif_ftam1_handler, osif_ftam2_handler, osif_ftam3_handler, osif_nbs9_handler, and osif_user_dt_handler.

FTAM—Invalid file model reference

Explanation: A file model, associated with a document type definition in the /ftamoids file, is not defined.

User Action: A file model used to define a document type must be defined before it can be referenced in a document type definition.

FTAM—Invalid object identifier type reference

Explanation: An invalid object identifier type was specified in the /ftamoids file.

User Action: Valid object identifiers define: file models, FTAM FADU, FTAM PCI, constraint sets, abstract syntaxes, and document types.

FTAM — Invalid String Significance

Explanation: The FTAM layer found an invalid string significance.

User Action: Enable tracing and retry the failed request. If you cannot find the problem, notify the vendor.

FTAM — Invalid Universal Class Number

Explanation: The FTAM layer found an invalid universal class number.

User Action: Enable tracing and retry the failed request. If you cannot find the problem, notify the vendor.

FTAM — Lower Layer Connect Failure

Explanation: The FTAM layer failed when trying to connect to a lower layer.

User Action: None.

FTAM — No more memory available

Explanation: The FTAM layer failed due to lack of memory.

User Action: Collect as much pertinent information as possible to identify the error message, describe the error and conditions preceding it, then contact your Digital support representative.

FTAM — Presentation Context Missing

Explanation: The FTAM layer could not find a presentation context.

User Action: Enable tracing, retry the failed request, and check the trace file.

FTAM — Protocol Error

Explanation: The FTAM layer encountered a protocol error.

User Action: Enable tracing, retry the failed request, and check the trace file.

FTAM Error Messages

H.1 Error Messages in Alphabetical Order

FTAM — Request violates negotiated options

Explanation: The FTAM layer found a request that violates negotiated options.

User Action: Find out what the application was trying to do and which options had been negotiated. If appropriate, try to use another command.

FTAM — Unsupported Parameter Value

Explanation: The FTAM layer found an unsupported parameter value.

User Action: Try to find the bad value and change it.

FTAM Listener start on TSAP '*tsap*'

Explanation: An FTAM listener is starting up at the specified transport service access point.

User Action: None.

FTAM management problem (unspecific)

Explanation: An unknown FTAM-management problem occurred. Either the problem or its cause is unknown.

FTAM diagnostic identifier: 3

User Action: None.

FTAM management, bad account

Explanation: A bad account was specified for the FTAM regime. Regime establishment failed.

FTAM diagnostic identifier: 4

User Action: Specify a valid initiator ID, filestore password, and account combination on the command line.

FTAM management, security not passed

Explanation: Required security information is absent or incorrect.

FTAM diagnostic identifier: 5

User Action: On your command line, specify a valid initiator ID and filestore password pair that allows access to the specified file.

FTAM protocol error (unspecific)

Explanation: An unknown protocol error occurred.

FTAM diagnostic identifier: 1007

User Action: The remote FTAM application of the current association produced this error. Collect as much pertinent information as possible and report the FTAM diagnostic message and the conditions preceding its occurrence to the vendor of that remote FTAM application.

FTAM protocol error, corruption error

Explanation: An FTAM protocol error was detected.

FTAM diagnostic identifier: 1010

User Action: The remote FTAM application of the current association produced this error. Collect as much pertinent information as possible and report the FTAM diagnostic message and the conditions preceding its occurrence to the vendor of that remote FTAM application.

FTAM Error Messages

H.1 Error Messages in Alphabetical Order

FTAM protocol error, functional unit error

Explanation: A violation of the negotiations for functional units caused an FTAM protocol error.

FTAM diagnostic identifier: 1009

User Action: The remote FTAM application of the current association produced this error. Collect as much pertinent information as possible and report the FTAM diagnostic message and the conditions preceding its occurrence to the vendor of that remote FTAM application.

FTAM protocol error, procedure error

Explanation: An FTAM protocol error was detected.

FTAM diagnostic identifier: 1008

User Action: The remote FTAM application of the current association produced this error. Collect as much pertinent information as possible and report the FTAM diagnostic message and the conditions preceding its occurrence to the vendor of that remote FTAM application.

FTAM Provider Abort message received

Explanation: The local FTAM protocol machine detected an error.

User Action: Collect as much pertinent information as possible and notify the vendor about the error message and describe the error and the conditions preceding it.

FTAM User Abort message received

Explanation: The remote FTAM implementation detected an error.

User Action: Collect as much pertinent information as possible and notify the vendor about the error message and describe the error and the conditions preceding it.

Functional unit invalid in processing mode

Explanation: The functional units negotiated within the FTAM regime are invalid for the processing mode of the current open regime.

FTAM diagnostic identifier: 5035

User Action: None.

Functional unit not available for requested access

Explanation: The requested access violates the negotiated set of functional units.

FTAM diagnostic identifier: 3029

User Action: None.

Further details: *diagnostic-text-string*

Explanation: This message provides more information about the received diagnostic. The diagnostic text string is textual information sent by the remote application.

User Action: None.

FTAM Error Messages

H.1 Error Messages in Alphabetical Order

Future filesize exceeded

Explanation: The file being created exceeds the allocated future file size.

FTAM diagnostic identifier: 5032

User Action: Recreate the file with a larger future file size.

Future filesize increased

Explanation: When creating a file, the real filestore automatically increased the file's future file size.

FTAM diagnostic identifier: 5034

User Action: None.

Grouping threshold violation

Explanation: The number of primitives within a service grouping differs from the value specified for the grouping threshold.

FTAM diagnostic identifier: 1016

User Action: Collect as much pertinent information as possible to identify the error message, describe the error and conditions preceding it, then contact your Digital support representative.

illegal concurrency control access name —
valid choices are: read, insert, replace, extend, erase,
read-attribute, change-attribute, delete-file

Explanation: An illegal concurrency control access name was found using this command.

User Action: Reissue the command with the correct concurrency control access name.

illegal concurrency control key name —
valid choices are: not-required, shared, exclusive, no-access

Explanation: An illegal concurrency control key name was found using this command.

User Action: Reissue the command with the correct concurrency control key name.

illegal concurrency control syntax; missing colon(:)

Explanation: A missing colon resulted in an illegal concurrency control syntax while using this command.

User Action: Reissue the command with the correct syntax.

illegal concurrency control syntax; missing comma(,)

Explanation: A missing comma resulted in an illegal concurrency control syntax while using this command.

User Action: Reissue the command with the correct syntax.

illegal concurrency control syntax; missing parenthesis

Explanation: A missing parenthesis resulted in an illegal concurrency control syntax while using this command.

User Action: Reissue the command with a parenthesis.

FTAM Error Messages

H.1 Error Messages in Alphabetical Order

illegal document type specified —
valid choices are FTAM-1, FTAM-2, FTAM-3, NBS-9, or INTAP-1

Explanation: An illegal document type was specified using this command.

User Action: Reissue the command with the correct document type.

Illegal grouping sequence

Explanation: The requested grouping contains an illegal sequence of FTAM primitives.

FTAM diagnostic identifier: 1015

User Action: Collect as much pertinent information as possible to identify the error message, describe the error and conditions preceding it, then contact your Digital support representative.

Illegal length value of 255 found

Explanation: The ASN.1 component found an illegal length value of 255.

User Action: Collect as much pertinent information as possible to identify the error message, describe the error and conditions preceding it, then contact your Digital support representative.

Illegal parameter type

Explanation: A parameter type in a call to the file service is illegal.

FTAM diagnostic identifier: 1005

User Action: Collect as much pertinent information as possible to identify the error message, describe the error and conditions preceding it, then contact your Digital support representative.

illegal string significance specified —
valid choices are v (variable), f (fixed), or n (no string significance)

Explanation: An illegal string significance was specified using this command.

User Action: Reissue the command with the correct string significance.

illegal string significance specified - *string* valid choices are v (variable), f (fixed), or n (no string significance)

Explanation: Explanation: Invalid FTAM document type string significance was specified. The only valid entries are "v", "f", or "n".

User Action: Re-enter utility, specifying a valid string significance value.

illegal universal class number specified —
valid choices are printable, IA5, graphic, visible, or general

Explanation: An illegal universal class number was specified using this command.

User Action: Reissue the command with the correct universal class number.

Incompatible service classes

Explanation: The negotiated service classes are not correct.

FTAM diagnostic identifier: 2021

User Action: Collect as much pertinent information as possible to identify the error message, describe the error and conditions preceding it, then contact your Digital support representative.

FTAM Error Messages

H.1 Error Messages in Alphabetical Order

Initial attributes altered

Explanation: The responder altered the initial attributes specified in the F-CREATE request, but the file creation succeeded.

FTAM diagnostic identifier: 3018

User Action: None.

Initial attributes not possible

Explanation: A file could not be created with the initial attributes specified on the F-CREATE request.

FTAM diagnostic identifier: 3002

User Action: None.

Initiator error (unspecific)

Explanation: An unknown error occurred in the initiator.

FTAM diagnostic identifier: 7

User Action: None.

Initiator identity unacceptable

Explanation: The specified initiator identity is not acceptable.

FTAM diagnostic identifier: 2015

User Action: None.

Insufficient buffer space to receive data

Explanation: FTAM has insufficient buffer space to receive data.

User Action: Collect as much pertinent information as possible to identify the error message, describe the error and conditions preceding it, then contact your Digital support representative.

Invalid access password specified

Explanation: The access password specified by the user is invalid.

User Action: Check the access password used on the command line.

Invalid address *address string*

Explanation: The OpenVMS psap.ssap.tsap.nsap address format is invalid.

User Action: Modify OpenVMS address so it conforms to the required psap.ssap.tsap.nsap format.

Invalid create password

Explanation: The password used for file creation is not valid.

FTAM diagnostic identifier: 3025

User Action: Check the password used on the command line.

invalid create password specified

Explanation: An invalid create password was specified using this command.

User Action: Check the create password. If you are using hexadecimal values (preceded by %x), make sure there are an even number of bytes in the value (for example, %x01).

FTAM Error Messages

H.1 Error Messages in Alphabetical Order

Invalid delete password on override

Explanation: The password used for deleting a file (to be overridden) is invalid. It does not match the remote filestore's delete password.

FTAM diagnostic identifier: 3026

User Action: Check the password used on the command line.

Invalid filestore password

Explanation: The specified filestore password is not valid.

FTAM diagnostic identifier: 2020

User Action: Use the correct password on the command line.

Invalid FTAM access control list - missing mandatory action-list parameter

Explanation: ocp security group was specified but the specification did not include the mandatory action-list parameter.

User Action: Enter command with action-list. Refer to ocp reference page.

Invalid FTAM security group parameter: concurrency=(ca-name:ca-key[,ca-name:ca-key...]); passwords=(apwd-type:apwd-value[,apwd-type:apwd-value...]); identity=user-identity-string; legal-qual=legal-qual-string

Explanation: Invalid syntax was entered for the security group parameter specification.

User Action: Check syntax specification and re-enter command.

Invalid *parameter* specified for file *file-name*

Explanation: The initiator found that the specified file name contains the invalid parameter specified. The possible invalid parameters are alias, account, password, or user name.

User Action: Reissue the command with the correct values.

Invalid SAP length

Explanation: FTAM found an invalid service access point length.

User Action: Check the service access points. If you are using hexadecimal values (preceded by %x), SAPs must be an even number of bytes long (for example, %x01).

Length size for *number* is too big by *number* octets

Explanation: The ASN.1 component encountered a length size for the number of bytes of data that was too large by the specified number of octets.

User Action: Collect as much pertinent information as possible to identify the error message, describe the error and conditions preceding it, then contact your Digital support representative.

Local failure (unspecific)

Explanation: The responder reports a failure with an unknown reason.

FTAM diagnostic identifier: 5028

User Action: None.

FTAM Error Messages

H.1 Error Messages in Alphabetical Order

Local failure — data corrupted

Explanation: The responder reports that the data being transferred is corrupted.

FTAM diagnostic identifier: 5030

User Action: None.

Local failure — device failure

Explanation: The responder reports that a local device failed.

FTAM diagnostic identifier: 5031

User Action: Check the devices in use for any failures and take proper actions.

Local failure — filespace exhausted

Explanation: The responder reports that the specified device lacks space.

FTAM diagnostic identifier: 5029

User Action: Clear some space on the device or specify a different device.

local fstat error

Explanation: A local `fstat` error was encountered using this command.

User Action: Check the local file specification.

local read error

Explanation: A local read error was encountered using this command.

User Action: Enable tracing, retry the failed request, and check the trace file.

local write error

Explanation: A local write error was encountered using this command.

User Action: Enable tracing, retry the failed request, and check the trace file.

Lower layer addressing error

Explanation: An incorrect address was used for lower layers.

FTAM diagnostic identifier: 1012

User Action: Ask the system manager to verify and correct the addressing information specified for the remote system in the alias database file.

Lower layer failure

Explanation: Either an FTAM lower level or the transport service has indicated an error condition. The facility code of the error message indicates the location of the condition.

FTAM diagnostic identifier: 1011

User Action: For transport service messages, see the explanation for the message ID in the OpenVMS documentation.

FTAM Error Messages

H.1 Error Messages in Alphabetical Order

Mandatory parameter not set

Explanation: A required parameter was not set in one of the protocol data units.

FTAM diagnostic identifier: 1002

User Action: Enable tracing and retry the failed request. If you cannot find the problem, collect as much pertinent information as possible to identify the error message, describe the error and conditions preceding it, then contact your Digital support representative.

maximum string length may not exceed 7K

Explanation: The maximum string length cannot exceed the specified length using this command.

User Action: Reissue the command with a smaller maximum string length.

Missing alias argument on command line

Explanation: The listener did not find an alias argument on the command line.

User Action: Reissue the `ftam_listener` command with an alias argument using an alias found in the alias database file.

Missing FTAM access control action list parameter

Explanation: One or more of the copy security group parameters was specified but the name corresponding mandatory action-list parameter was not.

User Action: Enter command with action-list. Refer to copy reference page.

Missing p-address for alias '*alias*'

Explanation: The listener did not find a presentation-address for the specified alias.

User Action: Check the alias database file.

Missing value for mandatory CHOICE '*ASN.1-field-name*'

Explanation: The ASN.1 component did not find a value for the specified mandatory CHOICE field.

User Action: Enable tracing and retry the failed request. If you cannot find the problem, collect as much pertinent information as possible to identify the error message, describe the error and conditions preceding it, then contact your Digital support representative.

Missing value for mandatory parameter '*ASN.1-field-name*'

Explanation: The ASN.1 component did not find a value for the specified mandatory parameter.

User Action: Enable tracing and retry the failed request. If you cannot find the problem, collect as much pertinent information as possible to identify the error message, describe the error and conditions preceding it, then contact your Digital support representative.

FTAM Error Messages

H.1 Error Messages in Alphabetical Order

Missing value for mandatory parameter *param-name*

Explanation: No value was supplied for the named mandatory parameter.

FTAM diagnostic identifier: See `osif.h` for text that describes the named return code.

User Action: Check trace for more information.

Missing value for mandatory SET-OF/SEQUENCE-OF '*ASN.1-field-name*'

Explanation: The ASN.1 component did not find a value for the specified mandatory SET-OF/SEQUENCE-OF field.

User Action: Enable tracing and retry the failed request. If you cannot find the problem, collect as much pertinent information as possible to identify the error message, describe the error and conditions preceding it, then contact your Digital support representative.

More restrictive lock

Explanation: The initiator has been refused access to the file, probably due to the file's protection.

FTAM diagnostic identifier: 3011

User Action: Check the protection on the file, directory, and system that you are trying to access. If protection is the cause of the error, have the system manager or account owner change the incorrect protection.

No alias was specified on the command line

Explanation: The responder did not find an alias specified on the command line.

User Action: Reissue the command with an alias.

No digit string found in object sub-identifier '*object-identifier*'

Explanation: The ASN.1 component did not find a digit string in the specified object sub-identifier.

User Action: Object identifiers require numeric values. Check the AP-title and make sure it has the following form: { 1 22 333 }.

Non-existent file

Explanation: The file being selected does not exist.

FTAM diagnostic identifier: 3004

User Action: None.

No Reason

Explanation: A failure occurred for an unknown reason.

FTAM diagnostic identifier: 0

User Action: None.

No response was received for the *param-string* parameter from the remote system

Explanation: No response was received for the named parameter requested in either an F-READ-ATTRIBUTES request or the F-OPEN request FTAM protocol data unit (PDU).

FTAM diagnostic identifier:

User Action: Check trace for more information.

FTAM Error Messages

H.1 Error Messages in Alphabetical Order

No value found to encode/decode

Explanation: The ASN.1 component did not find a value to encode or decode.

User Action: Collect as much pertinent information as possible to identify the error message, describe the error and conditions preceding it, then contact your Digital support representative.

Operation inconsistent

Explanation: The requested operation violates the negotiation rules.

FTAM diagnostic identifier: 5017

User Action: None.

Operation not available

Explanation: The requested operation is unavailable.

FTAM diagnostic identifier: 5015

User Action: None.

Operation not supported

Explanation: The requested operation is unsupported.

FTAM diagnostic identifier: 5016

User Action: None.

Override not possible

Explanation: The create override parameter is not possible on remote systems.

FTAM diagnostic identifier: 3023

User Action: Check the protection for the remote file system.

Override recreated file with new attributes

Explanation: The create override parameter is not possible on remote systems.

FTAM diagnostic identifier: 3022

User Action: None.

Override recreated file with old attributes

Explanation: The create override parameter is not possible on remote systems.

FTAM diagnostic identifier: 3021

User Action: None.

Override selected existing file

Explanation: The file to be created already exists. Instead of creating a new file, the real filestore selected the existing file.

FTAM diagnostic identifier: 3020

User Action: None.

FTAM Error Messages

H.1 Error Messages in Alphabetical Order

protocol error on read

Explanation: A protocol error was encountered when trying to read a file.

User Action: Enable tracing, retry the failed request, and check the trace file.

protocol error on write

Explanation: A protocol error was encountered when trying to write a file.

User Action: Enable tracing, retry the failed request, and check the trace file.

Premature end of buffer found

Explanation: The ASN.1 component found a premature end of buffer.

User Action: Enable tracing, retry the failed request, and check the trace file.

Presentation — Abstract syntax not found

Explanation: The Presentation layer did not find the abstract syntax.

User Action: Enable tracing, retry the failed request, and check the trace file.

Presentation — Bad abstract syntax

Explanation: The Presentation layer found a bad abstract syntax.

User Action: Enable tracing, retry the failed request, and check the trace file.

Presentation — Error decoding PPDU

Explanation: The Presentation layer encountered an error decoding the presentation protocol data unit (PPDU).

User Action: Enable tracing, retry the failed request, and check the trace file.

Presentation — Error generating an ABORT event

Explanation: The Presentation layer encountered an error when generating an ABORT event.

User Action: Enable tracing, retry the failed request, and check the trace file.

Presentation — Invalid function

Explanation: The Presentation protocol machine does not recognize a presentation protocol data unit that it has received.

User Action: Collect as much pertinent information as possible to identify the error message, describe the error and conditions preceding it, then contact your Digital support representative.

Presentation — Invalid functional units

Explanation: The Presentation layer detected an invalid combination of negotiated functional units.

User Action: Enable tracing, retry the failed request, and check the trace file.

FTAM Error Messages

H.1 Error Messages in Alphabetical Order

Presentation — Transfer syntax not found

Explanation: The Presentation layer did not find a transfer syntax.

User Action: Enable tracing, retry the failed request, and check the trace file.

Presentation — Unsupported

Explanation: The presentation context restoration functional unit was requested. It is not supported.

User Action: Collect as much pertinent information as possible and notify the vendor of the remote FTAM application about the error message and describe the error and the conditions preceding it.

Previous FTAM legal qualification has been superseded

Explanation: The security group legal qualification parameter may only be entered once. Only the last occurrence of the legal qualification parameter in an ocp security group list will be accepted.

FTAM diagnostic identifier:

User Action: Only enter one occurrence of the security group legal qualification parameter per ocp command.

Processing mode inconsistent

Explanation: The requested processing mode violates the negotiation rules.

FTAM diagnostic identifier: 5023

User Action: None.

Processing mode not available

Explanation: The requested processing mode is unavailable.

FTAM diagnostic identifier: 5021

User Action: None.

Processing mode not supported

Explanation: The responder does not support the requested processing mode.

FTAM diagnostic identifier: 5022

User Action: None.

proposed protocol versions not supported

Explanation: Session refused the connection because the proposed protocol versions are not supported.

User Action: Enable tracing, retry the failed request, and check the trace file.

reason not specified

Explanation: Session refused the connection because of an unspecified reason.

User Action: Enable tracing, retry the failed request, and check the trace file.

FTAM Error Messages

H.1 Error Messages in Alphabetical Order

Recovery file could not be opened

Explanation: FTAM is unable to open the file containing the recovery related information.

User Action: Check that the recovery file exists and is readable.

Recovery not supported by peer

Explanation: The peer system does not support recovery.

User Action: None

Recovery mode inconsistent

Explanation: The recovery mode is inconsistent with the negotiated value.

FTAM diagnostic identifier: 6011

User Action: Enable tracing, retry the failed request, and check the trace file.

Recovery mode not available

Explanation: The proposed recovery mode is not supported.

FTAM diagnostic identifier: 6010

User Action: Enable tracing, retry the failed request, and check the trace file.

Recovery mode reduced

Explanation: The remote system has reduced recovery mode.

FTAM diagnostic identifier: 6012

User Action: None.

Recovery in progress

Explanation: An error has occurred during the transfer and FTAM is trying to recover from the error.

User Action: None.

rejection by called SS-user

Explanation: Session refused the connection because of a rejection by the called Session service user.

User Action: Enable tracing, retry the failed request, and check the trace file.

rejection by called SS-user due to temporary congestion

Explanation: Session refused the connection because of a rejection by the called Session service user due to temporary congestion.

User Action: Try again later.

Requested access violates permitted actions

Explanation: The requested access violates the negotiation rules for permitted actions.

FTAM diagnostic identifier: 3028

User Action: Collect as much pertinent information as possible to identify the error message, describe the error and conditions preceding it, then contact your Digital support representative.

FTAM Error Messages

H.1 Error Messages in Alphabetical Order

Requested length size (*number*) smaller than calculated size (*number*)

Explanation: The ASN.1 component found the specified requested length size to be smaller than the specified calculated size.

User Action: Enable tracing, retry the failed request, and check the trace file.

Responder error (unspecific)

Explanation: An unknown error occurred in the responder.

FTAM diagnostic identifier: 1

User Action: None.

Selection attributes not matched

Explanation: The file was not found; the requested file attributes do not match any existing file.

FTAM diagnostic identifier: 3001

User Action: Resubmit your request with the correct file attributes.

Session — Bad Protocol

Explanation: The Session layer received an abort (AB) SPDU, indicating that a protocol error has occurred (bit 3 of the transport disconnect field in the AB SPDU is set to one).

User Action: Enable tracing, retry the failed request, and check the trace file.

Session — Invalid connection block

Explanation: The Session layer received an event, but the Session Connect Block (SCB) is missing from the Session Parameter Block (SPB).

User Action: Collect as much pertinent information as possible to identify the error message, describe the error and conditions preceding it, then contact your Digital support representative.

Session — Invalid enclosure specified

Explanation: The Session layer detected an invalid specification of the enclosure field of the data (DT) SPDU.

User Action: Enable tracing, retry the failed request, and check the trace file. Since Session does not support segmenting, the enclosure field should not be present in the trace.

Session — Invalid function

Explanation: The Session layer has received an invalid SPDU event.

User Action: Collect as much pertinent information as possible to identify the error message, describe the error and conditions preceding it, then contact your Digital support representative.

Session — Invalid functional units

Explanation: The Session layer detected an invalid combination of negotiated functional units.

User Action: Enable tracing, retry the failed request, and check the trace file.

FTAM Error Messages

H.1 Error Messages in Alphabetical Order

Session — Invalid NSAP

Explanation: The Session layer detected an illegally constructed network service access point.

User Action: Enable tracing, retry the failed request, and check the trace file. Verify the format of the NSAP with the expected format described in your installation documentation. If the NSAP was part of an alias, make the appropriate corrections to the alias database file.

Session — Invalid parameter

Explanation: The Session layer received an SPDU with a field whose value is out of the expected range of valid values.

User Action: Enable tracing, retry the failed request, and check the trace file. Consult ISO 8327 for the valid range of values for the out-of-bounds field indicated in the trace.

Session — Invalid SSAP identifier

Explanation: The Session layer detected a discrepancy between the session service access point (SSAP) waiting for the connection (in the FTAM listener or responder) and the SSAP in the Session connect (CN) SPDU.

User Action: Enable tracing, retry the failed request, and check the trace file. Locate the discrepancy between the SSAP in CN SPDU and the SSAP used by the FTAM listener or responder. If the SSAP was part of an alias, make the appropriate corrections to the alias database file.

Session — Invalid sync point serial number

Explanation: The Session layer received an illegal sync point serial number. The value might be out of range or a serial number might have been proposed when the appropriate functional units were not set.

User Action: Enable tracing, retry the failed request, and check the trace file.

Session — Invalid token

Explanation: The Session layer detected the presence of an illegal set of tokens based on the negotiated functional units. Since the Session layer currently supports only the kernel functional unit, which does not require a token, the Session layer should never be in possession of any tokens.

User Action: Enable tracing, retry the failed request, and check the trace file.

Session — Missing sync point

Explanation: The Session layer received a connect (CN) or accept (AC) SPDU with a set functional units that requires a sync point serial number to be specified. Session, however, supports only the kernel functional unit, which does not require that a sync point serial number be specified.

User Action: Enable tracing, retry the failed request, and check the trace file. Check the functional units negotiated and include only the kernel functional unit.

FTAM Error Messages

H.1 Error Messages in Alphabetical Order

Session — Netnostate

Explanation: The Session layer received an SPDU whose Session Identifier code is not defined in ISO 8327.

User Action: Enable tracing, retry the failed request, and check the trace file.

Session — Proposed protocol versions not supported

Explanation: The Session layer received a refuse (RF) SPDU with a reason code that indicates that the proposed protocol versions are not supported.

User Action: Enable tracing, retry the failed request, and check the trace file. Only versions one and two are currently supported by the Session layer.

Session — Protocol Error

Explanation: The Session layer received an invalid SPDU event.

User Action: Collect as much pertinent information as possible to identify the error message, describe the error and conditions preceding it, then contact your Digital support representative.

Session — reason not specified

Explanation: The Session layer received a refuse (RF) SPDU with a reason code indicating that no reason was specified for the connection refusal.

User Action: Enable tracing, retry the failed request, and check the trace file.

Session — Rejection by called SS-user.

Explanation: The Session layer received a refuse (RF) SPDU with a reason code indicating that the rejection was initiated by the called session service-user.

User Action: Enable tracing, retry the failed request, and check the trace file.

Session — Rejection by called SS-user due to temporary congestion

Explanation: The Session layer received a refuse (RF) SPDU with a reason code indicating that the rejection was initiated by the called session service-user due to temporary congestion.

User Action: Retry request.

Session — SPM congestion at connect time

Explanation: The Session layer received a refuse (RF) SPDU with a reason code indicating that the rejection was due to SPM congestion at the time of request.

User Action: Retry request.

Session — SSAP identifier unknown

Explanation: The Session layer received a refuse (RF) SPDU with a reason code that indicates that the rejection was due to an unmatched session service access point (SSAP).

User Action: Enable tracing, retry the failed request, and check the trace file. Verify that the SSAP in CN SPDU matches the SSAP specified by the listener or responder entity.

FTAM Error Messages

H.1 Error Messages in Alphabetical Order

Session — SS-user not attached to SSAP

Explanation: The Session layer received a refuse (RF) SPDU with a reason code that indicates that the session service-user is not attached to the session service access point (SSAP).

User Action: Enable tracing, retry the failed request, and check the trace file.

Session — Unexpected reason code

Explanation: The Session layer received a refuse (RF) SPDU with a reason code that is not defined in ISO 8327.

User Action: Enable tracing, retry the failed request, and check the trace file.

Session — Unknown error

Explanation: The Session layer received an abort (AB) SPDU, indicating no reason was given for the abort (bit 4 of the transport disconnect field in the AB SPDU is set to one).

User Action: Enable tracing, retry the failed request, and check the trace file.

Session — Unsupported versions

Explanation: The Session layer received a connect (CN) SPDU or accept (AC) SPDU which specifies a protocol version that is not supported.

User Action: Enable tracing, retry the failed request, and check the trace file. Only versions one and two are currently supported by the Session layer.

Source bit offset of *number* too large by *number* bits

Explanation: The ASN.1 component found that the specified source bit offset was too large by the specified number of bits.

User Action: Enable tracing, retry the failed request, and check the trace file.

Specific PDU request inconsistent with current requested access

Explanation: The PDU request violates the negotiation rules for requested access.

FTAM diagnostic identifier: 1017

User Action: Enable tracing, retry the failed request, and check the trace file.

SPM congestion at connect time

Explanation: Session refused the connection because there was SPM congestion.

User Action: Try again later.

SSAP identifier unknown

Explanation: Session refused the connection because the session service access point (SSAP) identifier is unknown.

User Action: The listener is not listening on the specified SSAP. Reissue the request with the correct SSAP.

FTAM Error Messages

H.1 Error Messages in Alphabetical Order

SS-user not attached to SSAP

Explanation: Session refused the connection because the Session service user was not attached to the session service access point.

User Action: Check addressing information and retry the request.

Starting guard zone of block *address* has been modified
The block was created in *module-name* at line *line-number*

Explanation: FTAM found that the starting guard zone of the specified block had been modified. The block was created in the specified line of the specified module. CMN_DEALLOCATE was called from the specified line of the specified module.

User Action: Collect as much pertinent information as possible to identify the error message, describe the error and conditions preceding it, then contact your Digital support representative.

Subsequent error

Explanation: A previously encountered error condition caused a later error.

FTAM diagnostic identifier: 8

User Action: None.

Superuser privileges are required to run this command.

Explanation: The listener requires superuser privileges to run this command.

User Action: Run this command as root.

System shutdown

Explanation: One of the FTAM systems has shut down.

FTAM diagnostic identifier: 2 or 1014

User Action: Reboot the system or contact the system manager.

Tag value too long

Explanation: The ASN.1 component found the tag value to be too long.

User Action: Enable tracing, retry the failed request, and check the trace file.

Temporal insufficiency of resources

Explanation: Resources are temporarily insufficient.

FTAM diagnostic identifier: 9

User Action: Try again later.

The file does not consist of an even number of fixed records.
Do you want to pad the file?

Explanation: FTAM found a file that does not consist of an even number of fixed records.

User Action: Answer yes or no.

FTAM Error Messages

H.1 Error Messages in Alphabetical Order

The value passed in the direction parameter was not among the list of valid values.

Direction value *number* is invalid, range is *number* — *number*

Explanation: The tracing utility found an invalid value passed in the direction parameter.

User Action: Collect as much pertinent information as possible to identify the error message, describe the error and conditions preceding it, then contact your Digital support representative.

The value passed in the layer parameter was not among the list of valid values.

Layer value *number* is invalid, range is *number* — *number*

Explanation: The tracing utility found an invalid value passed in the layer parameter.

User Action: Collect as much pertinent information as possible to identify the error message, describe the error and conditions preceding it, then contact your Digital support representative.

The *string* document type is not supported

Explanation: The specified document type is not supported by the peer implementation.

User Action: None.

Timeout

Explanation: One of the timers ran out.

FTAM diagnostic identifier: 1013

User Action: None.

Too many aliases specified

Explanation: The listener found too many aliases being specified.

User Action: Use only one alias for the listener.

Too many command line arguments

Explanation: The responder found too many command line arguments.

User Action: Reissue the command with the correct number of arguments.

Too many queue lengths specified

Explanation: The listener found too many queue lengths being specified.

User Action: Reissue the command with only one queue length argument.

Too many responder names specified

Explanation: The listener found too many responder names being specified.

User Action: Reissue the command with only one responder name.

Too many unused bits (*number* specified, 7 maximum)

Explanation: The ASN.1 component found too many unused bits.

User Action: Enable tracing, retry the failed request, and check the trace file.

FTAM Error Messages

H.1 Error Messages in Alphabetical Order

Tried to copy more bytes from the PDU than were left

Explanation: The ASN.1 decoder could not decode the protocol data unit.

User Action: Enable tracing, retry the failed request, and check the trace file.

unable to append to destination file - document type of source file is *string* and destination file is *string*

Explanation: Both source and destination files must be of the same document type in order to append one to another.

User Action: Convert the source file to be the same document type as the destination file, and re-enter the copy command.

Unable to open recovery file

Explanation: FTAM is unable to find the file containing the recovery related information.

User Action: Check that the recovery file exists and is readable.

unable to open source file as *string* - document type of source file is *string*

Explanation: Document type of source file does not match the document type specified by the user on the command line.

User Action: Don't specify a document type on the command line. The copy utility determines which document type the source file will be opened as.

unable to open source file as XXXX - maximum string length XXXX of source file is XXXX

Explanation: The actual maximum string length of source file does not match the maximum string length specified by the user on the command line.

User Action: Don't specify a maximum string length on the command line. The copy utility determines which maximum string length the source file should be opened as.

unable to open source file as XXXX - string significance XXXX of source file is XXXX

Explanation: The actual string significance of source file does not match the string significance specified by the user on the command line.

User Action: Don't specify a string significance on the command line. The ocp utility determines which string significance the source file should be opened as.

unable to open source file as XXXX - universal class number XXXX of source file is XXXX

Explanation: The actual universal class of source file does not match the universal class specified by the user on the command line.

User Action: Don't specify a universal class on the command line. The ocp utility determines which universal class the source file should be opened as.

unexpected-ppdu

Explanation: Presentation found an unexpected presentation protocol data unit (PPDU).

User Action: Enable tracing, retry the failed request, and check the trace file.

FTAM Error Messages

H.1 Error Messages in Alphabetical Order

unexpected-ppdu-parameter

Explanation: Presentation found an unexpected presentation protocol data unit (PPDU) parameter.

User Action: Enable tracing, retry the failed request, and check the trace file.

unexpected-session-service-primitive

Explanation: Session found an unexpected Session service primitive.

User Action: Enable tracing, retry the failed request, and check the trace file.

Unexpected API response received

Explanation: The initiator received an unexpected API response.

User Action: None.

Unexpected close error

system-error-message

Explanation: The responder found an unexpected close error. A system error message is displayed also.

User Action: None.

Unexpected command line option: *option-name*

Explanation: The responder found the unexpected command line option specified.

User Action: Check the command line option.

Unexpected document type *document-type-name*

Explanation: The initiator found the unexpected document type specified.

User Action: Check the specified document type.

Unexpected errno value

Explanation: The responder found an unexpected errno value.

User Action: None.

Unexpected error creating file

system-error-message

Explanation: The responder found an unexpected error while creating the specified file. A system error message is displayed also.

User Action: None.

Unexpected error opening file

system-error-message

Explanation: The responder found an unexpected error while opening the specified file. A system error message is displayed also.

User Action: None.

Unexpected override parameter value: *number*

Explanation: The responder found the unexpected override parameter value specified.

User Action: Check the override parameter value.

FTAM Error Messages

H.1 Error Messages in Alphabetical Order

Unexpected override parameter value: create-failure

Explanation: The responder found the unexpected override parameter value of create-failure.

User Action: None.

Unexpected read error

system-error-message

Explanation: The responder found the unexpected read error specified. A system error message is displayed also.

User Action: None.

Unexpected string significance of *number* for document type *document-type-name*

Explanation: The initiator found the unexpected string significance specified for the specified document type.

User Action: Check the string significance value.

Unexpected tag value '*number*'

Explanation: The ASN.1 component found the unexpected tag value specified.

User Action: Enable tracing, retry the failed request, and check the trace file.

universal class number specification with FTAM-3 files is not allowed

Explanation: A universal class number specification is not allowed with FTAM-3 files.

User Action: Reissue the command without the -C option.

Unknown alias '*alias*'

Explanation: The listener did not know the specified alias.

User Action: Check the alias database file.

Unknown ASN.1 universal class number *number*

Explanation: The ASN.1 component did not know the specified ASN.1 universal class number.

User Action: Enable tracing, retry the failed request, and check the trace file.

Unknown diagnostic (diagnostic id=*number*, local error id=*number*)

Explanation: The responder did not know the specified diagnostic and its local error ID.

User Action: Collect as much pertinent information as possible to identify the error message, describe the error and conditions preceding it, then contact your Digital support representative.

Unknown service class *number*

Explanation: The responder did not know the specified service class.

User Action: Enable tracing, retry the failed request, and check the trace file.

FTAM Error Messages

H.1 Error Messages in Alphabetical Order

Unknown state machine event (*number*)

Explanation: FTAM did not know the specified state machine event.

User Action: Enable tracing, retry the failed request, and check the trace file.

unrecognized-ppdu

Explanation: Presentation did not recognize the presentation protocol data unit (PPDU).

User Action: Enable tracing, retry the failed request, and check the trace file.

unrecognized-ppdu-parameter

Explanation: Presentation did not recognize the presentation protocol data unit (PPDU) parameter.

User Action: Enable tracing, retry the failed request, and check the trace file.

Unsupported Document Type Parameters

Explanation: The initiator found unsupported document type parameters.

User Action: Enable tracing, retry the failed request, and check the trace file.

Unsupported functional unit

Explanation: The responder does not support a requested functional unit.

FTAM diagnostic identifier: 2003

User Action: None.

Unsupported parameter

Explanation: An unsupported parameter was encountered.

FTAM diagnostic identifier: 1003

User Action: Enable tracing, retry the failed request, and check the trace file.

Unsupported parameter types

Explanation: A parameter type in a call to the file service is not supported.

FTAM diagnostic identifier: 1006

User Action: None.

Unsupported parameter values

Explanation: An unsupported parameter was encountered.

FTAM diagnostic identifier: 1001

User Action: Enable tracing, retry the failed request, and check the trace file.

Unsupported service class

Explanation: The responder does not support the requested service class.

FTAM diagnostic identifier: 2002

User Action: None.

FTAM Error Messages

H.1 Error Messages in Alphabetical Order

Usage: ftam_listener [-q queue-length] [-r responder] AE-title

Explanation: You did not specify the command syntax correctly.

User Action: Use the command as shown.

User data queue unexpectedly empty

Explanation: The ASN.1 component found the user data queue to be unexpectedly empty.

User Action: Enable tracing, retry the failed request, and check the trace file.

Zero length filename

Explanation: The initiator found a file name of zero length.

User Action: Specify a file name after the pair of colons (::).

H.2 Error Messages in Numerical Order

This section lists the FTAM error messages in numerical order, according to the message's FTAM Diagnostic Identifier. See Section H.1 for message descriptions and user actions.

FTAM Diagnostic Identifier	Message Text
0	No Reason
1	Responder error (unspecific)
2	System shutdown
3	FTAM management problem (unspecific)
4	FTAM management, bad account
5	FTAM management, security not passed
6	Delay may be encountered
7	Initiator error (unspecific)
8	Subsequent error
9	Temporal insufficiency of resources
10	Access request violates VFS security
11	Access request violates local security
1000	Conflicting parameter values
1001	Unsupported parameter values
1002	Mandatory parameter not set
1003	Unsupported parameter
1004	Duplicated parameter
1005	Illegal parameter type
1006	Unsupported parameter types
1007	FTAM protocol error (unspecific)
1008	FTAM protocol error, procedure error
1009	FTAM protocol error, functional unit error

FTAM Error Messages H.2 Error Messages in Numerical Order

FTAM Diagnostic Identifier	Message Text
1010	FTAM protocol error, corruption error
1011	Lower layer failure
1012	Lower layer addressing error
1013	Timeout
1014	System shutdown
1015	Illegal grouping sequence
1016	Grouping threshold violation
1017	Specific PDU request inconsistent with current requested access
2000	Association with user not allowed
2002	Unsupported service class
2003	Unsupported functional unit
2004	Attribute group error (unspecific)
2005	Attribute group not supported
2006	Attribute group not allowed
2007	Bad account
2008	Association management (unspecific)
2009	Association management — bad address
2010	Association management — bad account
2011	Checkpoint window error — too large
2012	Checkpoint window error — too small
2013	Checkpoint window error — unsupported
2014	Communications QoS not supported
2015	Initiator identity unacceptable
2016	Context management refused
2018	Contents type list cut by responder
2019	Contents type list cut by initiator
2020	Invalid filestore password
2021	Incompatible service classes
3000	Filename not found
3001	Selection attributes not matched
3002	Initial attributes not possible
3003	Bad attribute name
3004	Non-existent file
3005	File already exists
3006	File cannot be created
3007	File cannot be deleted
3008	Concurrency control not available
3009	Concurrency control not supported
3010	Concurrency control not possible

FTAM Error Messages

H.2 Error Messages in Numerical Order

FTAM Diagnostic Identifier	Message Text
3011	More restrictive lock
3012	File busy
3013	File not available
3014	Access control not available
3015	Access control not supported
3016	Access control inconsistent
3017	Filename truncated
3018	Initial attributes altered
3019	Bad account
3020	Override selected existing file
3021	Override recreated file with old attributes
3022	Override recreated file with new attributes
3023	Override not possible
3024	Ambiguous file specification
3025	Invalid create password
3026	Invalid delete password on override
3027	Bad attribute value
3028	Requested access violates permitted actions
3029	Functional unit not available for requested access
3030	File created but not selected
4000	Attribute non-existent
4001	Attribute cannot be read
4002	Attribute cannot be changed
4003	Attribute not supported
4004	Bad attribute name
4005	Bad attribute value
5000	Bad FADU (unspecific)
5001	Bad FADU — size error
5002	Bad FADU — type error
5003	Bad FADU — poorly specified
5004	Bad FADU — bad location
5005	FADU does not exist
5006	FADU not available (unspecific)
5007	FADU not available for reading
5008	FADU not available for writing
5009	FADU not available for location
5010	FADU not available for erasure
5011	FADU cannot be inserted
5012	FADU cannot be replaced

FTAM Error Messages H.2 Error Messages in Numerical Order

FTAM Diagnostic Identifier	Message Text
5013	FADU cannot be located
5014	Bad data element type
5015	Operation not available
5016	Operation not supported
5017	Operation inconsistent
5018	Concurrency control not available
5019	Concurrency control not supported
5020	Concurrency control inconsistent
5021	Processing mode not available
5022	Processing mode not supported
5023	Processing mode inconsistent
5024	Access context not available

FTAM Error Messages

H.2 Error Messages in Numerical Order

FTAM Diagnostic Identifier	Message Text
5025	Access context not supported
5026	Bad write (unspecific)
5027	Bad read (unspecific)
5028	Local failure (unspecific)
5029	Local failure — filespace exhausted
5030	Local failure — data corrupted
5031	Local failure — device failure
5032	Future filesize exceeded
5034	Future filesize increased
5035	Functional unit invalid in processing mode
5036	Contents type inconsistent
5037	Contents type simplified
5038	Duplicate FADU name
5039	Damage to select/open regime
5040	FADU locking not available on file
6000	Bad checkpoint (unspecific)
6001	Activity not unique
6002	Checkpoint outside of window
6003	Activity no longer exists
6004	Activity not recognized
6006	Corrupt docket
6007	File waiting restart
6008	Bad recovery point
6010	Recovery mode not available
6011	Recovery mode inconsistent
6012	Recovery mode reduced
6013	Access control not available
6014	Access control not supported
6015	Access control inconsistent
6016	Contents type inconsistent
6017	Contents type simplified

Virtual Terminal Error Messages

This appendix describes specific error messages and possible actions to take in response to these messages. The messages are listed here in alphabetical order under the four types of severity. Messages are displayed in the following format:

```
%VT-L-IDENT, message-text
```

where

- VT is the facility.
- L is the severity of the error:
 - S - success
 - I - informational
 - E - error
 - W - warning
- IDENT is a symbol that represents the message.
- message-text explains the cause of the message.

In addition, you may also see messages with the facility code of OSAK or SYSTEM. These messages usually further clarify the Virtual Terminal error messages.

For a description of errors from the OSAK facility, refer to the OSAK documentation.

In the case of errors that use the SYSTEM facility, they may be generated by OSI Transport, Digital TCP/IP Services for OpenVMS, LAT, or OpenVMS, or other software. If the SYSTEM error is associated with:

- OSAK — refer to the OSAK documentation.
- TELNET — refer to *Digital TCP/IP for OpenVMS Management*.
- LAT — refer to the *OpenVMS I/O Drivers Reference Manual*.
- OTHER — refer to the *OpenVMS System Messages Manual*.

Note

In the following list, many of the messages indicate that they are not normally displayed. If such a message is found, you may contact your Digital Support representative for assistance. Also, many of the **User Action** lines suggest initiating a trace. Refer to your problem solving documentation for more information on generating trace files.

Virtual Terminal Error Messages

Success Messages

END, control returned to local node

Explanation: Indicates that the VT association has been terminated normally and control returned to local end system.

User Action: None

NORMAL, normal successful completion

Explanation: Not normally displayed; indicates that the operation completed normally.

User Action: None

STALLED, operation stalled

Explanation: Not normally displayed; indicates an internal function has been temporarily stalled.

User Action: Submit an SPR.

Information Messages

ABORTREASON, reason for abort: (text)

Explanation: The VT association was aborted by the peer and textual information about the abort was provided.

User Action: In general, the text should be self-explanatory. If the peer was an OpenVMS or a Digital UNIX system, the following discusses the various text and reasons. If the peer is from another vendor, you may need to contact that vendor for additional information. The text may indicate that an unexpected situation was encountered, in which case you should initiate a trace to attempt to gather more information leading up to the event.

- Normal termination initiated by responder

Message indicates that association was terminated by the peer as a result of the user logging out. Because of a discrepancy between ISO 9040 and 9041, it is not possible for a responder to use the normal release mechanism to terminate an association. This message is normal and may be ignored.

- Protocol error detected

A VTP protocol error was detected and the peer aborted the association. Additional information may be provided in the message indicating what type of VTP protocol data unit (PDU) was being processed. A trace is needed for full analysis of the problem.

INCHARMODE, already in character mode

Explanation: While using the Generalized Telnet or Telnet-1988 profile, the user issued a mode char command when already in character mode.

User Action: None

INDEFINITE, indefinite length encoding

Explanation: Not normally displayed; indicates a length indicator was encountered, which specified indefinite form length encoding.

User Action: None

Virtual Terminal Error Messages

INLINEMODE, already in line mode

Explanation: While using the Generalized Telnet or Telnet-1988 profile, the user issued a mode line command when already in line mode.

User Action: None

LONG, long length encoding

Explanation: Not normally displayed; indicates a length indicator was encountered which specified long form length encoding.

User Action: None

NOABORTREASON, no abort reason specified

Explanation: The VT association was aborted by the peer and a reason for the abort was not specified.

User Action: If this message is displayed when logging out of a remote system, it may be considered a normal event and ignored. If the message is displayed during an association, first determine if the event is reproducible. If the event can be reproduced, a trace should be initiated to help determine why the peer aborted the association.

NOEVENT, no event was detected

Explanation: Not normally displayed; indicates that an internal VT request completed, but insufficient information was available to process a complete event.

User Action: None

PADEXIT, exiting PAD

Explanation: Displayed when leaving the VT command prompt (VT_PAD> on OpenVMS, ologin> on Digital UNIX).

User Action: None

SHORT, short length encoding

Explanation: Not normally displayed; indicates a length indicator was encountered which specified short form length encoding.

User Action: None

Error Messages

ABOPT, Ambiguous command option - supply more characters

Explanation: You typed an argument to a VT command that was too short to be unique.

User Action: Re-enter the command, using more characters for the option.

ABVERB, Ambiguous command verb - supply more characters

Explanation: You typed a VT command that was too short to be unique.

User Action: Re-enter the command, using more characters for the command.

Virtual Terminal Error Messages

ASQERR, error encoding/decoding ASQ

Explanation: An error was encountered in the encoding or decoding operation related to the specified VTP protocol data unit.

User Action: Initiate a trace to gather additional information leading up to the event.

ASRERR, error encoding/decoding ASR

Explanation: An error was encountered in the encoding or decoding operation related to the specified VTP protocol data unit.

User Action: Initiate a trace to gather additional information leading up to the event.

AUQERR, error encoding/decoding AUQ

Explanation: An error was encountered in the encoding or decoding operation related to the specified VTP protocol data unit.

User Action: Initiate a trace to gather additional information leading up to the event.

BADGETTYENT, Bad gettytab entry

Explanation: An attempt to parse an entry from /etc/gettydefs (on Digital UNIX) failed.

User Action: Have your system manager examine the file's first entry for correct formatting.

BADPARAM, bad parameter value

Explanation: Not normally displayed; indicates a parameter value used by an internal VT routine was incorrect.

User Action: None

CHRINUSE, character already in use

Explanation: An attempt was made to set the break, disconnect, or command character to a character already being used as a special character (e.g., trying to set the break character to be CTRL/\ when the disconnect character already has this value).

User Action: Re-enter the set command with another value.

CHRNOTALLOWED, character specified not from allowed set

Explanation: An attempt was made to set the break, disconnect, or command character to a character already being used as a special character (e.g., trying to set the break character to be CTRL/\ when the disconnect character already has this value).

User Action: Re-enter the set command with another value.

COUPDATEMISMATCH, CO update category mismatch

Explanation: Not normally displayed; indicates that a CO update was requested, but the CO specified was not of the same category as the update expected. This can be a result of a protocol error.

User Action: Initiate a trace to gather additional information leading up to the event.

CREATEERR, create error

Explanation: Not normally displayed; an error was encountered when creating a Display object, Control object, or Device object.

User Action: None

DAQERR, error encoding/decoding DAQ

Explanation: An error was encountered in the encoding or decoding operation related to the specified VTP protocol data unit.

User Action: Initiate a trace to gather additional information leading up to the event.

DLQERR, error encoding/decoding DLQ

Explanation: An error was encountered in the encoding or decoding operation related to the specified VTP protocol data unit.

User Action: Initiate a trace to gather additional information leading up to the event.

EMPTYDATA, attempt to send empty P-DATA

Explanation: Not normally displayed; indicates that the VT software attempted to send a P-DATA with nothing in it; probably a result of a state machine error.

User Action: Initiate a state machine trace to gather additional information leading up to the event.

ENVERR, environment error

Explanation: An error occurred when trying to read or write information from or to the terminal (in the initiator) or the pseudo-terminal (in the responder) or the gateway code (in any of the gateways).

User Action: See further messages for more information.

ERRCALSYS, Error calling system service *service*

Explanation: An error occurred when VT tried to call the named system service.

User Action: See further messages for more information.

ERRSTAGWY, Error starting gateway

Explanation: When VT attempted to start the gateway software an error was encountered.

User Action: See further messages for more information.

EXPAPPL1TAG, expected [APPLICATION 1] tag

Explanation: Indicates that a protocol error was encountered; the VT decoder expected an APPLICATION 1 tag and did not encounter it.

User Action: Initiate a trace to gather additional information leading up to the event.

EXPAPPL30TAG, expected [APPLICATION 30] tag

Explanation: Indicates that a protocol error was encountered; the VT decoder expected an APPLICATION 30 tag and did not encounter it.

User Action: Initiate a trace to gather additional information leading up to the event.

Virtual Terminal Error Messages

EXPBITSTRINGTAG, expected BITSTRING tag

Explanation: Indicates that a protocol error was encountered; the VT decoder expected a BITSTRING tag and did not encounter it.

User Action: Initiate a trace to gather additional information leading up to the event.

EXPBOOLEANTAG, expected BOOLEAN tag

Explanation: Indicates that a protocol error was encountered; the VT decoder expected a BOOLEAN tag and did not encounter it.

User Action: Initiate a trace to gather additional information leading up to the event.

EXPGRAPHICSTRINGTAG, expected GRAPHICSTRING tag

Explanation: Indicates that a protocol error was encountered; the VT decoder expected a GRAPHICSTRING tag and did not encounter it.

User Action: Initiate a trace to gather additional information leading up to the event.

EXPINTEGERTAG, expected an INTEGER tag

Explanation: In decoding a VTP protocol data unit, the VT decoder expected an INTEGER tag and did not encounter it.

User Action: Initiate a trace to gather additional information leading up to the event.

EXPNULL, expected a NULL

Explanation: Indicates that a protocol error was encountered; the VT decoder expected a NULL encoding and did not encounter it.

User Action: Initiate a trace to gather additional information leading up to the event.

EXPNULLTAG, expected NULL tag

Explanation: Indicates that a protocol error was encountered; the VT decoder expected a NULL tag and did not encounter it.

User Action: Initiate a trace to gather additional information leading up to the event.

EXPONENTSTRINGTAG, expected OCTETSTRING tag

Explanation: Indicates that a protocol error was encountered; the VT decoder expected an OCTETSTRING tag and did not encounter it.

User Action: Initiate a trace to gather additional information leading up to the event.

EXPOIDTAG, expected OID tag

Explanation: Indicates that a protocol error was encountered; the VT decoder expected an OBJECT IDENTIFIER tag and did not encounter it.

User Action: Initiate a trace to gather additional information leading up to the event.

EXPPRINTABLESTRINGTAG, expected PRINTABLESTRING tag

Explanation: Indicates that a protocol error was encountered; the VT decoder expected a PRINTABLESTRING tag and did not encounter it.

User Action: Initiate a trace to gather additional information leading up to the event.

GETENTLON, Geetytab entry too long

Explanation: An attempt to look at the /etc/gettydefs on a Digital UNIX system resulted in reading an entry that was too long for the VT software to handle.

User Action: Have your system administrator look at the first entry in the file appropriate to your operating system.

GTQERR, error encoding/decoding GTQ

Explanation: An error was encountered in the encoding or decoding operation related to the specified VTP protocol data unit.

User Action: Initiate a trace to gather additional information leading up to the event.

HELPFILERR, Could not open help file

Explanation: The VT Help file could not be opened. Either the file does not exist, or the protections on the file do not allow it to be accessed.

User Action: On OpenVMS, verify the existence of the file in sys\$help:vt.hlb and check that it allows W:RE (world read and execute) access. On Digital UNIX systems, verify the existence of the file in /usr/lib and check that it allows world read access.

INFINTC, Getty: infinite tc= loop

Explanation: The /etc/gettydefs on your Digital UNIX system has circular table continuation references.

User Action: Have your system administrator look at the first entry in the file appropriate to your operating system.

INSDECSPC, insufficient decoding space

Explanation: Not normally displayed; indicates a protocol data unit (PDU) received from the peer could not be decoded properly, possibly as a result of a protocol error.

User Action: A trace should be initiated to gather additional information.

INSENCSPC, insufficient encoding space

Explanation: Not normally displayed; indicates that the VT software attempted to encode a protocol data unit (PDU) and did not have sufficient space.

User Action: If this happens during an association attempt, it could indicate that a corrupt application entity (AE) title has been supplied (check the alias), or that identification information is too long (check the logical VT\$IMPLIDENT in the VT\$NAMES logical name table).

Virtual Terminal Error Messages

INSPWS, insufficient port workspace

Explanation: Not normally displayed; indicates that insufficient workspace existed for a port-related operation. This may be the result of an undetected protocol error.

User Action: Initiate a trace to gather additional information leading up to the event.

INSWS, insufficient workspace

Explanation: Not normally displayed; indicates that insufficient workspace existed for the processing of a protocol data unit. This may be the result of an undetected protocol error.

User Action: Initiate a trace to gather additional information leading up to the event.

INSVIRMEM, insufficient virtual memory

Explanation: Indicates that insufficient virtual memory was available for dynamic allocation. In some cases, this error can be caused by an undetected protocol error.

User Action: Increase the process PGFLQUO (pagefile quota) via AUTHORIZE, or the system VIRTUALPAGECNT via SYSGEN, as needed. If the error is still reported, initiate a trace to determine if an undetected protocol error is being encountered.

INTEGERTOOLONG, INTEGER encoded in too many octets

Explanation: The encoded integer is longer than 32 bits. This may be a result of a protocol error.

User Action: Initiate a trace to gather additional information leading up to the event.

INVALIAS, invalid alias information

Explanation: Either an alias was not provided, or the provided alias did not exist.

User Action: For the responder and gateways, check that the proper local alias has been created. For the initiator, verify that the alias specified has been created.

INVARGNUM, Invalid number of arguments for command

Explanation: Too few or too many arguments were supplied for the requested command.

User Action: Re-enter the command with the appropriate number of arguments.

INVCHRNOTINREP, invalid character; not in repertoire

Explanation: An attempt was made to issue the User Command Interface SEND command which specified a character that is not allowed in the current repertoire.

User Action: Verify that the character being sent (COMMAND, BREAK, DISCONNECT) is in the repertoire currently in use for the specified profile. If appropriate for the profile (i.e., Telnet-1988 or Generalized Telnet), request that the repertoire be changed so that the character may be transmitted.

Virtual Terminal Error Messages

INVCOCATAGORY, invalid CO category

Explanation: Not normally displayed; indicates the control object specified an invalid category.

User Action: None

INVFORPROFILE, invalid request for the profile currently in use

Explanation: An attempt was made to execute a User Command Interface command which is not appropriate for the profile currently in use; for example, the user attempted a send ao (only appropriate for Telnet-1988 or Generalized Telnet) and the profile in use was Transparent.

User Action: Terminate the current association and establish a new association using the appropriate profile.

INVHOSTNAME, invalid host name

Explanation: When using the TELNET gateway, VT was unable to use the the host name given by the user.

User Action: Verify that the TELNET host name typed in at the gateway prompt is correct, and actually exists in the Digital TCP/IP Services for OpenVMS remote host database.

INVIMPLIDENT, invalid implementation identification

Explanation: Not normally displayed; an implementation identification specified via the logical VT\$IMPLIDENT was considered invalid.

User Action: Check that the logical name is properly defined.

INVLENENCODING, invalid length encoding

Explanation: Indicates that the VT decoder encountered a length that was longer the 32 bits; usually cause by a protocol error.

User Action: Initiate a trace to gather additional information leading up to the event.

INVMODEOPT, invalid mode option, use: LINE or CHARACTER

Explanation: The option of the mode command is unrecognized.

User Action: Re-enter the command with a valid option.

INVOFFEREDVALUE, invalid offered value type

Explanation: Indicates that a profile argument offer was invalid. This may be a result of a protocol error.

User Action: Initiate a trace to gather additional information leading up to the event.

INVOPTION, Invalid option -option-character

Explanation: An invalid option was entered for the ologin command (Digital UNIX).

Explanation: Re-enter the command with valid options.

Virtual Terminal Error Messages

INVPADCMD, invalid PAD command: unknown or ambiguous

Explanation: A command was entered at the VT_PAD> (OpenVMS) or ologin (Digital UNIX) prompt. The command was either unrecognized, or too short to be unambiguous.

User Action: Re-enter the command with either a valid command or a longer keyword.

INVPORTTYPE, invalid port type specified

Explanation: Not normally displayed; an internal VT operation specified a request that was either not valid for the particular port, or the port itself was no longer valid.

User Action: None

INVREQ, invalid request

Explanation: Not normally displayed; indicates that an unexpected internal operation was requested, which could not be satisfied.

User Action: None

INVRESULT, invalid result code

Explanation: A VTP result code encoding was not valid. This error is usually due to a protocol error.

User Action: Initiate a trace to gather additional information leading up to the event.

INVSENOPT, invalid SEND option

Explanation: The option specified in a send command is not recognized.

User Action: Re-enter the command with a valid send option. Enter send ? to see a list of valid options.

INVSETOPT, invalid SET option. user: SET {break | escape | command}

Explanation: The option specified in a set command is not recognized.

User Action: Re-enter the command with a valid set option. Enter set ? to see a list of valid options.

INVSHOWOPT, invalid SHOW option

Explanation: The option specified in a show command is not recognized.

User Action: Re-enter the command with a valid show option. Enter show ? to see a list of valid options.

INVTGGLEOPT, invalid TOGGLE option, use BINARY or INBINARY or OUTBINARY

Explanation: The option specified in a toggle command is not recognized.

User Action: Re-enter the command with a valid toggle option. Enter toggle ? to see a list of valid options.

INVUNSET, Invalid UNSET option

Explanation: The option specified in an unset command is not recognized.

User Action: Re-enter the command with a valid unset option. Enter unset ? to see a list of valid options.

INVVALUE, The specified value is invalid

Explanation: A value specified in a User Command Interface command is not valid.

User Action: Specify a valid value.

INVVALUEVALUE, invalid value value type

Explanation: Not normally displayed; indicates that a value specified for a value type is invalid.

User Action: None

INVVTCLASS, invalid VT class

Explanation: Not normally displayed; indicates a VTP class was requested, which the VT software does not support.

User Action: Verify the requested profile.

INVVTFUNCUNITS, invalid functional units

Explanation: Not normally displayed; indicates VTP functional units were requested, which the VT software does not support.

User Action: Verify the requested profile.

INVVTPROFILE, invalid VT profile

Explanation: Not normally displayed; a profile was requested, which the VT software does not support.

User Action: Verify that the `set host/vtp/profile=` command specifies a supported profile.

INVVTVERSION, invalid VT version

Explanation: Not normally displayed; a VTP protocol version was specified which the VT software does not support.

User Action: Verify the requested profile.

IVOPT, Invalid command option - check validity and spelling

Explanation: A User Command Interface command option specified was invalid.

User Action: Supply a valid command option.

LITOOOLONG, LI longer than PDU

Explanation: Indicates a protocol error was encountered, and that the length encoding is not valid, since it specifies a value that is larger than the length of the protocol data unit (PDU).

User Action: Initiate a trace to gather additional information leading up to the event.

MISSINGEOC, missing EOC

Explanation: Indicates a protocol error was encountered, and that the EOCs that were expected to terminate an indefinite length encoding were not found.

User Action: Initiate a trace to gather additional information leading up to the event.

Virtual Terminal Error Messages

MSGCAT_OPENERR, The message catalog could not be opened

Explanation: An error occurred when trying to open the error message catalog on Digital UNIX.

User Action: Have your system administrator check to ensure that the VT message catalog has been placed in the proper directory and has the correct protection code.

MUSTBEONECHR, only one character allowed

Explanation: When setting a character such as the command/escape character, only one character may be entered. An attempt was made to use more than one character when setting a special character.

User Action: Re-enter the command using only one character or the circumflex-character notation (e.g., ^B) to specify a control character.

NDQERR, error encoding/decoding NDQ

Explanation: An error was encountered in the encoding or decoding operation related to the specified VTP protocol data unit.

User Action: Initiate a trace to gather additional information leading up to the event.

NOALIAS, No alias given on command line

Explanation: The Digital UNIX `ologin` command did not have an alias specified as the first argument.

User Action: Re-enter the command with an alias.

NOERROR, Call returned without an error

Explanation: When starting up a Digital UNIX gateway, the `exec` system call returned without an error. This call should not return at all.

User Action: Contact your Digital support representative for assistance and describe the events causing the message.

NOGATEWAY, Gateway access is unavailable

Explanation: An attempt was made to start one of the VT gateways, but the gateway software was not installed.

User Action: Ask your system administrator to install the gateway software.

NOPARAM, required parameter value absent

Explanation: Not normally displayed; indicates a parameter value required by an internal VT routine was missing.

User Action: None

NOSTATECHG, no state change

Explanation: Not normally displayed; indicates that the internal VT state machine did not execute a state transition as expected.

User Action: Initiate a state machine trace to gather additional information leading up to the event.

NOSUCHCO, no such control object

Explanation: Not normally displayed. A COupdate requested a control object that does not exist. This may be the result of a protocol error.

User Action: Initiate a trace to gather additional information leading up to the event.

NOSUCHDO, no such display object

Explanation: Not normally displayed. A DOupdate requested a display object that does not exist. This may be a result of a protocol error.

User Action: Initiate a trace to gather additional information leading up to the event.

OPSYSERR, undefined operating system error

Explanation: An operating-system-specific error was encountered. Additional error text should be supplied that further defines the error.

User Action: None

OSAKERR, OSAK error encountered

Explanation: An error was encountered by OSAK; examine the OSAK error code for additional information.

User Action: None

OSK_SLCT_DSRPTD, A disruptive event has occurred during call to osak_select

Explanation: This is an internal error that should not normally be encountered.

User Action: Call your local support center.

OSK_SLCT_TRANSERR, Error in transport provider found during call to osak_select

Explanation: This is an internal error that should not normally be encountered.

User Action: Call your local support center.

PABIND, supporting services abort indication received

Explanation: A lower layer abort caused the VT association to terminate abnormally. Additional error text may indicate more information about the abort.

User Action: This may be a normal way for some vendors' implementations to terminate an association when the user requests the association be terminated. If a request was not made to end the association, then a trace should be performed, and your local support center contacted for assistance.

PDATAERR, internal p-data error

Explanation: Not normally seen; indicates an internal error was encountered when starting or finishing a P-DATA.

User Action: None

Virtual Terminal Error Messages

PNS, profile not supported

Explanation: Not normally displayed; the profile specified is not supported by the VT software.

User Action: Check the requested profile.

PORTERR, error initializing VT port

Explanation: Not normally displayed; indicates that an attempt to initialize a port failed.

User Action: None

PREFUSED, presentation connection refused

Explanation: The peer refused the association request at the Presentation layer.

User Action: Check that the address associated with the alias is correct.

PROGERR, Internal programming error

Explanation: An internal programming error has been encountered.

User Action: Contact your Digital support representative.

PROTOCOLERR, protocol encoding error detected

Explanation: An unspecified protocol encoding error was detected.

User Action: Initiate a trace to gather additional information leading up to the event.

PTERMINALERR, pterminal error

Explanation: An error was encountered by the pseudo-terminal interface. Additional information should be supplied indicating what type of error was encountered.

User Action: None

QUEUEERR, queue mismatch error

Explanation: Not normally displayed; indicates that an internal queue operation failed.

User Action: None

REJECTED, VT Association Rejected

Explanation: The attempt to establish a VT association with the remote end system implementation failed.

User Action: Look for additional text providing additional reasons for the cause of the failure.

RLQERR, error encoding/decoding RLQ

Explanation: An error was encountered in the encoding or decoding operation related to the specified VTP protocol data unit.

User Action: Initiate a trace to gather additional information leading up to the event.

RLRERR, error encoding/decoding RLR

Explanation: An error was encountered in the encoding or decoding operation related to the specified VTP protocol data unit.

User Action: Initiate a trace to gather additional information leading up to the event.

RTQERR, error encoding/decoding RTQ

Explanation: An error was encountered in the encoding or decoding operation related to the specified VTP protocol data unit.

User Action: Initiate a trace to gather additional information leading up to the event.

TOOMANYPORTS, too many ports in port list

Explanation: An attempt has been made to set VT\$VT_RJOBLIM, VT\$LAT_RJOBLIM or VT\$TELNET_RJOBLIM to a value higher than 512.

User Action: Reduce the value

UNEXPECTEDTAG, encountered an unexpected tag

Explanation: indicates that a protocol error was encountered; the VT decoder expected a particular tag and did not encounter it.

User Action: Initiate a trace to gather additional information leading up to the event.

UNKACTION, unknown action

Explanation: Not normally displayed; an action request was made during a state transition in the VT state machine, which could not be performed.

User Action: Initiate a state machine trace to gather additional information leading up to the event.

UNKEVENT, unknown event

Explanation: Not normally displayed; an event was encountered that the VT state machine was not prepared to handle, either because the event had not been defined or because the event happened in an unexpected state.

User Action: Initiate a state machine trace to gather additional information leading up to the event.

UNKNOWNIRTYPE, unknown IR type

Explanation: Not normally displayed; the VT software cannot determine if the port type is an initiator or a responder.

User Action: None

UNKOBJJUPD, unknown objectupdate type

Explanation: An object update request was made but the object being updated was not a Control Object, Display Object or RIOreference. Possibly a result of a protocol error.

User Action: Initiate a trace to gather additional information leading up to the event.

Virtual Terminal Error Messages

UNKOSAKEVENT, unknown OSAK event

Explanation: This is an internal error that should not normally be encountered.

User Action: Call your local support center.

UNKRESULT3, unknown result3

Explanation: An invalid code was specified for a VTP result3 encoding.

User Action: Initiate a trace to gather additional information leading up to the event.

UNKWAVAR, unknown WAVAR owner

Explanation: Not normally displayed; indicates that the specified WAVAR owner is not known. This error could be the result of a protocol error or an invalid profile.

User Action: Initiate a trace to gather additional information leading up to the event.

UNSCOUPDATE, unsupported COupdate

Explanation: A DO, CO or RIOreference operation was requested, which the VT software does not support. This can be the result of a protocol error.

User Action: Initiate a trace to gather additional information leading up to the event.

UNSDOUPDATE, unsupported DOupdate

Explanation: A DO, CO or RIOreference operation was requested, which the VT software does not support. This can be the result of a protocol error.

User Action: Initiate a trace to gather additional information leading up to the event.

UNSRIOREF, RIOreference is not supported

Explanation: Not normally displayed; a request was made for an RIOreference operation. The VT software does not currently support RIOreference.

User Action: None

UNSRIOREFERENCE, unsupported RIOreference

Explanation: A DO, CO or RIOreference operation was requested, which the VT software does not support. This can be the result of a protocol error.

User Action: Initiate a trace to gather additional information leading up to the event.

UNSVTEPARAMS, vteparams are not supported

Explanation: Not normally displayed; indicates a request was made for vteparams. The VT software does not currently support vteparams.

User Action: None

USRREJCALLINGAPTITLE, user reject; unknown calling AP-TITLE

Explanation: The attempt to establish a VT association with the remote end system implementation failed. The application-process (AP) title we specified was not recognized by the remote system.

User Action: Check the AP-title being sent.

Virtual Terminal Error Messages

USRREJNOREASON, user reject; no reason

Explanation: The attempt to establish a VT association with the remote end system implementation failed and no reason was given for the failure.

User Action: Get a trace, call your local support center.

USRREJNULL, user reject; null reason

Explanation: See USRREJNOREASON

User Action: See USRREJNOREASON

USRREJUNSACNAME, user reject; unsupported application context name

Explanation: The attempt to establish a VT association with the remote end system implementation failed because the responding implementation did not like the application context name we supplied. This can indicate that the other implementation is based on an older version of the International Standard (IS) 9041, namely Draft International Standard (DIS) 9041. This error can also occur if an attempt is made to connect to an OSI application other than VT (e.g., FTAM).

User Action: Check the other open system to see what application is waiting for a connection on the address you are trying to connect. If the other implementation is, in fact a Virtual Terminal implementation of IS 9041, then get a trace and call your local support center.

VUABIND, VT-USER-ABORT indication received

Explanation: A VT-USER-ABORT indication was received.

User Action: Examine the following error message for information about the abort.

Warning Messages

USERLIMITREDUCED, user limit reduced

Explanation: An attempt was made to exceed the maximum number of associations and the value was lowered.

User Action: None

A

Abstract syntax
 explanation of, 6–6
 notation, 6–6

Acceptor
 definition of, 6–4

Access
 contexts, explained, 7–7
 control, 10–7
 control elements, E–5
 information, 10–7

Accessing remote nodes, 5–1

Account
 in address database, 10–5
 in file specifications, 10–7
 name (FTAM), 2–3

ACEs, E–5

ACSE
 overview of, 7–13
 services of, 7–14
 standards, 6–1

Activity attributes
 explanation of, 7–8

Adding
 aliases, after installation, 9–7

Addressing
 AE-title, 10–4
 alternative terminology for, 13–14, 14–11

Adjacent system
 definition of, 13–1, 14–1

AE-qualifiers
 explanation of, 7–2

AE-titles
 explanation of, 7–2, 10–4

AP-titles
 explanation of, 7–2

append command
 FTAM example of, 4–11
 Internet example of, 4–9
 summary of, A–2

Appending
 Facility
 explanation of, 2–10
 OpenVMS example of, 2–11
 files
 using ocp, 2–11

Appending
 files (cont'd)
 with the FTAM–FTP Gateway, 4–11

Application
 address
 explanation of, 2–2, 2–5
 context
 definition of, 7–13
 entity
 definition of, 7–1
 process
 definition of, 7–1

Application address
 NSAP component, 9–9, 9–11
 PSEL component, 9–9, 9–11
 service access points, 9–9
 SSEL component, 9–9, 9–11
 TSEL component, 9–9, 9–11

Application-entity qualifier
 explanation of, 7–2

Application-entity title
 explanation of, 7–2

Application-process title
 explanation of, 7–2

ascii command
 Internet example of, 4–8

ASN.1
 explanation of, 6–7
 with FTAM, 7–4

Associations
 establishing, 7–13
 role of entities in, 7–1
 terminating, 7–14

B

Basic encoding rules for ASN.1
 explanation of, 6–7

binary command
 Internet example of, 4–8

bye command
 Internet example of, 4–5

C

cd command

Internet example of, 4-6

Changing directories

with the FTAM-FTP Gateway, 4-6

clear x25 access template command, 14-5

CLNS

service, definition of, 14-1

close command

Internet example of, 4-6

Command

FTAM

file, 12-6

Command mode (VT), 5-3

Commands

DCL

directory/acl, E-6

for starting FTAM, 10-2

for stopping FTAM, 10-2

osak\$start.com, 10-2

reply/enable=network, 10-2

set protection, 10-5

@sys\$startup:osak\$start.com, 10-2

@sys\$startup:osak\$stop.com, 10-2

FTAM

append, 4-11

copy, 4-11

delete, 4-12

directory, 4-11

ftamconvert, 12-6

ftp, 4-5

rename, 4-12

summary of Digital UNIX, B-1

summary of OpenVMS, A-2

FTAM DCL

example of, 10-7, 10-9

FTAM-FTP

bye, 4-5

quit, 4-5

quote CCAT, 4-2

FTAM-FTP Gateway, 4-1

Internet

append, 4-9

ascii, 4-8

binary, 4-8

cd, 4-6

close, 4-6

delete, 4-9

dir, 4-7

disconnect, 4-6

get, 4-7, 4-8

ls, 4-7

put, 4-9

recv, 4-8

status, 4-8

NCL

Commands

NCL (cont'd)

clear x25 access template, 14-5

creating foreign command for, 13-3, 14-4

disable x.25 access template, 14-5

enable x.25 access template, 14-5

set x.25 access template, 14-5

set x25 access template, 13-6

sho osi transport templates * all,
13-3, 14-4

starting up, 13-3, 14-4

VT

create alias, 11-1

ologin, 5-2

set host/vtp, 5-1

summary of Digital UNIX, D-2

summary of OpenVMS, C-2

sys\$startup:vt_start.com, 11-1

sys\$startup:vt_sysstart.com, 11-1

Concatenating files

using copy, 2-11

Concatenation

definition of, 2-10

Confirm primitive

definition of, 6-4

connect command

summary of, C-2, D-2

Connection management

explanation of, 8-1

Connection problems, 11-5

Connections

inbound, dynamics of, 10-10

outbound, dynamics of, 10-9

Constraint sets

explanation of, 7-7

Contents type

definition of, 2-10, E-2

Context management

explanation of, 8-1

copy command

FTAM examples of, 4-11

summary of, A-3

Copying

Facility

Digital UNIX example of, 2-8

explanation of, 2-8

OpenVMS example of, 2-8

files

records larger than 7168 bytes, 2-9

with confirmation (Digital UNIX), 2-10

with confirmation (OpenVMS), 2-9

with FTAM attributes, 2-9

with no output file-destination, 2-10

with the FTAM-FTP Gateway, 4-8, 4-11

create alias command, 11-1

D

DAP-FTAM Gateway
 default account, description of, 10-6
 explanation of, 3-1
 invoking from OpenVMS nodes, 3-1
 supported document types for, 3-3

Databases
 entries of,
 address, 10-4, 10-7

DCL
 definition of, 1-1

DECnet-Plus Virtual Terminal
 command mode for, 5-3
 explanation of, 1-3
 for accessing remote nodes, 5-1
 managing, 11-1
 profiles for, 1-5
 repertoire of, 1-6
 starting an association with, 5-1
 using, 5-1

Decoding
 illustration of, 6-7

Default account
 BYTLM quota of, 10-1
 default local application address for, 10-6
 password for, 10-6

Default address
 description of, 10-5

delete command
 FTAM examples of, 4-12
 Internet example of, 4-9
 summary of, A-13

Delete Facility
 explanation of, 2-12

Deleting files
 with confirmation, 2-12
 with the FTAM-FTP Gateway, 4-9, 4-12

Dialogue
 explanation of, 6-2

dialogue control
 explanation of, 8-2

Digital Command Language (DCL)
 definition of, 1-1

Digital TCP/IP Services for OpenVMS, 11-5

Digital UNIX FTAM command summary, B-1

Digital UNIX VT command summary, D-1

dir command
 Internet example of, 4-7

directory command
 FTAM example of, 4-11
 summary of, A-15

Directory facility
 explanation of, 2-12, B-12

directory/acl command, E-6

directory/app=ftam command, E-6

disable x.25 access template command,
 14-5

disconnect command
 Internet example of, 4-6

Displaying
 file transfer type, with the FTAM-FTP
 Gateway, 4-8
 files with the FTAM-FTP Gateway, 4-7

Displays
 for CONS OSI Templates, 14-7
 for directory command
 access control elements in, E-6
 for OSI Templates, 13-8

Document types
 and RMS files, E-1
 explanation of, 7-7

Downstream file processing support, 10-2

DTE address
 definition of, 13-5

E

enable x.25 access template command, 14-5

Encoding
 illustration of, 6-7

Entity
 application, 7-1
 containing ACSE, 7-1
 explanation of, 6-2
 FTAM, 7-1
 identifiers for, 7-2

Error messages
 FTAM, H-1
 VT, I-1

Event logging, 10-2

F

File
 attributes
 explanation of, 2-12, 7-4
 commands
 Digital UNIX FTAM, 4-5
 OpenVMS FTAM, 4-10
 contents
 explanation of, 7-4
 designation
 definition of, 2-3
 header
 description of, 12-5
 removing with ftamconvert command,
 12-6
 name in address database, 10-5
 specification
 definition of, 2-1
 Digital UNIX format of, 2-5
 Digital UNIX variables of, 2-5

- File
 - specification (cont'd)
 - OpenVMS format of, 2-2
 - OpenVMS variables of, 2-2
 - structure
 - explanation of, 7-4
 - Transfer Protocol (FTP) commands, 4-5
 - File attributes, definition and explanation of, B-12
 - file command, 12-6
 - File creation
 - file protection upon, 2-16
 - File protection
 - upon file creation, 2-16
 - File-service model
 - overview of, 7-8
 - services of, 7-9
 - filename*
 - definition of, 3-2
 - Filestore
 - actions, explanation of, 7-4
 - password
 - definition of, 2-3
 - specifying, 10-7
 - real, explanation of, 7-3
 - virtual, explanation of, 7-3
 - Foreign command
 - for NCL, creating, 13-3, 14-4
 - FPM
 - explanation of, 7-12
 - FTAM
 - access control in, 10-7
 - account, specifying, 10-7
 - application address
 - explanation of, 2-2, 2-5
 - entities, 7-1
 - file name
 - definition of, 2-4, 2-7
 - file protocol of, 7-12
 - inbound address entry example, 10-6
 - mapping of RMS file attributes to, E-1
 - operation of, 10-7
 - overview of, 7-2
 - privileges required for, 10-1
 - protocol machine, explanation of, 7-12
 - service primitives of, 7-11
 - services of, 7-9
 - software
 - OSI layers of, 6-1
 - standards implemented by, 6-1
 - standard
 - explanation of, 1-1
 - titles of, 6-1
 - starting, with network startup file, 10-2
 - stopping, 10-2
 - system
 - definition of, 1-1
 - user quotas required for, 10-1
 - FTAM responder
 - log file, 2-8
 - FTAM-FTP Gateway
 - appending files with, 4-11
 - changing directories with, 4-6
 - copying files with, 4-8, 4-11
 - deleting files with, 4-9, 4-12
 - description of, 12-6
 - displaying file transfer type with, 4-8
 - displaying files with, 4-7
 - functions of, 4-1
 - invoking
 - from Internet nodes, 4-2
 - from OpenVMS FTAM nodes, 4-10
 - from OSI nodes, 4-10
 - listing files with, 4-7, 4-11
 - managing, 12-6
 - renaming files with, 4-12
 - setting file transfer type for, 4-8
 - specifying a concatenation character for, 4-2
 - supported commands for, 4-1
 - use of
 - from Internet to OSI, 12-7
 - from OSI to Internet, 12-6
 - using the quote CCAT command for, 4-2
 - FTAM-2 Document Type, file transfer, 2-9
 - ftamconvert command, 12-6
 - FTDRIVER
 - explained, 11-1
 - FTP
 - ending session, 4-5
 - starting session, 4-5
 - ftp command
 - Internet example of, 4-5
 - Full path name, 4-7
 - Functional units
 - explanation of, 6-6
- ## G
-
- Gateways
 - DAP-FTAM, 3-1, 10-6
 - disabling, 11-4
 - FTAM-FTP, 4-1
 - LAT/VT, 11-5
 - logical name for, 11-4
 - managing, 11-2
 - required resources for, 11-4
 - starting, 11-3
 - Telnet/VT, 11-4
 - use of, 5-6
 - VT, management of, 12-7
 - get command
 - Internet examples of, 4-7, 4-8
 - gtwysystem*
 - definition of, 3-2

H

Hierarchical file model
 explanation of, 7–4
Home directory, 4–7

I

Indication primitive
 definition of, 6–4
Information transfer
 explanation of, 8–2
Initializing
 FTAM, 10–2
 OSAKserver, 10–2
 privileges for, 10–1
Initiator, 2–7
 definition of, 1–2, 7–1
 ID
 definition of, 2–3
 specification of, 10–7
 relationship to responder, 7–2
 using file names with, 2–4
Internet
 command summary, 4–4
 host
 file commands, 4–5
 functions of, 4–2
 user name format of, 4–6
 service, definition of, 13–1
ISO application-entity database
 See isoapplications
ISO standard
 for ACSE, 7–13
 for FTAM, 7–2
 for Presentation, 8–1
 for Session, 8–1
isoapplications, 9–7
 modifying, 9–7
IVP
 local application address used by, 10–6
 responder command file used by, 10–5

L

LAT/VT Gateway, 11–5
LAT/VT Gateway Service
 enabling, 12–8
Listeners
 managing, 12–2
 on OSI and RFC 1006 networks, 12–3
 registering in X.500 Directory, 12–5
 starting, 12–2, 12–4
Listeners (VT), 9–1, 12–1
Listing files, 2–12
 with the FTAM–FTP Gateway, 4–7, 4–11

Local application address
 default address for, 10–6
 format of, 10–4
Local data
 explanation of, 6–7
Local files
 definition of, 1–1
Logging events, 10–2
Lower-layer addressing
 gathering, 13–3
 overview of, 14–2
Lower-layer addressing, gathering, 14–4
ls command
 Internet example of, 4–7

M

Managing
 FTAM
 by interpreting error messages, H–1
 inbound addresses, 10–4
 ISO application-entity database, 9–7
 listeners, 12–2
 OSI Application Entity Database, 12–1
 outbound addresses, 10–7
 the FTAM–FTP Gateway, 12–6
 virtual filestore information, 12–5
 Virtual Terminal
 by identifying connection problems, 11–5
 by interpreting error messages, I–1
 using OSAKtrace utility for, 11–5
 VT, 11–1
Model
 file service, 7–8
 hierarchical file, 7–4
 OSI reference, 6–1
 virtual filestore, 7–3
Modifying isoapplications, 9–7

N

NBS-9 Support
 explanation of, 2–13
NCL
 starting up, 13–3, 14–4
Networks
 overview of, 13–1, 14–1
NIST implementation agreements
 document types defined by, 7–7
 file data types defined by, 7–4
Nodes in file structure, 7–4
Non-RMS file designation
 definition of, 2–4
Non-UNIX file designation
 definition of, 2–6
Notation
 explanation of, 6–7

NPAGEDYN
 explanation of, 11–2
NSAP address
 alternative terms for, 13–14, 14–12
 definition of, 13–2, 14–3
NSAP component (Tab.), 9–3
NSAP values
 specifying for X.25, 9–11

O

ocat command
 summary of, B–2
ocp command
 summary of, B–4
ologin (VT/Telnet) command
 summary of, D–5
ologin command
 summary of, D–3
ols command
 summary of, B–11
omv command
 summary of, B–14
Open system
 definition of, 6–1
OpenVMS FTAM
 command summary, 4–10
 file commands, 4–10
OpenVMS FTAM command summary, A–1
OpenVMS OSI account
 BYTLM quota of, 10–1
OpenVMS VT command summary, C–1
orm command
 summary of, B–16
osak application database, 10–4
 entries of, 10–4
OSAKserver
 processing BYTLM quota for, 10–1
 stopping, 10–2
OSAKtrace utility, 11–5
OSI
 standards, 6–1
 Template
 definition of, 13–2, 14–2
 Templates
 CONS, displays of, 14–7
 displays of, 13–8
 Transport address
 components of, 13–2, 14–3
 format of with IEEE 802 access, 13–11
 format with X.25 access, 13–7
OSI Application Entity Database
 managing, 12–1
OSI networks
 listening on, 12–3
osiapplsetup procedure
 using, 12–2

osit\$default account
 BYTLM quota of, 10–1

P

Passwords
 in address database, 10–5
 in file specifications, 10–7
Path name
 definition of, 2–6
PCI
 explanation of, 6–6
PDU
 explanation of, 6–7
Physical address
 alternative terms for, 13–14, 14–12
 definition of, 13–2
Presentation
 selector
 alternative terms for, 13–15, 14–12
 services, summary of, 8–2
 standards, overview of, 8–1
 titles of standards for, 6–1
Presentation context
 explanation of, 6–7
Primitives of FTAM services, 7–11
Privileges, 10–1
Processes
 of FTAM, 10–7
Profile
 A-mode Default, 1–5
 definition of, 1–5
 Generalized Telnet, 1–6
 Telnet, 1–5
 Transparent, 1–6
Profile Mapping, explanation of, F–1
Protocol control information
 See PCI
Protocol data unit
 See PDU
Protocols
 explanation of, 6–2
PSEL component (Tab.), 9–3
put command
 Internet example of, 4–9

Q

quit command
 Internet example of, 4–5
Quotas
 for user processes, 10–1
 OSAKserver process, BYTLM for, 10–1
 osit\$default account, BYTLM for, 10–1

R

Real filestore
 explanation of, 7–3

Receiver
 definition of, 7–2
 role of, 7–3

Record Management Services (RMS)
 definition of, 1–1

Recovery
 explanation of, 2–14

recv command
 Internet example of, 4–8

Regimes
 and services, 7–11
 explanation of, 7–8

Remote files
 definition of, 1–1

remote-alias
 definition of, 3–2

rename command
 FTAM example of, 4–12
 summary of, A–22

Renaming facility
 explanation of, 2–13

Renaming files, 2–14
 with the FTAM–FTP Gateway, 4–12

Repertoires
 explanation of, 1–6

reply/enable=network command, 10–2

Request primitive
 definition of, 6–3

Requestor
 definition of, 6–3

Responder, 2–7
 definition of, 7–1
 FTAM log file, 2–8
 managing, 11–1
 relationship to initiator, 7–2
 required resources for, 11–2
 stopping, 11–2
 using file names with, 2–4

Response primitive
 definition of, 6–4

Restart
 explanation of, 2–14

RFC 1006 networks
 listening on, 12–3

RMS
 definition of, 1–1

rms.ftam.osif
 explanation of, 10–5

S

SAP
 explanation of, 6–4
 selectors, 6–6

Saveset
 OpenVMS file copying, 2–9

SDU
 explanation of, 6–8

Security information, 10–7
 definition of, 2–3
 FTAM system, 2–6
 on FTAM systems, 2–3

Sender
 definition of, 7–2
 role of, 7–3

Service
 confirmed, 6–3
 primitives of, 6–3
 presentation, 8–2
 primitives, 6–3
 provider
 definition of, 6–3
 role of, 6–3
 session, 8–2
 types of, 6–3
 unconfirmed, 6–3
 primitives of, 6–3
 user
 definition of, 6–3

Service data unit
 See SDU

Service-access point
 See SAP

Services
 and regimes, 7–11
 explanation of, 6–3
 of ACSE, 7–14
 of FTAM, 7–9

Session
 selector
 alternative terms for, 13–15, 14–12
 services, summary of, 8–2
 standards, overview of, 8–1
 titles of standards for, 6–1

set host/lat command
 summary of, D–8

set host/vt lat command
 summary of, C–5

set host/vtp command
 summary of, C–3, C–6

set protection command, 10–5

set x.25 access template command, 14–5

set x25 access template command, 13–6

- sethost (VT PC) command
 - summary of, C-7, D-7
- Setting file transfer type, with FTAM-FTP Gateway, 4-8
- show known osi templates command, 13-3, 14-4
- Source system
 - definition of, 13-1, 14-1
- SSEL component, 9-3
- Standards
 - for ACSE, 7-13
 - for FTAM, 7-2
 - for Presentation, 8-1
 - for Session, 8-1
- Starting
 - FTAM, 10-2
 - listeners, 12-2, 12-4
 - OSAKserver, 10-2
- Starting up OSAKserver
 - privileges for, 10-1
- status command (Internet), 4-8
- Stopping
 - FTAM, 10-2
 - OSAKserver, 10-2
- Structural nodes
 - explanation of, 7-4
- Structure of files, 7-4
- Subnetwork
 - definition of, 13-1, 14-1
- Support
 - for downstream file processing, 10-2
- Syntax transformation
 - explanation of, 6-7
- Syntaxes
 - abstract, 6-6
 - notation, 6-6, 6-7
 - transfer, 6-6
- sys\$startup:vt_start.com, 11-1
- sys\$startup:vt_systart.com, 11-1

T

- Target system
 - definition of
 - Digital UNIX, 14-1
 - OpenVMS, 13-1
- telnet command
 - summary of, C-8, D-9
- Telnet/VT Gateway, 11-4
- Transfer syntax
 - explanation of, 6-6
- Transformation
 - See Syntax transformation
- Transformed data
 - definition of, 6-7

- Transport
 - class, in address database, 10-5
 - options, in address database, 10-5
 - options, use of, 9-4
 - selector
 - alternative terms for, 13-15, 14-12
 - transport options, 9-4
- Truncation, explanation of, A-9
- TSEL component, 9-3

U

- UNIX File System
 - definition of, 1-1
- User
 - name
 - in address database, 10-5
 - in file specifications, 10-7
 - Internet format of, 4-6
- User data
 - processing of, 6-8
- Using
 - DECnet-Plus Virtual Terminal, 5-1
 - osiapplsetup procedure, 12-2

V

- Virtual filestore
 - explanation of, 7-3
 - information
 - default values for contents type, 12-6
 - determining file header information for, 12-6
 - determining with file command, 12-6
 - handling mismatches of, 12-5
 - storage in file header, 12-5
 - model
 - access contexts of, 7-7
 - activity attributes of, 7-8
 - constraint sets of, 7-7
 - document types of, 7-7
 - file attributes in, 7-4
 - file contents in, 7-4
 - file structure in, 7-4
 - filestore actions of, 7-4
- Virtual Terminal
 - environment, 1-3
 - explained, 1-3
 - interactions, 1-3
 - listeners, 9-1, 12-1
 - network operation, 1-4
 - standard, 1-3
- Virtual-filestore model
 - explanation of, 7-3
- VT
 - gateway management, 12-7
 - software
 - OSI layers of, 6-1

vt\$lat_service
 explanation of, 11-5
vt\$vt_local_alias
 explanation of, 11-1
vt\$vt_rjoblim
 explanation of, 11-2

W

Wildcards
 definition of, 2-4

with directory command, 2-13

X

X.25
 specifying NSAP values for, 9-11
X.25 address
 alternative terms for, 13-14, 14-12
 definition of, 13-2
X.500 Directory
 registering listeners, 12-5

