

---

# OpenVMS Programming Concepts Manual, Volume I

Order Number: AA-RNSHB-TE

**June 2002**

This manual is Volume I of two volumes. It describes the features that the Compaq OpenVMS operating system provides to programmers in the following areas:

- Process and Synchronization
- Interrupts and Condition Handling
- Addressing and Memory Management

**Revision/Update Information:** This manual supersedes the *OpenVMS Programming Concepts Manual*, Version 7.3.

**Software Version:** OpenVMS Alpha, Version 7.3-1  
OpenVMS VAX, Version 7.3

**Compaq Computer Corporation**  
**Houston, Texas**

---

© 2002 Compaq Information Technologies Group, L.P.

Compaq, the Compaq logo, Alpha, OpenVMS, Tru64, VAX, and VMS are trademarks of Compaq Information Technologies Group, L.P. in the U.S. and/or other countries.

Microsoft, Windows, and Windows NT are trademarks of Microsoft Corporation in the U.S. and/or other countries.

Motif, OSF/1, UNIX, and X/Open are trademarks of The Open Group in the U.S. and/or other countries.

All other product names mentioned herein may be trademarks of their respective companies.

Confidential computer software. Valid license from Compaq required for possession, use, or copying. Consistent with FAR 12.211 and 12.212, Commercial Computer Software, Computer Software Documentation, and Technical Data for Commercial Items are licensed to the U.S. Government under vendor's standard commercial license.

Compaq shall not be liable for technical or editorial errors or omissions contained herein. The information in this document is provided "as is" without warranty of any kind and is subject to change without notice. The warranties for Compaq products are set forth in the express limited warranty statements accompanying such products. Nothing herein should be construed as constituting an additional warranty.

ZK6640

The Compaq *OpenVMS* documentation set is available on CD-ROM.

---

# Contents

<b>Preface</b> .....	xix
<b>1 Overview of Manuals and Introduction to Development on OpenVMS Systems</b>	
1.1 Overview of the Manual .....	1-1
1.2 Overview of the OpenVMS Operating System .....	1-2
1.3 Components of the OpenVMS Operating System .....	1-3
1.3.1 OpenVMS Systems on Multiple Platforms .....	1-4
1.3.1.1 System Compatibility and Program Portability Across Platforms .....	1-5
1.3.2 OpenVMS Computing Environments .....	1-5
1.3.2.1 Open System Capabilities .....	1-5
1.3.2.2 Application Portability .....	1-6
1.3.2.2.1 Other Application Portability Features .....	1-6
1.3.3 Distributed Computing Capabilities .....	1-6
1.3.3.1 Client/Server Style of Computing .....	1-6
1.3.3.2 OpenVMS Client/Server Capabilities .....	1-7
1.4 The OpenVMS Programming Environment .....	1-7
1.4.1 Programming to Standards .....	1-9
1.4.1.1 Common Environment for Writing Code .....	1-9
1.4.1.2 Common Language Environment .....	1-9
1.5 OpenVMS Programming Software .....	1-9
1.5.1 Creating Program Source Files .....	1-10
1.5.2 Creating Object Files .....	1-11
1.5.3 Creating Runnable Programs .....	1-12
1.5.4 Testing and Debugging Programs .....	1-13
1.5.4.1 Special Modes of Operation for Debugging .....	1-14
1.5.5 Using Other Program Development Utilities .....	1-14
1.5.6 Managing Software Development Tasks .....	1-15
1.6 Using Callable System Routines .....	1-15
1.6.1 Using the POSIX Threads Library Routines .....	1-15
1.6.2 Using OpenVMS Run-Time Library Routines .....	1-16
1.6.3 Using OpenVMS System Services .....	1-17
1.6.4 Using OpenVMS Utility Routines .....	1-18
1.7 Programming User Interfaces .....	1-19
1.8 Developing Real-Time Applications .....	1-20
1.9 Optional Compaq Software Development Tools .....	1-20
1.10 Managing Data .....	1-20
1.10.1 RMS Files and Records .....	1-21
1.10.2 RMS Utilities .....	1-21

## Part I Process and Synchronization

### 2 Process Creation

2.1	Process Types . . . . .	2-1
2.2	Execution Context of a Process . . . . .	2-2
2.3	Modes of Execution of a Process . . . . .	2-2
2.4	Creating a Subprocess . . . . .	2-3
2.4.1	Using LIB\$SPAWN to Create a Spawned Subprocess . . . . .	2-3
2.4.2	Using the C system() Call . . . . .	2-6
2.4.3	Using SYS\$CREPRC to Create a Subprocess . . . . .	2-6
2.4.3.1	Disk and Directory Defaults for Created Processes . . . . .	2-12
2.5	Creating a Detached Process . . . . .	2-13
2.6	Process Quota Lists . . . . .	2-14
2.7	Debugging a Subprocess or a Detached Process . . . . .	2-15
2.8	Kernel Threads and the Kernel Threads Process Structure (Alpha Only) . . . . .	2-17
2.8.1	Definition and Advantages of Kernel Threads . . . . .	2-17
2.8.2	Kernel Threads Features . . . . .	2-17
2.8.2.1	Multiple Execution Contexts Within a Process . . . . .	2-17
2.8.2.2	Efficient Use of the OpenVMS and POSIX Threads Library Schedulers . . . . .	2-18
2.8.2.3	Terminating a POSIX Threads Image . . . . .	2-18
2.8.3	Kernel Threads Model and Design Features . . . . .	2-19
2.8.3.1	Kernel Threads Model . . . . .	2-19
2.8.3.2	Kernel Threads Design Features . . . . .	2-19
2.8.3.2.1	Process Structure . . . . .	2-19
2.8.3.2.2	Access to Inner Modes . . . . .	2-20
2.8.3.2.3	Scheduling . . . . .	2-20
2.8.3.2.4	ASTs . . . . .	2-20
2.8.3.2.5	Event Flags . . . . .	2-20
2.8.3.2.6	Process Control Services . . . . .	2-20
2.8.4	Kernel Threads Process Structure . . . . .	2-20
2.8.4.1	Process Control Block (PCB) and Process Header (PHD) . . . . .	2-21
2.8.4.1.1	Effect of a Multithreaded Process on the PCB and PHD . . . . .	2-21
2.8.4.2	Kernel Thread Block (KTB) . . . . .	2-21
2.8.4.3	Floating-Point Registers and Execution Data Blocks (FREDs) . . . . .	2-22
2.8.4.4	Kernel Threads Region . . . . .	2-22
2.8.4.5	Per-Kernel Thread Stacks . . . . .	2-22
2.8.4.6	Per-Kernel-Thread Data Cells . . . . .	2-23
2.8.4.7	Summary of Process Data Structures . . . . .	2-23
2.8.4.8	Kernel Thread Priorities . . . . .	2-23

### 3 Process Communication

3.1	Communication Within a Process . . . . .	3-1
3.1.1	Using Local Event Flags . . . . .	3-2
3.1.2	Using Logical Names . . . . .	3-2
3.1.2.1	Using Logical Name Tables . . . . .	3-2
3.1.2.2	Using Access Modes . . . . .	3-2
3.1.2.3	Creating and Accessing Logical Names . . . . .	3-2
3.1.3	Using Command Language Interpreter Symbols . . . . .	3-5
3.1.3.1	Local and Global Symbols . . . . .	3-5
3.1.3.2	Creating and Using Global Symbols . . . . .	3-5

3.1.4	Using the Common Area . . . . .	3-6
3.1.4.1	Creating the Process Common Area . . . . .	3-6
3.1.4.2	Common I/O Routines . . . . .	3-6
3.1.4.3	Modifying or Deleting Data in the Common Block . . . . .	3-6
3.1.4.4	Specifying Other Types of Data . . . . .	3-6
3.2	Communication Between Processes . . . . .	3-7
3.2.1	Mailboxes . . . . .	3-8
3.2.1.1	Creating a Mailbox . . . . .	3-9
3.2.1.2	Creating Temporary and Permanent Mailboxes . . . . .	3-9
3.2.1.3	Assigning an I/O Channel Along with a Mailbox . . . . .	3-10
3.2.1.4	Reading and Writing Data to a Mailbox . . . . .	3-11
3.2.1.5	Using Synchronous Mailbox I/O . . . . .	3-12
3.2.1.6	Using Immediate Mailbox I/O . . . . .	3-14
3.2.1.7	Using Asynchronous Mailbox I/O . . . . .	3-17
3.3	Intra-Cluster Communication . . . . .	3-21
3.3.1	Programming with Intra-Cluster Communications . . . . .	3-22
3.3.1.1	ICC Concepts . . . . .	3-22
3.3.1.2	Design Considerations . . . . .	3-23
3.3.1.2.1	Naming . . . . .	3-23
3.3.1.2.2	Message Ordering . . . . .	3-23
3.3.1.2.3	Flow Control . . . . .	3-23
3.3.1.2.4	Transfer Sizes and Receiving Data . . . . .	3-23
3.3.1.2.5	Transfer Sizes and Transceive . . . . .	3-24
3.3.1.2.6	Disconnection . . . . .	3-24
3.3.1.2.7	Error Recovery . . . . .	3-24
3.3.1.3	General Programming Considerations . . . . .	3-25
3.3.1.4	Servers . . . . .	3-25
3.3.1.4.1	Connection Events . . . . .	3-26
3.3.1.4.2	Disconnection Events . . . . .	3-26
3.3.1.5	Clients . . . . .	3-26

## 4 Process Control

4.1	Using Process Control for Programming Tasks . . . . .	4-1
4.1.1	Determining Privileges for Process Creation and Control . . . . .	4-3
4.1.2	Determining Process Identification . . . . .	4-3
4.1.3	Qualifying Process Naming Within Groups . . . . .	4-5
4.2	Obtaining Process Information . . . . .	4-5
4.2.1	Using the PID to Obtain Information . . . . .	4-6
4.2.2	Using the Process Name to Obtain Information . . . . .	4-6
4.2.3	Using SYS\$GETJPI and LIB\$GETJPI . . . . .	4-9
4.2.3.1	Requesting Information About a Single Process . . . . .	4-9
4.2.3.2	Requesting Information About All Processes on the Local System . . . . .	4-12
4.2.4	Using SYS\$GETJPI with SYS\$PROCESS_SCAN . . . . .	4-14
4.2.4.1	Using SYS\$PROCESS_SCAN Item List and Item-Specific Flags . . . . .	4-16
4.2.4.2	Requesting Information About Processes That Match One Criterion . . . . .	4-17
4.2.4.3	Requesting Information About Processes That Match Multiple Values for One Criterion . . . . .	4-20
4.2.4.4	Requesting Information About Processes That Match Multiple Criteria . . . . .	4-20

4.2.5	Specifying a Node as Selection Criterion . . . . .	4-21
4.2.5.1	Checking All Nodes on the Cluster for Processes . . . . .	4-22
4.2.5.2	Checking Specific Nodes on the Cluster for Processes . . . . .	4-22
4.2.5.3	Conducting Multiple Simultaneous Searches with SYS\$PROCESS_SCAN . . . . .	4-23
4.2.6	Programming with SYS\$GETJPI . . . . .	4-24
4.2.6.1	Using Item Lists Correctly . . . . .	4-24
4.2.6.2	Improving Performance by Using Buffered \$GETJPI Operations . . . . .	4-24
4.2.6.3	Fulfilling Remote SYS\$GETJPI Quota Requirements . . . . .	4-25
4.2.6.4	Using the SYS\$GETJPI Control Flags . . . . .	4-26
4.2.7	Using SYS\$GETLKI . . . . .	4-30
4.2.8	Setting Process Privileges . . . . .	4-31
4.3	Changing Process and Kernel Threads Scheduling . . . . .	4-32
4.4	Using Affinity and Capabilities in CPU Scheduling (Alpha Only) . . . . .	4-32
4.4.1	Defining Affinity and Capabilities . . . . .	4-33
4.4.1.1	Using Affinity and Capabilities with Caution . . . . .	4-33
4.4.2	Types of Capabilities . . . . .	4-33
4.4.3	Looking at User Capabilities . . . . .	4-33
4.4.4	Using the Capabilities System Services . . . . .	4-34
4.4.5	Types of Affinity . . . . .	4-35
4.4.5.1	Implicit Affinity . . . . .	4-35
4.4.5.2	Explicit Affinity . . . . .	4-35
4.5	Using the Class Scheduler in CPU Scheduling . . . . .	4-36
4.5.1	Specifications for the Class_Schedule Command . . . . .	4-37
4.5.1.1	The Add Sub-Command . . . . .	4-37
4.5.1.2	The Delete Sub-Command . . . . .	4-38
4.5.1.3	The Modify Sub-Command . . . . .	4-38
4.5.1.4	The Show Sub-Command . . . . .	4-39
4.5.1.5	The Suspend Sub-Command . . . . .	4-39
4.5.1.6	The Resume Sub-Command . . . . .	4-39
4.5.2	The Class Scheduler Database . . . . .	4-40
4.5.2.1	The Class Scheduler Database and Process Creation . . . . .	4-40
4.5.3	Determining If a Process Is Class Scheduled . . . . .	4-40
4.5.4	The SYS\$SCHED System Service . . . . .	4-41
4.6	Changing Process Name . . . . .	4-41
4.7	Accessing Another Process's Context . . . . .	4-42
4.7.1	Reading and Writing in the Address Space of Another Process (Alpha Only) . . . . .	4-42
4.7.1.1	EXE\$READ_PROCESS and EXE\$WRITE_PROCESS . . . . .	4-42
	EXE\$READ_PROCESS . . . . .	4-43
	EXE\$WRITE_PROCESS . . . . .	4-45
4.7.2	Writing an Executive Image (Alpha Only) . . . . .	4-48
4.7.2.1	INITIALIZATION_ROUTINE Macro (Alpha Only) . . . . .	4-50
	INITIALIZATION_ROUTINE . . . . .	4-50
4.7.2.2	Linking an Executive Image (Alpha Only) . . . . .	4-51
4.7.2.3	Loading an Executive Image (Alpha Only) . . . . .	4-52
4.7.2.4	LDR\$LOAD_IMAGE (Alpha Only) . . . . .	4-53
	LDR\$LOAD_IMAGE . . . . .	4-53
4.7.2.5	LDR\$UNLOAD_IMAGE (Alpha Only) . . . . .	4-56
	LDR\$UNLOAD_IMAGE . . . . .	4-56
4.8	Synchronizing Programs by Specifying a Time for Program Execution . . . . .	4-59

4.8.1	Obtaining the System Time . . . . .	4-59
4.8.1.1	Executing a Program at a Specified Time . . . . .	4-60
4.8.1.2	Executing a Program at Timed Intervals . . . . .	4-61
4.8.2	Placing Entries in the System Timer Queue . . . . .	4-62
4.9	Controlling Kernel Threads and Process Execution . . . . .	4-63
4.9.1	Process Hibernation and Suspension . . . . .	4-63
4.9.1.1	Using Process Hibernation . . . . .	4-65
4.9.1.2	Using Alternative Methods of Hibernation . . . . .	4-66
4.9.1.3	Using SYS\$\$SUSPND . . . . .	4-67
4.9.2	Passing Control to Another Image . . . . .	4-67
4.9.2.1	Invoking a Command Image . . . . .	4-67
4.9.2.2	Invoking a Noncommand Image . . . . .	4-68
4.9.3	Performing Image Exit . . . . .	4-68
4.9.3.1	Performing Image Rundown . . . . .	4-69
4.9.3.2	Initiating Rundown . . . . .	4-69
4.9.3.3	Performing Cleanup and Rundown Operations . . . . .	4-70
4.9.3.4	Initiating Image Rundown for Another Process . . . . .	4-70
4.9.4	Deleting a Process . . . . .	4-71
4.9.4.1	Deleting a Process By Using System Services . . . . .	4-74
4.9.4.2	Terminating Mailboxes . . . . .	4-74

## 5 Symmetric Multiprocessing (SMP) Systems

5.1	Introduction to Symmetric Multiprocessing . . . . .	5-1
5.2	CPU Characteristics of an SMP System . . . . .	5-1
5.2.1	Booting an SMP System . . . . .	5-1
5.2.2	Interrupt Requests on SMP System . . . . .	5-2
5.3	Symmetric Multiprocessing Goals . . . . .	5-2

## 6 Synchronizing Data Access and Program Operations

6.1	Overview of Synchronization . . . . .	6-1
6.1.1	Threads of Execution . . . . .	6-2
6.1.2	Atomicity . . . . .	6-3
6.2	Memory Read and Memory Write Operations . . . . .	6-3
6.2.1	Alignment . . . . .	6-3
6.2.2	Granularity . . . . .	6-3
6.2.3	Ordering of Read and Write Operations . . . . .	6-4
6.2.4	Memory Reads and Memory Writes . . . . .	6-4
6.3	Memory Read-Modify-Write Operations . . . . .	6-5
6.3.1	Uniprocessor Operations . . . . .	6-5
6.3.2	Multiprocessor Operations . . . . .	6-6
6.4	Hardware-Level Synchronization . . . . .	6-7
6.4.1	Interrupt Priority Level . . . . .	6-7
6.4.2	LD $x$ _L and ST $x$ _C Instructions (Alpha Only) . . . . .	6-8
6.4.3	Using Interlocked Memory Instructions (Alpha Only) . . . . .	6-9
6.4.3.1	Required Code Checks . . . . .	6-9
6.4.3.2	Using the Code Analysis Tool . . . . .	6-9
6.4.3.3	Characteristics of Noncompliant Code . . . . .	6-10
6.4.3.4	Coding Requirements . . . . .	6-11
6.4.3.5	Compiler Versions . . . . .	6-13
6.4.3.6	Interlocked Memory Sequence Checking for the MACRO-32 Compiler . . . . .	6-13

6.4.3.7	Recompiling Code with ALONONPAGED_INLINE or LAL_REMOVE_FIRST Macros . . . . .	6-14
6.4.4	Interlocked Instructions (VAX Only) . . . . .	6-15
6.4.5	Memory Barriers (Alpha Only) . . . . .	6-16
6.4.6	PALcode Routines (Alpha Only) . . . . .	6-16
6.5	Software-Level Synchronization . . . . .	6-16
6.5.1	Synchronization Within a Process . . . . .	6-17
6.5.2	Synchronization in Inner Mode (Alpha Only) . . . . .	6-17
6.5.3	Synchronization Using Process Priority . . . . .	6-18
6.5.4	Synchronizing Multiprocess Applications . . . . .	6-18
6.5.5	Writing Applications for an Operating System Running in a Multiprocessor Environment . . . . .	6-19
6.5.6	Synchronization Using Spin Locks . . . . .	6-19
6.5.7	Writable Global Sections . . . . .	6-19
6.6	Using Event Flags . . . . .	6-20
6.6.1	General Guidelines for Using Event Flags . . . . .	6-21
6.6.2	Introducing Local and Common Event Flag Numbers and Event Flag Clusters . . . . .	6-21
6.6.3	Using Event Flag Zero (0) . . . . .	6-23
6.6.4	Using EFN\$C_ENF Local Event Flag . . . . .	6-23
6.6.5	Using Local Event Flags . . . . .	6-23
6.6.5.1	Example of Event Flag Services . . . . .	6-24
6.6.6	Using Common Event Flags . . . . .	6-25
6.6.6.1	Using the name Argument with SYS\$ASCEFC . . . . .	6-26
6.6.6.2	Temporary Common Event Flag Clusters . . . . .	6-27
6.6.6.3	Permanent Common Event Flag Clusters . . . . .	6-27
6.6.7	Wait Form Services and SYS\$SYNCH . . . . .	6-29
6.6.8	Event Flag Waits . . . . .	6-29
6.6.9	Setting and Clearing Event Flags . . . . .	6-31
6.6.10	Example of Using a Common Event Flag Cluster . . . . .	6-31
6.6.11	Example of Using Event Flag Routines and Services . . . . .	6-34
6.7	Synchronizing Operations with System Services . . . . .	6-35

## 7 Synchronizing Access to Resources

7.1	Synchronizing Operations with the Lock Manager . . . . .	7-1
7.2	Using the Dedicated CPU Lock Manager (Alpha Only) . . . . .	7-2
7.2.1	Implementing the Dedicated CPU Lock Manager . . . . .	7-2
7.2.2	Enabling the Dedicated CPU Lock Manager . . . . .	7-3
7.2.3	Using the Dedicated CPU Lock Manager With Affinity . . . . .	7-3
7.2.4	Using the Dedicated CPU Lock Manager with Fast Path Devices . . . . .	7-4
7.2.5	Using the Dedicated CPU Lock Manager on the AlphaServer GS Series Systems . . . . .	7-4
7.3	Concepts of Resources and Locks . . . . .	7-5
7.3.1	Resource Granularity . . . . .	7-6
7.3.2	Resource Domains . . . . .	7-6
7.3.3	Resource Names . . . . .	7-7
7.3.4	Choosing a Lock Mode . . . . .	7-7
7.3.5	Levels of Locking and Compatibility . . . . .	7-8
7.3.6	Lock Management Queues . . . . .	7-9
7.3.7	Concepts of Lock Conversion . . . . .	7-10
7.3.8	Deadlock Detection . . . . .	7-11



7.3.9	Lock Quotas and Limits . . . . .	7-11
7.3.9.1	Enqueue Limit Quota (ENQLM) . . . . .	7-12
7.3.9.2	Sub-Resources and Sub-Locks . . . . .	7-12
7.3.9.3	Resource Hash Table . . . . .	7-13
7.3.9.4	LOCKIDTBL System Parameter . . . . .	7-13
7.4	Queuing Lock Requests . . . . .	7-14
7.4.1	Example of Requesting a Null Lock . . . . .	7-15
7.5	Advanced Locking Techniques . . . . .	7-15
7.5.1	Synchronizing Locks . . . . .	7-16
7.5.2	Notification of Synchronous Completion . . . . .	7-16
7.5.3	Expediting Lock Requests . . . . .	7-16
7.5.4	Lock Status Block . . . . .	7-16
7.5.5	Blocking ASTs . . . . .	7-17
7.5.6	Lock Conversions . . . . .	7-17
7.5.7	Forced Queuing of Conversions . . . . .	7-19
7.5.8	Parent Locks . . . . .	7-19
7.5.9	Lock Value Blocks . . . . .	7-20
7.6	Dequeuing Locks . . . . .	7-21
7.7	Local Buffer Caching with the Lock Management Services . . . . .	7-23
7.7.1	Using the Lock Value Block . . . . .	7-23
7.7.2	Using Blocking ASTs . . . . .	7-23
7.7.2.1	Deferring Buffer Writes . . . . .	7-23
7.7.2.2	Buffer Caching . . . . .	7-24
7.7.3	Choosing a Buffer-Caching Technique . . . . .	7-24
7.8	Example of Using Lock Management Services . . . . .	7-25

## Part II Interrupts and Condition Handling

### 8 Using Asynchronous System Traps

8.1	Overview of AST Routines . . . . .	8-1
8.2	Declaring and Queuing ASTs . . . . .	8-2
8.2.1	Reentrant Code and ASTs . . . . .	8-3
8.2.1.1	The Call Frame . . . . .	8-3
8.2.2	Shared Data Access with Readers and Writers . . . . .	8-3
8.2.3	Shared Data Access and AST Synchronization . . . . .	8-4
8.2.4	User ASTs and Asynchronous Completions . . . . .	8-4
8.3	Common Mistakes in Asynchronous Programming . . . . .	8-5
8.4	Using System Services for AST Event and Time Delivery . . . . .	8-5
8.5	Access Modes for AST Execution . . . . .	8-6
8.6	Calling an AST . . . . .	8-7
8.7	Delivering ASTs . . . . .	8-8
8.7.1	The AST Service Routine . . . . .	8-8
8.7.2	Conditions Affecting AST Delivery . . . . .	8-10
8.7.3	Kernel Threads AST Delivery (Alpha Only) . . . . .	8-11
8.7.3.1	Outer Mode (User and Supervisor) Non-Serial Delivery of ASTs . . . . .	8-12
8.7.3.2	Inner Mode (Executive and Kernel) AST Delivery . . . . .	8-12
8.8	ASTs and Process Wait States . . . . .	8-13
8.8.1	Event Flag Waits . . . . .	8-13
8.8.2	Hibernation . . . . .	8-13
8.8.3	Resource Waits and Page Faults . . . . .	8-13
8.9	Examples of Using AST Services . . . . .	8-14

## 9 Condition-Handling Routines and Services

9.1	Overview of Run-Time Errors	9-1
9.2	Overview of the OpenVMS Condition Handling Facility	9-2
9.2.1	Condition-Handling Terminology	9-2
9.2.2	Functions of the Condition Handling Facility	9-4
9.3	Exception Conditions	9-6
9.3.1	Conditions Caused by Exceptions	9-7
9.3.2	Exception Conditions	9-12
9.3.3	Arithmetic Exceptions	9-13
9.3.4	Unaligned Access Traps (Alpha Only)	9-15
9.4	How Run-Time Library Routines Handle Exceptions	9-15
9.4.1	Exception Conditions Signaled from Mathematics Routines (VAX Only)	9-16
9.4.1.1	Integer Overflow and Floating-Point Overflow	9-16
9.4.1.2	Floating-Point Underflow	9-16
9.4.2	System-Defined Arithmetic Condition Handlers	9-16
9.5	Condition Values	9-18
9.5.1	Return Status Convention	9-21
9.5.1.1	Testing Returned Condition Values	9-21
9.5.1.2	Testing SS\$_NOPRIV and SS\$_EXQUOTA Condition Values	9-21
9.5.2	Modifying Condition Values	9-23
9.6	Exception Dispatcher	9-24
9.7	Argument List Passed to a Condition Handler	9-27
9.8	Signaling	9-28
9.8.1	Generating Signals with LIB\$SIGNAL and LIB\$STOP	9-30
9.8.2	Signal Argument Vector	9-33
9.8.3	VAX Mechanism Argument Vector (VAX Only)	9-35
9.8.4	Alpha Mechanism Argument Vector (Alpha Only)	9-37
9.8.5	Multiple Active Signals	9-39
9.9	Types of Condition Handlers	9-41
9.9.1	Default Condition Handlers	9-42
9.9.2	Interaction Between Default and User-Supplied Handlers	9-44
9.10	Types of Actions Performed by Condition Handlers	9-45
9.10.1	Unwinding the Call Stack	9-46
9.10.2	GOTO Unwind Operations (Alpha Only)	9-49
9.11	Displaying Messages	9-49
9.11.1	Chaining Messages	9-53
9.11.2	Logging Error Messages to a File	9-55
9.11.2.1	Creating a Running Log of Messages Using SYS\$PUTMSG	9-56
9.11.2.2	Suppressing the Display of Messages in the Running Log	9-56
9.11.3	Using the Message Utility to Signal and Display User-Defined Messages	9-57
9.11.3.1	Creating the Message Source File	9-58
9.11.3.1.1	Specifying the Facility	9-58
9.11.3.1.2	Specifying the Severity	9-59
9.11.3.1.3	Specifying Condition Names and Messages	9-59
9.11.3.1.4	Specifying Variables in the Message Text	9-60
9.11.3.1.5	Compiling and Linking the Messages	9-60
9.11.3.1.6	Linking the Message Object Module	9-60
9.11.3.1.7	Accessing the Message Object Module from Multiple Programs	9-60
9.11.3.1.8	Modifying a Message Source Module	9-61
9.11.3.1.9	Accessing Modified Messages Without Relinking	9-61

9.11.4	Signaling User-Defined Values and Messages with Global and Local Symbols . . . . .	9-61
9.11.4.1	Signaling with Global Symbols . . . . .	9-61
9.11.4.2	Signaling with Local Symbols . . . . .	9-61
9.11.4.3	Specifying FAO Parameters . . . . .	9-62
9.12	Writing a Condition Handler . . . . .	9-63
9.12.1	Continuing Execution . . . . .	9-64
9.12.2	Resignaling . . . . .	9-64
9.12.3	Unwinding the Call Stack . . . . .	9-64
9.12.4	Example of Writing a Condition Handler . . . . .	9-65
9.12.4.1	Signal Array . . . . .	9-65
9.12.4.2	Mechanism Array . . . . .	9-65
9.12.4.3	Comparing the Signaled Condition with an Expected Condition . . . . .	9-65
9.12.4.4	Exiting from the Condition Handler . . . . .	9-66
9.12.4.5	Returning Control to the Program . . . . .	9-67
9.12.5	Example of Condition-Handling Routines . . . . .	9-69
9.13	Debugging a Condition Handler . . . . .	9-70
9.14	Run-Time Library Condition-Handling Routines . . . . .	9-70
9.14.1	RTL Jacket Handlers (Alpha Only) . . . . .	9-71
9.14.2	Converting a Floating-Point Fault to a Floating-Point Trap (VAX Only) . . . . .	9-71
9.14.3	Changing a Signal to a Return Status . . . . .	9-71
9.14.4	Changing a Signal to a Stop . . . . .	9-73
9.14.5	Matching Condition Values . . . . .	9-73
9.14.6	Correcting a Reserved Operand Condition (VAX Only) . . . . .	9-73
9.14.7	Decoding the Instruction That Generated a Fault (VAX Only) . . . . .	9-73
9.15	Exit Handlers . . . . .	9-74
9.15.1	Establishing an Exit Handler . . . . .	9-75
9.15.2	Writing an Exit Handler . . . . .	9-77
9.15.3	Debugging an Exit Handler . . . . .	9-77
9.15.4	Example of Exit Handler . . . . .	9-78

## Part III Addressing and Memory Management

### 10 Overview of Alpha Virtual Address Space

10.1	Using 64-Bit Addresses . . . . .	10-1
10.2	Traditional OpenVMS 32-Bit Virtual Address Space Layout . . . . .	10-2
10.3	OpenVMS Alpha 64-Bit Virtual Address Space Layout . . . . .	10-3
10.3.1	Process-Private Space . . . . .	10-4
10.3.2	System Space . . . . .	10-4
10.3.3	Page Table Space . . . . .	10-5
10.3.4	Virtual Address Space Size . . . . .	10-5
10.4	Virtual Regions . . . . .	10-6
10.4.1	Regions Within P0 Space and P1 Space . . . . .	10-7
10.4.2	64-Bit Program Region . . . . .	10-7
10.4.3	User-Defined Virtual Regions . . . . .	10-8

## 11 Support for 64-Bit Addressing (Alpha Only)

11.1	System Services Support for 64-Bit Addressing	11-1
11.1.1	System Services Terminology	11-1
11.1.2	Comparison of 32-Bit and 64-Bit Descriptors	11-2
11.1.3	Comparison of 32-Bit and 64-Bit Item Lists	11-4
11.1.3.1	32-Bit Item Lists	11-5
11.1.3.2	64-Bit Item Lists	11-6
11.1.4	System Services That Support 64-Bit Addresses	11-8
11.1.5	Sign-Extension Checking	11-12
11.1.6	Language Support for 64-Bit System Services	11-12
11.1.7	NEW STARLET Definitions for C	11-12
11.2	RMS Interface Enhancements for 64-Bit Addressing	11-14
11.2.1	RAB64 Data Structure	11-15
11.2.2	Using the 64-Bit RAB Extension	11-16
11.2.3	Macros to Support User RAB Structure	11-17
11.3	File System Support for 64-Bit Addressing	11-18
11.4	OpenVMS Alpha 64-Bit API Guidelines	11-18
11.4.1	Quadword/Longword Argument Pointer Guidelines	11-18
11.4.2	Alpha/VAX Guidelines	11-25
11.4.3	Promoting an API from a 32-Bit API to a 64-Bit API	11-25
11.4.4	Example of a 32-Bit Routine and a 64-Bit Routine	11-26
11.5	OpenVMS Alpha Tools and Utilities That Support 64-Bit Addressing	11-27
11.5.1	OpenVMS Debugger	11-27
11.5.2	OpenVMS Alpha System-Code Debugger	11-28
11.5.3	Delta/XDelta	11-28
11.5.4	LIB\$ and CVT\$ Facilities of the OpenVMS Run-Time Library	11-28
11.5.5	Watchpoint Utility	11-28
11.5.6	SDA	11-29
11.6	Language and Pointer Support for 64-Bit Addressing	11-29
11.7	Compaq C RTL Support for 64-Bit Addressing	11-30
11.7.1	Using the Compaq C Run-Time Library	11-30
11.7.2	Obtaining 64-Bit Pointers to Memory	11-31
11.7.3	Compaq C Header Files	11-31
11.7.4	Functions Affected	11-32
11.7.4.1	No Pointer-Size Impact	11-32
11.7.4.2	Functions Accepting Both Pointer Sizes	11-32
11.7.4.3	Functions with Two Implementations	11-33
11.7.4.4	Functions Restricted to 32-Bit Pointers	11-34
11.7.5	Reading Header Files	11-35

## 12 Memory Management Services and Routines on OpenVMS Alpha

12.1	Virtual Page Sizes (Alpha Only)	12-1
12.2	Levels of Memory Allocation Routines	12-2
12.3	Using System Services for Memory Allocation	12-4
12.3.1	Increasing and Decreasing Virtual Address Space	12-4
12.3.2	Input Address Arrays and Return Address Arrays	12-7
12.3.3	Allocating Memory in Existing Virtual Address Space on Alpha Systems (Alpha Only)	12-8
12.3.4	Page Ownership and Protection	12-9
12.3.5	Working Set Paging (Alpha Only)	12-9
12.3.6	Process Swapping	12-11

12.3.7	Sections . . . . .	12-11
12.3.7.1	Creating Sections . . . . .	12-12
12.3.7.2	Opening the Disk File . . . . .	12-13
12.3.7.3	Defining the Section Extents . . . . .	12-14
12.3.7.4	Defining the Section Characteristics . . . . .	12-14
12.3.7.5	Defining Global Section Characteristics . . . . .	12-15
12.3.7.6	Global Section Name . . . . .	12-16
12.3.7.7	Mapping Sections . . . . .	12-17
12.3.7.8	Mapping Global Sections . . . . .	12-19
12.3.7.9	Global Page-File Sections . . . . .	12-20
12.3.7.10	Mapping into a Defined Address Range (Alpha Only) . . . . .	12-20
12.3.7.11	Mapping from an Offset into a Section File (Alpha Only) . . . . .	12-21
12.3.7.12	Section Paging . . . . .	12-21
12.3.7.13	Reading and Writing Data Sections . . . . .	12-23
12.3.7.14	Releasing and Deleting Sections . . . . .	12-24
12.3.7.15	Writing Back Sections . . . . .	12-24
12.3.7.16	Memory-Resident Global Sections . . . . .	12-25
12.3.7.17	Image Sections . . . . .	12-25
12.3.7.18	Page Frame Sections . . . . .	12-25
12.3.7.19	Partial Sections (Alpha Only) . . . . .	12-26
12.3.8	Example of Using Memory Management System Services (Alpha Only) . . . . .	12-26
12.4	Large Page-File Sections (Alpha Only) . . . . .	12-30

### 13 Memory Management Services and Routines on OpenVMS VAX

13.1	Virtual Page Size . . . . .	13-1
13.2	Virtual Address Space . . . . .	13-1
13.3	Extended Addressing Enhancements on Selected VAX Systems . . . . .	13-3
13.3.1	Page Table Entry for Extended Addresses on VAX Systems . . . . .	13-5
13.4	Levels of Memory Allocation Routines . . . . .	13-5
13.5	Using System Services for Memory Allocation . . . . .	13-7
13.5.1	Increasing and Decreasing Virtual Address Space . . . . .	13-8
13.5.2	Input Address Arrays and Return Address Arrays . . . . .	13-9
13.5.3	Page Ownership and Protection . . . . .	13-10
13.5.4	Working Set Paging . . . . .	13-11
13.5.5	Process Swapping . . . . .	13-12
13.5.6	Sections . . . . .	13-13
13.5.6.1	Creating Sections . . . . .	13-14
13.5.6.2	Opening the Disk File . . . . .	13-14
13.5.6.3	Defining the Section Extents . . . . .	13-15
13.5.6.4	Defining the Section Characteristics . . . . .	13-15
13.5.6.5	Defining Global Section Characteristics . . . . .	13-16
13.5.6.6	Global Section Name . . . . .	13-17
13.5.6.7	Mapping Sections . . . . .	13-18
13.5.6.8	Mapping Global Sections . . . . .	13-19
13.5.6.9	Global Page-File Sections . . . . .	13-20
13.5.6.10	Section Paging . . . . .	13-20
13.5.6.11	Reading and Writing Data Sections . . . . .	13-22
13.5.6.12	Releasing and Deleting Sections . . . . .	13-23
13.5.6.13	Writing Back Sections . . . . .	13-23
13.5.6.14	Image Sections . . . . .	13-23
13.5.6.15	Page Frame Sections . . . . .	13-24
13.5.7	Example of Using Memory Management System Services . . . . .	13-25

<b>14</b>	<b>Using Run-Time Routines for Memory Allocation</b>	
14.1	Allocating and Freeing Pages	14-1
14.2	Interactions with Other Run-Time Library Routines	14-3
14.3	Interactions with System Services	14-4
14.4	Zones	14-6
14.4.1	Zone Attributes	14-8
14.4.2	Default Zone	14-12
14.4.3	Zone Identification	14-12
14.4.4	Creating a Zone	14-13
14.4.5	Deleting a Zone	14-13
14.4.6	Resetting a Zone	14-13
14.5	Allocating and Freeing Blocks	14-14
14.6	Allocation Algorithms	14-14
14.6.1	First Fit Algorithm	14-15
14.6.2	Quick Fit Algorithm	14-15
14.6.3	Frequent Sizes Algorithm	14-16
14.6.4	Fixed Size Algorithm	14-16
14.7	User-Defined Zones	14-16
14.8	Debugging Programs That Use Virtual Memory Zones	14-19
<b>15</b>	<b>Alignment on OpenVMS Alpha and VAX Systems</b>	
15.1	Alignment	15-1
15.1.1	Alignment and Performance	15-2
15.1.1.1	Alignment on OpenVMS VAX (VAX Only)	15-3
15.1.1.2	Alignment on OpenVMS Alpha (Alpha Only)	15-3
15.2	Using Compilers for Alignment (Alpha Only)	15-4
15.2.1	The Compaq C Compiler (Alpha Only)	15-4
15.2.1.1	Compiler Example of Memory Structure of VAX C and Compaq C	15-5
15.2.2	The BLISS Compiler	15-5
15.2.3	The Compaq Fortran Compiler (Alpha Only)	15-6
15.2.4	The MACRO-32 Compiler (Alpha Only)	15-6
15.2.5	The VAX Environment Software Translator—VEST (Alpha Only)	15-8
15.3	Using Tools for Finding Unaligned Data	15-9
15.3.1	The OpenVMS Debugger	15-9
15.3.2	The Performance and Coverage Analyzer—PCA	15-10
15.3.3	System Services (Alpha Only)	15-10
<b>16</b>	<b>Memory Management with VLM Features</b>	
16.1	Overview of VLM Features	16-1
16.2	Memory-Resident Global Sections	16-2
16.3	Fast I/O and Buffer Objects for Global Sections	16-4
16.3.1	Comparison of \$QIO and Fast I/O	16-4
16.3.2	Overview of Locking Buffers	16-4
16.3.3	Overview of Buffer Objects	16-5
16.3.4	Creating and Using Buffer Objects	16-6
16.4	Shared Page Tables	16-6
16.4.1	Memory Requirements for Private Page Tables	16-7
16.4.2	Shared Page Tables and Private Data	16-7
16.5	Expandable Global Page Table	16-8

## Part IV Appendices: Macros and Examples of 64-Bit Programming

### A C Macros for 64-Bit Addressing

DESCRIPTOR64 .....	A-1
\$is_desc64 .....	A-2
\$is_32bits .....	A-2

### B 64-Bit Example Program

### C VLM Example Program

## Index

### Examples

3-1	Performing an Iterative Calculation with a Spawned Subprocess .....	3-3
3-2	Opening a Mailbox .....	3-12
3-3	Synchronous I/O Using a Mailbox .....	3-12
3-4	Immediate I/O Using a Mailbox .....	3-15
3-5	Asynchronous I/O Using a Mailbox .....	3-18
4-1	Obtaining Different Types of Process Information .....	4-7
4-2	Using SYS\$GETJPI to Obtain Calling Process Information .....	4-9
4-3	Obtaining the Process Name .....	4-11
4-4	Using SYS\$GETJPI and the Process Name to Obtain Information About a Process .....	4-12
4-5	Using SYS\$GETJPI to Request Information About All Processes on the Local System .....	4-13
4-6	Using SYS\$GETJPI and SYS\$PROCESS_SCAN to Select Process Information by User Name .....	4-18
4-7	Using SYS\$GETJPI and SYS\$PROCESS_SCAN with Multiple Values for One Criterion .....	4-20
4-8	Selecting Processes That Match Multiple Criteria .....	4-21
4-9	Searching the Cluster for Process Information .....	4-22
4-10	Searching for Process Information on Specific Nodes in the Cluster ..	4-22
4-11	Using a SYS\$GETJPI Buffer to Improve Performance .....	4-25
4-12	Using SYS\$GETJPI Control Flags to Avoid Swapping a Process into the Balance Set .....	4-27
4-13	Procedure for Obtaining Process Lock Information .....	4-30
4-14	Executing a Program Using Delta Time .....	4-60
4-15	Executing a Program at Timed Intervals .....	4-62
7-1	Requesting a Null Lock .....	7-15
8-1	Calling the SYS\$SETIMR System Service .....	8-7
14-1	Monitoring Heap Operations with a User-Defined Zone .....	14-17
15-1	OpenVMS Debugger Output from SET OUTPUT LOG Command .....	15-9

## Figures

4-1	Image Exit and Process Deletion . . . . .	4-73
7-1	Model Database . . . . .	7-6
7-2	Three Lock Queues . . . . .	7-10
7-3	Deadlock . . . . .	7-11
7-4	Lock Status Block . . . . .	7-17
9-1	SS\$_HPARITH Exception Signal Array . . . . .	9-14
9-2	SS\$_ALIGN Exception Signal Array . . . . .	9-15
9-3	Format of a Condition Value . . . . .	9-19
9-4	Searching the Stack for a Condition Handler . . . . .	9-26
9-5	Sample Stack Scan for Condition Handlers . . . . .	9-30
9-6	Format of the Signal Argument Vector . . . . .	9-33
9-7	Signal Argument Vector for the Reserved Operand Error Conditions . . . . .	9-35
9-8	Signal Argument Vector for RTL Mathematics Routine Errors . . . . .	9-35
9-9	Format of a VAX Mechanism Argument Vector . . . . .	9-36
9-10	Mechanism Array on Alpha Systems . . . . .	9-38
9-11	Stack After Second Exception Condition Is Signaled . . . . .	9-41
9-12	Interaction Between Handlers and Default Handlers . . . . .	9-44
9-13	Unwinding the Call Stack . . . . .	9-48
9-14	Formats of Message Sequences . . . . .	9-52
9-15	Using a Condition Handler to Log an Error Message . . . . .	9-56
9-16	Structure of an Exit Handler . . . . .	9-75
10-1	32-Bit Virtual Address Space Layout . . . . .	10-2
10-2	64-Bit Virtual Address Space Layout . . . . .	10-3
11-1	General Format of a 32-Bit Descriptor . . . . .	11-3
11-2	General Format of a 64-Bit Descriptor . . . . .	11-3
11-3	Item_list_2 Format . . . . .	11-5
11-4	Item_list_3 Format . . . . .	11-5
11-5	Item_list_64a Format . . . . .	11-6
11-6	Item_list_64b Format . . . . .	11-7
11-7	item_list_64a . . . . .	11-21
11-8	item_list_64b . . . . .	11-21
12-1	Hierarchy of Alpha Memory Management Routines . . . . .	12-4
13-1	Virtual Address Overview on VAX Systems . . . . .	13-2
13-2	Layout of VAX Process Virtual Address Space . . . . .	13-3
13-3	Physical Address Space for VAX Systems with XPA . . . . .	13-4
13-4	Virtual Address Space for VAX Systems with XVA . . . . .	13-5
13-5	Hierarchy of VAX Memory Management Routines . . . . .	13-7
14-1	Memory Fragmentation . . . . .	14-3
14-2	Boundary Tags . . . . .	14-9
15-1	Aligned and Unaligned Structures . . . . .	15-2
15-2	Alignment Using VAX C Compiler . . . . .	15-5
15-3	Alignment Using Compaq C Compiler . . . . .	15-5



## Tables

1-1	Manual Description . . . . .	1-2
1-2	OpenVMS Programming Software . . . . .	1-10
1-3	Compilers, Interpreters, and Assemblers . . . . .	1-11
1-4	Other OpenVMS Program Development Utilities . . . . .	1-14
1-5	Groups of OpenVMS Run-Time Library Routines . . . . .	1-16
1-6	Groups of OpenVMS System Services . . . . .	1-17
1-7	OpenVMS Utility Routines . . . . .	1-18
2-1	Characteristics of Subprocesses and Detached Processes . . . . .	2-1
2-2	Comparison of LIB\$SPAWN, SYS\$CREPRC, and C system() Call Context Values . . . . .	2-3
4-1	Routines and Commands for Controlling Processes and Kernel Threads . . . . .	4-2
4-2	Process Identification . . . . .	4-5
4-3	SYS\$GETJPI Kernel Threads Item Codes . . . . .	4-15
4-4	SYS\$PROCESS_SCAN Kernel Threads Item Codes . . . . .	4-16
4-5	Item-Specific Flags . . . . .	4-16
4-6	Capabilities . . . . .	4-33
4-7	SYSMAN Command: Class_Schedule . . . . .	4-37
4-8	Class Name Qualifiers . . . . .	4-38
4-9	Show Sub-Command Qualifiers . . . . .	4-39
4-10	Time Manipulation System Services and Routines . . . . .	4-59
4-11	Process Hibernation and Suspension . . . . .	4-64
4-12	System Services and Routines Used for Hibernation and Suspension . . . . .	4-64
6-1	OpenVMS Compilers . . . . .	6-13
6-2	Usage Styles of Event Flags . . . . .	6-20
6-3	Event Flag Routines and Services . . . . .	6-21
6-4	Event Flags . . . . .	6-22
7-1	Lock Manager Services . . . . .	7-2
7-2	Lock Modes . . . . .	7-8
7-3	Compatibility of Lock Modes . . . . .	7-9
7-4	Legal QUECVT Conversions . . . . .	7-19
7-5	Effect of Lock Conversion on Lock Value Block . . . . .	7-21
8-1	AST System Services . . . . .	8-2
8-2	System Services That Use ASTs . . . . .	8-2
8-3	AST Arguments for VAX Systems and Alpha Systems . . . . .	8-9
9-1	Summary of Exception Conditions . . . . .	9-8
9-2	Architecture-Specific Hardware Exceptions . . . . .	9-12
9-3	Exception Summary Argument Fields . . . . .	9-14
9-4	Run-Time Library Condition-Handling Support Routines . . . . .	9-18
9-5	Fields of a Condition Value . . . . .	9-19
9-6	Severity of Error Conditions . . . . .	9-20
9-7	Privilege Errors . . . . .	9-22
9-8	Quota Errors . . . . .	9-22
9-9	\$CHFDEF Symbolic Names and Arguments on VAX Systems . . . . .	9-27
9-10	\$CHFDEF2 Symbolic Names and Arguments on Alpha Systems . . . . .	9-28

9-11	Fields in the Alpha Mechanism Array .....	9-39
11-1	Contents of the General Descriptor Format .....	11-4
11-2	64-Bit System Services .....	11-8
11-3	Structures Used by <code>_NEW_STARLET</code> Prototypes .....	11-14
11-4	Functions with Dual Implementations .....	11-34
11-5	Functions Restricted to 32-Bit Pointers .....	11-34
11-6	Callbacks That Pass Only 32-Bit Pointers .....	11-34
12-1	Page and Byte Offset Within Pages on Alpha Systems .....	12-7
12-2	Sample Virtual Address Arrays on Alpha Systems .....	12-8
12-3	Flag Bits to Set for Specific Section Characteristics on Alpha Systems .....	12-15
13-1	Sample Virtual Address Arrays on VAX Systems .....	13-10
13-2	Flag Bits to Set for Specific Section Characteristics on VAX Systems .....	13-16
14-1	Overhead for Area Control Blocks .....	14-10
14-2	Possible Values for the Block Size Attribute .....	14-10
14-3	Attribute Values for the Default Zone .....	14-12
14-4	Allocation Algorithms .....	14-14
15-1	Aligned Data Sizes .....	15-2
16-1	Page Table Size Requirements .....	16-7

## Intended Audience

This manual is intended for system and application programmers. It presumes that its readers have some familiarity with the Compaq *OpenVMS* programming environment.

## Document Structure

The printed copy of the *OpenVMS Programming Concepts Manual* is a two-volume manual. The first volume contains four parts; the four parts are as follows:

- Process and Synchronization
- Interrupts and Condition Handling
- Addressing and Memory Management
- Appendices: Macros and Examples of 64-Bit Programming

Within the parts of Volume I, chapters provide information about the programming features of the OpenVMS operating system. A list of the chapters and a summary of their content follows:

- Chapter 1 describes the structure of the two-volume manual, and offers an introduction to the OpenVMS operating system and to the tools that are available in the programming environment.
- Chapter 2 defines the two types of processes, and describes what constitutes the context of a process, and the modes of execution of a process. It also describes kernel threads and the kernel threads process structure.
- Chapter 3 describes communication within a process and between processes.
- Chapter 4 describes how to use the creation and control of a process or kernel thread for programming tasks. It also describes how to gather information about a process or kernel thread and how to synchronize a program by using time.
- Chapter 5 describes overview concepts of symmetric multiprocessing (SMP) systems.
- Chapter 6 describes synchronization concepts and the differences between the VAX system and Alpha system synchronization techniques. It presents methods of synchronization such as event flags, asynchronous system traps (ASTs), parallel processing RTLs, and process priorities, and the affects of kernel threads upon synchronization. It also describes how to use synchronous and asynchronous system services, and how to write applications in a multiprocessing environment.

- Chapter 7 describes the use of the lock manager system services to synchronize access to shared resources. This chapter presents the concept of resources and locks; it also describes the use of the SYS\$ENQ and SYS\$DEQ system services to queue and dequeue locks.
- Chapter 8 describes how to use asynchronous system traps (ASTs). It describes access modes and service routines for ASTs and how ASTs are declared and delivered. It also describes the effects of kernel threads on AST delivery.
- Chapter 9 describes the OpenVMS Condition Handling facility. It describes VAX system and Alpha system exceptions, arithmetic exceptions, and Alpha system unaligned access traps. It describes the condition value field, exception dispatcher, signaling, and the argument list passed to a condition handler. Additionally, types of condition handlers and various types of action performed by them are presented. This chapter also describes how to write and debug a condition handler, and how to use an exit handler.
- Chapter 10 describes the 32-bit and 64-bit use of virtual address space.
- Chapter 11 describes all the services, routines, tools, and programs that support 64-bit addressing.
- Chapter 12 describes system services and RTLs of Alpha systems to manage memory. It describes the page size and layout of virtual address space of Alpha systems. This chapter also describes how to add virtual address space, adjust working sets, control process swapping, and create and manage sections on Alpha systems.
- Chapter 13 describes the of system services and RTLs of VAX systems to manage memory. It describes the page size and layout of virtual address space of VAX systems. This chapter also describes how to add virtual address space, adjust working sets, control process swapping, and create and manage sections on VAX systems.
- Chapter 14 describes how to use RTLs to allocate and free pages and blocks of memory, and how to use RTLs to create, manage, and debug virtual memory zones.
- Chapter 15 describes the importance and techniques of instruction and data alignment.
- Chapter 16 describes the VLM memory management features, such as the following:
  - Memory-resident global sections
  - Fast I/O and buffer objects for global sections
  - Shared page tables
  - Expandable global page table
  - Reserved memory registry
- Appendix A describes the C language macros for manipulating 64-bit addresses, for checking the sign extension of the low 32 bits of 64-bit values, and for checking descriptors for the 64-bit format.
- Appendix B illustrates writing a program with a 64-bit region that was created and deleted by system services.
- Appendix C demonstrates the memory management VLM features described in Chapter 16.

## Related Documents

For a detailed description of each run-time library and system service routine mentioned in this manual, see the OpenVMS Run-Time Library documentation and the *OpenVMS System Services Reference Manual*.

You can find additional information about calling OpenVMS system services and Run-Time Library routines in your language processor documentation. You may also find the following documents useful:

- *OpenVMS DCL Dictionary*
- *OpenVMS User's Manual*
- *Guide to OpenVMS File Applications*
- *OpenVMS Guide to System Security*
- OpenVMS Record Management Services documentation
- *OpenVMS Utility Routines Manual*
- *OpenVMS I/O User's Reference Manual*

For additional information about Compaq *OpenVMS* products and services, access the Compaq website at the following location:

<http://www.openvms.compaq.com/>

## Reader's Comments

Compaq welcomes your comments on this manual. Please send comments to either of the following addresses:

Internet	<b>openvmsdoc@compaq.com</b>
Mail	Compaq Computer Corporation OSSG Documentation Group, ZKO3-4/U08 110 Spit Brook Rd. Nashua, NH 03062-2698

## How To Order Additional Documentation

Visit the following World Wide Web address for information about how to order additional documentation:

<http://www.openvms.compaq.com/>

## Conventions

The following conventions are used in this manual:

Ctrl/ <i>x</i>	A sequence such as Ctrl/ <i>x</i> indicates that you must hold down the key labeled Ctrl while you press another key or a pointing device button.
PF1 <i>x</i>	A sequence such as PF1 <i>x</i> indicates that you must first press and release the key labeled PF1 and then press and release another key or a pointing device button.

`Return`

In examples, a key name enclosed in a box indicates that you press a key on the keyboard. (In text, a key name is not enclosed in a box.)

In the HTML version of this document, this convention appears as brackets, rather than a box.

...

A horizontal ellipsis in examples indicates one of the following possibilities:

- Additional optional arguments in a statement have been omitted.
- The preceding item or items can be repeated one or more times.
- Additional parameters, values, or other information can be entered.

.

A vertical ellipsis indicates the omission of items from a code example or command format; the items are omitted because they are not important to the topic being discussed.

.

.

( )

In command format descriptions, parentheses indicate that you must enclose choices in parentheses if you specify more than one.

[ ]

In command format descriptions, brackets indicate optional choices. You can choose one or more items or no items. Do not type the brackets on the command line. However, you must include the brackets in the syntax for OpenVMS directory specifications and for a substring specification in an assignment statement.

|

In command format descriptions, vertical bars separate choices within brackets or braces. Within brackets, the choices are optional; within braces, at least one choice is required. Do not type the vertical bars on the command line.

{ }

In command format descriptions, braces indicate required choices; you must choose at least one of the items listed. Do not type the braces on the command line.

**bold text**

This typeface represents the introduction of a new term. It also represents the name of an argument, an attribute, or a reason.

*italic text*

Italic text indicates important information, complete titles of manuals, or variables. Variables include information that varies in system output (Internal error *number*), in command lines (*/PRODUCER=name*), and in command parameters in text (where *dd* represents the predefined code for the device type).

UPPERCASE TEXT

Uppercase text indicates a command, the name of a routine, the name of a file, or the abbreviation for a system privilege.

UPPERCASE TEXT

Uppercase text indicates a command, the name of a routine, the name of a file, or the abbreviation for a system privilege.

Monospace text

Monospace type indicates code examples and interactive screen displays.

In the C programming language, monospace type in text identifies the following elements: keywords, the names of independently compiled external functions and files, syntax summaries, and references to variables or identifiers introduced in an example.

- A hyphen at the end of a command format description, command line, or code line indicates that the command or statement continues on the following line.

numbers All numbers in text are assumed to be decimal unless otherwise noted. Nondecimal radices—binary, octal, or hexadecimal—are explicitly indicated.





---

# Overview of Manuals and Introduction to Development on OpenVMS Systems

This chapter describes the structure of this two-volume manual. This chapter also provides an overview of the OpenVMS operating system, its components, and the tools in programming software.

## 1.1 Overview of the Manual

This two-volume manual introduces the resources and features of the OpenVMS operating system that are available to help you develop programs. Table 1-1 describes the parts of each volume.

# Overview of Manuals and Introduction to Development on OpenVMS Systems

## 1.1 Overview of the Manual

Table 1–1 Manual Description

Volume	Part	Description
Volume I		
	Part I	<b>Process and Synchronization.</b> Describes the creation, communication, and control of processes. It also describes symmetric multiprocessing (SMP), and the synchronizing of data access, programming operations, and access to resources.
	Part II	<b>Interrupts and Condition Handling.</b> Describes the use of asynchronous system traps (ASTs), and the use of routines and services for handling conditions.
	Part III	<b>Addressing and Memory Management.</b> Describes 32-bit and 64-bit address space, and the support offered for 64-addressing. It also provides guidelines for 64-bit application programming interfaces (APIs); and OpenVMS Alpha, VAX, and VLM memory management with run-time routines for memory management, and alignment on OpenVMS Alpha and VAX systems.
	Part IV	<b>Appendices: Macros and Examples of 64-Bit Programming.</b> Describes the macros used in 64-bit programming, along with two examples of 64-bit programming.
Volume II		
	Part I	<b>OpenVMS Programming Interfaces: Calling a System Routine.</b> Describes the basic calling format for OpenVMS routines and system services. It also describes the STARLET structures and definitions for C programmers.
	Part II	<b>I/O, System and Programming Routines.</b> Describes the I/O operations, and the system and programming routines used by run-time libraries and system services.
	Part III	<b>Generic Macros for Calling System Services.</b> Describes in appendices the generic macros used for calling system services, OpenVMS data types, and the distributed name services on OpenVMS VAX systems.

## 1.2 Overview of the OpenVMS Operating System

The OpenVMS operating system is a highly flexible, general-purpose, multiuser system that supports the full range of computing capabilities, providing the high integrity and dependability of commercial-strength systems along with the benefits of open, distributed client/server systems.

OpenVMS operating systems can be integrated with systems from different vendors in open systems computing environments. Compaq has “opened” the traditional VMS system to support software that conforms to international standards for an open environment. These industry-accepted, open standards specify interfaces and services that permit applications and users to move between systems and allow applications on different systems to operate together.

# Overview of Manuals and Introduction to Development on OpenVMS Systems

## 1.2 Overview of the OpenVMS Operating System

The OpenVMS operating system configuration includes OpenVMS integrated software, services and routines, applications, and networks. The system supports all styles of computing, from timesharing to real-time processing to transaction processing. OpenVMS systems configured with optional software support distributed computing capabilities and can function as servers in multivendor client/server configurations.

The OpenVMS operating system is designed to provide software compatibility across all the processors on which it runs:

- OpenVMS VAX software runs on the complete family of VAX processors, which support traditional 32-bit processing.
- OpenVMS Alpha software runs on a full series of very high-speed RISC processors that support 64-bit as well as 32-bit processing.

Both VAX and Alpha processors encompass a wide range of computing power: from desktop and deskside workstations, through distributed office systems and data center servers, to extremely high performance enterprisewide servers.

The following sections describe the components of the OpenVMS operating system, give a general overview of the system software, and describe the various styles of computing that OpenVMS software supports. The sections also summarize the basic ways in which OpenVMS software can be configured and connected to other software, and the hardware platforms and processors on which the OpenVMS software runs.

### 1.3 Components of the OpenVMS Operating System

The OpenVMS operating system is a group of software programs (or images) that control computing operations. The base operating system is made up of core components and an array of services, routines, utilities, and related software. The OpenVMS operating system serves as the foundation from which all optional software products and applications operate. The services and utilities in the base OpenVMS operating system support functions such as system management, data management, and program development. Other integrated software that adds value to the system provides functions such as clustering and volume shadowing.

Optional software products, including application programs developed by OpenVMS programmers and other programmers, run on the core operating system. The OpenVMS system supports a powerful, integrated development environment with a wide selection of software development tools supplied by Compaq and other vendors. Application programs written in multiple languages provide computational, data-processing, and transaction-processing capabilities. Thousands of applications have been developed for OpenVMS systems by Compaq and independent software vendors.

#### **Compatibility Between Software Versions**

OpenVMS VAX and OpenVMS Alpha software exhibits compatibility from version to version:

- User-mode programs and applications created under earlier versions of OpenVMS VAX or OpenVMS Alpha run under subsequent versions with no change.
- Command procedures written under one version of OpenVMS continue to run under newer versions of the software.

# Overview of Manuals and Introduction to Development on OpenVMS Systems

## 1.3 Components of the OpenVMS Operating System

OpenVMS software developed on VAX platforms can migrate easily to Alpha platforms (see Section 1.3.1.1):

- Most OpenVMS VAX images run under translation on OpenVMS Alpha systems.
- Most user-mode OpenVMS VAX sources can be recompiled, relinked, and run on an OpenVMS Alpha system without modification. Code that explicitly relies on the VAX architecture requires modification.

### 1.3.1 OpenVMS Systems on Multiple Platforms

The OpenVMS operating system is available on two hardware platforms:

- A complex instruction set computer (CISC) architecture based on the VAX architecture
- A reduced instruction set computer (RISC) architecture based on the Alpha architecture

The OpenVMS VAX operating system runs on the CISC platform, and the OpenVMS Alpha operating system runs on the RISC platform. The OpenVMS Alpha operating system is a port of the OpenVMS VAX operating system, not a redesign of the operating system.

A computing architecture provides a set of rules that determine how the computer actually works; for example, the architecture defines how the data is addressed and the instructions are handled.

The VAX architecture is a flexible CISC architecture that provides for 32-bit processing. The instruction set consists of a large number of instructions of variable length, some of which are complex. The 32-bit VAX architecture provides sufficient address space for current and future applications. The capabilities of OpenVMS on VAX processors will continue to be expanded.

The VAX architecture is used across the entire VAX family of systems. The use of a single, unifying, integrated VAX architecture with the OpenVMS software permits an application to be developed on a VAX workstation, prototyped on a small VAX system, and put into production on a large VAX processor. The advantage of the VAX system approach is that it enables individual solutions to be tailored and fitted easily into a larger, enterprisewide solution.

The Alpha architecture is a high-performance RISC architecture that can provide 64-bit processing on a single chip. The use of the RISC architecture in Alpha processors offers increased CPU performance. The instruction set consists of uniformly sized simple instructions that can be executed rapidly. The 64-bit capability is especially useful for applications that require high performance and very large addressing capacity.

The hardware designs of VAX and Alpha processors are inherently reliable and are particularly suitable for high-availability applications (such as dependable applications for mission-critical business operations and server applications for a wide variety of distributed client/server environments).

A move to the Alpha design from a VAX processor can take place whenever applications require the performance or capacity. Alpha processor support for the 64-bit addressing capability provides sufficient primary data storage for the most data-intensive applications and for applications that perform very large numbers of high-speed I/O operations. For example, Alpha processors are appropriate for graphics- or numeric-intensive software applications that involve imaging, multimedia, visualization, simulation, and modeling.

# Overview of Manuals and Introduction to Development on OpenVMS Systems

## 1.3 Components of the OpenVMS Operating System

### 1.3.1.1 System Compatibility and Program Portability Across Platforms

The OpenVMS Alpha operating system is compatible with OpenVMS VAX systems in terms of user, system manager, and programmer environments. For general users and system managers, OpenVMS Alpha has the same interfaces as OpenVMS VAX. Virtually all OpenVMS VAX system management utilities, command formats, and tasks are identical in the OpenVMS Alpha environment. Additionally, OpenVMS VAX and OpenVMS Alpha systems can coexist in the same networking environment and in the same VMScluster system.

For programmers, the OpenVMS Alpha software development environment involves the same programming interfaces and development tools as with OpenVMS VAX. Most OpenVMS VAX application programs, especially those written in higher level languages, can be recompiled and relinked and then run on OpenVMS Alpha. Alternatively, if recompilation is not practical or possible, you can use the DECmigrate for OpenVMS AXP layered product to translate user-mode OpenVMS VAX images to run on OpenVMS Alpha systems.

### 1.3.2 OpenVMS Computing Environments

The OpenVMS operating system provides an array of capabilities that support the full range of computing environments. A computing environment is made up of resources that are compatible with each other and all work together toward a common goal. In general, OpenVMS environments can supply the following kinds of capabilities (which can exist in any combination):

- Open system capabilities
- Distributed processing capabilities
- Production system capabilities
- System and network management capabilities

OpenVMS software capabilities include both the standardized features of open systems computing and the commercial-strength functionality of traditional OpenVMS systems. System and network management software provides for control of heterogeneous, integrated environments.

The following sections describe the capabilities supported in OpenVMS computing environments and summarize the software resources available in each kind of environment.

#### 1.3.2.1 Open System Capabilities

OpenVMS offers the benefits of an open system environment, which permits both applications and users to move between systems. In addition, applications on different open systems can operate together.

The OpenVMS operating system makes available a set of services in an open domain, while still offering its traditional high-integrity computing services. Incorporation of open computing capabilities enhances the traditional feature-rich OpenVMS environment.

Software in the OpenVMS open systems environment enables the development and use of portable applications and consistent user interfaces and also permits systems to operate together. The keys to openness of OpenVMS systems are standard programming interfaces, standardized user interfaces, and standard protocols.

# Overview of Manuals and Introduction to Development on OpenVMS Systems

## 1.3 Components of the OpenVMS Operating System

### 1.3.2.2 Application Portability

Application portability is the capability to easily move an application from one system to another. Standard programming interfaces permit application and data portability. Portable applications written strictly to a suite of open specifications provide the following benefits:

- Applications can be written once and run on other open platforms that support the standards used in the applications.
- Users can access the wide range of applications available on open platforms.
- Applications can be supplied by different vendors.

Applications that are developed on the OpenVMS VAX or OpenVMS Alpha system and conform to open standards can be easily ported to other systems that conform to the same standard interfaces. Applications written in ISO and ANSI languages are portable to other systems. In addition, The Open Group/Motif graphical user interface supports application portability.

**1.3.2.2.1 Other Application Portability Features** Applications written in ISO/ANSI languages are easily portable to other platforms that support them. OpenVMS VAX and OpenVMS Alpha provide support for such languages as Ada, C, COBOL, and Fortran.

### 1.3.3 Distributed Computing Capabilities

In a distributed computing environment, an application is distributed over two or more systems or processors, each of which has its own autonomous operating environment. A distributed application is composed of separate modules, running on different systems, that communicate with each other by passing data between modules or by sharing access to files or databases. A distributed application must be able to coordinate its activities over a dispersed operating environment.

The distributed computing environment can consist of software located either in a single box or a single room or can comprise a worldwide network of computers. The systems in the distributed configuration can be uniprocessor, multiprocessor, or OpenVMS Cluster systems; systems from different vendors can be included in the same configuration.

#### 1.3.3.1 Client/Server Style of Computing

One style of distributed computing that permits resource sharing between different systems is client/server computing. In the client/server environment, portions of an application are distributed across the network between servers and clients:

- A server is any system that provides a service or resource to other systems.
- The client is the system requesting the service.

This style of computing allows each portion of a distributed application to run in its own optimal environment. The whole application does not have to run on one centralized system (such as a mainframe system), but enterprisewide cohesiveness can still be maintained. For example, individuals or local offices, using their own computers and running software appropriate to their needs, can be linked to large computers or OpenVMS Cluster systems in a network. A distributed computing system can function as though it were a single system that connects all parts of an enterprise. The client can have transparent access to the integrated resources of the enterprise.

# Overview of Manuals and Introduction to Development on OpenVMS Systems

## 1.3 Components of the OpenVMS Operating System

Any system can be a client or a server, and some systems may include both client software for certain applications and server software for other applications. Servers can be connected to many clients, and a client can be connected to more than one server at a time. (Client and server relationships may change frequently: at times it may not be possible to tell which is the client and which is the server.) In some cases, the application is stored on the server and run on the client, using the resources of the client. The user, who does not need to know what system is serving the application, can function in a familiar, local environment.

### 1.3.3.2 OpenVMS Client/Server Capabilities

OpenVMS systems support a wide variety of client/server configurations. Clients requiring resources can be personal computers, workstations, point-of-sale devices, OpenVMS systems, or systems from other vendors that are running the appropriate client software. Users on client systems can use character-cell terminals or windowing desktops.

Servers fulfilling clients' requests can be located on OpenVMS systems or other operating systems running appropriate server software. OpenVMS servers, for example, can provide file access, printing, application services, communication services, and computing power as application engines to clients on desktop devices or in laboratories or factories. Client/server configurations permit the commercial-strength capabilities of OpenVMS host systems to be integrated with the personal-computing capabilities of desktop systems.

Middleware, which runs on OpenVMS and other systems from multiple vendors, can be used to tie together clients and servers. Middleware integrates various client and server systems through application, communication, data interchange, and multivendor support. Complex information-sharing environments involving PC clients and operating system servers are supported by PATHWORKS software.

An essential feature of the OpenVMS operating system is its support of a rich environment for developing software application programs. The programming software integrated in the OpenVMS system provides the tools required to effectively develop new software applications. You also have the option of using additional powerful tools to enhance the productivity of software development in the OpenVMS environment.

The following sections summarize the primary program development features available on all OpenVMS VAX and OpenVMS Alpha systems. The sections also introduce the OpenVMS programming environment and present brief functional descriptions of the OpenVMS programming tools.

## 1.4 The OpenVMS Programming Environment

The OpenVMS system supports a flexible programming environment that offers a wide range of tools and resources to support efficient program development. This robust OpenVMS programming environment permits the development of mixed-language application programs and portable programs, as well as application programs with distributed functions that run in client/server environments. This environment also provides tools that allow you to use the web and other information technologies.

In the OpenVMS programming environment, you can use OpenVMS resources to perform the following tasks:

- Creating, controlling, and deleting processes

# Overview of Manuals and Introduction to Development on OpenVMS Systems

## 1.4 The OpenVMS Programming Environment

- Communicating with other components
- Sharing resources
- Implementing input/output procedures
- Using security features
- Managing memory
- Managing files
- Synchronizing events
- Providing for condition handling
- Calling utility routines

The components of an OpenVMS application are the main program, shared libraries, functional routines, and a user interface. Software tools that support development of applications in the OpenVMS programming environment include:

- Language compilers, interpreters, and assemblers
- Linkers and debuggers
- Text processors and other program development utilities
- Callable system routines such as run-time routines, system services, and other utility routines
- Record Management Services (RMS) routines and utilities

Optional software development tools that run on the OpenVMS system enhance programmer productivity, saving programming time and promoting the development of error-free code. OpenVMS supports optional integrated software products that enhance program development capabilities in an organization. These software development products can make use of middleware services that facilitate the development of applications for multivendor networks and for web-enabling tools to help develop client/server applications.

Middleware and web-enabling tools allow you to access data and information by using the web. The various middleware and web-enabling tools perform the following:

- Provide web access to data
- Provide web access to applications
- Provide web tools for commercial web servers
- Provide other web tools including freeware

Middleware products and capabilities include Distributed Computing Environment (DCE), Common Object Model (COM), and Compaq Reliable Transaction Router (RTR). Web-enabling tools include Compaq DECforms Web Connector, and Compaq TP Web Connector. For more information about middleware and web-enabling tools, go to the following URL:

<http://www.openvms.compaq.com/solutions/appdev.html>



# Overview of Manuals and Introduction to Development on OpenVMS Systems

## 1.4 The OpenVMS Programming Environment

### 1.4.1 Programming to Standards

Coding of programs for the OpenVMS environment and for other environments involves conforming to software development standards. OpenVMS standards that define modular programming techniques and procedure calling and condition handling practices pertain to applications specific to OpenVMS. IEEE and international standards apply to applications developed on OpenVMS that are designed to run on other systems as well as on OpenVMS.

#### 1.4.1.1 Common Environment for Writing Code

OpenVMS software programmers can write code in a common environment, following standard OpenVMS modular programming practices. This standard approach establishes the minimum criteria necessary to ensure the correct interface at the procedure level between software written by different programmers. If all programmers coding OpenVMS applications follow this standard approach, modular procedures added to a procedure library will not conflict with other procedures in the library. Standard modular programming practices apply to OpenVMS programs that have a public entry point. For details of this standard approach, see the *Guide to Creating OpenVMS Modular Procedures*.

#### 1.4.1.2 Common Language Environment

The OpenVMS system supports a common language environment, which permits using a mixture of languages in programming. A program written in any of the programming languages supported by OpenVMS can contain calls to procedures written in other supported languages. Mixed-language programming is possible because all supported languages adhere to the OpenVMS calling standard. This standard describes the techniques used by all supported languages for invoking routines and passing data between them. It also defines the mechanisms that ensure consistency in error and exception handling routines, regardless of the mix of programming languages. Information about the calling standard appears in the *OpenVMS Calling Standard*, and descriptions of how to use the calling interface are given in Chapter 17 and Chapter 18.

## 1.5 OpenVMS Programming Software

This section describes the integrated programming tools available on the OpenVMS operating system to help implement software development.

The phases of a typical software development life cycle can include proposal of the concept; formulation of requirements and specifications for the software product; design, implementation, and testing of the software; and integration and maintenance of the product. Implementing the software product involves building and modifying source code modules and compiling, linking, and executing the resulting images. Testing involves refining code to optimize performance.

As part of the software development life cycle, OpenVMS operating system components and optional software products that run on OpenVMS are used to develop applications. Some of the major OpenVMS programming software components, such as editors and utilities, are listed in Table 1–2. Programming language software supported by OpenVMS is described in Section 1.5.2. Optional program development software tools that run on OpenVMS are described in Section 1.9.

# Overview of Manuals and Introduction to Development on OpenVMS Systems

## 1.5 OpenVMS Programming Software

**Table 1–2 OpenVMS Programming Software**

Type of Software	OpenVMS Software Components
Text processors	DEC Text Processing Utility/Extensible Versatile Editor (DECTPU/EVE) EDT editor Text Editor and Corrector (TECO) vi, ed, and ex editors (POSIX) Compaq Language-Sensitive Editor for OpenVMS/Compaq Source Code Analyzer (LSE/SCA)
Major programming utilities	Linker OpenVMS Debugger Delta/XDelta Debugger OpenVMS Alpha System-Code Debugger <sup>1</sup>
Other program development utilities	Command Definition utility Librarian utility Message utility Patch utility <sup>2</sup> SUMSLP utility National Character Set utility System Dump Analyzer <sup>3</sup> POSIX for OpenVMS utilities
Callable system routines	Run-time library routines System services Utility routines Record Management Services (RMS) routines and utilities

<sup>1</sup>Alpha specific.

<sup>2</sup>VAX specific.

<sup>3</sup>Different versions run on the VAX and Alpha platforms.

The commands used to invoke some of the programming utilities (for example, linker, debugger, LIBRARIAN) vary slightly for VAX and Alpha platforms.

### 1.5.1 Creating Program Source Files

OpenVMS text-processing utilities can be used to create and modify program source files. The DEC Text Processing Utility (DECTPU) is a high-performance text processor that can be used to create text-editing interfaces such as EVE. DECTPU includes a high-level procedure language with its own compiler and interpreter, as well as the customizable EVE editing interface. DECTPU features multiple buffers, windows, and subprocesses, and provides for text processing in batch mode. The EDT editor is an interactive text editor that provides editing in keypad and line modes. EDT supports multiple buffers, startup command files, and journaling. In general, the EVE editing interface offers more capability than EDT for complex editing tasks.

TECO is a traditional character-oriented text-editing program that runs under both OpenVMS VAX and OpenVMS Alpha. It can be used to edit program sources and other ASCII text.

The vi editor is a display-oriented interactive text editor used in the POSIX for OpenVMS environment. POSIX also supports the ed and ex editors.

Other optional tools for creating source files on OpenVMS systems are available separately or as part of the Compaq software development environment. The Compaq Language-Sensitive Editor/Compaq Source Code Analyzer for OpenVMS (LSE/SCA) provides a multilanguage, multivendor editor for program

# Overview of Manuals and Introduction to Development on OpenVMS Systems

## 1.5 OpenVMS Programming Software

development and maintenance and also supplies cross-referencing features and the capability to analyze source code.

### 1.5.2 Creating Object Files

OpenVMS supports a variety of optional language compilers, interpreters, and assemblers that translate source code to object code (in the form of object modules). These language implementations adhere to industry standards, including ISO, ANSI, X/Open standards as well as U.S. Federal Information Processing Standards (FIPS) and Military Standards (MIL-STD), as applicable.

Table 1–3 lists language compilers, interpreters, and assemblers supported in the OpenVMS VAX and OpenVMS Alpha environments. Names that begin with DEC refer to software available on Alpha and VAX platforms unless otherwise indicated.

**Table 1–3 Compilers, Interpreters, and Assemblers**

Language	Characteristics
Compaq Ada	Complete production-quality implementation of Ada language; fully conforms to ANSI and MIL-STD standards; has Ada validation
VAX APL	Interpreter with built-in editor, debugger, file system, communication facility
VAX BASIC	Either an interpreter or a compiler; fully supported by the OpenVMS debugger; fully reentrant code
Compaq BASIC for OpenVMS Alpha	An optimizing compiler; highly compatible with VAX BASIC; no environment/interpreter support
Compaq BLISS-32	Advanced set of language features supporting development of modular software according to structured programming concepts
Compaq BLISS-64	Development of modular software support for 64-bit programs
VAX C	Full implementation of C programming language with added features for performance enhancement in the OpenVMS environment
Compaq C for OpenVMS Alpha	Compliant with ISO/ANSI-standard Programming Language C; supports 64-bit virtual addressing
Compaq C++	C++ compiler with class libraries, a new C Run-Time Library, and debug support; facilitates object-oriented program design
Compaq COBOL	Compliant with ANSI-standard COBOL; includes as enhancements screen-handling, file-sharing, and report-writing facilities
VAX DIBOL	For interactive data processing; includes a compiler, debugger, and utility programs for data handling, data storing, and interprogram communication
Compaq Fortran for OpenVMS VAX	ANSI-standard Fortran-77 support with many industry-leading extensions; conforms to FIPS standards; has a high optimization compiler and takes full advantage of features of OpenVMS environment

(continued on next page)

# Overview of Manuals and Introduction to Development on OpenVMS Systems

## 1.5 OpenVMS Programming Software

**Table 1–3 (Cont.) Compilers, Interpreters, and Assemblers**

Language	Characteristics
Compaq Fortran for OpenVMS Alpha	ANSI-standard FortranN-77 support, nearly all Compaq Fortran for OpenVMS VAX extensions support, and other language features, including recursion
Compaq Fortran 90	ANSI-standard Fortran-90 support for high-performance capabilities using parallel and clustered resources
VAX MACRO	Assembly language for programming the VAX computer under the OpenVMS operating system; uses all OpenVMS resources; supports large instruction set enabling complex programming statements
MACRO-32 Compiler	Available on OpenVMS Alpha systems to port existing VAX MACRO code to an Alpha system
MACRO-64 Assembler	Available on OpenVMS Alpha systems; a RISC assembly language that provides precise control of instructions and data
Compaq OPS5	Highly efficient language for implementing expert systems; used to apply artificial intelligence technology to production systems
Compaq Pascal	ANSI-standard Pascal features and added features support using character instruction sets and OpenVMS virtual memory
VAX PL/I	A compile-time preprocessor that allows language extension and conditional compilation
Compaq PL/I for OpenVMS Alpha	For complex programs; supports many data types including floating-point

### 1.5.3 Creating Runnable Programs

After a program source file is coded, it must be compiled or assembled into object modules by a language processor and then linked. The OpenVMS Linker binds the object modules into an image that can be executed on the OpenVMS operating system.

The linker processes object modules and shareable image files, as well as symbol table files, library files, and options files (used to manage the linking operation and simplify the use of complex, repetitious linker operations). The most common output of the linker is an executable image of the program. The linker can also produce a shareable image, a system image, an image map, or a symbol table file to be used by other programs being linked. Certain linking tasks, such as creating shareable images, are performed differently on OpenVMS VAX and OpenVMS Alpha systems.

The Librarian utility provides for efficient storage in central, easily accessible files of object modules, image files, macros, help text, or other record-oriented information.

### 1.5.4 Testing and Debugging Programs

The debugger allows users to trace program execution and to display and modify register contents using the same symbols as are in the source code.

The following debugger utilities available on both the OpenVMS VAX and OpenVMS Alpha operating systems contain some system-specific features related to the platform architecture:

- The OpenVMS Debugger (debugger), which debugs user-mode code
- The Delta/XDelta Debugger (DELTA/XDELTA), which debugs code in other modes as well as user mode

The OpenVMS symbolic debugger is more useful than DELTA/XDELTA for most programs: the symbolic commands entered using different interfaces (keypad, command line, or file of commands) display source code lines on the screen, have more descriptive error messages, and provide help information.

The debugger command language specified in the *OpenVMS Debugger Manual* provides more than 100 commands to control a debugging session, including these tasks:

- Control program execution on a line-by-line basis or at a user-specified breakpoint
- Display breakpoints, tracepoints, watchpoints, active routine calls, stack contents, variables, symbols, source code, and source directory search list
- Define symbols
- Create key definitions
- Change values in variables
- Evaluate a language or address expression
- Create or execute debugger command procedures

The OpenVMS symbolic debugger provides enhanced support for programs that have multiple threads of execution within an OpenVMS process, including any program that uses Compaq POSIX Threads Library for developing real-time applications.

The debugger has been modified to support debugging of programs that contain 64-bit data addresses.

An additional debugger utility is available only on an OpenVMS Alpha system: the OpenVMS Alpha System-Code Debugger, which can be used to debug non-pageable system code and device drivers. The system-code debugger is a symbolic debugger that lets the user employ the familiar OpenVMS Debugger interface to observe and manipulate system code interactively as it executes. The system-code debugger can display the source code where the software is executing and allows the user to advance by source line.

Users can perform the following tasks using the system-code debugger:

- Control the system software's execution, stopping at points of interest, resuming execution, intercepting fatal exceptions, and so on
- Trace the execution path of the system software
- Monitor exception conditions
- Examine and modify the value of variables

# Overview of Manuals and Introduction to Development on OpenVMS Systems

## 1.5 OpenVMS Programming Software

- In some cases, test the effect of modifications without having to edit the source code, recompile, and relink

You can use the OpenVMS Alpha System-Code Debugger to debug code written in the following languages: C, BLISS, and MACRO. Information about using the system-code debugger and how it differs from the OpenVMS Debugger is given in *Writing OpenVMS Alpha Device Drivers in C*.

### 1.5.4.1 Special Modes of Operation for Debugging

The OpenVMS operating system has a number of special modes of operation designed to aid in debugging complex hardware and software problems. In general terms, these special modes enable an extra level of tracing, data recording, and consistency checking that is useful in identifying a failing hardware or software component. These modes of operation are controlled by the following system parameters:

- MULTIPROCESSING
- POOLCHECK
- BUGCHECKFATAL
- SYSTEM\_CHECK

MULTIPROCESSING is useful for debugging privileged code that uses spinlocks, such as device driver code. POOLCHECK is useful for investigating frequent and inexplicable failures in a system. When POOLCHECK is enabled, pool-checking routines execute whenever pool is deallocated or allocated. BUGCHECKFATAL is useful for debugging the executive. SYSTEM\_CHECK turns on the previous three system parameters and also activates other software that aids in detecting problems. It enables a number of run-time consistency checks on system operation and records some trace information.

If you are using one of these special modes, for example, to debug a device driver or other complex application, under certain conditions generally related to high I/O loads, it is possible to incur a CPUSPINWAIT bugcheck. To prevent a CPUSPINWAIT bugcheck, use either the system default settings for these system parameters, or reduce the loading of the system.

If you have reason to change the default settings, you can reduce the likelihood of encountering a problem by setting the SMP\_LNGSPINWAIT system parameter to a value of 9000000.

### 1.5.5 Using Other Program Development Utilities

Other OpenVMS utility programs used for program development are listed in Table 1–4. RMS utilities, which permit file analysis and tuning, are covered in Section 1.10.2.

**Table 1–4 Other OpenVMS Program Development Utilities**

Utility	Function
Command Definition Utility (CDU)	Enables an application developer to create commands with a syntax similar to DIGITAL Command Language (DCL) commands

(continued on next page)

# Overview of Manuals and Introduction to Development on OpenVMS Systems

## 1.5 OpenVMS Programming Software

**Table 1–4 (Cont.) Other OpenVMS Program Development Utilities**

Utility	Function
Message utility	Permits user to create application messages to supplement the OpenVMS system messages
Patch utility <sup>1</sup>	Permits users to make temporary changes (in the form of patches) to an image file; the new version can then be run without recompiling and relinking
SUMSLP utility	Supplies batch-oriented editor used to make several updates to a single source file; one update program can be applied to all versions of a file
National character set utility	Permits users to define non-ASCII string collating sequences and to define conversion functions; allows an RMS indexed file to be collated using user-specified collating sequences
System Dump Analyzer utility <sup>2</sup>	Determines the cause of system failures; reads the crash dump file and formats and displays it; also used to diagnose root causes that lead to an error

<sup>1</sup>VAX specific.

<sup>2</sup>Different versions run on the VAX and Alpha platforms.

### 1.5.6 Managing Software Development Tasks

You can use optional products that run on OpenVMS systems to manage the complexity of software development tasks:

- Compaq Code Management System (CMS) for OpenVMS provides an efficient method of storing project files (such as documents, object files, and other records) and tracking all changes to these files.
- Compaq Module Management System (MMS) for OpenVMS automates building of software applications.

## 1.6 Using Callable System Routines

OpenVMS provides extensive libraries of prewritten and debugged routines that can be accessed by programs. Libraries specific to OpenVMS VAX and OpenVMS Alpha systems supply commonly needed routines optimized for the OpenVMS environment; these libraries include run-time library routines, system services, utility routines, and RMS services. These libraries are described in this section.

### 1.6.1 Using the POSIX Threads Library Routines

The POSIX Threads Library, previously known as DECthreads, routine library provides a set of portable services that support concurrent programming by creating and controlling multiple threads of execution within the address space provided by a single process on an OpenVMS system. POSIX threads services are based on the IEEE POSIX standard 1003.1c and are compliant with OSF Distributed Computing Environment (DCE) standards. On OpenVMS Alpha systems, POSIX threads are layered over kernel threads.

POSIX threads run-time library services provide an application programming interface usable from all OpenVMS languages and an open C-only POSIX interface that adheres to the POSIX threads standard.

On OpenVMS Alpha systems, POSIX threads provide support to accept 64-bit parameters.

# Overview of Manuals and Introduction to Development on OpenVMS Systems

## 1.6 Using Callable System Routines

The highly portable POSIX threads interface contains routines grouped in the following functional categories:

- General threads
- Object attributes
- Mutex
- Condition variable
- Thread context
- Thread cancellation
- Thread priority and scheduling
- Debugging

For more information about threads, see the *Guide to the POSIX Threads Library*.

### 1.6.2 Using OpenVMS Run-Time Library Routines

The OpenVMS Run-Time Library (RTL) is a set of language-independent procedures for programs to be run specifically in the OpenVMS environment. RTL routines establish a common run-time environment for application programs written in any language supported in the OpenVMS common language environment. RTL procedures adhere to the OpenVMS calling standard and can be called from any program or program module in a language supported by OpenVMS (see Section 1.5.2).

The run-time library provides general-purpose functions for application programs. Table 1–5 summarizes the groups of RTL routines.

**Table 1–5 Groups of OpenVMS Run-Time Library Routines**

Routine	Description
DTK\$ routines	Routines that control the Compaq DECtalk system
LIB\$ routines	Library routines that perform generally needed system functions such as resource allocation and common I/O procedures; provide support for 64-bit virtual addressing on OpenVMS Alpha systems
MTH\$ routines <sup>1</sup>	Math routines that perform arithmetic, algebraic, and trigonometric functions
DPML\$ routines <sup>2</sup>	Compaq Portable Mathematics Library for OpenVMS Alpha; a set of highly accurate mathematical functions
OTS\$ routines	Language-independent routines that perform tasks such as data conversion
SMG\$ routines	Screen management routines used in the design of complex images on a video screen
STR\$ routines	String manipulation routines

<sup>1</sup>VAX specific  
<sup>2</sup>Alpha specific

In addition, language-specific RTL routines support procedures in Ada, BASIC, C, COBOL, Fortran, Pascal, and PL/I as well as in POSIX C. Compaq C RTL routines support 64-bit programming on OpenVMS Alpha systems.



# Overview of Manuals and Introduction to Development on OpenVMS Systems

## 1.6 Using Callable System Routines

The Digital Extended Math Library (DXML) for OpenVMS is a set of libraries of mathematical subroutines that are optimized for Compaq platforms. DXML includes four libraries covering the areas of basic linear algebra, linear system and eigenproblem solvers, sparse linear system solvers, and signal processing. DXML offers development and run-time options and is suitable for high-performance applications such as seismic analysis, signal and image processing, and antenna design.

### 1.6.3 Using OpenVMS System Services

OpenVMS system services are procedures that control resources available to processes, provide for communication among processes, and perform basic operating system functions such as I/O coordination. Application programs can call OpenVMS system services to perform the same operations that the system services provide for the OpenVMS operating system (for example, creating a process or subprocess).

At run time, an application program calls a system service and passes control of the process to it. After execution of the system service, the service returns control to the program and also returns a condition value. The program analyzes the condition value, determines the success or failure of the system service call, and alters program execution flow as required.

OpenVMS system services are divided into functional groups, as shown in Table 1–6. System services can be used to protect and fine-tune the security of the OpenVMS environment, handle event flags and system interrupts, designate condition handlers, and provide logical name services and timer services to the application. Other system services control and provide information about processes, manage virtual memory use, and synchronize access to shared resources.

**Table 1–6 Groups of OpenVMS System Services**

Service Group	Function
Security	Provides mechanisms to enhance and control system security
Event flag	Clears, sets, and reads event flags; places process in wait state until flags are set
AST	Controls handling of software interrupts called asynchronous system traps (ASTs)
Logical names	Provide a generalized logical name service
Input/output	Performs input and output operations directly at the device driver level, bypassing RMS
Process control	Creates, deletes, and controls the execution of processes (on a clusterwide basis); permits a process on one node to request creation of a detached process on another node
Process information	Provides information about processes
Timer and time conversion	Permits scheduling of program events at specific times or time intervals; supplies binary time values
Condition handling	Designates condition-handling procedures that gain control when an exception/condition occurs

(continued on next page)

# Overview of Manuals and Introduction to Development on OpenVMS Systems

## 1.6 Using Callable System Routines

**Table 1–6 (Cont.) Groups of OpenVMS System Services**

Service Group	Function
Memory management	Permits control of an application program's virtual address space
Change mode	Changes the access mode of a process
Lock management	Permits cooperating processes to synchronize their access to shared resources
DECdtm services	Provide for complete and consistent execution of distributed transactions and for data integrity
Cluster event notification <sup>1</sup>	Requests notification when an OpenVMS Cluster configuration event occurs

<sup>1</sup>Alpha specific

OpenVMS I/O system services perform logical, physical, and virtual I/O and network operations, and queue messages to system processes. The \$QIO system service provides a direct interface to the operating system's I/O routines. These services are available from within most programming languages supported by OpenVMS and can be used to perform low-level I/O operations efficiently with a minimal amount of system overhead for time-critical applications.

On OpenVMS Alpha systems, new system services provide access to 64-bit virtual address space for process private use. Additionally, new system services are available to provide high CPU performance and improved symmetric multiprocessing (SMP) scaling of I/O operations. These services exhibit high-performance gains over the \$QIO service.

DECdtm services ensure consistent execution of applications on the OpenVMS operating system. In transaction processing applications, many users may be simultaneously making inquiries and updating a database. The distributed transaction processing environment typically involves communication between networked systems at different locations. DECdtm services coordinate distributed transactions by using the two-phase commit protocol and implementing special logging and communication techniques. DECdtm services ensure that all parts of a transaction are completed or the transaction is aborted.

### 1.6.4 Using OpenVMS Utility Routines

OpenVMS programs can access some OpenVMS utilities through callable interfaces. Utility routines enable programs to invoke the utility, execute utility-specific functions, and exit the utility, returning to the program. Table 1–7 lists the OpenVMS utility routines.

**Table 1–7 OpenVMS Utility Routines**

Routine	Utility/Facility
ACL\$	Access control list editor (ACL editor)
CLI\$	Command Definition Utility (CDU)
CONV\$	Convert and Convert/Reclaim utilities (CONVERT and CONVERT/RECLAIM)

(continued on next page)

# Overview of Manuals and Introduction to Development on OpenVMS Systems

## 1.6 Using Callable System Routines

**Table 1–7 (Cont.) OpenVMS Utility Routines**

<b>Routine</b>	<b>Utility/Facility</b>
DCX\$	Data Compression/Expansion facility (DCX)
EDT\$	EDT editor
FDL\$	File Definition Language utility (FDL)
LBR\$	Librarian utility (LIBRARIAN)
LGI\$	LOGINOUT routines
MAIL\$	Mail utility (MAIL)
NCS\$	National Character Set utility (NCS)
PSM\$	Print Symbiont Modification facility (PSM)
SMB\$	Symbiont/Job-Controller Interface facility (SMB)
SOR\$	Sort/Merge utility (SORT/MERGE)
TPU\$	DEC Text Processing Utility (DECTPU)

You can use an optional, portable library of user-callable routines to perform high-performance sorting on OpenVMS Alpha systems. The high-performance sort supports a subset<sup>1</sup> of the functionality present on the OpenVMS Sort/Merge utility, using the callable interface to the SOR\$ routine. The high-performance sort/merge provides better performance for most sort and merge operations.

## 1.7 Programming User Interfaces

User interfaces to the OpenVMS VAX and OpenVMS Alpha operating systems include the DCL interface and the optional Compaq DECwindows Motif for OpenVMS graphical user interface. Another user interface is through electronic forms.

You can use DCL commands to invoke program development software (compilers, editors, linkers) and to run and control execution of programs. You can use DCL command procedures to perform repetitious operations in software development.

The Command Definition Utility (CDU) enables application developers to create DCL-level commands with a syntax similar to OpenVMS DCL commands. Using CDU, the developer can create applications with user interfaces similar to those of operating system applications. The Message utility permits an application developer to create application messages to supplement the system messages supplied by the OpenVMS operating system.

The Compaq DECwindows Motif for OpenVMS software provides a consistent user interface for developing software applications and includes an extensive set of programming libraries and tools. Compaq DECwindows Motif for OpenVMS supports both the OSF/Motif standards-based graphical user interface and the X user interface (XUI) in a single run-time and development environment. Compaq DECwindows Motif for OpenVMS Alpha requires a DECwindows X11 display server (device driver and fonts) that supports the portable compiled format (PCF), permitting use of vendor-independent fonts.

<sup>1</sup> Available with OpenVMS Alpha Version 7.0; full functionality is planned for a future version of OpenVMS Alpha.

## Overview of Manuals and Introduction to Development on OpenVMS Systems

### 1.7 Programming User Interfaces

An applications programmer can use the following Compaq DECwindows Motif for OpenVMS software to construct a graphical user interface:

- A user interface toolkit composed of graphical user interface objects (widgets and gadgets); widgets provide advanced programming capabilities that permit users to create graphic applications; gadgets, similar to widgets, require less memory to create labels, buttons, and separators
- A user interface language to describe visual aspects of objects (menus, labels, forms) and to specify changes resulting from user interaction
- The OSF/Motif Window Manager, which allows users to customize the interface

The Compaq DECwindows Motif for OpenVMS programming libraries provided include:

- Standard X Window System libraries such as Xlib and the intrinsics
- Libraries needed to support the current base of XUI applications
- OSF/Motif toolkit support for developing applications using the Motif user interface style
- Compaq libraries that give users capabilities beyond the standards

### 1.8 Developing Real-Time Applications

The VAXELN Toolkit is a set of tools that can be used on VAX computers running OpenVMS to develop efficient real-time applications (for example, real-time applications for process control, simulation, or high-speed data acquisition). VAXELN real-time applications are run on rtVAX computers. The VAXELN real-time operating environment optimizes dedicated real-time systems for predictability and fast response time. VAXELN transparently supports open standards such as IEEE 1003.1 and IEEE 1003.1b (previously 1003.4). VAXELN operates in TCP/IP and DECnet local and wide area networks.

### 1.9 Optional Compaq Software Development Tools

Compaq supplies optional software development tools for the OpenVMS environment, such as DECset. DECset is a set of tools that supports software coding, testing, and maintenance of applications and data. These tools can be used individually or as part of the optional Compaq software development environment.

### 1.10 Managing Data

The basic OpenVMS tool for transparent, intuitive management of data is the Record Management Services (RMS) subsystem. RMS is a collection of routines that gives programmers a device-independent method for storing, retrieving, and modifying data for their application. RMS also provides extensive protection and reliability features to ensure data integrity.

RMS is a higher level interface to the file system and OpenVMS I/O subsystem. It is used by all products that run on OpenVMS VAX and OpenVMS Alpha for file and record operations. A subset of RMS services permits network file operations that are generally transparent to the user.

On OpenVMS Alpha systems, RMS supports I/O operations to and from 64-bit addressable space.

### 1.10.1 RMS Files and Records

RMS supports a variety of file organizations, record formats, and record-access modes. RMS supports sequential, relative, and indexed disk file organizations, and fixed- and variable-length records. It supports a number of record-access modes: sequential, by key value, by relative record number, or by record file address. RMS is designed primarily for mass storage devices (disks and tapes), but also supports unit-record devices such as terminals or printers.

RMS routines assist user programs in processing and managing files and their contents. RMS routines perform these services for application programs:

- Creating new files, accessing existing files, extending disk space for files, closing files, and obtaining file characteristics
- Getting, locating, inserting, updating, and deleting records in files

RMS promotes safe and efficient file sharing by providing multiple access modes, automatic record locking when applicable, and optional buffer sharing by multiple processes.

### 1.10.2 RMS Utilities

RMS file utilities allow users to analyze the internal structure of an RMS file and to determine the most appropriate set of parameters to tune an RMS file. RMS utilities can also be used to create, efficiently load, and reclaim space in an RMS file.

RMS file maintenance utilities include the following:

- Analyze/RMS\_File utility
- File Definition Language utilities (Create/FDL and Edit/FDL)
- Convert and Convert/Reclaim utilities

The Analyze/RMS\_File utility allows the programmer to analyze the internal structure of an OpenVMS RMS file and generate a report on its structure and use, as well as interactively explore the file's structure. The utility can generate an FDL file from an RMS file for use with the Edit/FDL utility to optimize the data file.

File Definition Language (FDL) is a special-purpose language for specifying file characteristics; it is useful with higher level languages or for ensuring that files are properly tuned. FDL makes use of RMS control blocks: the file access block (FAB), the record access block (RAB), and the extended attribute block (XAB).

The Edit/FDL utility creates a new FDL file according to user specifications. The Create/FDL utility uses the specifications of an existing FDL file to create a new empty data file.

You can use the Convert utility to copy records from one file to another, while changing the record format and file organization, and to append records to an existing file. The Convert/Reclaim utility reclaims empty bucket space in an indexed file to allow new records to be written to it.



# Part I

---

## Process and Synchronization

This part describes the creation, communication, and control of processes. It also describes symmetric multiprocessing (SMP), and the synchronizing of data access, programming operations, and access to resources.





---

## Process Creation

This chapter describes process creation and the different types of processes. It also describes kernel threads and the kernel threads process structure. This chapter contains the following sections:

Section 2.1 defines a process and describes the two types of processes.

Section 2.2 describes the execution context of a process.

Section 2.3 describes the modes of execution of a process.

Section 2.4 describes the creation of a subprocess.

Section 2.5 describes the creation of a detached process.

Section 2.6 describes the creation and use of process quota lists (PQLs).

Section 2.7 describes debugging within a subprocess and a detached process.

Section 2.8 describes kernel threads and the parts that make up the kernel threads process.

### 2.1 Process Types

A process is the environment in which an image executes. Two types of processes can be created with the operating system: spawned subprocesses or detached processes.

A **spawned subprocess** is dependent on the process that created it (its parent), and receives a portion of its parent process's resource quotas. The system deletes the spawned subprocess when the parent process exits.

A **detached process** is independent of the process that created it. The process the system creates when you log in is, for example, a detached process. If you want a created process to continue after the parent exits, or not to share resources with the parent, use a detached process.

Table 2–1 compares the characteristics of subprocesses and detached processes.

**Table 2–1 Characteristics of Subprocesses and Detached Processes**

Characteristic	Subprocess	Detached Process
Privileges	Received from creating process	Specified by creating process
Quotas and limits	Shared with creating process	Specified by creating process, but not shared with creating process
User authorization file	Used for information not given by creating process	Used for most information not given by creating process

(continued on next page)

## Process Creation

### 2.1 Process Types

Table 2–1 (Cont.) Characteristics of Subprocesses and Detached Processes

Characteristic	Subprocess	Detached Process
User identification code	Received from creating process	Specified by creating process
Restrictions	Exist as long as creating process exists	None
How created	SYS\$CREPRC, or LIB\$SPAWN from another process	SYS\$CREPRC from another process
When deleted	At image exit, or when creating process exits. Note that if you use SYS\$CREPRC in place of LIB\$SPAWN, the context of the parent process is not propagated into the subprocess.	At image exit. Note that a LIB\$SPAWN routine can fail in a detached process because it is dependent upon and requires the presence of a command language interpreter (CLI).
Command language interpreter (CLI) present	Usually not if created with SYS\$CREPRC; usually yes if spawned	Usually not (though interactive user processes have CLI present, and they are created with SYS\$CREPRC)

## 2.2 Execution Context of a Process

The execution context of a process defines a process to the system and includes the following:

- Image that the process is executing
- Input and output streams for the image executing in the process
- Disk and directory defaults for the process
- System resource quotas and user privileges available to the process

When the system creates a detached process as the result of a login, it uses the system user authorization file (SYSUAF.DAT) to determine the process's execution context.

For example, the following occurs when you log in to the system:

1. The process created for you executes the image LOGINOUT.
2. The terminal you are using is established as the input, output, and error stream device for images that the process executes.
3. Your disk and directory defaults are taken from the user authorization file.
4. The resource quotas and privileges you have been granted by the system manager are associated with the created process.
5. A command language interpreter (CLI) is mapped into the created process.

## 2.3 Modes of Execution of a Process

A process executes in one of the following modes:

- Interactive—Receives input from a record-oriented device, such as a terminal or mailbox
- Batch—Is created by the job controller and is not interactive
- Network—Is created by the network ancillary control program (ACP)

- Other—Is not running in any of the other modes (for example, a spawned subprocess where input is received from a command procedure)

## 2.4 Creating a Subprocess

You can create a subprocess using either the LIB\$SPAWN run-time library routines, the SYS\$CREPRC system service, or the C system () call. A subprocess created with LIB\$SPAWN is called a spawned subprocess.

Table 2–2 lists the context values provided by LIB\$SPAWN, SYS\$CREPRC, and the C system () call for a subprocess when you are using the default values in the routine calls.

**Table 2–2 Comparison of LIB\$SPAWN, SYS\$CREPRC, and C system() Call Context Values**

Context	LIB\$SPAWN	SYS\$CREPRC	C system ()
DCL	Yes	No <sup>1</sup>	Yes
Default device and directory	Parent's	Parent's	Parent's
Symbols	Parent's	No	Parent's
Logical names	Parent's <sup>2</sup>	No <sup>2</sup>	Parent's <sup>2</sup>
Privileges	Parent's	Parent's	Parent's
Priority	Parent's	0	Parent's

<sup>1</sup>The created subprocess can include DCL by executing the system image SYS\$SYSTEM:LOGINOUT.EXE.

<sup>2</sup>Plus group and job logical name tables.

### 2.4.1 Using LIB\$SPAWN to Create a Spawned Subprocess

The LIB\$SPAWN routine enables you to create a subprocess and to set some context options for the new subprocess. LIB\$SPAWN creates a subprocess with the same priority as the parent process (generally priority 4). The format for LIB\$SPAWN is:

```
LIB$SPAWN ([command_string],[input_file],
, [output_file],[flags],[process-name],[process_id],[completion_status]
, [completion_efn],[completion_astadr],[completion_astarg],[prompt],[cli])
```

For complete information on using each argument, refer to the LIB\$SPAWN routine in *OpenVMS RTL Library (LIB\$) Manual*.

#### Specifying a Command String

Use the **command\_string** argument to specify a single DCL command to execute once the subprocess is initiated. You can also use this argument to execute a command procedure that, in turn, executes several DCL commands (*@command\_procedure\_name*).

#### Redefining SYS\$INPUT and SYS\$OUTPUT

Use the **input\_file** and **output\_file** arguments to specify alternate input and output devices for SYS\$INPUT and SYS\$OUTPUT. Using alternate values for SYS\$INPUT and SYS\$OUTPUT can be particularly useful when you are synchronizing processes that are executing concurrently.

## Process Creation

### 2.4 Creating a Subprocess

#### Passing Parent Process Context Information to the Subprocess

Use the **flags** argument to specify which characteristics of the parent process are to be passed on to the subprocess. With this argument, you can reduce the time required to create a subprocess by passing only a part of the parent's context. You can also specify whether the parent process should continue to execute (execute concurrently) or wait until the subprocess has completed execution (execute in line).

#### After the Subprocess Completes Execution

Use the **completion\_status**, **completion\_efn**, and **completion\_astadr** arguments to specify the action to be taken when the subprocess completes execution (send a completion status, set a local event flag, or invoke an AST procedure). For more information about event flags and ASTs, refer to Chapter 8.

The LIB\$SPAWN routine and SPAWN command do not return a completion status code of 0 from a subprocess command procedure.

The LIB\$SPAWN routine can fail in a detached process as well, because it is dependent upon and requires the presence of a command language interpreter (CLI), such as DCL. Without a CLI present in the current process, this call fails with a "NOCLI, no CLI present to perform function" error. Note that a detached process typically does not have a CLI present.

You can use SYS\$CREPRC in place of LIB\$SPAWN; though with SYS\$CREPRC the context of the parent process (symbols and logical names) is not propagated into the subprocess.

When using LIB\$SPAWN asynchronously (with CLI\$M\_NOWAIT), you have to synchronize completion. For if the parent process should exit, all subprocesses exit, potentially resulting in an unexpected series of failures of all subprocesses of the exiting parent process.

#### Specifying an Alternate Prompt String

Use the **prompt** argument to specify a prompt string for the subprocess.

#### Specifying an Alternate Command Language Interpreter

Use the **cli** argument to specify a command language interpreter for the subprocess. To create a detached process with a **cli**, you must either specify LOGINOUT as the target image, or use calls from images that are running in an "interactive", "batch", or "other" mode process.

#### Examples of Creating Subprocesses

The following examples create a subprocess that executes the commands in the COMMANDS.COM command procedure, which must be a command procedure on the current default device in the current default directory. The created subprocess inherits symbols, logical names (including SYS\$INPUT and SYS\$OUTPUT), keypad definitions, and other context information from the parent. The subprocess executes while the parent process hibernates.

```
! Declare status and library routine
INTEGER STATUS, LIB$SPAWN

STATUS = LIB$SPAWN ('@COMMANDS')
```

## Process Creation 2.4 Creating a Subprocess

The equivalent C code follows:

```
#include <descrip.h>
#include <lib$routines.h>
#include <ssdef.h>
#include <stsdef.h>
main()
{
    int RetStat;
    $DESCRIPTOR( CmdDsc, "@COMMANDS" );
    RetStat = lib$spawn( &CmdDsc );
    if (!$VMS STATUS SUCCESS( RetStat ))
        return RetStat;
    return SS$ _NORMAL;
}
```

The following Fortran program segment creates a subprocess that does not inherit the parent's symbols, logical names, or keypad definitions. The subprocess reads and executes the commands in the COMMANDS.COM command procedure. (The *CLI\$* symbols are defined either in the \$CLIDEF module of the system object or in shareable image library. See Chapter 26 for more information.)

```
! Mask for LIB$SPAWN
INTEGER MASK
EXTERNAL CLI$M_NOCLISYM,
2      CLI$M_NOLOGNAM,
2      CLI$M_NOKEYPAD
! Declare status and library routine
INTEGER STATUS, LIB$SPAWN

! Set mask and call LIB$SPAWN
MASK = %LOC(CLI$M_NOCLISYM) .OR.
2      %LOC(CLI$M_NOLOGNAM) .OR.
2      %LOC(CLI$M_NOKEYPAD)

STATUS = LIB$SPAWN ('@COMMANDS.COM',
2
2      MASK)
```

The equivalent C program follows:

```
#include <clidef.h>
#include <descrip.h>
#include <lib$routines.h>
#include <ssdef.h>
#include <stsdef.h>
main()
{
    int RetStat;
    int FlagsMask = CLI$M_NOCLISYM | CLI$M_NOLOGNAM | CLI$M_NOKEYPAD;
    $DESCRIPTOR( CmdDsc, "@COMMANDS.COM" );
    RetStat = lib$spawn( &CmdDsc, 0, 0, &FlagsMask );
    if (!$VMS STATUS SUCCESS( RetStat ))
        return RetStat;
    return SS$ _NORMAL;
}
```

The following Fortran program segment creates a subprocess to execute the image \$DISK1:[USER.MATH]CALC.EXE. CALC, reads data from DATA84.IN, and writes the results to DATA84.RPT. The subprocess executes concurrently. (CLI\$M\_NOWAIT is defined in the \$CLIDEF module of the system object or shareable image library; see Chapter 26.)

## Process Creation

### 2.4 Creating a Subprocess

```
! Mask for LIB$SPAWN
EXTERNAL CLIS$M_NOWAIT
! Declare status and library routine
INTEGER STATUS, LIB$SPAWN

STATUS = LIB$SPAWN ('RUN $DISK1:[USER.MATH]CALC', ! Image
2              'DATA84.IN', ! Input
2              'DATA84.RPT', ! Output
2              %LOC(CLIS$M_NOWAIT)) ! Concurrent
```

The C version of the example follows:

```
#include <clidef.h>
#include <descrip.h>
#include <lib$routines.h>
#include <ssdef.h>
#include <stsdef.h>
main()
{
    int RetStat;
    int FlagsMask = CLIS$M_NOWAIT;
    $DESCRIPTOR( CmdDsc, "RUN $DISK1:[USER.MATH]CALC" );
    $DESCRIPTOR( InpDsc, "DATA84.IN" );
    $DESCRIPTOR( OutDsc, "DATA84.RPT" );
    RetStat = lib$spawn( &CmdDsc, &InpDsc, &OutDsc, &FlagsMask );
    if (!$VMS STATUS SUCCESS( RetStat ))
        return RetStat;
    return SS$ _NORMAL;
}
```

#### 2.4.2 Using the C system() Call

The following example shows the calling of a C system() function:

```
#include <ssdef.h>
#include <stdio.h>
#include <stdlib.h>
main()
{
    printf("calling system() \n");
    system("show system");
    printf("done\n");
    return SS$ _NORMAL;
}
```

This example shows how to call a system to spawn a DCL SHOW SYSTEM command, and subsequently returns and continues the execution of the main() image.

#### 2.4.3 Using SYS\$CREPRC to Create a Subprocess

The Create Process (SYS\$CREPRC) system service creates both subprocesses and detached processes. This section discusses creating a subprocess; Section 2.5 describes creating a detached process. When you call the SYS\$CREPRC system service to create a process, you define the context by specifying arguments to the service. The number of subprocesses a process can create is controlled by its PQL\$\_PRCLM subprocess quota, an individual quota description under the **quota** argument. The IMPERSONATE privilege controls your ability to create a detached process with a user identification code (UIC) that is different from the UIC of the creating process.

## Process Creation 2.4 Creating a Subprocess

With SYS\$CREPRC, you must usually specify the priority because the default priority is zero. Though SYS\$CREPRC does not set many context values for the subprocess by default, it does allow you to set many more context values than LIB\$SPAWN. For example, you cannot specify separate privileges for a subprocess with LIB\$SPAWN directly, but you can with SYS\$CREPRC.

By default, SYS\$CREPRC creates a subprocess rather than a detached process. The format for SYS\$CREPRC is as follows:

```
SYS$CREPRC ([pidadr] ,[image] ,[input] ,[output] ,[error] ,[prvadr] ,[quota]
            ,[prcnam] ,[baspri] ,[uic] ,[mbxunt] ,[stsflg] ,[itemlst] ,[node])
```

Ordinarily, when you create a subprocess, you need only assign it an image to execute and, optionally, the SYS\$INPUT, SYS\$OUTPUT, and SYS\$ERROR devices. The system provides default values for the process's privileges, resource quotas, execution modes, and priority. In some cases, however, you may want to define these values specifically. The arguments to the SYS\$CREPRC system service that control these characteristics follow. For details, see the descriptions of arguments to the SYS\$CREPRC system service in the *OpenVMS System Services Reference Manual*.

The default values passed into the subprocess might not be complete enough for your use. The following sections describe how to modify these default values with SYS\$CREPRC.

### Redefining SYS\$INPUT, SYS\$OUTPUT, and SYS\$ERROR

Use the **input**, **output**, and **error** arguments to specify alternate input, output, and error devices for SYS\$INPUT, SYS\$OUTPUT, and SYS\$ERROR. Using alternate values for SYS\$INPUT, SYS\$OUTPUT, and SYS\$ERROR can be particularly useful when you are synchronizing processes that are executing concurrently. By providing alternate or equivalent names for the logical names SYS\$INPUT, SYS\$OUTPUT, and SYS\$ERROR, you can place these logical name/equivalence name pairs in the process logical name table for the created process.

The following C program segment is an example of defining input, output, and error devices for a subprocess:

```
#include <descrip.h>
#include <ssdef.h>
#include <starlet.h>
#include <stdio.h>
#include <stsdef.h>
// Comment syntax used here assumes Compaq C compiler support (eg: V6.2)
main()
{
    int RetStat;
    $DESCRIPTOR(input,"SUB_MAIL_BOX"); // Descriptor for input stream
    $DESCRIPTOR(output,"COMPUTE_OUT"); // Descriptor for output and error
    $DESCRIPTOR(image,"COMPUTE.EXE"); // Descriptor for image name

    // Create the subprocess
    RetStat = sys$creprc( 0, // process id
                        &image, // image
                        &input, ① // input SYS$INPUT device
                        &output, ② // output SYS$OUTPUT device
                        &output, ③ // error SYS$ERROR device
                        0,0,0,0,0,0,0);
    if (!$VMS STATUS SUCCESS( RetStat ))
        return RetStat;
```

## Process Creation

### 2.4 Creating a Subprocess

```
    return SS$_NORMAL;  
  }  
}
```

- ❶ The **input** argument equates the equivalence name SUB\_MAIL\_BOX to the logical name SYS\$INPUT. This logical name may represent a mailbox that the calling process previously created with the Create Mailbox and Assign Channel (SYS\$CREMBX) system service. Any input the subprocess reads from the logical device SYS\$INPUT is from the mailbox.
- ❷ The **output** argument equates the equivalence name COMPUTE\_OUT to the logical name SYS\$OUTPUT. All messages the program writes to the logical device SYS\$OUTPUT are to this file. When a workstation (WSAO) device is specified with LOGINOUT as the image, the target (created) process receives the specified workstation as its DECwindows default display (DECW\$DISPLAY).
- ❸ The **error** argument equates the equivalence name COMPUTE\_OUT to the logical name SYS\$ERROR. All system-generated error messages are written into this file. Because this is the same file as that used for program output, the file effectively contains a complete record of all output produced during the execution of the program image.

The SYS\$CREPRC system service does not provide default equivalence names for the logical names SYS\$INPUT, SYS\$OUTPUT, and SYS\$ERROR. If none are specified, any entries in the group or system logical name tables, if any, may provide equivalences. If, while the subprocess executes, it reads or writes to one of these logical devices and no equivalence name exists, an error condition results.

The SYS\$CREPRC system service also does not provide default equivalence names for the logical names SYS\$LOGIN, SYS\$LOGIN\_DEVICE, and SYS\$SCRATCH. These logical names are available to the created process only when the specified image is LOGINOUT, and when the PRC\$M\_NOUAF flag is *not* set.

In a program that creates a subprocess, you can cause the subprocess to share the input, output, or error device of the creating process. You must first follow these steps:

1. Use the Get Device/Volume Information (SYS\$GETDVIW) system service to obtain the device name for the logical name SYS\$INPUT, SYS\$OUTPUT, or SYS\$ERROR.
2. Specify the address of the descriptor returned by the SYS\$GETDVIW service when you specify the **input**, **output**, or **error** argument to the SYS\$CREPRC system service.

This procedure is illustrated in the following example:



## Process Creation 2.4 Creating a Subprocess

```
#include <descrip.h>
#include <dvidf.h>
#include <efndef.h>
#include <lib$routines.h>
#include <prcdef.h>
#include <ssdef.h>
#include <starlet.h>
#include <stdio.h>
#include <stsdef.h>
// Comment syntax used here assumes Compaq C compiler support (eg: V6.2)
main()
{
#define MAXTERMLEN 64
#define MAXITMLST 3
    char TermName[MAXTERMLEN];
    int BasPri = 4;
    int RetStat;
    int TermLen;
    unsigned short int IOSB[4];

    // ItemList data structures used to acquire device name
    int i;
    struct
    {
        unsigned short int BufLen;
        unsigned short int ItmCod;
        void *BufAdr;
        void *BufRLA;
    } ItmLst[2];

    // Descriptors for sys$getdviw call
    $DESCRIPTOR( SysInput, "SYS$INPUT" );

    // Descriptors for sys$creprc call
    $DESCRIPTOR( ImageDesc, "SYS$SYSTEM:LOGINOUT.EXE" );
    struct dsc$descriptor TermDesc =
        { MAXTERMLEN, DSC$K_DTYPE_T, DSC$K_CLASS_S, TermName };

    // Assign values to the item list
    i = 0;
    ItmLst[i].BufLen = MAXTERMLEN;
    ItmLst[i].ItmCod = DVI$_DEVNAM;
    ItmLst[i].BufAdr = &TermLen;
    ItmLst[i+1].BufRLA = NULL;
    ItmLst[i].BufLen = 0;
    ItmLst[i].ItmCod = 0;
    ItmLst[i].BufAdr = NULL;
    ItmLst[i+1].BufRLA = NULL;

    // Acquire the terminal device name
    RetStat = sys$getdviw(
        EFN$_ENF, // no event flag needed here
        0, // Channel (not needed here)
        &SysInput, // Device Name
        ItmLst, // item list
        IOSB, // Address of I/O Status Block
        0,0,0);

    if (!$VMS_STATUS_SUCCESS( RetStat ))
        lib$signal( RetStat );
    if (!$VMS_STATUS_SUCCESS( IOSB[0] ))
        lib$signal( IOSB[0] );
}
```

## Process Creation

### 2.4 Creating a Subprocess

```
// Create the subprocess
RetStat = sys$creprc(
    0,
    &ImageDesc,    // The image to be run
    &TermDesc,     // Input (SYS$INPUT device)
    &TermDesc,     // Output (SYS$OUTPUT device)
    &TermDesc,     // Error (SYS$ERROR device)
    0,0,0,
    &BasPri,       // Process base priority
    0,0,0);
if (!$VMS_STATUS_SUCCESS( RetStat ))
    lib$signal( RetStat );

return SS$ _NORMAL;
}
```

In this example, the subprocess executes, and the logical names SYS\$INPUT, SYS\$OUTPUT, and SYS\$ERROR are equated to the device name of the logical input device of the creating process. The subprocess can then do one of the following:

- Use OpenVMS RMS to open the device for reading or writing, or both.
- Use the Assign I/O Channel (SYS\$ASSIGN) system service to assign an I/O channel to the device for input/output operations.

In the following example, the program assigns a channel to the device specified by the logical name SYS\$OUTPUT:

```
int RetStat;
unsigned short int IOchan;
$DESCRIPTOR(DevNam, "SYS$OUTPUT");
.
.
.
RetStat = sys$assign( &DevNam,          /* Device name */
                    &IOchan,         /* Channel */
                    0, 0, 0);
if (!$VMS_STATUS_SUCCESS( RetStat ))
    return RetStat;
```

For more information about channel assignment for I/O operations, see Chapter 23.

#### Setting Privileges

Set different privileges by defining the privilege list for the subprocess using the **prvadr** argument. This is particularly useful when you want to dedicate a subprocess to execute privileged or sensitive code. If you do not specify this argument, the privileges of the calling process are used. If you specify the **prvadr** argument, only the privileges specified in the bit mask are used; the privileges of the calling process are not used. For example, a creating process has the user privileges GROUP and TMPMBX. It creates a process, specifying the user privilege TMPMBX. The created process receives only the user privilege TMPMBX; it does not have the user privilege GROUP.

If you need to create a process that has a privilege that is not one of the privileges of your current process, you must have the user privilege SETPRV.

Symbols associated with privileges are defined by the \$PRVDEF macro. Each symbol begins with PRV\$\_ and identifies the bits in the bit mask that must be set to specify a given privilege. The following example shows the data definition for a bit mask specifying the GRPNAM and GROUP privileges:

## Process Creation

### 2.4 Creating a Subprocess

```
unsigned int PrivQuad[2] = { (PRV$M_GRPNAM | PRV$M_GROUP), 0};
// OpenVMS Alpha could also use: __int64 PrivQuad = PRV$M_GRPNAM | PRV$M_GROUP;
```

#### Setting Process Quotas

Set different process quotas by defining the quota list of system resources for the subprocess using the **quota** argument. This option can be useful when managing a subprocess to limit use of system resources (such as AST usage, I/O, CPU time, lock requests, and working set size and expansion). If you do not specify this argument, the system defines default quotas for the subprocess.

The following example shows how to construct the process quota array for the SYS\$CREPRC call using Compaq C, and particularly how to avoid problems on OpenVMS Alpha due to the default use of member alignment. Without the `nomember_alignment` setting, there would be three pad bytes embedded within each element of the array, and SYS\$CREPRC would not perform as expected.

```
#pragma environment save
#pragma nomember_alignment
struct
{
    unsigned char pql_code;
    unsigned long int pql_value;
} pql[] =
{
    { PQL$_ASTLM,      600    },
    { PQL$_BIOLM,     100    },
    { PQL$_BYTLM,    131072  },
    { PQL$_CPULM,      0     },
    { PQL$_DIOLM,     100    },
    { PQL$_FILLM,     50     },
    { PQL$_PGFLQUOTA, 40960  },
    { PQL$_PRCLM,     16     },
    { PQL$_TQELM,     600    },
    { PQL$_WSDEFAULT, 512    },
    { PQL$_WSQUOTA,   2048   },
    { PQL$_ENQLM,     600    },
    { PQL$_WSEXTENT, 4096   },
    { PQL$_JTQUOTA,   4096   },
    { PQL$_LISTEND,   0     }
};
#pragma environment restore
```

For more information about process quotas and process quota lists, see Section 2.6.

#### Setting the Subprocess Priority

Set the subprocess priority by setting the base execution priority with the **baspri** argument. If you do not set the subprocess priority, the priority defaults to 2 for VAX MACRO and VAX BLISS-32 and to 0 for all other languages. If you want a subprocess to have a higher priority than its creator, you must have the user privilege ALTPRI to raise the priority level.

#### Specifying Additional Processing Options

Enable and disable parent and subprocess wait mode, control process swapping, control process accounting, control process dump information, control authorization checks, and control working set adjustments using the **stsflg** argument. This argument defines the status flag, a set of bits that controls some execution characteristics of the created process, including resource wait mode and process swap mode.

## Process Creation

### 2.4 Creating a Subprocess

#### Defining an Image for a Subprocess to Execute

When you call the SYS\$CREPRC system service, use the **image** argument to provide the process with the name of an image to execute. For example, the following lines of C create a subprocess to execute the image named CARRIE.EXE:

```
    $DESCRIPTOR(image, "CARRIE");  
    .  
    .  
    .  
    RetStat = sys$creprc(0, &image, . . . );
```

In this example, only a file name is specified; the service uses current disk and directory defaults, performs logical name translation, uses the default file type .EXE, and locates the most recent version of the image file. When the subprocess completes execution of the image, the subprocess is deleted. Process deletion is described in Chapter 4.

#### 2.4.3.1 Disk and Directory Defaults for Created Processes

When you use the SYS\$CREPRC system service to create a process to execute an image, the system locates the image file in the default device and directory of the created process. Any created process inherits the current default device and directory of its creator.

If a created process runs an image that is not in its default directory, you must identify the directory and, if necessary, the device in the file specification of the image to be run.

There is no way to define a default device or directory for the created process that is different from that of the creating process in a call to SYS\$CREPRC. The created process can, however, define an equivalence for the logical device SYS\$DISK by calling the Create Logical Name (\$CRELNM) system service.

If the process is a subprocess, you, in the creating process, can define an equivalence name in the group logical name table, job logical name table, or any logical name table shared by the creating process and the subprocess. The created process then uses this logical name translation as its default directory. The created process can also set its own default directory by calling the OpenVMS RMS default directory system service, SYS\$SETDDIR.

A process can create a process with a default directory that is different from its own by completing the following steps in the creating process:

1. Make a call to SYS\$SETDDIR to change its own default directory.
2. Make a call to SYS\$CREPRC to create the new process.
3. Make a call to SYS\$SETDDIR to change its own default directory back to the default directory it had before the first call to SYS\$SETDDIR.

The creating process now has its original default directory. The new process has the different default directory that the creating process had when it created the new process. If the default device is to change, you must also redefine the SYS\$DISK logical name. For details on how to call SYS\$SETDDIR, see the *OpenVMS System Services Reference Manual*.

## 2.5 Creating a Detached Process

The creation of a detached process is primarily a task the operating system performs when you log in. In general, an application creates a detached process only when a program must continue executing after the parent process exits. To do this, you should use the SYS\$CREPRC system service. You can also use detached processes to write to the terminal of another process by using the SYS\$BREAKTHRU system service.

The IMPERSONATE privilege controls the ability to create a detached process with a UIC that is different from the UIC of the creating process. You can use the **uic** argument to the SYS\$CREPRC system service to define whether a process is a subprocess or a detached process. The **uic** argument provides the created process with a user identification code (UIC). If you omit the **uic** argument, the SYS\$CREPRC system service creates a subprocess that executes under the UIC of the creating process.

You can also create a detached process with the same UIC as the creating process by specifying the detach flag in the **stsfld** argument. You do not need the IMPERSONATE privilege to create a detached process with the same UIC as the creating process.

### Examples of Creating a Detached Process

The following Fortran program segment creates a process that executes the image SYS\$USER:[ACCOUNT]INCTAXES.EXE. INCTAXES reads input from the file TAXES.DAT and writes output to the file TAXES.RPT. (TAXES.DAT and TAXES.RPT are in the default directory on the default disk.) The last argument specifies that the created process is a detached process (the UIC defaults to that of the parent process). (The symbol PRC\$M\_DETACH is defined in the \$PRCDEF module of the system macro library.)

```
EXTERNAL  PRC$M_DETACH

! Declare status and system routines
INTEGER STATUS, SYS$CREPRC
      .
      .
STATUS = SYS$CREPRC (,
2      'SYS$USER:[ACCOUNT]INCTAXES', ! Image
2      'TAXES.DAT',                  ! SYS$INPUT
2      'TAXES.RPT',                  ! SYS$OUTPUT
2      '','','',
2      %VAL(4),                       ! Priority
2      '','',
2      %VAL(%LOC(PRC$M_DETACH))      ! Detached
```

The following program segment creates a detached process to execute the DCL commands in the command file SYS\$USER:[TEST]COMMANDS.COM. The system image SYS\$SYSTEM:LOGINOUT.EXE is executed to include DCL in the created process. The DCL commands to be executed are specified in a command procedure that is passed to SYS\$CREPRC as the input file. Output is written to the file SYS\$USER:[TEST]OUTPUT.DAT.

## Process Creation

### 2.5 Creating a Detached Process

```

      .
      .
      .
STATUS = SYS$CREPRC (,
2      'SYS$SYSTEM:LOGINOUT',          ! Image
2      'SYS$USER:[TEST]COMMANDS.COM', ! SYS$INPUT
2      'SYS$USER:[TEST]OUTPUT.DAT',   ! SYS$OUTPUT
2      '','','',
2      %VAL(4),                        ! Priority
2      '','',
2      %VAL(%LOC(PRC$M_DETACH))       ! Detached

```

### 2.6 Process Quota Lists

The SYS\$CREPRC system service uses the **quota** argument to create a process quota list (PQL). Individual quota items such as paging file quota (PQL\_PGFLQUOTA) and timer queue entry quota (PQL\_TQELM) of the SYS\$CREPRC system service make up the PQL. In allocating the PQL, SYS\$CREPRC constructs a default PQL for the process being created, assigning it the default values for all individual quota items. Default values are SYSGEN parameters and so can be changed from system to system. SYS\$CREPRC then reads the specified quota list, if any is indicated, and updates the corresponding items in the default PQL. Any missing values are filled in from the default items (PQL\_Dxxxxx) SYSGEN parameter, where xxxxx are the characters of the quota name that follow PQL\$\_ in the quota name. The PQL is then complete.

The SYS\$CREPRC service next reads the PQL, comparing each value against the corresponding minimum (PQL\_Mxxxxx) SYSGEN parameter. If the SYSGEN parameter is greater than the resulting value, SYS\$CREPRC replaces it with the SYSGEN value. Thus no process on the system has a quota value lower than the minimum (PQL\_Mxxxxx) SYSGEN parameter. Since all PQL individual quota items are dynamic, you can change the values in SYSGEN.

The SYS\$CREPRC service also determines what kind of process the PQL belongs to, whether batch, interactive, or detached. If it is a batch or interactive process, the process derives all its quotas from the user authorization file (UAF) and completely overwrites the PQL. These quotas are unaffected by the default (PQL\_Dxxxxx) SYSGEN parameters, but are affected by the minimum (PQL\_Mxxxxx) values. If the process is a detached process, it determines what items have been passed in the quota list and only then overwrites these items in the PQL. SYS\$CREPRC never reads the PQL it is creating until it has completed it and then goes to the final pass making sure its values are greater than the minimum (PQL\_Mxxxxx) values.

With subprocesses some quotas are pooled, for instance, PQL\_PGFLQUOTA and PQL\_TQELM. SYS\$CREPRC establishes pooled quotas when it creates a detached process, and they are shared by that process and all its descendent subprocesses. All the related processes report the same quota as they are accessing a common location in the job information block (JIB).

To determine the maximum virtual page count of the paging file quota of a process, use the JPI\$\_PGFLQUOTA item code of the SYS\$GETJPI system service. The JPI\$\_PGFLQUOTA on VAX systems returns the longword integer value of the paging file quota in pages; on Alpha systems, it returns the longword integer value of the paging file quota in pagelets.

To determine the remaining paging file quota of the process, use the JPI\$\_PAGFILCNT item code of the SYS\$GETJPI system service. The JPI\$\_PAGFILCNT on VAX systems returns the longword integer value of the paging file quota in pages; on Alpha systems, it returns the longword integer value of the paging file quota in pagelets.

For a complete description of quotas, see the *OpenVMS System Services Reference Manual: A-GETUAI*.

## 2.7 Debugging a Subprocess or a Detached Process

You have several ways to debug a subprocess or a detached process including the following:

- Using DBG\$ logical names
- Using the workstation device (see Section 2.4.3)
- Using a DECwindows DECterm display

### DBG\$ Logical Names

You can allow a program to be debugged within a subprocess or a detached process by using DBG\$INPUT and DBG\$OUTPUT. To allow debug operations with DBG\$INPUT and DBG\$OUTPUT, equate the subprocess logical names DBG\$INPUT and DBG\$OUTPUT to the terminal. When the subprocess executes the program, which has been compiled and linked with the debugger, the debugger reads input from DBG\$INPUT and writes output to DBG\$OUTPUT.

If you are executing the subprocess concurrently, you should restrict debugging to the program in the subprocess. The debugger prompt DBG> should enable you to differentiate between input required by the parent process and input required by the subprocess. However, each time the debugger displays information, you must press the Return key to display the DBG> prompt. (By pressing the Return key, you actually write to the parent process, which has regained control of the terminal following the subprocess's writing to the terminal. Writing to the parent process allows the subprocess to regain control of the terminal.)

### DECwindows DECterm Display

If you have DECwindows installed, you can use display for debugging a subprocess or detached process. The following debugging example with DECterm shows how to create a DECterm display, and pass it into the SYS\$CREPRC call for use with an application that is built using the OpenVMS Debugger:

```
#pragma module CREATE_DECTERM
#include <descrip.h>
#include <lib$routines.h>
#include <pqldef.h>
#include <prcdef.h>
#include <ssdef.h>
#include <starlet.h>
#include <stsdef.h>

// Comment syntax used here assumes Compaq C compiler support (eg: V6.2)

// To build and run:
// $ cc CREATE_DECTERM
// $ link CREATE_DECTERM,sys$input/option
// sys$share:DECW$TERMINALSHR.EXE/share
// $ run CREATE_DECTERM

// This routine is not declared in a currently-available library
extern int decw$term_port(void *,...);
```

## Process Creation

### 2.7 Debugging a Subprocess or a Detached Process

```
main( void )
{
    int RetStat;
    int StsFlg;
    int DbgTermLen = 0;
#define DBGTERMBUFLEN 50
    char DbgTermBuf[DBGTERMBUFLEN];
    $DESCRIPTOR( Customization,
"DECW$TERMINAL.iconName:\tDebugging Session\n\
DECW$TERMINAL.title:\tDebugging Session" );
    $DESCRIPTOR( Command, "SYS$SYSDEVICE:[HOFFMAN]DEBUG_IMAGE.EXE" );
    struct dsc$dscdescriptor DbgTerm;

    DbgTerm.dsc$w_length = DBGTERMBUFLEN;
    DbgTerm.dsc$b_dtype = DSC$K_DTYPE_T;
    DbgTerm.dsc$b_class = DSC$K_CLASS_S;
    DbgTerm.dsc$a_pointer = DbgTermBuf;

    // Request creation of a DECTerm display
    RetStat = decw$term_port(
        0, // display (use default)
        0, // setup file (use default)
        &Customization, // customization
        &DbgTerm, // resulting device name
        &DbgTermLen, // resulting device name length
        0, // controller (use default)
        0, // char buffer (use default)
        0 ); // char change buffer (default)
    if ( !$VMS_STATUS_SUCCESS (RetStat) )
        lib$signal( RetStat );

    DbgTerm.dsc$w_length = DbgTermLen;

    // Create the process as detached.
    StsFlg = PRC$M_DETACH;

    // Now create the process
    RetStat = sys$creprc(
        0, // PID
        &Command, // Image to invoke
        &DbgTerm, // Input
        &DbgTerm, // Output
        0, 0, 0, 0, 0, 0, 0, 0,
        StsFlg ); // Process creation flags
    if ( !$VMS_STATUS_SUCCESS( RetStat ) )
        lib$signal( RetStat );

    return SS$ _NORMAL;
}
```



## 2.8 Kernel Threads and the Kernel Threads Process Structure (Alpha Only)

### 2.8 Kernel Threads and the Kernel Threads Process Structure (Alpha Only)

This section defines and describes some advantages of using kernel threads. It also describes some kernel threads features and type of model, as well as the design changes made to the OpenVMS operating system.

---

**Note**

---

For information about the concepts and implementation of user threads with Compaq POSIX Threads Library, see the *Guide to the POSIX Threads Library*.

---

#### 2.8.1 Definition and Advantages of Kernel Threads

A **thread** is a single, sequential flow of execution within a process's address space. A single process contains an address space wherein either a single thread or multiple threads execute concurrently. Programs typically have a single flow of execution and therefore a single thread; whereas multithreaded programs have multiple points of execution at any one time.

By using threads as a programming model, you can gain the following advantages:

- More modular code design
- Simpler application design and maintenance
- The potential to run independent flows of execution in parallel on multiple CPUs
- The potential to make better use of available CPU resources through parallel execution

#### 2.8.2 Kernel Threads Features

With kernel threads, the OpenVMS operating system implements the following two features:

- Multiple execution contexts within a process
- Efficient use of the OpenVMS and POSIX Threads Library schedulers

##### 2.8.2.1 Multiple Execution Contexts Within a Process

Before the implementation of kernel threads, the scheduling model for the OpenVMS operating system was per process. The only scheduling context was the process itself, that is, only one execution context per process. Since a threaded application could create thousands of threads, many of these threads could potentially be executing at the same time. But because OpenVMS processes had only a single execution context, in effect, only one of those application threads was running at any one time. If this multithreaded application was running on a multiprocessor system, the application could not make use of more than a single CPU.

After the implementation of kernel threads, the scheduling model allows for multiple execution contexts within a process; that is, more than one application thread can be executing concurrently. These execution contexts are called kernel threads. Kernel threads allow a multithreaded application to have a thread executing on every CPU in a multiprocessor system. Kernel threads, therefore,

## Process Creation

### 2.8 Kernel Threads and the Kernel Threads Process Structure (Alpha Only)

allow a threaded application to take advantage of multiple CPUs in a symmetric multiprocessing (SMP) system.

In the initial release of kernel threads, OpenVMS allowed a maximum of 16 kernel threads per process. This enabled an application to have threads executing on up to 16 CPUs at one time. With OpenVMS Alpha Version 7.2, the number of kernel threads that can be created per-process increased to 256. The maximum value for the MULTITHREAD system parameter has also increased to 256.

#### 2.8.2.2 Efficient Use of the OpenVMS and POSIX Threads Library Schedulers

The user mode thread manager schedules individual user mode application threads. On OpenVMS, POSIX Threads Library is the user mode threading package of choice. Before the implementation of kernel threads, POSIX Threads Library multiplexed user mode threads on the single OpenVMS execution context—the process. POSIX Threads Library implemented parts of its scheduling by using a periodic timer. When the AST executed and the thread manager gained control, the thread manager could then select a new application thread for execution. But because the thread manager could not detect that a thread had entered an OpenVMS wait state, the entire application blocked until that periodic AST was delivered. That resulted in a delay until the thread manager regained control and could schedule another thread. Once the thread manager gained control, it could schedule a previously preempted thread unaware that the thread was in a wait state. The lack of integration between the OpenVMS and POSIX Threads Library schedulers could result in wasted CPU resources.

After the implementation of kernel threads, the scheduling model provides for scheduler callbacks, which is not the default. A scheduler callback is an upcall from the OpenVMS scheduler to the thread manager whenever a thread changes state. This upcall allows the OpenVMS scheduler to inform the thread manager that the current thread is stalled and that another thread should be scheduled. Upcalls also inform the thread manager that an event a thread is waiting on has completed. With kernel threads, the two schedulers are better integrated, minimizing application thread scheduling delays.

#### 2.8.2.3 Terminating a POSIX Threads Image

To avoid hangs or a disorderly shutdown of a multithreaded process, Compaq recommends that you issue an upcall with an EXIT command at the DCL prompt (\$). This procedure causes a normal termination of the image currently executing. If the image declared any exit-handling routines, for instance, they are then given control. The exit handlers are run in a separate thread, which allows them to be synchronized with activities in other threads. This allows them to block without danger of entering a self-deadlock due to the handler having been involved in a context which already held resources.

The effect of calling the EXIT command on the calling thread is the same as calling pthread\_exit(): the caller's stack is unwound and the thread is terminated. This allows each frame on the stack to have an opportunity to be notified and to take action during the termination, so that it can then release any resource which it holds that might be required for an exit handler. By using upcalls, you have a way out of self-deadlock problems that can impede image shutdown.

## 2.8 Kernel Threads and the Kernel Threads Process Structure (Alpha Only)

You can optionally perform a shutdown by using the control y EXIT (Ctrl-Y/EXIT) command. By doing this and with upcalls enabled, you release the exit handler thread. All other threads continue to execute untouched. This removes the possibility of the self-deadlock problem which is common when you invoke exit handlers asynchronously in an existing context. However, by invoking exit handlers, you do not automatically initiate any kind of implicit shutdown of the threads in the process. Because of this, it is up to the application to request explicitly the shutdown of its threads from its exit handler and to ensure that their shutdown is complete before returning from the exit handler. By having the application do this, you ensure that subsequent exit handlers do not encounter adverse operating conditions, such as threads which access files after they've been closed, or the inability to close files because they are being accessed by threads.

Along with using control y EXIT (Ctrl-Y/EXIT) to perform shutdowns, you can issue a control y (Ctrl-Y/STOP) command. If you use a control y STOP (Ctrl-Y/STOP) command, it is recommended that you do this with upcalls. To use a control y STOP (Ctrl-Y/STOP) command, can cause a disorderly or unexpected outcome.

### 2.8.3 Kernel Threads Model and Design Features

This section presents the type of kernel threads model that OpenVMS Alpha implements, and some features of the operating system design that changed to implement the kernel thread model.

#### 2.8.3.1 Kernel Threads Model

The OpenVMS kernel threads model is one that implements a few kernel threads to many user threads with integrated schedulers. With this model, there is a mapping of many user threads to only several execution contexts or kernel threads. The kernel threads have no knowledge of the individual threads within an application. The thread manager multiplexes those user threads on an execution context, though a single process can have multiple execution contexts. This model also integrates the user mode thread manager scheduler with the OpenVMS scheduler.

#### 2.8.3.2 Kernel Threads Design Features

Design additions and modifications made to various features of OpenVMS Alpha are as follows:

- Process Structure
- Access to Inner Modes
- Scheduling
- ASTs
- Event Flags
- Process Control Services

**2.8.3.2.1 Process Structure** With the implementation of OpenVMS kernel threads, all processes are a threaded process with at least one kernel thread. Every kernel thread gets a set of stacks, one for each access mode. Quotas and limits are maintained and enforced at the process level. The process virtual address space remains per process and is shared by all threads. The scheduling entity moves from the process to the kernel thread. In general, ASTs are delivered directly to the kernel threads. Event flags and locks remain per process. See Section 2.8.4 for more information.

## Process Creation

### 2.8 Kernel Threads and the Kernel Threads Process Structure (Alpha Only)

**2.8.3.2.2 Access to Inner Modes** With the implementation of kernel threads, a single threaded process continues to function exactly as it has in the past. A multithreaded process may have multiple threads executing in user mode or in user mode ASTs, as is also possible for supervisor mode. Except in cases where an activity in inner mode is considered **thread safe**, a multithreaded process may have only a single thread executing in an inner mode at any one time. Multithreaded processes retain the normal preemption of inner mode by more inner mode ASTs. A special inner mode semaphore serializes access to inner mode.

**2.8.3.2.3 Scheduling** With the implementation of kernel threads, the OpenVMS scheduler concerns itself with kernel threads, and not processes. At certain points in the OpenVMS executive at which the scheduler could wait a kernel thread, it can instead transfer control to the thread manager. This transfer of control, known as a callback or upcall, allows the thread manager the chance to reschedule stalled application threads.

**2.8.3.2.4 ASTs** With the implementation of kernel threads, ASTs are not delivered to the process. They are delivered to the kernel thread on which the event was initiated. Inner mode ASTs are generally delivered to the kernel thread already in inner mode. If no thread is in inner mode, the AST is delivered to the kernel thread that initiated the event.

**2.8.3.2.5 Event Flags** With the implementation of kernel threads, event flags continue to function on a per-process basis, maintaining compatibility with existing application behavior.

**2.8.3.2.6 Process Control Services** With the implementation of kernel threads, many process control services continue to function at the process level. SYS\$SUSPEND and SYS\$RESUME system services, for example, continue to change the scheduling state of the entire process, including all of its threads. Other services such as SYS\$HIBER and SYS\$SCHDWK act on individual kernel threads instead of the entire process.

#### 2.8.4 Kernel Threads Process Structure

This section describes the components that make up a kernel threads process. It describes the following components:

- Process control block (PCB) and process header (PHD)
- Kernel thread block (KTB)
- Floating-point registers and execution data block (FRED)
- Kernel threads region
- Per-kernel thread stacks
- Per-kernel thread data cells
- Process status bits
- Kernel thread priorities

## 2.8 Kernel Threads and the Kernel Threads Process Structure (Alpha Only)

### 2.8.4.1 Process Control Block (PCB) and Process Header (PHD)

Two primary data structures exist in the OpenVMS executive that describe the context of a process:

- Software process control block (PCB)
- Process header (PHD)

The PCB contains fields that identify the process to the system. The PCB comprises contexts that pertain to quotas and limits, scheduling state, privileges, AST queues, and identifiers. In general, any information that is required to be resident at all times is in the PCB. Therefore, the PCB is allocated from nonpaged pool.

The PHD contains fields that pertain to a process's virtual address space. The PHD consists of the working set list and the process section table. The PHD also contains the hardware process control block (HWPCB) and a floating-point register save area. The HWPCB contains the hardware execution context of the process. The PHD is allocated as part of a balance set slot, and it can be outswapped.

**2.8.4.1.1 Effect of a Multithreaded Process on the PCB and PHD** With multiple execution contexts within the same process, the multiple threads of execution all share the same address space, but have some independent software and hardware context. This change to a multithreaded process results in an impact on the PCB and PHD structures, and on any code that references them.

Before the implementation of kernel threads, the PCB contained much context that was per-process. Now, with the introduction of multiple threads of execution, much context becomes per-thread. To accommodate per-thread context, a new data structure, the kernel thread block (KTB), is created, with the per-thread context removed from the PCB. However, the PCB continues to contain context common to all threads, such as quotas and limits. The new per-kernel thread structure contains the scheduling state, priority, and the AST queues.

The PHD contains the HWPCB that gives a process its single execution context. The HWPCB remains in the PHD; this HWPCB is used by a process when it is first created. This execution context is also called the initial thread. A single threaded process has only this one execution context. A new structure, the floating-point registers and execution data block (FRED), is created to contain the hardware context of the newly created kernel threads. Since all threads in a process share the same address space, the PHD continues to describe the entire virtual memory layout of the process.

### 2.8.4.2 Kernel Thread Block (KTB)

The kernel thread block (KTB) is a new per-kernel-thread data structure. The KTB contains all per-thread software context moved from the PCB. The KTB is the basic unit of scheduling, a role previously performed by the PCB, and is the data structure placed in the scheduling state queues. Since the KTB is the logical extension of the PCB, the SCHED spinlock synchronizes access to the KTB and the PCB.

Typically, the number of KTBs a multithreaded process has is the same as the number of CPUs on the system. Actually, the number of KTBs is limited by the value of the system parameter MULTITHREAD. If MULTITHREAD is zero, the OpenVMS kernel support is disabled. With kernel threads disabled, user-level threading is still possible with POSIX Threads Library. The environment is identical to the OpenVMS environment prior to the OpenVMS Version 7.0 release.

## Process Creation

### 2.8 Kernel Threads and the Kernel Threads Process Structure (Alpha Only)

If MULTITHREAD is nonzero, it represents the maximum number of execution contexts or kernel threads that a process can own, including the initial one.

The KTB, in reality, is not an independent structure from the PCB. Both the PCB and KTB are defined as sparse structures. The fields of the PCB that move to the KTB retain their original PCB offsets in the KTB. In the PCB, these fields are unused. In effect, if the two structures are overlaid, the result is the PCB as it currently exists with new fields appended at the end. The PCB and KTB for the initial thread occupy the same block of nonpaged pool; therefore, the KTB address for the initial thread is the same as for the PCB.

#### 2.8.4.3 Floating-Point Registers and Execution Data Blocks (FREDs)

To allow for multiple execution contexts, not only are additional KTBs required to maintain the software context, but additional HWPCBs must be created to maintain the hardware context. Each HWPCB has allocated with it a block of 256 bytes for preserving the contents of the floating-point registers across context switches. Another 128 bytes is allocated for per-kernel thread data.

The combined structure that contains the HWPCB, floating-point register save area, and the per-kernel thread data is called the floating-point registers and execution data (FRED) block. Prior to Version 7.2, OpenVMS supported 16 kernel threads per process. With Version 7.2 and higher, OpenVMS supported 256 kernel threads per process. Also, prior to Version 7.3-1, OpenVMS allocated the maximum number of FRED blocks for a given process when that process was created, even if the process did not become multithreaded. With Version 7.3-1 and higher, OpenVMS allocated all FRED blocks as needed.

#### 2.8.4.4 Kernel Threads Region

Much process context resides in P1 space, taking the form of data cells and the process stacks. Some of these data cells need to be per kernel thread, as do the stacks. During initialization of the multithread environment, a kernel thread region in P1 space is initialized to contain the per-kernel-thread data cells and stacks. The region begins at the boundary between P0 and P1 space at address 40000000x, and it grows toward higher addresses and the initial thread's user stack. The region is divided into per-kernel-thread areas. Each area contains pages for data cells and the four stacks.

#### 2.8.4.5 Per-Kernel Thread Stacks

A process is created with four stacks; each access mode has one stack. All four of these stacks are located in P1 space. Stack sizes are either fixed, determined by a SYSGEN parameter, or expandable. The parameter KSTACKPAGES controls the size of the kernel stack. This parameter continues to control all kernel stack sizes, including those created for new execution contexts of kernel threads. The executive stack is a fixed size of two pages; with kernel threads implementation, the executive stack for new execution contexts continues to be two pages in size. The supervisor stack is a fixed size of four pages; with kernel threads implementation, the supervisor stack for new execution contexts is reduced to two pages in size.

For the user stack, a more complex situation exists. OpenVMS allocates P1 space from high to lower addresses. The user stack is placed after the lowest P1 space address allocated. This allows the user stack to expand on demand toward P0 space. With the introduction of multiple sets of stacks, the locations of these stacks impose a limit on the size of each area in which they can reside. With the implementation of kernel threads, the user stack is no longer boundless. The

## 2.8 Kernel Threads and the Kernel Threads Process Structure (Alpha Only)

initial user stack remains semi-boundless; it still grows toward P0 space, but the limit is the per-kernel thread region instead of P0 space.

The default user stack in a process can expand on demand to be quite large, so single threaded applications do not typically run out of user stack. When an application is written using POSIX Threads Library, each thread gets its own user stack, which is a fixed size. If the application developer underestimates the stack requirements, the application may fail due to a thread overflowing its stack. This failure is typically reported as an access violation and is very difficult to diagnose. To address this problem, yellow stack zones have been introduced in OpenVMS Version 7.2 and are available to applications using POSIX Threads Library.

Yellow stack zones are a mechanism by which the stack overflow can be signaled back to the application. The application can then choose either to provide a stack overflow handler or do nothing. If the application does nothing, this mechanism helps pinpoint the failure for the application developer. Instead of an access violation being signaled, a stack overflow error is signaled.

### 2.8.4.6 Per-Kernel-Thread Data Cells

Several pages in P1 space contain process state in the form of data cells. A number of these cells must have a per-kernel-thread equivalent. These data cells do not all reside on pages with the same protection. Because of this, the per-kernel-thread area reserves two pages for these cells. Each page has a different page protection; one page protection is user read, user write (URUW); the other is user read, executive write (UREW).

### 2.8.4.7 Summary of Process Data Structures

Process creation results in a PCB/KTB, a PHD/FRED, and a set of stacks. All processes have a single kernel thread, the initial thread.

A multithreaded process always begins as a single threaded process. A multithreaded process contains a PCB/KTB pair and a PHD/FRED pair for the initial thread; for its other threads, it contains additional KTBs, additional FREDs, and additional sets of stacks. When the multithreaded application exits, the process returns to its single threaded state, and all additional KTBs, FREDs, and stacks are deleted.

### 2.8.4.8 Kernel Thread Priorities

The SYS\$SETPRI system service and the SET PROCESS/PRIORITY DCL command both take a process identification value (PID) as an input and therefore affect only a single kernel thread at a time. If you want to change the base priorities of all kernel threads in a process, you must either make a separate call to SYS\$SETPRI or invoke the SET PROCESS/PRIORITY command for each thread.

In OpenVMS Alpha Version 7.2, a new value for the 'policy' parameter to the SYS\$SETPRI system service has been added. If JPI\$K\_ALL\_THREADS is specified, the call to SYS\$SETPRI changes the base priorities of all kernel threads in the target process.

The same support is provided by the ALL\_THREADS qualifier to the SET PROCESS/PRIORITY DCL command.





---

## Process Communication

This chapter describes communication mechanisms used within a process and between processes. It also describes programming with intra-cluster communication (ICC). It contains the following sections:

Section 3.1 describes communication within a process.

Section 3.2 describes communication between processes.

Section 3.3 describes intra-cluster communication.

The operating system allows your process to communicate within itself and with other processes. Processes can be either wholly independent or cooperative. This chapter presents considerations for developing applications that require the concurrent execution of many programs, and how you can use process communication to perform the following functions:

- Synchronize events
- Share data
- Obtain information about events important to the program you are executing

### 3.1 Communication Within a Process

Communicating within a process, from one program component to another, can be performed using the following methods:

- Local event flags
- Logical names (in supervisor mode)
- Global symbols (command language interpreter symbols)
- Common area

For passing information among chained images, you can use all four methods because the image reading the information executes immediately after the image that deposited it. Only the common area allows you to pass data reliably from one image to another in the event that another image's execution intervenes the two communicating images.

For communicating within a single image, you can use event flags, logical names, and symbols. For synchronizing events within a single image, use event flags. See Chapter 6 for more information about synchronizing events.

Because permanent mailboxes and permanent global sections are not deleted when the creating image exits, they also can be used to pass information from the current image to a later executing image. However, Compaq recommends that you use the common area because it uses fewer system resources than the permanent structures and does not require privilege. (You need the PRMMBX

## Process Communication

### 3.1 Communication Within a Process

privilege to create a permanent mailbox and the PRMGBL privilege to create a permanent global section.)

#### 3.1.1 Using Local Event Flags

Event flags are status-posting bits maintained by the operating system for general programming use. Programs can set, clear, and read event flags. By setting and clearing event flags at specific points, one program component can signal when an event has occurred. Other program components can then check the event flag to determine when the event has been completed. For more information about using local and common event flags for synchronizing events, refer to Chapter 6.

#### 3.1.2 Using Logical Names

Logical names can store up to 255 bytes of data. When you need to pass information from one program to another within a process, you can assign data to a logical name when you create the logical name; then, other programs can access the contents of the logical name. See Chapter 32 for more information about logical name system services.

##### 3.1.2.1 Using Logical Name Tables

If both processes are part of the same job, you can place the logical name in the process logical name table (LNM\$PROCESS) or in the job logical name table (LNM\$JOB). If a subprocess is prevented from inheriting the process logical name table, you must communicate using the job logical name table. If the processes are in the same group, place the logical name in the group logical name table LNM\$GROUP (requires GRPNAM or SYSPRV privilege). If the processes are not in the same group, place the logical name in the system logical name table LNM\$SYSTEM (requires SYSNAM or SYSPRV privilege). You can also use symbols, but only between a parent and a spawned subprocess that has inherited the parent's symbols.

##### 3.1.2.2 Using Access Modes

You can create a logical name under three access modes—user, supervisor, or executive. If you create a process logical name in user mode, it is deleted after the image exits. If you create a logical name in supervisor or executive mode, it is retained after the image exits. Therefore, to share data within the process from one image to the next, use supervisor-mode or executive-mode logical names.

##### 3.1.2.3 Creating and Accessing Logical Names

Perform the following steps to create and access a logical name:

1. Create the logical name and store data in it. Use LIB\$SET\_LOGICAL to create a supervisor logical name. No special privileges are required. You can also use the system service SYS\$CRELNM. SYS\$CRELNM also allows you to create a logical name for the system or group table and to create a logical name in any other mode, assuming you have appropriate privileges.
2. Access the logical name. Use the system service SYS\$TRNLNM. SYS\$TRNLNM searches for the logical name and returns information about it.
3. Once you have finished using the logical name, delete it. Use the routine LIB\$DELETE\_LOGICAL or SYS\$DELLNM. LIB\$DELETE\_LOGICAL deletes the supervisor logical name without requiring any special privileges. SYS\$DELLNM requires special privileges to delete logical names for privileged modes. However, you can also use this routine to delete either logical name tables or a logical name within a system or group table.

## Process Communication

### 3.1 Communication Within a Process

Example 3–1 creates a spawned subprocess to perform an iterative calculation. The logical name REP\_NUMBER specifies the number of times that REPEAT, the program executing in the subprocess, should perform the calculation. Because both the parent process and the subprocess are part of the same job, REP\_NUMBER is placed in the job logical name table LNM\$JOB. (Note that logical names are case sensitive; specifically, LNM\$JOB is a system-defined logical name that refers to the job logical name table, whereas lnm\$job is not.) To satisfy the references to LNM\$\_STRING, the example includes the file \$LNMDEF.

#### Example 3–1 Performing an Iterative Calculation with a Spawned Subprocess

```
PROGRAM CALC

! Status variable and system routines
INTEGER*4 STATUS,
2      SYS$CRELNM,
2      LIB$GET EF,
2      LIB$SPAWN
! Define itmlst structure
STRUCTURE /ITMLST/
UNION
MAP
  INTEGER*2 BUFLN
  INTEGER*2 CODE
  INTEGER*4 BUFADR
  INTEGER*4 RETLENADR
END MAP
MAP
  INTEGER*4 END_LIST
END MAP
END UNION
END STRUCTURE
! Declare itmlst
RECORD /ITMLST/ LNMLIST(2)
! Number to pass to REPEAT.FOR
CHARACTER*3 REPETITIONS_STR
INTEGER REPETITIONS
! Symbols for LIB$SPAWN and SYS$CRELNM
! Include FORSYSEDEF symbol definitions:
INCLUDE      '($LNMDEF)'
EXTERNAL CLI$M_NOLOGNAM,
2      CLI$M_NOCLISYM,
2      CLI$M_NOKEYPAD,
2      CLI$M_NOWAIT,
2      LNM$_STRING
      .
      . ! Set REPETITIONS_STR
      .
! Set up and create logical name REP_NUMBER in job table
LNMLIST(1).BUFLN      = 3
LNMLIST(1).CODE      = %LOC (LNM$ STRING)
LNMLIST(1).BUFADR    = %LOC(REPETITIONS_STR)
LNMLIST(1).RETLENADR = 0
LNMLIST(2).END_LIST = 0
STATUS = SYS$CRELNM (,
2      'LNM$JOB',      ! Logical name table
2      'REP NUMBER',,, ! Logical name
2      LNMLIST)      ! List specifying
                    ! equivalence string
IF (.NOT. STATUS) CALL LIB$SIGNAL (%VAL(STATUS))
```

(continued on next page)

## Process Communication

### 3.1 Communication Within a Process

#### Example 3–1 (Cont.) Performing an Iterative Calculation with a Spawmed Subprocess

```

! Execute REPEAT.FOR in a subprocess
MASK = %LOC (CLI$M_NOLOGNAM) .OR.
2      %LOC (CLI$M_NOCLISYM) .OR.
2      %LOC (CLI$M_NOKEYPAD) .OR.
2      %LOC (CLI$M_NOWAIT)
STATUS = LIB$GET_EF (FLAG)
IF (.NOT. STATUS) CALL LIB$SIGNAL (%VAL(STATUS))
STATUS = LIB$SPAWN ('RUN REPEAT',,,MASK,,,FLAG)
IF (.NOT. STATUS) CALL LIB$SIGNAL (%VAL(STATUS))
.
.
.

REPEAT.FOR
PROGRAM REPEAT
! Repeats a calculation REP_NUMBER of times,
! where REP_NUMBER is a logical name

! Status variables and system routines
INTEGER STATUS,
2      SYS$TRNLNM,
2      SYS$DELLNM

! Number of times to repeat
INTEGER*4 REITERATE,
2      REPEAT_STR_LEN
CHARACTER*3 REPEAT_STR
! Item list for SYS$TRNLNM
! Define itmlst structure
STRUCTURE /ITMLST/
UNION
MAP
INTEGER*2 BUFLN
INTEGER*2 CODE
INTEGER*4 BUFADR
INTEGER*4 RETLENADR
END MAP
MAP
INTEGER*4 END_LIST
END MAP
END UNION
END STRUCTURE
! Declare itmlst
RECORD /ITMLST/ LNMLIST (2)
! Define item code
EXTERNAL LNM$ STRING
! Set up and translate the logical name REP_NUMBER
LNMLIST(1).BUFLN = 3
LNMLIST(1).CODE = LNM$ STRING
LNMLIST(1).BUFADR = %LOC(REPEAT_STR)
LNMLIST(1).RETLENADR = %LOC(REPEAT_STR_LEN)
LNMLIST(2).END_LIST = 0
STATUS = SYS$TRNLNM (,
2      'LNM$JOB',      ! Logical name table
2      'REP_NUMBER',  ! Logical name
2      LNMLIST)      ! List requesting
! equivalence string
IF (.NOT. STATUS) CALL LIB$SIGNAL (%VAL(STATUS))

```

(continued on next page)

**Example 3–1 (Cont.) Performing an Iterative Calculation with a Spawned Subprocess**

```
! Convert equivalence string to integer
! BN causes spaces to be ignored
READ (UNIT = REPEAT_STR (1:REPEAT_STR_LEN),
2     FMT = '(BN,I3)') REITERATE
! Calculations
DO I = 1, REITERATE
.
.
.
END DO
! Delete logical name
STATUS = SYS$DELLNM ('LNM$JOB',      ! Logical name table
2                   'REP NUMBER',) ! Logical name
IF (.NOT. STATUS) CALL LIB$SIGNAL (%VAL(STATUS))
END
```

### 3.1.3 Using Command Language Interpreter Symbols

The symbols you create and access for process communication are command language interpreter (CLI) symbols. These symbols are stored in symbol tables maintained for use within the context of DCL, the default command language interpreter. They can store up to 255 bytes of information. The use of these symbols is limited to processes using DCL. If the process is not using DCL, an error status is returned by the symbol routines.

#### 3.1.3.1 Local and Global Symbols

The two kinds of CLI symbols and their definitions are as follows:

- Local—A local symbol is available to the command level that defined it, any command procedure executed from that command level, and lower command levels.
- Global—A global symbol can be accessed from any command level, regardless of the level at which it was defined.

#### 3.1.3.2 Creating and Using Global Symbols

If you need to pass information from one program to another within a process, you can assign data to a global symbol when you create the symbol. Then, other programs can access the contents of the global symbol. You should use global symbols so the value within the symbol can be accessed by other programs.

To use DCL global symbols, follow this procedure:

1. Create the symbol and assign data to it using the routine LIB\$SET\_SYMBOL. Make sure you specify that the symbol will be placed in the global symbol table in the **tbl-ind** argument. If you do not specify the global symbol table, the symbol will be a local symbol.
2. Access the symbol with the LIB\$GET\_SYMBOL routine. This routine uses DCL to return the value of the symbol as a string.
3. Once you have finished using the symbol, delete it with the LIB\$DELETE\_SYMBOL routine. If you created a global symbol, make sure you specify the global symbol table in the **tbl-ind** argument. By default, the system searches the local symbol table.

## Process Communication

### 3.1 Communication Within a Process

#### 3.1.4 Using the Common Area

Use the common area to store data from one image to the next. Such data is unlikely to be corrupted between the time one image deposits it in a common area and another image reads it from the area. The common area can store 252 bytes of data. The LIB\$PUT\_COMMON routine writes information to this common area; the LIB\$GET\_COMMON routine reads information from this common area.

##### 3.1.4.1 Creating the Process Common Area

The common area for your process is automatically created for you; no special declaration is necessary. To pass more than 255 bytes of data, put the data into a file instead of in the common area and use the common area to pass the specification.

##### 3.1.4.2 Common I/O Routines

The LIB\$PUT\_COMMON routine allows a program to copy a string into the process's common storage area. This area remains defined during multiple image activations. LIB\$GET\_COMMON allows a program to copy a string from the common area into a destination string. The programs reading and writing the data in the common area must agree upon its amount and format. The maximum length of the destination string is defined as follows:

[min(256, the length of the data in the common storage area) - 4]

This maximum length is normally 252.

In BASIC and Fortran, you can use these routines to allow a USEROPEN routine to pass information back to the routine that called it. A USEROPEN routine cannot write arguments. However, it can call LIB\$PUT\_COMMON to put information into the common area. The calling program can then use LIB\$GET\_COMMON to retrieve it.

You can also use these routines to pass information between images run successively, such as chained images run by LIB\$RUN\_PROGRAM.

##### 3.1.4.3 Modifying or Deleting Data in the Common Block

You cannot modify or delete data in the process common area unless you invoke LIB\$PUT\_COMMON. Therefore, you can execute any number of images between one image and another, provided that you have not invoked LIB\$PUT\_COMMON. Each subsequent image reads the correct data. Invoking LIB\$GET\_COMMON to read the common block does not modify the data.

##### 3.1.4.4 Specifying Other Types of Data

Although the descriptions of the LIB\$PUT\_COMMON and LIB\$GET\_COMMON routines in the *OpenVMS RTL Library (LIB\$) Manual* specify a character string for the argument containing the data written to or read from the common area, you can specify other types of data. However, you must pass both noncharacter and character data by descriptor.

The following program segment reads statistics from the terminal and enters them into a binary file. After all of the statistics are entered into the file, the program places the name of the file into the per-process common area and exits.

```
.  
. .  
! Enter statistics  
. .  
! Put the name of the stats file into common  
STATUS = LIB$PUT_COMMON (FILE_NAME (1:LEN))  
. .  
.
```

The following program segment reads the file name from the per-process common block and compiles a report using the statistics from that file.

```
. .  
! Read the name of the stats file from common  
STATUS = LIB$GET_COMMON (FILE_NAME,  
2 LEN)  
! Compile the report  
. .  
.
```

## 3.2 Communication Between Processes

Communication between processes, or interprocess communication, can be performed in the following ways:

- Shared files
- Common event flags
- Logical names
- Mailboxes
- Global sections
- Lock management system services

Each approach offers different possibilities in terms of the speed at which it communicates information and the amount of information it can communicate. For example, shared files offer the possibility of sharing an unlimited amount of information; however, this approach is the slowest because the disk must be accessed to share information.

Like shared files, global sections offer the possibility of sharing large amounts of information. Because sharing information through global sections requires only memory access, it is the fastest communication method.

Logical names and mailboxes can communicate moderate amounts of information. Because each method operates through a relatively complex system service, each is faster than files, but slower than the other communication methods.

The lock management services and common event flag cluster methods can communicate relatively small amounts of information. With the exception of global sections, they are the fastest of the interprocess communication methods.

## Process Communication

### 3.2 Communication Between Processes

**Common event flags:** Processes executing within the same group can use common event flags to signal the occurrence or completion of particular activities. For details about event flags, and an example of how cooperating processes in the same group use a common event flag, see Chapter 6.

**Logical name tables:** Processes executing in the same job can use the job logical name table to provide member processes with equivalence names for logical names. Processes executing in the same group can use the group logical name table. A process must have the GRPNAM or SYSPRV privilege to place names in the group logical name table. All processes in the system can use the system logical name table. A process must have the SYSNAM or SYSPRV privilege to place names in the system logical name table. Processes can also create and use user-defined logical name tables. For details about logical names and logical name tables, see Chapter 32.

**Mailboxes:** You can use mailboxes as virtual input/output devices to pass information, messages, or data among processes. For additional information on how to create and use mailboxes, see Section 3.2.1. Mailboxes may also be used to provide a creating process with a way to determine when and under what conditions a created subprocess was deleted. For an example of a termination mailbox, see Section 4.9.4.2.

**Global sections:** Global sections can be either disk files or page-file sections that contain shareable code or data. Through the use of memory management services, these files can be mapped to the virtual address space of more than one process. In the case of a data file on disk, cooperating processes can synchronize reading and writing the data in physical memory; as data is updated, system paging results in the updated data being written directly back into the disk file. Global page-file sections are useful for temporary storage of common data; they are not mapped to a disk file. Instead, they page only to the system default page file. Global sections are described in more detail in Chapter 13 and Chapter 12.

**Lock management system services:** Processes can use the lock management system services to control access to resources (any entity on the system that the process can read, write, or execute). In addition to controlling access, the lock management services provide a mechanism for passing information among processes that have access to a resource (lock value blocks). Blocking ASTs can be used to notify a process that other processes are waiting for a resource. Using lock value blocks is a practical technique for communicating in cluster environments. With lock value blocks, communication between two processes from node to node in a distributed environment is an effective way of implementing cluster communication. For more information about the lock management system services, see Chapter 7.

While common event flags and lock management services establish communication, they are most useful for synchronizing events and are discussed in Chapter 6. Global sections and shared files are best used for sharing data and are discussed in Chapter 26.

#### 3.2.1 Mailboxes

A mailbox is a virtual device used for communication among processes. You must call OpenVMS RMS services, language I/O statements, or I/O system services to perform actual data transfers.



### 3.2.1.1 Creating a Mailbox

To create a mailbox, use the SYS\$CREMBX system service. SYS\$CREMBX creates the mailbox and returns the number of the I/O channel assigned to the mailbox.

The format for the SYS\$CREMBX system service is as follows:

```
SYS$CREMBX ([prmflg] ,chan ,[maxmsg] ,[bufquo] ,[promsk] ,[acmode] ,[lognam]
           ,[flags] ,[nullarg])
```

When you invoke SYS\$CREMBX, you usually specify the following two arguments:

- Specify a variable to receive the I/O channel number using the **chan** argument. This argument is required.
- Specify the logical name to be associated with the mailbox using the **lognam** argument. The logical name identifies the mailbox for other processes and for input/output statements.

The SYS\$CREMBX system service also allows you to specify the message size, buffer size, mailbox protection code, and access mode of the mailbox; however, the default values for these arguments are usually sufficient. For more information on SYS\$CREMBX, refer to the *OpenVMS System Services Reference Manual*.

### 3.2.1.2 Creating Temporary and Permanent Mailboxes

By default, a mailbox is deleted when no I/O channel is assigned to it. Such a mailbox is called a temporary mailbox. If you have PRMMBX privilege, you can create a permanent mailbox (specify the **prmflg** argument as 1 when you invoke SYS\$CREMBX). A permanent mailbox is not deleted until it is marked for deletion with the SYS\$DELMBX system service (requires PRMMBX). Once a permanent mailbox is marked for deletion, it is like a temporary mailbox; when the last I/O channel to the mailbox is deassigned, the mailbox is deleted.

The following statement creates a mailbox named MAIL\_BOX. The I/O channel assigned to the mailbox is returned in MBX\_CHAN.

```
! I/O channel
INTEGER*2 MBX_CHAN

! Mailbox name
CHARACTER*(*) MBX_NAME
PARAMETER (MBX_NAME = 'MAIL_BOX')

STATUS = SYS$CREMBX (,
2             MBX_CHAN, ! I/O channel
2             ' '
2             MBX_NAME) ! Mailbox name
```

---

**Note**

---

If you use MAIL as the logical name for a mailbox, then the system will not execute the proper image in response to the DCL command MAIL.

---

The following program segment creates a permanent mailbox, then creates a subprocess that marks that mailbox for deletion:

## Process Communication

### 3.2 Communication Between Processes

```
INTEGER STATUS,
2     SYS$CREMBX
INTEGER*2 MBX_CHAN

! Create permanent mailbox
STATUS = SYS$CREMBX (%VAL(1),      ! Permanence flag
2     MBX_CHAN,      ! Channel
2
2     'MAIL_BOX') ! Logical name
IF (.NOT. STATUS) CALL LIB$SIGNAL (%VAL(STATUS))
! Create subprocess to delete it
STATUS = LIB$SPAWN ('RUN DELETE MBX')
IF (.NOT. STATUS) CALL LIB$SIGNAL (%VAL(STATUS))

END
```

The following program segment executes in the subprocess. Notice that the subprocess must assign a channel to the mailbox and then use that channel to delete the mailbox. Any process that deletes a permanent mailbox, unless it is the creating process, must use this technique. (Use SYS\$ASSIGN to assign the channel to the mailbox to ensure that the mailbox already exists. SYS\$CREMBX system service assigns a channel to a mailbox; however, SYS\$CREMBX also creates the mailbox if it does not already exist.)

```
INTEGER STATUS,
2     SYS$DELMBX,
2     SYS$ASSIGN
INTEGER*2 MBX_CHAN

! Assign channel to mailbox
STATUS = SYS$ASSIGN ('MAIL_BOX',
2     MBX_CHAN,,)
IF (.NOT. STATUS) CALL LIB$SIGNAL (%VAL(STATUS))
! Delete the mailbox
STATUS = SYS$DELMBX (%VAL(MBX_CHAN))
IF (.NOT. STATUS) CALL LIB$SIGNAL (%VAL(STATUS))

END
```

#### 3.2.1.3 Assigning an I/O Channel Along with a Mailbox

A mailbox is a virtual device used for communication between processes. A channel is the communication path that a process uses to perform I/O operations to a particular device. The LIB\$ASN\_WTH\_MBX routine assigns a channel to a device and associates a mailbox with the device.

Normally, a process calls the SYS\$CREMBX system service to create a mailbox and assign a channel and logical name to it. In the case of a temporary mailbox, this service places the logical name corresponding to the mailbox in the job logical name table. This implies that any process running in the same job and using the same logical name uses the same mailbox.

Sometimes it is not desirable to have more than one process use the same mailbox. For example, when a program connects explicitly with another process across a network, the program uses a mailbox both to obtain the data confirming the connection and to store the asynchronous messages from the other process. If that mailbox is shared with other processes in the same group, there is no way to determine which messages are intended for which processes; the processes read each other's messages, and the original program does not receive the correct information from the cooperating process across the network link.

## Process Communication

### 3.2 Communication Between Processes

The LIB\$ASN\_WTH\_MBX routine avoids this situation by associating the physical mailbox name with the channel assigned to the device. To create a temporary mailbox for itself and other processes cooperating with it, your program calls LIB\$ASN\_WTH\_MBX. The run-time library routine assigns the channel and creates the temporary mailbox by using the system services \$GETDVI, \$ASSIGN, and \$CREMBX. Instead of a logical name, the mailbox is identified by a physical device name of the form *MBcu*. The elements that make up this device name are as follows:

*MB* indicates that the device is a mailbox.

*c* is the controller.

*u* is the unit number.

The routine returns this device name to the calling program, which then must pass the mailbox channel to the other programs with which it cooperates. In this way, the cooperating processes access the mailbox by its physical name instead of by its jobwide logical name.

The calling program passes the routine a device name, which specifies the device to which the channel is to be assigned. For this argument (called **dev-nam**), you can use a logical name. If you do so, the routine attempts one level of logical name translation.

The privilege restrictions and process quotas required for using this routine are those required by the \$GETDVI, \$CREMBX, and \$ASSIGN system services.

#### 3.2.1.4 Reading and Writing Data to a Mailbox

The following list describes the three ways you can read and write to a mailbox:

- Synchronous I/O—Reads or writes to a mailbox and then waits for the cooperating image to perform the other operation. Use I/O statements for your programming language. This is the recommended method of addressing a mailbox.
- Immediate I/O—Queues a read or write operation to a mailbox and continues program execution after the operation completes. To do this, use the SYS\$QIOW system service.
- Asynchronous I/O—Queues a read or write operation to a mailbox and continues program execution while the request executes. To do this, use the SYS\$QIO system service. When the read or write operation completes, the I/O status block (if specified) is filled, the event flag (if specified) is set, and the AST routine (if specified) is executed.

Chapter 23 describes the SYS\$QIO and SYS\$QIOW system services and provides further discussion of mailbox I/O. See the *OpenVMS System Services Reference Manual* for more information. Compaq recommends that you supply the optional I/O status block parameter when you use these two system services. The contents of the status block varies depending on the QIO function code; refer to the function code descriptions in the *OpenVMS I/O User's Reference Manual* for a description of the appropriate status block.

## Process Communication

### 3.2 Communication Between Processes

#### 3.2.1.5 Using Synchronous Mailbox I/O

Use synchronous I/O when you read or write information to another image and cannot continue until that image responds.

The program segment shown in Example 3–2 opens a mailbox for the first time. To open a mailbox for Fortran I/O, use the OPEN statement with the following specifiers: UNIT, FILE, CARRIAGECONTROL, and STATUS. The value for the keyword FILE should be the logical name of a mailbox (SYS\$CREMBX allows you to associate a logical name with a mailbox when the mailbox is created). The value for the keyword CARRIAGECONTROL should be 'LIST'. The value for the keyword STATUS should be 'NEW' for the first OPEN statement and 'OLD' for subsequent OPEN statements.

#### Example 3–2 Opening a Mailbox

```
! Status variable and values
INTEGER STATUS

! Logical unit and name for mailbox
INTEGER MBX_LUN
CHARACTER(*) MBX_NAME
PARAMETER (MBX_NAME = MAIL_BOX)
! Create mailbox
STATUS = SYS$CREMBX (,
2      MBX_CHAN, ! Channel
2      ' '
2      MBX_NAME) ! Logical name
IF (.NOT. STATUS) CALL LIB$SIGNAL (%VAL(STATUS))

! Get logical unit for mailbox and open mailbox
STATUS = LIB$GET_LUN (MBX_LUN)
IF (.NOT. STATUS) CALL LIB$SIGNAL (%VAL(STATUS))
OPEN (UNIT = MBX_LUN,
2     FILE = MBX_NAME,
2     CARRIAGECONTROL = 'LIST',
2     STATUS = 'NEW')
```

In Example 3–3, one image passes device names to a second image. The second image returns the process name and the terminal associated with the process that allocated each device. A WRITE statement in the first image does not complete until the cooperating process issues a READ statement. (The variable declarations are not shown in the second program because they are very similar to those in the first program.)

#### Example 3–3 Synchronous I/O Using a Mailbox

```
! DEVICE.FOR
PROGRAM PROCESS_DEVICE

! Status variable
INTEGER STATUS

! Name and I/O channel for mailbox
CHARACTER(*) MBX_NAME
PARAMETER (MBX_NAME = 'MAIL_BOX')
INTEGER*2 MBX_CHAN
! Logical unit number for FORTRAN I/O
INTEGER MBX_LUN
```

(continued on next page)

## Process Communication

### 3.2 Communication Between Processes

#### Example 3-3 (Cont.) Synchronous I/O Using a Mailbox

```
! Character string format
CHARACTER*(*) CHAR_FMT
PARAMETER (CHAR_FMT = '(A50)')
! Mailbox message
CHARACTER*50 MBX_MESSAGE
.
.
! Create the mailbox
STATUS = SYS$CREMBX (,
2      MBX_CHAN, ! Channel
2      '','','
2      MBX_NAME) ! Logical name
IF (.NOT. STATUS) CALL LIB$SIGNAL (%VAL(STATUS))
! Get logical unit for mailbox and open mailbox
STATUS = LIB$GET_LUN (MBX_LUN)
IF (.NOT. STATUS) CALL LIB$SIGNAL (%VAL(STATUS))
OPEN (UNIT = MBX_LUN,
2     FILE = MBX_NAME,
2     CARRIAGECONTROL = 'LIST',
2     STATUS = 'NEW')
! Create subprocess to execute GETDEVINF.EXE
STATUS = SYS$CREPRC (,
2      'GETDEVINF', ! Image
2      '','','
2      'GET DEVICE', ! Process name
2      %VAL(4),,,) ! Priority
IF (.NOT. STATUS) CALL LIB$SIGNAL (%VAL(STATUS))
! Pass device names to GETDEVINF
WRITE (UNIT=MBX_LUN,
2     FMT=CHAR_FMT) 'SYS$DRIVE0'
! Read device information from GETDEVINF
READ (UNIT=MBX_LUN,
2     FMT=CHAR_FMT) MBX_MESSAGE
.
.
END
```

#### GETDEVINF.FOR

```
.
.
! Create mailbox
STATUS = SYS$CREMBX (,
2      MBX_CHAN, ! I/O channel
2      '','','
2      MBX_NAME) ! Mailbox name
IF (.NOT. STATUS) CALL LIB$SIGNAL (%VAL(STATUS))
! Get logical unit for mailbox and open mailbox
STATUS = LIB$GET_LUN (MBX_LUN)
IF (.NOT. STATUS) CALL LIB$SIGNAL (%VAL(STATUS))
OPEN (UNIT=MBX_LUN,
2     FILE=MBX_NAME,
2     CARRIAGECONTROL='LIST',
2     STATUS = 'OLD')
! Read device names from mailbox
READ (UNIT=MBX_LUN,
2     FMT=CHAR_FMT) MBX_MESSAGE
```

(continued on next page)

## Process Communication

### 3.2 Communication Between Processes

#### Example 3–3 (Cont.) Synchronous I/O Using a Mailbox

```
! Use SYS$GETJPI to find process and terminal
! Process name: PROC_NAME (1:P_LEN)
! Terminal name: TERM (1:T_LEN)
.
.
.
MBX_MESSAGE = MBX_MESSAGE//' '//
2          PROC_NAME(1:P_LEN)//' '//
2          TERM(1:T_LEN)
! Write device information to DEVICE
WRITE (UNIT=MBX_LUN,
2      FMT=CHAR_FMT) MBX_MESSAGE

END
```

#### 3.2.1.6 Using Immediate Mailbox I/O

Use immediate I/O to read or write to another image without waiting for a response from that image. To ensure that the other process receives the information that you write, either do not exit until the other process has a channel to the mailbox, or use a permanent mailbox.

##### Queueing an Immediate I/O Request

To queue an immediate I/O request, invoke the SYS\$QIOW system service. See the *OpenVMS System Services Reference Manual* for more information.

##### Reading Data from the Mailbox

Since immediate I/O is asynchronous, a mailbox may contain more than one message or no message when it is read. If the mailbox contains more than one message, the read operation retrieves the messages one at a time in the order in which they were written. If the mailbox contains no message, the read operation generates an end-of-file error.

To allow a cooperating program to differentiate between an empty mailbox and the end of the data being transferred, the process writing the messages should use the IO\$\_WRITEOF function code to write an end-of-file message to the mailbox as the last piece of data. When the cooperating program reads an empty mailbox, the end-of-file message is returned and the second longword of the I/O status block is 0. When the cooperating program reads an end-of-file message explicitly written to the mailbox, the end-of-file message is returned and the second longword of the I/O status block contains the process identification number of the process that wrote the message to the mailbox.

In Example 3–4, the first program creates a mailbox named MAIL\_BOX, writes data to it, and then indicates the end of the data by writing an end-of-file message. The second program creates a mailbox with the same logical name, reads the messages from the mailbox into an array, and stops the read operations when a read operation generates an end-of-file message and the second longword of the I/O status block is nonzero, confirming that the writing process sent the end-of-file message. The processes use common event flag 64 to ensure that SEND.FOR does not exit until RECEIVE.FOR has established a channel to the mailbox. (If RECEIVE.FOR executes first, an error occurs because SYS\$ASSIGN cannot find the mailbox.)

## Process Communication

### 3.2 Communication Between Processes

#### Example 3-4 Immediate I/O Using a Mailbox

```
!SEND.FOR
.
.
.
INTEGER*4 STATUS
! Name and channel number for mailbox
CHARACTER*(*) MBX_NAME
PARAMETER (MBX_NAME = 'MAIL_BOX')
INTEGER*2 MBX_CHAN
! Mailbox message
CHARACTER*80 MBX_MESSAGE
INTEGER LEN
CHARACTER*80 MESSAGES (255)
INTEGER MESSAGE_LEN (255)
INTEGER MAX_MESSAGE
PARAMETER (MAX_MESSAGE = 255)
! I/O function codes and status block
INCLUDE '($IODEF)'
INTEGER*4 WRITE_CODE
STRUCTURE /STATUS_BLOCK/
  INTEGER*2 IOSTAT,
  2      MSG_LEN
  INTEGER*4 READER_PID
END STRUCTURE
RECORD /STATUS_BLOCK/ IOSTATUS
! System routines
INTEGER SYS$CREMBX,
2      SYS$ASCEFC,
2      SYS$WAITFR,
2      SYS$QIOW
! Create the mailbox
STATUS = SYS$CREMBX (,
2      MBX_CHAN,
2      ' ',
2      MBX_NAME)
IF (.NOT. STATUS) CALL LIB$SIGNAL (%VAL(STATUS))
! Fill MESSAGES array
.
.
.
! Write the messages
DO I = 1, MAX_MESSAGE
  WRITE_CODE = IO$ WRITEVBLK .OR. IO$M_NOW
  MBX_MESSAGE = MESSAGES(I)
  LEN = MESSAGE_LEN(I)
  STATUS = SYS$QIOW (,
2      %VAL(MBX_CHAN),      ! Channel
2      %VAL(WRITE_CODE),   ! I/O code
2      IOSTATUS,           ! Status block
2      ' ',
2      %REF(MBX_MESSAGE),  ! P1
2      %VAL(LEN),          ! P2
  IF (.NOT. STATUS) CALL LIB$SIGNAL (%VAL(STATUS))
  IF (.NOT. IOSTATUS.IOSTAT)
2      CALL LIB$SIGNAL (%VAL(IOSTATUS.STATUS))
END DO
```

(continued on next page)

## Process Communication

### 3.2 Communication Between Processes

#### Example 3-4 (Cont.) Immediate I/O Using a Mailbox

```

! Write end-of-file
WRITE CODE = IO$ WRITEOF .OR. IO$M_NOW
STATUS = SYS$QIOW (,
2             %VAL(MBX_CHAN),      ! Channel
2             %VAL(WRITE_CODE),    ! End-of-file code
2             IOSTATUS,            ! Status block
2             ,,,,,,)
IF (.NOT. STATUS) CALL LIB$SIGNAL (%VAL(STATUS))
IF (.NOT. IOSTATUS.IOSTAT)
2   CALL LIB$SIGNAL (%VAL(IOSTATUS.IOSTAT))
.
.
! Make sure cooperating process can read the information
! by waiting for it to assign a channel to the mailbox
STATUS = SYS$ASCEFC (%VAL(64),
2             'CLUSTER',,)
IF (.NOT. STATUS) CALL LIB$SIGNAL (%VAL(STATUS))
STATUS = SYS$WAITFR (%VAL(64))
IF (.NOT. STATUS) CALL LIB$SIGNAL (%VAL(STATUS))

END

```

#### RECEIVE.FOR

```

INTEGER STATUS

INCLUDE '($IODEF)'
INCLUDE '($SDEF)'

! Name and channel number for mailbox
CHARACTER*(*) MBX_NAME
PARAMETER (MBX_NAME = 'MAIL_BOX')
INTEGER*2 MBX_CHAN
! QIO function code
INTEGER READ_CODE
! Mailbox message
CHARACTER*80 MBX_MESSAGE
INTEGER*4   LEN
! Message arrays
CHARACTER*80 MESSAGES (255)
INTEGER*4   MESSAGE_LEN (255)
! I/O status block
STRUCTURE /STATUS_BLOCK/
  INTEGER*2 IOSTAT,
  2       MSG_LEN
  INTEGER*4 READER_PID
END STRUCTURE
RECORD /STATUS_BLOCK/ IOSTATUS
! System routines
INTEGER SYS$ASSIGN,
2       SYS$ASCEFC,
2       SYS$SETEF,
2       SYS$QIOW
! Create the mailbox and let the other process know
STATUS = SYS$ASSIGN (MBX_NAME,
2             MBX_CHAN,,)
IF (.NOT. STATUS) CALL LIB$SIGNAL (%VAL(STATUS))
STATUS = SYS$ASCEFC (%VAL(64),
2             'CLUSTER',,)
IF (.NOT. STATUS) CALL LIB$SIGNAL (%VAL(STATUS))
STATUS = SYS$SETEF (%VAL(64))
IF (.NOT. STATUS) CALL LIB$SIGNAL (%VAL(STATUS))

```

(continued on next page)



## Process Communication

### 3.2 Communication Between Processes

#### Example 3–4 (Cont.) Immediate I/O Using a Mailbox

```

! Read first message
READ_CODE = IO$_READVBLK .OR. IO$_M_NOW
LEN = 80
STATUS = SYS$QIOW (,
2          %VAL(MBX_CHAN),      ! Channel
2          %VAL(READ_CODE),    ! Function code
2          IOSTATUS,           ! Status block
2          ,,
2          %REF(MBX_MESSAGE),  ! P1
2          %VAL(LEN),,,,,      ! P2
IF (.NOT. STATUS) CALL LIB$SIGNAL (%VAL(STATUS))
IF ((.NOT. IOSTATUS.IOSTAT) .AND.
2  (IOSTATUS.IOSTAT .NE. SS$ ENDOFFILE)) THEN
    CALL LIB$SIGNAL (%VAL(IOSTATUS.IOSTAT))
ELSE IF (IOSTATUS.IOSTAT .NE. SS$ ENDOFFILE) THEN
    I = 1
    MESSAGES(I) = MBX_MESSAGE
    MESSAGE_LEN(I) = IOSTATUS.MSG_LEN
END IF
! Read messages until cooperating process writes end-of-file
DO WHILE (.NOT. ((IOSTATUS.IOSTAT .EQ. SS$ ENDOFFILE) .AND.
2  (IOSTATUS.READER_PID .NE. 0)))

    STATUS = SYS$QIOW (,
2          %VAL(MBX_CHAN),      ! Channel
2          %VAL(READ_CODE),    ! Function code
2          IOSTATUS,           ! Status block
2          ,,
2          %REF(MBX_MESSAGE),  ! P1
2          %VAL(LEN),,,,,      ! P2
    IF (.NOT. STATUS) CALL LIB$SIGNAL (%VAL(STATUS))
    IF ((.NOT. IOSTATUS.IOSTAT) .AND.
2  (IOSTATUS.IOSTAT .NE. SS$ ENDOFFILE)) THEN
        CALL LIB$SIGNAL (%VAL(IOSTATUS.IOSTAT))
    ELSE IF (IOSTATUS.IOSTAT .NE. SS$ ENDOFFILE) THEN
        I = I + 1
        MESSAGES(I) = MBX_MESSAGE
        MESSAGE_LEN(I) = IOSTATUS.MSG_LEN
    END IF
END DO
.
.
.

```

#### 3.2.1.7 Using Asynchronous Mailbox I/O

Use asynchronous I/O to queue a read or write request to a mailbox. To ensure that the other process receives the information you write, either do not exit the other process until the other process has a channel to the mailbox, or use a permanent mailbox.

To queue an asynchronous I/O request, invoke the SYS\$QIO system service; however, when specifying the function codes, do not specify the IO\$\_M\_NOW modifier. The SYS\$QIO system service allows you to specify either an AST to be executed or an event flag to be set when the I/O operation completes.

Example 3–5 calculates gross income and taxes and then uses the results to calculate net income. INCOME.FOR uses SYS\$CREPRC, specifying a termination mailbox, to create a subprocess to calculate taxes (CALC\_TAXES) while INCOME calculates gross income. INCOME issues an asynchronous read

## Process Communication

### 3.2 Communication Between Processes

to the termination mailbox, specifying an event flag to be set when the read completes. (The read completes when CALC\_TAXES completes, terminating the created process and causing the system to write to the termination mailbox.) After finishing its own gross income calculations, INCOME.FOR waits for the flag that indicates CALC\_TAXES has completed and then figures net income.

CALC\_TAXES.FOR passes the tax information to INCOME.FOR using the installed common block created from INSTALLED.FOR.

#### Example 3–5 Asynchronous I/O Using a Mailbox

```
!INSTALLED.FOR

! Installed common block to be linked with INCOME.FOR and
! CALC_TAXES.FOR.
! Unless the shareable image created from this file is
! in SYS$SHARE, you must define a group logical name
! INSTALLED and equivalence it to the full file specification
! of the shareable image.
INTEGER*4 INCOME (200),
2         TAXES (200),
2         NET (200)
COMMON /CALC/ INCOME,
2         TAXES,
2         NET

END

!INCOME.FOR
! Status and system routines
.
.
.
INCLUDE '($SDEF)'
INCLUDE '($IODEF)'
INTEGER STATUS,
2     LIB$GET_LUN,
2     LIB$GET_EF,
2     SYS$CLREF,
2     SYS$CREMBX,
2     SYS$CREPRC,
2     SYS$GETDVIW,
2     SYS$QIO,
2     SYS$WAITFR
```

(continued on next page)

## Process Communication

### 3.2 Communication Between Processes

#### Example 3–5 (Cont.) Asynchronous I/O Using a Mailbox

```
! Set up for SYS$GETDVI
! Define itmlst structure
STRUCTURE /ITMLST/
  UNION
    MAP
      INTEGER*2 BUFLen
      INTEGER*2 CODE
      INTEGER*4 BUFADR
      INTEGER*4 RETLENADR
    END MAP
    MAP
      INTEGER*4 END_LIST
    END MAP
  END UNION
END STRUCTURE
! Declare itmlst
RECORD /ITMLST/ DVILIST (2)
INTEGER*4 UNIT_BUF,
2          UNIT_LEN
EXTERNAL DVI$ UNIT
! Name and I/O channel for mailbox
CHARACTER*(*) MBX_NAME
PARAMETER (MBX_NAME = 'MAIL_BOX')
INTEGER*2 MBX_CHAN
INTEGER*4 MBX_LUN          ! Logical unit number for I/O
CHARACTER*84 MBX_MESSAGE ! Mailbox message
INTEGER*4 READ_CODE,
2          LENGTH
! I/O status block
STRUCTURE /STATUS_BLOCK/
  INTEGER*2 IOSTAT,
2          MSG_LEN
  INTEGER*4 READER_PID
END STRUCTURE
RECORD /STATUS_BLOCK/ IOSTATUS
! Declare calculation variables in installed common
INTEGER*4 INCOME (200),
2          TAXES (200),
2          NET (200)
COMMON /CALC/ INCOME,
2          TAXES,
2          NET
! Flag to indicate taxes calculated
INTEGER*4 TAX_DONE
! Get and clear an event flag
STATUS = LIB$GET_EF (TAX_DONE)
IF (.NOT. STATUS) CALL LIB$SIGNAL(%VAL(STATUS))
STATUS = SYS$CLREF (%VAL(TAX_DONE))
IF (.NOT. STATUS) CALL LIB$SIGNAL(%VAL(STATUS))
! Create the mailbox
STATUS = SYS$CREMBX (,
2          MBX_CHAN,
2          ' ',
2          MBX_NAME)
IF (.NOT. STATUS) CALL LIB$SIGNAL(%VAL(STATUS))
```

(continued on next page)

## Process Communication

### 3.2 Communication Between Processes

#### Example 3–5 (Cont.) Asynchronous I/O Using a Mailbox

```

! Get unit number of the mailbox
DVILIST(1).BUFLEN = 4
DVILIST(1).CODE = %LOC(DVI$ UNIT)
DVILIST(1).BUFADR = %LOC(UNIT_BUF)
DVILIST(1).RETLENADR = %LOC(UNIT_LEN)
DVILIST(2).END LIST = 0
STATUS = SY$GETDVIW (,
2          %VAL(MBX_CHAN), ! Channel
2          MBX_NAME,      ! Device
2          DVILIST,       ! Item list
2          ,,,)
IF (.NOT. STATUS) CALL LIB$SIGNAL(%VAL(STATUS))
! Create subprocess to calculate taxes
STATUS = SY$CREPRC (,
2          'CALC_TAXES', ! Image
2          '','','
2          'CALC TAXES', ! Process name
2          %VAL(4),      ! Priority
2          ,
2          %VAL(UNIT_BUF),)
IF (.NOT. STATUS) CALL LIB$SIGNAL(%VAL(STATUS))
! Asynchronous read to termination mailbox
! sets flag when tax calculations complete
READ CODE = IO$_READVBLK
LENGTH = 84
STATUS = SY$QIO (%VAL(TAX_DONE), ! Indicates read complete
2          %VAL(MBX_CHAN), ! Channel
2          %VAL(READ_CODE), ! Function code
2          IOSTATUS,, ! Status block
2          %REF(MBX_MESSAGE),! P1
2          %VAL(LENGTH),,,) ! P2
IF (.NOT. STATUS) CALL LIB$SIGNAL (%VAL(STATUS))
! Calculate incomes
.
.
.
! Wait until taxes are calculated
STATUS = SY$WAITFR (%VAL(TAX_DONE))
IF (.NOT. STATUS) CALL LIB$SIGNAL(%VAL(STATUS))
! Check mailbox I/O
IF (.NOT. IOSTATUS.IOSTAT)
2  CALL LIB$SIGNAL (%VAL(IOSTATUS.IOSTAT))

! Calculate net income after taxes
.
.
.
END

```

#### CALC\_TAXES.FOR

```

! Declare calculation variables in installed common
INTEGER*4 INCOME (200),
2          TAXES (200),
2          NET (200)
COMMON /CALC/ INCOME,
2          TAXES,
2          NET

```

(continued on next page)

**Example 3–5 (Cont.) Asynchronous I/O Using a Mailbox**

```
! Calculate taxes
.
.
.
END
```

### 3.3 Intra-Cluster Communication

Intra-cluster communication (ICC), available through ICC system services, forms an application program interface (API) for process-to-process communications. For large data transfers, intra-cluster communication is the highest performance OpenVMS application communication mechanism, better than standard network transports and mailboxes.

Intra-cluster communication enables application program developers to create distributed applications with connections between different processes on a single system or between processes on different systems within a single OpenVMS Cluster system. Intra-cluster communication does not require a network product. It uses memory or System Communication Services (SCS).

The intra-cluster system services used to implement intra-cluster communication do the following:

- Allow the creation of both client and server processes
- Maintain a simple registry of servers and services
- Manage security of the server process namespace and access to server processes
- Establish connections between these processes and transmit data between these processes
- Provide 64-bit buffer and address support

Intra-cluster system services provide the following benefits when implementing ICC:

- An easy-to-use conventional system service interface for interprocess communications within a cluster
- An interface usable for communications between processes within a single, nonclustered node
- An interface callable from all modes and from execlets as well as from images
- An easy-to-use interface giving access to high-speed interconnects such as Memory Channel
- An interface independent of the installation of any networking product
- An interface usable for nonprivileged clients and authorized (but not necessarily privileged) servers

The intra-cluster communication system services are as follows:

- Open Association: SYS\$ICC\_OPEN\_ASSOC
- Close Association: SYS\$ICC\_CLOSE\_ASSOC
- Connect: SYS\$ICC\_CONNECT and SYS\$ICC\_CONNECTTW

## Process Communication

### 3.3 Intra-Cluster Communication

- Accept: SYS\$ICC\_ACCEPT
- Reject: SYS\$ICC\_REJECT
- Disconnect: SYS\$ICC\_DISCONNECT and SYS\$ICC\_DISCONNECTW
- Transmit Data: SYS\$ICC\_TRANSMIT and SYS\$ICC\_TRANSMITW
- Receive Data: SYS\$ICC\_RECEIVE and SYS\$ICC\_RECEIVEW
- Transceive Data: SYS\$ICC\_TRANSCEIVE and SYS\$ICC\_TRANSCEIVEW
- Reply: SYS\$ICC\_REPLY and SYS\$ICC\_REPLYW

See the *OpenVMS System Services Reference Manual: GETUTC-Z* for additional information about the ICC system services.

#### 3.3.1 Programming with Intra-Cluster Communications

The following sections provide information on how to program with intra-cluster communications (ICC) using ICC system services.

##### 3.3.1.1 ICC Concepts

The following terms and their definitions are central to creating and using intra-cluster communication.

An ASSOCIATION is a named link between an application and ICC. The association name, combined with the node name of the system on which the application is running, identifies this application to other applications that want to communicate within a node or cluster.

An ASSOCIATION NAME is a string that identifies an ASSOCIATION. Association Names are 1 to 31 characters in length and must be unique within a node. Association Names are case-sensitive. Associations are created by calling the SYS\$ICC\_OPEN\_ASSOC service (or by the first call to SYS\$ICC\_CONNECT if OPEN was not previously called) and are identified by an Association Handle.

An ASSOCIATION HANDLE is an opaque identifier that represents an association to ICC. Association Handles are passed as unsigned longwords.

A NODE is either a standalone system or a member of an OpenVMS Cluster. It is identified by a one-to-six-character case-blind name that matches the SYSGEN parameter SCSNODE.

A CONNECTION is a link between two associations created by calling the SYS\$ICC\_CONNECT or SYS\$ICC\_ACCEPT service. An association may have multiple simultaneous connections at any given time. A connection is identified by a Connection Handle. A given application may choose to either only initiate connections, or initiate and accept connections as well. Connections support both synchronous and asynchronous communications.

A CONNECTION HANDLE is an opaque identifier that represents a connection to ICC. Connection Handles are passed as unsigned longwords.

In ICC terminology, a SERVER is an application that has declared to ICC that it is willing to accept connections. A server must call SYS\$ICC\_OPEN\_ASSOC and supply the address of a connection routine. Upon receipt of a connection request AST, a server completes its side of the connection by calling the SYS\$ICC\_ACCEPT service. It may also choose not to accept the connection request by calling SYS\$ICC\_REJECT.

A CLIENT, in the ICC model, is an application that calls SYS\$ICC\_CONNECT to request a connection to a server. Note that a server may also be a client. A client need not call SYS\$ICC\_OPEN\_ASSOC (although there are certain benefits to doing so) but may instead call SYS\$ICC\_CONNECT using the supplied constant Default Association Handle. An association opened in this manner is called the Default Association. Only one default association is permitted per process; however, any number of connections may be established even when there is only one association.

The ICC SIMPLE CLUSTERWIDE REGISTRY provides a method for servers to register their node and association names under a single logical name, thus eliminating the need for clients to determine on which node the server process is running. Multiple servers can register under the same logical name, and ICC will randomly select one from the list. The selection algorithm leads to load sharing, but not necessarily to load balancing.

#### 3.3.1.2 Design Considerations

This section contains information about ICC design considerations.

**3.3.1.2.1 Naming** An ICC server may have two visible names—the association name and, if the ICC registry is used, a registry name. The registry name may be the same as the association name.

If, however, you wish to run multiple copies of the server on a single node, the registry name should be the more general name, while the association name should reference a particular instance of the server.

**3.3.1.2.2 Message Ordering** ICC guarantees that messages will be delivered in the order in which they were transmitted. There is no provision for out-of-order delivery.

**3.3.1.2.3 Flow Control** ICC implements flow control on a per-association basis. You can change this value by specifying a value for the MAXFLOWBUFCNT parameter to the SYS\$ICC\_OPEN\_ASSOC service.

In addition to flow control, ICC uses the value of MAXFLOWBUFCNT to determine preallocation of certain resources cached by the services for performance reasons. Increasing this value results in a larger charge against process quotas. The default value of MAXFLOWBUFCNT is 5.

Because all ICC connections within the association are subject to flow control, failure to receive data in a timely manner will eventually cause all connections in the association to stall.

**3.3.1.2.4 Transfer Sizes and Receiving Data** ICC supports two models for receiving data. In the simple receive model, a SYS\$ICC\_RECEIVE call either completes immediately if data is present, or else the receive buffer is queued up to be filled when data arrives from the sender. SYS\$ICC\_RECEIVEW does not return to the caller until either data is present, or the connection has disconnected.

The major disadvantage to this method is that the buffer you supply to SYS\$ICC\_RECEIVE must be large enough to receive the largest message the sender might transmit. Receipt of a message larger than the queued buffer causes ICC to disconnect the link to preserve order. There is no provision within ICC to break a single message over multiple receive calls.

## Process Communication

### 3.3 Intra-Cluster Communication

The second model is data event driven. In this method, the application provides SYS\$ICC\_OPEN\_ASSOC (parameter `recv_rtn`) the address of a routine to be called whenever a connection established over this particular association is the target of a TRANSMIT. The data routine is called at AST level in the original mode of the caller and supplied with the size of the incoming transfer, the connection handle for this transfer, and a user-supplied context value. Once notified of incoming data, the application must then allocate a sufficiently large buffer and issue a SYS\$ICC\_RECEIVE call to obtain the data. The maximum transfer size using this method is 1 Mb.

The SYS\$ICC\_RECEIVE call does not have to be made from the data routine; however, a receive request cannot be made before receipt of a data event. Therefore, receive operations are never queued within ICC when you use a data event.

Because there is a single data routine per association, all connections on the association share the same data routine. To have some connections use both methods, at least two associations must be opened.

**3.3.1.2.5 Transfer Sizes and Transceive** SYS\$ICC\_TRANSCEIVE is a single service that sends a message and completes when the other side responds with a call to SYS\$ICC\_REPLY. The maximum size of the return message is fixed by the size of the buffer the caller provides to the transceive service at the time the call is made. The maximum transmission size for both SYS\$ICC\_TRANSCEIVE and SYS\$ICC\_REPLY is 1 Mb. The minimum length of the reply transmission is zero bytes.

**3.3.1.2.6 Disconnection** In a properly coded communications protocol, responsibility for disconnecting the connection should be left to the side of the protocol that last received data. This rule assures that there is no data in transit in which the state may be uncertain at the time the disconnect event occurs.

An ICC connection may be disconnected under any of the following circumstances:

- One side of the connection calls either SYS\$ICC\_DISCONNECT or SYS\$ICC\_CLOSE\_ASSOC.
- The client or server process in the connection is deleted.
- The node on which one side of the connection is running is either shut down, crashes, or loses communication with the rest of the cluster.
- An unrecoverable error within the ICC services occurs, and the only possible recovery by the service is to disconnect the link.
- A pending receive buffer is too small to receive all the incoming data. To preserve message order, ICC will disconnect the link.

No matter what the cause of the disconnection, the application should be prepared to deal with disconnection other than that as an expected part of the application communication protocol.

**3.3.1.2.7 Error Recovery** Whenever possible, ICC services attempt to return an appropriate status value to the caller, either as the routine status value or in the status fields of the IOSB or IOS\_ICC structure. Sometimes the only recovery method available to ICC is to disconnect the connection. ICC disconnects only when it lacks sufficient context to return status to the calling application.



### 3.3.1.3 General Programming Considerations

The ICC public structures and constants are declared in the module \$ICCDEF (MACRO), within STARLET.REQ for BLISS and ICCDEF.H in SYS\$LIBRARY:SYS\$STARLET\_C.TLB for C. STARLET.H provides full system service prototypes for C.

### 3.3.1.4 Servers

To open an association to ICC, call ICC\$OPEN\_ASSOC, which provides the following parameters:

Parameter	Description
assoc_handle	Address to receive the association handle. (longword) Required.
assoc_name	Address of a string descriptor pointing to the desired association name. If you omit this argument, the ICC default association will be opened. Association names are case sensitive. This is also the name used in the ICC security object for this association.
logical_name logical_table	Address of string descriptors describing the logical name and logical table name for use by the ICC simple registry. The logical name table must exist at the time of the call, and the caller must have write access to the table. Unless your application requires a logical name table for exclusive use of the application, use of the default ICC\$REGISTRY_TABLE is recommended.  The logical name is case sensitive. Table names are always converted to uppercase. The logical name supplied here is the name by which the client using the registry will know the server. If either of these arguments is supplied, they must both be supplied.
conn_event_rtn	Address of a routine to be called whenever a client requests a connection to this server. A server may not omit this parameter. See the sections on connection and disconnection routines for more details about what actions a connection routine must take.
disc_event_rtn	Optional address of a routine to be called when a disconnect event occurs. This may be the same routine as the connection routine. See the section on connection and disconnection routines for more details about what actions a disconnection routine may take.
recv_rtn	Address of routine to be called whenever a connection receives data. Note that all connections on this association use the same routine. Please see the discussion on transfer sizes in Section 3.3.1.2.4 for information on how having or not having a data routine affects maximum receive size. Optional.
maxflowbufcnt	Pass by value the maximum number of inbound messages per connection that ICC will allow before initiating flow control on the connection. The default value for this parameter is 5. Optional.

## Process Communication

### 3.3 Intra-Cluster Communication

Parameter	Description
prot	<p>The default protection for this association. Refer to <i>OpenVMS Guide to System Security</i> for information on the security attributes of ICC associations.</p> <p>This parameter is effective only if no Permanent Security Object has been created for this association.</p> <p>If prot is zero (0) or not specified, all users may connect to this association.</p> <p>If prot is one (1), only members of the same UIC group, or users with SYSPRV, may connect.</p> <p>If prot is two (2), only the owner or users with SYSPRV may connect.</p> <p>Object protection specified by a Permanent Security Object overrides this parameter. Additionally, if no Permanent Security Object exists, the value specified here may be overridden by the SET SECURITY command issued for the Temporary Security Object while the association is open.</p>

**3.3.1.4.1 Connection Events** Once the association is opened, connection requests are delivered as asynchronous calls to the server's connection routine.

The connection routine (and disconnection routine, if supplied) are each called with seven arguments as described in the \$ICC\_OPEN\_ASSOC system service, located in the *OpenVMS System Services Reference Manual: GETUTC-Z*.

A single connection or disconnection routine may distinguish between the events based on the first argument (event\_type), which will either be the code ICC\$\_EV\_CONNECT or ICC\$\_EV\_DISCONNECT.

A connection routine must either call SYS\$ICC\_ACCEPT to complete the connection or SYS\$ICC\_REJECT to reject the connection. The EPID and username of the requesting process are supplied by ICC. Any additional information required by the application for verification either must be supplied by the client via the connection data parameter or must be obtainable by the server itself (for example, via SYS\$GETJPI.)

Failure to ACCEPT or REJECT the connection will stall all additional attempts to connect to this server.

**3.3.1.4.2 Disconnection Events** A disconnect event signals either that the partner application of the connection has requested a disconnect, the partner process has been deleted, or that the remote node has left the cluster. Upon receiving a disconnect event, the server should call SYS\$ICC\_DISCONNECT to clean up the server side of the connection.

Failure to call DISCONNECT may leave resources allocated to the connection that will not be released until the image terminates. In the case of inner mode associations, resources will be released at process termination.

#### 3.3.1.5 Clients

A simple client need not call SYS\$ICC\_OPEN\_ASSOC although there may be some benefits for even the simplest clients. For a client, the major benefit of calling OPEN is declaring a data receive routine.

In cases where a client may wish to connect to multiple servers, calling OPEN\_ASSOC multiple times can help isolate the routines related to data receipt and disconnection.

## Process Communication

### 3.3 Intra-Cluster Communication

Call SYS\$ICC\_CONNECT[W] with the following arguments:

Argument	Description
IOS_ICC	Address of an IOS_ICC structure (defined in ICCDEF).
astadr astprm	Optional AST address and parameter.
assoc_handle	Either the value returned from the OPEN_ASSOC call or the constant ICC\$DEFAULT_ASSOC if OPEN_ASSOC was not called.
conn_handle	Address of a longword to receive the connection handle for this connection.
remote_assoc	A string descriptor pointing to either the association name of the server or the registry name of the server if the server is using the ICC simple registry. Either use is case sensitive.
remote_node	If omitted, then the assoc_name argument will be treated as a name to look up in the ICC simple registry. A zero length or blank string represents the local node. Any other string will be converted to uppercase and must match the name of a node in the cluster.
user_context	A unique context value for this connection. This value will be passed to data event and disconnection routines.
conn_buf conn_buf_len	Address and length of any connection data. This could include additional authentication or protocol setup data required by the application.
return_buf return_buf_len retlen_addr	Address and length of a buffer to receive any data (accept or reject data) returned from the server. The buffer must be large enough to receive the maximum amount of data the server might return. The actual number of bytes will be written to retlen_addr.
flags	The only valid flag is ICC\$M_SYNCH_MODE. If you select synch mode, the data transmission routines (TRANSMIT, REPLY, and RECEIVE—TRANSCIVE can never complete synchronously) may return the alternate success status SS\$_SYNCH and not call the AST completion routine. If you do not specify synch mode, the AST routine, if provided, will always be called.

When the CONNECT call completes, the connection is established and useable only if success status was returned as both the return value of the service and in the status fields (ios\_icc\$w\_status and ios\_icc\$l\_remstat) of the IOS\_ICC.



---

## Process Control

This chapter describes how to use operating system features to control a process or kernel thread. It contains the following sections:

Section 4.1 describes the control of a process or kernel thread to complete a programming task.

Section 4.2 describes how to use the operating system's process information services to gather information about a process or kernel thread.

Section 4.3 describes how to change a process's scheduling.

Section 4.4 describes the affinity and capability mechanisms for CPU scheduling.

Section 4.5 describes the class scheduler and how to use it on both VAX and Alpha systems.

Section 4.6 describes how to change a process's name.

Section 4.7 describes how to access another process's context.

Section 4.8 describes how to synchronize programs by setting specific times for program execution.

Section 4.9 describes how to suspend, resume, and stop program execution.

### 4.1 Using Process Control for Programming Tasks

Process control features in the operating system allow you to employ the following techniques to design your application:

- Modularize application programs so that each process or kernel thread of the application executes a single task
- Perform parallel processing, in which one process or kernel thread executes one part of a program while another process or kernel thread executes another part
- Implement application program control, in which one process manages and coordinates the activities of several other processes
- Schedule program execution
- Dedicate a process to execute DCL commands
- Isolate code for one or more of the following reasons:
  - To debug logic errors
  - To execute privileged code
  - To execute sensitive code

## Process Control

### 4.1 Using Process Control for Programming Tasks

Among the services and routines the operating system provides to help you monitor and control the processes or kernel threads involved in your application are those that perform the following functions:

- Obtaining process information
- Obtaining kernel thread information
- Setting process privileges
- Setting process name
- Setting process scheduling
- Hibernating or suspending a process or kernel thread
- Deleting a process
- Synchronizing process execution

You can use system routines and DCL commands to accomplish these tasks. Table 4–1 summarizes which routines and commands to use. You can use the DCL commands in a command procedure that is executed as soon as the subprocess (or detached process) is created.

For process synchronization techniques other than specifying a time for program execution, refer to Chapters 6, 7, and 8.

**Table 4–1 Routines and Commands for Controlling Processes and Kernel Threads**

Routine	DCL Command	Task
LIB\$GETJPI SYS\$GETJPI SYS\$GETJPIW	SHOW PROCESS	Return process or kernel thread information. SYS\$GETJPI(W) can request process and thread information from a specific PID or PRCNAM. If no specific thread is identified, then the data represents the initial thread.
SYS\$SETPRV	SET PROCESS	Set process privileges.
SYS\$SETPRI	SET PROCESS	Set process or kernel thread priority. This service affects the base and current priority of a specified kernel thread and not the entire process.
SYS\$SETSWM	SET PROCESS	Control swapping of process.
SYS\$HIBER SYS\$SUSPND SYS\$RESUME	SET PROCESS	Hibernate, suspend, and resume a process or kernel threads. These services hibernate, suspend, or resume all kernel threads associated with the specified process.
SYS\$SETPRN	SET PROCESS	Set process name.
SYS\$FORCEX SYS\$EXIT	EXIT and STOP	Initiate process and image rundown. All associated kernel threads of a specified process are run down and deleted.
SYS\$DELPRC	EXIT and STOP	Delete process.

(continued on next page)

## 4.1 Using Process Control for Programming Tasks

Table 4–1 (Cont.) Routines and Commands for Controlling Processes and Kernel Threads

Routine	DCL Command	Task
SYS\$CANTIM	CANCEL	Cancel timer for process or kernel threads. This service finds and cancels all timers for all threads associated with the specified process.
SYS\$ADJSTK	SET PROCESS	Adjust or initialize a stack pointer. Stack adjustments are performed for the kernel thread requesting the service.
SYS\$PROCESS_SCAN	SHOW PROCESS	Scan for a process or kernel thread on the local system, or across the nodes in an OpenVMS Cluster system.
SYS\$SETSTK	None available	Allow the current process or kernel thread to change the size of its stacks. This service adjusts the size of the stacks of the kernel thread that invoked the service.

By default, the routines and commands reference the current process or kernel thread. To reference another process, you must specify either the process identification (PID) number or the process name when you call the routine or a command qualifier when you enter commands. You must have the GROUP privilege to reference a process with the same group number and a different member number in its UIC, and WORLD privilege to reference a process with a different group number in its UIC.

The information presented in this section covers using the routines. If you want to use the DCL commands in a command procedure, refer to the *OpenVMS DCL Dictionary*.

#### 4.1.1 Determining Privileges for Process Creation and Control

There are three levels of process control privilege:

- Processes with the same UIC can always issue process control services for one another.
- You need the GROUP privilege to issue process control services for other processes executing in the same group.
- You need the WORLD privilege to issue process control services for any process in the system.

You need additional privileges to perform some specific functions; for example, raising the base priority of a process requires ALTPRI privilege.

#### 4.1.2 Determining Process Identification

There are two types of process identification:

- Process identification (PID) number

The system assigns this unique 32-bit number to a process when it is created. If you provide the **pidadr** argument to the SYS\$CREPRC system service, the system returns the process identification number at the location specified. You can then use the process identification number in subsequent process control services.

## Process Control

### 4.1 Using Process Control for Programming Tasks

- Process name

There are two types of process names:

- Process name

A process name is a 1- to 15-character name string. Each process name must be unique within its group (processes in different groups can have the same name). You can assign a name to a process by specifying the **prcnam** argument when you create it. You can then use this name to refer to the process in other system service calls. Note that you cannot use a process name to specify a process outside the caller's group; you must use a process identification (PID) number.

- Full process name

The full process name is unique for each process in the cluster. Full process name strings can be up to 23 characters long and are configured in the following way:

1–6 characters for the node name  
2 characters for the colons (::) that follow the node name  
1–15 characters for the local process name

For example, you could call the SYS\$CREPRC system service, as follows:

```
unsigned int orionid=0, status;  
$DESCRIPTOR(orion, "ORION");  
.  
.  
.  
status = SYS$CREPRC(&orionid,          /* pidadr (process id returned) */  
                  &orion,            /* prcnam - process name */  
                  . . . );
```

The service returns the process identification in the longword at ORIONID. You can now use either the process name (ORION) or the PID (ORIONID) to refer to this process in other system service calls.

A process can set or change its own name with the Set Process Name (\$SETPRN) system service. For example, a process can set its name to CYGNUS, as follows:

```
/* Descriptor for process name */  
$DESCRIPTOR(cygnus, "CYGNUS");  
status = SYS$SETPRN( &cygnus ); /* prcnam - process name */
```

Most of the process control services accept the **prcnam** or the **pidadr** argument or both. However, you should identify a process by its process identification number for the following reasons:

- The service executes faster because it does not have to search a table of process names.
- For a process not in your group, you must use the process identification number (see Section 4.1.3).

If you specify the PID address, the service uses the PID address. If you specify the process name without a PID address, the service uses the process name. If you specify both—the process name and PID address—it uses the PID address unless the contents of the PID is 0. In that case, the service uses the process name. If you specify a PID address of 0 without a process name, then the service is performed for the calling process.



## 4.1 Using Process Control for Programming Tasks

If you specify neither the process name argument nor the process identification number argument, the service is performed for the calling process. If the PID address is specified, the service returns the PID of the target process in it. Table 4–2 summarizes the possible combinations of these arguments and explains how the services interpret them.

**Table 4–2 Process Identification**

Process Name Specified?	PID Address Specified?	Contents of PID	Resultant Action by Services
No	No	–	The process identification of the calling process is used, but is not returned.
No	Yes	0	The process identification of the calling process is used and returned.
No	Yes	PID	The process identification is used and returned.
Yes	No	–	The process name is used. The process identification is not returned.
Yes	Yes	0	The process name is used and the process identification is returned.
Yes	Yes	PID	The process identification is used and returned; the process name is ignored.

### 4.1.3 Qualifying Process Naming Within Groups

Process names are always qualified by their group number. The system maintains a table of all process names and the UIC associated with each. When you use the **prcnam** argument in a process control service, the table is searched for an entry that contains the specified process name and the group number of the calling process.

To use process control services on processes within its group, a calling process must have the GROUP user privilege; this privilege is not required when you specify a process with the same UIC as the caller.

The search for a process name fails if the specified process name does not have the same group number as the caller. The search fails even if the calling process has the WORLD user privilege. To execute a process control service for a process that is not in the caller's group, the requesting process must use a process identification and must have the WORLD user privilege.

## 4.2 Obtaining Process Information

The operating system's process information procedures enable you to gather information about processes and kernel threads. You can obtain information about either one process or a group of processes on either the local system or on remote nodes in an OpenVMS Cluster system. You can also obtain process lock information. DCL commands such as SHOW SYSTEM and SHOW PROCESS use the process information procedures to display information about processes. You can also use the process information procedures within your programs.

## Process Control

### 4.2 Obtaining Process Information

The following are process information procedures:

- Get Job/Process Information (SYS\$GETJPI(W))
- Get Job/Process Information (LIB\$GETJPI)
- Process Scan (SYS\$PROCESS\_SCAN)
- Get Lock Information (SYS\$GETLKI)

The SYS\$GETJPI(W) and SYS\$PROCESS\_SCAN system services can also be used to get kernel threads information. SYS\$GETJPI(W) can request threads information from a particular process ID or process name. SYS\$PROCESS\_SCAN can request information about all threads in a process, or all threads for each multithreaded process on the system.

For more information about SYS\$GETJPI, SYS\$PROCESS\_SCAN, and SYS\$GETLKI, see the *OpenVMS System Services Reference Manual*.

The differences among these procedures are as follows:

- SYS\$GETJPI operates asynchronously.
- SYS\$GETJPIW and LIB\$GETJPI operate synchronously.
- SYS\$GETJPI and SYS\$GETJPIW can obtain one or more pieces of information about a process or kernel thread in a single call.
- LIB\$GETJPI can obtain only one piece of information about a process or kernel thread in a single call.
- SYS\$GETJPI and SYS\$GETJPIW can specify an AST to execute at the completion of the routine.
- SYS\$GETJPI and SYS\$GETJPIW can use an I/O status block (IOSB) to test for completion of the routine.
- LIB\$GETJPI can return some items either as strings or as numbers. It is often the easiest to call from a high-level language because the caller is not required to construct an item list.
- SYS\$GETLKI returns information about the lock database.

#### 4.2.1 Using the PID to Obtain Information

The process information procedures return information about processes by using the process identification (PID) or the process name. The PID is a 32-bit number that is unique for each process in the cluster. Specify the PID by using the **pidadr** argument. You must specify all the significant digits of a PID; you can omit leading zeros.

With kernel threads, the PID continues to identify a process, but it can also identify a kernel thread within that process. In a multithreaded process each kernel thread has its own PID that is based on the initial threads PID.

#### 4.2.2 Using the Process Name to Obtain Information

To obtain information about a process using the process name, specify the **prcnam** argument. Although a PID is unique for each process in the cluster, a process name is unique (within a UIC group) only for each process on a node. To locate information about processes on the local node, specify a process name string of 1 to 15 characters. To locate information about a process on a particular node, specify the full process name, which can be up to 23 characters long. The full process name is configured in the following way:

## Process Control

### 4.2 Obtaining Process Information

- 1 to 6 characters for the node name
- 2 characters for the colons (:) that follow the node name
- 1 to 15 characters for the local process name

Note that a local process name can look like a remote process name. Therefore, if you specify ATHENS::SMITH, the system checks for a process named ATHENS::SMITH on the local node before checking node ATHENS for a process named SMITH.

Chapter 17 and the *OpenVMS System Services Reference Manual* describe these routines completely, listing all items of information that you can request. LIB\$GETJPI, SYS\$GETJPI, and SYS\$GETJPIW share the same item codes with the following exception: LIB\$K\_ items can be accessed only by LIB\$GETJPI.

In the following example, the string argument rather than the numeric argument is specified, causing LIB\$GETJPI to return the UIC of the current process as a string:

```
! Define request codes
INCLUDE '($JPIDEF)'

! Variables for LIB$GETJPI
CHARACTER*9 UIC
INTEGER LEN

STATUS = LIB$GETJPI (JPI$_UIC,
2                    ' ',
2                    UIC,
2                    LEN)
```

To specify a list of items for SYS\$GETJPI or SYS\$GETJPI(W) (even if that list contains only one item), use a record structure. Example 4-1 uses SYS\$GETJPI(W) to request the process name and user name associated with the process whose process identification number is in SUBPROCESS\_PID.

#### Example 4-1 Obtaining Different Types of Process Information

```
.
.
.
! PID of subprocess
INTEGER SUBPROCESS_PID

! Include the request codes
INCLUDE '($JPIDEF)'
```

(continued on next page)

## Process Control

### 4.2 Obtaining Process Information

#### Example 4–1 (Cont.) Obtaining Different Types of Process Information

```
! Define itmlst structure
STRUCTURE /ITMLST/
  UNION
    MAP
      INTEGER*2 BUFLN
      INTEGER*2 CODE
      INTEGER*4 BUFADR
      INTEGER*4 RETLENADR
    END MAP
    MAP
      INTEGER*4 END_LIST
    END MAP
  END UNION
END STRUCTURE
! Declare GETJPI itmlst
RECORD /ITMLST/ JPI_LIST(3)
! Declare buffers for information
CHARACTER*15  PROCESS_NAME
CHARACTER*12  USER_NAME
INTEGER*4     PNAME_LEN,
2            UNAME_LEN
! Declare I/O status structure
STRUCTURE /IOSB/
  INTEGER*2 STATUS,
2          COUNT
  INTEGER*4 %FILL
END STRUCTURE
! Declare I/O status variable
RECORD /IOSB/ JPISTAT
! Declare status and routine
INTEGER*4     STATUS,
2            SYS$GETJPIW
.
. ! Define SUBPROCESS_PID
.
! Set up itmlst
JPI_LIST(1).BUFLN   = 15
JPI_LIST(1).CODE    = JPI$ PRCNAM
JPI_LIST(1).BUFADR  = %LOC(PROCESS_NAME)
JPI_LIST(1).RETLENADR = %LOC(PNAME_LEN)
JPI_LIST(2).BUFLN   = 12
JPI_LIST(2).CODE    = JPI$ USERNAME
JPI_LIST(2).BUFADR  = %LOC(USER_NAME)
JPI_LIST(2).RETLENADR = %LOC(UNAME_LEN)
JPI_LIST(3).END_LIST = 0
```

(continued on next page)

**Example 4–1 (Cont.) Obtaining Different Types of Process Information**

```

! Request information and wait for it
STATUS = SYS$GETJPIW (,
2         SUBPROCESS_PID,
2         ,
2         JPI_LIST,
2         JPISTAT,
2         ,)
IF (.NOT. STATUS) CALL LIB$SIGNAL (%VAL(STATUS))
! Check final return status
IF (.NOT. JPISTAT.STATUS) THEN
    CALL LIB$SIGNAL (%VAL(JPISTAT.STATUS))
END IF
.
.
.

```

**4.2.3 Using SYS\$GETJPI and LIB\$GETJPI**

SYS\$GETJPI uses the PID or the process name to obtain information about one process and the `-1` wildcard as the **pidadr** to obtain information about all processes on the local system. If a PID or process name is not specified, SYS\$GETJPI returns information about the calling process. SYS\$GETJPI cannot perform a selective search—it can search for only one process at a time in the cluster or for all processes on the local system. If you want to perform a selective search for information or get information about processes across the cluster, use SYS\$GETJPI with SYS\$PROCESS\_SCAN.

**4.2.3.1 Requesting Information About a Single Process**

Example 4–2 is a Fortran program that displays the process name and the PID of the calling program. If you want to get the same information about each process on the system, specify the initial process identification argument as `-1` when you invoke LIB\$GETJPI or SYS\$GETJPI(W). Call the GETJPI routine (whichever you choose) repeatedly until it returns a status of SS\$\_NOMOREPROC, indicating that all processes on the system have been examined.

**Example 4–2 Using SYS\$GETJPI to Obtain Calling Process Information**

```

! No process name or PID is specified; $GETJPI returns data on the
! calling process.

```

```

PROGRAM CALLING_PROCESS
IMPLICIT NONE                                ! Implicit none
INCLUDE '($jpidef) /nolist'                 ! Definitions for $GETJPI
INCLUDE '($ssdef) /nolist'                  ! System status codes
STRUCTURE /JPIITMLST/                        ! Structure declaration for
UNION                                        ! $GETJPI item lists
MAP
    INTEGER*2 BUFLN,
2    CODE
    INTEGER*4 BUFADR,
2    RETLENADR

```

(continued on next page)

## Process Control

### 4.2 Obtaining Process Information

#### Example 4-2 (Cont.) Using SYS\$GETJPI to Obtain Calling Process Information

```

        END MAP
        MAP                                ! A longword of 0 terminates
        INTEGER*4 END_LIST                 ! an item list
        END MAP
    END UNION
END STRUCTURE
RECORD /JPIITMLST/                        ! Declare the item list for
2          JPILIST(3)                     ! $GETJPI

INTEGER*4 SYS$GETJPIW                     ! System service entry points

INTEGER*4 STATUS,                         ! Status variable
2          PID                             ! PID from $GETJPI

INTEGER*2 IOSB(4)                         ! I/O Status Block for $GETJPI

CHARACTER*16
2          PRCNAM                          ! Process name from $GETJPI
INTEGER*2 PRCNAM_LEN                      ! Process name length
! Initialize $GETJPI item list

JPILIST(1).BUFLen      = 4
JPILIST(1).CODE        = JPI$ PID
JPILIST(1).BUFADR      = %LOC(PID)
JPILIST(1).RETLENADR   = 0
JPILIST(2).BUFLen     = LEN(PRCNAM)
JPILIST(2).CODE       = JPI$ PRCNAM
JPILIST(2).BUFADR     = %LOC(PRCNAM)
JPILIST(2).RETLENADR  = %LOC(PRCNAM_LEN)
JPILIST(3).END_LIST   = 0
! Call $GETJPI to get data for this process

STATUS = SYS$GETJPIW (
2          ,                               ! No event flag
2          ,                               ! No PID
2          ,                               ! No process name
2          JPILIST,                       ! Item list
2          IOSB,                          ! Always use IOSB with $GETJPI!
2          ,                               ! No AST
2          )                               ! No AST arg
! Check the status in both STATUS and the IOSB, if
! STATUS is OK then copy IOSB(1) to STATUS

IF (STATUS) STATUS = IOSB(1)

! If $GETJPI worked, display the process, if done then
! prepare to exit, otherwise signal an error

IF (STATUS) THEN
    TYPE 1010, PID, PRCNAM(1:PRCNAM_LEN)
    FORMAT (' ',Z8.8,' ',A)
ELSE
    CALL LIB$SIGNAL(%VAL(STATUS))
END IF
END
1010

```

## Process Control

### 4.2 Obtaining Process Information

Example 4–3 creates the file PROCNAME.RPT that lists, using LIB\$GETJPI, the process name of each process on the system. If the process running this program does not have the privilege necessary to access a particular process, the program writes the words NO PRIVILEGE in place of the process name. If a process is suspended, LIB\$GETJPI cannot access it and the program writes the word SUSPENDED in place of the process name. Note that, in either of these cases, the program changes the error value in STATUS to a success value so that the loop calling LIB\$GETJPI continues to execute.

#### Example 4–3 Obtaining the Process Name

```
.
:
.
! Status variable and error codes
INTEGER STATUS,
2     STATUS OK,
2     LIB$GET LUN,
2     LIB$GETJPI
INCLUDE '($SSDEF)'
PARAMETER (STATUS_OK = 1)

! Logical unit number and file name
INTEGER*4 LUN
CHARACTER*(*) FILE_NAME
PARAMETER (FILE_NAME = 'PROCNAME.RPT')
! Define item codes for LIB$GETJPI
INCLUDE '($JPIDEF)'

! Process name
CHARACTER*15 NAME
INTEGER LEN
! Process identification
INTEGER PID /-1/

.
:
.
! Get logical unit number and open the file
STATUS = LIB$GET LUN (LUN)
OPEN (UNIT = LUN,
2     FILE = 'PROCNAME.RPT',
2     STATUS = 'NEW')
! Get information and write it to file
DO WHILE (STATUS)
    STATUS = LIB$GETJPI(JPI$ PRCNAM,
2                     PID,
2                     '',
2                     NAME,
2                     LEN)
```

(continued on next page)

## Process Control

### 4.2 Obtaining Process Information

#### Example 4–3 (Cont.) Obtaining the Process Name

```
! Extra space in WRITE commands is for
! FORTRAN carriage control
IF (STATUS) THEN
  WRITE (UNIT = LUN,
2     FMT = '(2A)' ' ', NAME(1:LEN)
      STATUS = STATUS_OK
ELSE IF (STATUS .EQ. SS$_NOPRIV) THEN
  WRITE (UNIT = LUN,
2     FMT = '(2A)' ' ', 'NO PRIVILEGE'
      STATUS = STATUS_OK
ELSE IF (STATUS .EQ. SS$_SUSPENDED) THEN
  WRITE (UNIT = LUN,
2     FMT = '(2A)' ' ', 'SUSPENDED'
      STATUS = STATUS_OK
END IF
END DO
! Close file
IF (STATUS .EQ. SS$_NOMOREPROC)
2  CLOSE (UNIT = LUN)
.
.
.
```

Example 4–4 demonstrates how to use the process name to obtain information about a process.

#### Example 4–4 Using SYS\$GETJPI and the Process Name to Obtain Information About a Process

```
! To find information for a particular process by name,
! substitute this code, which includes a process name,
! to call $GETJPI in Example 4-2

! Call $GETJPI to get data for a named process

STATUS = SYS$GETJPIW (
2     ,           ! No event flag
2     ,           ! No PID
2     'SMITH_1', ! Process name
2     JPILIST,   ! Item list
2     IOSB,      ! Always use IOSB with $GETJPI!
2     ,           ! No AST
2     )          ! No AST arg
```

#### 4.2.3.2 Requesting Information About All Processes on the Local System

You can use SYS\$GETJPI to perform a wildcard search on all processes on the local system. When the initial **pidadr** argument is specified as **-1**, SYS\$GETJPI returns requested information for each process that the program has privilege to access. The requested information is returned for one process per call to SYS\$GETJPI.

To perform a wildcard search, call SYS\$GETJPI in a loop, testing the return status.



## Process Control

### 4.2 Obtaining Process Information

When performing wildcard searches, SYS\$GETJPI returns an error status for processes that are inaccessible. When a program that uses a -1 wildcard checks the status value returned by SYS\$GETJPI, it should test for the following status codes:

Status	Explanation
SS\$_NOMOREPROC	All processes have been returned.
SS\$_NOPRIV	The caller lacks sufficient privilege to examine a process.
SS\$_SUSPENDED	The target process is being deleted or is suspended and cannot return the information.

Example 4-5 is a C program that demonstrates how to use the SYS\$GETJPI -1 wildcard to search for all processes on the local system.

#### Example 4-5 Using SYS\$GETJPI to Request Information About All Processes on the Local System

```
#include <stdio.h>
#include <jpidef.h>
#include <stdlib.h>
#include <ssdef.h>

/* Item descriptor */
struct {
    unsigned short buflen, item_code;
    void *bufaddr;
    void *retlenaddr;
    unsigned int terminator;
}itm_lst;

/* I/O Status Block */
struct {
    unsigned short iostat;
    unsigned short iolen;
    unsigned int device_info;
}iosb;

main() {
    unsigned short len;
    unsigned int efn=1,pidadr = -1,status, usersize;
    char username[12];

    /* Initialize the item list */
    itm_lst.buflen = 12;
    itm_lst.item_code = JPI$_USERNAME;
    itm_lst.bufaddr = username;
    itm_lst.retlenaddr = &usersize;
    itm_lst.terminator = 0;

    do{
```

(continued on next page)

## Process Control

### 4.2 Obtaining Process Information

#### Example 4–5 (Cont.) Using SYS\$GETJPI to Request Information About All Processes on the Local System

```
        status = SYS$GETJPIW(0,          /* no event flag */
                             &pidadr,   /* process id */
                             0,          /* process name */
                             &itm_lst,  /* item list */
                             &iosb,     /* I/O status block */
                             0,          /* astadr (AST routine) */
                             0);         /* astprm (AST parameter) */
        switch(status)
        {
case SS$_NOPRIV:
        printf("\nError: No privileges for attempted operation");
        break;
case SS$_SUSPENDED:
        printf("\nError: Process is suspended");
        break;
case SS$_NORMAL:
        if (iosb.iostat == SS$_NORMAL)
            printf("\nUsername: %s",username);
        else
            printf("\nIOSB condition value %d returned",iosb.iostat);
        }
    }while(status != SS$_NOMOREPROC);
}
```

#### 4.2.4 Using SYS\$GETJPI with SYS\$PROCESS\_SCAN

Using the SYS\$PROCESS\_SCAN system service greatly enhances the power of SYS\$GETJPI. With this combination, you can search for selected groups of processes or kernel threads on the local system as well as for processes or kernel threads on remote nodes or across the cluster. When you use SYS\$GETJPI alone, you specify the **pidadr** or the **prcnam** argument to locate information about one process. When you use SYS\$GETJPI with SYS\$PROCESS\_SCAN, the **pidctx** argument generated by SYS\$PROCESS\_SCAN is used as the **pidadr** argument to SYS\$GETJPI. This context allows SYS\$GETJPI to use the selection criteria that are set up in the call to SYS\$PROCESS\_SCAN.

When using SYS\$GETJPI with a PRCNAM specified, SYS\$GETJPI returns data for only the initial thread. This parallels the behavior of the DCL commands SHOW SYSTEM, SHOW PROCESS, and MONITOR PROCESS. If a valid PIDADR is specified, then the data returned describes only that specific kernel thread. If a PIDADR of zero is specified, then the data returned describes the calling kernel thread.

SYS\$GETJPI has the flag, JPI\$\_THREAD, as part of the JPI\$\_GETJPI\_CONTROL\_FLAGS item code. The JPI\$\_THREAD flag designates that the service call is requesting data for all of the kernel threads in a multithreaded process. If the call is made with JPI\$\_THREAD set, then SYS\$GETJPI begins with the initial thread, and SYS\$GETJPI returns SS\$\_NORMAL. Subsequent calls to SYS\$GETJPI with JPI\$\_THREAD specified returns data for the next thread until there are no more threads, at which time the service returns SS\$\_NOMORETHREAD.

If you specify a wildcard PIDADR `-1` along with `JPI$_THREAD`, you cause `SYS$GETJPI` to return information for all threads for all processes on the system on subsequent calls. `SYS$GETJPI` returns the status `SS$_NORMAL` until there are no more processes, at which time it returns `SS$_NOMOREPROC`. If you specify a wildcard search, you must request either the `JPI$_PROC_INDEX` or the `JPI$_INITIAL_THREAD_PID` item code to distinguish the transition from the last thread of a multithreaded process to the next process. The `PROC_INDEX` and the `INITIAL_THREAD_PID` are different for each process on the system.

Table 4-3 shows four item codes of `SYS$GETJPI` that provide kernel threads information.

**Table 4-3 SYS\$GETJPI Kernel Threads Item Codes**

Item Code	Meaning
<code>JPI\$_INITIAL_THREAD_PID</code>	Returns the PID of the initial thread for the target process
<code>JPI\$_KT_COUNT</code>	Returns the current count of kernel threads for the target process
<code>JPI\$_MULTITHREAD</code>	Returns the maximum kernel thread count allowed for the target process
<code>JPI\$_THREAD_INDEX</code>	Returns the kernel thread index for the target thread or process

This wildcard search is initiated by invoking `SYS$GETJPI` with a `-1` specified for the PID, and is available only on the local node. With kernel threads, a search for all threads in a single process is available, both on the local node and on another node on the cluster.

In a dual architecture or mixed-version cluster, one or more nodes in the cluster may not support kernel threads. To indicate this condition, a threads capability bit (`CSB$_M_CAP_THREADS`) exists in the `CSB$_L_CAPABILITY` cell in the cluster status block. If this bit is set for a node, it indicates that the node supports kernel threads. This information is passed around as part of the normal cluster management activity when a node is added to a cluster. If a `SYS$GETJPI` request that requires threads support needs to be passed to another node in the cluster, a check is made on whether the node supports kernel threads before the request is sent to that node. If the node supports kernel threads, the request is sent. If the node does not support kernel threads, the status `SS$_INCOMPAT` is returned to the caller, and the request is not sent to the other node.

You can use `SYS$PROCESS_SCAN` only with `SYS$GETJPI`; you cannot use it alone. The process context generated by `SYS$PROCESS_SCAN` is used like the `-1` wildcard except that it is initialized by calling the `SYS$PROCESS_SCAN` service instead of by a simple assignment statement. However, the `SYS$PROCESS_SCAN` context is more powerful and more flexible than the `-1` wildcard. `SYS$PROCESS_SCAN` uses an item list to specify selection criteria to be used in a search for processes and produces a context longword that describes a selective search for `SYS$GETJPI`.

Using `SYS$GETJPI` with `SYS$PROCESS_SCAN` to perform a selective search is a more efficient way to locate information because only information about the processes you have selected is returned. For example, you can specify a search for processes owned by one user name, and `SYS$GETJPI` returns only the processes that match the specified user name. You can specify a search for

## Process Control

### 4.2 Obtaining Process Information

all batch processes, and `SYS$GETJPI` returns only information about processes running as batch jobs. You can specify a search for all batch processes owned by one user name and `SYS$GETJPI` returns only information about processes owned by that user name that are running as batch jobs.

By default, `SYS$PROCESS_SCAN` sets up a context for only the initial thread of a multithreaded process. However, if the value `PSCAN$_THREAD` is specified for the item code `PSCAN$_PSCAN_CONTROL_FLAGS`, then threads are included in the scan. The `PSCAN$_THREAD` flag takes precedence over the `JPI$_THREAD` flag in the `SYS$GETJPI` call. With `PSCAN$_THREAD` specified, threads are included in the entire scan. With `PSCAN$_THREAD` not specified, threads are included in the scan for a specific `SYS$GETJPI` call only if `JPI$_THREAD` is specified.

Table 4–4 shows two item codes of `SYS$PROCESS_SCAN` that provide kernel thread information.

**Table 4–4 `SYS$PROCESS_SCAN` Kernel Threads Item Codes**

Item Code	Meaning
<code>PSCAN\$_KT_COUNT</code>	Uses the current count of kernel threads for the process as a selection criteria. The valid item-specific flags for this item code are <code>EQL</code> , <code>GEQ</code> , <code>GTR</code> , <code>LEQ</code> , <code>LSS</code> , <code>NEQ</code> , and <code>OR</code> .
<code>PSCAN\$_MULTITHREAD</code>	Uses the maximum count of kernel threads for the process as a selection criteria. The valid item-specific flags for this item code are <code>EQL</code> , <code>GEQ</code> , <code>GTR</code> , <code>LEQ</code> , <code>LSS</code> , <code>NEQ</code> , and <code>OR</code> .

#### 4.2.4.1 Using `SYS$PROCESS_SCAN` Item List and Item-Specific Flags

`SYS$PROCESS_SCAN` uses an item list to specify the selection criteria for the `SYS$GETJPI` search.

Each entry in the `SYS$PROCESS_SCAN` item list contains the following:

- The attribute of the process to be examined
- The value of the attribute or a pointer to the value
- Item-specific flags to control how to interpret the value

Item-specific flags enable you to control selection information. For example, you can use flags to select only those processes that have attribute values that correspond to the value in the item list, as shown in Table 4–5.

**Table 4–5 Item-Specific Flags**

Item-Specific Flag	Description
<code>PSCAN\$_M_OR</code>	Match this value or the next value
<code>PSCAN\$_M_EQL</code>	Match value exactly (the default)
<code>PSCAN\$_M_NEQ</code>	Match if value is not equal
<code>PSCAN\$_M_GEQ</code>	Match if value is greater than or equal to
<code>PSCAN\$_M_GTR</code>	Match if value is greater than
<code>PSCAN\$_M_LEQ</code>	Match if value is less than or equal to

(continued on next page)

**Table 4–5 (Cont.) Item-Specific Flags**

Item-Specific Flag	Description
PSCAN\$M_LSS	Match if value is less than
PSCAN\$M_CASE_BLIND	Match without regard to case of letters
PSCAN\$M_PREFIX_MATCH	Match on the leading substring
PSCAN\$M_WILDCARD	Match string is a wildcard pattern

The PSCAN\$M\_OR flag is used to connect entries in an item list. For example, in a program that searches for processes owned by several specified users, you must specify each user name in a separate item list entry. The item list entries are connected with the PSCAN\$M\_OR flag as shown in the following Fortran example. This example connects all the processes on the local node that belong to SMITH, JONES, or JOHNSON.

```
PSCANLIST(1).BUFLEN = LEN('SMITH')
PSCANLIST(1).CODE   = PSCAN$ USERNAME
PSCANLIST(1).BUFADR = %LOC('SMITH')
PSCANLIST(1).ITMFLAGS = PSCAN$M_OR
PSCANLIST(2).BUFLEN = LEN('JONES')
PSCANLIST(2).CODE   = PSCAN$ USERNAME
PSCANLIST(2).BUFADR = %LOC('JONES')
PSCANLIST(2).ITMFLAGS = PSCAN$M_OR
PSCANLIST(3).BUFLEN = LEN('JOHNSON')
PSCANLIST(3).CODE   = PSCAN$ USERNAME
PSCANLIST(3).BUFADR = %LOC('JOHNSON')
PSCANLIST(3).ITMFLAGS = 0
PSCANLIST(4).END_LIST = 0
```

Use the PSCAN\$M\_WILDCARD flag to specify that a character string is to be treated as a wildcard. For example, to find all process names that begin with the letter A and end with the string ER, use the string A\*ER with the PSCAN\$M\_WILDCARD flag. If you do not specify the PSCAN\$M\_WILDCARD flag, the search looks for the 4-character process name A\*ER.

The PSCAN\$M\_PREFIX\_MATCH defines a wildcard search to match the initial characters of a string. For example, to find all process names that start with the letters AB, use the string AB with the PSCAN\$M\_PREFIX\_MATCH flag. If you do not specify the PSCAN\$M\_PREFIX\_MATCH flag, the search looks for a process with the 2-character process name AB.

#### **4.2.4.2 Requesting Information About Processes That Match One Criterion**

You can use SYS\$GETJPI with SYS\$PROCESS\_SCAN to search for processes that match an item list with one criterion. For example, if you specify a search for processes owned by one user name, SYS\$GETJPI returns only those processes that match the specified user name.

Example 4–6 demonstrates how to perform a SYS\$PROCESS\_SCAN search on the local node to select all processes that are owned by user SMITH.

## Process Control

### 4.2 Obtaining Process Information

#### Example 4–6 Using SYS\$GETJPI and SYS\$PROCESS\_SCAN to Select Process Information by User Name

```
PROGRAM PROCESS_SCAN
  IMPLICIT NONE                                ! Implicit none
  INCLUDE '($jpi) /nolist'                    ! Definitions for $GETJPI
  INCLUDE '($psc) /nolist'                    ! Definitions for $PROCESS_SCAN
  INCLUDE '($ss) /nolist'                     ! Definitions for SS$_NAMES

  STRUCTURE /JPIITMLST/                       ! Structure declaration for
  UNION                                       ! $GETJPI item lists
  MAP
    INTEGER*2 BUFLN,
  2    CODE
    INTEGER*4 BUFADR,
  2    RETLENADR
  END MAP
  MAP                                         ! A longword of 0 terminates
    INTEGER*4 END_LIST                       ! an item list
  END MAP
  END UNION
END STRUCTURE
STRUCTURE /PSCANITMLST/                     ! Structure declaration for
  UNION                                       ! $PROCESS_SCAN item lists
  MAP
    INTEGER*2 BUFLN,
  2    CODE
    INTEGER*4 BUFADR,
  2    ITMFLAGS
  END MAP
  MAP                                         ! A longword of 0 terminates
    INTEGER*4 END_LIST                       ! an item list
  END MAP
  END UNION
END STRUCTURE
RECORD /PSCANITMLST/                         ! Declare the item list for
  2    PSCANLIST(12)                         ! $PROCESS_SCAN
RECORD /JPIITMLST/                           ! Declare the item list for
  2    JPILIST(3)                             ! $GETJPI
INTEGER*4 SYS$GETJPIW,                       ! System service entry points
  2    SYS$PROCESS_SCAN
INTEGER*4 STATUS,                            ! Status variable
  2    CONTEXT,                              ! Context from $PROCESS_SCAN
  2    PID                                    ! PID from $GETJPI
INTEGER*2 IOSB(4)                            ! I/O Status Block for $GETJPI
CHARACTER*16
  2    PRCNAM                                ! Process name from $GETJPI
INTEGER*2 PRCNAM_LEN                         ! Process name length
LOGICAL*4 DONE                               ! Done with data loop
```

(continued on next page)

## Process Control 4.2 Obtaining Process Information

### Example 4-6 (Cont.) Using SYS\$GETJPI and SYS\$PROCESS\_SCAN to Select Process Information by User Name

```

*****
!* Initialize item list for $PROCESS_SCAN *
*****

! Look for processes owned by user SMITH
PSCANLIST(1).BUFLEN  = LEN('SMITH')
PSCANLIST(1).CODE    = PSCAN$ USERNAME
PSCANLIST(1).BUFADR  = %LOC('SMITH')
PSCANLIST(1).ITMFLAGS = 0
PSCANLIST(2).END_LIST = 0
*****
!*      End of item list initialization      *
*****

STATUS = SYS$PROCESS_SCAN (          ! Set up the scan context
2                               CONTEXT,
2                               PSCANLIST)

IF (.NOT. STATUS) CALL LIB$SIGNAL (%VAL(STATUS))

! Loop calling $GETJPI with the context
DONE = .FALSE.
DO WHILE (.NOT. DONE)

    ! Initialize $GETJPI item list

    JPILIST(1).BUFLEN  = 4
    JPILIST(1).CODE    = JPI$ PID
    JPILIST(1).BUFADR  = %LOC(PID)
    JPILIST(1).RETLENADR = 0
    JPILIST(2).BUFLEN  = LEN(PCRNAM)
    JPILIST(2).CODE    = JPI$ PCRNAM
    JPILIST(2).BUFADR  = %LOC(PCRNAM)
    JPILIST(2).RETLENADR = %LOC(PCRNAM_LEN)
    JPILIST(3).END_LIST = 0
! Call $GETJPI to get the next SMITH process

    STATUS = SYS$GETJPIW (
2          ,          ! No event flag
2          CONTEXT,  ! Process context
2          ,          ! No process name
2          JPILIST,  ! Item list
2          IOSB,     ! Always use IOSB with $GETJPI!
2          ,          ! No AST
2          )         ! No AST arg

    ! Check the status in both STATUS and the IOSB, if
    ! STATUS is OK then copy IOSB(1) to STATUS

    IF (STATUS) STATUS = IOSB(1)

    ! If $GETJPI worked, display the process, if done then
    ! prepare to exit, otherwise signal an error

    IF (STATUS) THEN
        TYPE 1010, PID, PCRNAM(1:PCRNAM_LEN)
        FORMAT (' ',Z8.8,' ',A)
    ELSE IF (STATUS .EQ. SSS$_NOMOREPROC) THEN
        DONE = .TRUE.
    ELSE
        CALL LIB$SIGNAL(%VAL(STATUS))
    END IF

```

1010

(continued on next page)

## Process Control

### 4.2 Obtaining Process Information

#### Example 4–6 (Cont.) Using SYS\$GETJPI and SYS\$PROCESS\_SCAN to Select Process Information by User Name

```
END DO
END
```

#### 4.2.4.3 Requesting Information About Processes That Match Multiple Values for One Criterion

You can use SYS\$PROCESS\_SCAN to search for processes that match one of a number of values for a single criterion, such as processes owned by several specified users.

You must specify each value in a separate item list entry, and connect the item list entries with the PSCAN\$M\_OR item-specific flag. SYS\$GETJPI selects each process that matches any of the item values.

For example, to look for processes with user names SMITH, JONES, or JOHNSON, substitute code such as that shown in Example 4–7 to initialize the item list in Example 4–6.

#### Example 4–7 Using SYS\$GETJPI and SYS\$PROCESS\_SCAN with Multiple Values for One Criterion

```
!*****
!* Initialize item list for $PROCESS_SCAN *
!*****

! Look for users SMITH, JONES and JOHNSON

PSCANLIST(1).BUFLEN = LEN('SMITH')
PSCANLIST(1).CODE   = PSCAN$ USERNAME
PSCANLIST(1).BUFADR = %LOC('SMITH')
PSCANLIST(1).ITMFLAGS = PSCAN$M_OR
PSCANLIST(2).BUFLEN = LEN('JONES')
PSCANLIST(2).CODE   = PSCAN$ USERNAME
PSCANLIST(2).BUFADR = %LOC('JONES')
PSCANLIST(2).ITMFLAGS = PSCAN$M_OR
PSCANLIST(3).BUFLEN = LEN('JOHNSON')
PSCANLIST(3).CODE   = PSCAN$ USERNAME
PSCANLIST(3).BUFADR = %LOC('JOHNSON')
PSCANLIST(3).ITMFLAGS = 0
PSCANLIST(4).END_LIST = 0

!*****
!*      End of item list initialization      *
!*****
```

#### 4.2.4.4 Requesting Information About Processes That Match Multiple Criteria

You can use SYS\$PROCESS\_SCAN to search for processes that match values for more than one criterion. When multiple criteria are used, a process must match at least one value for each specified criterion.

Example 4–8 demonstrates how to find any batch process owned by either SMITH or JONES. The program uses syntax like the following logical expression to initialize the item list:



```
((username = "SMITH") OR (username = "JONES"))  
      AND  
      (MODE = JPI$K_BATCH)
```

#### Example 4–8 Selecting Processes That Match Multiple Criteria

```
!*****  
!* Initialize item list for $PROCESS_SCAN *  
!*****  
  
! Look for BATCH jobs owned by users SMITH and JONES  
  
PSCANLIST(1).BUFLEN = LEN('SMITH')  
PSCANLIST(1).CODE   = PSCAN$ _USERNAME  
PSCANLIST(1).BUFADR = %LOC('SMITH')  
PSCANLIST(1).ITMFLAGS = PSCAN$M OR  
PSCANLIST(2).BUFLEN = LEN('JONES')  
PSCANLIST(2).CODE   = PSCAN$ _USERNAME  
PSCANLIST(2).BUFADR = %LOC('JONES')  
PSCANLIST(2).ITMFLAGS = 0  
PSCANLIST(3).BUFLEN = 0  
PSCANLIST(3).CODE   = PSCAN$ _MODE  
PSCANLIST(3).BUFADR = JPI$K_BATCH  
PSCANLIST(3).ITMFLAGS = 0  
PSCANLIST(4).END_LIST = 0  
  
!*****  
!*      End of item list initialization      *  
!*****
```

See the *OpenVMS System Services Reference Manual* for more information about SYS\$PROCESS\_SCAN item codes and flags.

#### 4.2.5 Specifying a Node as Selection Criterion

Several SYS\$PROCESS\_SCAN item codes do not refer to attributes of a process, but to the VMScluster node on which the target process resides. When SYS\$PROCESS\_SCAN encounters an item code that refers to a node attribute, it creates an alphabetized list of node names. SYS\$PROCESS\_SCAN then directs SYS\$GETJPI to compare the selection criteria against processes on these nodes.

SYS\$PROCESS\_SCAN ignores a node specification if it is running on a node that is not part of a VMScluster system. For example, if you request that SYS\$PROCESS\_SCAN select all nodes with the hardware model name VAX 6360, this search returns information about local processes on a nonclustered system, even if it is a MicroVAX system.

A remote SYS\$GETJPI operation currently requires the system to send a message to the CLUSTER\_SERVER process on the remote node. The CLUSTER\_SERVER process then collects the information and returns it to the requesting node. This has several implications for clusterwide searches:

- All remote SYS\$GETJPI operations are asynchronous and must be synchronized properly. Many applications that are not correctly synchronized might seem to work on a single node because some SYS\$GETJPI operations are actually synchronous; however, these applications fail if they attempt to examine processes on remote nodes. For more information on how to synchronize SYS\$GETJPI operations, see Chapter 6.
- The CLUSTER\_SERVER process is always a current process, because it is executing on behalf of SYS\$GETJPI.

## Process Control

### 4.2 Obtaining Process Information

- Attempts by SYS\$GETJPI to examine a node do not succeed during a brief period between the time a node joins the cluster and the time that the CLUSTER\_SERVER process is started. Searches that occur during this period skip such a node. Searches that specify only such a booting node fail with a SYS\$GETJPI status of SS\$\_UNREACHABLE.
- SS\$\_NOMOREPROC is returned after all processes on all specified nodes have been scanned.

#### 4.2.5.1 Checking All Nodes on the Cluster for Processes

The SYS\$PROCESS\_SCAN system service can scan the entire cluster for processes. For example, to scan the cluster for all processes owned by SMITH, use code like that in Example 4–9 to initialize the item list to find all processes with a nonzero cluster system identifier (CSID) and a user name of SMITH.

##### Example 4–9 Searching the Cluster for Process Information

```
!*****
!* Initialize item list for $PROCESS_SCAN *
!*****

! Search the cluster for jobs owned by SMITH

PSCANLIST(1).BUFLEN = 0
PSCANLIST(1).CODE = PSCAN$_NODE_CSID
PSCANLIST(1).BUFADR = 0
PSCANLIST(1).ITMFLAGS = PSCAN$_M_NEQ
PSCANLIST(2).BUFLEN = LEN('SMITH')
PSCANLIST(2).CODE = PSCAN$_USERNAME
PSCANLIST(2).BUFADR = %LOC('SMITH')
PSCANLIST(2).ITMFLAGS = 0
PSCANLIST(3).END_LIST = 0

!*****
!* End of item list initialization *
!*****
```

#### 4.2.5.2 Checking Specific Nodes on the Cluster for Processes

You can specify a list of nodes as well. Example 4–10 demonstrates how to design an item list to search for batch processes on node TIGNES, VALTHO, or 2ALPES.

##### Example 4–10 Searching for Process Information on Specific Nodes in the Cluster

```
!*****
!* Initialize item list for $PROCESS_SCAN *
!*****

! Search for BATCH jobs on nodes TIGNES, VALTHO and 2ALPES
```

(continued on next page)

**Example 4–10 (Cont.) Searching for Process Information on Specific Nodes in the Cluster**

```
PSCANLIST(1).BUFLEN = LEN('TIGNES')
PSCANLIST(1).CODE   = PSCAN$ NODENAME
PSCANLIST(1).BUFADR = %LOC('TIGNES')
PSCANLIST(1).ITMFLAGS = PSCAN$M OR
PSCANLIST(2).BUFLEN = LEN('VALTHO')
PSCANLIST(2).CODE   = PSCAN$ NODENAME
PSCANLIST(2).BUFADR = %LOC('VALTHO')
PSCANLIST(2).ITMFLAGS = PSCAN$M OR
PSCANLIST(3).BUFLEN = LEN('2ALPES')
PSCANLIST(3).CODE   = PSCAN$ NODENAME
PSCANLIST(3).BUFADR = %LOC('2ALPES')
PSCANLIST(3).ITMFLAGS = 0
PSCANLIST(4).BUFLEN = 0
PSCANLIST(4).CODE   = PSCAN$ MODE
PSCANLIST(4).BUFADR = JPI$K_BATCH
PSCANLIST(4).ITMFLAGS = 0
PSCANLIST(5).END_LIST = 0

!*****
!*      End of item list initialization      *
!*****
```

**4.2.5.3 Conducting Multiple Simultaneous Searches with SYS\$PROCESS\_SCAN**

Only one asynchronous remote SYS\$GETJPI request per SYS\$PROCESS\_SCAN context is permitted at a time. If you issue a second SYS\$GETJPI request using a context before a previous remote request using the same context has completed, your process stalls in a resource wait until the previous remote SYS\$GETJPI request completes. This stall in the RWAST state prevents your process from executing in user mode or receiving user-mode ASTs.

If you want to run remote searches in parallel, create multiple contexts by calling SYS\$PROCESS\_SCAN once for each context. For example, you can design a program that calls SYS\$GETSYI in a loop to find the nodes in the VMScluster system and creates a separate SYS\$PROCESS\_SCAN context for each remote node. Each of these separate contexts can run in parallel. The DCL command SHOW USERS uses this technique to obtain user information more quickly.

Only requests to remote nodes must wait until the previous search using the same context has completed. If the SYS\$PROCESS\_SCAN context specifies the local node, any number of SYS\$GETJPI requests using that context can be executed in parallel (within the limits implied by the process quotas for ASTLM and BYTLM).

---

**Note**

When you use SYS\$GETJPI to reference remote processes, you must properly synchronize all SYS\$GETJPI calls. Before the operating system's Version 5.2, if you did not follow these synchronization rules, your programs might have appeared to run correctly. However, if you attempt to run such improperly synchronized programs using SYS\$GETJPI with SYS\$PROCESS\_SCAN with a remote process, your program might attempt to use the data before SYS\$GETJPI has returned it.

---

## Process Control

### 4.2 Obtaining Process Information

To perform a synchronous search in which the program waits until all requested information is available, use `SYS$GETJPIW` with an **iosb** argument.

See the *OpenVMS System Services Reference Manual* for more information about process identification, `SYS$GETJPI`, and `SYS$PROCESS_SCAN`.

#### 4.2.6 Programming with `SYS$GETJPI`

The following sections describe some important considerations for programming with `SYS$GETJPI`.

##### 4.2.6.1 Using Item Lists Correctly

When `SYS$GETJPI` collects data, it makes multiple passes through the item list. If the item list is self-modifying—that is, if the addresses for the output buffers in the item list point back at the item list—`SYS$GETJPI` replaces the item list information with the returned data. Therefore, incorrect data might be read or unexpected errors might occur when `SYS$GETJPI` reads the item list again. To prevent confusing errors, Compaq recommends that you do not use self-modifying item lists.

The number of passes that `SYS$GETJPI` needs depends on which item codes are referenced and the state of the target process. A program that appears to work normally might fail when a system has processes that are swapped out of memory, or when a process is on a remote node.

##### 4.2.6.2 Improving Performance by Using Buffered `$GETJPI` Operations

To request information about a process located on a remote node, `SYS$GETJPI` must send a message to the remote node, wait for the response, and then extract the data from the message received. When you perform a search on a remote system, the program must repeat this sequence for each process that `SYS$GETJPI` locates.

To reduce the overhead of such a remote search, use `SYS$PROCESS_SCAN` with the `PSCAN$_GETJPI_BUFFER_SIZE` item code to specify a buffer size for `SYS$GETJPI`. When the buffer size is specified by `SYS$PROCESS_SCAN`, `SYS$GETJPI` packs information for several processes into one buffer and transmits them in a single message. This reduction in the number of messages improves performance.

For example, if the `SYS$GETJPI` item list requests 100 bytes of information, you might specify a `PSCAN$_GETJPI_BUFFER_SIZE` of 1000 bytes so that the service can place information for at least 10 processes in each message. (`SYS$GETJPI` does not send fill data in the message buffer; therefore, information for more than 10 processes can be packed into the buffer.)

The `SYS$GETJPI` buffer must be large enough to hold the data for at least one process. If the buffer is too small, the error code `SS$_IVBUFLN` is returned from the `SYS$GETJPI` call.

You do not have to allocate space for the `SYS$GETJPI` buffer; buffer space is allocated by `SYS$PROCESS_SCAN` as part of the search context that it creates. Because `SYS$GETJPI` buffering is transparent to the program that calls `SYS$GETJPI`, you do not have to modify the loop that calls `SYS$GETJPI`.

If you use `PSCAN$_GETJPI_BUFFER_SIZE` with `SYS$PROCESS_SCAN`, all calls to `SYS$GETJPI` using that context must request the same item code information. Because `SYS$GETJPI` collects information for more than one process at a time within its buffers, you cannot change the item codes or the lengths of the buffers in the `SYS$GETJPI` item list between calls. `SYS$GETJPI`

returns the error SS\$\_BADPARAM if any item code or buffer length changes between SYS\$GETJPI calls. However, you can change the buffer addresses in the SYS\$GETJPI item list from call to call.

The SYS\$GETJPI buffered operation is not used for searching the local node. When a search specifies both multiple nodes and SYS\$GETJPI buffering, the buffering is used on remote nodes but is ignored on the local node. Example 4–11 demonstrates how to use a SYS\$GETJPI buffer to improve performance.

**Example 4–11 Using a SYS\$GETJPI Buffer to Improve Performance**

```
!*****
!* Initialize item list for $PROCESS SCAN *
!*****

! Search for jobs owned by users SMITH and JONES
! across the cluster with $GETJPI buffering

PSCANLIST(1).BUFLEN = 0
PSCANLIST(1).CODE = PSCAN$_NODE_CSID
PSCANLIST(1).BUFADR = 0
PSCANLIST(1).ITMFLAGS = PSCAN$_NEQ
PSCANLIST(2).BUFLEN = LEN('SMITH')
PSCANLIST(2).CODE = PSCAN$_USERNAME
PSCANLIST(2).BUFADR = %LOC('SMITH')
PSCANLIST(2).ITMFLAGS = PSCAN$_OR
PSCANLIST(3).BUFLEN = LEN('JONES')
PSCANLIST(3).CODE = PSCAN$_USERNAME
PSCANLIST(3).BUFADR = %LOC('JONES')
PSCANLIST(3).ITMFLAGS = 0
PSCANLIST(4).BUFLEN = 0
PSCANLIST(4).CODE = PSCAN$_GETJPI_BUFFER_SIZE
PSCANLIST(4).BUFADR = 1000
PSCANLIST(4).ITMFLAGS = 0
PSCANLIST(5).END_LIST = 0

!*****
!* End of item list initialization *
!*****
```

**4.2.6.3 Fulfilling Remote SYS\$GETJPI Quota Requirements**

A remote SYS\$GETJPI request uses system dynamic memory for messages. System dynamic memory uses the process quota BYTLM. Follow these steps to determine the number of bytes required by a SYS\$GETJPI request:

1. Add the following together:
  - The size of the SYS\$PROCESS\_SCAN item list
  - The total size of all reference buffers for SYS\$PROCESS\_SCAN (the sum of all buffer length fields in the item list)
  - The size of the SYS\$GETJPI item list
  - The size of the SYS\$GETJPI buffer
  - The size of the calling process RIGHTSLIST
  - Approximately 300 bytes for message overhead
2. Double this total.

The total is doubled because the messages consume system dynamic memory on both the sending node and the receiving node.

## Process Control

### 4.2 Obtaining Process Information

This formula for BYTLM quota applies to both buffered and nonbuffered SYS\$GETJPI requests. For buffered requests, use the value specified in the SYS\$PROCESS\_SCAN item, PSCAN\$\_GETJPI\_BUFFER\_SIZE, as the size of the buffer. For nonbuffered requests, use the total length of all data buffers specified in the SYS\$GETJPI item list as the size of the buffer.

If the BYTLM quota is insufficient, SYS\$GETJPI (not SYS\$PROCESS\_SCAN) returns the error SS\$\_EXBYTLM.

#### 4.2.6.4 Using the SYS\$GETJPI Control Flags

The JPI\$\_GETJPI\_CONTROL\_FLAGS item code, which is specified in the SYS\$GETJPI item list, provides additional control over SYS\$GETJPI. Therefore, SYS\$GETJPI may be unable to retrieve all the data requested in an item list because JPI\$\_GETJPI\_CONTROL\_FLAGS requests that SYS\$GETJPI not perform certain actions that may be necessary to collect the data. For example, a SYS\$GETJPI control flag may instruct the calling program not to retrieve a process that has been swapped out of the balance set.

If SYS\$GETJPI is unable to retrieve any data item because of the restrictions imposed by the control flags, it returns the data length as 0. To verify that SYS\$GETJPI received a data item, examine the data length to be sure that it is not 0. To make this verification possible, be sure to specify the return length for each item in the SYS\$GETJPI item list when any of the JPI\$\_GETJPI\_CONTROL\_FLAGS flags is used.

Unlike other SYS\$GETJPI item codes, the JPI\$\_GETJPI\_CONTROL\_FLAGS item is an input item. The item list entry should specify a longword buffer. The desired control flags should be set in this buffer.

Because the JPI\$\_GETJPI\_CONTROL\_FLAGS item code tells SYS\$GETJPI how to interpret the item list, it must be the first entry in the SYS\$GETJPI item list. The error code SS\$\_BADPARAM is returned if it is not the first item in the list.

The following are the SYS\$GETJPI control flags.

#### **JPI\$M\_NO\_TARGET\_INSWAP**

When you specify JPI\$M\_NO\_TARGET\_INSWAP, SYS\$GETJPI does not retrieve a process that has been swapped out of the balance set. Use JPI\$M\_NO\_TARGET\_INSWAP to avoid the additional load of swapping processes into a system. For example, use this flag with SHOW SYSTEM to avoid bringing processes into memory to display their accumulated CPU time.

If you specify JPI\$M\_NO\_TARGET\_INSWAP and request information from a process that has been swapped out, the following consequences occur:

- Data stored in the virtual address space of the process is not accessible.
- Data stored in the process header (PHD) may not be accessible.
- Data stored in resident data structures, such as the process control block (PCB) or the job information block (JIB), is accessible.

You must examine the return length of an item to verify that the item was retrieved. The information may be located in a different data structure in another release of the operating system.

### **JPI\$M\_NO\_TARGET\_AST**

When you specify `JPI$M_NO_TARGET_AST`, `SY$GETJPI` does not deliver a kernel-mode AST to the target process. Use `JPI$M_NO_TARGET_AST` to avoid executing a target process in order to retrieve information.

If you specify `JPI$M_NO_TARGET_AST` and cannot deliver an AST to a target process, the following consequences occur:

- Data stored in the virtual address space of the process is not accessible.
- Data stored in system data structures, such as the process header (PHD), the process control block (PCB), or the job information block (JIB), is accessible.

You must examine the return length of an item to verify that the item was retrieved. The information may be located in a different data structure in another release of the operating system.

The use of the flag `JPI$M_NO_TARGET_AST` also implies that `SY$GETJPI` does not swap in a process, because `SY$GETJPI` would only bring a process into memory to deliver an AST to that process.

### **JPI\$M\_IGNORE\_TARGET\_STATUS**

When you specify `JPI$M_IGNORE_TARGET_STATUS`, `SY$GETJPI` attempts to retrieve as much information as possible, even if the process is suspended or being deleted. Use `JPI$M_IGNORE_TARGET_STATUS` to retrieve all possible information from a process. For example, use this flag with `SHOW SYSTEM` to display processes that are suspended, being deleted, or in miscellaneous wait states.

Example 4–12 demonstrates how to use `SY$GETJPI` control flags to avoid swapping processes during a `SY$GETJPI` call.

#### **Example 4–12 Using `SY$GETJPI` Control Flags to Avoid Swapping a Process into the Balance Set**

```
PROGRAM CONTROL_FLAGS
IMPLICIT NONE                                ! Implicit none
INCLUDE '($jpidef) /nolist'                 ! Definitions for $GETJPI
INCLUDE '($pscandef) /nolist'               ! Definitions for $PROCESS_SCAN
INCLUDE '($ssdef) /nolist'                  ! Definitions for SS$_names
```

(continued on next page)

## Process Control

### 4.2 Obtaining Process Information

#### Example 4–12 (Cont.) Using SYS\$GETJPI Control Flags to Avoid Swapping a Process into the Balance Set

```

STRUCTURE /JPIITMLST/           ! Structure declaration for
UNION                           ! $GETJPI item lists
  MAP
    INTEGER*2 BUFLen,
  2    CODE
    INTEGER*4 BUFADR,
  2    RETLENADR
  END MAP
  MAP                             ! A longword of 0 terminates
    INTEGER*4 END_LIST           ! an item list
  END MAP
END UNION
END STRUCTURE
STRUCTURE /PSCANITMLST/        ! Structure declaration for
UNION                           ! $PROCESS_SCAN item lists
  MAP
    INTEGER*2 BUFLen,
  2    CODE
    INTEGER*4 BUFADR,
  2    ITMFLAGS
  END MAP
  MAP                             ! A longword of 0 terminates
    INTEGER*4 END_LIST           ! an item list
  END MAP
END UNION
END STRUCTURE
RECORD /PSCANITMLST/           ! Declare the item list for
  2    PSCANLIST(5)             ! $PROCESS_SCAN
RECORD /JPIITMLST/             ! Declare the item list for
  2    JPILIST(6)               ! $GETJPI
INTEGER*4 SYS$GETJPIW,         ! System service entry points
  2    SYS$PROCESS_SCAN
INTEGER*4 STATUS,              ! Status variable
  2    CONTEXT,                 ! Context from $PROCESS_SCAN
  2    PID,                      ! PID from $GETJPI
  2    JPIFLAGS                 ! Flags for $GETJPI
INTEGER*2 IOSB(4)              ! I/O Status Block for $GETJPI
CHARACTER*16                    ! Process name from $GETJPI
  2    PRCNAM,                   ! Node name from $GETJPI
  2    NODENAME                 ! Process name length
INTEGER*2 PRCNAM_LEN,          ! Node name length
  2    NODENAME_LEN
CHARACTER*80                     ! Image name from $GETJPI
  2    IMAGNAME                 ! Image name length
INTEGER*2 IMAGNAME_LEN
LOGICAL*4 DONE                  ! Done with data loop

```

(continued on next page)



## Process Control

### 4.2 Obtaining Process Information

#### Example 4–12 (Cont.) Using SYS\$GETJPI Control Flags to Avoid Swapping a Process into the Balance Set

```
!*****
!* Initialize item list for $PROCESS_SCAN *
!*****

! Look for interactive and batch jobs across
! the cluster with $GETJPI buffering

PSCANLIST(1).BUFLEN = 0
PSCANLIST(1).CODE = PSCAN$ _NODE_CSID
PSCANLIST(1).BUFADR = 0
PSCANLIST(1).ITMFLAGS = PSCAN$M _NEQ
PSCANLIST(2).BUFLEN = 0
PSCANLIST(2).CODE = PSCAN$ _MODE
PSCANLIST(2).BUFADR = JPI$K _INTERACTIVE
PSCANLIST(2).ITMFLAGS = PSCAN$M _OR
PSCANLIST(3).BUFLEN = 0
PSCANLIST(3).CODE = PSCAN$ _MODE
PSCANLIST(3).BUFADR = JPI$K _BATCH
PSCANLIST(3).ITMFLAGS = 0
PSCANLIST(4).BUFLEN = 0
PSCANLIST(4).CODE = PSCAN$ _GETJPI_BUFFER_SIZE
PSCANLIST(4).BUFADR = 1000
PSCANLIST(4).ITMFLAGS = 0
PSCANLIST(5).END_LIST = 0

!*****
!* End of item list initialization *
!*****

STATUS = SYS$PROCESS_SCAN ( ! Set up the scan context
2 CONTEXT,
2 PSCANLIST)

IF (.NOT. STATUS) CALL LIB$SIGNAL (%VAL(STATUS))

! Initialize $GETJPI item list

JPILIST(1).BUFLEN = 4
JPILIST(1).CODE = IAND ('FFFF'X, JPI$ _GETJPI_CONTROL_FLAGS)
JPILIST(1).BUFADR = %LOC(JPIFLAGS)
JPILIST(1).RETLENADR = 0
JPILIST(2).BUFLEN = 4
JPILIST(2).CODE = JPI$ _PID
JPILIST(2).BUFADR = %LOC(PID)
JPILIST(2).RETLENADR = 0
JPILIST(3).BUFLEN = LEN(PRCNAM)
JPILIST(3).CODE = JPI$ _PRCNAM
JPILIST(3).BUFADR = %LOC(PRCNAM)
JPILIST(3).RETLENADR = %LOC(PRCNAM_LEN)
JPILIST(4).BUFLEN = LEN(IMAGNAME)
JPILIST(4).CODE = JPI$ _IMAGNAME
JPILIST(4).BUFADR = %LOC(IMAGNAME)
JPILIST(4).RETLENADR = %LOC(IMAGNAME_LEN)
JPILIST(5).BUFLEN = LEN(NODENAME)
JPILIST(5).CODE = JPI$ _NODENAME
JPILIST(5).BUFADR = %LOC(NODENAME)
JPILIST(5).RETLENADR = %LOC(NODENAME_LEN)
JPILIST(6).END_LIST = 0
! Loop calling $GETJPI with the context

DONE = .FALSE.
JPIFLAGS = IOR (JPI$M_NO_TARGET_INSWAP, JPI$M_IGNORE_TARGET_STATUS)
DO WHILE (.NOT. DONE)
```

(continued on next page)

## Process Control

### 4.2 Obtaining Process Information

#### Example 4–12 (Cont.) Using SYS\$GETJPI Control Flags to Avoid Swapping a Process into the Balance Set

```
! Call $GETJPI to get the next process
STATUS = SYS$GETJPIW (
2      , ! No event flag
2      CONTEXT, ! Process context
2      , ! No process name
2      JPILIST, ! Itemlist
2      IOSB, ! Always use IOSB with $GETJPI!
2      , ! No AST
2      ) ! No AST arg
! Check the status in both STATUS and the IOSB, if
! STATUS is OK then copy IOSB(1) to STATUS
IF (STATUS) STATUS = IOSB(1)
! If $GETJPI worked, display the process, if done then
! prepare to exit, otherwise signal an error
IF (STATUS) THEN
    IF (IMAGNAME_LEN .EQ. 0) THEN
        TYPE 1010, PID, NODENAME, PRCNAM
    ELSE
        TYPE 1020, PID, NODENAME, PRCNAM,
2        IMAGNAME(1:IMAGNAME_LEN)
    END IF
ELSE IF (STATUS .EQ. SS$_NOMOREPROC) THEN
    DONE = .TRUE.
ELSE
    CALL LIB$SIGNAL(%VAL(STATUS))
END IF
END DO
1010 FORMAT (' ',Z8.8,' ',A6,':: ',A,' (no image)')
1020 FORMAT (' ',Z8.8,' ',A6,':: ',A,' ',A)
END
```

#### 4.2.7 Using SYS\$GETLKI

The SYS\$GETLKI system service allows you to obtain process lock information. Example 4–13 is a C program that illustrates the procedure for obtaining process lock information for both Alpha and VAX systems. However, to compile on Alpha systems, you need to supply the /DEFINE=Alpha=1 qualifier.

#### Example 4–13 Procedure for Obtaining Process Lock Information

```
#pragma nostandard
#ifdef Alpha
#pragma module          LOCK_SCAN
#else
/* Alpha */
#pragma module          LOCK_SCAN
#endif
/* Alpha */
#pragma standard

#include <ssdef.h>
#include <lkidef.h>
```

(continued on next page)

**Example 4–13 (Cont.) Procedure for Obtaining Process Lock Information**

```
#pragma nostandard
globalvalue
    ss$ _normal, ss$ _nomorelock;
#pragma standard

struct lock_item_list
    {
        short int    buffer_length;
        short int    item_code;
        void         *bufaddress;
        void         *retaddress;
    };

typedef struct lock_item_list lock_item_list_type;

unsigned long lock_id;
long int value_block[4];

#pragma nostandard
static lock_item_list_type
    getlki_item_list[] = {
        {sizeof(value_block), LKI$ _VALBLK,    &value_block,  0},
        {sizeof(lock_id),     LKI$ _LOCKID,    &lock_id,      0},
        {0,0,0,0}
    };
globalvalue ss$ _normal, ss$ _nomorelock;
#pragma standard

main()
{
    int status = ss$ _normal;
    unsigned long lock_context = -1; /* init for wild-card operation */

    while (status == ss$ _normal) {
        status = sys$ getlkiw( 1, &lock_context, getlki_item_list,0,0,0,0);
        /*
        /* Dequeue the lock if the value block contains a 1 */
        /*
        if ((status == ss$ _normal) & (value_block[0] == 1)){
            status = sys$ dq( lock_id, 0, 0, 0 );
        }
    }
    if (status != ss$ _nomorelock){
        exit(status);
    }
}
```

### 4.2.8 Setting Process Privileges

Use the SYS\$SETPRV system service to set process privileges. Setting process privileges allows you to limit executing privileged code to a specific process, to limit functions within a process, and to limit access from other processes. You can either enable or disable a set of privileges and assign privileges on a temporary or permanent basis. To use this service, the creating process must have the appropriate privileges.

## Process Control

### 4.3 Changing Process and Kernel Threads Scheduling

#### 4.3 Changing Process and Kernel Threads Scheduling

Prior to kernel threads, the OpenVMS scheduler selected a process to run. With kernel threads, the OpenVMS scheduler selects a kernel thread to run. All processes are thread-capable processes with at least one kernel thread. A process may have only one kernel thread, or a process may have a variable number of kernel threads. A single-threaded process is equivalent to a process before OpenVMS Version 7.0.

With kernel threads, all base and current priorities are perkernel thread. To alter a thread's scheduling, you can change the base priority of the thread with the `SYS$SETPRI` system service, which affects the specified kernel thread and not the entire process.

To alter a process's scheduling, you can lock the process into physical memory so that it is not swapped out. Processes that have been locked into physical memory are executed before processes that have been swapped out. For kernel threads, the thread with the highest priority level is executed first.

If you create a subprocess with the `LIB$SPAWN` routine, you can set the priority of the subprocess by executing the DCL command `SET PROCESS/PRIORITY` as the first command in a command procedure. You must have the `ALTPRI` privilege to increase the base priority above the base priority of the creating process.

If you create a subprocess with the `LIB$SPAWN` routine, you can inhibit swapping by executing the DCL command `SET PROCESS/NOSWAP` as the first command in a command procedure. Use the `SYS$SETSWM` system service to inhibit swapping for any process. A process must have the `PSWAPM` privilege to inhibit swapping.

If you alter a kernel thread's scheduling, you must do so with care. Review the following considerations before you attempt to alter the standard kernel threads or process scheduling with either `SYS$SETPRI` or `SYS$SETSWM`:

- **Priority**—Increasing a kernel thread's base priority gives that thread more processor time at the expense of threads that execute at lower priorities. Compaq does not recommend this unless you have a program that must respond immediately to events (for example, a real-time program). If you must increase the base priority, return it to normal as soon as possible. If the entire image must execute at an increased priority, reset the base priority before exiting; image termination does not reset the base priority.
- **Swapping**—Inhibiting swapping keeps your process in physical memory. Compaq does not recommend inhibiting swapping unless the effective execution of your image depends on it (for example, if the image executing in the process is collecting statistics about processor performance).

#### 4.4 Using Affinity and Capabilities in CPU Scheduling (Alpha Only)

On Alpha systems, the **affinity** and **capabilities** mechanisms allow CPU scheduling to be adapted to larger CPU configurations by controlling the distribution of processes or threads throughout the active CPU set. Control of the distribution of processes throughout the active CPU set becomes more important as higher-performance server applications, such as databases and real-time process-control environments, are implemented. Affinity and capabilities provide the user with opportunities to perform the following tasks:

- Create and modify a set of user-defined process capabilities

## 4.4 Using Affinity and Capabilities in CPU Scheduling (Alpha Only)

- Create and modify a set of user-defined CPU capabilities to match those in the process
- Allow a process to apply the affinity mechanisms to a subset of the active CPU set in a symmetric multiprocessing (SMP) configuration

### 4.4.1 Defining Affinity and Capabilities

The affinity mechanism allows a process, or each of its kernel threads, to specify an exact set of CPUs on which it can execute. The capabilities mechanism allows a process to specify a set of resources that a CPU in the active set must have defined before it is allowed to contend for process execution. Presently, both of these mechanisms are present in the OpenVMS scheduling mechanism; both are used extensively internally and externally to implement parts of the I/O and timing subsystems. Now, however, the OpenVMS operating system provides user access to these mechanisms.

#### 4.4.1.1 Using Affinity and Capabilities with Caution

It is important for users to understand that inappropriate and abusive use of the affinity and capabilities mechanisms can have a negative impact on the symmetric aspects of the current multi-CPU scheduling algorithm.

### 4.4.2 Types of Capabilities

Capabilities are resources assigned to CPUs that a process needs to execute correctly. There are four defined capabilities. They are restricted to internal system events or functions that control system states or functions. Table 4–6 describes the four capabilities.

**Table 4–6 Capabilities**

Capability	Description
Primary	Owned by only one CPU at a time, since the primary could possibly migrate from CPU to CPU in the configuration. For I/O and timekeeping functions, the system requires that the process run on the primary CPU. The process requiring this capability is allowed to run only on the processor that has it at the time.
Run	Controls the ability of a CPU to execute processes. Every process requires this resource; if the CPU does not have it, scheduling for that CPU comes to a halt in a recognized state. The command STOP/CPU uses this capability when it is trying to make the CPU quiescent, bringing it to a halted state.
Quorum	Used in a cluster environment when a node wants another node to come to a quiescent state until further notice. Like the Run capability, Quorum is a required resource for every process and every CPU in order for scheduling to occur.
Vector	Like the Primary capability, it reflects a feature of the CPU; that is, that the CPU has a vector processing unit directly associated with it. Obsolete on OpenVMS Alpha systems but is retained as a compatibility feature with OpenVMS VAX.

### 4.4.3 Looking at User Capabilities

Previously, the use of capabilities was restricted to system resources and control events. However, it is also valuable for user functions to be able to indicate a resource or special CPU function.

## Process Control

### 4.4 Using Affinity and Capabilities in CPU Scheduling (Alpha Only)

There are 16 user-defined capabilities added to both the process and the CPU structures. Unlike the static definitions of the current system capabilities, the user capabilities have meaning only in the context of the processes that define them. Through system service interfaces, processes or individual threads of a multithreaded process, can set specific bits in the capability masks of a CPU to give it a resource, and can set specific bits in the kernel thread's capability mask to require that resource as an execution criterion.

The user capability feature is a direct superset of the current capability functionality. All currently existing capabilities are placed into the system capability set; they are not available to the process through system service interfaces. These system service interfaces affect only the 16 bits specifically set aside for user definition.

The OpenVMS operating system has no direct knowledge of what the defined capability is that is being used. All responsibility for the correct definition, use, and management of these bits is determined by the processes that define them. The system controls the impact of these capabilities through privilege requirements; but, as with the priority adjustment services, abusive use of the capability bits could affect the scheduling dynamic and CPU loads in an SMP environment.

#### 4.4.4 Using the Capabilities System Services

The `SYS$CPU_CAPABILITIES` and `SYS$PROCESS_CAPABILITIES` system services provide access to the capability features. By using the `SYS$CPU_CAPABILITIES` and `SYS$PROCESS_CAPABILITIES` services, you can assign user capabilities to a CPU and to a specific kernel thread. Assigning a user capability to a CPU lasts either for the life of the system or until another explicit change is made. This operation has no direct effect on the scheduling dynamics of the system; it only indicates that the specified CPU is capable of handling any process or thread that requires that resource. If a process does not indicate that it needs that resource, it ignores the CPU's additional capability and schedules the process on the basis of other process requirements.

Assigning a user capability requirement to a specific process or thread has a major impact on the scheduling state of that entity. For the process or thread to be scheduled on a CPU in the active set, that CPU must have the capability assigned prior to the scheduling attempt. If no CPU currently has the correct set of capability requirements, the process is placed into a wait state until a CPU with the right configuration becomes available. Like system capabilities, user process capabilities are additive; that is, for a CPU to schedule the process, the CPU must have the full complement of required capabilities.

These services reference both sets of 16-bit user capabilities by the common symbolic constant names of `CAP$M_USER1` through `CAP$M_USER16`. These names reflect the corresponding bit position in the appropriate capability mask; they are nonzero and self-relative to themselves only.

Both services allow multiple bits to be set or cleared, or both, simultaneously. Each takes as parameters a select mask and a modify mask that define the operation set to be performed. The service callers are responsible for setting up the select mask to indicate the user capabilities bits affected by the current call. This select mask is a bit vector of the ORed bit symbolic names that, when set, states that the value in the modify mask is the new value of the bit. Both masks use the symbolic constants to indicate the same bit; alternatively, if appropriate, you can use the symbolic constant `CAP$K_USER_ALL` in the select mask to indicate that the entire set of capabilities is affected. Likewise, you can use the

## 4.4 Using Affinity and Capabilities in CPU Scheduling (Alpha Only)

symbolic constant `CAP$K_USER_ADD` or `CAP$K_USER_REMOVE` in the modify mask to indicate that all capabilities specified in the select mask are to be either set or cleared.

For information about using the `SYS$CPU_CAPABILITIES` and `SYS$PROCESS_CAPABILITIES` system services, see the *OpenVMS System Services Reference Manual: A-GETUAI* and *OpenVMS System Services Reference Manual: GETUTC-Z*.

### 4.4.5 Types of Affinity

There are two types of affinity: implicit and explicit. This section describes both.

#### 4.4.5.1 Implicit Affinity

Implicit affinity, sometimes known as soft affinity, is a variant form of the original affinity mechanism used in the OpenVMS scheduling mechanisms. Rather than require a process to stay on a specific CPU regardless of conditions, implicit affinity maximizes cache and translation buffer (TB) context by maintaining an association with the CPU that has the most information about a given process.

Currently, the OpenVMS scheduling mechanism already has a version of implicit affinity. It keeps track of the last CPU the process ran on and tries to schedule itself to that CPU, subject to a fairness algorithm. The fairness algorithm makes sure a process is not skipped too many times when it normally would have been scheduled elsewhere.

The Alpha architecture lends itself to maintaining cache and TB context that has significant potential for performance improvement at both the process and system level. Because this feature contradicts the normal highest-priority process-scheduling algorithms in an SMP configuration, implicit affinity cannot be a system default.

The `SYS$SET_IMPLICIT_AFFINITY` system service provides implicit affinity support. This service works on an explicitly specified process or kernel thread block (KTB) through the **pidadr** and **prcnam** arguments. The default is the current process, but if the symbolic constant `CAP$K_PROCESS_DEFAULT` is specified in **pidadr**, the bit is set in the global default cell `SCH$GL_DEFAULT_PROCESS_CAP`. Setting implicit affinity globally is similar to setting a capability bit in the same mask, because every process creation after the modification picks up the bit as a default that stays in effect across all image activations.

The protections required to invoke `SYS$SET_IMPLICIT_AFFINITY` depend on the process that is being affected. Because the addition of implicit affinity has the same potential as the `SYS$ALTPRI` service for affecting the priority scheduling of processes in the COM queue, `ALTPRI` protection is required as the base which all modification forms of the serve must have to invoke `SYS$SET_IMPLICIT_AFFINITY`. If the process is the current one, no other privilege is required. To affect processes in the same UIC group, the `GROUP` privilege is required. For any other processes in the system, the `WORLD` privilege is required.

#### 4.4.5.2 Explicit Affinity

Even though capabilities and affinity overlap considerably in their functional behavior, they are nonetheless two discrete scheduling mechanisms. Affinity, the subsetting of the number of CPUs on which a process can execute, has precedence over the capability feature and provides an explicit binding operation between the process and CPU. It forces the scheduling algorithm to consider only the CPU set it requires, and then applies the capability tests to see whether any of them are appropriate.

## Process Control

### 4.4 Using Affinity and Capabilities in CPU Scheduling (Alpha Only)

Explicit affinity allows database and high-performance applications to segregate application functions to individual CPUs, providing improved cache and TB performance as well as reducing context switching and general scheduling overhead. During the IPL 8 scheduling pass, the process is investigated to see to which CPUs it is bound and whether the current CPU is one of those. If it passes that test, capabilities are also validated to allow the process to context switch. The number of CPUs that can be supported is 32.

The `SYS$PROCESS_AFFINITY` system service provides access to the explicit affinity functionality. `SYS$PROCESS_AFFINITY` resolves to a specific process, defaulting to the current one, through the `pidadr` and `prcnam` arguments. Like the other system services, the CPUs that are affected are indicated through `select_mask`, and the binding state of each CPU is specified in `modify_mask`.

Specific CPUs can be referenced in `select_mask` and `modify_mask` using the symbolic constants `CAP$M_CPU0` through `CAP$M_CPU31`. These constants are defined to match the bit position of their associated CPU ID. Alternatively, specifying `CAP$K_ALL_ACTIVE_CPUS` in `select_mask` sets or clears explicit affinity for all CPUs in the current active set.

Explicit affinity, like capabilities, has a permanent process as well as current image copy. As each completed image is run down, the permanent explicit affinity values overwrite the running image set, superseding any changes that were made in the interim. Specifying `CAP$M_FLAG_PERMANENT` in the `flags` parameter indicates that both the current and permanent processes are to be modified simultaneously. As a result, unless explicitly changed again, this operation has a scope from the current image through the end of the process life.

For information about the `SYS$SET_IMPLICIT_AFFINITY` and `SYS$PROCESS_AFFINITY` system services, see the *OpenVMS System Services Reference Manual: A-GETUAI* and *OpenVMS System Services Reference Manual: GETUTC-Z*.

### 4.5 Using the Class Scheduler in CPU Scheduling

The class scheduler, implemented on both VAX and Alpha systems, gives you the ability to limit the amount of CPU time that a system's users may receive by placing the users into scheduling classes. Each class is assigned a percentage of the overall system's CPU time. As the system runs, the combined set of users in a class are limited to the percentage of CPU execution time allocated to their class. The users may get some additional CPU time if the qualifier */windfall* is enabled for their scheduling class. Enabling the qualifier */windfall* allows the system to give a small amount of CPU time to a scheduling class when a CPU is idle and the scheduling class's allotted time has been depleted.

To invoke the class scheduler, you use the `SYSMAN` interface. `SYSMAN` allows a user to create, delete, modify, suspend, resume, and display scheduling classes. Table 4-7 shows the `SYSMAN` command, `class_schedule`, and its sub-commands.



Table 4-7 SYSMAN Command: Class\_Schedule

Sub-command	Meaning
Add	Creates a new scheduling class
Delete	Deletes a scheduling class
Modify	Modifies the characteristics of a scheduling class
Show	Shows the characteristics of a scheduling class
Suspend	Suspends temporarily a scheduling class
Resume	Resumes a scheduling class

### 4.5.1 Specifications for the Class\_Schedule Command

The full specifications for class\_schedule and its sub-commands are as follows:

#### 4.5.1.1 The Add Sub-Command

The format for the Add sub-command is as follows:

```
SYSMAN>class schedule add "class name"
/cpulimit = ([primary], [h1-h2=time%],[h1=time%],
             [,...],[secondary],[h1-h2=time%],[h1=time%],[,...])
[/primedays = ([no]day[,...])]
[/username = (name1, name2,...name"n")]
[/account = (name1, name2,...name"n")]
[/uic = (uicl,uic2,...uic"n")]
[/windfall]
```

#### The Class Name and Qualifiers

The class name is the name of the scheduling class. It must be specified and the maximum length for this name is 16 characters.

Table 4-8 shows the qualifiers and their meanings for this SYSMAN command.

## Process Control

### 4.5 Using the Class Scheduler in CPU Scheduling

**Table 4–8 Class Name Qualifiers**

Qualifier	Meaning
/cpulimit	<p>Defines the maximum amount of CPU time that this scheduling class can receive for the specified days and hours. You must specify this qualifier when adding a class.</p> <p>The h1-h2=time% syntax allows you to specify a range of hours followed by the maximum amount of CPU time (expressed as a percentage) to be associated with this set of hours. The first set of hours after the keyword PRIMARY specifies hours on primary days; the set of hours after the keyword SECONDARY specifies hours on secondary days. The hours are inclusive; if you class schedule a given hour, access extends to the end of that hour.</p>
/primedays	<p>Allows you to define which days are primary days and which days are secondary days. You specify primary days as MON, TUE, WED, THU, FRI, SAT, and SUN. You specify secondary days as NOMON, NOTUE, NOWED, NOTHU, NOFRI, NOSAT, and NOSUN. The default is MON through FRI and NOSAT and NOSUN. Any days omitted from the list take their default value. You can use the DCL command, SET DAY, to override the class definition of primary and secondary days.</p>
/username	<p>Specifies which user is part of this scheduling class. This is part of a user's SYSUAF record.</p>
/account	<p>Specifies which user is part of this scheduling class. This is part of a user's SYSUAF record.</p>
/uic	<p>Specifies which users are part of this scheduling class. This is part of a user's SYSUAF record.</p>
/windfall	<p>Specifies that all processes in the scheduling class are eligible for windfall. By enabling windfall, you allow processes in the scheduling class to receive a "windfall," that is, a small percentage of CPU time, when the class' allotted CPU time has been depleted and a CPU is idle. Rather than let the CPU remain idle, you might decide that it is better to let these processes execute even if it means giving them more than their allotted time.</p> <p>The default value is for windfall to be disabled.</p>

#### 4.5.1.2 The Delete Sub-Command

The format for the Delete sub-command is as follows:

```
SYSMAN>class_schedule delete "class name"
```

The Delete sub-command deletes the scheduling class from the class scheduler database file, and all processes that are members of this scheduling class are no longer class scheduled.

#### 4.5.1.3 The Modify Sub-Command

The format for the Modify sub-command is as follows:

```
SYSMAN>class_schedule modify "class name"
/cpulimit = ([primary], [h1-h2=time%],[h1=time%],
            [,...],[secondary],[h1-h2=time%],[h1=time%],[,...])
[/primedays = ([no]day[,...])]
[/username = (name1, name2,...name"n")]
[/account = (name1, name2,...name"n")]
[/uic = (uic1,uic2,...uic"n")]
[/windfall]
```

## 4.5 Using the Class Scheduler in CPU Scheduling

The Modify sub-command changes the characteristics of a scheduling class. The qualifiers are the same qualifiers as for the add sub-command. To remove a time restriction, specify a zero (0) for the time percentage associated with a particular range of hours.

To remove a name or uic value, you must specify a minus sign in front of each name or value.

### 4.5.1.4 The Show Sub-Command

The format for the Show sub-command is as follows:

```
SYSMAN>class_schedule show [class name] [/all]
                                     [/full]
```

Table 4–9 shows the qualifiers and their meanings for this SYSMAN command.

**Table 4–9 Show Sub-Command Qualifiers**

Qualifier	Meaning
/all	Displays all scheduling classes. The qualifier must be specified if no class name is given.
/full	Displays all information about his scheduling class.

#### Note

By default, a limited display of data is shown by this sub-command. The default shows the following:

- Name
- Maximum cpu time(s) for reach range of hours
- Primary days and secondary days
- Windfall settings

### 4.5.1.5 The Suspend Sub-Command

The format for the Suspend sub-command is as follows:

```
SYSMAN>class_schedule suspend "class name"
```

The Suspend sub-command suspends the specified scheduling class. All processes that are part of this scheduling class remain as part of this scheduling class but are granted unlimited CPU time.

### 4.5.1.6 The Resume Sub-Command

The format of the Resume sub-command is as follows:

```
SYSMAN>class_schedule resume "class name"
```

The Resume sub-command complements the suspend command. You use this command to resume a scheduling class that is currently suspended.

## Process Control

### 4.5 Using the Class Scheduler in CPU Scheduling

#### 4.5.2 The Class Scheduler Database

The class scheduler database is a permanent database that allows OpenVMS to class schedule processes automatically after a system has been booted and rebooted. This database resides on the system disk in SYS\$SYSTEM:VMS\$CLASS\_SCHEDULE.DATA. SYSMAN creates this file as an RMS indexed file when the first scheduling class is created by the SYSMAN command, class\_schedule add.

##### 4.5.2.1 The Class Scheduler Database and Process Creation

By using a permanent class scheduler, a process is placed into a scheduling class, if appropriate, at process creation time. When a new process is created, it needs to be determined whether this process belongs to a scheduling class. Since to determine this relies upon data in the SYSUAF file, and the Loginout image already has the process' information from this file, Loginout class schedules the process if it determines that the process belongs to a scheduling class.

There are two other types of processes to consider during process creation: subprocess and detached process. A subprocess becomes part of the same scheduling class as the parent process, even though it may not match the class's criteria. That is, its user and account name and/or UIC may not be part of the class's record. A detached process only joins a scheduling class if it executes the Loginout image (Loginout.exe) during process creation.

Though a process can join a scheduling class at process creation time, you can change or modify its scheduling class during runtime with the SET PROCESS/SCHEDULING\_CLASS command.

#### 4.5.3 Determining If a Process Is Class Scheduled

You can determine whether a process is class scheduled by the following:

- The SHOW SYSTEM DCL command
- The SYS\$GETJPI system service
- The Authorize utility

##### The SHOW SYSTEM DCL Command

The DCL command, SHOW SYSTEM, with the qualifier, /CLASS = "name", displays processes that belong to a specific scheduling class, or if no name is specified, it displays all class scheduled processes and the name of their scheduling class. The SHOW SYSTEM/FULL command shows the scheduling class name of all processes that are class scheduled.

For more information about the DCL command SHOW SYSTEM, see *OpenVMS DCL Dictionary: N-Z*.

**The SYS\$GETJPI System Service** The SYS\$GETJPI system service item code, JPI\$\_CLASS\_NAME, returns the name of the scheduling class, as a character string, that this process belongs to. If the process is not class scheduled, then a return length of zero (0) is returned to the caller.

For more information about the SYS\$GETJPI system service, see the *OpenVMS System Services Reference Manual: A-GETUAI*.

**The Authorize Utility** When a new user is added to the SYSUAF file, or when a user's record is modified, Authorize searches the class scheduler database file to determine if this user is a member of a scheduling class. If it is, then Authorize displays the following message: UAF-I-SCHEDCLASS, which indicates that the user is a member of a scheduling class.

## 4.5 Using the Class Scheduler in CPU Scheduling

## 4.5.4 The SYS\$SCHED System Service

The SYS\$SCHED system service allows you to create a temporary class scheduling database. The processes are class-scheduled by PID, after the process has been created. The SYSMAN interface creates a separate and permanent class scheduling database that schedules you at process creation time. A process cannot belong to both databases, the SYS\$SCHED and SYSMAN database. Therefore, the SYS\$SCHED system service checks to see if the process to be inserted into a scheduling class is already class scheduled before it attempts to place the specified process into a scheduling class. If it is already class scheduled, then the error message, SS\$\_INCHEDCLASS, is returned from SYS\$SCHED.

For more information about the SYS\$SCHED system service, see the *OpenVMS System Services Reference Manual: GETUTC-Z*.

## 4.6 Changing Process Name

Use the system service SYS\$SETPRN to change the name of your process. SYS\$SETPRN can be used only on the calling process. Changing process names might be useful when a lengthy image is being executed. You can change names at significant points in the program; then monitor program execution through the change in process names. You can obtain a process name by calling a SYS\$GETJPI routine from within a controlling process, either by pressing the Ctrl/T key sequence if the image is currently executing in your process, or by entering the DCL command SHOW SYSTEM if the program is executing in a detached process.

The following program segment calculates the tax status for a number of households, sorts the households according to tax status, and writes the results to a report file. Because this is a time-consuming process, the program changes the process name at major points so that progress can be monitored.

```

.
.
.
! Calculate approximate tax rates
STATUS = SYS$SETPRN ('INCTAXES')
IF (.NOT. STATUS) CALL LIB$SIGNAL(%VAL(STATUS))
STATUS = TAX_RATES (TOTAL HOUSES,
2          PERSONS HOUSE,
2          ADULTS HOUSE,
2          INCOME HOUSE,
2          TAX PER HOUSE)
IF (.NOT. STATUS) CALL LIB$SIGNAL(%VAL(STATUS))
! Sort
STATUS = SYS$SETPRN ('INCSORT')
IF (.NOT. STATUS) CALL LIB$SIGNAL(%VAL(STATUS))
STATUS = TAX_SORT (TOTAL HOUSES,
2          TAX PER HOUSE)
IF (.NOT. STATUS) CALL LIB$SIGNAL(%VAL(STATUS))

! Write report
STATUS = SYS$SETPRN ('INCREPORT')
IF (.NOT. STATUS) CALL LIB$SIGNAL(%VAL(STATUS))
.
.
.

```

## Process Control

### 4.7 Accessing Another Process's Context

#### 4.7 Accessing Another Process's Context

On OpenVMS VAX systems, a system programmer must sometimes develop code that performs various actions (such as performance monitoring) on behalf of a given process, executing in that process's context. To do so, a programmer typically creates a routine consisting of position-independent code and data, allocates sufficient space in nonpaged pool, and copies the routine to it. On OpenVMS VAX systems, such a routine can execute correctly no matter where it is loaded into memory.

On OpenVMS Alpha systems, the practice of moving code in memory is more difficult and complex. It is not enough to simply copy code from one memory location to another. On OpenVMS Alpha systems, you must relocate both the routine and its linkage section, being careful to maintain the relative distance between them, and then apply all appropriate fixups to the linkage section.

The OpenVMS Alpha system provides two mechanisms to enable one process to access the context of another:

- Code that must read from or write to another process's registers or address space can use the `EXE$READ_PROCESS` and `EXE$WRITE_PROCESS` system routines, as described in Section 4.7.1.
- Code that must perform other operations in another process's context (for instance, to execute a system service to raise a target process's quotas) can be written as an OpenVMS Alpha executive image, as described in Section 4.7.2.

##### 4.7.1 Reading and Writing in the Address Space of Another Process (Alpha Only)

`EXE$READ_PROCESS` and `EXE$WRITE_PROCESS` are OpenVMS Alpha system routines in nonpaged system space. `EXE$READ_PROCESS` reads data from a target process's address space or registers and writes it to a buffer in the local process's address space. `EXE$WRITE_PROCESS` obtains data from a local process's address space and transfers it to the target process's context. Both routines must be called from kernel mode at IPL 0.

One of the arguments to these procedures specifies whether or not the procedure is to access memory and registers in the target process. Another argument specifies the memory address or register number. The contents of these arguments are symbolic names (beginning with the prefix `EACB$`) that are defined by the `$PROCESS_READ_WRITE` macro in `SYS$LIBRARY:LIB.MLB`. (They are also defined in `LIB.REQ` for BLISS programmers.)

###### 4.7.1.1 `EXE$READ_PROCESS` and `EXE$WRITE_PROCESS`

The following are descriptions of the callable interfaces to `EXE$READ_PROCESS` and `EXE$WRITE_PROCESS`.

---

## EXE\$READ\_PROCESS

Reads data from a target process's address space or registers and writes it to a buffer in the local process's address space.

### Module

PROC\_READ\_WRITE

### Format

status = EXE\$READ\_PROCESS (ipid, buffer\_size, target\_address, local\_address, target\_address\_type, ast\_counter\_address)

### Arguments

#### ipid

OpenVMS usage    ipid  
type             longword (unsigned)  
access            read only  
mechanism        by value

Internal process ID of the target process.

#### buffer\_size

OpenVMS usage    longword\_unsigned  
type             longword (unsigned)  
access            read only  
mechanism        by value

Number of bytes to transfer. If **target\_address\_type** is EACB\$K\_GENERAL\_REGISTER, the values of **target\_address** and **buffer\_size** together determine how many 64-bit registers are written, in numeric order, to the buffer. A partial register is written for any value that is not a multiple of 8.

If you specify **buffer\_size** to be larger than 8, more than one register is written from the buffer. Registers are written in numeric order, followed by the PC and PS, starting at the register indicated by **target\_address**.

If **target\_address\_type** is EACB\$K\_GENERAL\_REGISTER and the values of **buffer\_size** and **target\_address** would cause a target process read extending beyond R31 (the last available register), EXE\$READ\_PROCESS returns SS\$\_ILLSER status.

#### target\_address

OpenVMS usage    longword\_unsigned  
type             longword (unsigned)  
access            read only  
mechanism        by reference (if address); by value (if constant)

If **target\_address\_type** is EACB\$K\_MEMORY, address in target process at which the transfer is to start.

If **target\_address\_type** is EACB\$K\_GENERAL\_REGISTER, symbolic constant indicating at which general register the transfer should start. Possible constant values include EACB\$K\_R0 through EACB\$K\_R29, EACB\$K\_PC, and EACB\$K\_PS.

## Process Control

### EXE\$READ\_PROCESS

#### **local\_address**

OpenVMS usage longword\_unsigned  
type longword (unsigned)  
access read only  
mechanism by reference

Address of buffer in local process to which data is to be written.

#### **target\_address\_type**

OpenVMS usage integer  
type longword (unsigned)  
access read only  
mechanism by value

Symbolic constant indicating whether the **target\_address** argument is a memory address (EACB\$K\_MEMORY) or a general register (EACB\$K\_GENERAL\_REGISTER). Floating-point registers are not supported as target addresses.

#### **ast\_counter\_address**

OpenVMS usage longword\_unsigned  
type longword (unsigned)  
access read only  
mechanism by reference

Address of a longword used internally as an AST counter by EXE\$READ\_PROCESS and EXE\$WRITE\_PROCESS to detect errors. Supply the same address in the **ast\_counter\_address** argument for every call to these routines.

## Returns

OpenVMS usage cond\_value  
type longword (unsigned)  
access write only  
mechanism by value

Status indicating the success or failure of the operation.

## Return Values

SS\$_ACCVIO	Unable to write to the location indicated by <b>local_address</b> or <b>ast_counter_address</b> .
SS\$_ILLSER	Routine was called with IPL greater than 0, or an illegal <b>target_address_type</b> was specified. If <b>target_address_type</b> is EACB\$K_GENERAL_REGISTER, this status can indicate that the values of <b>buffer_size</b> and <b>target_address</b> would cause a target process read extending beyond R31 (the last available register).
SS\$_INSFMEM	Insufficient memory available for specified buffer.
SS\$_NONEXPR	The <b>ipid</b> argument does not correspond to an existing process.
SS\$_NORMAL	The interprocess read finished successfully.



SS\$\_TIMEOUT                      The read operation did not finish within a few seconds.

## Context

The caller of EXE\$READ\_PROCESS must be executing in kernel mode at IPL 0. Kernel mode ASTs must be enabled.

## Description

EXE\$READ\_PROCESS reads data from a target process's address space and writes it to a buffer in the local process's address space.

EXE\$READ\_PROCESS allocates nonpaged pool for an AST control block (ACB), an ACB extension, and a buffer of the specified size. It initializes the extended ACB with information describing the data transfer and then delivers an AST to the target process to perform the operation. The data is read in the context of the target process from its address space or registers into nonpaged pool. An AST is then queued to the requesting process to complete the read operation by copying the data from pool to the process's buffer.

EXE\$READ\_PROCESS does not return to its caller until the read is completed, an error is encountered, or it has timed out. (The current timeout value is 3 seconds.)

---

## EXE\$WRITE\_PROCESS

Reads data from the local process's address space and writes it either to a target process's registers or a buffer in a target process's address space.

## Module

PROC\_READ\_WRITE

## Format

status = EXE\$WRITE\_PROCESS (ipid, buffer\_size, local\_address, target\_address, target\_address\_type, ast\_counter\_address)

## Arguments

### ipid

OpenVMS usage	ipid
type	longword (unsigned)
access	read only
mechanism	by value

Internal process ID of the target process.

### buffer\_size

OpenVMS usage	longword_unsigned
type	longword (unsigned)
access	read only
mechanism	by value

## Process Control

### EXE\$WRITE\_PROCESS

Number of bytes to transfer. If **target\_address\_type** is EACB\$K\_GENERAL\_REGISTER, the values of **target\_address** and **buffer\_size** together determine how many 64-bit registers are written, in numeric order, from the buffer. A partial register is written for any value that is not a multiple of 8.

If you specify **buffer\_size** to be larger than 8, more than one register is written from the buffer. Registers are written in numeric order, followed by the PC and PS, starting at the register indicated by **target\_address**.

If **target\_address\_type** is EACB\$K\_GENERAL\_REGISTER and the values of **buffer\_size** and **target\_address** would cause a write extending beyond R31 (the last available register), EXE\$WRITE\_PROCESS returns SS\$\_ILLSER status.

#### local\_address

OpenVMS usage	longword_unsigned
type	longword (unsigned)
access	read only
mechanism	by reference

Address in local process from which data is to be transferred.

#### target\_address

OpenVMS usage	longword_unsigned
type	longword (unsigned)
access	read only
mechanism	by reference (if address) by value (if constant)

If **target\_address\_type** is EACB\$K\_MEMORY, address in target process at which the transfer is to start.

If **target\_address\_type** is EACB\$K\_GENERAL\_REGISTER, symbolic constant indicating at which general register the transfer should start. Possible constant values include EACB\$K\_R0 through EACB\$K\_R29, EACB\$K\_PC, and EACB\$K\_PS.

#### target\_address\_type

OpenVMS usage	longword_unsigned
type	longword (unsigned)
access	read only
mechanism	by value

Symbolic constant indicating whether the **target\_address** argument is a memory address (EACB\$K\_MEMORY) or a general register (EACB\$K\_GENERAL\_REGISTER). Floating-point registers are not supported as target addresses.

#### ast\_counter\_address

OpenVMS usage	longword_unsigned
type	longword (unsigned)
access	read only
mechanism	by reference

Address of a longword used internally as an AST counter by EXE\$READ\_PROCESS and EXE\$WRITE\_PROCESS to detect errors. Supply the same address in the **ast\_counter\_address** argument for every call to these routines.

## Returns

OpenVMS usage	cond_value
type	longword (unsigned)
access	write only
mechanism	by value

Status indicating the success or failure of the operation.

## Return Values

SS\$_ACCVIO	Unable to read from the location indicated by <b>local_address</b> or write to the location indicated by <b>ast_counter_address</b> .
SS\$_ILLSER	Routine was called with IPL greater than 0, an illegal <b>target_address_type</b> was specified. If <b>target_address_type</b> is EACB\$K_GENERAL_REGISTER, this status can indicate that the values of <b>buffer_size</b> and <b>target_address</b> would cause a process write extending beyond R31 (the last available register).
SS\$_INSFMEM	Insufficient memory available for specified buffer.
SS\$_NONEXPR	The <b>ipid</b> argument does not correspond to an existing process.
SS\$_NORMAL	The interprocess write finished successfully.
SS\$_TIMEOUT	The write operation did not finish within a few seconds.

## Context

The caller of EXE\$WRITE\_PROCESS must be executing in kernel mode at IPL 0. Kernel mode ASTs must be enabled.

## Description

EXE\$WRITE\_PROCESS reads data from the local process's address space and writes it to a target process's registers or a buffer in a target process's address space.

EXE\$WRITE\_PROCESS allocates nonpaged pool for an AST control block (ACB), an ACB extension, and a buffer of the specified size. It initializes the extended ACB with information describing the data transfer, copies the data to be written to the target process into the buffer, and then delivers an AST to the target process to perform the operation.

The AST routine copies the data from pool into the target location and then queues an AST to the requesting process to complete the write operation.

EXE\$WRITE\_PROCESS does not return to its caller until the read is completed, an error is encountered, or it has timed out. (The current timeout value is 3 seconds.)

### 4.7.2 Writing an Executive Image (Alpha Only)

An **executive image** is an image that is mapped into system space as part of the OpenVMS executive. It contains data, routines, and initialization code specific to an image's functions and features. An executive image is implemented as a form of shareable image. Like any shareable image, it has a global symbol table, image section descriptors, and an image activator fixup section. Unlike a shareable image, however, an executive image does not contain a symbol vector.

Universally available procedures and data cells in system-supplied executive images are accessed through entries provided by the symbol vectors in the system base images SYS\$BASE\_IMAGE.EXE and SYS\$PUBLIC\_VECTORS.EXE.

References to an executive image are resolved through these symbol vectors, whether from an executive image or from a user executable or shareable image.

Unlike a system-supplied executive image, an executive image that you create cannot provide universally accessible entry points and symbols in this manner. Instead, it must establish its own vector of procedure descriptors for its callable routines and make the address of that vector available systemwide.

The OpenVMS executive loader imposes several requirements on the sections of any executive image. These requirements include the following:

- An executive image can contain at most one image section of the following types and no others:
  - Nonpaged execute section (for code)
  - Nonpaged read/write section (for read-only and writable data, locations containing addresses that must be relocated at image activation, and the linkage section for nonpaged code)
  - Paged execute section (for code)
  - Paged read/write section (for read-only and writable data, locations containing addresses that must be relocated at image activation, and the linkage section for pageable code)
  - Initialization section (for initialization procedures and their associated linkage section and data)
  - Image activator fixup section

The modules of an executive image define program sections (PSECT) with distinct names. The named PSECT is necessary so that the program sections can be collected into clusters, by means of the COLLECT= linker option, during linking. A COLLECT= option specified in the linking of an executive image generates each of the first five image sections.

The linker creates the image activator fixup section to enable the image activator to finally resolve references to SYS\$BASE\_IMAGE.EXE and SYS\$PUBLIC\_VECTORS.EXE with addresses within the loaded executive image. Once the executive image has been initialized, the OpenVMS executive loader deallocates the memory for both the fixup section and the initialization section.

- In your linker options file, you use the COLLECT= option to collect the program sections from the modules comprising the executive image and place them into one of the standard clusters of an executive image, as described above, marked with the appropriate attributes. If the attributes of a PSECT being collected into an image section do not match the attributes of that section, you use the PSECT\_ATTR= option to force the attributes to match.

All PSECT must have the same attributes so that only one image section is produced from the cluster.

Note that, on OpenVMS Alpha systems, the execute section cannot contain data. You must collect all data, whether read-only or writable, into one of the read/write sections.

- You link an executive image as a type of shareable image that can be loaded into system space by the executive loader. You may link an executive image in such a way (using the /SECTION\_BINDING qualifier to the LINK command) that the executive loader consolidates its image sections into granularity hint regions within memory with similar image sections of the executive. This process yields a tangible performance benefit on OpenVMS Alpha systems. See the *OpenVMS Linker Utility Manual* for more information about section binding.

See Section 4.7.2.2 for a template of a LINK command and linker options file used to produce an executive image.

An executive image can contain one or more initialization procedures that are executed when the image is loaded. If the image is listed in SYS\$LOADABLE\_IMAGES:VMS\$SYSTEM\_IMAGES.DAT as created by means of System Management utility (SYSMAN) commands, initialization procedures can be run at various stages of system initialization.

An initialization routine performs a variety of functions, some specific to the features supported by the image and others required by many executive images. An executive image declares an initialization routine by invoking the INITIALIZATION\_ROUTINE macro (see Section 4.7.2.1).

Because an initialization routine is executed when the executive image is loaded, it serves as an ideal mechanism for locating the callable routines of an executive image in memory. One method for accomplishing this involves the following procedure:

- Establishing a vector table within the executive image. For instance, the MACRO-32 Compiler for OpenVMS Alpha would compile the following into the address of a vector table consisting of the procedure values of routines residing elsewhere in the image:

```
ROUTINE_VECTOR:
.ADDRESS      ROUTINE_A      ;address of routine A
.ADDRESS      ROUTINE_B      ;address of routine B
.
.
.ADDRESS      ROUTINE_M      ;address of routine M
```

- Declaring an initialization procedure using the INITIALIZATION\_ROUTINE macro.
- Loading the image by calling LDR\$LOAD\_IMAGE as described in Section 4.7.2.4, with LDR\$V\_USER\_BUF set in the flags longword that is the second argument to LDR\$LOAD\_IMAGE and with the address of a user buffer in the third argument. The dynamic loader passes the address of the user buffer to the initialization procedure.

Alternatively, you can use the System Management utility (SYSMAN) to load the executive image. Using a SYSMAN command to update the OpenVMS system images file (SYS\$LOADABLE\_IMAGES:VMS\$SYSTEM\_

## Process Control

### EXE\$WRITE\_PROCESS

IMAGES.DATA) allows the image to be loaded and initialized at various phases of system initialization (see Section 4.7.2.3).

- Inserting code in the initialization routine that locates the vector table and stores it in a place accessible to users of routines in the executive image.

An initialization routine can accomplish this by returning the address of the vector table to the caller of LDR\$LOAD\_IMAGE in the specified user buffer. The caller of LDR\$LOAD\_IMAGE can take whatever steps necessary to make the routines accessible to potential callers. One such mechanism is to call the Create Logical Name (\$CRELNM) system service to establish a systemwide logical name whose equivalence name is the address of the vector table.

#### 4.7.2.1 INITIALIZATION\_ROUTINE Macro (Alpha Only)

The following describes the invocation format of the INITIALIZATION\_ROUTINE macro. An equivalent macro, \$INITIALIZATION\_ROUTINE is provided for BLISS programmers. For C programmers, INIT\_RTN\_SETUP.H in SYS\$LIB\_C.TLB is available.

---

## INITIALIZATION\_ROUTINE

Declares a routine to be an initialization routine.

### Format

```
INITIALIZATION_ROUTINE name [,system_rtn=0] [,unload=0] [,priority=0]
```

### Parameters

#### **name**

Name of the initialization routine.

#### **[system\_rtn=0]**

Indicates whether the initialization routine is external to the module invoking the macro. The default value of 0, indicating that the initialization routine is part of the current module, is the only option supported on OpenVMS Alpha systems.

#### **[unload=0]**

Indicates whether the **name** argument specifies an unload routine. The default value of 0, indicating that the argument specifies an initialization routine, is the only option supported on OpenVMS Alpha systems.

#### **[priority=0]**

Indicates the PSECT in which the entry for this initialization routine should be placed. Routines that specify the **priority** argument as 0 are placed in the first PSECT (EXEC\$INIT\_000); those that specify a value of 1 are placed in the second (EXEC\$INIT\_001). The routines in the first PSECT are called before those in the second.

### Description

The INITIALIZATION\_ROUTINE macro declares a routine to be an initialization routine. It enters a vector for the routine in the initialization routine vector table, guaranteeing that this routine is called when the image is loaded by the OpenVMS loader.

#### 4.7.2.2 Linking an Executive Image (Alpha Only)

The following template can serve as the basis of a LINK command and linker options file used to create an OpenVMS executive image. See the *OpenVMS Linker Utility Manual* for a full description of most linker qualifiers and options referenced by this example.

---

**Note**

---

Use of the linker to create executive images (specifically the use of the /ATTRIBUTES switch on the COLLECT= option) is not documented elsewhere and is not supported by Compaq.

---

```

! Replace 'execl' with your image name
$ LINK/ALPHA/USERLIB=LNK$LIBRARY/NATIVE_ONLY/BPAGES=14 -
  /REPLACE/SECTION/NOTRACEBACK-
  /SHARE=EXE$:execl-
  /MAP=MAP$:execl /FULL /CROSS -
  /SYMBOL=EXE$:execl -
  SYS$INPUT/OPTION, -
!
SYMBOL TABLE=GLOBALS
! Creates .STB for System Dump Analyzer
CLUSTER=execl,,- ❶
ALPHA$LIBRARY:STARLET/INCLUDE:(SYS$DOINIT) - ❷
! Insert executive object code here
ALPHA$LOADABLE_IMAGES:SYS$BASE_IMAGE.EXE/SHAREABLE/SELECTIVE
PSECT_ATTR=EXEC$INIT_LINKAGE,PIC,USR,CON,REL,GBL,NOSHR,EXE,RD,WRT,NOVEC ❸
!
COLLECT=NONPAGED_READONLY_PSECTS/ATTRIBUTES=RESIDENT,- ❹
  nonpaged_code
COLLECT=NONPAGED_READWRITE_PSECTS/ATTRIBUTES=RESIDENT,-
  nonpaged_data,-
  nonpaged_linkage
COLLECT=PAGED_READONLY_PSECTS,-
  paged_code,-
  $CODE$
COLLECT=PAGED_READWRITE_PSECTS,-
  paged_data,-
  paged_linkage,-
  $LINK$,-
  $PLIT$,-
  $INITIAL$,-
  $LITERAL$,-
  $GLOBAL$,-
  $OWN$,-
  $DATA$
COLLECT=INITIALIZATION_PSECTS/ATTRIBUTES=INITIALIZATION_CODE,-
  EXEC$INIT_CODE,-
  EXEC$INIT_LINKAGE,-
  EXEC$INIT_000,-
  EXEC$INIT_001,-
  EXEC$INIT_002,-
  EXEC$INIT_SSTBL_000,-
  EXEC$INIT_SSTBL_001,-
  EXEC$INIT_SSTBL_002

```

- ❶ The CLUSTER= option creates the named cluster *execl*, specifying the order in which the linker processes the listed modules.

## Process Control

### INITIALIZATION\_ROUTINE

- ② The object module SYS\$DOINIT (in STARLET.OLB) is explicitly linked into an executive image. This module declares the initialization routine table and provides routines to drive the actual initialization of an executive image.
- ③ The image sections in an executive image are generated according to the attributes assigned to program sections within source modules by the compilers and linker. Because an executive image can consist only of a certain number and type of image section, the options file contains PSECT\_ATTR= options to coerce the attributes of various program sections contributing to the image so that the linker produces only one image section from the cluster. Correspondingly, the options file consists of a set of COLLECT= options clauses to collect these program sections into each permitted image section.
- ④ This series of COLLECT= options is required to create and assign image section attributes (RESIDENT or INITIALIZATION\_CODE) to the NONPAGED\_READONLY\_PSECTS, NONPAGED\_READWRITE\_PSECTS, and INITIALIZATION\_PSECTS image sections of an executive image. Each COLLECT= option collects a set of program sections with similar attributes into a cluster that the linker uses to produce one of the permitted image sections for an executive image.

#### 4.7.2.3 Loading an Executive Image (Alpha Only)

There are two methods of loading an executive image:

- Calling LDR\$LOAD\_IMAGE to load the executive image at run time. This method lets you pass the address of a buffer to the image's initialization routine by which the caller and the initialization routine can exchange data. Section 4.7.2.4 describes LDR\$LOAD\_IMAGE. Note that you must link the code that calls LDR\$LOAD\_IMAGE against the system base image, using the /SYSEXE qualifier to the LINK command.
- Using the SYSMAN SYS\_LOADABLE ADD command and updating the OpenVMS system images file (SYS\$LOADABLE\_IMAGES:VMS\$SYSTEM\_IMAGES.DATA). This method causes the executive image to be loaded and initialized during the phases of system initialization. (See *VMS for Alpha Platforms Internals and Data Structures* for information about how an executive image's initialization routine is invoked during system initialization.)

To load an executive image with the System Management utility (SYSMAN), perform the following tasks:

1. Copy the executive image to SYS\$LOADABLE\_IMAGES.
2. Add an entry for the executive image in the data file SYS\$UPDATE:VMS\$SYSTEM\_IMAGES.IDX, as follows:

```
SYSMAN SYS_LOADABLE ADD _LOCAL_ executive-image -  
/LOAD_STEP = SYSINIT -  
/SEVERITY = WARNING -  
/MESSAGE = "failure to load executive-image"
```

3. Invoke the SYS\$UPDATE:VMS\$SYSTEM\_IMAGES.COM command procedure to generate a new system image data file (file name SYS\$LOADABLE\_IMAGES:VMS\$SYSTEM\_IMAGES.DATA). During the bootstrap, the system uses this data file to load the appropriate images.
4. Reboot the system. This causes the new executive image to be loaded into the system.



#### 4.7.2.4 LDR\$LOAD\_IMAGE (Alpha Only)

The following is a description of the callable interface to LDR\$LOAD\_IMAGE.

### LDR\$LOAD\_IMAGE

Loads an OpenVMS executive image into the system.

#### Module

SYSLDR\_DYN

#### Format

LDR\$LOAD\_IMAGE filename ,flags ,ref\_handle ,user\_buf

#### Arguments

##### filename

OpenVMS usage character string  
 type character string  
 access read only  
 mechanism by descriptor

The longword address of a character string descriptor containing the file name of the executive image to be loaded. The file name can include a directory specification and image name, but no device name. If you omit the directory specification, LDR\$LOAD\_IMAGE supplies SYS\$LOADABLE\_IMAGES as the default.

##### flags

OpenVMS usage flags  
 type longword (unsigned)  
 access read only  
 mechanism value

A flags longword, containing the following bit fields. (Symbolic names for these bit fields are defined by the \$LDRDEF macro in SYS\$LIBRARY:LIB.MLB.)

Bit Field	Description
LDR\$V_PAG	When set, indicates that the image should be loaded with its pageable sections resident. The flag is generally based on the value of the bit 0 in the S0_PAGING system parameter.
LDR\$V_UNL	When set, indicates that the image may be removed from memory.
LDR\$V_OVR	When set, indicates that the image's read-only sections should not be overwritten during bugcheck processing. This flag is not used on OpenVMS Alpha systems.
LDR\$V_USER_BUF	When set, indicates that the caller has passed the address of a buffer that should be passed to the initialization routine.

## Process Control

### LDR\$LOAD\_IMAGE

Bit Field	Description
LDR\$V_NO_SLICE	When set, indicates that the image's sections should not be loaded into a granularity hint region.

#### ref\_handle

OpenVMS usage address  
type longword (signed)  
access write only  
mechanism by reference

The longword address of a reference handle, a three-longword buffer to be filled by LDR\$LOAD\_IMAGE as follows:

+00 Address of loaded image or zero if image was loaded sliced.  
+04 Address of loaded image data block (LDRIMG). See the \$LDRIMGDEF macro definition in SYS\$LIBRARY:LIB.MLB and *VMS for Alpha Platforms Internals and Data Structures* for a description of the LDRIMG structure.  
+08 Loaded image sequence number.

#### user\_buf

OpenVMS usage address  
type longword (signed)  
access read only  
mechanism by reference

The longword address of a user buffer passed to executive image's initialization routine if LDR\$V\_USER\_BUF is set in the flags longword.

## Context

LDR\$LOAD\_IMAGE must be called in executive mode.

## Returns

OpenVMS usage cond\_value  
type longword (unsigned)  
access write only  
mechanism by value

Status indicating the success or failure of the operation.

## Return Values

SS\$\_ACCVIO Unable to read the character string descriptor containing the file name of the executive image to be loaded or to write the reference handle.

LOADER\$\_BAD\_GSD An executive image was loaded containing a global symbol that is not vectored through either the SYS\$BASE\_IMAGE or the SYS\$PUBLIC\_VECTORS image.

SS\$_BADIMGHDR	Image header is larger than two blocks or was built with a version of the linker that is incompatible with LDR\$LOAD_IMAGE.
LOADER\$_BADIMGOFF	During a sliced image load request, a relocation or fixup operation was attempted on an image offset that has no resultant address within the image.
LOADER\$_DZRO_ISD	A load request was made for an executive image that illegally contains demand zero sections.
SS\$_INSFARG	Fewer than three arguments were passed to LDR\$LOAD_IMAGE, or, with LDR\$V_USER_BUF set in the flags longword, fewer than four arguments.
SS\$_INSFMEM	Insufficient nonpaged pool for the LDRIMG structure or insufficient physical memory to load nonpageable portion of an executive image (that is, an image loaded as nonsliced).
SS\$_INSFSPTS	Insufficient system page table entries (SPTEs) to describe the address space required for the executive image to be loaded as nonsliced.
LOADER\$_MULTIPLE_ISDS	A load request was made for an image that was not linked correctly because it contains more than one each of the following types of sections: <ul style="list-style-type: none"><li>fixup</li><li>initialization</li><li>nonpaged code</li><li>nonpaged data</li><li>paged code</li><li>paged data</li></ul>
LOADER\$_NO_PAGED_ISDS	SYSBOOT failed to load the executive image because it contains either paged code or paged data sections.
SS\$_NOPRIV	LDR\$LOAD_IMAGE was called from user or supervisor mode.
LOADER\$_NO_SUCH_IMAGE	A load request was made for an executive image that was linked against a shareable image that is not loaded. The only legal shareable images for executive images are SYS\$BASE_IMAGE and SYS\$PUBLIC_VECTORS.
SS\$_NORMAL	Normal, successful completion.
LOADER\$_PAGED_GST_TOBIG	An executive image has more global symbols in the fixup data than can fit in the loader's internal tables.
LOADER\$_PSB_FIXUPS	A load request was made for an executive image that contains LPPSB fixup because it was linked /NONATIVE_ONLY. Executive images must be linked /NATIVE_ONLY.

## Process Control

### LDR\$LOAD\_IMAGE

LOADER\$_SPF_TOBIG	The loader's internal tables cannot accommodate all of the executive image fixups that must be postponed to later in the bootstrap operation.
SS\$_SYSVERDIF	Image was linked with versions of executive categories incompatible with those of the running system.
LOADER\$_VEC_TOBIG	An attempt to load an executive image failed because the image's symbol vector updates for SYS\$BASE_IMAGE and SYS\$PUBLIC_VECTORS exceed the size of the loader's internal tables.
Other	Any RMS error status returned from \$OPEN failures. Any I/O error status returned from \$QIO failures.

### Description

LDR\$LOAD\_IMAGE loads an executive image into system space and calls its initialization routine. Optionally, LDR\$LOAD\_IMAGE returns information about the loaded image to its caller.

The initialization routine is passed by two or three longword arguments, depending upon the setting of LDR\$V\_USER\_BUF:

- Address of loaded image data block (LDRIMG)
- The flags longword
- The longword address of a user buffer passed to the executive image's initialization routine (if LDR\$V\_USER\_BUF is set in the flags longword)

---

#### 4.7.2.5 LDR\$UNLOAD\_IMAGE (Alpha Only)

The following is a description of the callable interface to LDR\$UNLOAD\_IMAGE.

---

### LDR\$UNLOAD\_IMAGE

Unloads a removable executive image. This routine is called to unload an execlct. All resources are returned.

#### Module

SYSLDR\_DYN

#### Format

LDR\$UNLOAD\_IMAGE filename ,ref\_handle

## Arguments

### filename

OpenVMS usage character string  
type character string  
access read only  
mechanism by descriptor

The longword address of a character string descriptor containing the file name of the executive image to be unloaded. The file name must be supplied exactly as it was supplied to LDR\$LOAD\_IMAGE when the executive image was loaded.

### ref\_handle

OpenVMS usage address  
type longword (signed)  
access read only  
mechanism by reference

The longword address of the reference handle containing the three-longword block returned by LDR\$LOAD\_IMAGE when the executive image was loaded.

## Context

LDR\$UNLOAD\_IMAGE must be called in kernel mode.

## Returns

OpenVMS usage cond\_value  
type longword (unsigned)  
access write only  
mechanism by value

Status indicating the success or failure of the operation.

## Return Values

SS\$_INSFARG	LDR\$UNLOAD_IMAGE was not called with two parameters.
SS\$_BADPARAMS	Reference handle data inconsistent with LDRIMG block that matches the name in the first argument.
LOADER\$_MARKUNL	A call was made to the LDR\$UNLOAD_IMAGE routine to unload a removable executive image that already has an outstanding unload request against it.
SS\$_NOPRIV	LDR\$UNLOAD_IMAGE was not called in kernel mode.
SS\$_NORMAL	Executive image was successfully removed from the system.
LOADER\$_NOT_UNL	A call was made to LDR\$UNLOAD_IMAGE to unload an executive image that is not loaded or that was not loaded with the LDR\$V_UNL flag bit set.

## Process Control

### LDR\$UNLOAD\_IMAGE

LOADER\$\_UNL\_PEN

A call was made to LDR\$UNLOAD\_IMAGE to unload an executive image that is in use. The image is marked to be unloaded later.

### Description

LDR\$UNLOAD\_IMAGE removes an executive image from system space and returns all memory resources allocated when the image was loaded. Images can only be removed if they were originally loaded with the bit LDR\$V\_UNL set in the input flags to LDR\$LOAD\_IMAGE.

## 4.8 Synchronizing Programs by Specifying a Time for Program Execution

## 4.8 Synchronizing Programs by Specifying a Time for Program Execution

You can synchronize timed program execution in the following ways:

- Executing a program at a specific time
- Executing a program at timed intervals

## 4.8.1 Obtaining the System Time

The process control procedures that allow you to synchronize timed program execution require you to supply a system time value.

You can use either system services or RTL routines for obtaining and reading time. They are summarized in Table 4–10. With these routines, you can determine the system time, convert it to an external time, and pass a time back to the system. The system services use the operating system's default date format. With the RTL routines, you can use the default format or specify your own date format. However, if you are just using the time and date for program synchronization, using the operating system's default format is probably sufficient.

When using the RTL routines to change date/time formats, initialization routines are required. Refer to the *OpenVMS RTL Library (LIB\$) Manual* for more information.

See Chapter 27 for a further discussion of using timing operations with the operating system.

**Table 4–10 Time Manipulation System Services and Routines**

Routine	Description
SYS\$GETTIM	Obtains the current date and time in 64-bit binary format
SYS\$NUMTIM	Converts system date and time to numeric integer values
SYS\$ASCTIM	Converts an absolute or delta time from 64-bit system time format to an ASCII string
SYS\$ASCUTC	Converts an absolute time from 128-bit Coordinated Universal Time (UTC) format to an ASCII string
LIB\$SYS_ASCTIM	Converts binary time to an ASCII string
SYS\$BINTIM	Converts a date and time from ASCII to system format
SYS\$BINUTC	Converts an ASCII string to an absolute time value in the 128-bit UTC format
SYS\$FAO	Converts a binary value into an ASCII character string in decimal, hexadecimal, or octal notation and returns the character string in an output string
SYS\$GETUTC	Returns the current time in 128-bit UTC format
SYS\$NUMUTC	Converts an absolute 128-bit binary time into its numeric components. The numeric components are returned in local time
SYS\$TIMCON	Converts 128-bit UTC to 64-bit system format or 64-bit system format to 128-bit UTC based on the value of the convert flag

(continued on next page)

## Process Control

### 4.8 Synchronizing Programs by Specifying a Time for Program Execution

Table 4–10 (Cont.) Time Manipulation System Services and Routines

Routine	Description
LIB\$ADD_TIMES	Adds two quadword times
LIB\$CONVERT_DATE_STRING	Converts an input date/time string to an operating system internal time
LIB\$CVT_FROM_INTERNAL_TIME	Converts internal time to external time
LIB\$CVTF_FROM_INTERNAL_TIME	Converts internal time to external time (F-floating value)
LIB\$CVT_TO_INTERNAL_TIME	Converts external time to internal time
LIB\$CVTF_TO_INTERNAL_TIME	Converts external time to internal time (F-floating value)
LIB\$CVT_VECTIM	Converts 7-word vector to internal time
LIB\$DAY	Obtains offset to current day from base time, in number of days
LIB\$DATE_TIME	Obtains the date and time in user-specified format
LIB\$FORMAT_DATE_TIME	Formats a date and/or time for output
LIB\$FREE_DATE_TIME_CONTEXT	Frees date/time context
LIB\$GET_DATE_FORMAT	Returns the user's specified date/time input format
LIB\$GET_MAXIMUM_DATE_LENGTH	Returns the maximum possible length of an output date/time string
LIB\$GET_USERS_LANGUAGE	Returns the user's selected language
LIB\$INIT_DATE_TIME_CONTEXT	Initializes the date/time context with a user-specified format
LIB\$SUB_TIMES	Subtracts two quadword times

#### 4.8.1.1 Executing a Program at a Specified Time

To execute a program at a specified time, use LIB\$SPAWN to create a process that executes a command procedure containing two commands—the DCL command WAIT and the command that invokes the desired program. Because you do not want the parent process to remain in hibernation until the process executes, execute the process concurrently.

You can also use the SYS\$CREPRC system service to execute a program at a specified time. However, because a process created by SYS\$CREPRC hibernates rather than terminates after executing the desired program, Compaq recommends you use the LIB\$SPAWN routine unless you need a detached process.

Example 4–14 executes a program at a specified delta time. The parent program prompts the user for a delta time, equates the delta time to the symbol EXECUTE\_TIME, and then creates a subprocess to execute the command procedure LATER.COM. LATER.COM uses the symbol EXECUTE\_TIME as the parameter for the WAIT command. (You might also allow the user to enter an absolute time and have your program change it to a delta time by subtracting the current time from the specified time. Chapter 27 discusses time manipulation.)

#### Example 4–14 Executing a Program Using Delta Time

```
! Delta time
CHARACTER*17 TIME
INTEGER LEN
```

(continued on next page)



## 4.8 Synchronizing Programs by Specifying a Time for Program Execution

**Example 4–14 (Cont.) Executing a Program Using Delta Time**

```

! Mask for LIB$SPAWN
INTEGER*4 MASK

! Declare status and library routine
INTEGER STATUS, LIB$SPAWN

! Get delta time
STATUS = LIB$GET_INPUT (TIME,
2                      'Time (delta): ',
2                      LEN)
IF (.NOT. STATUS) CALL LIB$SIGNAL (%VAL (STATUS))
! Equate symbol to TIME
STATUS = LIB$SET_SYMBOL ('EXECUTE_TIME',
2                      TIME(1:LEN))
IF (.NOT. STATUS) CALL LIB$SIGNAL (%VAL (STATUS))
! Set the mask and call LIB$SPAWN
MASK = IBSET (MASK,0)           ! Execute subprocess concurrently
STATUS = LIB$SPAWN('@LATER',
2                  'DATA84.IN',
2                  'DATA84.RPT',
2                  MASK)

END

```

**LATER.COM**

```

$ WAIT 'EXECUTE_TIME'
$ RUN SYS$DRIVE0:[USER.MATH]CALC
$ DELETE/SYMBOL EXECUTE_TIME

```

**4.8.1.2 Executing a Program at Timed Intervals**

To execute a program at timed intervals, you can use either LIB\$SPAWN or SYS\$CREPRC.

**Using LIB\$SPAWN**

Using LIB\$SPAWN, you can create a subprocess that executes a command procedure containing three commands: the DCL command WAIT, the command that invokes the desired program, and a GOTO command that directs control back to the WAIT command. Because you do not want the parent process to remain in hibernation until the subprocess executes, execute the subprocess concurrently. See Section 4.8.1.1 for an example of LIB\$SPAWN.

**Using SYS\$CREPRC**

Using SYS\$CREPRC, create a detached process to execute a program at timed intervals as follows:

1. Create and hibernate a process—Use SYS\$CREPRC to create a process that executes the desired program. Set the PRC\$V\_HIBER bit of the **stsf** argument of the SYS\$CREPRC system service to indicate that the created process should hibernate before executing the program.
2. Schedule a wakeup call for the created subprocess—Use the SYS\$SCHDWK system service to specify the time at which the system should wake up the subprocess, and a time interval at which the system should repeat the wakeup call.

## Process Control

### 4.8 Synchronizing Programs by Specifying a Time for Program Execution

Example 4–15 executes a program at timed intervals. The program creates a subprocess that immediately hibernates. (The identification number of the created subprocess is returned to the parent process so that it can be passed to SYS\$SCHEDWK.) The system wakes up the subprocess at 6:00 a.m. on the 23rd (month and year default to system month and year) and every 10 minutes thereafter.

#### Example 4–15 Executing a Program at Timed Intervals

```
! SYS$CREPRC options and values
INTEGER OPTIONS
EXTERNAL PRC$V_HIBER
! ID of created subprocess
INTEGER CR_ID
! Binary times
INTEGER TIME(2),
2     INTERVAL(2)
.
.
.
! Set the PRC$V_HIBER bit in the OPTIONS mask and
! create the process
OPTIONS = IBSET (OPTIONS, %LOC(PRC$V_HIBER))
STATUS = SYS$CREPRC (CR_ID,      ! PID of created process
2     'CHECK',      ! Image
2
2     'SLEEP',      ! Process name
2     %VAL(4),      ! Priority
2
2     %VAL(OPTIONS)) ! Hibernate
IF (.NOT. STATUS) CALL LIB$SIGNAL (%VAL(STATUS))
! Translate 6:00 a.m. (absolute time) to binary
STATUS = SYS$BINTIM ('23-- 06:00:00.00', ! 6:00 a.m.
2     TIME)
IF (.NOT. STATUS) CALL LIB$SIGNAL (%VAL(STATUS))
! Translate 10 minutes (delta time) to binary
STATUS = SYS$BINTIM ('0 :10:00.00',      ! 10 minutes
2     INTERVAL)
IF (.NOT. STATUS) CALL LIB$SIGNAL (%VAL(STATUS))
! Schedule wakeup calls
STATUS = SYS$SCHEDWK (CR_ID,      ! ID of created process
2
2     TIME,      ! Initial wakeup time
2     INTERVAL) ! Repeat wakeup time
IF (.NOT. STATUS) CALL LIB$SIGNAL (%VAL(STATUS))
.
.
.
```

#### 4.8.2 Placing Entries in the System Timer Queue

When you use the system timer queue, you use the timer expiration to signal when a routine is to be executed. It allows the caller to request a timer that will activate sometime in the future. The timer is requested for the calling kernel thread. When the timer activates, the event is reported to that thread. It does not affect any other thread in the process.

For the actual signal, you can use an event flag or AST. With this method, you do not need a separate process to control program execution. However, you do use up your process's quotas for ASTs and timer queue requests.

## 4.8 Synchronizing Programs by Specifying a Time for Program Execution

Use the system service `SYS$SETIMR` to place a request in the system timer queue. The format of this service is as follows:

```
SYS$SETIMR ([efn] ,daytim ,[astadr] ,[reqidt] ,[flags])
```

### Specifying the Starting Time

Specify the absolute or delta time at which you want the program to begin execution using the **daytim** argument. Use the `SYS$BINTIM` system service to convert an ASCII time to the binary system format required for this argument.

### Signaling Timer Expiration

Once the system has reached this time, the timer expires. To signal timer expiration, set an event flag in the **efn** argument or specify an AST routine to be executed in the **astadr** argument. Refer to Section 6.6 and Chapter 8 for more information about using event flags and ASTs.

### How Timer Requests Are Identified

The **reqidt** argument identifies each system time request uniquely. Then, if you need to cancel a request, you can refer to each request separately.

To cancel a timer request, use the `SYS$CANTIM` system service.

## 4.9 Controlling Kernel Threads and Process Execution

You can control kernel threads and process execution in the following ways:

- Suspending a process—All kernel threads associated with the specified process are suspended.
- Hibernating a process—Only the calling kernel thread is hibernated.
- Stopping a process—All kernel threads associated with the specified process are stopped.
- Resuming a process—All kernel threads associated with the specified process are resumed.
- Exiting an image—All kernel threads associated with the specified process are exited.
- Deleting a process—All kernel threads associated with the specified process are deleted, and then the process is deleted.

### 4.9.1 Process Hibernation and Suspension

There are two ways to halt the execution of a kernel thread or process temporarily:

- Hibernation—Performed by the Hibernate (`SYS$HIBER`) system service, which affects the calling kernel thread.
- Suspension—Performed by the Suspend Process (`SYS$SUSPND`) system service, which affects all of the kernel threads associated with the specified process.

The kernel thread can continue execution normally only after a corresponding Wake from Hibernation (`SYS$WAKE`) system service (if it is hibernating), or after a Resume Process (`SYS$RESUME`) system service, if it is suspended.

Suspending or hibernating a kernel thread puts it into a dormant state; the thread is not deleted.

## Process Control

### 4.9 Controlling Kernel Threads and Process Execution

A process in hibernation can control itself; a process in suspension requires another process to control it. Table 4–11 compares hibernating and suspended processes.

**Table 4–11 Process Hibernation and Suspension**

Hibernation	Suspension
Can cause only self to hibernate.	Can suspend self or another process, depending on privilege; suspends all threads associated with the specified process.
Reversed by SYS\$WAKE/SYS\$SCHDWK system service.	Reversed by SYS\$RESUME system service.
Interruptible; can receive ASTs.	Noninterruptible; cannot receive ASTs <sup>1</sup> .
Can wake self.	Cannot cause self to resume.
Can schedule wake up at an absolute time or at a fixed time interval.	Cannot schedule resumption.

<sup>1</sup>If a process is suspended in kernel mode (a hard suspension), it cannot receive any ASTs. If a process is suspended at supervisor mode (a soft suspension), it can receive executive or kernel mode ASTs. See the description of SYS\$SUSPND in the *OpenVMS System Services Reference Manual: GETUTC-Z*.

Table 4–12 summarizes the system services and routines that can place a process in or remove a process from hibernation or suspension.

**Table 4–12 System Services and Routines Used for Hibernation and Suspension**

Routine	Function
<b>Hibernating Processes</b>	
SYS\$HIBER	Places the requesting kernel thread in the hibernation state. An AST can be delivered to the thread while it is hibernating. The service puts only the calling thread into HIB; no other thread is affected.
SYS\$WAKE	Resumes execution of a kernel thread in hibernation. This service wakes all hibernating kernel threads in a process regardless of the caller. Any thread that is not hibernating when the service is called is marked <i>wake pending</i> . Because of the wake pending, the next call to SYS\$HIBER completes immediately and the thread does not hibernate. Premature wakeups must be handled in the code.
SYS\$SCHDWK	Resumes execution of a kernel thread in hibernation at a specified time. This service schedules a wakeup request for a thread that is about to call SYS\$HIBER. The wakeup affects only the requesting thread; any other hibernating kernel threads are not affected.
LIB\$WAIT	Uses the services SYS\$SCHDWK and SYS\$HIBER.
SYS\$CANWAK	Cancels a scheduled wakeup issued by SYS\$SCHDWK. Unless called with a specific timer request ID, this service cancels all timers for all threads in the process regardless of the calling thread.

(continued on next page)

## Process Control

### 4.9 Controlling Kernel Threads and Process Execution

**Table 4–12 (Cont.) System Services and Routines Used for Hibernation and Suspension**

Routine	Function
<b>Suspended Kernel Threads and Processes</b>	
SYS\$SUSPEND	Puts in a suspended state all threads associated with the specified process.
SYS\$RESUME	Puts in an execution state all threads of the specified process.

#### 4.9.1.1 Using Process Hibernation

The hibernate/wake mechanism provides an efficient way to prepare an image for execution and then to place it in a wait state until it is needed.

If you create a subprocess that must execute the same function repeatedly and must execute immediately when it is needed, you could use the SYS\$HIBER and SYS\$WAKE system services, as shown in the following example:

```

/* Process TAURUS */
#include <stdio.h>
#include <descrip.h>
main() {
    unsigned int status;
    $DESCRIPTOR(prcnam, "ORION");
    $DESCRIPTOR(image, "COMPUTE.EXE");

    /* Create ORION */
    status = SYS$CREPRC(0,           ❶      /* Process id */
                       &image,
                       0, 0, 0, 0, 0, /* Image */
                       &prcnam,
                       0, 0, 0, 0);   /* Process name */
    if ((status & 1) != 1)
        LIB$SIGNAL(status);
    .
    .
    .
    /* Wake ORION */
    status = SYS$WAKE(0, &prcnam);    ❷
    if ((status & 1) != 1)
        LIB$SIGNAL(status);
    .
    .
    .
    /* Wake ORION again */
    status = SYS$WAKE(0, &prcnam);
    if ((status & 1) != 1)
        LIB$SIGNAL(status);
    .
    .
    .
}
/* Process ORION and image COMPUTE */

```

## Process Control

### 4.9 Controlling Kernel Threads and Process Execution

```
#include <stdio.h>
#include <ssdef.h>
.
.
.
sleep:
    status = SYS$HIBER();
    if ((status & 1) != 1)
        LIB$SIGNAL(status);
.
.
.
    goto sleep;
}
```

- ❶ Process TAURUS creates the process ORION, specifying the descriptor for the image named COMPUTE.
- ❷ At an appropriate time, TAURUS issues a SYS\$WAKE request for ORION. ORION continues execution following the SYS\$HIBER service call. When it finishes its job, ORION loops back to repeat the SYS\$HIBER call and to wait for another wakeup.
- ❸ The image COMPUTE is initialized, and ORION issues the SYS\$HIBER system service.

The Schedule Wakeup (SYS\$SCHDWK) system service, a variation of the SYS\$WAKE system service, schedules a wakeup for a hibernating process at a fixed time or at an elapsed (delta) time interval. Using the SYS\$SCHDWK service, a process can schedule a wakeup for itself before issuing a SYS\$HIBER call. For an example of how to use the SYS\$SCHDWK system service, see Chapter 27.

Hibernating processes can be interrupted by asynchronous system traps (ASTs), as long as AST delivery is enabled. The process can call SYS\$WAKE on its own behalf in the AST service routine, and continue execution following the execution of the AST service routine. For a description of ASTs and how to use them, see Chapter 8.

#### 4.9.1.2 Using Alternative Methods of Hibernation

You can use two additional methods to cause a process to hibernate:

- Specify the **stsflg** argument for the SYS\$CREPRC system service, setting the bit that requests SYS\$CREPRC to place the created process in a state of hibernation as soon as it is initialized.
- Specify the /DELAY, /SCHEDULE, or /INTERVAL qualifier to the RUN command when you execute the image from the command stream.

When you use the SYS\$CREPRC system service, the creating process can control when to wake the created process. When you use the RUN command, its qualifiers control when to wake the process.

If you use the /INTERVAL qualifier and the image to be executed does not call the SYS\$HIBER system service, the image is placed in a state of hibernation whenever it issues a return instruction (RET). Each time the image is awakened, it begins executing at its entry point. If the image does call SYS\$HIBER, each time it is awakened it begins executing at either the point following the call to SYS\$HIBER or at its entry point (if it last issued a RET instruction).

## 4.9 Controlling Kernel Threads and Process Execution

If wakeup requests are scheduled at time intervals, the image can be terminated with the Delete Process (SYS\$DELPRC) or Force Exit (SYS\$FORCEX) system service, or from the command level with the STOP command. The SYS\$DELPRC and SYS\$FORCEX system services are described in Section 4.9.3.4 and in Section 4.9.4. The RUN and STOP commands are described in the *OpenVMS DCL Dictionary*.

These methods allow you to write programs that can be executed once, on request, or cyclically. If an image is executed more than once in this manner, normal image activation and termination services are not performed on the second and subsequent calls to the image. Note that the program must ensure both the integrity of data areas that are modified during its execution and the status of opened files.

### 4.9.1.3 Using SYSSUSPND

Using the Suspend Process (SYSSUSPND) system service, a process can place itself or another process into a wait state similar to hibernation. Suspension, however, is a more pronounced state of hibernation. The operating system provides no system service to force a process to be swapped out, but the SYSSUSPND system service can accomplish the task in the following way. Suspended processes are the first processes to be selected for swapping. A suspended process cannot be interrupted by ASTs, and it can resume execution only after another process calls a Resume Process (SYS\$RESUME) system service on its behalf. If ASTs are queued for the process while it is suspended, they are delivered when the process resumes execution. This is an effective tool for blocking delivery of all ASTs.

At the DCL level, you can suspend a process by issuing the SET PROCESS command with the /SUSPEND qualifier. This command temporarily stops the process's activities. The process remains suspended until another process resumes or deletes it. To allow a suspended process to resume operation, use either the /NOSUSPEND or /RESUME qualifier.

## 4.9.2 Passing Control to Another Image

The RTL routines LIB\$DO\_COMMAND and LIB\$RUN\_PROGRAM allow you to invoke the next image from the current image. That is, they allow you to perform image rundown for the current image and pass control to the next image without returning to DCL command level. The routine you use depends on whether the next image is a command image or a noncommand image.

### 4.9.2.1 Invoking a Command Image

The following DCL command executes the command image associated with the DCL command COPY:

```
$ COPY DATA.TMP APRIL.DAT
```

To pass control from the current image to a command image, use the run-time library (RTL) routine LIB\$DO\_COMMAND. If LIB\$DO\_COMMAND executes successfully, control is not returned to the invoking image, and statements following the LIB\$DO\_COMMAND statement are not executed. The following statement causes the current image to exit and executes the DCL command in the preceding example:

## Process Control

### 4.9 Controlling Kernel Threads and Process Execution

```
.  
:  
:  
STATUS = LIB$DO_COMMAND ('COPY DATA.TMP APRIL.DAT')  
IF (.NOT. STATUS) CALL LIB$SIGNAL (%VAL(STATUS))  
END
```

To execute a number of DCL commands, specify a DCL command procedure. The following statement causes the current image to exit and executes the DCL command procedure [STATS.TEMP]CLEANUP.COM:

```
.  
:  
:  
STATUS = LIB$DO_COMMAND ('@[STATS.TEMP]CLEANUP')  
IF (.NOT. STATUS) CALL LIB$SIGNAL (%VAL(STATUS))  
END
```

#### 4.9.2.2 Invoking a Noncommand Image

You invoke a noncommand image at DCL command level with the DCL command RUN. The following command executes the noncommand image [STATISTICS.TEMP]TEST.EXE:

```
$ RUN [STATISTICS.TEMP]TEST
```

To pass control from the current image to a noncommand image, use the run-time library routine LIB\$RUN\_PROGRAM. If LIB\$RUN\_PROGRAM executes successfully, control is not returned to the invoking image, and statements following the LIB\$RUN\_PROGRAM statement are not executed. The following program segment causes the current image to exit and passes control to the noncommand image [STATISTICS.TEMP]TEST.EXE on the default disk:

```
.  
:  
:  
STATUS = LIB$RUN_PROGRAM ('[STATISTICS.TEMP]TEST.EXE')  
IF (.NOT. STATUS) CALL LIB$SIGNAL (%VAL(STATUS))  
END
```

#### 4.9.3 Performing Image Exit

When image execution completes normally, the operating system performs a variety of image rundown functions. If the image is executed by the command interpreter, image rundown prepares the process for the execution of another image. If the image is not executed by the command interpreter—for example, if it is executed by a subprocess—the process is deleted.

Main programs and main routines terminate by executing a return instruction (RET). This instruction returns control to the caller, which could have been LIB\$INITIALIZE, the debugger, or the command interpreter. The completion code, SS\$\_NORMAL, which has the value 1, should be used to indicate normal successful completion.

Any other condition value can be used to indicate success or failure. The command language interpreter uses the condition value as the parameter to the Exit (SYS\$EXIT) system service. If the severity field (STS\$V\_SEVERITY) is SEVERE or ERROR, the continuation of a batch job or command procedure is affected.



## 4.9 Controlling Kernel Threads and Process Execution

These exit activities are also initiated when an image completes abnormally as a result of any of the following conditions:

- Specific error conditions caused by improper specifications when a process is created. For example, if an invalid device name is specified for the SYS\$INPUT, SYS\$OUTPUT, or SYS\$ERROR logical name, or if an invalid or nonexistent image name is specified, the error condition is signaled in the created process.
- An exception occurring during execution of the image. When an exception occurs, any user-specified condition handlers receive control to handle the exception. If there are no user-specified condition handlers, a system-declared condition handler receives control, and it initiates exit activities for the image. Condition handling is described in Chapter 9.
- A Force Exit (SYS\$FORCEX) system service issued on behalf of the process by another process.

### 4.9.3.1 Performing Image Rundown

The operating system performs image rundown functions that release system resources obtained by a process while it is executing in user mode. These activities occur in the following order:

1. Any outstanding I/O requests on the I/O channels are canceled, and I/O channels are deassigned.
2. Memory pages occupied or allocated by the image are deleted, and the working set size limit of the process is readjusted to its default value.
3. All devices allocated to the process at user mode are deallocated (devices allocated from the command stream in supervisor mode are not deallocated).
4. Timer-scheduled requests, including wakeup requests, are canceled.
5. Common event flag clusters are disassociated.
6. Locks are dequeued as a part of rundown.
7. User mode ASTs that are queued but have not been delivered are deleted, and ASTs are enabled for user mode.
8. Exception vectors declared in user mode, compatibility mode handlers, and change mode to user handlers are reset.
9. System service failure exception mode is disabled.
10. All process private logical names and logical name tables created for user mode are deleted. Deletion of a logical name table causes all names in that table to be deleted. Note that names entered in shareable logical name tables, such as the job or group table, are not deleted at image rundown, regardless of the access mode for which they were created.

### 4.9.3.2 Initiating Rundown

To initiate the rundown activities described in Section 4.9.3.1, the system calls the Exit (SYS\$EXIT) system service on behalf of the process. In some cases, a process can call SYS\$EXIT to terminate the image itself (for example, if an unrecoverable error occurs).

You should not call the SYS\$EXIT system service directly from a main program. By not calling SYS\$EXIT directly from a main program, you allow the main program to be more like ordinary modular routines and therefore usable by other programmers as callable routines.

## Process Control

### 4.9 Controlling Kernel Threads and Process Execution

The `SYS$EXIT` system service accepts a status code as an argument. If you use `SYS$EXIT` to terminate image execution, you can use this status code argument to pass information about the completion of the image. If an image returns without calling `SYS$EXIT`, the current value in `R0` is passed as the status code when the system calls `SYS$EXIT`.

This status code is used as follows:

- The command interpreter uses the status code to display optionally an error message when it receives control following image rundown.
- If the image has declared an exit handler, the status code is written in the address specified in the exit control block.
- If the process was created by another process, and the creator has specified a mailbox to receive a termination message, the status code is written into the termination mailbox when the process is deleted.

#### 4.9.3.3 Performing Cleanup and Rundown Operations

Use exit handlers to perform image-specific cleanup or rundown operations. For example, if an image uses memory to buffer data, an exit handler can ensure that the data is not lost when the image exits as the result of an error condition.

To establish an exit-handling routine, you must set up an exit control block and specify the address of the control block in the call to the `Declare Exit Handler` (`SYS$DCLEXH`) system service. You can call an exit handler by using standard calling conventions; you can provide arguments to the exit handler in the exit control block. The first argument in the control block argument list must specify the address of a longword for the system to write the status code from `SYS$EXIT`.

If an image declares more than one exit handler, the control blocks are linked together on a last-in, first-out (LIFO) basis. After an exit handler is called and returns control, the control block is removed from the list. You can remove exit control blocks prior to image exit by using the `Cancel Exit Handler` (`SYS$CANEXH`) system service.

Exit handlers can be declared from system routines executing in supervisor or executive mode. These exit handlers are also linked together in other lists, and they receive control after exit handlers that are declared from user mode are executed.

Exit handlers are called as a part of the `SYS$EXIT` system service. While a call to the `SYS$EXIT` system service often precedes image rundown activities, the call is not a part of image rundown. There is no way to ensure that exit handlers will be called if an image terminates in a nonstandard way.

To see examples of exit handler programs, refer to Section 9.15.4.

#### 4.9.3.4 Initiating Image Rundown for Another Process

The `Force Exit` (`SYS$FORCEX`) system service provides a way for a process to initiate image rundown for another process. For example, the following call to `SYS$FORCEX` causes the image executing in the process `CYGNUS` to exit:

```
    $DESCRIPTOR(prcnam, "CYGNUS");
    .
    .
    .
    status = SYS$FORCEX(0,          /* pidadr - Process id */
                       &prcnam,   /* prcnam - Process name */
                       0);         /* code - Completion code */
```

## 4.9 Controlling Kernel Threads and Process Execution

Because the `SYS$FORCEX` system service calls the `SYS$EXIT` system service, any exit handlers declared for the image are executed before image rundown. Thus, if the process is using the command interpreter, the process is not deleted and can run another image. Because the `SYS$FORCEX` system service uses the AST mechanism, an exit cannot be performed if the process being forced to exit has disabled the delivery of ASTs. AST delivery and how it is disabled and reenabled is described in Chapter 8.

The `SYS$DCHEXH` system service causes the target process to execute the exit handler. For additional information about exit handlers and examples, see Chapter 9 and Section 9.15.4.

### 4.9.4 Deleting a Process

Process deletion completely removes a process from the system. A process can be deleted by any of the following events:

- The Delete Process (`SYS$DELPRC`) system service is called.
- A process that created a subprocess is deleted.
- An interactive process uses the DCL command `LOGOUT`.
- A batch job reaches the end of its command file.
- An interactive process uses the DCL command `STOP/ID=pid` or `STOP username`.
- A process that contains a single image calls the Exit (`SYS$EXIT`) system service.
- The Force Exit (`SYS$FORCEX`) system service forces image exit on a process that contains a single image.

When the system is called to delete a process as a result of any of these conditions, it first locates all subprocesses, and searches hierarchically. No process can be deleted until all the subprocesses it has created have been deleted.

The lowest subprocess in the hierarchy is a subprocess that has no descendant subprocesses of its own. When that subprocess is deleted, its parent subprocess becomes a subprocess that has no descendant subprocesses and it can be deleted as well. The topmost process in the hierarchy becomes the parent process of all the other subprocesses.

The system performs each of the following procedures, beginning with the lowest process in the hierarchy and ending with the topmost process:

- The image executing in the process is run down. The image rundown that occurs during process deletion is the same as that described in Section 4.9.3.1. When a process is deleted, however, the rundown releases all system resources, including those acquired from access modes other than user mode.
- Resource quotas are released to the creating process, if the process being deleted is a subprocess.
- If the creating process specifies a termination mailbox, a message indicating that the process is being deleted is sent to the mailbox. For detached processes created by the system, the termination message is sent to the system job controller.

## Process Control

### 4.9 Controlling Kernel Threads and Process Execution

- The control region of the process's virtual address space is deleted. (The control region consists of memory allocated and used by the system on behalf of the process.)
- All system-maintained information about the process is deleted.

Figure 4–1 illustrates the flow of events from image exit through process deletion.

Figure 4-1 Image Exit and Process Deletion

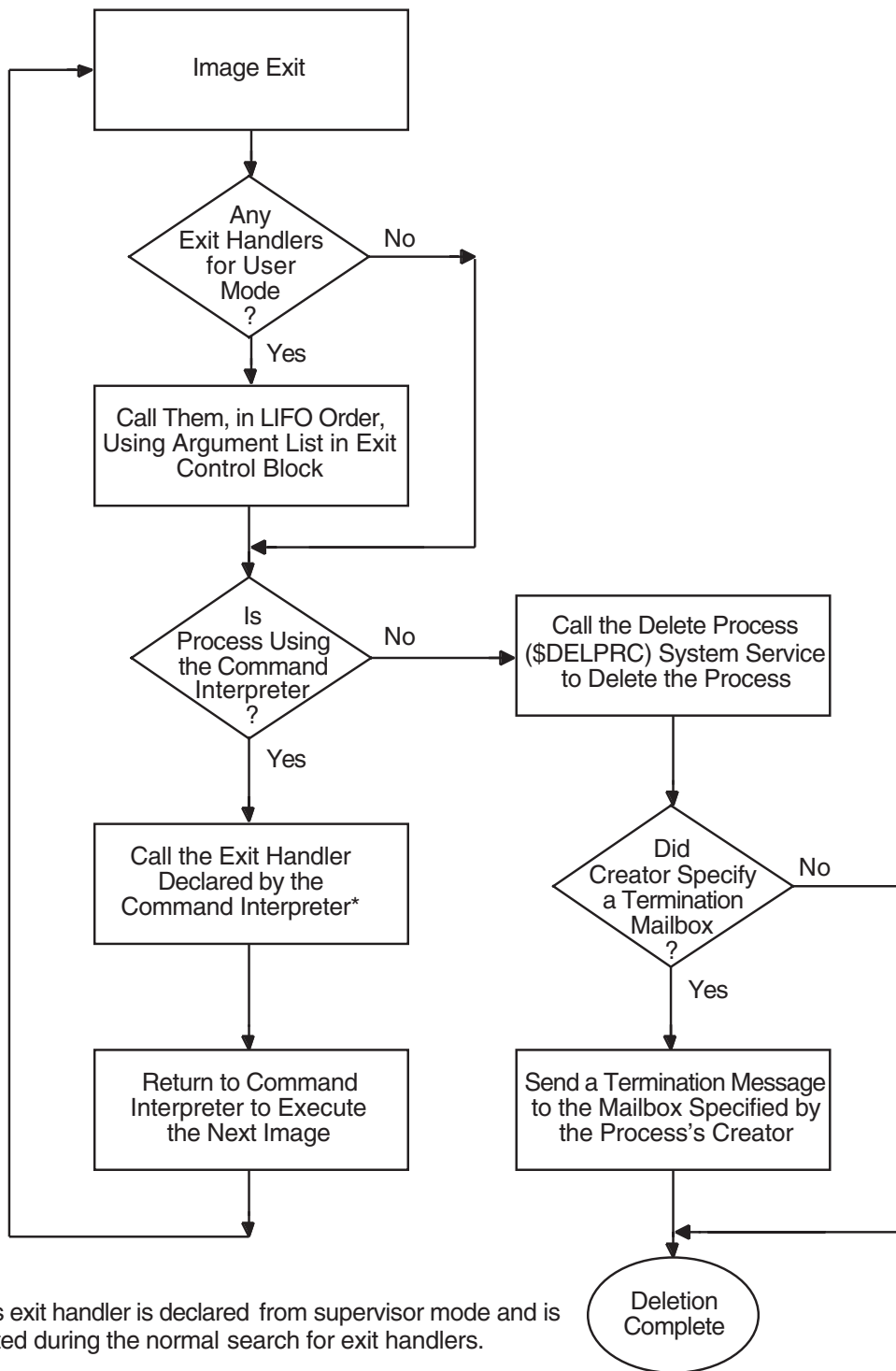

ZK-0857-GE

## Process Control

### 4.9 Controlling Kernel Threads and Process Execution

#### 4.9.4.1 Deleting a Process By Using System Services

A process can delete itself or another process at any time, depending on the restrictions outlined in Section 4.1.1. Any one of the following system services can be used to delete a subprocess or a detached process. Some services terminate execution of the image in the process; others terminate the process itself.

- **SYS\$EXIT**—Initiates normal exit in the current image. Control returns to the command language interpreter. If there is no command language interpreter, the process is terminated. This routine cannot be used to terminate an image in a detached process.
- **SYS\$FORCEX**—Initiates a normal exit on the image in the specified process. **GROUP** or **WORLD** privilege may be required, depending on the process specified. An AST is sent to the specified process. The AST calls on the **SYS\$EXIT** routine to complete the image exit. Because an AST is used, you cannot use this routine on a suspended process. You can use this routine on a subprocess or detached process. See Section 4.9.3.4 for an example.
- **SYS\$DELPRC**—Deletes the specified process. **GROUP** or **WORLD** privilege may be required, depending on the process specified. A termination message is sent to the calling process's mailbox. You can use this routine on a subprocess, a detached process, or the current process. For example, if a process has created a subprocess named **CYGNUS**, it can delete **CYGNUS**, as follows:

```
$_DESCRIPTOR(prcnam,"CYGNUS");
.
.
.
status = SYS$EDLPRC(0,          /* Process id */
                   &prcnam);  /* Process name */
```

Because a subprocess is automatically deleted when the image it is executing terminates (or when the command stream for the command interpreter reaches end of file), you normally do not need to call the **SYS\$DELPRC** system service explicitly.

#### 4.9.4.2 Terminating Mailboxes

A termination mailbox provides a process with a way of determining when, and under what conditions, a process that it has created was deleted. The Create Process (**SYS\$CREPRC**) system service accepts the unit number of a mailbox as an argument. When the process is deleted, the mailbox receives a termination message.

The first word of the termination message contains the symbolic constant, **MSG\$\_DELPROC**, which indicates that it is a termination message. The second longword of the termination message contains the final status value of the image. The remainder of the message contains system accounting information used by the job controller and is identical to the first part of the accounting record sent to the system accounting log file. The description of the **SYS\$CREPRC** system service in the *OpenVMS System Services Reference Manual* provides the complete format of the termination message.

If necessary, the creating process can determine the process identification of the process being deleted from the I/O status block (IOSB) posted when the message is received in the mailbox. The second longword of the IOSB contains the process identification of the process being deleted.

## Process Control

### 4.9 Controlling Kernel Threads and Process Execution

A termination mailbox cannot be located in memory shared by multiple processors.

The following example illustrates a complete sequence of process creation, with a termination mailbox:

```
#include <stdio.h>
#include <descrip.h>
#include <ssdef.h>
#include <msgdef.h>
#include <dvidf.h>
#include <iodef.h>
#include <accdef.h>

unsigned short unitnum;
unsigned int pidadr;

/* Create a buffer to store termination info */
struct accdef exitmsg;

/* Define and initialize the item list for $GETDVI */
static struct {
    unsigned short buflen,item_code;
    void *bufaddr;
    void *retlenaddr;
    unsigned int terminator;
}mbxinfo = { 4, DVI$_UNIT, &unitnum, 0, 0};

/* I/O Status Block for QIO */
struct {
    unsigned short iostat, mblen;
    unsigned int mbpid;
}mbxiosb;

main() {
    void exitast(void);
    unsigned short exchan;
    unsigned int status,maxmsg=84,bufquo=240,promsk=0;
    unsigned int func=IO$_READVBLK;
    $DESCRIPTOR(image,"LYRA");

    /* Create a mailbox */
    status = SYS$CREMBX(0,          /* prmflg (permanent or temporary) */
                      &exchan,    /* channel */
                      maxmsg,     /* maximum message size */
                      bufquo,     /* no. of bytes used for buffer */
                      promsk,     /* protection mask */
                      0,0,0,0);
    if ((status & 1) != 1)
        LIB$SIGNAL( status );

    /* Get the mailbox unit number */
    status = SYS$GETDVI(0,          /* efn - event flag */
                      exchan,     /* chan - channel */
                      0,          /* devnam - device name */
                      &mbxinfo,  /* item list */
                      0,0,0,0);
    if ((status & 1) != 1)
        LIB$SIGNAL( status );
```

## Process Control

### 4.9 Controlling Kernel Threads and Process Execution

```

/* Create a subprocess */
status = SYS$CREPRC(&pidadr, /* process id */
                  &image, /* image to be run */
                  0,0,0,0,0,0,0,0,
                  unitnum, /* mailbox unit number */
                  0); /* options flags */
if ((status & 1) != 1)
    LIB$SIGNAL( status );

/* Read from mailbox */
status = SYS$QIOW(0, /* efn - event flag */ ④
                 exchan, /* chan - channel number */
                 func, /* function modifier */
                 &mbxiosb, /* iosb - I/O status block */
                 &exitast, /* astadr - astadr AST routine */
                 0, /* astprm - astprm AST parameter */
                 &exitmsg, /* p1 - buffer to receive message*/
                 ACC$K_TERMLEN, /* p2 - length of buffer */
                 0,0,0,0); /* p3, p4, p5, p6 */

if ((status & 1) != 1)
    LIB$SIGNAL( status );

}

void exitast(void) {
    if(mbxiosb.iostat == SS$NORMAL) ⑤
    {
        printf("\nMailbox successfully written...");
        if (exitmsg.acc$w_msgtyp == MSG$_DELPROC)
        {
            printf("\nProcess deleted...");
            if (pidadr == mbxiosb.mbpid)
            {
                printf("\nPIDs are equal...");
                if (exitmsg.acc$l_finalsts == SS$NORMAL)
                    printf("\nNormal termination...");
                else
                    printf("\nAbnormal termination status: %d",
                            exitmsg.acc$l_finalsts);
            }
            else
                printf("\nPIDs are not equal");
        }
        else
            printf("\nTermination message not received... status: %d",
                    exitmsg.acc$w_msgtyp);
    }
    else
        printf("\nMailbox I/O status block: %d",mbxiosb.iostat);
    return;
}

```

- ① The item list for the Get Device/Volume Information (SYS\$GETDVI) system service specifies that the unit number of the mailbox is to be returned.
- ② The Create Mailbox and Assign Channel (SYS\$CREMBX) system service creates the mailbox and returns the channel number at EXCHAN.
- ③ The Create Process (SYS\$CREPRC) system service creates a process to execute the image LYRA.EXE and returns the process identification at LYRAPID. The **mbxunt** argument refers to the unit number of the mailbox, obtained from the Get Device/Volume Information (SYS\$GETDVI) system service.



## 4.9 Controlling Kernel Threads and Process Execution

- ④ The Queue I/O Request (SYS\$QIO) system service queues a read request to the mailbox, specifying both an AST service routine to receive control when the mailbox receives a message and the address of a buffer to receive the message. The information in the message can be accessed by the symbolic offsets defined in the \$ACCDEF macro. The process continues executing.
- ⑤ When the mailbox receives a message, the AST service routine EXITAST receives control. Because this mailbox can be used for other interprocess communication, the AST routine does the following:
  - Checks for successful completion of the I/O operation by examining the first word in the IOSB
  - Checks that the message received is a termination message by examining the message type field in the termination message at the offset ACC\$W\_MSGTYPE
  - Checks for the process identification of the process that has been deleted by examining the second longword of the IOSB
  - Checks for the completion status of the process by examining the status field in the termination message at the offset ACC\$L\_FINALSTS

In this example, the AST service routine performs special action when the subprocess is deleted.

The Create Mailbox and Assign Channel (SYS\$CREMBX), Get Device/Volume Information (SYS\$GETDVI), and Queue I/O Request (SYS\$QIO) system services are described in greater detail in Chapter 23.



---

# Symmetric Multiprocessing (SMP) Systems

## 5.1 Introduction to Symmetric Multiprocessing

OpenVMS Alpha supports tightly coupled symmetric multiprocessing (SMP). This chapter presents a brief overview of symmetric multiprocessing terms and characteristics. For more information about SMP concepts and hardware configurations, refer to *VMS for Alpha Platforms Internals and Data Structures*.

A multiprocessing system consists of two or more CPUs that address common memory and that can execute instructions simultaneously. If all CPUs in the system execute the same copy of the operating system, the multiprocessing system is said to be tightly coupled. If all CPUs have equal access to memory, interrupts, and I/O devices, the system is said to be symmetric.

In most respects the members of an OpenVMS SMP system are symmetric. Each member can perform the following tasks:

- Initiate an I/O request
- Service exceptions
- Service software interrupts
- Service hardware interrupts, such as interprocessor and interval timer interrupts
- Execute process context code in any access mode

## 5.2 CPU Characteristics of an SMP System

The members of an SMP system are characterized in several ways. One important characteristic is that of primary CPU. During system operation the primary CPU has several unique responsibilities for system timekeeping, writing messages to the console terminal, and accessing any other I/O devices that are not accessible to all members. Although the hardware and software permit device interrupts to be serviced by any processor, in practice all device interrupts are serviced on the primary CPU. An SMP configuration may include some devices that are not accessible from all SMP members. The console terminal, for example, is accessible only from the primary processor.

### 5.2.1 Booting an SMP System

Booting the system is initiated on a CPU with full access to the console subsystem and terminal, called the BOOT CPU. The BOOT CPU controls the bootstrap sequence and boots the other available CPUs. On OpenVMS Alpha systems, the BOOT CPU and the primary CPU are always the same; the others are called secondary processors.

## Symmetric Multiprocessing (SMP) Systems

### 5.2 CPU Characteristics of an SMP System

The booted primary and all currently booted secondary processors are called members of the active set. These processors actively participate in system operations and respond to interprocessor interrupts, which coordinate systemwide events.

#### 5.2.2 Interrupt Requests on SMP System

In an SMP system, each processor services its own software interrupt requests, of which the most significant are the following:

- When a current Kernel thread is preempted by a higher priority computable resident thread, the IPL 3 rescheduling interrupt service routine, running on that processor, takes the current thread out of execution and switches to the higher priority Kernel thread.
- When a device driver completes an I/O request, an IPL 4 I/O postprocessing interrupt is requested: some completed requests are queued to a CPU-specific postprocessing queue and are serviced on that CPU; others are queued to a systemwide queue and serviced on the primary CPU.
- When the current Kernel thread has used its quantum of CPU time, the software timer interrupt service routine, running on that CPU, performs quantum-end processing.
- Software interrupts at IPLs 6 and 8 through 11 are requested to execute fork processes. Each processor services its own set of fork queues. A fork process generally executes on the same CPU from which it was requested. However, since many fork processes are requested from device interrupt service routines, which currently execute only on the primary CPU, more fork processes execute on the primary than on other processors.

### 5.3 Symmetric Multiprocessing Goals

SMP supports the following goals:

- One version of the operating system. As part of the standard OpenVMS Alpha product, SMP support does not require its own version. The same OpenVMS version runs on all Alpha processors. The synchronization methodology and the interface to synchronization routines are the same on all systems. However, as described in *VMS for Alpha Platforms Internals and Data Structures*, there are different versions of the synchronization routines themselves in different versions of the executive image that implement synchronization. Partly for that reason, SMP support imposes relatively little additional overhead on a uniprocessor system.
- Parallelism in kernel mode. SMP support might have been implemented such that any single processor, but not more than one at a time, could execute kernel mode code. However, more parallelism was required for a solution that would support configurations with more CPUs. The members of an SMP system can be executing different portions of the Executive concurrently.

The executive has been divided into different critical regions, each with its own lock, called a spinlock. A spinlock is one type of system synchronization element that guarantees atomic access to the functional divisions of the Executive using Alpha architecture instructions specifically designed for multi-processor configurations. Two sections in Chapter 6, Section 6.4 and Section 6.5 describe both the underlying architecture and software elements that provide this level of SMP synchronization.

## Symmetric Multiprocessing (SMP) Systems

### 5.3 Symmetric Multiprocessing Goals

The spinlock is the heart of the SMP model, allowing system concurrency at all levels of the operating system. All components that want to benefit from multiple-CPU configurations must incorporate these elements to guarantee consistency and correctness. Device drivers, in particular, use a variant of the static system spinlock (a devicelock) to ensure its own degree of synchronization and ownership within the system.

- Symmetric scheduling mechanisms. The standard, default behavior of the operating system is to impose as little binding between system executable entities and specific CPUs in the active set as possible. That is, in general, each CPU is equally able to execute any Kernel thread. The multi-processor scheduling algorithm is an extension of the single-CPU behavior, providing consistent preemption and real-time behavior in all cases.

However, there are circumstances when an executable Kernel thread needs system resources and services possessed only by certain CPUs in the configuration. In those non-symmetric cases, OpenVMS provides a series of privileged, system-level CPU scheduling routines that supersedes the standard scheduling mechanisms and binds a Kernel thread to one or more specific CPUs. System components that are tied to the primary CPU, such as system timekeeping and console processing, use these mechanisms to guarantee that their functions are performed in the correct context. Also, because the Alpha hardware architecture shows significant performance benefits for Kernel threads run on CPUs where the hardware context has been preserved from earlier execution, the CPU scheduling mechanisms have been introduced in OpenVMS Alpha Version 7.0 as a series of system services and user commands. Through the use of explicit CPU affinity and user capabilities, an application can be placed throughout the active set to take advantage of the hardware context. Chapter 4 in Section 4.4 describes these features in greater detail.



---

# Synchronizing Data Access and Program Operations

This chapter describes the operating system's synchronization features. It focuses on how the operating system synchronizes the sequencing of events to perform memory operations. Memory access synchronization techniques are based on synchronization techniques that other types of storage use, whether to share hardware resources or data in files.

This chapter contains the following sections:

Section 6.1 describes synchronization, execution of threads, and atomicity.

Section 6.2 describes alignment, granularity, ordering of read and write operations, and performance of memory read and write operations on VAX and Alpha systems in uniprocessor and multiprocessor environments.

Section 6.3 describes how to perform memory read-modify-write operations on VAX and Alpha systems in uniprocessor and multiprocessor environments.

Section 6.4 describes hardware-level synchronization methods, such as interrupt priority level, load-locked/store-conditional and interlocked instructions, memory barriers, and PALcode routines.

Section 6.5 describes software-level synchronization methods, such as process-private synchronization techniques, process priority, and spin locks. It also describes how to write applications for a multiprocessor environment using higher-level synchronization methods and how to write to global sections.

Section 6.6 describes how to use local and common event flags for synchronization.

Section 6.7 describes how to use SYS\$SYNCH system service for synchronization.

## 6.1 Overview of Synchronization

Software synchronization refers to the coordination of events in such a way that only one event happens at a time. This kind of synchronization is a serialization or sequencing of events. Serialized events are assigned an order and processed one at a time in that order. While a serialized event is being processed, no other event in the series is allowed to disrupt it.

By imposing order on events, synchronization allows reading and writing of several data items indivisibly, or atomically, in order to obtain a consistent set of data. For example, all of process A's writes to shared data must happen before or after process B's writes or reads, but not during process B's writes or reads. In this case, all of process A's writes must happen indivisibly for the operation to be correct. This includes process A's updates—reading of a data item, modifying it, and writing it back (read-modify-write sequence). Other synchronization

## Synchronizing Data Access and Program Operations

### 6.1 Overview of Synchronization

techniques are used to ensure the completion of an asynchronous system service before the caller tries to use the results of the service.

#### 6.1.1 Threads of Execution

Code threads that can execute within a process include the following:

- Mainline code in an image being executed by a kernel thread, or multiple threads
- Asynchronous system traps (ASTs) that interrupt the image
- Condition handlers established by the image and that run after exceptions occur
- Inner access-mode threads of execution that run as a result of system service, OpenVMS Record Management Services (RMS), and command language interpreter (CLI) callback requests

Process-based threads of execution can share any data in the P0 and P1 address space and must synchronize access to any data they share. A thread of execution can incur an exception, which results in passing of control to a condition handler. Alternatively, the thread can receive an AST, which results in passing of control to an AST procedure. Further, an AST procedure can incur an exception, and a condition handler's execution can be interrupted by an AST delivery. If a thread of execution requests a system service or RMS service, control passes to an inner access-mode thread of execution. Code that executes in the inner mode can also incur exceptions, receive ASTs, and request services.

Multiple processes, each with its own set of threads of execution, can execute concurrently. Although each process has private P0 and P1 address space, processes can share data in a global section mapped into each process's address spaces. You need to synchronize access to global section data because a thread of execution accessing the data in one process can be rescheduled, allowing a thread of execution in another process to access the same data before the first process completes its work. Although processes access the same system address space, the protection on system space pages usually prevents outer mode access. However, process-based code threads running in inner access modes can access data concurrently in system space and must synchronize access to it.

Interrupt service routines access only system space. They must synchronize access to shared system space data among themselves and with process-based threads of execution.

A CPU-based thread of execution and an I/O processor must synchronize access to shared data structures, such as structures that contain descriptions of I/O operations to be performed.

Multiprocessor execution increases synchronization requirements when the threads that must synchronize can run concurrently on different processors. Because a process executes on only one processor at a time, synchronization of threads of execution within a process is unaffected by whether the process runs on a uniprocessor or on a symmetric multiprocessing (SMP) system. However, multiple processes can execute simultaneously on different processors. Because of this, processes sharing data in a global section can require additional synchronization for SMP system execution. Further, process-based inner mode and interrupt-based threads can execute simultaneously on different processors and can require synchronization of access to system space beyond what is sufficient on a uniprocessor.



### 6.1.2 Atomicity

**Atomicity** is a type of serialization that refers to the indivisibility of a small number of actions, such as those occurring during the execution of a single instruction or a small number of instructions. With more than one action, no single action can occur by itself. If one action occurs, then all the actions occur. Atomicity must be qualified by the viewpoint from which the actions appear indivisible: an operation that is atomic for threads running on the same processor can appear as multiple actions to a thread of execution running on a different processor.

An atomic memory reference results in one indivisible read or write of a data item in memory. No other access to any part of that data can occur during the course of the atomic reference. Atomic memory references are important for synchronizing access to a data item that is shared by multiple writers or by one writer and multiple readers. References need not be atomic to a data item that is not shared or to one that is shared but is only read.

## 6.2 Memory Read and Memory Write Operations

This section presents the important concepts of **alignment** and **granularity** and how they affect the access of shared data on VAX and Alpha systems. It also discusses the importance of the order of reads and writes completed on VAX and Alpha systems, and how VAX and Alpha systems perform memory reads and writes.

### 6.2.1 Alignment

The term **alignment** refers to the placement of a data item in memory. For a data item to be naturally aligned, its lowest-addressed byte must reside at an address that is a multiple of the size of the data item in bytes. For example, a naturally aligned longword has an address that is a multiple of 4. The term **naturally aligned** is usually shortened to “aligned.”

On VAX systems, a thread on a VAX uniprocessor or multiprocessor can read and write aligned byte, word, and longword data atomically with respect to other threads of execution accessing the same data.

On Alpha systems, in contrast to the variety of memory accesses allowed on VAX systems, an Alpha processor allows atomic access only to an aligned longword or an aligned quadword. Reading or writing an aligned longword or quadword of memory is atomic with respect to any other thread of execution on the same processor or on other processors.

### 6.2.2 Granularity

VAX and Alpha systems differ in granularity of data access. The phrase **granularity of data access** refers to the size of neighboring units of memory that can be written independently and atomically by multiple processors. Regardless of the order in which the two units are written, the results must be identical.

VAX systems have byte granularity: individual adjacent or neighboring bytes within the same longword can be written by multiple threads of execution on one or more processors, as can aligned words and longwords.

VAX systems provide instructions that can manipulate byte-sized and aligned word-sized memory data in a single, noninterruptible operation. On VAX systems, a byte-sized or word-sized data item that is shared can be manipulated individually.

## Synchronizing Data Access and Program Operations

### 6.2 Memory Read and Memory Write Operations

Alpha systems have longword and quadword granularity. That is, only adjacent aligned longwords or quadwords can be written independently. Because Alpha systems support only instructions that load or store longword-sized and quadword-sized memory data, the manipulation of byte-sized and word-sized data on Alpha systems requires that the entire longword or quadword contain the byte- or word-sized item to be manipulated. Thus, simply because of its proximity to an explicitly shared data item, neighboring data might become shared unintentionally. Manipulation of byte-sized and word-sized data on Alpha systems requires multiple instructions that:

1. Fetch the longword or quadword that contains the byte or word
2. Mask the nontargeted bytes
3. Manipulate the target byte or word
4. Store the entire longword or quadword

On Alpha systems, because this sequence is interruptible, operations on byte and word data are not atomic. Also, this change in the granularity of memory access can affect the determination of which data is actually shared when a byte or word is accessed.

On Alpha systems, the absence of byte and word granularity has important implications for access to shared data. In effect, any memory write of a data item other than an aligned longword or quadword must be done as a multiple-instruction read-modify-write sequence. Also, because the amount of data read and written is an entire longword or quadword, programmers must ensure that all accesses to fields within the longword or quadword are synchronized with each other.

#### 6.2.3 Ordering of Read and Write Operations

On VAX uniprocessor and multiprocessor systems, write operations and read operations appear to occur in the same order in which you specify them from the viewpoint of all types of external threads of execution. Alpha uniprocessor systems also guarantee that read and write operations appear ordered for multiple threads of execution running within a single process or within multiple processes running on a uniprocessor.

On Alpha multiprocessor systems, you must order reads and writes explicitly to ensure that they occur in a specific order from the viewpoint of threads of execution on other processors. To provide the necessary operating system primitives and compatibility with VAX systems, Alpha systems support instructions that impose an order on read and write operations.

#### 6.2.4 Memory Reads and Memory Writes

On VAX systems, most instructions that read or write memory are noninterruptible. A memory write done with a noninterruptible instruction is atomic from the viewpoint of other threads on the same CPU.

On VAX systems, on a uniprocessor system, reads and writes of bytes, words, longwords, and quadwords are atomic with respect to any thread on the processor. On a multiprocessor, not all of those accesses are atomic with respect to any thread on any processor; only reads and writes of bytes, aligned words, and aligned longwords are atomic. Accessing unaligned data can require multiple operations. As a result, even though an unaligned longword is written with a noninterruptible instruction, if it requires multiple memory accesses, a thread on

## Synchronizing Data Access and Program Operations

### 6.2 Memory Read and Memory Write Operations

another CPU might see memory in an intermediate state. VAX systems do not guarantee multiprocessor atomic access to quadwords.

On Alpha systems, there is no instruction that performs multiple memory accesses. Each load or store instruction performs a maximum of one load from or one store to memory. A load can occur only from an aligned longword or quadword. A store can occur only to an aligned longword or quadword.

On Alpha systems, although reads and writes from one thread appear to occur ordered from the viewpoint of other threads on the same processor, there is no implicit ordering of reads and writes as seen by threads on other processors.

### 6.3 Memory Read-Modify-Write Operations

A fundamental synchronization primitive for accessing shared data is an atomic read-modify-write operation. This operation consists of reading the contents of a memory location and replacing them with new contents based on the old. Any intermediate memory state is not visible to other threads. Both VAX systems and Alpha systems provide this synchronization primitive, but they implement it in significantly different ways.

#### 6.3.1 Uniprocessor Operations

On VAX systems, many instructions are capable of performing a read-modify-write operation in a single, noninterruptible (atomic) sequence from the viewpoint of multiple application threads executing on a single processor. VAX systems provide synchronization among multiple threads of execution running on a uniprocessor system.

On VAX systems, the implicit dependence on the atomicity of VAX instructions is not recommended. Because of the optimizations they perform, the VAX compilers do not guarantee that a certain type of program statement, such as an increment operation ( $x=x+1$ ), is implemented using a VAX atomic instruction, even if one exists.

On Alpha systems, there is no single instruction that performs an atomic read-modify-write operation. As a result, even uniprocessing applications in which processes access shared data must provide explicit synchronization of these accesses, usually through compiler semantics.

On Alpha systems, read-modify-write operations that can be performed atomically on VAX systems require a sequence of instructions on Alpha systems. Because this sequence can be interrupted, the data may be left in an unstable state. For example, the VAX increment long (INCL) instruction fetches the contents of a specified longword, increments its value, and stores the value back in the longword, performing the operations without interruption. On Alpha systems, each step—fetching, incrementing, storing—must be explicitly performed by a separate instruction. Therefore, another thread in the process (for example, an AST routine) could execute before the sequence completes. However, because atomic updates are the basis of synchronization, and to provide compatibility with VAX systems, Alpha systems provide the following mechanisms to enable atomic read-modify-write updates:

- Privileged architecture library (PALcode) routines perform queue insertions and removals.

## Synchronizing Data Access and Program Operations

### 6.3 Memory Read-Modify-Write Operations

- Load-locked and store-conditional instructions create a sequence of instructions that implement an atomic update.

---

#### Note

---

The load-locked and store-conditional instructions also create a sequence of instructions that are atomic in a multiprocessor system. In contrast, a VAX INCL instruction is atomic only in a uniprocessor environment.

---

#### 6.3.2 Multiprocessor Operations

On multiprocessor systems, you must use special methods to ensure that a read-modify-write sequence is atomic. On VAX systems, interlocked instructions provide synchronization; on Alpha systems, load-locked and store-conditional instructions provide synchronization.

On VAX systems, a number of uninterruptible instructions are provided that both read and write memory with one instruction. When used with an operand type that is accessible in a single memory operation, each instruction provides an atomic read-modify-write sequence. The sequence is atomic with respect to threads of execution on the same VAX processor, but it is not atomic to threads on other processors. For instance, when a VAX CPU executes the instruction INCL *x*, it issues two separate commands to memory: a read, followed by a write of the incremented value. Another thread of execution running concurrently on another processor could issue a command to memory that reads or writes location *x* between the INCL's read and write. Section 6.4.4 describes read-modify-write sequences that are atomic with respect to threads on all VAX CPUs in an SMP system.

On a VAX multiprocessor system, an atomic update requires an interlock at the level of the memory subsystem. To perform that interlock, the VAX architecture provides a set of interlocked instructions that include Add Aligned Word Interlocked (ADAWI), Remove from Queue Head Interlocked (REMQHI), and Branch on Bit Set and Set Interlocked (BBSSI).

If you code in VAX MACRO, you use the assembler to generate whatever instructions you tell it. If you code in a high-level language, you cannot assume that the compiler will compile a particular language statement into a specific code sequence. That is, you must tell the compiler explicitly to generate an atomic update. For further information, see the documentation for your high-level language.

On Alpha systems, there is no single instruction that performs an atomic read-modify-write operation. An atomic read-modify-write operation is only possible through a sequence that includes load-locked and store-conditional instructions, (see Section 6.4.2). Use of these instructions provides a read-modify-write operation on data within one aligned longword or quadword that is atomic with respect to threads on all Alpha CPUs in an SMP system.

## 6.4 Hardware-Level Synchronization

On VAX systems, the following features assist with synchronization at the hardware level:

- Atomic memory references
- Noninterruptible instructions
- Interrupt priority level (IPL)
- Interlocked memory accesses

On VAX systems, many read-modify-write instructions, including queue manipulation instructions, are noninterruptible. These instructions provide an atomic update capability on a uniprocessor. A kernel-mode code thread can block interrupt and process-based threads of execution by raising the IPL. Hence, it can execute a sequence of instructions atomically with respect to the blocked threads on a uniprocessor. Threads of execution that run on multiple processors of an SMP system synchronize access to shared data with read-modify-write instructions that interlock memory.

On Alpha systems, some of these mechanisms are present, while others have been implemented in PALcode routines.

Alpha processors provide several features to assist with synchronization. Even though all instructions that access memory are noninterruptible, no single one performs an atomic read-modify-write. A kernel-mode thread of execution can raise the IPL in order to block other threads on that processor while it performs a read-modify-write sequence or while it executes any other group of instructions. Code that runs in any access mode can execute a sequence of instructions that contains load-locked (LDx\_L) and store-conditional (STx\_C) instructions to perform a read-modify-write sequence that appears atomic to other threads of execution. Memory barrier instructions order a CPU's memory reads and writes from the viewpoint of other CPUs and I/O processors. Other synchronization mechanisms are provided by PALcode routines.

The sections that follow describe the features of interrupt priority level, load-locked (LDx\_L) and store-conditional (STx\_C) instructions, memory barriers, interlocked instructions, and PALcode routines.

### 6.4.1 Interrupt Priority Level

The operating system in a uniprocessor system synchronizes access to systemwide data structures by requiring that all threads sharing data run at the highest-priority IPL of the highest-priority interrupt that causes any of them to execute. Thus, a thread's accessing of data cannot be interrupted by any other thread that accesses the same data.

The IPL is a processor-specific mechanism. Raising the IPL on one processor has no effect on another processor. You must use a different synchronization technique on SMP systems where code threads run concurrently on different CPUs that must have synchronized access to shared system data.

On VAX systems, the code threads that run concurrently on different processors synchronize through instructions that interlock memory in addition to raising the IPL. Memory interlocks also synchronize access to data shared by an I/O processor and a code thread.

## Synchronizing Data Access and Program Operations

### 6.4 Hardware-Level Synchronization

On Alpha systems, access to a data structure that is shared either by executive code running concurrently on different CPUs or by an I/O processor and a code thread must be synchronized through a load-locked/store-conditional sequence.

#### 6.4.2 LD<sub>x</sub>\_L and ST<sub>x</sub>\_C Instructions (Alpha Only)

Because Alpha systems do not provide a single instruction that both reads and writes memory or mechanism to interlock memory against other interlocked accesses, you must use other synchronization techniques. Alpha systems provide the load-locked/store-conditional mechanism that allows a sequence of instructions to perform an atomic read-modify-write operation.

Load-locked (LD<sub>x</sub>\_L) and store-conditional (ST<sub>x</sub>\_C) instructions guarantee atomicity that is functionally equivalent to that of VAX systems. The LD<sub>x</sub>\_L and ST<sub>x</sub>\_C instructions can be used only on aligned longwords or aligned quadwords. The LD<sub>x</sub>\_L and ST<sub>x</sub>\_C instructions do not provide atomicity by blocking access to shared data by competing threads. Instead, when the LD<sub>x</sub>\_L instruction executes, a CPU-specific lock bit is set. Before the data can be stored, the CPU uses the ST<sub>x</sub>\_C instruction to check the lock bit. If another thread has accessed the data item in the time since the load operation began, the lock bit is cleared and the store is not performed. Clearing the lock bit signals the code thread to retry the load operation. That is, a load-locked/store-conditional sequence tests the lock bit to see whether the store succeeded. If it did not succeed, the sequence branches back to the beginning to start over. This loop repeats until the data is untouched by other threads during the operation.

By using the LD<sub>x</sub>\_L and ST<sub>x</sub>\_C instructions together, you can construct a code sequence that performs an atomic read-modify-write operation to an aligned longword or quadword. Rather than blocking other threads' modifications of the target memory, the code sequence determines whether the memory locked by the LD<sub>x</sub>\_L instruction could have been written by another thread during the sequence. If it is written, the sequence is repeated. If it is not written, the store is performed. If the store succeeds, the sequence is atomic with respect to other threads on the same processor and on other processors. The LD<sub>x</sub>\_L and ST<sub>x</sub>\_C instructions can execute in any access mode.

Traditional VAX usage is for interlocked instructions to be used for multiprocessor synchronization. On Alpha systems, LD<sub>x</sub>\_L and ST<sub>x</sub>\_C instructions implement interlocks and can be used for uniprocessor synchronization. To achieve protection similar to the VAX interlock protection, you need to use memory barriers along with the load-locked and store-conditional instructions.

Some Alpha system compilers make the LD<sub>x</sub>\_L and ST<sub>x</sub>\_C instruction mechanism available as language built-in functions. For example, Compaq C on Alpha systems includes a set of built-in functions that provides for atomic addition and for logical AND and OR operations. Also, Alpha system compilers make the mechanism available implicitly, because they use the LD<sub>x</sub>\_L and ST<sub>x</sub>\_C instructions to access declared data as requiring atomic accesses in a language-specific way.

### 6.4.3 Using Interlocked Memory Instructions (Alpha Only)

The *Alpha Architecture Reference Manual, Third Edition* (AARM) describes strict rules for using interlocked memory instructions. The new Alpha 21264 (EV6) processor and all future Alpha processors are more stringent than their predecessors in their requirement that these rules be followed. As a result, code that has worked in the past, despite noncompliance, could fail when executed on systems featuring the new 21264 processor. **Occurrences of these noncompliant code sequences are believed to be rare.** Note that the 21264 processor is not supported on versions prior to OpenVMS Alpha Version 7.1–2.

Noncompliant code can result in a loss of synchronization between processors when interprocessor locks are used, or can result in an infinite loop when an interlocked sequence always fails. Such behavior has occurred in some code sequences in programs compiled on old versions of the BLISS compiler, some versions of the MACRO–32 compiler and the MACRO–64 assembler, and in some Compaq C and Compaq C++ programs.

For recommended compiler versions, see Section 6.4.3.5.

The affected code sequences use LDx\_L/STx\_C instructions, either directly in assembly language sources or in code generated by a compiler. Applications most likely to use interlocked instructions are complex, multithreaded applications or device drivers using highly optimized, hand-crafted locking and synchronization techniques.

#### 6.4.3.1 Required Code Checks

OpenVMS recommends that code that will run on the 21264 processor be checked for these sequences. Particular attention should be paid to any code that does interprocess locking, multithreading, or interprocessor communication.

The SRM\_CHECK tool (named after the *System Reference Manual*, which defines the Alpha architecture) has been developed to analyze Alpha executables for noncompliant code sequences. The tool detects sequences that might fail, reports any errors, and displays the machine code of the failing sequence.

#### 6.4.3.2 Using the Code Analysis Tool

The SRM\_CHECK tool can be found in the following location on the OpenVMS Alpha Version 7.2 Operating System CD-ROM:

```
SYS$SYSTEM:SRM_CHECK.EXE
```

To run the SRM\_CHECK tool, define it as a foreign command (or use the DCL\$PATH mechanism) and invoke it with the name of the image to check. If a problem is found, the machine code is displayed and some image information is printed. The following example illustrates how to use the tool to analyze an image called myimage.exe:

```
$ define DCL$PATH []  
$ srm_check myimage.exe
```

The tool supports wildcard searches. Use the following command line to initiate a wildcard search:

```
$ srm_check [*...]* -log
```

## Synchronizing Data Access and Program Operations

### 6.4 Hardware-Level Synchronization

Use the `-log` qualifier to generate a list of images that have been checked. You can use the `-output` qualifier to write the output to a data file. For example, the following command directs output to a file named `CHECK.DAT`:

```
$ srm_check 'file' -output check.dat
```

You can use the output from the tool to find the module that generated the sequence by looking in the image's MAP file. The addresses shown correspond directly to the addresses that can be found in the MAP file.

The following example illustrates the output from using the analysis tool on an image named `SYSTEM_SYNCHRONIZATION.EXE`:

```
** Potential Alpha Architecture Violation(s) found in file...
** Found an unexpected ldq at 00003618
0000360C  AD970130      ldq_l          R12, 0x130(R23)
00003610  4596000A      and           R12, R22, R10
00003614  F5400006      bne          R10, 00003630
00003618  A54B0000      ldq          R10, (R11)
Image Name:   SYSTEM_SYNCHRONIZATION
Image Ident:  X-3
Link Time:    5-NOV-1998 22:55:58.10
Build Ident:  X6P7-SSB-0000
Header Size:  584
Image Section: 0, vbn: 3, va: 0x0, flags: RESIDENT EXE (0x880)
```

The MAP file for `system_synchronization.exe` contains the following:

```
EXEC$NONPAGED_CODE      00000000 0000B317 0000B318 (    45848.) 2 ** 5
SMPROUT                  00000000 000047BB 000047BC (    18364.) 2 ** 5
SMPINITIAL               000047C0 000061E7 00001A28 (    6696.) 2 ** 5
```

The address 360C is in the `SMPROUT` module, which contains the addresses from 0-47BB. By looking at the machine code output from the module, you can locate the code and use the listing line number to identify the corresponding source code. If `SMPROUT` had a nonzero base, it would be necessary to subtract the base from the address (360C in this case) to find the relative address in the listing file.

Note that the tool reports *potential* violations in its output. Although `SRM_CHECK` can normally identify a code section in an image by the section's attributes, it is possible for OpenVMS images to contain data sections with those same attributes. As a result, `SRM_CHECK` may scan data as if it were code, and occasionally, a block of data may look like a noncompliant code sequence. This circumstance is rare and can be detected by examining the MAP and listing files.

#### 6.4.3.3 Characteristics of Noncompliant Code

The areas of noncompliance detected by the `SRM_CHECK` tool can be grouped into the following four categories. Most of these can be fixed by recompiling with new compilers. In rare cases, the source code may need to be modified. See Section 6.4.3.5 for information about compiler versions.

- Some versions of OpenVMS compilers introduce noncompliant code sequences during an optimization called "loop rotation." This problem can only be triggered in C or C++ programs that use `LDx_L/STx_C` instructions in assembly language code that is embedded in the C/C++ source using the `ASM` function, or in assembly language written in `MACRO-32` or `MACRO-64`. In some cases, a branch was introduced between the `LDx_L` and `STx_C` instructions.

This can be addressed by recompiling.



## Synchronizing Data Access and Program Operations

### 6.4 Hardware-Level Synchronization

- Some code compiled with very old BLISS, MACRO-32, or DEC Pascal compilers may contain noncompliant sequences. Early versions of these compilers contained a code scheduling bug where a load was incorrectly scheduled after a load\_locked.

This can be addressed by recompiling.

- In rare cases, the MACRO-32 compiler may generate a noncompliant code sequence for a BBSSI or BBCCI instruction where there are too few free registers.

This can be addressed by recompiling.

- Errors may be generated by incorrectly coded MACRO-64 or MACRO-32 and incorrectly coded assembly language embedded in C or C++ source using the ASM function.

This requires source code changes. The new MACRO-32 compiler flags noncompliant code at compile time.

If the SRM\_CHECK tool finds a violation in an image, the image should be recompiled with the appropriate compiler (see Section 6.4.3.5). After recompiling, the image should be analyzed again. If violations remain after recompiling, the source code must be examined to determine why the code scheduling violation exists. Modifications should then be made to the source code.

#### 6.4.3.4 Coding Requirements

The *Alpha Architecture Reference Manual* describes how an atomic update of data between processors must be formed. The Third Edition, in particular, has much more information on this topic.

Exceptions to the following two requirements are the source of all known noncompliant code:

- There cannot be a memory operation (load or store) between the LDx\_L (load locked) and STx\_C (store conditional) instructions in an interlocked sequence.
- There cannot be a branch taken between an LDx\_L and an STx\_C instruction. Rather, execution must "fall through" from the LDx\_L to the STx\_C without taking a branch.

Any branch whose target is between an LDx\_L and matching STx\_C creates a noncompliant sequence. For instance, any branch to "label" in the following example would result in noncompliant code, regardless of whether the branch instruction itself was within or outside of the sequence:

```
LDx_L Rx, n(Ry)
...
label: ...
STx_C Rx, n(Ry)
```

Therefore, the SRM\_CHECK tool looks for the following:

- Any memory operation (LDx/STx) between an LDx\_L and an STx\_C
- Any branch that has a destination between an LDx\_L and an STx\_C
- STx\_C instructions that do not have a preceding LDx\_L instruction

This typically indicates that a backward branch is taken from an LDx\_L to the STx\_C. Note that hardware device drivers that do device mailbox writes are an exception. These drivers use the STx\_C to write the mailbox. This condition is found only on early Alpha systems and not on PCI based systems.

## Synchronizing Data Access and Program Operations

### 6.4 Hardware-Level Synchronization

- Excessive instructions between an LD<sub>x</sub>\_L and an ST<sub>x</sub>C

The AARM recommends that no more than 40 instructions appear between an LD<sub>x</sub>\_l and an ST<sub>x</sub>\_c. In theory, more than 40 instructions can cause hardware interrupts to keep the sequence from completing. However, there are no known occurrences of this.

To illustrate, the following are examples of code flagged by SRM\_CHECK.

```
** Found an unexpected ldq at 0008291C
00082914 AC300000 ldq_l      R1, (R16)
00082918 2284FFEC lda       R20, 0xFFEC(R4)
0008291C A6A20038 ldq       R21, 0x38(R2)
```

In the above example, an LDQ instruction was found after an LDQ\_L before the matching STQ\_C. The LDQ must be moved out of the sequence, either by recompiling or by source code changes. (See Section 6.4.3.3.)

```
** Backward branch from 000405B0 to a STx C sequence at 0004059C
00040598 C3E00003 br        R31, 000405A8
0004059C 47F20400 bis       R31, R18, R0
000405A0 B8100000 stl_c     R0, (R16)
000405A4 F4000003 bne_     R0, 000405B4
000405A8 A8300000 ldl_l    R1, (R16)
000405AC 40310DA0 cmp_l_e  R1, R17, R0
000405B0 F41FFFFA bne      R0, 0004059C
```

In the above example, a branch was discovered between the LDL\_L and STL\_C. In this case, there is no "fall through" path between the LD<sub>x</sub>\_L and ST<sub>x</sub>\_C, which the architecture requires.

---

#### Note

---

This branch backward from the LD<sub>x</sub>\_L to the ST<sub>x</sub>\_C is characteristic of the noncompliant code introduced by the "loop rotation" optimization.

---

The following MACRO-32 source code demonstrates code where there is a "fall through" path, but this case is still noncompliant because of the potential branch and a memory reference in the lock sequence.

```
getlck: evax_ldql  r0, lockdata(r8) ; Get the lock data
        movl_     index, r2        ; and the current index.
        tstl     r0                ; If the lock is zero,
        beql    is_clear          ; skip ahead to store.
        movl    r3, r2            ; Else, set special index.
is_clear:
        incl     r0                ; Increment lock count
        evax_stqc r0, lockdata(r8) ; and store it.
        tstl     r0                ; Did store succeed?
        beql    getlck            ; Retry if not.
```

To correct this code, the memory access to read the value of INDEX must first be moved outside the LDQ\_L/STQ\_C sequence. Next, the branch between the LDQ\_L and STQ\_C, to the label IS\_CLEAR, must be eliminated. In this case, it could be done using a CMOVEQ instruction. The CMOV<sub>xx</sub> instructions are frequently useful for eliminating branches around simple value moves. The following example shows the corrected code:

## Synchronizing Data Access and Program Operations

### 6.4 Hardware-Level Synchronization

```

movl      index, r2      ; Get the current index
getlck:  evax_ldql  r0, lockdata(r8) ; and then the lock data.
         evax_cmoveq r0, r3, r2    ; If zero, use special index.
         incl      r0              ; Increment lock count
         evax_stqc  r0, lockdata(r8) ; and store it.
         tstl      r0              ; Did write succeed?
         beql      getlck          ; Retry if not.

```

#### 6.4.3.5 Compiler Versions

This section contains information about versions of compilers that may generate noncompliant code sequences and the recommended versions to use when recompiling.

Table 6–1 contains information for OpenVMS compilers.

**Table 6–1 OpenVMS Compilers**

Old Version	Recommended Minimum Version
BLISS V1.1	BLISS V1.3
DEC C V5.x	Compaq C V6.0
DEC C++ V5.x	Compaq C++ V6.0
DEC Pascal V5.0-2	Compaq Pascal V5.1-11
MACRO–32 V3.0	V3.1 for OpenVMS Version 7.1–2 V4.1 for OpenVMS Version 7.2
MACRO–64 V1.2	See below.

Current versions of the MACRO–64 assembler may still encounter the loop rotation issue. However, MACRO–64 does not perform code optimization by default, and this problem occurs only when optimization is enabled. If SRM\_CHECK indicates a noncompliant sequence in the MACRO–64 code, it should first be recompiled without optimization. If the sequence is still flagged when retested, the source code itself contains a noncompliant sequence that must be corrected.

#### 6.4.3.6 Interlocked Memory Sequence Checking for the MACRO–32 Compiler

The MACRO–32 Compiler for OpenVMS Alpha Version 4.1 now performs additional code checking and displays warning messages for noncompliant code sequences. The following warning messages can display under the circumstances described:

BRNDIRLOC, branch directive ignored in locked memory sequence

**Explanation:** The compiler found a .BRANCH\_LIKELY directive within an LDx\_L/STx\_C sequence.

**User Action:** None. The compiler ignores the .BRANCH\_LIKELY directive and, unless other coding guidelines are violated, the code works as written.

BRNTRGLOC, branch target within locked memory sequence in routine 'routine\_name'

**Explanation:** A branch instruction has a target that is within an LDx\_L/STx\_C sequence.

**User Action:** To avoid this warning, rewrite the source code to avoid branches within or into LDx\_L/STx\_C sequences. Branches out of interlocked sequences are valid and are not flagged.

## Synchronizing Data Access and Program Operations

### 6.4 Hardware-Level Synchronization

MEMACCLOC, memory access within locked memory sequence in routine 'routine\_name'

**Explanation:** A memory read or write occurs within an LD<sub>x</sub>\_L/ST<sub>x</sub>\_C sequence. This can be either an explicit reference in the source code, such as "MOVL data, R0", or an implicit reference to memory. For example, fetching the address of a data label (for example, "MOVAB label, R0") is accomplished by a read from the linkage section, the data area that is used to resolve external references.

**User Action:** To avoid this warning, move all memory accesses outside the LD<sub>x</sub>\_L/ST<sub>x</sub>\_C sequence.

RETFOLLOC, RET/RSB follows LD<sub>x</sub>\_L instruction

**Explanation:** The compiler found a RET or RSB instruction after an LD<sub>x</sub>\_L instruction and before finding an ST<sub>x</sub>\_C instruction. This indicates an ill-formed lock sequence.

**User Action:** Change the code so that the RET or RSB instruction does not fall between the LD<sub>x</sub>\_L instruction and the ST<sub>x</sub>\_C instruction.

RTNCALLOC, routine call within locked memory sequence in routine 'routine\_name'

**Explanation:** A routine call occurs within an LD<sub>x</sub>\_L/ST<sub>x</sub>\_C sequence. This can be either an explicit CALL/JSB in the source code, such as "JSB subroutine", or an implicit call that occurs as a result of another instruction. For example, some instructions such as MOVC and EDIV generate calls to run-time libraries.

**User Action:** To avoid this warning, move the routine call or the instruction that generates it, as indicated by the compiler, outside the LD<sub>x</sub>\_L/ST<sub>x</sub>\_C sequence.

STCMUSFOL, ST<sub>x</sub>\_C instruction must follow LD<sub>x</sub>\_L instruction

**Explanation:** The compiler found an ST<sub>x</sub>\_C instruction before finding an LD<sub>x</sub>\_L instruction. This indicates an ill-formed lock sequence.

**User Action:** Change the code so that the ST<sub>x</sub>\_C instruction follows the LD<sub>x</sub>\_L instruction.

#### 6.4.3.7 Recompiling Code with ALONONPAGED\_INLINE or LAL\_REMOVE\_FIRST Macros

Any MACRO-32 code on OpenVMS Alpha that invokes either the ALONONPAGED\_INLINE or the LAL\_REMOVE\_FIRST macros from the SYS\$LIBRARY:LIB.MLB macro library must be recompiled on OpenVMS Version 7.2 to obtain a correct version of these macros. The change to these macros corrects a potential synchronization problem that is more likely to be encountered on the new Alpha 21264 (EV6) processors.

---

#### Note

---

Source modules that call the EXE\$ALONONPAGED routine (or any of its variants) do *not* need to be recompiled. These modules transparently use the correct version of the routine that is included in this release.

---

#### **6.4.4 Interlocked Instructions (VAX Only)**

On VAX systems, seven instructions interlock memory. A memory interlock enables a VAX CPU or I/O processor to make an atomic read-modify-write operation to a location in memory that is shared by multiple processors. The memory interlock is implemented at the level of the memory controller. On a VAX multiprocessor system, an interlocked instruction is the only way to perform an atomic read-modify-write on a shared piece of data. The seven interlock memory instructions are as follows:

- ADAWI—Add aligned word, interlocked
- BBCCI—Branch on bit clear and clear, interlocked
- BBSSI—Branch on bit set and set, interlocked
- INSQHI—Insert entry into queue at head, interlocked
- INSQTI—Insert entry into queue at tail, interlocked
- REMQHI—Remove entry from queue at head, interlocked
- REMQTI—Remove entry from queue at tail, interlocked

The VAX architecture interlock memory instructions are described in detail in the *VAX Architecture Reference Manual*.

The following description of the interlocked instruction mechanism assumes that the interlock is implemented by the memory controller and that the memory contents are fresh.

When a VAX CPU executes an interlocked instruction, it issues an interlock-read command to the memory controller. The memory controller sets an internal flag and responds with the requested data. While the flag is set, the memory controller stalls any subsequent interlock-read commands for the same aligned longword from other CPUs and I/O processors, even though it continues to process ordinary reads and writes. Because interlocked instructions are noninterruptible, they are atomic with respect to threads of execution on the same processor.

When the VAX processor that is executing the interlocked instruction issues a write-unlock command, the memory controller writes the modified data back and clears its internal flag. The memory interlock exists for the duration of only one instruction. Execution of an interlocked instruction includes paired interlock-read and write-unlock memory controller commands.

When you synchronize data with interlocks, you must make sure that all accessors of that data use them. This means that memory references of an interlocked instruction are atomic only with respect to other interlocked memory references.

On VAX systems, the granularity of the interlock depends on the type of VAX system. A given VAX implementation is free to implement a larger interlock granularity than that which is required by the set of interlocked instructions listed above. On some processors, for example, while an interlocked access to a location is in progress, interlocked access to any other location in memory is not allowed.

## Synchronizing Data Access and Program Operations

### 6.4 Hardware-Level Synchronization

#### 6.4.5 Memory Barriers (Alpha Only)

On Alpha systems, there are no implied memory barriers except those performed by the PALcode routines that emulate the interlocked queue instructions. Wherever necessary, you must insert explicit memory barriers into your code to impose an order on memory references. Memory barriers are required to ensure both the order in which other members of an SMP system or an I/O processor see writes to shared data and the order in which reads of shared data complete.

There are two types of memory barrier:

- The MB instruction
- The instruction memory barrier (IMB) PALcode routine

The MB instruction guarantees that all subsequent loads and stores do not access memory until after all previous loads and stores have accessed memory from the viewpoint of multiple threads of execution. Even in a multiprocessor system, all of the instruction's reads of one processor always return the data from the most recent writes by that processor, assuming no other processor has written to the location. Alpha compilers provide semantics for generating memory barriers when needed for specific operations on data items.

The instruction memory barrier (IMB) PALcode routine must be used after a modification to the instruction stream to flush prefetched instructions. In addition, it also provides the same ordering effects as the MB instruction.

Code that modifies the instruction stream must be changed to synchronize the old and new instruction streams properly. Use of an REI instruction to accomplish this does not work on OpenVMS Alpha systems.

If a kernel mode code sequence changes the expected instruction stream, it must issue an IMB instruction after changing the instruction stream and before the time the change is executed. For example, if a device driver stores an instruction sequence in an extension to the unit control block (UCB) and then transfers control there, it must issue an IMB instruction after storing the data in the UCB but before transferring control to the UCB data.

The MACRO-32 compiler for OpenVMS Alpha provides the `EVAX_IMB` built-in to insert explicitly an IMB instruction in the instruction stream.

#### 6.4.6 PALcode Routines (Alpha Only)

Privileged architecture library (PALcode) routines include Alpha instructions that emulate VAX queue and interlocked queue instructions. PALcode executes in a special environment with interrupts blocked. This feature results in noninterruptible updates. A PALcode routine can perform the multiple memory reads and memory writes that insert or remove a queue element without interruption.

### 6.5 Software-Level Synchronization

The operating system uses the synchronization primitives provided by the hardware as the basis for several different synchronization techniques. The following sections summarize the operating system's synchronization techniques available to application software.

## Synchronizing Data Access and Program Operations

### 6.5 Software-Level Synchronization

#### 6.5.1 Synchronization Within a Process

On Alpha systems without kernel threads, only one thread of execution can execute within a process at a time, so synchronization of threads that execute simultaneously is not a concern. However, a delivery of an AST or the occurrence of an exception can intervene in a sequence of instructions in one thread of execution. Because these conditions can occur, application design must take into account the need for synchronization with condition handlers and AST procedures.

On Alpha systems, writing bytes or words or performing a read-modify-write operation requires a sequence of Alpha instructions. If the sequence incurs an exception or is interrupted by AST delivery or an exception, another process code thread can run. If that thread accesses the same data, it can read incompletely written data or cause data corruption. Aligning data on natural boundaries and unpacking word and byte data reduce this risk.

On Alpha systems, an application written in a language other than VAX MACRO must identify to the compiler data accessed by any combination of mainline code, AST procedures, and condition handlers to ensure that the compiler generates code that is atomic with respect to other threads. Also, data shared with other processes must be identified.

With process-private data accessed from both AST and non-AST threads of execution, the non-AST thread can block AST delivery by using the Set AST Enable (SYS\$SETAST) system service. If the code is running in kernel mode, it can also raise IPL to block AST delivery. The *Guide to Creating OpenVMS Modular Procedures* describes the concept of AST reentrancy.

On a uniprocessor or in a symmetric multiprocessing (SMP) system, access to multiple locations with a read or write instructions or with a read-modify-write sequence is not atomic on VAX and Alpha systems. Additional synchronization methods are required to control access to the data. See Section 6.5.4 and the sections following it, which describe the use of higher-level synchronization techniques.

#### 6.5.2 Synchronization in Inner Mode (Alpha Only)

On Alpha systems with kernel threads, the system allows multiple execution contexts, or threads within a process, that all share the same address space to run simultaneously. The synchronization provided by the SCHED spinlock continues to allow thread safe access to process data structures such as the process control block (PCB). However, access to process address space and any structures currently not explicitly synchronized with spin locks are no longer guaranteed exclusive access solely by access mode. In the multithreaded environment, a new process level synchronization mechanism is required.

Because spin locks operate on a systemwide level and do not offer the process level granularity required for inner mode access synchronization in a multithreaded environment, a process level semaphore is necessary to serialize inner mode (kernel and executive) access. User and supervisor mode threads are allowed to run without any required synchronization.

The process level semaphore for inner mode synchronization is the inner mode (IM) semaphore. The IM semaphore is created in the first floating-point registers and execution data block (FRED) page in the balance set slot process for each process. In a multithreaded environment, a thread requiring inner mode access must acquire ownership of the IM semaphore. That is, two threads associated with the same process cannot execute in inner mode simultaneously. If the

## Synchronizing Data Access and Program Operations

### 6.5 Software-Level Synchronization

semaphore is owned by another thread, then the requesting thread spins until inner mode access becomes available, or until some specified timeout value has expired.

#### 6.5.3 Synchronization Using Process Priority

In some applications (usually real-time applications), a number of processes perform a series of tasks. In such applications, the sequence in which a process executes can be controlled or synchronized by means of process priority. The basic method of synchronization by priority involves executing the process with the highest priority while preventing all other processes from executing.

If you use process priority for synchronization, be aware that if the higher-priority process is blocked, either explicitly or implicitly (for example, when doing an I/O), the lower-priority process can run, resulting in corruption on the data of the higher process's activities.

Because each processor in a multiprocessor system, when idle, schedules its own work load, it is impossible to prevent all other processes in the system from executing. Moreover, because the scheduler guarantees only that the highest-priority and computable process is scheduled at any given time, it is impossible to prevent another process in an application from executing.

Thus, application programs that synchronize by process priority must be modified to use a different serialization method to run correctly in a multiprocessor system.

#### 6.5.4 Synchronizing Multiprocess Applications

The operating system provides the following techniques to synchronize multiprocess applications:

- Common event flags
- Lock management system services

The operating system provides basic event synchronization through event flags. Common event flags can be shared among cooperating processes running on a uniprocessor or in an SMP system, though the processes must be in the same user identification code (UIC) group. Thus, if you have developed an application that requires the concurrent execution of several processes, you can use event flags to establish communication among them and to synchronize their activity. A shared, or common, event flag can represent any event that is detectable and agreed upon by the cooperating processes. See Section 6.6 for information about using event flags.

The lock management system services—Enqueue Lock Request (SYS\$ENQ), and Dequeue Lock Request (SYS\$DEQ)—provide multiprocess synchronization tools that can be requested from all access modes. For details about using lock management system services, see Chapter 7.

Synchronization of access to shared data by a multiprocess application should be designed to support processes that execute concurrently on different members of an SMP system. Applications that share a global section can use VAX MACRO interlocked instructions or the equivalent in other languages to synchronize access to data in the global section. These applications can also use the lock management system services for synchronization.



### 6.5.5 Writing Applications for an Operating System Running in a Multiprocessor Environment

Most application programs that run on an operating system in a uniprocessor system also run without modification in a multiprocessor system. However, applications that access writable global sections or that rely on process priority for synchronizing tasks should be reexamined and modified according to the information contained in this section.

In addition, some applications may execute more efficiently on a multiprocessor if they are specifically adapted to a multiprocessing environment. Application programmers may want to decompose an application into several processes and coordinate their activities by means of event flags or a shared region in memory.

### 6.5.6 Synchronization Using Spin Locks

A **spin lock** is a device used by a processor to synchronize access to data that is shared by members of a symmetric multiprocessing (SMP) system. A spin lock enables a set of processors to serialize their access to shared data. The basic form of a spin lock is a bit that indicates the state of a particular set of shared data. When the bit is set, it shows that a processor is accessing the data. A bit is either tested and set or tested and cleared; it is atomic with respect to other threads of execution on the same or other processors.

A processor that needs access to some shared data tests and sets the spin lock associated with that data. To test and set the spin lock, the processor uses an interlocked bit-test-and-set instruction. If the bit is clear, the processor can have access to the data. This is called locking or acquiring the spin lock. If the bit is set, the processor must wait because another processor is already accessing the data.

Essentially, a waiting processor spins in a tight loop; it executes repeated bit test instructions to test the state of the spin lock. The term spin lock derives from this spinning. When the spin lock is in a loop, repeatedly testing the state of the spin lock, the spin lock is said to be in a state of busy wait. The busy wait ends when the processor accessing the data clears the bit with an interlocked operation to indicate that it is done. When the bit is cleared, the spin lock is said to be unlocked or released.

Spin locks are used by the operating system executive, along with the interrupt priority level (IPL), to control access to system data structures in a multiprocessor system.

### 6.5.7 Writable Global Sections

A writable global section is an area of memory that can be accessed (read and modified) by more than one process. On uniprocessor or SMP systems, access to a single global section with an appropriate read or write instruction is atomic on VAX and Alpha systems. Therefore, no other synchronization is required.

An appropriate read or write on VAX systems is an instruction that is a naturally aligned byte, word, or longword, such as a MOV $x$  instruction, where  $x$  is a B for a byte, W for a word, or L for a longword. On Alpha systems, an appropriate read or write instruction is a naturally aligned longword or quadword, for instance, an LD $x$  or write ST $x$  instruction where  $x$  is an L for an aligned longword or Q for an aligned quadword.

## Synchronizing Data Access and Program Operations

### 6.5 Software-Level Synchronization

On both VAX and Alpha multiprocessor systems, for a read-modify-write sequence on a multiprocessor system, two or more processes can execute concurrently, one on each processor. As a result, it is possible that concurrently executing processes can access the same locations simultaneously in a writable global section. If this happens, only partial updates may occur, or data could be corrupted or lost, because the operation is not atomic. Unless proper interlocked instructions are used on VAX systems or load-locked/store-conditional instructions are used on Alpha systems, invalid data may result. You must use interlocked or load-locked/store-conditional instructions or other synchronizing techniques, such as locks or event flags.

On a uniprocessor or SMP system, access to multiple locations within a global section with read or write instructions or a read-modify-write sequence is not atomic on VAX and Alpha systems. On a uniprocessor system, an interrupt can occur that causes process preemption, allowing another process to run and access the data before the first process completes its work. On a multiprocessor system, two processes can access the global section simultaneously on different processors. You must use a synchronization technique such as a spin lock or event flags to avoid these problems.

Check existing programs that use writable global sections to ensure that proper synchronization techniques are in place. Review the program code itself; do not rely on testing alone, because an instance of simultaneous access by more than one process to a location in a writable global section is rare.

If an application must use queue instructions to control access to writable global sections, ensure that it uses interlocked queue instructions.

## 6.6 Using Event Flags

Event flags are maintained by the operating system for general programming use in coordinating thread execution with asynchronous events. Programs can use event flags to perform a variety of signaling functions. Event flag services clear, set, and read event flags. They also place a thread in a wait state pending the setting of an event flag or flags.

Table 6–2 shows the two usage styles of event flags.

**Table 6–2 Usage Styles of Event Flags**

Style	Meaning
Explicit	Uses SET, CLEAR, and READ functions that are commonly used when one thread deals with multiple asynchronous events.
Implicit	Uses the SYS\$SYNCH and wait form of system services when one or more threads wish to wait for a particular event. For multithreaded applications, only the implicit use of event flags is recommended.

The wait form of system services is a variant of asynchronous services; there is a service request and then a wait for the completion of the request. For reliable operation in most applications, WAIT form services must specify an I/O status block (IOSB). The IOSB prevents the service from completing prematurely and also provides status information.

### 6.6.1 General Guidelines for Using Event Flags

Explicit use of event flags follows these general steps:

1. Allocate or choose local event flags or associate common event flags for your use.
2. Set or clear the event flag.
3. Read the event flag.
4. Suspend thread execution until an event flag is set.
5. Deallocate the local event flags or disassociate common event flags when they are no longer needed.

Implicit use of event flags may involve only step 4, or steps 1, 4, and 5.

Use run-time library routines and system services to accomplish these event flag tasks. Table 6–3 summarizes the event flag routines and services.

**Table 6–3 Event Flag Routines and Services**

Routine or Service	Task
LIB\$FREE_EF	Deallocate a local event flag
LIB\$GET_EF	Allocate any local event flag
LIB\$RESERVE_EF	Allocate a specific local event flag
SYS\$ASCEFC	Associate a common event flag cluster
SYS\$CLREF	Clear a local or common event flag
SYS\$DACEFC	Disassociate a common event flag cluster
SYS\$DLCEFC	Delete a common event flag cluster
SYS\$READEF	Read a local or common event flag
SYS\$SETEF	Set a local or common event flag
SYS\$SYNCH	Wait for a local or common event flag to be set and for nonzero I/O status block—recommended to be used with threads
SYS\$WAITFR	Wait for a specific local or common event flag to be set—not recommended to be used with threads
SYS\$WFLAND	Wait for several local or common event flags to be set—logical AND of event flags
SYS\$WFLOR	Wait for one of several local or common event flags to be set—logical OR of event flags

Some system services set an event flag to indicate the completion or the occurrence of an event; the calling program can test the flag. Other system services use event flags to signal events to the calling process, such as SYS\$ENQ(W), SYS\$QIO(W), or SYS\$SETIMR.

### 6.6.2 Introducing Local and Common Event Flag Numbers and Event Flag Clusters

Each event flag has a unique number; event flag arguments in system service calls refer to these numbers. For example, if you specify event flag 1 in a call to the SYS\$QIO system service, then event flag 1 is set when the I/O operation completes.

## Synchronizing Data Access and Program Operations

### 6.6 Using Event Flags

To allow manipulation of groups of event flags, the flags are ordered in clusters of 32 numbers corresponding to bits 0 through 31 (<31:0>) in a longword. The clusters are also numbered from 0 to 4. The range of event flag numbers encompasses the flags in all clusters: event flag 0 is the first flag in cluster 0, event flag 32 is the first flag in cluster 1, and so on.

Event flags are divided into five clusters: two for local event flags and two for common event flags. There is also a special local cluster 4 that supports EFN 128.

- A local event flag cluster is process specific and is used to synchronize events within a process.
- A common event flag cluster can be shared by cooperating processes in the same UIC group. A common event flag cluster is identified by name and is specific to a UIC group and VMScLuster node. Before a process can use a common event flag cluster, it must explicitly “associate” with the cluster. (Association is described in Section 6.6.6.) Use them to synchronize events among images executing in different processes.
- A special local cluster 4 supports only EFN 128, symbolically EFN\$C\_ENF. EFN\$C\_ENF is intended for use with wait form services, such as SYS\$QIOW and SYS\$ENQW, or SYS\$SYNCH system service. However, EFN 128 can also be used with ASTs and the SYS\$QIO service. By using EFN 128 with ASTs, for example, you can avoid setting event flag zero (0), which eliminates possible event flag contention in processes. The EFN 128 allows you to bypass all event flag processing in system services. Using EFN 128 also allows for faster processing.

There is no need to reserve or free this event flag. Multiple threads of execution may concurrently use EFN\$C\_ENF without interference. With explicit event flag services, EFN\$C\_ENF behaves as if always set. For more information, see Section 6.6.4.

Table 6–4 summarizes the ranges of event flag numbers and the clusters to which they belong.

The same system services manipulate flags in either local and common event flag clusters. Because the event flag number implies the cluster number, you need not specify the cluster number when you call a system service that refers to an event flag.

When a system service requires an event flag cluster number as an argument, you need only specify the number of any event flag in the cluster. Thus, to read the event flags in cluster 1, you could specify any number in the range 32 through 63.

**Table 6–4 Event Flags**

Cluster Number	Flag Number	Type	Usage
0	0	Local	Default flag used by system routines.

(continued on next page)

## Synchronizing Data Access and Program Operations

### 6.6 Using Event Flags

Table 6–4 (Cont.) Event Flags

Cluster Number	Flag Number	Type	Usage
0	1 to 23	Local	May be used in system routines. When an event flag is requested, it is not returned unless it has been previously and specifically freed by calls to LIB\$FREE_EF.
0	24 to 31	Local	Reserved for Compaq use only.
1	32 to 63	Local	Available for general use.
2	64 to 95	Common	Available for general use.
3	96 to 127	Common	Available for general use.
4	128	Local	Available for general use without explicit allocation.

#### 6.6.3 Using Event Flag Zero (0)

Event flag 0 is the default event flag. Whenever a process requests a system service with an event flag number argument, but does not specify a particular flag, event flag 0 is used. Therefore, event flag 0 is more likely than other event flags to be used incorrectly for multiple concurrent requests.

Code that uses any event flag should be able to tolerate spurious sets, assuming that the only real danger is a spurious clear that causes a thread to miss an event. Since any system service that uses an event flag clears the flag, there is a danger that an event which has occurred but has not been responded to is masked which can result in a hang. For further information, see the SYS\$SYNCH system service in *OpenVMS System Services Reference Manual: GETUTC-Z*.

#### 6.6.4 Using EFN\$C\_ENF Local Event Flag

The combination of EFN\$C\_ENF and a status block should be used with the wait form of system services, or with SYS\$SYNCH system service. EFN\$C\_ENF does not need to be initialized, nor does it need to be reserved or freed. Multiple threads of execution may concurrently use EFN\$C\_ENF without interference as long as they use a unique status block for each concurrent asynchronous service. When EFN\$C\_ENF is used with explicit event flag system services, it performs as if always set. You should use EFN\$C\_ENF to eliminate the chance for event flag overlap.

#### 6.6.5 Using Local Event Flags

Local event flags are automatically available to each program. They are not automatically initialized. However, if an event flag is passed to a system service such as SYS\$GETJPI, the service initializes the flag before using it.

When using local event flags, use the event flag routines as follows:

1. To ensure that the event flag you are using is not accessed and changed by other users, allocate local event flags. The *OpenVMS RTL Library (LIB\$) Manual* describes routines you can use to allocate an arbitrary event flag (LIB\$GET\_EF), and to allocate a particular event flag (LIB\$RESERVE\_EF) from the processwide pool of available local event flags. Similar routines do not exist for common event flags.

## Synchronizing Data Access and Program Operations

### 6.6 Using Event Flags

The LIB\$GET\_EF routine by default allocates flags from event flag cluster 1 (event flags 32 through 63). Event flags 1 through 32 (in event flag cluster 0) can also optionally be allocated by calls to LIB\$GET\_EF. To maintain compatibility with older application software that used event flags 1 through 23 in an uncoordinated fashion, these event flags must be initially marked as free by application calls to the LIB\$FREE\_EF routine before these flags can be allocated by subsequent calls to the LIB\$GET\_EF routine.

2. Before using the event flag, initialize it using the SYS\$CLREF system service, unless you pass the event flag to a routine that clears it for you.
3. When an event that is relevant to other program components is completed, set the event flag with the SYS\$SETEF system service.
4. A program component can read the event flag to determine what has happened and act accordingly. Use the SYS\$READEF system service to read the event flag.
5. The program components that evaluate event flag status can be placed in a wait state. Then, when the event flag is set, execution is resumed. Use the SYS\$WAITFR, SYS\$WFLOR, SYS\$WFLAND, or SYS\$SYNCH routine to accomplish this task.
6. When a local event flag is no longer required, free it by using the LIB\$FREE\_EF routine.

The following Fortran example uses LIB\$GET\_EF to choose a local event flag and then uses SYS\$CLREF to set the event flag to 0 (clear the event flag). (Note that run-time library routines require an event flag number to be passed by reference, and system services require an event flag number to be passed by value.)

```
INTEGER FLAG,  
2      STATUS,  
2      LIB$GET_EF,  
2      SYS$CLREF  
  
STATUS = LIB$GET_EF (FLAG)  
IF (.NOT. STATUS) CALL LIB$SIGNAL (%VAL(STATUS))  
STATUS = SYS$CLREF (%VAL(FLAG))  
IF (.NOT. STATUS) CALL LIB$SIGNAL (%VAL(STATUS))
```

#### 6.6.5.1 Example of Event Flag Services

Local event flags are used most commonly with other system services. For example, you can use the Set Timer (SYS\$SETIMR) system service to request that an event flag be set either at a specific time of day or after a specific interval of time has passed. If you want to place a process in a wait state for a specified period of time, specify an event flag number for the SYS\$SETIMR service and then use the Wait for Single Event Flag (SYS\$WAITFR) system service, as shown in the C example that follows:

```
.  
.  
.  
main() {  
    unsigned int status, daytim[1], efn=3;
```

## Synchronizing Data Access and Program Operations

### 6.6 Using Event Flags

```
/* Set the timer */
    status = SYS$SETIMR( efn, /* efn - event flag */
                       &daytim, /* daytim - expiration time */
                       0, /* astadr - AST routine */
                       0, /* reqidt - timer request id */
                       0); /* flags */
    if ((status & 1) != 1)
        LIB$SIGNAL( status );
    .
    .
    .
/* Wait until timer expires */
    status = SYS$WAITFR( efn );
    if ((status & 1) != 1)
        LIB$SIGNAL( status );
    .
    .
    .
}
```

In this example, the **daytim** argument refers to a 64-bit time value. For details about how to obtain a time value in the proper format for input to this service, see Chapter 27.

#### 6.6.6 Using Common Event Flags

Common event flags are manipulated like local event flags. However, before a process can use event flags in a common event flag cluster, the cluster must be created. The Associate Common Event Flag Cluster (SYS\$ASCEFC) system service creates a common event flag cluster. (Section 6.6.6.1 explains the format of this string.) By calling SYS\$ASCEFC, other processes in the same UIC group can establish their association with the cluster so they can access flags in it. Each process that associates with the cluster must use the same name to refer to it; the SYS\$ASCEFC system service establishes correspondence between the cluster name and the cluster number that a process assigns to the cluster.

The first program to name a common event flag cluster creates it; all flags in a newly created cluster are clear. Other processes on the same OpenVMS cluster node that have the same UIC group number as the creator of the cluster can reference the cluster by invoking SYS\$ASCEFC and specifying the cluster name.

Different processes may associate the same name with different common event flag numbers; as long as the name and UIC group are the same, the processes reference the same cluster.

Common event flags act as a communication mechanism between images executing in different processes in the same group on the same OpenVMS cluster node. Common event flags are often used as a synchronization tool for other, more complicated communication techniques, such as logical names and global sections. For more information about using event flags to synchronize communication between processes, see Chapter 3.

If every cooperating process that is going to use a common event flag cluster has the necessary privilege or quota to create a cluster, the first process to call the SYS\$ASCEFC system service creates the cluster.

The following example shows how a process might create a common event flag cluster named COMMON\_CLUSTER and assign it a cluster number of 2:

## Synchronizing Data Access and Program Operations

### 6.6 Using Event Flags

```
.
.
#include <descrip.h>
.
.
.
    unsigned int status, efn=65;
    $DESCRIPTOR(name,"COMMON_CLUSTER"); /* Cluster name */
.
.
.
/* Create cluster 2 */
    status = SYS$ASCEFC( efn, &name, 0, 0);
```

Other processes in the same group can now associate with this cluster. Those processes must use the same character string name to refer to the cluster; however, the cluster numbers they assign do not have to be the same.

#### 6.6.6.1 Using the name Argument with SYS\$ASCEFC

The **name** argument to the Associate Common Event Flag Cluster (SYS\$ASCEFC) system service identifies the cluster that the process is creating or associating with. The **name** argument specifies a descriptor pointing to a character string.

Translation of the **name** argument proceeds in the following manner:

1. CEF\$ is prefixed to the current name string, and the result is subjected to logical name translation.
2. If the result is a logical name, step 1 is repeated until translation does not succeed or until the number of translations performed exceeds the number 10.
3. The CEF\$ prefix is stripped from the current name string that could not be translated. This current string is the cluster name.

For example, assume that you have made the following logical name assignment:

```
$ DEFINE CEF$CLUS_RT CLUS_RT_001
```

Assume also that your program contains the following statements:

```
#include <ssdef.h>
#include <descrip.h>
.
.
.
    unsigned int status;
    $DESCRIPTOR(name,"CLUS_RT"); /* Logical name of cluster */
.
.
.
    status = SYS$ASCEFC( . . . ,&name, . . . );
```

The following logical name translation takes place:

1. CEF\$ is prefixed to CLUS\_RT.
2. CEF\$CLUS\_RT is translated to CLUS\_RT\_001. (Further translation is unsuccessful. When logical name translation fails, the string is passed to the service.)



## Synchronizing Data Access and Program Operations

### 6.6 Using Event Flags

There are two exceptions to the logical name translation method discussed in this section:

- If the name string starts with an underscore (`_`), the operating system strips the underscore and considers the resultant string to be the actual name (that is, further translation is not performed).
- If the name string is the result of a logical name translation, the name string is checked to see whether it has the **terminal** attribute. If it does, the operating system considers the resultant string to be the actual name (that is, further translation is not performed).

#### 6.6.6.2 Temporary Common Event Flag Clusters

Common event flag clusters are either temporary or permanent. The **perm** argument to the `SYS$ASCEFC` system service defines whether the cluster is temporary or permanent.

Temporary clusters require an element of the creating process's quota for timer queue entries (TQELM quota). They are deleted automatically when all processes associated with the cluster have disassociated. Disassociation can be performed explicitly with the Disassociate Common Event Flag Cluster (`SYS$DACEFC`) system service, or implicitly when the image that called `SYS$ASCEFC` exits.

#### 6.6.6.3 Permanent Common Event Flag Clusters

If you have the `PRMCEB` privilege, you can create a permanent common event flag cluster (set the **perm** argument to 1 when you invoke `SYS$ASCEFC`). A permanent event flag cluster continues to exist until it is marked explicitly for deletion with the Delete Common Event Flag Cluster (`SYS$DLCEFC`) system service (requires the `PRMCEB` privilege). Once a permanent cluster is marked for deletion, it is like a temporary cluster; when the last process that associated with the cluster disassociates from it, the cluster is deleted.

In the following examples, the first program segment associates common event flag cluster 3 with the name `CLUSTER` and then clears the second event flag in the cluster. The second program segment associates common event flag cluster 2 with the name `CLUSTER` and then sets the second event flag in the cluster (the flag cleared by the first program segment).

##### Example 1

```
STATUS = SYS$ASCEFC (%VAL(96),  
2 'CLUSTER',,  
STATUS = SYS$CLREF (%VAL(98))
```

##### Example 2

```
STATUS = SYS$ASCEFC (%VAL(64),  
2 'CLUSTER',,  
STATUS = SYS$SETEF (%VAL(66))
```

For clearer code, rather than using a specific event flag number, use one variable to contain the bit offset you need and one variable to contain the number of the first bit in the common event flag cluster that you are using. To reference the common event flag, add the offset to the number of the first bit. The following examples accomplish the same result as the preceding two examples:

## Synchronizing Data Access and Program Operations

### 6.6 Using Event Flags

#### Example 1

```
INTEGER*4 BASE,
2      OFFSET
PARAMETER (BASE = 96)

OFFSET=2
STATUS = SYS$ASCEFC (%VAL(BASE),
2      'CLUSTER',,)
STATUS = SYS$CLREF (%VAL(BASE+OFFSET))
```

#### Example 2

```
INTEGER*4 BASE,
2      OFFSET
PARAMETER (BASE = 64)

OFFSET=2
STATUS = SYS$ASCEFC (%VAL(BASE),
2      'CLUSTER',,)
STATUS = SYS$SETEF (%VAL(BASE+OFFSET))
```

Common event flags are often used for communicating between a parent process and a created subprocess. The following parent process associates the name CLUSTER with a common event flag cluster, creates a subprocess, and then waits for the subprocess to set event flag 64:

```
INTEGER*4 BASE,
2      OFFSET
PARAMETER (BASE = 64,
2      OFFSET = 0)
.
.
.
! Associate common event flag cluster with name
STATUS = SYS$ASCEFC (%VAL(BASE),
2      'CLUSTER',,)
IF (.NOT. STATUS) CALL LIB$SIGNAL (%VAL(STATUS))

! Create subprocess to execute concurrently
MASK = IBSET (MASK,0)
STATUS = LIB$SPAWN ('RUN REPORTSUB', ! Image
2      'INPUT.DAT', ! SYS$INPUT
2      'OUTPUT.DAT', ! SYS$OUTPUT
2      MASK)
IF (.NOT. STATUS) CALL LIB$SIGNAL (%VAL(STATUS))

! Wait for response from subprocess
STATUS = SYS$WAITFR (%VAL(BASE+OFFSET))
IF (.NOT. STATUS) CALL LIB$SIGNAL (%VAL(STATUS))
.
.
.
```

REPORTSUB, the program executing in the subprocess, associates the name CLUSTER with a common event flag cluster, performs some set of operations, sets event flag 64 (allowing the parent to continue execution), and continues executing:

## Synchronizing Data Access and Program Operations

### 6.6 Using Event Flags

```
INTEGER*4 BASE,
2      OFFSET
PARAMETER (BASE = 64,
2      OFFSET = 0)
.
.
.
! Do operations necessary for
! continuation of parent process
.
.
! Associate common event flag cluster with name
STATUS = SYS$ASCEFC (%VAL(BASE),
2      'CLUSTER',)
IF (.NOT. STATUS)
2 CALL LIB$SIGNAL (%VAL(STATUS))

! Set flag for parent process to resume
STATUS = SYS$SETEF (%VAL(BASE+OFFSET))
.
.
.
```

#### 6.6.7 Wait Form Services and SYS\$SYNCH

A wait form system service is a variant of an asynchronous service in which there is a service request and then a wait for the completion of the request. The SYS\$SYNCH system service checks the completion status of a system service that completes asynchronously. For reliable operation in most applications, the service whose completion status is to be checked must have been called with the **efn** and **iosb** arguments specified. The SYS\$SYNCH service uses the event flag and I/O status block of the service to be checked.

Compaq recommends that only EFN\$C\_ENF be used for concurrent use of event flags.

#### 6.6.8 Event Flag Waits

The following three system services place the process or thread in a wait state until an event flag or a group of event flags is set:

- The Wait for Single Event Flag (SYS\$WAITFR) system service places the process or thread in a wait state until a *single* flag has been set.
- The Wait for Logical OR of Event Flags (SYS\$WFLOR) system service places the process or thread in a wait state until *any one* of a specified group of event flags has been set.
- The Wait for Logical AND of Event Flags (SYS\$WFLAND) system service places the process or thread in a wait state until *all* of a specified group of event flags have been set.

Another system service that accepts an event flag number as an argument is the Queue I/O Request (SYS\$QIO) system service. The following example shows a program segment that issues two SYS\$QIO system service calls and uses the SYS\$WFLAND system service to wait until both I/O operations complete before it continues execution:

## Synchronizing Data Access and Program Operations

### 6.6 Using Event Flags

```

.
.
.
#include <lib$routines.h>
#include <starlet.h>
#include <stsdef.h>
.
.
.
    unsigned int RetStat, Efn1=1, Efn2=2, EFMask;           ❶
    unsigned short int IOSB1[4], IOSB2[4];                ❷
    unsigned int EFMask = 1L<<Efn1 | 1L<<Efn2;            ❸
.
.
.
// Issue first I/O request and check for error */
    RetStat = sys$qio( Efn1, Chan1, FuncCode1, IOSB1, ... )
    if (!$VMS STATUS_SUCCESS( RetStat ))                  ❹
        lib$signal(RetStat);

// Issue second I/O request and check for error
    RetStat = sys$qio( Efn2, Chan2, FuncCode2, IOSB2, ... )
    if (!$VMS STATUS_SUCCESS( RetStat ))
        lib$signal(RetStat);

// Wait until both complete and check for error          ❺
    RetStat = sys$wfland( Efn1, EFMask );
    if (!$VMS STATUS_SUCCESS( RetStat ))
        lib$signal(status);

// Determine which asynchronous operation has completed.
// If set to zero, the particular $qio call has not completed.  ❻
    if ( IOSB1[0] )
        CallOneCompleted();
    if ( IOSB2[0] )
        CallTwoCompleted();
.
.
.

```

- ❶ The event flag argument is specified in each SYS\$QIO request. Both of these event flags are explicitly declared in event flag cluster 0. These variables contain the event flag numbers, and not the event flag masks.
- ❷ The I/O Status Blocks are declared. Ensure that the storage associated with these structures is valid over the lifetime of the asynchronous call. Ensure that these structures are not declared within the local context of a call frame of a function that can exit before the asynchronous call completes. Be sure that these calls are declared with static or external context, within the stack frame of a function that will either remain active, or was located within other non-volatile storage.

The use of either LIB\$GET\_EF or EFN\$C\_ENF (defined in efndef.h) is strongly recommended over the static declaration of local event flags, because the consistent use of either of these techniques will avoid the unintended reuse of local event flags within different parts of the same program, and the intermittent problems that can ensue. Common event flags are somewhat less likely to encounter similar problems due to the requirement to associate with the cluster before use. But the use and switching of event flag clusters and the use of event flags within each cluster should still be carefully coordinated.

## Synchronizing Data Access and Program Operations

### 6.6 Using Event Flags

- ③ Set up the event flag mask. Since both of these event flags are located in the same event flag cluster, you can use a simple OR to create the bit mask. Since these event flags are in the same cluster, you can use them in the SYS\$WSFLAND call.
- ④ After both I/O requests are queued successfully, the program calls the SYS\$WFLAND system service to wait until the I/O operations complete. In this service call, the **Efn1** argument can specify any event flag number within the event flag cluster containing the event flags to be waited for, since the argument indicates which event flag cluster is associated with the mask. The **EFMask** argument specifies to wait for flags 1 and 2.  
You should specify a unique event flag (or of EFN\$C\_ENF) and a unique I/O Status Block for any asynchronous call.
- ⑤ Note that the SYS\$WFLAND system service (and the other wait system services) waits for the event flag to be set; it does not wait for the I/O operation to complete. If some other event were to set the required event flags, the wait for event flag would complete prematurely. Use of event flags must be coordinated carefully.
- ⑥ Use the I/O Status Block to determine which of the two calls have completed. The I/O status block is initialized to zero by the \$qio call, and is set to non-zero when the call is completed. An event flag can be set spuriously—typically if there is unintended sharing or reuse of event flags—and thus you should check the I/O status block. For a mechanism that can check both the event flag and the IOSB and thus ensure that the call has completed, see the \$synch system service call.

#### 6.6.9 Setting and Clearing Event Flags

System services that use event flags clear the event flag specified in the system service call before they queue the timer or I/O request. This ensures that the process knows the state of the event flag. If you are using event flags in local clusters for other purposes, be sure the flag's initial value is what you want before you use it.

The Set Event Flag (SYS\$SETEF) and Clear Event Flag (SYS\$CLREF) system services set and clear specific event flags. For example, the following system service call clears event flag 32:

```
$CLREF_S EFN=#32
```

The SYS\$SETEF and SYS\$CLREF services return successful status codes that indicate whether the specified flag was set or cleared when the service was called. The caller can thus determine the previous state of the flag, if necessary. The codes returned are SS\$\_WASSET and SS\$\_WASCLR.

All event flags in a common event flag cluster are initially clear when the cluster is created. Section 6.6.10 describes the creation of common event flag clusters.

#### 6.6.10 Example of Using a Common Event Flag Cluster

The following example shows four cooperating processes that share a common event flag cluster. The processes are named COLUMBIA, ENDEAVOUR, ATLANTIS, and DISCOVERY, and are all in the same UIC group.

## Synchronizing Data Access and Program Operations

### 6.6 Using Event Flags

```

/* **** Common Header File **** ❶
.
.
.
#define EFC0 0 // EFC 0 (Local)
#define EFC1 32 // EFC 1 (Local)
#define EFC2 64 // EFC 2 (Common)
#define EFC3 96 // EFC 3 (Common)
    int Efn0 = 0, Efn1 = 1, Efn2 = 2, Efn3 = 3;
    int EFMask;
    $DESCRIPTOR(EFCname, "ENTERPRISE");
.
.
.
// **** Process COLUMBIA **** ❷
//
// The image running within process COLUMBIA creates a common
// event flag cluster, associating it with Cluster 2
.
.
.
    RetStat = sys$ascefc(EFC2, &EFCname, . . . ); ❸
    if (!$VMS STATUS_SUCCESS(RetStat))
        lib$signal(RetStat);
.
.
.
    EFMask = 1L<<Efn1 | 1L<<Efn2 | 1L<<Efn3; ❹
// Wait for the specified event flags
    RetStat = sys$wfland(EFC2, EFMask); ❺
    if (!$VMS STATUS_SUCCESS(RetStat))
        lib$signal(RetStat);
.
.
.
// Disassociate the event flag cluster ❻
    RetStat = sys$dacefc(EFC2);

// **** Process ENDEAVOUR ****
//
// The image running within process ENDEAVOUR associates with the
// specified event flag cluster, specifically associating it with
// the common event flag cluster 3.
.
.
.
// Associate the event flag cluster, using Cluster 3 ❼
    RetStat = sys$ascefc(EFC3, &EFCname, . . . );
    if (!$VMS STATUS_SUCCESS(RetStat))
        lib$signal(RetStat);

// Set the event flag, and check for errors ❽
    RetStat = sys$setef(Efn2+EFC3);
    if (!$VMS STATUS_SUCCESS(RetStat))
        lib$signal(RetStat);
.
.
.
    RetStat = sys$dacefc(EFC3);

```

## Synchronizing Data Access and Program Operations

### 6.6 Using Event Flags

```

// **** Process ATLANTIS ****
//
// The image running within process ATLANTIS associates with the
// specified event flag cluster, specifically associating it with
// the common event flag cluster 2.
// Associate the event flag cluster, using Cluster 2
RetStat = sys$ascefc(EFC2, &EFCname);
if (!$VMS STATUS_SUCCESS(RetStat))
    lib$signal(RetStat);
// Set the event flag, and check for errors
RetStat = sys$setef(Efn2+EFC2);
if (!$VMS STATUS_SUCCESS(RetStat))
    lib$signal(RetStat);
.
.
.
retstat = sys$dacefc(EFC2);

// **** Process DISCOVERY ****
// The image running within process DISCOVERY associates with the
// specified event flag cluster, specifically associating it with
// the common event flag cluster 3.
RetStat = sys$ascefc(EFC3, &EFCname);
if (!$VMS STATUS_SUCCESS(RetStat))
    lib$signal(RetStat);
// Wait for the flag, and check for errors
RetStat = sys$waitfr(Efn2+EFC3);
if (!$VMS STATUS_SUCCESS(RetStat))
    lib$signal(RetStat);
// Set event flag 2, and check for errors
RetStat = sys$setef(Efn2+EFC3);
if (!$VMS STATUS_SUCCESS(RetStat))
    lib$signal(RetStat);
.
.
.
RetStat = sys$dacefc(EFC2);

```

- ❶ Set up some common definitions used by the various applications, including preprocessor defines for the event flag clusters, and some variables and values for particular event flags within the clusters.
- ❷ Assume that COLUMBIA is the first process to issue the SYS\$ASCEFC system service and therefore is the creator of the ENTERPRISE event flag cluster. Because this is a newly created common event flag cluster, all event flags in it are clear. COLUMBA then waits for the specified event flags, and then exits—the process will remain in a common event flag (CEF) wait state.
- ❸ Use bit-shifts and an OR operation to create a bit mask from the bit numbers.
- ❹ The SYS\$ASCEFC call creates the relationship of the named event flag cluster, the specified range of common event flags, and the process. It also creates the event flag cluster, if necessary.
- ❺ The SYS\$DACEFC call disassociates the specified event flag cluster from the COLUMBIA process.

## Synchronizing Data Access and Program Operations

### 6.6 Using Event Flags

- ⑥ In process ENDEAVOUR, the argument **EFCname** in the SYS\$ASCEFC system service call is a pointer to the string descriptor containing the name to be assigned to the event flag cluster; in this example, the cluster is named ENTERPRISE and was created by process COLUMBIA. While COLUMBIA mapped this cluster as cluster 2, this service call associates this name with cluster 3, event flags 96 through 127. Cooperating processes ENDEAVOUR, ATLANTIS, and DISCOVERY must use the same character string name to refer to this cluster.
- ⑦ The continuation of process COLUMBIA depends on (unspecified) work done by processes ENDEAVOUR, ATLANTIS, and DISCOVERY. The SYS\$WFLAND system service call specifies a mask indicating the event flags that must be set before process COLUMBIA can continue. The mask in this example (binary 1110) indicates that the second, third, and fourth flags in the cluster must be set. Process ENDEAVOUR sets the second event flag in the event flag cluster longword, using the SYS\$SETEF system service call.
- ⑧ Process ATLANTIS associates with the cluster, but instead of referring to it as cluster 2, it refers to it as cluster 3 (with event flags in the range 96 through 127). Thus, when process ATLANTIS sets the event flag, it must bias the flag for the particular event flag cluster longword.
- ⑨ Process DISCOVERY associates with the cluster, waits for an event flag set by process ENDEAVOUR, and sets an event flag itself.

#### 6.6.11 Example of Using Event Flag Routines and Services

This section contains an example of how to use event flag services.

Common event flags are often used for communicating between a parent process and a created subprocess. In the following example, REPORT.FOR creates a subprocess to execute REPORTSUB.FOR, which performs a number of operations.

After REPORTSUB.FOR performs its first operation, the two processes can perform in parallel. REPORT.FOR and REPORTSUB.FOR use the common event flag cluster named JESSIER to communicate.

REPORT.FOR associates the cluster name with a common event flag cluster, creates a subprocess to execute REPORTSUB.FOR and then waits for REPORTSUB.FOR to set the first event flag in the cluster. REPORTSUB.FOR performs its first operation, associates the cluster name JESSIER with a common event flag cluster, and sets the first flag. From then on, the processes execute concurrently.

```
REPORT.FOR
.
.
.
! Associate common event flag cluster
STATUS = SYS$ASCEFC (%VAL(64),
2          'JESSIER',,,)
IF (.NOT. STATUS) CALL LIB$SIGNAL (%VAL(STATUS))

! Create subprocess to execute concurrently
MASK = IBSET (MASK,0)
STATUS = LIB$SPAWN ('RUN REPORTSUB', ! Image
2          'INPUT.DAT',      ! SYS$INPUT
2          'OUTPUT.DAT',    ! SYS$OUTPUT
2          MASK
IF (.NOT. STATUS) CALL LIB$SIGNAL (%VAL(STATUS))
```



## Synchronizing Data Access and Program Operations

### 6.6 Using Event Flags

```
! Wait for response from subprocess.
STATUS = SYS$WAITFR (%VAL(64))
IF (.NOT. STATUS) CALL LIB$SIGNAL (%VAL(STATUS))
.
.
.
REPORTSUB.FOR
.
.
.
! Do operations necessary for
! continuation of parent process.
.
.
.
! Associate common event flag cluster
STATUS = SYS$ASCEFC (%VAL(64),
2      'JESSIER',, )
IF (.NOT. STATUS)
2 CALL LIB$SIGNAL (%VAL(STATUS))

! Set flag for parent process to resume
STATUS = SYS$SETEF (%VAL(64))
.
.
.
```

## 6.7 Synchronizing Operations with System Services

A number of system services can be executed either synchronously or asynchronously such as the following:

- SYS\$GETJPI and SYS\$GETJPIW
- SYS\$QIO and SYS\$QIOW

The W at the end of the system service name indicates the synchronous version of the service.

The asynchronous version of a system service queues a request and immediately returns control to your program pending the completion of the request. You can perform other operations while the system service executes. To avoid data corruptions, you should not attempt any read or write access to any of the buffers or itemlists referenced by the system service call prior to the completion of the asynchronous portion of the system service call. Further, no self-referential or self-modifying itemlists should be used.

Typically, you pass an event flag and an I/O status block to an asynchronous system service. When the system service completes, it sets the event flag and places the final status of the request in the I/O status block. Use the SYS\$SYNCH system service to ensure that the system service has completed. You pass to SYS\$SYNCH the event flag and I/O status block that you passed to the asynchronous system service; SYS\$SYNCH waits for the event flag to be set and then examines the I/O status block to be sure that the system service rather than some other program set the event flag. If the I/O status block is still 0, SYS\$SYNCH waits until the I/O status block is filled.

## Synchronizing Data Access and Program Operations

### 6.7 Synchronizing Operations with System Services

The following example shows the use of the SYS\$GETJPI system service:

```
! Data structure for SYS$GETJPI
.
.
.
INTEGER*4 STATUS,
2      FLAG,
2      PID VALUE
! I/O status block
STRUCTURE /STATUS_BLOCK/
  INTEGER*2 JPISTATUS,
  2      LEN
  INTEGER*4 ZERO /0/
END STRUCTURE
RECORD /STATUS_BLOCK/ IOSTATUS
.
.
.
! Call SYS$GETJPI and wait for information
STATUS = LIB$GET_EF (FLAG)
IF (.NOT. STATUS) CALL LIB$SIGNAL (%VAL(STATUS))
STATUS = SYS$GETJPI (%VAL(FLAG),
2      PID_VALUE,
2      ,
2      NAME_BUF_LEN,
2      IOSTATUS,
2      ,)
IF (.NOT. STATUS) CALL LIB$SIGNAL (%VAL(STATUS))
.
.
.
STATUS = SYS$SYNCH (%VAL(FLAG),
2      IOSTATUS)
IF (.NOT. IOSTATUS.JPISTATUS) THEN
  CALL LIB$SIGNAL (%VAL(IOSTATUS.JPISTATUS))
END IF
END
```

The synchronous version of a system service acts as if you had used the asynchronous version followed immediately by a call to SYS\$SYNCH; however, it behaves this way only if you specify a status block. If you omit the I/O status block, the result is as though you called the asynchronous version followed by a call to SYS\$WAITFR. Regardless of whether you use the synchronous or asynchronous version of a system service, if you omit the **efn** argument, the service uses event flag 0.

---

## Synchronizing Access to Resources

This chapter describes the use of the lock manager to synchronize access to shared resources and contains the following sections:

Section 7.1 describes how the lock manager synchronizes processes to a specified resource.

Section 7.2 describes how to use the dedicated CPU lock manager to enhance system performance.

Section 7.3 describes the concepts of resources and locks.

Section 7.4 describes how to use the SYS\$ENQ and SYS\$ENQW system services to queue lock requests.

Section 7.5 describes specialized features of locking techniques.

Section 7.6 describes how to use the SYS\$DEQ system service to dequeue the lock.

Section 7.7 describes how applications can perform local buffer caching.

Section 7.8 presents a code example of how to use lock management services.

### 7.1 Synchronizing Operations with the Lock Manager

Cooperating processes can use the lock manager to synchronize access to a shared resource (for example, a file, program, or device). This synchronization is accomplished by allowing processes to establish locks on named resources. All processes that access the shared resources must use the lock management services; otherwise, the synchronization is not effective.

---

#### Note

---

The use of the term *resource* throughout this chapter means shared resource.

---

To synchronize access to resources, the lock management services provide a mechanism that allows processes to wait in a queue until a particular resource is available.

The lock manager does not ensure proper access to the resource; rather, the programs must respect the rules for using the lock manager. The rules required for proper synchronization to the resource are as follows:

- The resource must always be referred to by an agreed-upon name.
- Access to the resource is always accomplished by queuing a lock request with the SYS\$ENQ or SYS\$ENQW system service.

## Synchronizing Access to Resources

### 7.1 Synchronizing Operations with the Lock Manager

- All lock requests that are placed in a wait queue must wait for access to the resource.

A process can choose to lock a resource and then create a subprocess to operate on this resource. In this case, the program that created the subprocess (the parent program) should not exit until the subprocess has exited. To ensure that the parent program does not exit before the subprocess, specify an event flag to be set when the subprocess exits (use the **completion-efn** argument of LIB\$SPAWN). Before exiting from the parent program, use SYS\$WAITFR to ensure that the event flag is set. (You can suppress the logout message from the subprocess by using the SYS\$DELPRC system service to delete the subprocess instead of allowing the subprocess to exit.)

Table 7–1 summarizes the lock manager services.

**Table 7–1 Lock Manager Services**

Routine	Description
SYS\$ENQ(W)	Queues a new lock or lock conversion on a resource
SYS\$DEQ	Releases locks and cancels lock requests
SYS\$GETLKI(W)	Obtains information about the lock database

### 7.2 Using the Dedicated CPU Lock Manager (Alpha Only)

The Dedicated CPU Lock Manager is a feature that improves performance on large SMP systems that have heavy lock manager activity. The feature dedicates a CPU to performing lock manager operations.

A dedicated CPU has the following advantages for overall system performance:

- Reduces the amount of MP\_SYNCH time
- Provides good CPU cache utilization

#### 7.2.1 Implementing the Dedicated CPU Lock Manager

For the Dedicated CPU Lock Manager to be effective, systems must have a high CPU count and a high amount of MP\_SYNCH due to the lock manager. The amount of MP\_SYNCH can be seen with the MONITOR utility by using the MONITOR MODE command. If your system has more than 5 CPUs and if MP\_SYNCH is higher than 200 percent, then your system may be able to take advantage of the Dedicated CPU Lock Manager. Usage of the spinlock trace feature under SDA can help determine if the lock manager is contributing to the high amount of MP\_SYNCH time.

The dedicated CPU Lock Manager is implemented by LCKMGR\_SERVER process. This process runs at priority 63. When the Dedicated CPU Lock Manager is turned on, this process runs in a compute bound loop looking for lock manager work to perform. Because this process polls for work, it is always computable, and with a priority of 63, the process will never give up the CPU. Thus, a whole CPU is consumed by this process.

When a program calls either the \$ENQ or \$DEQ System Services, and if the Dedicated CPU Lock Manager is running, a lock manager request is placed on a work queue for the Dedicated CPU Lock Manager. While the process is waiting for the lock request to be processed, the process spins in kernel mode at IPL 2.

## Synchronizing Access to Resources

### 7.2 Using the Dedicated CPU Lock Manager (Alpha Only)

After the dedicated CPU processes the request, the status for the system service is returned to the process.

The Dedicated CPU Lock Manager is dynamic and can be turned off if there are no perceived benefits, such as a small number of CPUs or a small amount of locking activity. When the Dedicated CPU Lock Manager is turned off, the LCKMGR\_SERVER process is in a HIB (hibernate) state. The process may not be deleted once started.

#### 7.2.2 Enabling the Dedicated CPU Lock Manager

To use the Dedicated CPU Lock Manager, perform the following steps in order:

1. Enable the Dedicated CPU Lock Manager by doing the following:

Set the dynamic system parameter LCKMGR\_MODE to an appropriate value.

By default, LCKMGR\_MODE=0. When LCKMGR\_MODE=0, the Dedicated CPU Lock Manager is disabled. When LCKMGR\_MODE=1, the system behaves as if LCKMGR\_MODE=2. When LCKMGR\_MODE= $n$  (where  $n$  is between 2 and 255, inclusive),  $n$  denotes the minimum number of active CPUs required to enable the Dedicated CPU Lock Manager. When there are at least  $n$  active CPUs in the current system, the system automatically enables the Dedicated CPU Lock Manager.

2. Activate the Dedicated CPU Lock Manager by starting the LCKMGR\_SERVER process by entering the following command:

```
$RUN SYS$SYSTEM:LCKMGR_SERVER
```

This command creates a detached process named LCKMGR\_SERVER. LCKMGR\_SERVER runs whenever the Dedicated CPU Lock Manager is enabled. While running, it performs the operations of the Dedicated CPU Lock Manager. If the number of active CPUs present drops below  $n$ , the system automatically disables the Dedicated CPU Lock Manager. As a result, LCKMGR\_SERVER hibernates at the latest within 1 second. You can deactivate the CPU with a STOP/CPU command or with a Galaxy CPU reassignment operation.

When the number of active CPUs becomes at least  $n$ , the system re-enables the Dedicated CPU Lock Manager. When this occurs, LCKMGR\_SERVER awakens and resumes running.

#### 7.2.3 Using the Dedicated CPU Lock Manager With Affinity

The LCKMGR\_SERVER process uses the affinity mechanism to set the process to the lowest CPU ID other than the primary. This can be changed by the dynamic system parameter LOCKMGR\_CPU by placing a CPU ID there. The Dedicated CPU Lock Manager then attempts to use this CPU. If this CPU is not available, it reverts back to the lowest CPU other than the primary.

The following shows how to change the CPU used by the LCKMGR\_SERVER process:

```
$RUN SYS$SYSTEM:SYSGEN
SYSGEN>USE ACTIVE
SYSGEN>SET LOCKMGR_CPU 2
SYSGEN>WRITE ACTIVE
SYSGEN>EXIT
```

## Synchronizing Access to Resources

### 7.2 Using the Dedicated CPU Lock Manager (Alpha Only)

To verify the CPU dedicated to the lock manager, use the following show system command:

```
$ SHOW SYSTEM/PROCESS=LCKMGR_SERVER
OpenVMS V7.3 on node JYGAL 24-OCT-2000 10:10:11.31 Uptime 3 20:16:56
  Pid      Process Name      State Pri      I/O      CPU      Page flts  Pages
4CE0021C LCKMGR_SERVER      CUR  2  63      9  3 20:15:47.78      70      84
```

Note that under the State field, it shows the process is currently running on CPU 2.

Compaq highly recommends that a process not be given hard affinity to the CPU used by the Dedicated CPU Lock Manager. With hard affinity when such a process becomes computable, it cannot obtain any CPU time, because the LCKMGR\_SERVER process is running at the highest possible real-time priority of 63. However, the LCKMGR\_SERVER detects once per second if there are any computable processes that are set by the affinity mechanism to the dedicated lock manager CPU. If so, the LCKMGR\_SERVER switches to a different CPU for one second to allow the waiting process to run.

#### 7.2.4 Using the Dedicated CPU Lock Manager with Fast Path Devices

OpenVMS Version 7.3 and higher supports Fast Path for SCSI and Fibre Channel Controllers along with the existing support of CIPCA adapters. The Dedicated CPU Lock Manager supports both the LCKMGR\_SERVER process and Fast Path devices on the same CPU. However, this may not produce optimal performance.

Compaq thus recommends that the CPU used by the LCKMGR\_SERVER process not have any Fast Path devices. This can be accomplished in the following ways:

1. Since the default behavior for the LCKMGR\_SERVER process is to run on the first available nonprimary CPU, this CPU could be eliminated as an available Fast Path CPU. To do so, the bit associated with the CPU ID would be cleared from the IO\_PREFER\_CPUS SYSGEN parameter.

For example, your system has eight CPUs with CPU IDs from 0 to 7 and four SCSI adapters that will use Fast Path. Clearing bit 1 from IO\_PREFER\_CPUS would result in the 4 SCSI devices being bound to CPUs 2, 3, 4, and 5. CPU 1, which is the default CPU the lock manager will use, will not have any Fast Path devices.

2. By implementing the LOCKMGR\_CPU system parameter, the LCKMGR\_SERVER process can be told to use a CPU other than the default. For the above example, setting this system parameter to 7 would result in the LCKMGR\_SERVER process running on CPU 7. The Fast Path devices would by default be bound to CPUs 1, 2, 3, and 4.

#### 7.2.5 Using the Dedicated CPU Lock Manager on the AlphaServer GS Series Systems

The AlphaServer GS Series Systems (GS80, GS160, and the GS320) have NUMA memory characteristics. When using the Dedicated CPU Lock Manager on one of these systems, the best performance is obtained by utilizing a CPU and memory from within a single Quad Building Block (QBB).

The Dedicated CPU Lock Manager does not yet have the ability to decide from where QBB memory should be allocated. However, there is a method to preallocate lock manager memory from the low QBB. This can be done with the LOCKIDTBL system parameter. This system parameter indicates the initial size of the Lock ID Table, along with the initial amount of memory to preallocate for lock manager data structures.

## Synchronizing Access to Resources

### 7.2 Using the Dedicated CPU Lock Manager (Alpha Only)

To preallocate the proper amount of memory, this system parameter should be set to the highest number of locks plus resources on the system. The command `MONITOR LOCK` can provide this information. If `MONITOR` indicates the system has 100,000 locks and 50,000 resources, then setting `LOCKIDTBL` to the sum of these two values will ensure that enough memory is initially allocated. Adding in some additional overhead may also be beneficial. Setting `LOCKIDTBL` to 200,000 thus might be appropriate.

If necessary, use the `LOCKMGR_CPU` system parameter to help ensure that the `LCKMGR_SERVER` runs on a CPU in the low `QBB`.

### 7.3 Concepts of Resources and Locks

A resource can be any entity on the operating system (for example, files, data structures, databases, or executable routines). When two or more processes access the same resource, you often need to control their access to the resource. You do not want to have one process reading the resource while another process writes new data, because a writer can quickly invalidate anything being read by a reader. The lock management system services allow processes to associate a name with a resource and request access to that resource. Lock modes enable processes to indicate how they want to share access with other processes.

To use the lock management system services, a process must request access to a resource (request a lock) using the Enqueue Lock Request (`SYS$ENQ`) system service. The following three arguments to the `SYS$ENQ` system service are required for new locks:

- Resource name—The lock management services use the resource name to look for other lock requests that use the same name.
- Lock mode to be associated with the requested lock—The lock mode indicates how the process wants to share the resource with other processes.
- Address of a lock status block—The lock status block receives the completion status for a lock request and the lock identification. The lock identification refers to a lock request after it has been queued.

The lock management services compare the lock mode of the newly requested lock to the mode of other locks with the same resource name. New locks are granted in the following instances:

- If no other process has a lock on the resource.
- If another process has a lock on the resource and the mode of the new request is compatible with the existing lock.
- If another process already has a lock on the resource and the mode of the new request is not compatible with the lock mode of the existing lock, the new request is placed in a queue, where it waits until the resource becomes available. When the resource becomes available, the process is notified that the lock has been granted.

Processes can also use the `SYS$ENQ` system service to change the lock mode of a lock. This is called a **lock conversion**.

# Synchronizing Access to Resources

## 7.3 Concepts of Resources and Locks

### 7.3.1 Resource Granularity

Many resources can be divided into smaller parts. As long as a part of a resource can be identified by a resource name, the part can be locked. The term **resource granularity** describes the part of the resource being locked.

Figure 7–1 depicts a model of a database. The database is divided into areas, such as a file, which in turn are subdivided into records. The records are further divided into items.

**Figure 7–1 Model Database**

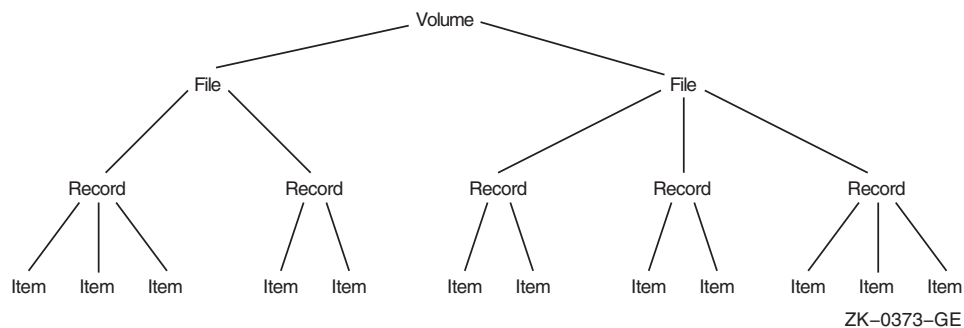

The processes that request locks on the database shown in Figure 7–1 may lock the whole database, an area in the database, a record, or a single item. Locking the entire database is considered locking at a **coarse granularity**; locking a single item is considered locking at a **fine granularity**.

In this example, overall access to the database can be represented by a root resource name. Access either to areas in the database or records within areas can be represented by sublocks.

Root resources consist of the following:

- Resource domain
- Resource name
- Access mode

Subresources consist of the following:

- Parent resource
- Resource name
- Access mode

### 7.3.2 Resource Domains

Because resource names are arbitrary names chosen by applications, one application may interfere (either intentionally or unintentionally) with another application. Unintentional interference can be easily avoided by careful design, such as by using a registered facility name as a prefix for all root resource names used by an application.



## Synchronizing Access to Resources

### 7.3 Concepts of Resources and Locks

Intentional interference can be prevented by using **resource domains**. A resource domain is a namespace for root resource names and is identified by a number. Resource domain 0 is used as a system resource domain. Usually, other resource domains are used by the UIC group corresponding to the domain number.

By using the `SYS$SET_RESOURCE_DOMAIN` system service, a process can gain access to any resource domain subject to normal operating system access control. By default, each resource domain allows read, write, and lock access by members of the corresponding UIC group. See the *OpenVMS Guide to System Security* for more information about access control.

#### 7.3.3 Resource Names

The lock management system services refer to each resource by a name composed of the following four parts:

- A name specified by the caller
- The caller's access mode
- The caller's UIC group number (unless the resource is systemwide)
- The identification of the lock's parent (optional)

For two resources to be considered the same, these four parts must be identical for each resource.

The name specified by the process represents the resource being locked. Other processes that need to access the resource must refer to it using the same name. The correlation between the name and the resource is a convention agreed upon by the cooperating processes.

The access mode is determined by the caller's access mode unless a less privileged mode is specified in the call to the `SYS$ENQ` system service. Access modes, their numeric values, and their symbolic names are discussed in the *OpenVMS Calling Standard*.

The default resource domain is selected by the UIC group number for the process. You can access the system domain by setting the `LCK$M_SYSTEM` when you request a new root lock. Other domains can be accessed using the optional `RSDM_ID` parameter to `SYS$ENQ`. You need the `SYSLCK` user privilege to request systemwide locks from user or supervisor mode. No additional privilege is required to request systemwide locks from executive or kernel mode.

When a lock request is queued, it can specify the identification of a parent lock, at which point it becomes a sublock (see Section 7.5.8). However, the parent lock must be granted, or the lock request is not accepted. This enables a process to lock a resource at different degrees of granularity.

#### 7.3.4 Choosing a Lock Mode

The mode of a lock determines whether the resource can be shared with other lock requests. Table 7–2 describes the six lock modes.

## Synchronizing Access to Resources

### 7.3 Concepts of Resources and Locks

Table 7–2 Lock Modes

Mode Name	Meaning
LCK\$K_NLMODE	Null mode. This mode grants no access to the resource. The null mode is typically used either as an indicator of interest in the resource or as a placeholder for future lock conversions.
LCK\$K_CRMODE	Concurrent read. This mode grants read access to the resource and allows sharing of the resource with other readers. The concurrent read mode is generally used either to perform additional locking at a finer granularity with sublocks or to read data from a resource in an “unprotected” fashion (allowing simultaneous writes to the resource).
LCK\$K_CWMODE	Concurrent write. This mode grants write access to the resource and allows sharing of the resource with other writers. The concurrent write mode is typically used to perform additional locking at a finer granularity, or to write in an “unprotected” fashion.
LCK\$K_PRMODE	Protected read. This mode grants read access to the resource and allows sharing of the resource with other readers. No writers are allowed access to the resource. This is the traditional “share lock.”
LCK\$K_PWMODE	Protected write. This mode grants write access to the resource and allows sharing of the resource with users at concurrent read mode. No other writers are allowed access to the resource. This is the traditional “update lock.”
LCK\$K_EXMODE	Exclusive. The exclusive mode grants write access to the resource and prevents the sharing of the resource with any other readers or writers. This is the traditional “exclusive lock.”

#### 7.3.5 Levels of Locking and Compatibility

Locks that allow the process to share a resource are called **low-level locks**; locks that allow the process almost exclusive access to a resource are called **high-level locks**. Null and concurrent read mode locks are considered low-level locks; protected write and exclusive mode locks are considered high-level. The lock modes, from lowest- to highest-level access, are:

- Null
- Concurrent read
- Concurrent write
- Protected read
- Protected write
- Exclusive

Note that the concurrent write and protected read modes are considered to be of the same level.

Locks that can be shared with other locks are said to have compatible lock modes. High-level lock modes are less compatible with other lock modes than are low-level lock modes. Table 7–3 shows the compatibility of the lock modes.

**Table 7–3 Compatibility of Lock Modes**

Mode of Requested Lock	Mode of Currently Granted Locks					
	NL	CR	CW	PR	PW	EX
NL	Yes	Yes	Yes	Yes	Yes	Yes
CR	Yes	Yes	Yes	Yes	Yes	No
CW	Yes	Yes	Yes	No	No	No
PR	Yes	Yes	No	Yes	No	No
PW	Yes	Yes	No	No	No	No
EX	Yes	No	No	No	No	No

**Key to Lock Modes:**

NL = Null  
 CR = Concurrent read  
 CW = Concurrent write  
 PR = Protected read  
 PW = Protected write  
 EX = Exclusive

### 7.3.6 Lock Management Queues

A lock on a resource can be in one of the following three states:

- **Granted**—The lock request has been granted.
- **Waiting**—The lock request is waiting to be granted.
- **Conversion**—The lock request has been granted at one mode and is waiting to be granted a high-level lock mode.

A queue is associated with each of the three states (see Figure 7–2).

When you request a new lock, the lock management services first determine whether the resource is currently known (that is, if any other processes have locks on that resource). If the resource is new (that is, if no other locks exist on the resource), the lock management services create an entry for the new resource and the requested lock. If the resource is already known, the lock management services determine whether any other locks are waiting in either the conversion or the waiting queue. If other locks are waiting in either queue, the new lock request is queued at the end of the waiting queue. If both the conversion and waiting queues are empty, the lock management services determine whether the new lock is compatible with the other granted locks. If the lock request is compatible, the lock is granted; if it is not compatible, it is placed in the waiting queue. You can use a flag bit to direct the lock management services not to queue a lock request if one cannot be granted immediately.

## Synchronizing Access to Resources

### 7.3 Concepts of Resources and Locks

Figure 7–2 Three Lock Queues

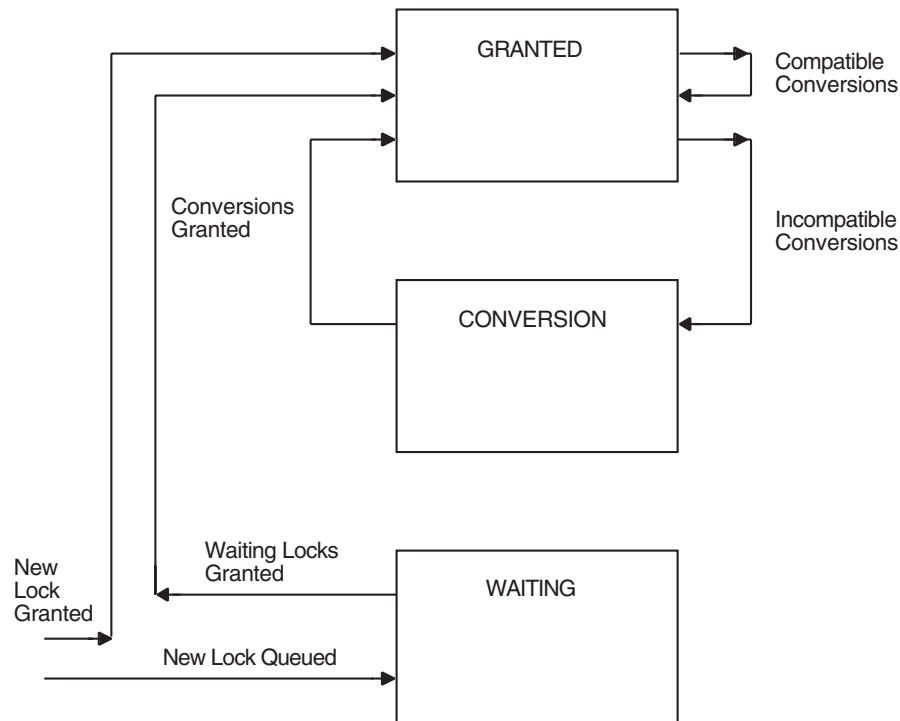

ZK-0374-GE

#### 7.3.7 Concepts of Lock Conversion

Lock conversions allow processes to change the level of locks. For example, a process can maintain a low-level lock on a resource until it limits access to the resource. The process can then request a lock conversion.

You specify lock conversions by using a flag bit (see Section 7.5.6) and a lock status block. The lock status block must contain the lock identification of the lock to be converted. If the new lock mode is compatible with the currently granted locks, the conversion request is granted immediately. If the new lock mode is incompatible with the existing locks in the granted queue, the request is placed in the conversion queue. The lock retains its old lock mode and does not receive its new lock mode until the request is granted.

When a lock is dequeued or is converted to a lower-level lock mode, the lock management services inspect the first conversion request on the conversion queue. The conversion request is granted if it is compatible with the locks currently granted. Any compatible conversion requests immediately following are also granted. If the conversion queue is empty, the waiting queue is checked. The first lock request on the waiting queue is granted if it is compatible with the locks currently granted. Any compatible lock requests immediately following are also granted.

### 7.3.8 Deadlock Detection

A deadlock occurs when any group of locks are waiting for each other in a circular fashion.

In Figure 7–3, three processes have queued requests for resources that cannot be accessed until the current locks held are dequeued (or converted to a lower lock mode).

Figure 7–3 Deadlock

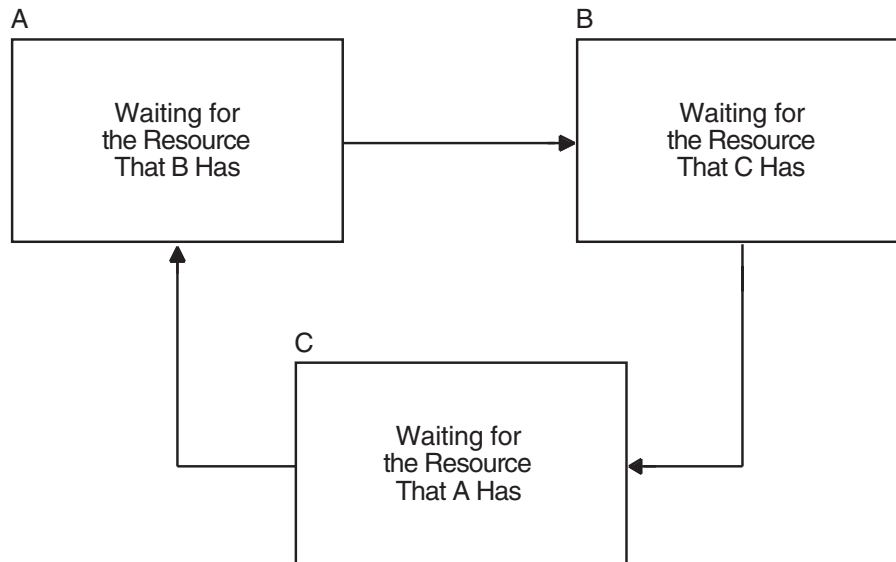

ZK-0375-GE

If the lock management services determine that a deadlock exists, the services choose a process to break the deadlock. The chosen process is termed the **victim**. If the victim has requested a new lock, the lock is not granted; if the victim has requested a lock conversion, the lock is returned to its old lock mode. In either case, the status code `SS$_DEADLOCK` is placed in the lock status block. Note that granted locks are never revoked; only waiting lock requests can receive the status code `SS$_DEADLOCK`.

---

**Note**

---

Programmers must not make assumptions regarding which process is to be chosen to break a deadlock.

---

### 7.3.9 Lock Quotas and Limits

The OpenVMS lock manager was modified for OpenVMS Version 7.1. Some internal restrictions on the number of locks and resources available on the system have been eased and a method to allow enqueue limit quota (ENQLM) of greater than 32767 has been added. No changes were made to the interface and no programming changes to applications are required to take advantage of these changes.

## Synchronizing Access to Resources

### 7.3 Concepts of Resources and Locks

While most processes do not require very many locks simultaneously (typically fewer than 100), large scale database or server applications can easily exceed this threshold.

Specifically, the OpenVMS lock manager includes the following enhancements:

- ENQLM greater than 32767 allowed
- Sub-resources and sub-locks greater than 65535 allowed
- Resource hash table greater than 65535 allowed
- LOCKIDTBL size restrictions removed (LOCKIDTBL\_MAX obsolete)

If you set an ENQLM value of 32767 in the SYSUAF, the operating system treats it as no limit and allows an application to own up to 16,776,959 locks, the architectural maximum of the OpenVMS lock manager. The following sections describe these features in more detail.

#### 7.3.9.1 Enqueue Limit Quota (ENQLM)

Before the release of OpenVMS Version 7.1, the previous limit for the total number of locks a single process could own was 32767. This limit was enforced unless the process ran in a privileged mode and used the NOQUOTA flag. Further attempts to acquire locks would result in an error (SS\$\_EXQUOTA). Because applications generally use the lock manager for internal synchronization, this error was usually fatal to the application. While most processes do not require very many locks simultaneously (typically fewer than 100), large scale database or server applications can easily exceed this threshold.

Now with the release of OpenVMS Version V7.1, an ENQLM value of 32767 in a user's SYSUAF record is treated as if there is no quota limit for that user. This means that the user is allowed to own up to 16,776,959 locks, the architectural maximum of the OpenVMS lock manager.

The current maximum SYSUAF ENQLM value of 32767 is not treated as a limit. Instead, when a process is created that reads ENQLM from the SYSUAF, if the value in the SYSUAF is 32767, it is automatically extended to the new maximum. The Create Process (SYS\$CREPRC) system service has been modified to allow large quotas to be passed on to the target process. Therefore, a process can be created with an arbitrary ENQLM of any value up to the new maximum if it is initialized from a process with the SYSUAF quota of 32767.

The behavior of the process quota and creation limit (PQL) parameters for the default and minimum ENQLM quotas for detached processes has not changed. The default SYSGEN values for the parameters have been raised accordingly.

#### 7.3.9.2 Sub-Resources and Sub-Locks

The previous maximum value for the number of sub-resources or sub-locks in a resource or lock tree (parent/children relationships) was 65535. The internal structures were reorganized from word to longword counters, which can handle sub-resource and sub-lock counts up to the current architectural limits of the lock manager. No programming or interface changes were made. As a result, SS\$\_EXDEPTH errors no longer occur for exceeding the sub-locks or sub-resources limit.

The maximum number of locks on a single resource is limited to 65,535. If your program attempts to exceed this limit, SS\$\_EXDEPTH will still be returned.

## Synchronizing Access to Resources

### 7.3 Concepts of Resources and Locks

In a mixed-version OpenVMS Cluster, only nodes running OpenVMS Version 7.1 or higher are able to handle these large lock trees. Large scale locking applications should be restricted to running on a subset of nodes running OpenVMS Version 7.1, or the entire cluster should be upgraded to OpenVMS Version 7.1 to avoid unpredictable results.

#### 7.3.9.3 Resource Hash Table

The resource hash table is an internal OpenVMS lock manager structure used to do quick lookups on resource names without a lengthy interactive search. Like all such tables, it results in a tradeoff of consuming memory in order to speed operation. A typical tuning goal is to have the resource hash table size (RESHASHTBL system parameter) about four times larger than the total number of resources in use on the system. Systems that have memory constraints or are not critically dependent on locking speed could set the table to a smaller size.

Previously, the limit for the RESHASHTBL was 65535, based on both the word field used for the parameter and the algorithm used to develop the hash index. This limit has been removed. The new maximum for the RESHASHTBL is 16,777,216 ( $2^{24}$ ), which is the current architectural maximum for the total number of resources possible on the system.

No external changes are apparent from this modification. Large memory systems that use very large resource namespaces can take advantage of this change to gain a performance advantage in many locking operations. There is no mixed-version OpenVMS Cluster impact related to this change.

#### 7.3.9.4 LOCKIDTBL System Parameter

The lock ID table is an internal OpenVMS lock manager structure used to find the relevant data structures for any given lock in the system. On OpenVMS Alpha, the lock ID table is allowed to expand up to the LOCKIDTBL\_MAX system parameter limit. When the table is filled with current locks, the lock request is rejected with an error of SS\$\_NOLOCKID. This usually results in a system failure (LCKMGRERR bugcheck) as soon as a privileged system application receives such an error.

On OpenVMS VAX, however, this behavior was modified to allow for continued expansion of the lock ID table and was not constrained by LOCKIDTBL\_MAX, as on OpenVMS Alpha.

With OpenVMS Version 7.1, both Alpha and VAX platforms dynamically increase the lock ID table as usage requires and if sufficient physical memory is available. The default, minimum, and maximum values for the LOCKIDTBL system parameter now allow large single tables for lock IDs. The maximum number of locks is now regulated by the amount of available nonpaged pool instead of by both nonpaged pool and the LOCKIDTBL\_MAX system parameter.

The LOCKIDTBL\_MAX parameter is now obsolete. In its place, an appropriate maximum value based on the total available memory is calculated at boot time and stored as the value for the parameter. Inputs (via MODPARAMS or SYSGEN) are ignored.

In addition, the lock ID table itself is now located in S2 space for OpenVMS Alpha, to avoid using large amounts of S0 space in large memory systems.

There are no visible changes for these modifications.

## Synchronizing Access to Resources

### 7.4 Queuing Lock Requests

### 7.4 Queuing Lock Requests

You use the SYS\$ENQ or SYS\$ENQW system service to queue lock requests. SYS\$ENQ queues a lock request and returns; SYS\$ENQW queues a lock request, waits until the lock is granted, and then returns. When you request new locks, the system service call must specify the lock mode, address of the lock status block, and resource name.

The format for SYS\$ENQ and SYS\$ENQW is as follows:

```
SYS$ENQ(W) ([efn] ,lkmode ,lksb ,[flags] ,[resnam] ,[parid] ,[astadr]  
           ,[astprm] ,[blkast] ,[acmode] ,[rsdm_id] ,[nullarg])
```

The following example illustrates a call to SYS\$ENQW:

```
#include <stdio.h>  
#include <descrip.h>  
#include <lckdef.h>  
  
/* Declare a lock status block */  
struct lock_blk {  
    unsigned short  condition,reserved;  
    unsigned int    lock_id;  
}lksb;  
  
.  
.  
.  
    unsigned int    status, lkmode=LCK$K_PMODE;  
    $DESCRIPTOR(resource,"STRUCTURE_1");  
  
/* Queue a request for protected read mode lock */  
status = SYS$ENQW(0,      /* efn - event flag */  
                 lkmode,  /* lkmode - lock mode requested */  
                 &lksb,   /* lksb - lock status block */  
                 0,      /* flags */  
                 &resource, /* resnam - name of resource */  
                 0,      /* parid - parent lock id */  
                 0,      /* astadr - AST routine */  
                 0,      /* astprm - AST parameter */  
                 0,      /* blkast - blocking AST */  
                 0,      /* acmode - access mode */  
                 0);     /* rsdm_id - resource domain id */  
  
}
```

In this example, a number of processes access the STRUCTURE\_1 data structure. Some processes read the data structure; others write to the structure. Readers must be protected from reading the structure while it is being updated by writers. The reader in the example queues a request for a protected read mode lock. Protected read mode is compatible with itself, so all readers can read the structure at the same time. A writer to the structure uses protected write or exclusive mode locks. Because protected write mode and exclusive mode are not compatible with protected read mode, no writers can write the data structure until the readers have released their locks, and no readers can read the data structure until the writers have released their locks.

Table 7-3 shows the compatibility of lock modes.



### 7.4.1 Example of Requesting a Null Lock

The program segment in Example 7–1 requests a null lock for the resource named `TERMINAL`. After the lock is granted, the program requests that the lock be converted to an exclusive lock. Note that, after `SYS$ENQW` returns, the program checks the status of the system service and the status returned in the lock status block to ensure that the request completed successfully. (The lock mode symbols are defined in the `$LCKDEF` module of the system macro library.)

#### Example 7–1 Requesting a Null Lock

```
! Define lock modes
INCLUDE '($LCKDEF)'
! Define lock status block
STRUCTURE /STATUS_BLOCK/
  INTEGER*2 LOCK_STATUS,
  2      NULL_
  INTEGER*4 LOCK_ID
END STRUCTURE
RECORD /STATUS_BLOCK/ IOSTATUS
.
.
! Request a null lock
STATUS = SYS$ENQW (,
2      %VAL(LCK$K_NLMODE),
2      IOSTATUS,
2      '
2      'TERMINAL',
2      , , , , )
IF (.NOT. STATUS) CALL LIB$SIGNAL (%VAL(STATUS))
IF (.NOT. IOSTATUS.LOCK STATUS)
2  CALL LIB$SIGNAL (%VAL(IOSTATUS.LOCK_STATUS))
! Convert the lock to an exclusive lock
STATUS = SYS$ENQW (,
2      %VAL(LCK$K_EXMODE),
2      IOSTATUS,
2      %VAL(LCK$M_CONVERT),
2      'TERMINAL',
2      , , , , )
IF (.NOT. STATUS) CALL LIB$SIGNAL (%VAL(STATUS))
IF (.NOT. IOSTATUS.LOCK STATUS)
2  CALL LIB$SIGNAL (%VAL(IOSTATUS.LOCK_STATUS))
```

For more complete information on the use of `SYS$ENQ`, refer to the *OpenVMS System Services Reference Manual*.

## 7.5 Advanced Locking Techniques

The previous sections discuss locking techniques and concepts that are useful to all applications. The following sections discuss specialized features of the lock manager.

## Synchronizing Access to Resources

### 7.5 Advanced Locking Techniques

#### 7.5.1 Synchronizing Locks

The `SYS$ENQ` system service returns control to the calling program when the lock request is queued. The status code in `R0` indicates whether the request was queued successfully. After the request is queued, the procedure cannot access the resource until the request is granted. A procedure can use three methods to check that a request has been granted:

- Specify the number of an event flag to be set when the request is granted, and wait for the event flag.
- Specify the address of an AST routine to be executed when the request is granted.
- Poll the lock status block for a return status code that indicates that the request has been granted.

These methods of synchronization are identical to the synchronization techniques used with the `SYS$QIO` system services (described in Chapter 23).

The `$ENQW` macro performs synchronization by combining the functions of the `SYS$ENQ` system service and the Synchronize (`SYS$SYNCH`) system service. The `$ENQW` macro has the same arguments as the `$ENQ` macro. It queues the lock request and then places the program in an event flag wait state (LEF) until the lock request is granted.

#### 7.5.2 Notification of Synchronous Completion

The lock management services provide a mechanism that allows processes to determine whether a lock request is granted synchronously, that is, if the lock is not placed on the conversion or waiting queue. This feature can be used to improve performance in applications where most locks are granted synchronously (as is normally the case).

If the flag bit `LCK$M_SYNCSTS` is set and a lock is granted synchronously, the status code `SS$_SYNCH` is returned in `R0`; no event flag is set, and no AST is delivered.

If the request is not completed synchronously, the success code `SS$_NORMAL` is returned; event flags or AST routines are handled normally (that is, the event flag is set, and the AST is delivered when the lock is granted).

#### 7.5.3 Expediting Lock Requests

A request can be expedited (granted immediately) if its requested mode, when granted, does not block any currently queued requests from being granted. The `LCK$M_EXPEDITE` flag is specified in the `SYS$ENQ` operation to expedite a request. Currently, only `NLMODE` requests can be expedited. A request to expedite any other lock mode fails with `SS$_UNSUPPORTED` status.

#### 7.5.4 Lock Status Block

The lock status block receives the final completion status and the lock identification, and optionally contains a lock value block (see Figure 7-4). When a request is queued, the lock identification is stored in the lock status block even if the lock has not been granted. This allows a procedure to dequeue locks that have not been granted. For more information about the Dequeue Lock Request (`SYS$DEQ`) system service, see Section 7.6.

**Figure 7–4 Lock Status Block**

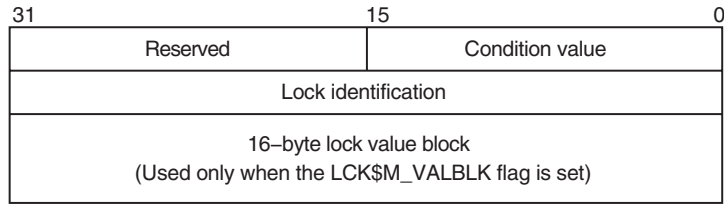

ZK–1708–GE

The status code is placed in the lock status block either when the lock is granted or when errors occur in granting the lock.

The uses of the lock value block are described in Section 7.7.1.

### 7.5.5 Blocking ASTs

In some applications that use the lock management services, a process must know whether it is preventing another process from locking a resource. The lock management services inform processes of this through the use of blocking ASTs. When the lock prevents another lock from being granted, the blocking routine is delivered as an AST to the process. Blocking ASTs are not delivered when the state of the lock is either Conversion or Waiting.

To enable blocking ASTs, the **blkast** argument of the SYS\$ENQ system service must contain the address of a blocking AST service routine. The **astprm** argument passes a parameter to the blocking AST. For more information about ASTs and AST service routines, see Chapter 8. Some uses of blocking ASTs are also described in that chapter.

### 7.5.6 Lock Conversions

Lock conversions perform three main functions:

- Maintaining a low-level lock and converting it to a higher lock mode when necessary
- Maintaining values stored in a resource lock value block (described in the following paragraphs)
- Improving performance in some applications

A procedure normally needs an exclusive (or protected write) mode lock while writing data. The procedure should not keep the resource exclusively locked all the time, however, because writing might not always be necessary. Maintaining an exclusive or protected write mode lock prevents other processes from accessing the resource. Lock conversions allow a process to request a low-level lock at first and convert the lock to a high-level lock mode (protected write mode, for example) only when it needs to write data.

Some applications of locks require the use of the lock value block. If a version number or other data is maintained in the lock value block, you need to maintain at least one lock on the resource so that the value block is not lost. In this case, processes convert their locks to null locks, rather than dequeuing them when they have finished accessing the resource.

## Synchronizing Access to Resources

### 7.5 Advanced Locking Techniques

To improve performance in some applications, all resources that might be locked are locked with null locks during initialization. You can convert the null locks to higher-level locks as needed. Usually a conversion request is faster than a new lock request because the necessary data structures have already been built. However, maintaining any lock for the life of a procedure uses system dynamic memory. Therefore, the approach of creating all necessary locks as null locks and converting them as needed improves performance at the expense of increased storage requirements.

---

#### Note

---

If you specify the flag bit `LCK$M_NOQUEUE` on a lock conversion and the conversion fails, the new blocking AST address and parameter specified in the conversion request replace the blocking AST address and parameter specified in the previous `SYS$ENQ` request.

---

#### Queuing Lock Conversions

To perform a lock conversion, a procedure calls the `SYS$ENQ` system service with the flag bit `LCK$M_CONVERT`. Lock conversions do not use the **resnam**, **parid**, **acmode**, or **prot** argument. The lock being converted is identified by the lock identification contained in the lock status block. The following program shows a simple lock conversion. Note that the lock must be granted before it can be converted.

```
#include <stdio.h>
#include <descrip.h>
#include <lckdef.h>

/* Declare a lock status block */
struct lock_blk {
    unsigned short lkstat, reserved;
    unsigned int lock_id;
}lksb;

.
.
.
    unsigned int status, lkmode, flags;
    $DESCRIPTOR(resource,"STRUCTURE_1");
.
.
.
    lkmode = LCK$K_NLMODE;

/* Queue a request for protected read mode lock */
    status = SYS$ENQW(0, /* efn - event flag */
        lkmode, /* lkmode - lock mode */
        &lksb, /* lksb - lock status block */
        0, /* flags */
        &resource, /* resnam - name of resource */
        0, 0, 0, 0, 0, 0);

.
.
.
    lkmode = LCK$K_PWMODE;
    flags = LCK$M_CONVERT;
```

## Synchronizing Access to Resources

### 7.5 Advanced Locking Techniques

```

/* Queue a request for protected write mode lock */
status = SYS$ENQW(0, /* efn - event flag */
                 lkmode, /* lkmode - lock mode */
                 &lksb, /* lksb - lock status block */
                 flags, /* flags */
                 0, 0, 0, 0, 0, 0, 0);
.
.
.
}

```

#### 7.5.7 Forced Queuing of Conversions

It is possible to force certain conversions to be queued that would otherwise be granted. A conversion request with the LCK\$M\_QUECVT flag set is forced to wait behind any already queued conversions.

The conversion request is granted immediately if no conversions are already queued.

The QUECVT behavior is valid only for a subset of all possible conversions. Table 7-4 defines the legal set of conversion requests for LCK\$M\_QUECVT. Illegal conversion requests fail with SS\$\_BADPARAM returned.

**Table 7-4 Legal QUECVT Conversions**

Lock Mode at Which Lock Is Held	Lock Mode to Which Lock Is Converted					
	NL	CR	CW	PR	PW	EX
NL	No	Yes	Yes	Yes	Yes	Yes
CR	No	No	Yes	Yes	Yes	Yes
CW	No	No	No	Yes	Yes	Yes
PR	No	No	Yes	No	Yes	Yes
PW	No	No	No	No	No	Yes
EX	No	No	No	No	No	No

**Key to Lock Modes:**

NL = Null  
 CR = Concurrent read  
 CW = Concurrent write  
 PR = Protected read  
 PW = Protected write  
 EX = Exclusive

#### 7.5.8 Parent Locks

When a lock request is queued, you can declare a parent lock for the new lock. A lock that has a parent is called a **sublock**. To specify a parent lock, the lock identification of the parent lock is passed in the **parid** argument to the SYS\$ENQ system service. A parent lock must be granted before the sublocks belonging to the parent can be granted.

The benefits of specifying parent locks are as follows:

- Low-level locks (concurrent read or concurrent write) such as files can be held at a coarse granularity; whereas high-level (protected write or exclusive mode) sublocks such as records or data items are held on resources of a finer granularity.

## Synchronizing Access to Resources

### 7.5 Advanced Locking Techniques

- Resource names are unique with each parent; parent locks are part of the resource name.

The following paragraphs describe the use of parent locks.

Assume that a number of processes need to access a database. The database can be locked at two levels: the file and individual records. For updating all the records in a file, locking the whole file and updating the records without additional locking is faster and more efficient. But for updating selected records, locking each record as it is needed is preferable.

To use parent locks in this way, all processes request locks on the file. Processes that need to update all records must request protected write or exclusive mode locks on the file. Processes that need to update individual records request concurrent write mode locks on the file and then use sublocks to lock the individual records in protected write or exclusive mode.

In this way, the processes that need to access all records can do so by locking the file, while processes that share the file can lock individual records. A number of processes can share the file-level lock at concurrent write mode while their sublocks update selected records.

On VAX systems, the number of levels of sublocks is limited by the size of the interrupt stack. If the limit is exceeded, the error status `SS$_EXDEPTH` is returned. The size of the interrupt stack is controlled by the `SYSGEN` parameter `INTSTKPAGES`. The default value for `INTSTKPAGES` allows 32 levels of sublocks. For more information about `SYSGEN` and `INTSTKPAGES`, see the *OpenVMS System Manager's Manual*.

On Alpha systems, the number of levels of sublocks is fixed at 127. If that limit is exceeded, the error status `SS$_EXDEPTH` is returned.

#### 7.5.9 Lock Value Blocks

The lock value block is an optional, 16-byte extension of a lock status block. The first time a process associates a lock value block with a particular resource, the lock management services create a resource lock value block for that resource. The lock management services maintain the resource lock value block until there are no more locks on the resource.

To associate a lock value block with a resource, the process must set the flag bit `LCK$_M_VALBLK` in calls to the `SY$_ENQ` system service. The lock status block **lksb** argument must contain the address of the lock status block for the resource.

When a process sets the flag bit `LCK$_M_VALBLK` in a lock request (or conversion request) and the request (or conversion) is granted, the contents of the resource lock value block are written to the lock value block of the process.

When a process sets the flag bit `LCK$_M_VALBLK` on a conversion from protected write or exclusive mode to an equal or lower mode, the contents of the process's lock value block are stored in the resource lock value block.

In this manner, processes can pass the value in the lock value block along with the ownership of a resource.

Table 7-5 shows how lock conversions affect the contents of the process's and the resource's lock value block.

## Synchronizing Access to Resources 7.5 Advanced Locking Techniques

**Table 7–5 Effect of Lock Conversion on Lock Value Block**

Lock Mode at Which Lock Is Held	Lock Mode to Which Lock Is Converted					
	NL	CR	CW	PR	PW	EX
NL	Return	Return	Return	Return	Return	Return
CR	Neither	Return	Return	Return	Return	Return
CW	Neither	Neither	Return	Return	Return	Return
PR	Neither	Neither	Neither	Return	Return	Return
PW	Write	Write	Write	Write	Write	Return
EX	Write	Write	Write	Write	Write	Write

**Key to Lock Modes:**

NL—Null  
 CR—Concurrent read  
 CW—Concurrent write  
 PR—Protected read  
 PW—Protected write  
 EX—Exclusive

**Key to Effects:**

Return—The contents of the resource lock value block are returned to the lock value block of the process.  
 Neither—The lock value block of the process is not written; the resource lock value block is not returned.  
 Write—The contents of the process's lock value block are written to the resource lock value block.

Note that when protected write or exclusive mode locks are dequeued using the Dequeue Lock Request (SYS\$DEQ) system service and the address of a lock value block is specified in the **valblk** argument, the contents of that lock value block are written to the resource lock value block.

## 7.6 Dequeuing Locks

When a process no longer needs a lock on a resource, you can dequeue the lock by using the Dequeue Lock Request (SYS\$DEQ) system service. Dequeuing locks means that the specified lock request is removed from the queue it is in. Locks are dequeued from any queue: Granted, Waiting, or Conversion (see Section 7.3.6). When the last lock on a resource is dequeued, the lock management services delete the name of the resource from its data structures.

The four arguments to the SYS\$DEQ macro (**lkid**, **valblk**, **acmode**, and **flags**) are optional. The **lkid** argument allows the process to specify a particular lock to be dequeued, using the lock identification returned in the lock status block.

The **valblk** argument contains the address of a 16-byte lock value block. If the lock being dequeued is in protected write or exclusive mode, the contents of the lock value block are stored in the lock value block associated with the resource. If the lock being dequeued is in any other mode, the lock value block is not used. The lock value block can be used only if a particular lock is being dequeued.

Three flags are available:

- **LCK\$M\_DEQUALL**—The LCK\$M\_DEQUALL flag indicates that all locks of the access mode specified with the **acmode** argument and less privileged access modes are to be dequeued. The access mode is maximized with the

## Synchronizing Access to Resources

### 7.6 Dequeuing Locks

access mode of the caller. If the flag `LCK$M_DEQALL` is specified, then the `lkid` argument must be 0 (or not specified).

- `LCK$M_CANCEL`—When `LCK$M_CANCEL` is specified, `SYS$DEQ` attempts to cancel a lock conversion request that was queued by `SYS$ENQ`. This attempt can succeed only if the lock request has not yet been granted, in which case the request is in the conversion queue. The `LCK$M_CANCEL` flag is ignored if the `LCK$M_DEQALL` flag is specified. For more information about the `LCK$M_CANCEL` flag, see the description of the `SYS$DEQ` service in the *OpenVMS System Services Reference Manual*.
- `LCK$M_INVVALBLK`—When `LCK$M_INVVALBLK` is specified, `$DEQ` marks the lock value block, which is maintained for the resource in the lock database, as invalid. See the descriptions of `SYS$DEQ` and `SYS$ENQ` in the *OpenVMS System Services Reference Manual* for more information about the `LCK$M_INVVALBLK` flag.

The following is an example of dequeuing locks:

```
#include <stdio.h>
#include <descrip.h>
#include <lckdef.h>

/* Declare a lock status block */
struct lock_blk {
    unsigned short lkstat ,reserved;
    unsigned int lock_id;
}lksb;

.
.
.
void read_updates();
unsigned int status, lkmode=LCK$K_CRMODE, lkid;
$DESCRIPTOR(resnam,"STRUCTURE_1"); /* resource */

/* Queue a request for concurrent read mode lock */
status = SYS$ENQW(0, /* efn - event flag */
                 lkmode, /* lkmode - lock mode */
                 &lksb, /* lksb - lock status block */
                 0, /* flags */
                 &resnam, /* resnam - name of resource */
                 0, /* parid - lock id of parent */
                 &read_updates, /* astadr - AST routine */
                 0, 0, 0, 0);
if((status & 1) != 1)
    LIB$SIGNAL(status);

.
.
.
lkid = lksb.lock_id;
status = SYS$DEQ(lkid, /* lkid - id of lock to be dequeued */
                0, 0, 0);
if((status & 1) != 1)
    LIB$SIGNAL(status);
}
```

User-mode locks are automatically dequeued when the image exits.



## **7.7 Local Buffer Caching with the Lock Management Services**

The lock management services provide methods for applications to perform **local buffer caching** (also called distributed buffer management). Local buffer caching allows a number of processes to maintain copies of data (disk blocks, for example) in buffers local to each process and to be notified when the buffers contain invalid data because of modifications by another process. In applications where modifications are infrequent, substantial I/O can be saved by maintaining local copies of buffers. You can use either the lock value block or blocking ASTs (or both) to perform buffer caching.

### **7.7.1 Using the Lock Value Block**

To support local buffer caching using the lock value block, each process maintaining a cache of buffers maintains a null mode lock on a resource that represents the current contents of each buffer. (For this discussion, assume that the buffers contain disk blocks.) The value block associated with each resource is used to contain a disk block “version number.” The first time a lock is obtained on a particular disk block, the current version number of that disk block is returned in the lock value block of the process. If the contents of the buffer are cached, this version number is saved along with the buffer. To reuse the contents of the buffer, the null lock must be converted to protected read mode or exclusive mode, depending on whether the buffer is to be read or written. This conversion returns the latest version number of the disk block. The version number of the disk block is compared with the saved version number. If they are equal, the cached copy is valid. If they are not equal, a fresh copy of the disk block must be read from disk.

Whenever a procedure modifies a buffer, it writes the modified buffer to disk and then increments the version number before converting the corresponding lock to null mode. In this way, the next process that attempts to use its local copy of the same buffer finds a version number mismatch and must read the latest copy from disk rather than use its cached (now invalid) buffer.

### **7.7.2 Using Blocking ASTs**

Blocking ASTs notify processes with granted locks that another process with an incompatible lock mode has been queued to access the same resource.

Blocking ASTs support local buffer caching in two ways. One technique involves deferred buffer writes; the other technique is an alternative method of local buffer caching without using value blocks.

#### **7.7.2.1 Deferring Buffer Writes**

When local buffer caching is being performed, a modified buffer must be written to disk before the exclusive mode lock can be released. If a large number of modifications are expected (particularly over a short period of time), you can reduce disk I/O by both maintaining the exclusive mode lock for the entire time that the modifications are being made and by writing the buffer once. However, this prevents other processes from using the same disk block during this interval. This problem can be avoided if the process holding the exclusive mode lock has a blocking AST. The AST notifies the process if another process needs to use the same disk block. The holder of the exclusive mode lock can then write the buffer to disk and convert its lock to null mode (thereby allowing the other process to access the disk block). However, if no other process needs the same disk block, the first process can modify it many times but write it only once.

## Synchronizing Access to Resources

### 7.7 Local Buffer Caching with the Lock Management Services

#### 7.7.2.2 Buffer Caching

To perform local buffer caching using blocking ASTs, processes do not convert their locks to null mode from protected read or exclusive mode when finished with the buffer. Instead, they receive blocking ASTs whenever another process attempts to lock the same resource in an incompatible mode. With this technique, processes are notified that their cached buffers are invalid as soon as a writer needs the buffer, rather than the next time the process tries to use the buffer.

#### 7.7.3 Choosing a Buffer-Caching Technique

The choice between using either version numbers or blocking ASTs to perform local buffer caching depends on the characteristics of the application. An application that uses version numbers performs more lock conversions; whereas one that uses blocking ASTs delivers more ASTs. Note that these techniques are compatible; some processes can use one technique, and other processes can use the other at the same time. Generally, blocking ASTs are preferable in a low-contention environment; whereas version numbers are preferable in a high-contention environment. You can even invent combined or adaptive strategies.

In a **combined** strategy, the applications use specific techniques. If a process is expected to reuse the contents of a buffer in a short amount of time, the application uses blocking ASTs; if there is no reason to expect a quick reuse, the application uses version numbers.

In an **adaptive** strategy, an application makes evaluations based on the rate of blocking ASTs and conversions. If blocking ASTs arrive frequently, the application changes to using version numbers; if many conversions take place and the same cached copy remains valid, the application changes to using blocking ASTs.

For example, suppose one process continually displays the state of a database, while another occasionally updates it. If version numbers are used, the displaying process must always make sure that its copy of the database is valid (by performing a lock conversion); if blocking ASTs are used, the display process is informed every time the database is updated. On the other hand, if updates occur frequently, the use of version numbers is preferable to continually delivering blocking ASTs.

## 7.8 Example of Using Lock Management Services

The following program segment requests a null lock for the resource named `TERMINAL`. After the lock is granted, the program requests that the lock be converted to an exclusive lock. Note that, after `SYS$ENQW` returns, the program checks both the status of the system service and the condition value returned in the lock status block to ensure that the request completed successfully.

```

! Define lock modes
INCLUDE '($LCKDEF)'
! Define lock status block
INTEGER*2 LOCK_STATUS,
2      NULL_
INTEGER LOCK_ID
COMMON /LOCK_BLOCK/ LOCK_STATUS,
2      NULL_,
2      LOCK_ID
      .
      .
! Request a null lock
STATUS = SYS$ENQW (,
2      %VAL(LCK$K_NLMODE),
2      LOCK_STATUS_,
2      'TERMINAL',
2      , , , , )
IF (.NOT. STATUS) CALL LIB$SIGNAL (%VAL(STATUS))
IF (.NOT. LOCK_STATUS) CALL LIB$SIGNAL (%VAL(LOCK_STATUS))

! Convert the lock to an exclusive lock
STATUS = SYS$ENQW (,
2      %VAL(LCK$K_EXMODE),
2      LOCK_STATUS_,
2      %VAL(LCK$M_CONVERT),
2      'TERMINAL',
2      , , , , )
IF (.NOT. STATUS) CALL LIB$SIGNAL (%VAL(STATUS))
IF (.NOT. LOCK_STATUS) CALL LIB$SIGNAL (%VAL(LOCK_STATUS))

```

To share a terminal between a parent process and a subprocess, each process requests a null lock on a shared resource name. Then, each time one of the processes wants to perform terminal I/O, it requests an exclusive lock, performs the I/O, and requests a null lock.

Because the lock manager is effective only between cooperating programs, the program that created the subprocess should not exit until the subprocess has exited. To ensure that the parent does not exit before the subprocess, specify an event flag to be set when the subprocess exits (the **num** argument of `LIB$SPAWN`). Before exiting from the parent program, use `SYS$WAITFR` to ensure that the event flag has been set. (You can suppress the logout message from the subprocess by using the `SYS$DELPRC` system service to delete the subprocess instead of allowing the subprocess to exit.)

After the parent process exits, a created process cannot synchronize access to the terminal and should use the `SYS$BRKTHRU` system service to write to the terminal.



# Part II

---

## Interrupts and Condition Handling

This part describes the use of asynchronous system traps (ASTs), and the use of condition-handling routines and services.



---

## Using Asynchronous System Traps

This chapter describes the use of asynchronous system traps (ASTs). It contains the following sections:

Section 8.1 provides an overview of AST routines.

Section 8.2 provides information about declaring and queuing ASTs.

Section 8.3 describes common asynchronous programming mistakes.

Section 8.4 provides information about using system services for AST event and time delivery.

Section 8.5 describes access modes for ASTs.

Section 8.6 provides information about calling ASTs.

Section 8.7 provides information about delivering ASTs.

Section 8.8 describes ASTs and process wait states.

Section 8.9 presents code examples of how to use AST services.

### 8.1 Overview of AST Routines

Asynchronous system traps (ASTs) are interrupts that occur asynchronously (out of sequence) with respect to the process's execution. ASTs are activated asynchronously to the mainline code in response to an event, usually either as a timer expiration or an I/O completion. An AST provides a transfer of control to a user-specified procedure that handles the event. For example, you can use ASTs to signal a program to execute a routine whenever a certain condition occurs.

The routine executed upon delivery of an AST is called an AST routine. AST routines are coded and referenced like any other routine; they are compiled and linked in the normal fashion. An AST routine's code must be reentrant. When the AST routine is finished, the routine that was interrupted resumes execution from the point of interruption.

ASTs provide a powerful programming technique. By using ASTs, you allow other processing to continue pending the occurrence of one or more events. Polling and blocking techniques, on the other hand, can use resources inefficiently. A polling technique employs a looping that polls for an event, which has to wait for an indication that an event has occurred. Therefore, depending on the frequency of the polling, polling techniques waste resources. If you use less frequent intervals, polling can then be slow to react to the occurrence of the event.

Blocking techniques force all processing to wait for the completion of a particular event. Blocking techniques can also be wasteful, for there could well be other activities the process could be performing while waiting for the occurrence of a specific event.

## Using Asynchronous System Traps

### 8.1 Overview of AST Routines

To deliver an AST, you use system services that specify the address of the AST routine. Then the system delivers the AST (that is, transfers control to your AST routine) at a particular time or in response to a particular event.

Some system services allow a process to request that it be interrupted when a particular event occurs. Table 8–1 shows the system services that are AST services.

**Table 8–1 AST System Services**

System Service	Task Performed
SYS\$SETAST	Enable or disable reception of AST requests
SYS\$DCLAST	Declare AST

The system services that use the AST mechanism accept as an argument the address of an AST service routine, that is, a routine to be given control when the event occurs.

Table 8–2 shows some of the services that use ASTs.

**Table 8–2 System Services That Use ASTs**

System Service	Task Performed
SYS\$DCLAST	Declare AST
SYS\$ENQ	Enqueue Lock Request
SYS\$GETDVI	Get Device/Volume Information
SYS\$GETJPI	Get Job/Process Information
SYS\$GETSYI	Get Systemwide Information
SYS\$QIO	Queue I/O Request
SYS\$SETIMR	Set Timer
SYS\$SETPRA	Set Power Recovery AST
SYS\$UPDSEC	Update Section File on Disk

The following sections describe in more detail how ASTs work and how to use them.

## 8.2 Declaring and Queuing ASTs

Most ASTs occur as the result of the completion of an asynchronous event that is initiated by a system service (for example, a SYS\$QIO or SYS\$SETIMR request) when the process requests notification by means of an AST.

The Declare AST (SYS\$DCLAST) system service can be called to invoke a subroutine as an AST. With this service, a process can declare an AST only for the same or for a less privileged access mode.

You may find occasional use for the SYS\$DCLAST system service in your programming applications; you may also find the SYS\$DCLAST service useful when you want to test an AST service routine.

The following sections present programming information about declaring and using ASTs.



### 8.2.1 Reentrant Code and ASTs

Compiled code that is generated by Compaq compilers is reentrant. Furthermore, Compaq compilers normally generate AST routine local data that is reentrant. Data that is shared static, shared external data, Fortran COMMON, and group or system global section data are not inherently reentrant, and usually require explicit synchronization.

Because the queuing mechanism for an AST does not provide for returning a function value or passing more than one argument, you should write an AST routine as a subroutine. This subroutine should use nonvolatile storage that is valid over the life of the AST. To establish nonvolatile storage, you can use the LIB\$GET\_VM run-time routine. You can also use a high-level language's storage keywords to create permanent nonvolatile storage. For instance, you can use the C language's keywords as follows:

```
extern
static
routine malloc().
```

In some cases, a system service that queues an AST (for example, SYS\$GETJPI) allows you to specify an argument for the AST routine. If you choose to pass the argument, the AST routine must be written to accept the argument.

#### 8.2.1.1 The Call Frame

When a routine is active under OpenVMS, it has available to it temporary storage on a stack, in a construct known as a stack frame, or call frame. Each time a subroutine call is made, another call frame is pushed onto the stack and storage is made available to that subroutine. Each time a subroutine returns to its caller, the subroutine's call frame is pulled off the stack, and the storage is made available for reuse by other subroutines. Call frames therefore are nested. Outer call frames remain active longer, and the outermost call frame, the call frame associated with the main routine, is normally always available.

A primary exception to this call frame condition is when an exit handler runs. With an exit handler running, only static data is available. The exit handler effectively has its own call frame. Exit handlers are declared with the SYS\$DCLEXH system service.

The use of call frames for storage means that all routine-local data is reentrant; that is, each subroutine has its own storage for the routine-local data.

The allocation of storage that is known to the AST must be in memory that is not volatile over the possible interval the AST might be pending. This means you must be familiar with how the compilers allocate routine-local storage using the stack pointer and the frame pointer. This storage is valid only while the stack frame is active. Should the routine that is associated with the stack frame return, the AST cannot write to this storage without having the potential for some severe application data corruptions.

### 8.2.2 Shared Data Access with Readers and Writers

The following are two types of shared data access:

- Multiple readers with one writer
- Multiple readers with multiple writers

If there is shared data access with multiple readers, your application must be able to tolerate having a stale counter that allows frequent looping back and picking up a new value from the code.

## Using Asynchronous System Traps

### 8.2 Declaring and Queuing ASTs

With multiple writers, often the AST is the writer, and the mainline code is the reader or updater. That is, the mainline processes all available work until it cannot dequeue any more requests, releasing each work request to the free queue as appropriate, and then hibernates when no more work is available. The AST then activates, pulls free blocks off the free queue, fills entries into the pending work queue, and then wakes the mainline code. In this situation, you should use a scheduled wakeup call for the mainline code in case work gets into the queue and no wakeup is pending.

Having multiple writers is possibly the most difficult to code, because you cannot always be sure where the mainline code is in its processing when the AST is activated. A suggestion is to use a work queue and a free queue at a known shared location, and to use entries in the queue to pass the work or data between the AST and the mainline code. Interlocked queue routines, such as LIB\$INSQHI and LIB\$REMQTI, are available in the Run-Time Library.

#### 8.2.3 Shared Data Access and AST Synchronization

An AST routine might invoke subroutines that are also invoked by another routine. To prevent conflicts, a program unit can use the SYS\$SETAST system service to disable AST interrupts before calling a routine that might be invoked by an AST. You use the SYS\$SETAST service typically only if there is noninterlocked (nonreentrant) variables, or if the code itself is nonreentrant. Once the shared routine has executed, the program unit can use the same service to reenables AST interrupts. In general you should avoid using the SYS\$SETAST call because of implications for application performance.

Implicit synchronization can be achieved for data that is shared for write by using only AST routines to write the data, since only one AST can be running at any one time. You can also use the SYS\$DCLAST system service to call a subroutine in AST mode.

Explicit synchronization can be achieved through a lack of read-modify cells, in cases of where there is one writer with one or more readers. However, if there are multiple writers, you must consider explicit synchronization of access to the data cells. This can be achieved using bitlocks (LIB\$BCCDI), hardware interlocked queues (LIB\$INSQHI), interlocked add and subtract (LIB\$ADAWI) routines, or by other techniques. These routines are available directly in assembler by language keywords in C and other languages, and by OpenVMS RTL routines from all languages. On Alpha systems, you can use PALcode calls such as load-locked (LDx\_L) and store-conditional (STx\_C) instructions to manage synchronization.

For details of synchronization, see Chapter 6. Also see processor architecture manuals about the necessary synchronization techniques and for common synchronization considerations.

#### 8.2.4 User ASTs and Asynchronous Completions

OpenVMS asynchronous completions usually activate an inner-mode, a privileged mode AST to copy any results read into a user buffer, if this is a read operation, and to update the IO status block (IOSB) and set the event flag. If a user-mode AST has been specified, it is activated once all data is available and the event flag and IOSB, if requested, have been updated.

### 8.3 Common Mistakes in Asynchronous Programming

The following lists common asynchronous programming **mistakes** and suggests how to avoid them:

- Allocating the IOSB in a routine's call frame and returning before completion of the asynchronous request that then exits. When the asynchronous operation completes, the IOSB is written, and if the call frame is no longer valid, then a data corruption of 8 bytes, the size of the IOSB, occurs.
- Failure to specify both an event flag and an IOSB. These are, in essence, required arguments.
- Failure to use SYS\$SYNCH, or to check both for an event flag that has been set and for a nonzero IOSB. If both conditions do not hold, the operation is not yet complete.
- Incorrect sharing of an IOSB among multiple operations that are pending in parallel, or the allocation of an IOSB in storage that is volatile while the operation is pending.
- Failure to acquire and synchronize the use of event flags using one or more calls to the LIB\$GET\_EF and LIB\$FREE\_EF routines.
- Attempting to access the terminal with language I/O statements using SYS\$INPUT or SYS\$OUTPUT may cause a redundant I/O error. You must establish another channel to the terminal by explicitly opening the terminal, or by using the SMG\$ routines.

### 8.4 Using System Services for AST Event and Time Delivery

The following list presents system services and routines that are used to queue the AST routine that determines whether an AST is delivered after a specified event or time. Note that the system service (W) calls are synchronous. Synchronous system services can have ASTs, but the code blocks pending completion, when the AST is activated.

- Event—The following system routines allow you to specify an AST routine to be delivered when the system routine completes:
  - LIB\$SPAWN—Signals when the subprocess has been created.
  - SYS\$ENQ and SYS\$ENQW—Signals when the resource lock is blocking a request from another process.
  - SYS\$GETDVI and SYS\$GETDVIW—Indicate that device information has been received.
  - SYS\$GETJPI and SYS\$GETJPIW—Indicate that process information has been received.
  - SYS\$GETSYI and SYS\$GETSYIW—Indicate that system information has been received.
  - SYS\$QIO and SYS\$QIOW—Signal when the requested I/O is completed.
  - SYS\$UPDSEC—Signals when the section file has been updated.
  - SYS\$ABORT\_TRANS and SYS\$ABORT\_TRANSW—Signal when a transaction is aborted.

## Using Asynchronous System Traps

### 8.4 Using System Services for AST Event and Time Delivery

- SYS\$AUDIT\_EVENT and SYS\$AUDIT\_EVENTW—Signal when an event message is appended to the system security audit log file or send an alarm to a security operator terminal.
- SYS\$BRKTHRU and SYS\$BRKTHRU(W)—Signal when a message is sent to one or more terminals.
- SYS\$CHECK\_PRIVILEGE and SYS\$CHECK\_PRIVILEGEW—Signal when the caller has the specified privileges or identifier.
- SYS\$DNS and SYS\$DNSW—On VAX systems, signal when client applications are allowed to store resource names and addresses.
- SYS\$END\_TRANS and SYS\$END\_TRANSW—Signal an end to a transaction by attempting to commit it.
- SYS\$GETQUI and SYS\$GETQUIW—Signal when information is returned about queues and the jobs initiated from those queues.
- SYS\$START\_TRANS and SYS\$START\_TRANSW—Signal the start of a new transaction.
- SYS\$SETCLUEVT and SYS\$SETCLUEVTW—On Alpha systems, signal a request for notification when a VMScluster configuration event occurs.
- Event—The SYS\$SETPRA system service allows you to specify an AST to be delivered when the system detects a power recovery.
- Time—The SYS\$SETIMR system service allows you to specify a time for the AST to be delivered.
- Time—The SYS\$DCLAST system service delivers a specified AST immediately. This makes it an ideal tool for debugging AST routines.

If a program queues an AST and then exits before the AST is delivered, the AST is deleted before execution. If a process is hibernating when an AST is delivered, the AST executes, and the process then resumes hibernating.

If a suspended process receives an AST, the execution of the AST depends on the AST mode and the mode at which the process was suspended, as follows:

- If the process was suspended from a SYS\$SUSPEND call at supervisor mode, user-mode ASTs are executed as soon as the process is resumed. If more than one AST is delivered, they are executed in the order in which they were delivered. Supervisor-, executive-, and kernel-mode ASTs are executed upon delivery.
- If the process was suspended from a SYS\$SUSPEND call at kernel mode, all ASTs are blocked and are executed as soon as the process is resumed.

Generally, AST routines are used with the SYS\$QIO or SYS\$QIOW system service for handling Ctrl/C, Ctrl/Y, and unsolicited input.

### 8.5 Access Modes for AST Execution

Each request for an AST is associated with the access mode from which the AST is requested. Thus, if an image executing in user mode requests notification of an event by means of an AST, the AST service routine executes in user mode.

Because the ASTs you use almost always execute in user mode, you do not need to be concerned with access modes. However, you should be aware of some system considerations for AST delivery. These considerations are described in Section 8.7.

## 8.6 Calling an AST

This section shows the use of the Set Time (SYS\$SETIMER) system service as an example of calling an AST. When you call the Set Timer (SYS\$SETIMR) system service, you can specify the address of a routine to be executed when a time interval expires or at a particular time of day. The service schedules the execution of the routine and returns; the program image continues executing. When the requested timer event occurs, the system “delivers” an AST by interrupting the process and calling the specified routine.

Example 8–1 shows a typical program that calls the SYS\$SETIMR system service with a request for an AST when a timer event occurs.

### Example 8–1 Calling the SYS\$SETIMR System Service

```
#include <stdio.h>
#include <stdlib.h>
#include <ssdef.h>
#include <descrip.h>
#include <starlet.h>
#include <lib$routines.h>

struct {
    unsigned int lower, upper;
}daytim;

/* AST routine */
void time_ast(void);

main() {
    unsigned int status;
    $DESCRIPTOR(timbuf,"0 ::10.00"); /* 10-second delta */

    /* Convert ASCII format time to binary format */
    status = SYS$BINTIM(&timbuf, /* buffer containing ASCII time */
                       &daytim); /* timadr (buffer to receive */
                                   /* binary time) */
    if ((status & 1) != 1)
        LIB$SIGNAL(status);
    else
        printf("Converting time to binary format...\n");

    /* Set the timer */
    status = SYS$SETIMR(0, /* efn (event flag) */ ❶
                       &daytim, /* expiration time */
                       &time_ast, /* astadr (AST routine) */
                       0, /* reqidt (timer request id) */
                       0); /* flags */
    if ((status & 1) != 1)
        LIB$SIGNAL(status);
    else
        printf("Setting the timer to expire in 10 secs...\n"); ❷

    /* Hibernate the process until the timer expires */
    status = SYS$HIBER();
    if ((status & 1) != 1)
        LIB$SIGNAL(status);
}

void time_ast (void) {
```

(continued on next page)

## Using Asynchronous System Traps

### 8.6 Calling an AST

#### Example 8–1 (Cont.) Calling the SYS\$SETIMR System Service

```
unsigned int status;
status = SYS$WAKE(0, /* process id */
                 0); /* process name */
if ((status & 1) != 1)
    LIB$SIGNAL(status);
printf("Executing AST routine to perform wake up...\n"); ❸
return;
}
```

- ❶ The call to the SYS\$SETIMR system service requests an AST at 10 seconds from the current time.

The **daytim** argument refers to the quadword, which must contain the time in system time (64-bit) format. For details on how this is accomplished, see Chapter 27. The **astadr** argument refers to TIME\_AST, the address of the AST service routine.

When the call to the system service completes, the process continues execution.

- ❷ The timer expires in 10 seconds and notifies the system. The system interrupts execution of the process and gives control to the AST service routine.
- ❸ The user routine TIME\_AST handles the interrupt. When the AST routine completes, it issues a RET instruction to return control to the program. The program resumes execution at the point at which it was interrupted.

## 8.7 Delivering ASTs

This section describes the AST service routine, some conditions affecting AST delivery, and the affect of kernel threads on AST delivery. The order of an AST delivery is not deterministic. The order the ASTs are entered into the AST queue for delivery to the process is not related to the order the particular operations that included AST notification requests were queued.

### 8.7.1 The AST Service Routine

An AST service routine must be a separate procedure. The AST must use the standard call procedure, and the routine must return using a RET instruction. If the service routine modifies any registers other than the standard scratch registers, it must set the appropriate bits in the entry mask so that the contents of those registers are saved.

Because you cannot know when the AST service routine will begin executing, you must take care that when you write the AST service routine it does not modify any data or instructions used by the main procedure (unless, of course, that is its function).

On entry to the AST service routine, the arguments shown in Table 8–3 are passed.

**Table 8–3 AST Arguments for VAX Systems and Alpha Systems**

VAX System Arguments	Alpha System Arguments
AST parameter	AST parameter
R0	R0
R1	R1
PC	PC
PSL	PS

Registers R0 and R1, the program counter (PC), and the processor status longword (PSL) on VAX systems, or processor status (PS) on Alpha systems were saved when the process was interrupted by delivery of the AST.

The AST parameter is an argument passed to the AST service routine so that it can identify the event that caused the AST. When you call a system service requesting an AST, or when you call the SYS\$DCLAST system service, you can supply a value for the AST parameter. If you do not specify a value, the parameter defaults to 0.

The following example illustrates an AST service routine. In this example, the ASTs are queued by the SYS\$DCLAST system service; the ASTs are delivered to the process immediately so that the service routine is called following each SYS\$DCLAST system service call.

```
#include <stdio.h>
#include <ssdef.h>
#include <starlet.h>
#include <lib$routines.h>

/* Declare the AST routine */

void astrtn ( int );

main()
{
    unsigned int status, value1=1, value2=2;
    status = SYS$DCLAST(&astrtn, /* astadr - AST routine */ ①
                      value1, /* astprm - AST parameter */
                      0); /* acmode */
    if((status & 1) != 1)
        LIB$SIGNAL( status );
    .
    .
    .
    status = SYS$DCLAST(&astrtn, value2, 0);
    if((status & 1) != 1)
        LIB$SIGNAL( status );
}

void astrtn (int value) { ②
/* Evaluate AST parameter */
    switch (value)
    {
        case 1: printf("Executing AST routine with value 1...\n");
                goto handler_1;
                break;

        case 2: printf("Executing AST routine with value 2...\n");
                goto handler_2;
                break;
    }
}
```

## Using Asynchronous System Traps

### 8.7 Delivering ASTs

```
                default: printf("Error\n");
            };
/* Handle first AST */
handler_1:
    .
    .
    .
    return;
/* Handle second AST */
handler_2:
    .
    .
    .
    return;
}
```

- 1 The program calls the SYS\$DCLAST AST system service twice to queue ASTs. Both ASTs specify the AST service routine, ASTRTN. However, a different parameter is passed for each call.
- 2 The first action this AST routine takes is to check the AST parameter so that it can determine if the AST being delivered is the first or second one declared. The value of the AST parameter determines the flow of execution. If a number of different values are determining a number of different paths of execution, Compaq recommends that you use the VAX MACRO instruction CASE.

#### 8.7.2 Conditions Affecting AST Delivery

When a condition causes an AST to be delivered, the system may not be able to deliver the AST to the process immediately. An AST *cannot* be delivered under any of the following conditions:

- An AST service routine is currently executing at the same or at a more privileged access mode.  
Because ASTs are implicitly disabled when an AST service routine executes, one AST routine cannot be interrupted by another AST routine declared for the same access mode. Only one AST can be running in any particular processor mode at any one time. If an AST is active in any particular processor mode, it blocks all the same and less privileged ASTs. An AST can, however, be interrupted for an AST declared for a more privileged access mode.
- AST delivery is explicitly disabled for the access mode.  
A process can disable the delivery of AST interrupts with the Set AST Enable (SYS\$SETAST) system service. This service may be useful when a program is executing a sequence of instructions that should not be interrupted for the execution of an AST routine.  
On Alpha systems, SYS\$SETAST is often used in a main program that shares data with an AST routine in order to block AST delivery while the program accesses the shared data.
- The process is executing or waiting at an access mode more privileged than that for which the AST is declared.



For example, if a user-mode AST is declared as the result of a system service but the program is currently executing at a higher access mode (because of another system service call, for example), the AST is not delivered until the program is once again executing in user mode.

If an AST cannot be delivered when the interrupt occurs, the AST is queued until the conditions disabling delivery are removed. Queued ASTs are ordered by the access mode from which they were declared, with those declared from more privileged access modes at the front of the queue. If more than one AST is queued for an access mode, the ASTs are delivered in the order in which they are queued.

#### 8.7.3 Kernel Threads AST Delivery (Alpha Only)

On Alpha systems with the kernel threads implementation, ASTs are associated with the kernel thread that initiates them, though it is not required that they execute on the thread that initiates them. The use of the kernel thread's PID in the asynchronous system trap control block (ACB) identifies the initiating thread. Associating an ACB with its initiating thread is required; the arrival of an AST is often the event that allows a thread, waiting on a flag or resource, to be made computable.

An AST, for example, may set a flag or make a resource available, and when the AST is completed, the thread continues its execution in non-AST mode and rechecks the wait condition. If the wait condition is satisfied, the thread continues; if not, the thread goes back into the wait queue.

On the other hand, if an AST executes on a kernel thread other than the one that initiated it, then when the AST completes, the kernel thread that initiated the AST must be made computable to ensure that it rechecks a waiting condition that may now be satisfied.

The queuing and delivery mechanisms of ASTs make a distinction between outer mode ASTs (user and supervisor modes), and inner mode ASTs (executive and kernel modes). This distinction is necessary because of the requirement to synchronize inner mode access.

With the kernel threads implementation, the standard process control block (PCB) AST queues now appear in the kernel thread block (KTB), so that each kernel thread may receive ASTs independently. These queues receive outer mode ASTs, which are delivered on the kernel thread that initiates them. The PCB has a new set of inner mode queues for inner mode ASTs that require the inner mode semaphore. With the creation of multiple kernel threads, inner mode ASTs are inserted in the PCB queues, and are delivered on whichever kernel thread holds the inner mode semaphore. Inner mode ASTs, which are explicitly declared as thread-safe, are inserted in the KTB queues, and are delivered on the kernel thread that initiates them.

If a thread manager declares a user AST callback, then user mode ASTs are delivered to the thread manager. The thread manager then is responsible for determining the context in which the AST should be executed.

There are significant programming considerations to be understood when mixing POSIX Threads Library with ASTs. For information about using POSIX Threads Library with ASTs, see the *Guide to the POSIX Threads Library*.

## Using Asynchronous System Traps

### 8.7 Delivering ASTs

#### 8.7.3.1 Outer Mode (User and Supervisor) Non-Serial Delivery of ASTs

Before kernel threads, AST routine code of a given mode has always been able to assume the following:

- It would be processed serially. It would not be interrupted or executed concurrently with any other AST of the same mode.
- It would be processed without same-mode, non-AST level code executing concurrently.

Further, before kernel threads, user mode code could safely access data that it knows is only used by other user mode, non-AST level routines without needing any synchronization mechanisms. The underlying assumption is that only one thread of user mode execution exists. If the current code stream is accessing the data, then by implication no other code stream can be accessing it.

After kernel threads, this assumed behavior of AST routines and user mode code is no longer valid. Multiple user-mode, non-AST level code streams can be executing at the same time. The use of any data that can be accessed by multiple user-mode code streams must be modified to become synchronized using the load-locked (LDx\_L) and store-conditional (STx\_C) instructions, or by using some other synchronization mechanism.

Kernel threads assumes that multiple threads of execution can be active at one time and includes outer mode ASTs. Within any given kernel thread, outer mode ASTs will still be delivered serially. Also, the kernel thread model allows any combination of multiple outer mode threads, or multiple outer mode ASTs. However, outer-mode AST routines, as well as non-AST outer-mode code, has to be aware that any data structure that can be accessed concurrently by outer-mode code, or by any other outer-mode AST must be protected by some form of synchronization.

Before kernel threads, same-mode ASTs executed in the order that they were queued. After kernel threads and within a single kernel thread, that still is true. However, it is not true process-wide. If two ACBs are queued to two different KTBs, whichever is scheduled first, executes first. There is no attempt to schedule kernel threads in such a way to correctly order ASTs that have been queued to them. The ASTs execute in any order and can, in fact, execute concurrently.

#### 8.7.3.2 Inner Mode (Executive and Kernel) AST Delivery

Before kernel threads, OpenVMS implemented AST preemptions in inner modes as follows:

- An executive mode AST can preempt non-AST executive mode processing.
- A kernel mode AST can preempt non-AST kernel mode processing, or any executive mode processing.
- A special kernel mode AST can preempt a normal kernel mode AST, non-AST kernel mode, or any executive mode.
- No ASTs can be delivered when interrupt priority level (IPL) is raised to 2 or above. Special kernel mode ASTs execute entirely at IPL 2 or above, which is what prevents other kernel mode ASTs from executing while the special kernel mode AST is active.

After kernel threads, in contrast to the preceding list, kernel threads deliver any non thread-safe inner mode ASTs to the kernel thread that already owns the semaphore. If no thread currently owns the semaphore when the AST is queued, then the semaphore is acquired in SCH\$QAST, and the owner is set to the target kernel thread for that AST. Subsequently queued ASTs see that thread as the semaphore owner and are delivered to that thread. This allows the PALcode and the hardware architecture to process all the AST preemption and ordering rules.

## 8.8 ASTs and Process Wait States

A process in a wait state can be interrupted for the delivery of an AST and the execution of an AST service routine. When the AST service routine completes execution, the process is returned to the wait state, if the condition that caused the wait is still in effect.

With the exception of suspended waits (SUSP) and suspended outswapped waits (SUSPO), any wait states can be interrupted.

### 8.8.1 Event Flag Waits

If a process is waiting for an event flag and is interrupted by an AST, the wait state is restored following execution of the AST service routine. If the flag is set at completion of the AST service routine (for example, by completion of an I/O operation), then the process continues execution when the AST service routine completes.

Event flags are described in Section 6.6 of Chapter 6.

### 8.8.2 Hibernation

A process can place itself in a wait state with the Hibernate (SYS\$HIBER) system service. This state can be interrupted for the delivery of an AST. When the AST service routine completes execution, the process continues hibernation. The process can, however, “wake” itself in the AST service routine or be awakened either by another process or as the result of a timer-scheduled wakeup request. Then, it continues execution when the AST service routine completes.

Process suspension is another form of wait; however, a suspended process cannot be interrupted by an AST. Process hibernation and suspension are described in Chapter 4.

### 8.8.3 Resource Waits and Page Faults

When a process is executing an image, the system can place the process in a wait state until a required resource becomes available, or until a page in its virtual address space is paged into memory. These waits, which are generally transparent to the process, can also be interrupted for the delivery of an AST.

## Using Asynchronous System Traps

### 8.9 Examples of Using AST Services

### 8.9 Examples of Using AST Services

The following is an example of a Compaq Fortran program that finds the process identification (PID) number of any user working on a particular disk and delivers an AST to a local routine that notifies the user that the disk is coming down:

```
PROGRAM DISK DOWN
! Implicit none
! Status variable
INTEGER STATUS
STRUCTURE /ITMLST/
UNION
MAP
  INTEGER*2 BUFLen,
2      CODE
  INTEGER*4 BUFADR,
2      RETLENADR
END MAP
MAP
  INTEGER*4 END_LIST
END MAP
END UNION
END STRUCTURE
RECORD /ITMLST/ DVILIST(2),
2      JPILIST(2)
! Information for GETDVI call
INTEGER PID BUF,
2      PID_LEN
! Information for GETJPI call
CHARACTER*7 TERM_NAME
INTEGER TERM_LEN
EXTERNAL DVI$PID,
2      JPI$TERMINAL
! AST routine and flag
INTEGER AST_FLAG
PARAMETER (AST_FLAG = 2)
EXTERNAL NOTIFY_USER

INTEGER SYSSGETDVIW,
2      SYSSGETJPI,
2      SYSSWAITFR
```

## Using Asynchronous System Traps 8.9 Examples of Using AST Services

```

! Set up for SYSSGETDVI
DVILIST(1).BUFLEN = 4
DVILIST(1).CODE = %LOC(DVI$ _PID)
DVILIST(1).BUFADR = %LOC(PID _BUF)
DVILIST(1).RETLENADR = %LOC(PID _LEN)
DVILIST(2).END_LIST = 0
! Find PID number of process using SYS$DRIVE0
STATUS = SYSSGETDVIW (,
2
2           ' MTA0:',           ! device
2           DVILIST,           ! item list
2           ',,')
IF (.NOT. STATUS) CALL LIB$SIGNAL (%VAL(STATUS))
! Get terminal name and fire AST
JPILIST(1).CODE = %LOC(JPI$ _TERMINAL)
JPILIST(1).BUFLEN = 7
JPILIST(1).BUFADR = %LOC(TERM _NAME)
JPILIST(1).RETLENADR = %LOC(TERM _LEN)
JPILIST(2).END_LIST = 0
STATUS = SYSSGETJPI (,
2           PID_BUF,           !process id
2
2           JPILIST,           !itemlist
2
2           NOTIFY_USER,       !AST
2           TERM _NAME)       !AST arg
IF (.NOT. STATUS) CALL LIB$SIGNAL(%VAL(STATUS))

! Ensure that AST was executed
STATUS = SYSSWAITFR(%VAL(AST_FLAG))
IF (.NOT. STATUS) CALL LIB$SIGNAL(%VAL(STATUS))
END

SUBROUTINE NOTIFY_USER (TERM_STR)
! AST routine that broadcasts a message to TERMINAL
! Dummy argument
CHARACTER*(*) TERM_STR
CHARACTER*8 TERMINAL
INTEGER LENGTH
! Status variable
INTEGER STATUS
CHARACTER*(*) MESSAGE
PARAMETER (MESSAGE =
2           'SYS$TAPE going down in 10 minutes')
! Flag to indicate AST executed
INTEGER AST_FLAG

! Declare system routines
INTRINSIC LEN
INTEGER SYS$BRDCST,
2       SYS$SETEF
EXTERNAL SYS$BRDCST,
2       SYS$SETEF,
2       LIB$SIGNAL
! Add underscore to device name
LENGTH = LEN (TERM_STR)
TERMINAL(2:LENGTH+1) = TERM_STR
TERMINAL(1:1) = '_'

```

## Using Asynchronous System Traps

### 8.9 Examples of Using AST Services

```
! Send message
STATUS = SYS$BRDCST(MESSAGE,
2          TERMINAL(1:LENGTH+1))
IF (.NOT. STATUS) CALL LIB$SIGNAL(%VAL(STATUS))
! Set event flag
STATUS = SYS$SETEF (%VAL(AST FLAG))
IF (.NOT. STATUS) CALL LIB$SIGNAL(%VAL(STATUS))
END
```

The following is an example of a C program setting up an AST:

```
#module SETAST "SRH X1.0-000"
#pragma builtins

/*
** COPYRIGHT (c) 1992 BY
** COMPAQ COMPUTER CORPORATION, MAYNARD, MASSACHUSETTS.
** ALL RIGHTS RESERVED.
**
** THIS SOFTWARE IS FURNISHED UNDER A LICENSE AND MAY BE USED AND COPIED
** ONLY IN ACCORDANCE WITH THE TERMS OF SUCH LICENSE AND WITH THE
** INCLUSION OF THE ABOVE COPYRIGHT NOTICE. THIS SOFTWARE OR ANY OTHER
** COPIES THEREOF MAY NOT BE PROVIDED OR OTHERWISE MADE AVAILABLE TO ANY
** OTHER PERSON. NO TITLE TO AND OWNERSHIP OF THE SOFTWARE IS HEREBY
** TRANSFERRED.
**
** THE INFORMATION IN THIS SOFTWARE IS SUBJECT TO CHANGE WITHOUT NOTICE
** AND SHOULD NOT BE CONSTRUED AS A COMMITMENT BY COMPAQ COMPUTER
** CORPORATION.
**
** COMPAQ ASSUMES NO RESPONSIBILITY FOR THE USE OR RELIABILITY OF ITS
** SOFTWARE ON EQUIPMENT THAT IS NOT SUPPLIED BY COMPAQ.
*/

/*
**++
** Facility:
**
** Examples
**
** Version: V1.0
**
** Abstract:
**
** Example of working with the $SETAST call and ASTs.
**
** Author:
** Steve Hoffman
**
** Creation Date: 1-Jan-1990
**
** Modification History:
**--
*/
/*
* AST and $SETAST demo
* raise the AST shields
* request an AST, parameter is 1
* request an AST, parameter is 2
* lower the shields
* <bing1><bing2>
*/
main()
{
    int retstat = 0;
    int bogus();
    int SYS$SETAST();
```

## Using Asynchronous System Traps 8.9 Examples of Using AST Services

```
int SYS$DCLAST();

printf("\ndisabling\n");
/*
 * $$SETAST() returns $$WASSET and $$WASCLR depending
 * on the previous setting of the AST shield. Watch out,
 * $$WASSET looks like a SUCCESSFUL $$ACCVIO. (ie:
 * a debug EXAMINE/COND shows $$WASSET as the error
 * %SYSTEM-S-ACCVIO. *Real* ACCVIO's never have the "-S-"
 * code!)
 */
retstat = SYS$SETAST( 0 );
printf("\n disable/ was: %d\n", retstat );

retstat = SYS$DCLAST( bogus, 1, 0 );
retstat = SYS$DCLAST( bogus, 2, 0 );
printf("\ndclast %x\n", retstat );

printf("\nenabling\n" );
retstat = SYS$SETAST( 1 );

/*
 * and, since we just lowered the shields, the ASTs should hit
 * in here somewhere....
 */
printf("\n enable/ was: %d\n", retstat );

return( 1 );
};

/*
 * and, here's the entire, sophisticated, twisted AST code...
 */
bogus( astprm )
int astprm;
{
printf("\nAST tripped. ast parameter was 0x%x\n\n", astprm);
return( 1 );
};
```





---

## Condition-Handling Routines and Services

This chapter describes the OpenVMS Condition Handling facility and contains the following sections:

Section 9.1 gives an overview of run-time errors.

Section 9.2 gives an overview of the OpenVMS Condition Handling facility, presenting condition-handling terminology and functionality.

Section 9.3 describes VAX system and Alpha system exceptions, arithmetic exceptions, and unaligned access traps on Alpha systems.

Section 9.4 describes how run-time library routines handle exceptions.

Section 9.5 describes the condition value field and the testing and modifying of values.

Section 9.6 describes the exception dispatcher.

Section 9.7 describes the argument list that is passed to a condition handler.

Section 9.8 describes signaling.

Section 9.9 describes types of condition handlers.

Section 9.10 describes types of actions performed by condition handlers.

Section 9.11 describes messages and how to use them.

Section 9.12 describes how to write a condition handler.

Section 9.13 describes how to debug a condition handler.

Section 9.14 describes several run-time library routines that can be established as condition handlers.

Section 9.15 describes how to establish, write, and debug an exit handler.

### 9.1 Overview of Run-Time Errors

Run-time errors are hardware- or software-detected events, usually errors, that alter normal program execution. Examples of run-time errors are as follows:

- System errors—for example, specifying an invalid argument to a system-defined procedure
- Language-specific errors—for example, in Fortran, a data type conversion error during an I/O operation
- Application-specific errors—for example, attempting to use invalid data

## Condition-Handling Routines and Services

### 9.1 Overview of Run-Time Errors

When an error occurs, the operating system either returns a condition code or value identifying the error to your program or signals the condition code. If the operating system signals the condition code, an error message is displayed and program execution continues or terminates, depending on the severity of the error. See Section 9.5 for details about condition values.

When unexpected errors occur, your program should display a message identifying the error and then either continue or stop, depending on the severity of the error. If you know that certain run-time errors might occur, you should provide special actions in your program to handle those errors.

Both an error message and its associated condition code identify an error by the name of the facility that generated it and an abbreviation of the message text. Therefore, if your program displays an error message, you can identify the condition code that was signaled. For example, if your program displays the following error message, you know that the condition code SS\$\_NOPRIV was signaled:

```
%SYSTEM-F-NOPRIV, no privilege for attempted operation
```

### 9.2 Overview of the OpenVMS Condition Handling Facility

The operating system provides a set of signaling and condition-handling routines and related system services to handle exception conditions. This set of services is called the OpenVMS Condition Handling facility (CHF). The OpenVMS Condition Handling Facility is a part of the common run-time environment of OpenVMS, which includes run-time library (RTL) routines and other components of the operating system.

The OpenVMS Condition Handling facility provides a single, unified method to enable condition handlers, signal conditions, print error messages, change the error behavior from the system default, and enable or disable detection of certain hardware errors. The RTL and all layered products of the operating system use the CHF for condition handling.

See the *OpenVMS Calling Standard* for a detailed description of OpenVMS condition handling.

#### 9.2.1 Condition-Handling Terminology

This section defines the terms used to describe condition handling.

##### **exception**

An event detected by the hardware or software that changes the normal flow of instruction execution. An exception is a synchronous event caused by the execution of an instruction and often means something generated by hardware. When an exception occurs, the processor transfers control by forcing a change in the flow of control from that explicitly indicated in the currently executing process.

Some exceptions are relevant primarily to the current process and normally invoke software in the context of the current process. An integer overflow exception detected by the hardware is an example of an event that is reported to the process. Other exceptions, such as page faults, are handled by the operating system and are transparent to the user.

An exception may also be signaled by a routine (software signaling) by calling the RTL routines LIB\$SIGNAL or LIB\$STOP.

## Condition-Handling Routines and Services

### 9.2 Overview of the OpenVMS Condition Handling Facility

#### condition

An informational state that exists when an exception occurs. *Condition* is a more general term than *exception*; a condition implies either a hardware exception or a software-raised condition. Often, the term condition is preferred because the term exception implies an error. Section 9.3.1 further defines the differences between exceptions and conditions.

#### condition handling

When a condition is detected during the execution of a routine, a signal can be raised by the routine. The routine is then permitted to respond to the condition. The routine's response is called **handling the condition**.

On VAX systems, an address of 0 in the first longword of a procedure call frame or in an exception vector indicates that a condition handler does not exist for that call frame or vector.

On Alpha systems, the handler valid flag bit in the procedure descriptor is cleared to indicate that a condition handler does not exist.

The condition handlers are themselves routines; they have their own call frames. Because they are routines, condition handlers can have condition handlers of their own. This allows condition handlers to field exceptions that might occur within themselves in a modular fashion.

On VAX systems, a routine can enable a condition handler by placing the address of the condition handler in the first longword of its stack frame.

On Alpha systems, the association of a handler with a procedure is static and must be specified at the time a procedure is compiled (or assembled). Some languages that lack their own exception-handling syntax, however, may support emulation of dynamic specified handlers by means of built-in routines.

If you determine that a program needs to be informed of particular exceptions so it can take corrective action, you can write and specify a condition handler. This condition handler, which receives control when any exception occurs, can test for specific exceptions.

If an exception occurs and you have not specified a condition handler, the default condition handler established by the operating system is given control. If the exception is a fatal error, the default condition handler issues a descriptive message and causes the image that incurred the exception to exit.

To declare or enable a condition handler, use the following system services:

- Set Exception Vector (SYS\$SETEXV)
- Unwind from Condition Handler Frame (SYS\$UNWIND)
- Declare Change Mode or Compatibility Mode Handler (SYS\$DCLCMH)

Parallel mechanisms exist for uniform dispatching of hardware and software exception conditions. Exceptions that are detected and signaled by hardware transfer control to an exception service routine in the executive. Software-detected exception conditions are generated by calling the run-time library routines LIB\$SIGNAL or LIB\$STOP. Hardware- and software-detected exceptions eventually execute the same exception dispatching code. Therefore, a condition handler may handle an exception condition generated by hardware or by software identically.

## Condition-Handling Routines and Services

### 9.2 Overview of the OpenVMS Condition Handling Facility

The Set Exception Vector (SYS\$SETEXV) system service allows you to specify addresses for a primary exception handler, a secondary exception handler, and a last-chance exception handler. You can specify handlers for each access mode. The primary exception vector is reserved for the debugger. In general, you should avoid using these vectored handlers unless absolutely necessary. If you use a vectored handler, it must be prepared for all exceptions occurring in that access mode.

#### 9.2.2 Functions of the Condition Handling Facility

The OpenVMS Condition Handling facility and the related run-time library routines and system services perform the following functions:

- Establish and call condition-handler routines  
You can establish condition handlers to receive control in the event of an exception in one of the following ways:
  - On VAX systems, by specifying the address of a condition handler in the first longword of a procedure call frame.  
On Alpha systems, the method for establishing a dynamic (that is, nonvectored) condition handler is specified by the language.
  - By establishing exception handlers with the Set Exception Vector (SYS\$SETEXV) system service.

The first of these methods is the preferred way to specify a condition handler for a particular image. The use of dynamic handlers is also the most efficient way in terms of declaration. You should use vectored handlers for special purposes, such as writing debuggers.

The VAX MACRO programmer can use the following single-move address instruction to place the address of the condition handler in the longword pointed to by the current frame pointer (FP):

```
MOVAB    HANDLER, (FP)
```

You can associate a condition handler for the currently executing routine by specifying an address pointing to the handler, either in the routine's stack frame on VAX systems or in one of the exception vectors. (The MACRO-32 compiler for OpenVMS Alpha systems generates the appropriate Alpha code from this VAX instruction to establish a dynamic condition handler.)

On VAX systems, the high-level language programmer can call the common run-time library routine LIB\$ESTABLISH (see the *OpenVMS RTL Library (LIB\$) Manual*), using the name of the handler as an argument. LIB\$ESTABLISH returns as a function value either the address of the former handler established for the routine or 0 if no handler existed.

On VAX systems, the new condition handler remains in effect for your routine until you call LIB\$REVERT or control returns to the caller of the caller of LIB\$ESTABLISH. Once this happens, you must call LIB\$ESTABLISH again if the same (or a new) condition handler is to be associated with the caller of LIB\$ESTABLISH.

On VAX systems, some languages provide access to condition handling as part of the language. You can use the ON ERROR GOTO statement in BASIC and the ON statement in PL/I to define condition handlers. If you are using a language that does provide access to condition handling, use its language mechanism rather than LIB\$ESTABLISH. Each procedure can declare a condition handler.

## Condition-Handling Routines and Services

### 9.2 Overview of the OpenVMS Condition Handling Facility

When the routine signals an exception, the OpenVMS Condition Handling facility calls the condition handler associated with the routine. See Section 9.8 for more information about exception vectors. Figure 9–5 shows a sample stack scan for a condition handler.

The following Compaq Fortran program segment establishes the condition handler ERRLOG. Because the condition handler is used as an actual argument, it must be declared in an EXTERNAL statement.

```
INTEGER*4 OLD_HANDLER
EXTERNAL  ERRLOG
.
.
.
OLD_HANDLER = LIB$ESTABLISH (ERRLOG)
```

LIB\$ESTABLISH returns the address of the previous handler as its function value. If only part of a program unit requires a special condition handler, you can reestablish the original handler by invoking LIB\$ESTABLISH and specifying the saved handler address as follows:

```
CALL LIB$ESTABLISH (OLD_HANDLER)
```

The run-time library provides several condition handlers and routines that a condition handler can call. These routines take care of several common exception conditions. Section 9.14 describes these routines.

On Alpha systems, LIB\$ESTABLISH and LIB\$REVERT are not supported, though a high-level language may support them for compatibility. (Table 9–4 lists other run-time library routines supported and not supported on Alpha systems.)

- On VAX systems, remove an established condition-handler routine  
On VAX systems using LIB\$REVERT, you can remove a condition handler from a routine's stack frame by setting the frame's handler address to 0. If your high-level language provides condition-handling statements, you should use them rather than LIB\$REVERT.
- On VAX systems, enable or disable the detection of arithmetic hardware exceptions  
On VAX systems, using run-time library routines, you can enable or disable the signaling of floating point underflow, integer overflow, and decimal overflow, which are detected by the VAX hardware.
- Signal a condition  
When the hardware detects an exception, such as an integer overflow, a signal is raised at that instruction. A routine may also raise a signal by calling LIB\$SIGNAL or LIB\$STOP. Signals raised by LIB\$SIGNAL allow the condition handler either to terminate or to resume the normal flow of the routine. Signals raised by LIB\$STOP require termination of the operation that raises the condition. The condition handler will not be allowed to continue from the point of call to LIB\$STOP.
- Display an informational message  
The system establishes default condition handlers before it calls the main program. Because these default condition handlers provide access to the system's standard error messages, the standard method for displaying a message is by signaling the severity of the condition: informational, warning, or error. See Section 9.5 for the definition of the severity field of a condition

## Condition-Handling Routines and Services

### 9.2 Overview of the OpenVMS Condition Handling Facility

vector. The system default condition handlers resume execution of the instruction after displaying the messages associated with the signal. If the condition value indicates a severe condition, then the image exits after the message is displayed.

- Display a stack traceback on errors  
The default operations of the LINK and RUN commands provide a system-supplied handler (the traceback handler) to print a symbolic stack traceback. The traceback shows the state of the routine stack at the point where the condition occurred. The traceback information is displayed along with the messages associated with the signaled condition.
- Compile customer-defined messages  
The Message utility allows you to define your own exception conditions and the associated messages. Message source files contain the condition values and their associated messages. See Section 9.11.3 for a complete description of how to define your own messages.
- Unwind the stack  
A condition handler can cause a signal to be dismissed and the stack to be unwound to the establisher or caller of the establisher of the condition handler when it returns control to the OpenVMS Condition Handling facility (CHF). During the unwinding operation, the CHF scans the stack. If a condition handler is associated with a frame, the system calls that handler before removing the frame. Calling the condition handlers during the unwind allows a routine to perform cleanup operations specific to a particular application, such as recovering from noncontinuable errors or deallocating resources that were allocated by the routine (such as virtual memory, event flags, and so forth). See Section 9.12.3 for a description of the SYS\$UNWIND system service.
- Log error messages to a file  
The Put Message (SYS\$PUTMSG) system service permits any user-written handler to include a message in a listing file. Such message logging can be separate from the default messages the user receives. See Section 9.11 for a detailed description of the SYS\$PUTMSG system service.

### 9.3 Exception Conditions

Exceptions can be generated by any of the following:

- Hardware
- Software

Hardware-generated exceptions always result in conditions that require special action if program execution is to continue.

Software-generated exceptions may result in error or warning conditions. These conditions and their message descriptions are documented in the online Help Message utility and in the OpenVMS system messages documentation. To access online message descriptions, use the HELP/MESSAGE command.

More information on using the Help Message utility is available in *OpenVMS System Messages: Companion Guide for Help Message Users*. That document describes only those messages that occur when the system is not fully operational and you cannot access Help Message.

## Condition-Handling Routines and Services

### 9.3 Exception Conditions

Some examples of exception conditions are as follows:

- Arithmetic exception condition in a user-written program detected and signaled by hardware (for example, floating-point overflow)
- Error in a user argument to a run-time library routine detected by software and signaled by calling LIB\$STOP (for example, a negative square root)
- Error in a run-time library language-support routine, such as an I/O error or an error in a data-type conversion
- RMS success condition stating that the record is already locked
- RMS success condition stating that the created file superseded an existing version

There are two standard methods for a Compaq- or user-written routine to indicate that an exception condition has occurred:

- Return a completion code to the calling program using the function value mechanism

Most general-purpose run-time library routines indicate exception conditions by returning a condition value in R0. The calling program then tests bit 0 of R0 for success or failure. This method allows better programming structure, because the flow of control can be changed explicitly after the return from each call. If the actual function value returned is greater than 32 bits, then use both R0 and R1.

On Alpha systems, if the actual function returned is a floating-point value, the floating-point value is returned in F0, or F0 and F1.

- Signal the exception condition

A condition can be signaled by calling the RTL routine LIB\$SIGNAL or LIB\$STOP. Any condition handlers that were enabled are then called by the CHF. See Figure 9–5 for the order in which CHF invokes condition handlers.

Exception conditions raised by hardware or software are signaled to the routine identically.

For more details, see Section 9.8 and Section 9.8.1.

#### 9.3.1 Conditions Caused by Exceptions

Table 9–1 summarizes common conditions caused by exceptions. The condition names are listed in the first column. The second column explains each condition more fully by giving information about the type, meaning, and arguments relating to the condition. The condition type is either trap or fault. For more information about traps and faults, refer to the *VAX Architecture Reference Manual* and *Alpha Architecture Reference Manual*. The meaning of the exception condition is a short description of each condition. The arguments for the condition handler are listed where applicable; they give specific information about the condition.

## Condition-Handling Routines and Services

### 9.3 Exception Conditions

**Table 9–1 Summary of Exception Conditions**

Condition Name	Explanation	
SS\$_ACCVIO	Type:	Fault.
	Description:	Access Violation.
	Arguments:	<ol style="list-style-type: none"> <li>Reason for access violation. This is a mask with the following format: <ul style="list-style-type: none"> <li>Bit &lt;0&gt; = type of access violation <ul style="list-style-type: none"> <li>0 = page table entry protection code did not permit intended access</li> <li>1 = POLR, PILR, or SLR length violation<sup>1</sup></li> </ul> </li> <li>Bit &lt;1&gt; = page table entry reference <ul style="list-style-type: none"> <li>0 = specified virtual address not accessible</li> <li>1 = associated page table entry not accessible</li> </ul> </li> <li>Bit &lt;2&gt; = intended access <ul style="list-style-type: none"> <li>0 = read</li> <li>1 = modify</li> </ul> </li> <li>Bit &lt;16&gt; = indicates fault on the pre-fetch of the instruction<sup>2</sup> <ul style="list-style-type: none"> <li>0 = successful execution</li> <li>1 = fault on fetch</li> </ul> </li> <li>Bit &lt;17&gt; = indicates whether instruction is marked as no execute<sup>2</sup> <ul style="list-style-type: none"> <li>0 = not marked</li> <li>1 = indicates instruction is marked as a fault on execute in its page table entry</li> </ul> </li> </ul> </li> <li>Virtual address to which access was attempted or, on some processors, virtual address within the page to which access was attempted.</li> </ol>
SS\$_ARTRES <sup>2</sup>	Type:	Trap.
	Description:	Reserved arithmetic trap.
	Arguments:	None.
SS\$_ASTFLT	Type:	Trap.
	Description:	Stack invalid during attempt to deliver an AST.

<sup>1</sup>On VAX systems, this condition is generated by hardware.

<sup>2</sup>On Alpha systems, this condition is generated by software.

(continued on next page)



## Condition-Handling Routines and Services

### 9.3 Exception Conditions

**Table 9–1 (Cont.) Summary of Exception Conditions**

Condition Name	Explanation	
	Arguments:	
		<ol style="list-style-type: none"> <li>1. Stack pointer value when fault occurred.</li> <li>2. AST parameter of failed AST.</li> <li>3. Program counter (PC) at AST delivery interrupt.</li> <li>4. Processor status longword (PSL) for VAX or processor status (PS) for Alpha at AST delivery interrupt.<sup>3</sup> For PS, it is the low-order 32 bits.</li> <li>5. Program counter (PC) to which AST would have been delivered.<sup>3</sup></li> <li>6. Processor status longword (PSL) for VAX or processor status (PS) for Alpha to which AST would have been delivered.<sup>3</sup> For PS, it is the low-order 32 bits.</li> </ol>
SS\$_BREAK	Type:	Fault.
	Description:	Breakpoint instruction encountered.
	Arguments:	None.
SS\$_CMODSUPR	Type:	Trap.
	Description:	Change mode to supervisor instruction encountered. <sup>4</sup>
	Arguments:	Change mode code. The possible values are –32,768 through 32,767.
SS\$_CMODUSER	Type:	Trap.
	Description:	Change mode to user instruction encountered. <sup>4</sup>
	Arguments:	Change mode code. The possible values are –32,768 through 32,767.
SS\$_COMPAT <sup>1</sup>	Type:	Fault.
	Description:	Compatibility-mode exception. This exception condition can occur only when executing in compatibility mode. <sup>5</sup>
	Arguments:	Type of compatibility exception. The possible values are as follows: <ol style="list-style-type: none"> <li>0 = Reserved instruction execution</li> <li>1 = BPT instruction executed</li> <li>2 = IOT instruction executed</li> <li>3 = EMT instruction executed</li> <li>4 = TRAP instruction executed</li> <li>5 = Illegal instruction executed</li> <li>6 = Odd address fault</li> <li>7 = TBIT trap.</li> </ol>

<sup>1</sup>On VAX systems, this condition is generated by hardware.

<sup>3</sup>The PC and PSL (or PS) normally included in the signal array are not included in this argument list. The stack pointer of the access mode receiving this exception is reset to its initial value.

<sup>4</sup>If a change mode handler has been declared for user or supervisor mode with the Declare Change Mode or Compatibility Mode Handler (SYS\$DCLCMH) system service, that routine receives control when the associated trap occurs.

<sup>5</sup>If a compatibility-mode handler has been declared with the Declare Change Mode or Compatibility Mode Handler (SYS\$DCLCMH) system service, that routine receives control when this fault occurs.

(continued on next page)

## Condition-Handling Routines and Services

### 9.3 Exception Conditions

**Table 9–1 (Cont.) Summary of Exception Conditions**

Condition Name	Explanation
SS\$_DECOVF <sup>1 2</sup>	Type: Trap. Description: Decimal overflow. Arguments: None.
SS\$_FLTDIV <sup>1 2</sup>	Type: Trap. Description: Floating/decimal divide-by-zero. Arguments: None.
SS\$_FLTDIV_F <sup>1</sup>	Type: Fault. Description: Floating divide-by-zero. Arguments: None.
SS\$_FLTTOVF <sup>1 2</sup>	Type: Trap. Description: Floating-point overflow. Arguments: None.
SS\$_FLTTOVF_F <sup>1</sup>	Type: Fault. Description: Floating-point overflow fault. Arguments: None.
SS\$_FLTUND <sup>1 2</sup>	Type: Trap. Description: Floating-point underflow. Arguments: None.
SS\$_FLTUND_F <sup>1</sup>	Type: Fault. Description: Floating-point underflow fault. Arguments: None.
SS\$_INTDIV <sup>1 2</sup>	Type: Trap. Description: Integer divide-by-zero. Arguments: None.
SS\$_INTOVF <sup>1 2</sup>	Type: Trap. Description: Integer overflow. Arguments: None.
SS\$_OPCCUS <sup>1</sup>	Type: Fault. Description: Opcode reserved for customer fault. Arguments: None.
SS\$_OPCDEC	Type: Fault. Description: Opcode reserved for Compaq fault. Arguments: None.
SS\$_PAGRDERR	Type: Fault. Description: Read error occurred during an attempt to read a faulted page from disk.

<sup>1</sup>On VAX systems, this condition is generated by hardware.

<sup>2</sup>On Alpha systems, this condition is generated by software.

(continued on next page)

## Condition-Handling Routines and Services

### 9.3 Exception Conditions

**Table 9–1 (Cont.) Summary of Exception Conditions**

Condition Name	Explanation	
	Arguments:	
	<ol style="list-style-type: none"> <li>1. Translation not valid reason. This is a mask with the following format:               <ul style="list-style-type: none"> <li>Bit &lt;0&gt; = 0</li> <li>Bit &lt;1&gt; = page table entry reference                   <ul style="list-style-type: none"> <li>0 = specified virtual address not valid</li> <li>1 = associated page table entry not valid</li> </ul> </li> <li>Bit &lt;2&gt; = intended access                   <ul style="list-style-type: none"> <li>0 = read</li> <li>1 = modify</li> </ul> </li> </ul> </li> <li>2. Virtual address of referenced page.</li> </ol>	
SS\$_RADDRMOD <sup>1</sup>	Type:	Fault.
	Description:	Attempt to use a reserved addressing mode.
	Arguments:	None.
SS\$_ROPRAND	Type:	Fault.
	Description:	Attempt to use a reserved operand.
	Arguments:	None.
SS\$_SSFAIL	Type:	Fault.
	Description:	System service failure (when system service failure exception mode is enabled). Condition occurred as result of the use of the obsolete feature that was enabled by using \$SETSFM service.
	Arguments:	Status return from system service (R0). (The same value is in R0 of the mechanism array.)
SS\$_SUBRNG <sup>1 2</sup>	Type:	Trap.
	Description:	Subscript range trap.
	Arguments:	None.
SS\$_TBIT <sup>1</sup>	Type:	Fault.
	Description:	Trace bit is pending following an instruction.
	Arguments:	None.

<sup>1</sup>On VAX systems, this condition is generated by hardware.

<sup>2</sup>On Alpha systems, this condition is generated by software.

#### Change-Mode and Compatibility-Mode Handlers

Two types of hardware exception can be handled in a way different from the normal condition-handling mechanism described in this chapter. The two types of hardware exception are as follows:

- Traps caused by change-mode-to-user or change-mode-to-supervisor instructions
- On VAX systems, compatibility mode faults

## Condition-Handling Routines and Services

### 9.3 Exception Conditions

You can use the Declare Change Mode or Compatibility Mode Handler (SYS\$DCLCMH) system service to establish procedures to receive control when one of these conditions occurs. The SYS\$DCLCMH system service is described in the *OpenVMS System Services Reference Manual*.

#### 9.3.2 Exception Conditions

On Alpha systems, the condition values that your condition-handling routine expects to receive on VAX systems may no longer be meaningful, even though the format of the 32-bit condition value and its location in the signal array are the same as they are on VAX systems. Because of architectural differences, some exception conditions that are returned on VAX systems are not supported on Alpha systems.

On Alpha systems, because hardware exceptions are more architecture specific than software exceptions, only a subset of the hardware exceptions supported on VAX systems are also supported on Alpha systems. In addition, the Alpha architecture defines several additional exceptions that are not supported on VAX systems.

Table 9–2 lists the Alpha exceptions that are not supported on VAX systems and VAX hardware exceptions that are not supported on Alpha systems. For some arithmetic exceptions, Alpha software produces VAX compatible exceptions that are not supported by the hardware itself. See Section 9.3.3 for a discussion of SS\$\_HPARITH, a generic Alpha exception condition that software may replace with specific VAX exceptions.

**Table 9–2 Architecture-Specific Hardware Exceptions**

Exception Condition Code	Comment
<b>New Alpha Exceptions</b>	
SS\$_HPARITH—High-performance arithmetic exception	Generated for most Alpha arithmetic exceptions (see Section 9.3.3)
SS\$_ALIGN—Data alignment trap	No VAX equivalent
<b>VAX Specific Hardware Exceptions</b>	
SS\$_ARTRES—Reserved arithmetic trap	No Alpha system equivalent
SS\$_COMPAT—Compatibility fault	No Alpha system equivalent
SS\$_DECOVF—Decimal overflow <sup>1</sup>	Replaced by SS\$_HPARITH (see Section 9.3.3)
SS\$_FLTDIV—Float divide-by-zero (trap) <sup>1</sup>	Replaced by SS\$_HPARITH (see Section 9.3.3)
SS\$_FLTDIV_F—Float divide-by-zero (fault)	Replaced by SS\$_HPARITH (see Section 9.3.3)
SS\$_FLTOVF—Float overflow (trap) <sup>1</sup>	Replaced by SS\$_HPARITH (see Section 9.3.3)
SS\$_FLTOVF_F—Float overflow (fault)	Replaced by SS\$_HPARITH (see Section 9.3.3)

<sup>1</sup>On Alpha systems, this condition may be generated by software.

(continued on next page)

**Table 9–2 (Cont.) Architecture-Specific Hardware Exceptions**

Exception Condition Code	Comment
<b>VAX Specific Hardware Exceptions</b>	
SS\$_FLTUND–Float underflow (trap) <sup>1</sup>	Replaced by SS\$_HPARITH (see Section 9.3.3)
SS\$_FLTUND_F–Float underflow (fault)	Replaced by SS\$_HPARITH (see Section 9.3.3)
SS\$_INTDIV–Integer divide-by-zero <sup>1</sup>	Replaced by SS\$_HPARITH (see Section 9.3.3)
SS\$_INTOVF–Integer overflow <sup>1</sup>	Replaced by SS\$_HPARITH (see Section 9.3.3)
SS\$_TBIT–Trace pending	No Alpha system equivalent
SS\$_OPCCUS–Opcode reserved to customer	No Alpha system equivalent
SS\$_RADMOD–Reserved addressing mode	No Alpha system equivalent
SS\$_SUBRNG–INDEX subscript range check	No Alpha system equivalent

<sup>1</sup>On Alpha systems, this condition may be generated by software.

### 9.3.3 Arithmetic Exceptions

On VAX systems, the architecture ensures that arithmetic exceptions are reported synchronously; that is, a VAX arithmetic instruction that causes an exception (such as an overflow) enters any exception handlers immediately, and subsequent instructions are not executed. The program counter (PC) reported to the exception handler is that of the failing arithmetic instruction. This allows application programs, for example, to resume the main sequence, with the failing operation being emulated or replaced by some equivalent or alternative set of operations.

On Alpha systems, arithmetic exceptions are reported **asynchronously**; that is, implementations of the architecture can allow a number of instructions (including branches and jumps) to execute beyond that which caused the exception. These instructions may overwrite the original operands used by the failing instruction, thus causing the loss of information that is integral to interpreting or rectifying the exception. The program counter (PC) reported to the exception handler is not that of the failing instruction, but rather is that of some subsequent instruction. When the exception is reported to an application’s exception handler, it may be impossible for the handler to fix up the input data and restart the instruction.

Because of this fundamental difference in arithmetic exception reporting, Alpha systems define a new condition code, SS\$\_HPARITH, to indicate most arithmetic exceptions. Thus, if your application contains a condition-handling routine that performs processing when an integer overflow exception occurs, on VAX systems the application expects to receive the SS\$\_INTOVF condition code. On Alpha systems, this exception may be indicated by the condition code SS\$\_HPARITH. It is possible, however, that some higher level languages using RTL routines, for example, LIB\$ routines, might convert the SS\$\_HPARITH into a more precise exception code such as SS\$\_INTOVF, or generate a precise exception code directly in an arithmetic emulation routine. If a SS\$\_HPARITH is received as the condition code, it indicates an imprecise Alpha system exception. If a precise integer overflow is received, SS\$\_INTOVF, it indicates either a VAX system condition or a precise Alpha system condition.

## Condition-Handling Routines and Services

### 9.3 Exception Conditions

Figure 9–1 shows the format of the SS\$\_HPARITH exception signal array.

**Figure 9–1 SS\$\_HPARITH Exception Signal Array**

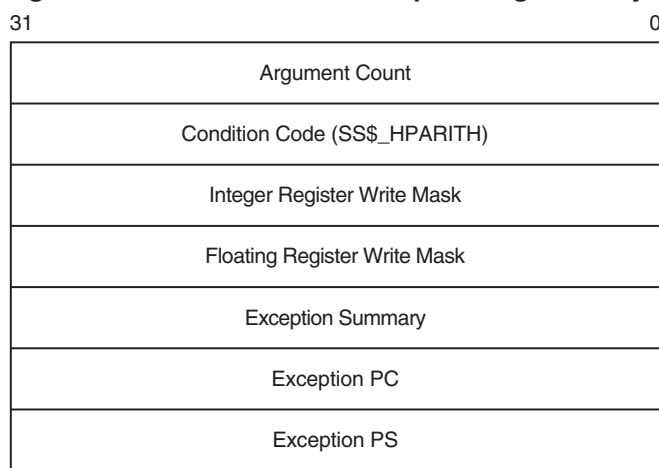

ZK-5206A-GE

This signal array contains three arguments that are specific to the SS\$\_HPARITH exception: the **integer register write mask**, **floating register write mask**, and **exception summary** arguments of the **exception pc** and **exception ps**. The **integer register write mask** and **floating register write mask** arguments indicate the registers that were targets of instructions that set bits in the **exception summary** argument. Each bit in the mask represents a register. The **exception summary** argument indicates the type of exceptions that are being signaled by setting flags in the first 7 bits. Table 9–3 lists the meaning of each of these bits when set.

**Table 9–3 Exception Summary Argument Fields**

Bit	Meaning When Set
0	Software completion.
1	Invalid floating arithmetic, conversion, or comparison operation.
2	Invalid attempt to perform a floating divide operation with a divisor of zero. Note that integer divide-by-zero is not reported.
3	Floating arithmetic or conversion operation overflowed the destination exponent.
4	Floating arithmetic or conversion operation underflowed the destination exponent.
5	Floating arithmetic or conversion operation gave a result that differed from the mathematically exact result.
6	Integer arithmetic or conversion operation from floating point to integer overflowed the destination precision.

For more information and recommendations about using arithmetic exceptions on Alpha systems, see *Migrating to an OpenVMS AXP System: Recompiling and Relinking Applications*. Note that this manual has been archived but is available on the OpenVMS Documentation CD-ROM.

### 9.3.4 Unaligned Access Traps (Alpha Only)

On Alpha systems, an unaligned access trap is generated when an attempt is made to load or store a longword or quadword to or from a register using an address that does not have the natural alignment of the particular data reference and do not use an Alpha instruction that takes an unaligned address as an operand (LDQ\_U). For more information about data alignment, see Section 9.4.2.

Alpha compilers typically avoid triggering alignment faults by:

- Aligning static data on natural boundaries by default. (This default behavior can be overridden by using a compiler qualifier.)
- Generating special inline code sequences for data that is known to be unnaturally aligned at compile time.

Note, however, that compilers cannot align dynamically defined data. Thus, alignment faults may be triggered.

An alignment exception is identified by the condition code SS\$\_ALIGN. Figure 9–2 illustrates the elements of the signal array returned by the SS\$\_ALIGN exception.

**Figure 9–2 SS\$\_ALIGN Exception Signal Array**

31	0
Argument Count	
Condition Code (SS\$_ALIGN)	
Virtual Address	
Register Number	
Exception PC	
Exception PS	

ZK-5205A-GE

This signal array contains two arguments specific to the SS\$\_ALIGN exception: the **virtual address** argument and the **register number** argument. The **virtual address** argument contains the address of the unaligned data being accessed. The **register number** argument identifies the target register of the operation.

## 9.4 How Run-Time Library Routines Handle Exceptions

Most general-purpose run-time library routines handle errors by returning a status in R0. In some cases, however, exceptions that occur during the execution of a run-time library routine are signaled. This section tells how run-time library routines signal exception conditions.

Some calls to the run-time library do not or cannot specify an action to be taken. In this case, the run-time library signals the proper exception condition by using the operating system's signaling mechanism.

## Condition-Handling Routines and Services

### 9.4 How Run-Time Library Routines Handle Exceptions

In order to maintain modularity, the run-time library does not use exception vectors, which are processwide data locations. Thus, the run-time library itself does not establish handlers by using the primary, secondary, or last-chance exception vectors.

#### 9.4.1 Exception Conditions Signaled from Mathematics Routines (VAX Only)

On VAX systems, mathematics routines return function values in register R0 or registers R0 and R1, unless the return values are larger than 64 bits. For this reason, mathematics routines cannot use R0 to return a completion status and must signal all errors. In addition, all mathematics routines signal an error specific to the MTH\$ facility rather than a general hardware error.

##### 9.4.1.1 Integer Overflow and Floating-Point Overflow

Although the hardware normally detects integer overflow and floating-point overflow errors, run-time library mathematics routines are programmed with a software check to trap these conditions before the hardware signaling process can occur. This means that they call LIB\$SIGNAL instead of allowing the hardware to initiate signaling.

The software check is needed because JSB routines cannot set up condition handlers. The check permits the JSB mathematics routines to add an extra stack frame so that the error message and stack traceback appear as if a CALL instruction had been performed. Because of the software check, JSB routines do not cause a hardware exception condition even when the calling program has enabled the detection of integer overflow. On the other hand, detection of floating-point overflow is always enabled and cannot be disabled.

If an integer or floating-point overflow occurs during a CALL or a JSB routine, the routine signals a mathematics-specific error such as MTH\$\_FLOOVEMAT (Floating Overflow in Math Library) by calling LIB\$SIGNAL explicitly.

##### 9.4.1.2 Floating-Point Underflow

All mathematics routines are programmed to avoid floating-point underflow conditions. Software checks are made to determine if a floating-point underflow condition would occur. If so, the software makes an additional check:

- If the immediate calling program (CALL or JSB) has enabled floating-point underflow traps, a mathematics-specific error condition is signaled.
- Otherwise, the result is corrected to zero and execution continues with no error condition.

The user can enable or disable detection of floating-point underflow at run time by calling the routine LIB\$FLT\_UNDER.

#### 9.4.2 System-Defined Arithmetic Condition Handlers

On VAX systems, you can use the following run-time library routines as arithmetic condition handlers to enable or disable the signaling of decimal overflow, floating-point underflow, and integer overflow:

- LIB\$DEC\_OVER—Enables or disables the signaling of a decimal overflow. By default, signaling is disabled.
- LIB\$FLT\_UNDER—Enables or disables the signaling of a floating-point underflow. By default, signaling is disabled.



## Condition-Handling Routines and Services

### 9.4 How Run-Time Library Routines Handle Exceptions

- `LIB$INT_OVER`—Enables or disables the signaling of an integer overflow. By default, signaling is enabled.

You can establish these handlers in one of two ways:

- Invoke the appropriate handler as a function specifying the first argument as 1 to enable signaling.
- Invoke the handler with command qualifiers when you compile your program. (Refer to your program language manuals.)

You cannot disable the signaling of integer divide-by-zero, floating-point overflow, and floating-point or decimal divide-by-zero.

When the signaling of a hardware condition is enabled, the occurrence of the exception condition causes the operating system to signal the condition as a severe error. When the signaling of a hardware condition is disabled, the occurrence of the condition is ignored, and the processor executes the next instruction in the sequence.

The signaling of overflow and underflow detection is enabled independently for activation of each routine, because the call instruction saves the state of the calling program's hardware enable operations in the stack and then initializes the enable operations for the called routine. A return instruction restores the calling program's enable operations.

These run-time library routines are intended primarily for high-level languages, because you can achieve the same effect in MACRO with the single Bit Set PSW (`BISPSW`) or Bit Clear PSW (`BICPSW`) VAX instructions.

These routines allow you to enable and disable detection of decimal overflow, floating-point underflow, and integer overflow for a portion of your routine's execution. Note that the VAX BASIC and Compaq Fortran compilers provide a compile-time qualifier that permits you to enable or disable integer overflow for your entire routine.

On Alpha systems, certain RTL routines that process conditions do not exist because the exception conditions defined by the Alpha architecture differ somewhat from those defined by the VAX architecture. Table 9-4 lists the run-time library condition-handling support routines available on VAX systems and indicates which are supported on Alpha systems.

## Condition-Handling Routines and Services

### 9.4 How Run-Time Library Routines Handle Exceptions

**Table 9–4 Run-Time Library Condition-Handling Support Routines**

<b>Routine</b>	<b>Availability on Alpha Systems</b>
<b>Arithmetic Exception Support Routines</b>	
LIB\$DEC_OVER—Enables or disables signaling of decimal overflow	Not supported
LIB\$FIXUP_FLT—Changes floating-point reserved operand to a specified value	Not supported
LIB\$FLT_UNDER—Enables or disables signaling of floating-point underflow	Not supported
LIB\$INT_OVER—Enables or disables signaling of integer overflow	Not supported
<b>General Condition-Handling Support Routines</b>	
LIB\$DECODE_FAULT—Analyzes instruction context for fault	Not supported
LIB\$ESTABLISH—Establishes a condition handler	Not supported (languages may support for compatibility)
LIB\$MATCH_COND—Matches condition value	Supported
LIB\$REVERT—Deletes a condition handler	Not supported (languages may support for compatibility)
LIB\$SIG_TO_STOP—Converts a signaled condition to a condition that cannot be continued	Supported
LIB\$SIG_TO_RET—Converts a signal to a return status	Supported
LIB\$SIM_TRAP—Simulates a floating-point trap	Not supported
LIB\$SIGNAL—Signals an exception condition	Supported
LIB\$STOP—Stops execution by using signaling	Supported

## 9.5 Condition Values

Error conditions are identified by integer values called **condition codes** or **condition values**. The operating system defines condition values to identify errors that might occur during execution of system-defined procedures. Each exception condition has associated with it a unique, 32-bit condition value that identifies the exception condition, and each condition value has a unique, systemwide symbol and an associated message. The condition value is used in both methods of indicating exception conditions, returning a status and signaling.

From a condition value you can determine whether an error has occurred, which error has occurred, and the severity of the error. Table 9–5 describes the fields of a condition value.

## Condition-Handling Routines and Services

### 9.5 Condition Values

**Table 9–5 Fields of a Condition Value**

Field	Bits	Meaning
FAC_NO	<27:16>	Indicates the system facility in which the condition occurred
MSG_NO	<15:3>	Indicates the condition that occurred
SEVERITY	<2:0>	Indicates whether the condition is a success (bit <0> = 1) or a failure (bit <0> = 0) as well as the severity of the error, if any

Figure 9–3 shows the format of a condition value.

**Figure 9–3 Format of a Condition Value**

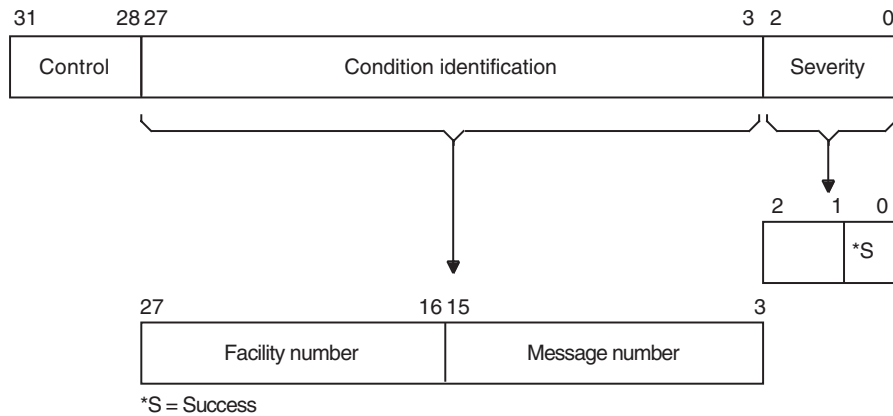

ZK-1795-GE

#### Condition Value Fields

##### severity

The severity of the error condition. Bit <0> indicates success (logical true) when set and failure (logical false) when clear. Bits <1> and <2> distinguish degrees of success or failure. The three bits, when taken as an unsigned integer, are interpreted as described in Table 9–6. The symbolic names are defined in module \$STSDEF.

## Condition-Handling Routines and Services

### 9.5 Condition Values

**Table 9–6 Severity of Error Conditions**

Value	Symbol	Severity	Response
0	STS\$K_WARNING	Warning	Execution continues, unpredictable results
1	STS\$K_SUCCESS	Success	Execution continues, expected results
2	STS\$K_ERROR	Error	Execution continues, erroneous results
3	STS\$K_INFO	Information	Execution continues, informational message displayed
4	STS\$K_SEVERE	Severe error	Execution terminates, no output
5			Reserved for Compaq
6			Reserved for Compaq
7			Reserved for Compaq

#### **condition identification**

Identifies the condition uniquely on a systemwide basis.

#### **control**

Four control bits. Bit <28> inhibits the message associated with the condition value from being printed by the SYS\$EXIT system service. After using the SYS\$PUTMSG system service to display an error message, the system default handler sets this bit. It is also set in the condition value returned by a routine as a function value, if the routine has also signaled the condition, so that the condition has been either printed or suppressed. Bits <29:31> must be zero; they are reserved for Compaq.

When a software component completes execution, it returns a condition value in this format. When a severity value of warning, error, or severe error has been generated, the status value returned describes the nature of the problem. Your program can test this value to change the flow of control or to generate a message. Your program can also generate condition values to be examined by other routines and by the command language interpreter. Condition values defined by customers must set bits <27> and <15> so that these values do not conflict with values defined by Compaq.

#### **message number**

The number identifying the message associated with the error condition. It is a status identification, that is, a description of the hardware exception condition that occurred or a software-defined value. Message numbers with bit <15> set are specific to a single facility. Message numbers with bit <15> clear are systemwide status values.

#### **facility number**

Identifies the software component generating the condition value. Bit <27> is set for user facilities and clear for Compaq facilities.

### 9.5.1 Return Status Convention

Most system-defined procedures are functions of longwords, where the function value is equated to a condition value. In this capacity, the condition value is referred to as a **return status**. You can write your own routines to follow this convention. See Section 9.14.3 for information about how to change a signal to a return status. Each routine description in the *OpenVMS System Services Reference Manual*, *OpenVMS RTL Library (LIB\$) Manual*, *OpenVMS Record Management Utilities Reference Manual*, and *OpenVMS Utility Routines Manual* lists the condition values that can be returned by that procedure.

#### 9.5.1.1 Testing Returned Condition Values

When a function returns a condition value to your program unit, you should always examine the returned condition value. To check for a failure condition (warning, error, or severe error), test the returned condition value for a logical value of false. The following program segment invokes the run-time library procedure LIB\$DATE\_TIME, checks the returned condition value (returned in the variable STATUS), and, if an error has occurred, signals the condition value by calling the run-time library procedure LIB\$SIGNAL (Section 9.8 describes signaling):

```
INTEGER*4 STATUS,  
2      LIB$DATE_TIME  
CHARACTER*23 DATE  
  
STATUS = LIB$DATE_TIME (DATE)  
IF (.NOT. STATUS) CALL LIB$SIGNAL (%VAL (STATUS))
```

To check for a specific error, test the return status for a particular condition value. For example, LIB\$DATE\_TIME returns a success value (LIB\$\_STRTRU) when it truncates the string. If you want to take special action when truncation occurs, specify the condition as shown in the following example (the special action would follow the IF statement):

```
INTEGER*4 STATUS,  
2      LIB$DATE_TIME  
CHARACTER*23 DATE  
  
INCLUDE '($LIBDEF)'  
:  
:  
:  
STATUS = LIB$DATE_TIME (DATE)  
IF (STATUS .EQ. LIB$_STRTRU) THEN  
:  
:  
:
```

#### 9.5.1.2 Testing SS\$\_NOPRIV and SS\$\_EXQUOTA Condition Values

The SS\$\_NOPRIV and SS\$\_EXQUOTA condition values returned by a number of system service procedures require special checking. Any system service that is listed as returning SS\$\_NOPRIV or SS\$\_EXQUOTA can instead return a more specific condition value that indicates the privilege or quota in question. Table 9-7 list the specific privilege errors, and Table 9-8 lists the quota errors.

## Condition-Handling Routines and Services

### 9.5 Condition Values

**Table 9–7 Privilege Errors**

---

SS\$_NOACNT	SS\$_NOALLSPOOL	SS\$_NOALTPRI
SS\$_NOBUGCHK	SS\$_NOBYPASS	SS\$_NOCMEXEC
SS\$_NOCMKRNL	SS\$_NODETACH	SS\$_NODIAGNOSE
SS\$_NODOWNGRADE	SS\$_NOEXQUOTA	SS\$_NOGROUP
SS\$_NOGRPNAM	SS\$_NOGRPPRV	SS\$_NOLOGIO
SS\$_NOMOUNT	SS\$_NONETMBX	SS\$_NOOPER
SS\$_NOPFNMAP	SS\$_NOPHYIO	SS\$_NOPRMCEB
SS\$_NOPRMGBL	SS\$_NOPRMMBX	SS\$_NOPSWAPM
SS\$_NOREADALL	SS\$_NOSECURITY	SS\$_NOSETPRV
SS\$_NOSHARE	SS\$_NOSHMEM	SS\$_NOSYSGBL
SS\$_NOSYSLCK	SS\$_NOSYSNAM	SS\$_NOSYSPRV
SS\$_NOTMPMBX	SS\$_NOUPGRADE	SS\$_NOVOLPRO
SS\$_NOWORLD		

---

**Table 9–8 Quota Errors**

---

SS\$_EXASTLM	SS\$_EXBIOLM	SS\$_EXBYTLM
SS\$_EXDIOLM	SS\$_EXENQLM	SS\$_EXFILLM
SS\$_EXPGFLQUOTA	SS\$_EXPRCLM	SS\$_EXTQELM

---

Because either a general or a specific value can be returned, your program must test for both. The following four symbols provide a starting and ending point with which you can compare the returned condition value:

- SS\$\_NOPRIVSTRT—First specific value for SS\$\_NOPRIV
- SS\$\_NOPRIVEND—Last specific value for SS\$\_NOPRIV
- SS\$\_NOQUOTASTRT—First specific value for SS\$\_EXQUOTA
- SS\$\_NOQUOTAEND—Last specific value for SS\$\_EXQUOTA

The following Compaq Fortran example tests for a privilege error by comparing STATUS (the returned condition value) with the specific condition value SS\$\_NOPRIV and the range provided by SS\$\_NOPRIVSTRT and SS\$\_NOPRIVEND. You would test for SS\$\_NOEXQUOTA in a similar fashion.

```

      .
      .
      .
! Declare status and status values
INTEGER STATUS
INCLUDE '($SDEF)'
      .
      .
      .
IF (.NOT. STATUS) THEN
  IF ((STATUS .EQ. SS$ _NOPRIV) .OR.
2    ((STATUS .GE. SS$ _NOPRIVSTRT) .AND.
2    (STATUS .LE. SS$ _NOPRIVEND))) THEN
      .
      .
      .
  ELSE
    CALL LIB$SIGNAL (%VAL(STATUS))
  END IF
END IF

```

### 9.5.2 Modifying Condition Values

To modify a condition value, copy a series of bits from one longword to another longword. For example, the following statement copies the first three bits (bits <2:0>) of STS\$K\_INFO to the first three bits of the signaled condition code, which is in the second element of the signal array named SIGARGS. As shown in Table 9–6, STS\$K\_INFO contains the symbolic severity code for an informational message.

```

! Declare STS$K symbols
INCLUDE '($STSDEF)'
      .
      .
      .
! Change the severity of the condition code
! in SIGARGS(2) to informational
CALL MVBITS (STS$K_INFO,
2           0,
2           3,
2           SIGARGS(2),
2           0)

```

Once you modify the condition value, you can resignal the condition value and either let the default condition handler display the associated message or use the SYS\$PUTMSG system service to display the message. If your condition handler displays the message, do not resignal the condition value, or the default condition handler will display the message a second time.

In the following example, the condition handler verifies that the signaled condition value is LIB\$\_NOSUCHSYM. If it is, the handler changes its severity from error to informational and then resignals the modified condition value. As a result of the handler's actions, the program displays an informational message indicating that the specified symbol does not exist, and then continues executing.

```

INTEGER FUNCTION SYMBOL (SIGARGS,
2                       MECHARGS)
! Changes LIB$_NOSUCHSYM to an informational message

! Declare dummy arguments
INTEGER*4 SIGARGS(*),
2        MECHARGS(*)
! Declare index variable for LIB$MATCH_COND
INTEGER INDEX

```

## Condition-Handling Routines and Services

### 9.5 Condition Values

```
! Declare condition codes
INCLUDE '($LIBDEF)'
INCLUDE '($STSDEF)'
INCLUDE '($SSDEF)'
! Declare library procedures
INTEGER LIB$MATCH_COND
INDEX = LIB$MATCH_COND (SIGARGS(2),
2                          LIB$NO_SUCHSYM)
! If the signaled condition code is LIB$NO_SUCHSYM,
! change its severity to informational.
IF (INDEX .GT. 0)
2 CALL MVBITS (STS$K_INFO,
2              0,
2              3,
2              SIGARGS(2),
2              0)

SYMBOL = SS$_RESIGNAL

END
```

### 9.6 Exception Dispatcher

When an exception occurs, control is passed to the operating system's exception-dispatching routine. The exception dispatcher searches for a condition-handling routine invoking the first handler it finds and passes the information to the handler about the condition code and the state of the program when the condition code was signaled. If the handler resignals, the operating system searches for another handler; otherwise, the search for a condition handler ends.

The operating system searches for condition handlers in the following sequence:

1. Primary exception vectors—Four vectors (lists) of one or more condition handlers; each vector is associated with an access mode. By default, all of the primary exception vectors are empty. Exception vectors are used primarily for system programming, not application programming. The debugger uses the primary exception vector associated with user mode.

When an exception occurs, the operating system searches the primary exception associated with the access mode at which the exception occurred. To enter or cancel a condition handler in an exception vector, use the SYS\$SETEXV system service. Condition handlers that are entered into the exception vectors associated with kernel, executive, and supervisor modes remain in effect either until they are canceled or until you log out. Condition handlers that are entered into the exception vector associated with user mode remain in effect either until they are canceled or until the image that entered them exits.

2. Secondary exception vectors—A set of exception vectors with the same structure as the primary exception vectors. Exception vectors are primarily used for system programming, not application programming. By default, all of the secondary exception vectors are empty.
3. Call frame condition handlers—Each program unit can establish one condition handler (the address of the handler is placed in the call frame of the program unit). The operating system searches for condition handlers established by your program, beginning with the current program unit. If the current program unit has not established a condition handler, the operating system searches for a handler that was established by the program unit that invoked the current program unit, and so on back to the main program.



## Condition-Handling Routines and Services

### 9.6 Exception Dispatcher

4. Traceback handler—If you do not establish any condition handlers and link your program with the /TRACEBACK qualifier of the LINK command (the default), the operating system finds and invokes the traceback handler.
5. Catchall handler—If you do not establish any condition handlers and you link your program with the /NOTRACEBACK qualifier to the LINK command, the operating system finds and invokes the catchall handler. The catchall handler is at the bottom of the user stack and in the last-chance exception vector.
6. Last-chance exception vectors—A set of exception vectors with the same structure as the primary and secondary exception vectors. Exception vectors are used primarily for system programming, not application programming. By default, the user- and supervisor-mode last-chance exception vectors are empty. The executive- and kernel-mode last-chance exception vectors contain procedures that cause a bugcheck (a nonfatal bugcheck results in an error log entry; a fatal bugcheck results in a system shutdown). The debugger uses the user-mode last-chance exception vector, and DCL uses the supervisor-mode last-chance exception vector.

The search is terminated when the dispatcher finds a condition handler. If the dispatcher cannot find a user-specified condition handler, it calls the condition handler whose address is stored in the last-chance exception vector. If the image was activated by the command language interpreter, the last-chance vector points to the catchall condition handler. The catchall handler issues a message and either continues program execution or causes the image to exit, depending on whether the condition was a warning or an error condition, respectively.

You can call the catchall handler in two ways:

- If the last-chance exception vector either returns to the dispatcher or is empty, then it calls the catchall condition handler and exits with the return status code `SS$_NOHANDLER`.
- If the exception dispatcher detects an access violation, it calls the catchall condition handler and exits with the return status code `SS$_ACCVIO`.

Figure 9–4 illustrates the exception dispatcher’s search of the call stack for a condition handler.

# Condition-Handling Routines and Services

## 9.6 Exception Dispatcher

Figure 9-4 Searching the Stack for a Condition Handler

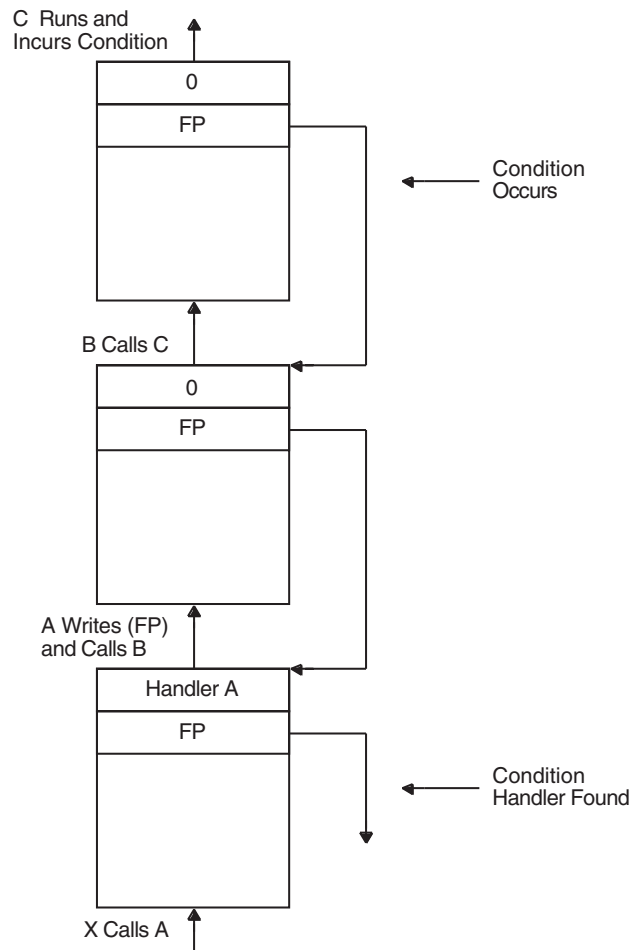

- 1 The illustration of the call stack indicates the calling sequence: Procedure A calls procedure B, and procedure B calls procedure C. Procedure A establishes a condition handler.
- 2 An exception occurs while procedure C is executing. The exception dispatcher searches for a condition handler.
- 3 After checking for a condition handler declared in the exception vectors (assume that none has been specified for the process), the dispatcher looks at the first longword of procedure C's call frame. A value of 0 indicates that no condition handler has been specified. The dispatcher locates the call frame for procedure B by using the frame pointer (FP) in procedure C's call frame. Again, it finds no condition handler, and locates procedure A's call frame.
- 4 The dispatcher locates and gives control to handler A.

ZK-0858-GE

## Condition-Handling Routines and Services

### 9.6 Exception Dispatcher

In cases where the default condition handling is insufficient, you can establish your own handler by one of the mechanisms described in Section 9.2.1. Typically, you need condition handlers only if your program must perform one of the following operations:

- Respond to condition values that are signaled rather than returned, such as an integer overflow error. (Section 9.14.3 describes the system-defined handler LIB\$SIG\_TO\_RET that allows you to treat signals as return values; Section 9.4.2 describes other useful system-defined handlers for arithmetic errors.)
- Modify part of a condition code, such as the severity. See Section 9.5.2 for more information. If you want to change the severity of any condition code to a severe error, you can use the run-time library procedure LIB\$STOP instead of writing your own condition handler.
- Add messages to the one associated with the originally signaled condition code or log the messages associated with the originally signaled condition code.

## 9.7 Argument List Passed to a Condition Handler

On VAX systems, the argument list passed to the condition handler is constructed on the stack and consists of the addresses of two argument arrays, signal and mechanism, as illustrated in Section 9.8.2 and Section 9.8.3.

On Alpha systems, the arrays are set up on the stack, but any argument is passed in registers.

On VAX systems, you can use the \$CHFDEF macro instruction to define the symbolic names to refer to the arguments listed in Table 9–9.

**Table 9–9 \$CHFDEF Symbolic Names and Arguments on VAX Systems**

Symbolic Name	Related Argument
CHF\$L_SIGARGLST	Address of signal array
CHF\$L_MCHARGLST	Address of mechanism array
CHF\$L_SIG_ARGS	Number of signal arguments
CHF\$L_SIG_NAME	Condition name
CHF\$L_SIG_ARG1	First signal-specific argument
CHF\$L_MCH_ARGS	Number of mechanism arguments
CHF\$L_MCH_FRAME	Establisher frame address
CHF\$L_MCH_DEPTH	Frame depth of establisher
CHF\$L_MCH_SAVR0	Saved register R0
CHF\$L_MCH_SAVR1	Saved register R1

On Alpha systems, you can use the \$CHFDEF2 macro instruction to define the symbolic names to refer to the arguments listed in Table 9–10.

## Condition-Handling Routines and Services

### 9.7 Argument List Passed to a Condition Handler

**Table 9–10 \$CHFDEF2 Symbolic Names and Arguments on Alpha Systems**

Symbolic Name	Related Argument
CHF\$L_SIGARGLST	Address of signal array
CHF\$L_MCHARGLST	Address of mechanism array
CHF\$IS_SIG_ARGS	Number of signal arguments
CHF\$IS_SIG_NAME	Condition name
CHF\$IS_SIG_ARG1	First signal-specific argument
CHF\$IS_MCH_ARGS	Number of mechanism arguments
CHF\$IS_MCH_FLAGS	Flag bits <63:0> for related argument mechanism information
CHF\$PH_MCH_FRAME	Establisher frame address
CHF\$IS_MCH_DEPTH	Frame depth of establisher
CHF\$PH_MCH_DADDR	Address of the handler data quadword if the exception handler data field is present
CHF\$PH_MCH_ESF_ADDR	Address of the exception stack frame
CHF\$PH_MCH_SIG_ADDR	Address of the signal array
CHF\$IH_MCH_SAVR $nn$	A copy of the saved integer registers at the time of the exception
CHF\$FH_MCH_SAVF $nn$	A copy of the saved floating-point registers at the time of the exception

## 9.8 Signaling

Signaling can be initiated when hardware or software detects an exception condition. In either case, the exception condition is said to be signaled by the routine in which it occurred. If hardware detects the error, it passes control to a condition dispatcher. If software detects the error, it calls one of the run-time library signal-generating routines: LIB\$SIGNAL or LIB\$STOP. The RTL signal-generating routines pass control to the same condition dispatcher. When LIB\$STOP is called, the severity code is forced to severe, and control cannot return to the routine that signaled the condition. See Section 9.12.1 for a description of how a signal can be dismissed and how normal execution from the point of the exception condition can be continued.

When a routine signals, it passes to the OpenVMS Condition Handling facility (CHF) the condition value associated with the exception condition, as well as optional arguments that can be passed to a condition handler. The CHF uses these arguments to build two data structures on the stack:

- The signal argument vector. This vector contains the information describing the nature of the exception condition.
- The mechanism argument vector. This vector describes the state of the process at the time the exception condition occurred.

These two vectors become the arguments that the CHF passes to condition handlers.

These argument vectors are described in detail in Section 9.8.2 and Section 9.8.3.

## Condition-Handling Routines and Services

### 9.8 Signaling

After the signal and mechanism argument vectors are set up, the CHF searches for enabled **condition handlers**. A condition handler is a separate routine that has been associated with a routine in order to take a specific action when an exception condition occurs. The CHF searches for condition handlers to handle the exception condition, beginning with the primary exception vector of the access mode in which the exception condition occurred. If this vector contains the address of a handler, that handler is called. If the address is 0 or if the handler resignals, then the CHF repeats the process with the secondary exception vector. Enabling vectored handlers is discussed in detail in the *OpenVMS Calling Standard*. Because the exception vectors are allocated in static storage, they are not generally used by modular routines.

If neither the primary nor secondary vectored handlers handle the exception condition by continuing program execution, then the CHF looks for stack frame condition handlers. It looks for the address of a condition handler in the first longword of the routine stack frame on VAX systems, or in the procedure descriptor (in which the handler valid bit is set) for the routine stack frame on Alpha systems where the exception condition occurred. At this point, several actions are possible, depending on the results of this search:

- If this routine has not set up a condition handler, the CHF continues the stack scan by moving to the previous stack frame (that is, the stack frame of the calling routine).
- If a condition handler is present, the CHF then calls this handler, which may resignal, continue, or unwind. See Section 9.10.

The OpenVMS Condition Handling facility searches for and calls condition handlers from each frame on the stack until the frame pointer is zero (indicating the end of the call sequence). At that point, the CHF calls the vectored catchall handler, which displays an error message and causes the program to exit. Note that, normally, the frame containing the stack catchall handler is at the end of the calling sequence or at the bottom of the stack. Section 9.9 explains the possible actions of default and user condition handlers in more detail.

Figure 9–5 illustrates a stack scan for condition handlers in which the main program calls procedure A, which then calls procedure B. A stack scan is initiated either when a hardware exception condition occurs or when a call is made to LIB\$SIGNAL or LIB\$STOP.

# Condition-Handling Routines and Services

## 9.8 Signaling

Figure 9–5 Sample Stack Scan for Condition Handlers

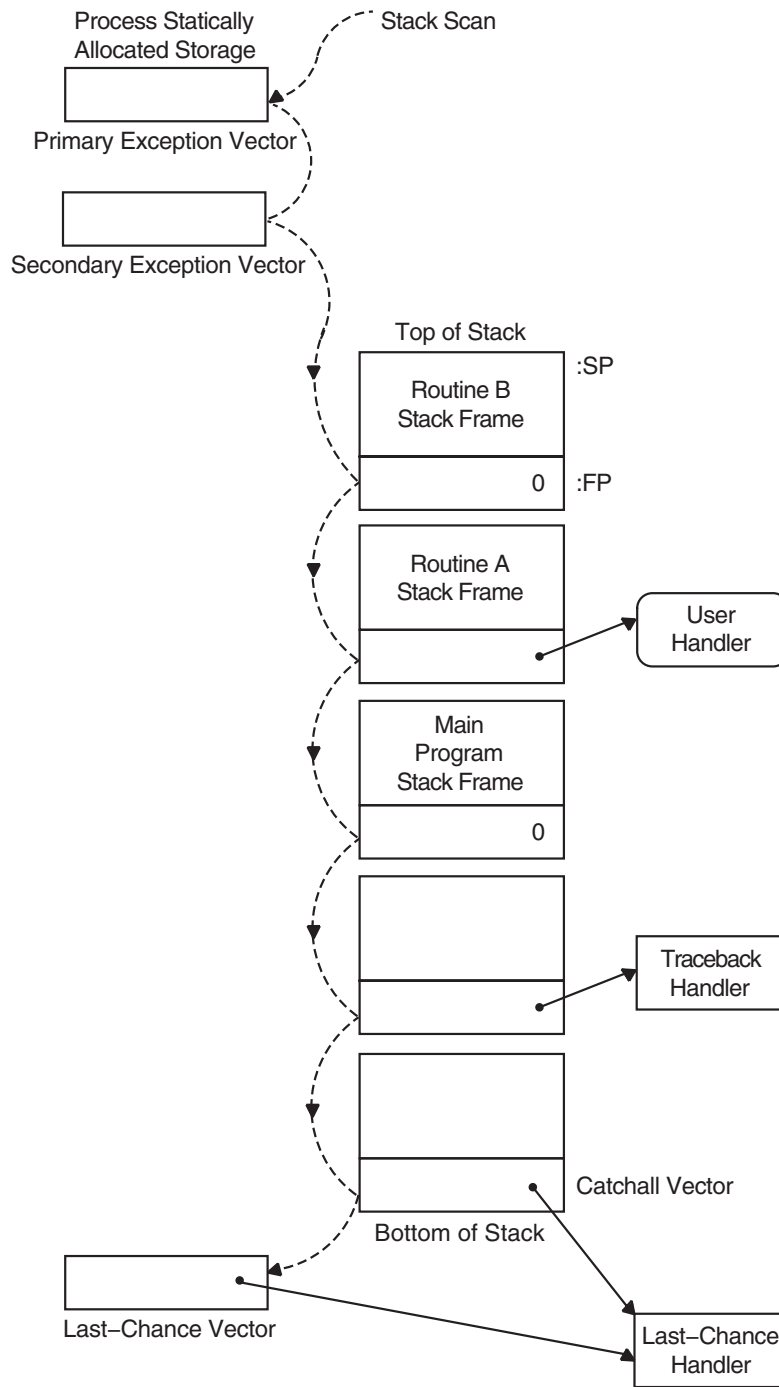

ZK-1935-GE

### 9.8.1 Generating Signals with LIB\$SIGNAL and LIB\$STOP

When software detects an exception condition, the software normally calls one of the run-time library signal-generating routines, LIB\$SIGNAL or LIB\$STOP, to initiate the signaling mechanism. This call indicates to the calling program that the exception condition has occurred. Your program can also call one of these routines explicitly to indicate an exception condition.

### LIB\$SIGNAL Routine

You can signal a condition code by invoking the run-time library procedure LIB\$SIGNAL and passing the condition code as the first argument. (The *OpenVMS RTL Library (LIB\$) Manual* contains the complete specifications for LIB\$SIGNAL.) The following statement signals the condition code contained in the variable STATUS:

```
CALL LIB$SIGNAL (%VAL(STATUS))
```

When an error occurs in a subprogram, the subprogram can signal the appropriate condition code rather than return the condition code to the invoking program unit. In addition, some statements also signal condition codes; for example, an assignment statement that attempts to divide by zero signals the condition code SS\$\_INTDIV.

When your program wants to issue a message and allow execution to continue after handling the condition, it calls the standard routine, LIB\$SIGNAL. The calling sequence for LIB\$SIGNAL is the following:

```
LIB$SIGNAL condition-value [,condition-argument...]  
            [,condition-value-n [,condition-argument-n...]]...
```

Only the **condition-value** argument must be specified; other arguments are optional. A description of the arguments is as follows:

#### condition-value

OpenVMS usage: cond\_value  
type: longword (unsigned)  
access: read only  
mechanism: by value

OpenVMS 32-bit condition value. The **condition-value** argument is an unsigned longword that contains this condition value. Section 9.5 explains the format of a condition value.

#### condition-argument

OpenVMS usage: varying\_arg  
type: unspecified  
access: read only  
mechanism: by value

As many arguments as are required to process the exception specified by **condition-value**. These arguments are also used as FAO (formatted ASCII output) arguments to format a message.

#### condition-value-n

OpenVMS usage: cond\_value  
type: longword (unsigned)  
access: read only  
mechanism: by value

OpenVMS 32-bit condition value. The optional **condition-value-n** argument is an unsigned longword that contains this condition value. The calling routine can specify additional conditions to be processed by specifying **condition-value-2** through **condition-value-n**, with each condition value followed by

## Condition-Handling Routines and Services

### 9.8 Signaling

any arguments required to process the condition specified. However, the total number of arguments in the call to LIB\$SIGNAL must not exceed 253.

#### **condition-argument-n**

OpenVMS usage:       varying\_arg  
type:                unspecified  
access:              read only  
mechanism:           by value

As many arguments as required to create the message reporting the exception specified by **condition-value-n**.

#### **LIB\$STOP**

When your program wants to issue a message and stop execution unconditionally, it calls LIB\$STOP. The calling sequence for LIB\$STOP is as follows:

```
LIB$STOP condition-value [,number-of-arguments] [,FAO-argument...]
```

Only the **condition-value** argument must be specified; other arguments are optional. The **condition-value** argument is an OpenVMS 32-bit condition value. The **condition-value** argument is an unsigned longword that contains this condition value.

The **number-of-arguments** argument, if specified, contains the number of FAO arguments that are associated with **condition-value**. The optional **number-of-arguments** argument is a signed longword integer that contains this number. If omitted or specified as zero, no FAO arguments follow.

The **FAO-argument** argument is an optional FAO (formatted ASCII output) argument that is associated with the specified condition value.

The **condition-value** argument indicates the condition that is being signaled. However, LIB\$STOP always sets the severity of **condition-value** to SEVERE before proceeding with the stack-scanning operation.

The FAO arguments describe the details of the exception condition. These are the same arguments that are passed to the OpenVMS Condition Handling facility as part of the signal argument vector. The system default condition handlers pass them to SYS\$PUTMSG, which uses them to issue a system message.

Unlike most routines, LIB\$SIGNAL and LIB\$STOP preserve R0 and R1 as well as the other registers. Therefore, a call to LIB\$SIGNAL allows the debugger to display the entire state of the process at the time of the exception condition. This is useful for debugging checks and gathering statistics.

The behavior of LIB\$SIGNAL is the same as that of the exception dispatcher that performs the stack scan after hardware detects an exception condition. That is, the system scans the stack in the same way, and the same arguments are passed to each condition handler. This allows a user to write a single condition handler to detect both hardware and software conditions.

For more information about the RTL routines LIB\$SIGNAL and LIB\$STOP, see *OpenVMS RTL Library (LIB\$) Manual*.



### 9.8.2 Signal Argument Vector

Signaling a condition value causes both VAX and Alpha systems to pass control to a special subprogram called a condition handler. The operating system invokes a default condition handler unless you have established your own. The default condition handler displays the associated error message and continues or, if the error is a severe error, terminates program execution.

The signal argument vector contains information describing the nature of the hardware or software condition. Figure 9–6 illustrates the open-ended structure of the signal argument vector, which can be from 3 to 257 longwords in length.

The format of the signal argument array and the data it returns is the same on VAX systems and Alpha systems, with the exception of the processor status (PS) returned on Alpha systems and the processor status longword (PSL) returned on VAX systems. On Alpha systems, it is the low-order 32 bits of the PS.

On Alpha systems, CHF\$IS\_SIG\_ARGS and CHF\$IS\_SIG\_NAME are aliases for CHF\$L\_SIG\_ARGS and CHF\$L\_SIG\_NAME, as shown in Figure 9–6, and the PSL field for VAX systems is the processor status (PS) field for Alpha systems.

**Figure 9–6 Format of the Signal Argument Vector**

	<b>MACRO and BLISS</b>	<b>High-Level Languages</b>
n = Additional Longwords	CHF\$L_SIG_ARGS	SIGARGS(1)
Condition Value	CHF\$L_SIG_NAME	SIGARGS(2)
Optional Additional Arguments Making Up One or More Message Sequences		
PC		SIGARGS(n)
PSL		SIGARGS(n + 1)

ZK–1963–GE

#### Fields of the Signal Argument Vector

##### **SIGARGS(1)**

An unsigned integer (*n*) designating the number of longwords that follow in the vector, not counting the first, including PC and PSL. (On Alpha systems, the value used for the PSL is the low-order half of the Alpha processor status [PS] register.) For example, the first entry of a 4-longword vector would contain a 3.

##### **SIGARGS(2)**

On both VAX systems and Alpha systems, this argument is a 32-bit value that uniquely identifies a hardware or software exception condition. The format of the condition code, which is the same for both VAX systems and Alpha systems, is shown and described in Figure 9–3. However, Alpha systems do not support every condition returned on VAX systems, and Alpha systems define several new conditions that cannot be returned on VAX systems. Table 9–2 lists VAX system condition codes that cannot be returned on Alpha systems.

## Condition-Handling Routines and Services

### 9.8 Signaling

If more than one message is associated with the error, this is the condition value of the first message. Handlers should always check whether the condition is the one that they expect by examining the STS\$V\_COND\_ID field of the condition value (bits <27:3>). Bits <2:0> are the severity field. Bits <31:28> are control bits; they may have been changed by an intervening handler and so should not be included in the comparison. You can use the RTL routine LIB\$MATCH\_COND to match the correct fields. If the condition is not expected, the handler should resignal by returning false (bit <0> = 0). The possible exception conditions and their symbolic definitions are listed in Table 9-1.

#### **SIGARGS(3 to n -1)**

Optional arguments that provide additional information about the condition. These arguments consist of one or more message sequences. The format of the message description varies depending on the type of message being signaled. For more information, see the SYS\$PUTMSG description in the *OpenVMS System Services Reference Manual*. The format of a message sequence is described in Section 9.11.

#### **SIGARGS(n)**

The program counter (PC) of the next instruction to be executed if any handler (including the system-supplied handlers) returns with the status SS\$\_CONTINUE. For hardware faults, the PC is that of the instruction that caused the fault. For hardware traps, the PC is that of the instruction following the one that caused the trap. The error generated by LIB\$SIGNAL is a trap. For conditions signaled by calling LIB\$SIGNAL or LIB\$STOP, the PC is the location following the CALLS or CALLG instruction. See the *VAX Architecture Reference Manual* or *Alpha Architecture Reference Manual* for a detailed description of faults and traps.

#### **SIGARGS(n+1)**

On VAX systems the processor status longword (PSL), or on Alpha systems the processor status (PS) register, of the program at the time that the condition was signaled.

For information about the PSL on VAX systems, and the PS on Alpha systems, see the *VAX Architecture Reference Manual* and the *Alpha Architecture Reference Manual*.

---

#### **Note**

---

LIB\$SIGNAL and LIB\$STOP copy the variable-length argument list passed by the caller. Then, before calling a condition handler, they append the PC and PSL (or on Alpha systems the processor status (PS) register) entries to the end of the list.

---

The formats for some conditions signaled by the operating system and the run-time library are shown in Figure 9-7 and Figure 9-8. These formats are the same on VAX systems and Alpha systems, except for the PSL, or on Alpha systems, the PS register.

**Figure 9–7 Signal Argument Vector for the Reserved Operand Error Conditions**

3	Additional Longwords
SS\$_ROPRAND	Condition Value
PC	PC of Instruction Causing Fault
PSL	

ZK–1964–GE

**Figure 9–8 Signal Argument Vector for RTL Mathematics Routine Errors**

5	Additional Longwords
MTH\$_abcmnoxyz	Math Condition Value
1	Number of FAO Arguments
Caller's PC	PC Following JSB or CALL
PC	PC Following Call to LIB\$SIGNAL
PSL	

ZK–1965–GE

The caller's PC is the PC following the calling program's JSB or CALL to the mathematics routine that detected the error. The PC is that following the call to LIB\$SIGNAL.

### 9.8.3 VAX Mechanism Argument Vector (VAX Only)

On VAX systems, the mechanism argument vector is a 5-longword vector that contains all of the information describing the state of the process at the time of the hardware or software signaled condition. Figure 9–9 illustrates a mechanism argument vector for VAX systems.

## Condition-Handling Routines and Services

### 9.8 Signaling

Figure 9–9 Format of a VAX Mechanism Argument Vector

	MACRO and BLISS	High-Level Languages
4 = Additional Longwords	CHF\$L_MCH_ARGS	MCHARGS(1)
Frame	CHF\$L_MCH_FRAME	MCHARGS(2)
Depth	CHF\$L_MCH_DEPTH	MCHARGS(3)
Saved R0	CHF\$L_MCH_SAVR0	MCHARGS(4)
Saved R1	CHF\$L_MCH_SAVR1	MCHARGS(5)

ZK-1966-GE

#### Fields of the VAX Mechanism Argument Vector

##### MCHARGS(1)

An unsigned integer indicating the number of longwords that follow, not counting the first, in the vector. Currently, this number is always 4.

##### MCHARGS(2)

The address of the stack frame of the routine that established the handler being called. You can use this address as a base from which to reference the local stack-allocated storage of the establisher, as long as the restrictions on the handler's use of storage are observed. For example, if the call stack is as shown in Figure 9–4, this argument points to the call frame for procedure A.

You can use this value to display local variables in the procedure that established the condition handler if the variables are at known offsets from the frame pointer (FP) of the procedure.

##### MCHARGS(3)

The stack depth, which is the number of stack frames between the establisher of the condition handler and the frame in which the condition was signaled. To ensure that calls to LIB\$SIGNAL and LIB\$STOP appear as similar as possible to hardware exception conditions, the call to LIB\$SIGNAL or LIB\$STOP is not included in the depth.

If the routine that contained the hardware exception condition or that called LIB\$SIGNAL or LIB\$STOP also handled the exception condition, then the depth is zero; if the exception condition occurred in a called routine and its caller handled the exception condition, then the depth is 1. If a system service signals an exception condition, a handler established by the immediate caller is also entered with a depth of 1.

The following table shows the stack depths for the establishers of condition handlers:

Depth	Meaning
-3	Condition handler was established in the last-chance exception vector.
-2	Condition handler was established in the primary exception vector.
-1	Condition handler was established in the secondary exception vector.

Depth	Meaning
0	Condition handler was established by the frame that was active when the exception occurred.
1	Condition handler was established by the caller of the frame that was active when the exception occurred.
2	Condition handler was established by the caller of the caller of the frame that was active when the exception occurred.
.	
.	
.	

For example, if the call stack is as shown in Figure 9–4, the depth argument passed to handler A would have a value of 2.

The condition handler can use this argument to determine whether to handle the condition. For example, the handler might not want to handle the condition if the exception that caused the condition did not occur in the establisher frame.

#### **MCHARGS(4) and MCHARGS(5)**

Copies of the contents of registers R0 and R1 at the time of the exception condition or the call to LIB\$SIGNAL or LIB\$STOP. When execution continues or a stack unwind occurs, these values are restored to R0 and R1. Thus, a handler can modify these values to change the function value returned to a caller.

### **9.8.4 Alpha Mechanism Argument Vector (Alpha Only)**

On Alpha systems, the mechanism array returns much the same data as it does on VAX systems, though its format is changed. The mechanism array returned on Alpha systems preserves the contents of a larger set of integer scratch registers as well as the Alpha floating-point scratch registers. In addition, because Alpha registers are 64 bits long, the mechanism array is constructed of quadwords (64 bits), not longwords (32 bits) as it is on VAX systems. Figure 9–10 shows the format of the mechanism array on Alpha systems.

# Condition-Handling Routines and Services

## 9.8 Signaling

**Figure 9–10 Mechanism Array on Alpha Systems**

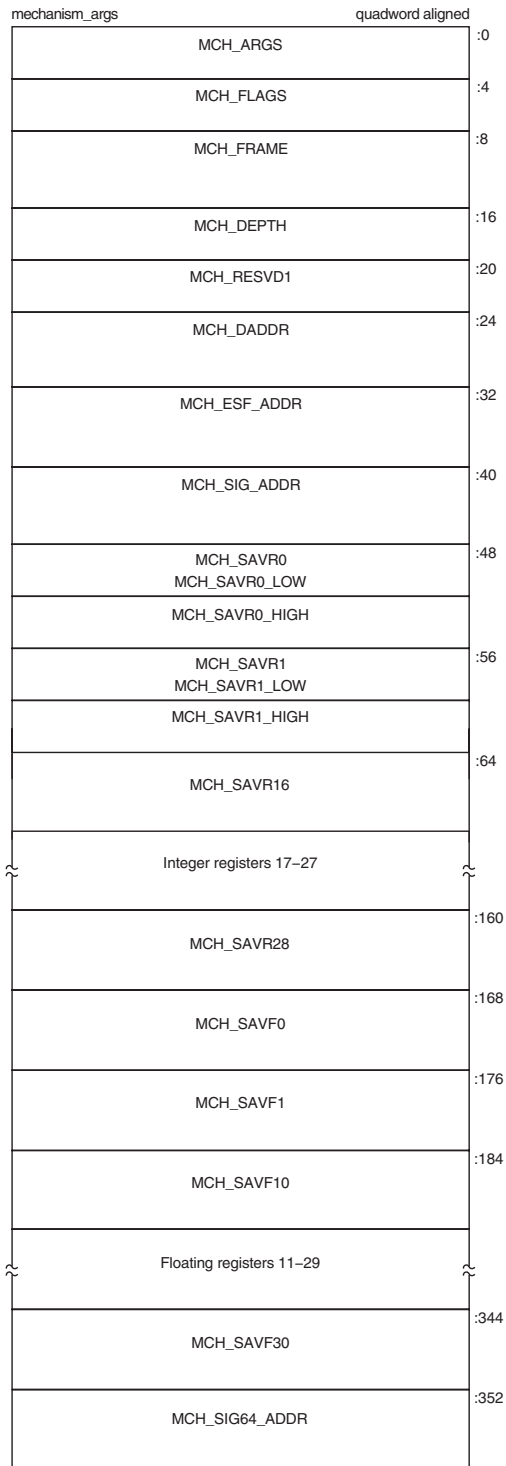

CHF\$\$\_CHFDEF2 = 360

ZK-4645A-GE

Table 9–11 describes the arguments in the mechanism array.

**Table 9–11 Fields in the Alpha Mechanism Array**

Argument	Description
CHF\$IS_MCH_ARGS	Represents the number of quadwords in the mechanism array, not counting the argument count quadword. (The value contained in this argument is always 43.)
CHF\$IS_MCH_FLAGS	Flag bits <63:0> for related argument mechanism information defined as follows for CHF\$V_FPREGS:  Bit <0>: When set, the process has already performed a floating-point operation and the floating-point registers stored in this structure are valid.  If this bit is clear, the process has not yet performed any floating-point operations, and the values in the floating-point register slots in this structure are unpredictable.
CHF\$PH_MCH_FRAME	The frame pointer (FP) in the procedure context of the establisher.
CHF\$IS_MCH_DEPTH	Positive count of the number of procedure activation stack frames between the frame in which the exception occurred and the frame depth that established the handler being called.
CHF\$PS_MCH_DADDR	Address of the handler data quadword if the exception handler data field is present (as indicated by PDSC.FLAGS.HANDLER_DATA_VALID); otherwise, contains zero.
CHF\$PH_MCH_ESF_ADDR	Address of the exception stack frame (see the <i>Alpha Architecture Reference Manual</i> ).
CHF\$PH_MCH_SIG_ADDR	Address of the signal array. The signal array is a 32-bit (longword) array.
CHF\$IH_MCH_SAVR <sub>nn</sub>	A copy of the saved integer registers at the time of the exception. The following registers are saved: R0, R1, and R16–R28. Registers R2–R15 are implicitly saved in the call chain.
CHF\$FM_MCH_SAVF <sub>nn</sub>	A copy of the saved floating-point registers at the time of the exception or may have unpredictable data as described in CHF\$IS_MCH_FLAGS. If the floating-point register fields are valid, the following registers are saved: F0, F1, and F10–F30. Registers F2–F9 are implicitly saved in the call chain.

For more information and recommendations about using the mechanism argument vector on Alpha systems, see *Migrating to an OpenVMS AXP System: Recompiling and Relinking Applications*. Note that this manual has been archived but is available on the OpenVMS Documentation CD-ROM.

### 9.8.5 Multiple Active Signals

A signal is said to be active until the routine that signaled regains control or until the stack is unwound or the image exits. A second signal can occur while a condition handler or a routine it has called is executing. This situation is called **multiple active signals** or **multiple exception conditions**. When this situation occurs, the stack scan is not performed in the usual way. Instead, the frames that were searched while processing all of the previous exception conditions are skipped when the current exception condition is processed. This is done in order to avoid recursively reentering a routine that is not reentrant. For

## Condition-Handling Routines and Services

### 9.8 Signaling

example, Fortran code typically is not recursively reentrant. If a Fortran handler were called while another activation of that handler was still going, the results would be unpredictable.

A second exception may occur while a condition handler or a procedure that it has called is still executing. In this case, when the exception dispatcher searches for a condition handler, it skips the frames that were searched to locate the first handler.

The search for a second handler terminates in the same manner as the initial search, as described in Section 9.6.

If the SYS\$UNWIND system service is issued by the second active condition handler, the depth of the unwind is determined according to the same rules followed in the exception dispatcher's search of the stack: all frames that were searched for the first condition handler are skipped.

Primary and secondary vectored handlers, on the other hand, are always entered when an exception occurs.

If an exception occurs during the execution of a handler that was established in the primary or secondary exception vector, that handler must handle the additional condition. Failure to do so correctly might result in a recursive exception loop in which the vectored handler is repeatedly called until the user stack is exhausted.

The modified search routine is best illustrated with an example. Assume the following calling sequence:

1. Routine A calls routine B, which calls routine C.
2. Routine C signals an exception condition (signal S), and the handler for routine C (CH) resigns.
3. Control passes to BH, the handler for routine B. The call frame for handler BH is located on top of the signal and mechanism arrays for signal S. The saved frame pointer in the call frame for BH points to the frame for routine C.
4. BH calls routine X; routine X calls routine Y.
5. Routine Y signals a second exception condition (signal T). Figure 9-11 illustrates the stack contents after the second exception condition is signaled.

Normally, the OpenVMS Condition Handling facility (CHF) searches all currently active frames for condition handlers, including B and C. If this happens, however, BH is called again. At this point, you skip the condition handlers that have already been called. Thus, the search for condition handlers should proceed in the following order:

```
YH
XH
BHH (the handler for routine B's handler)
AH
```

6. The search now continues in its usual fashion. The CHF examines the primary and secondary exception vectors, then frames Y, X, and BH. Thus, handlers YH, XH, and BHH are called. Assume that these handlers resignal.



**Figure 9–11 Stack After Second Exception Condition Is Signaled**

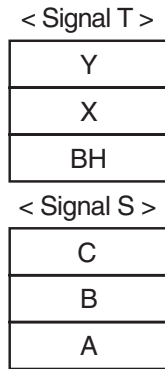

ZK-1968-GE

7. The CHF now skips the frames that have already been searched and resumes the search for condition handlers in routine A's frame. The depths that are passed to handlers as a result of this modified search are 0 for YH, 1 for XH, 2 for BHH, and 3 for AH.

Because of the possibility of multiple active signals, you should be careful if you use an exception vector to establish a condition handler. Vectored handlers are called, not skipped, each time an exception occurs.

## 9.9 Types of Condition Handlers

On VAX systems, when a routine is activated, the first longword in its stack frame is set to 0. This longword is reserved to contain an address pointing to another routine called the condition handler. If an exception condition is signaled during the execution of the routine, the OpenVMS Condition Handling Facility uses the address in the first longword of the frame to call the associated condition handler.

On Alpha systems, each procedure, other than a null frame procedure, can have a condition handler potentially associated with it, identified by the `HANDLER_VALID`, `STACK_HANDLER`, or `REG_HANDLER` field of the associated procedure descriptor. You establish a handler by including the procedure value of the handler procedure in that field.

The arguments passed to the condition-handling routine are the signal and mechanism argument vectors, described in Section 9.8.2, Section 9.8.3, and Section 9.8.4.

Various types of condition handlers can be called for a given routine:

- **User-supplied condition handlers**  
 You can write your own condition handler and set up its address in the stack frame of your routine using the run-time library routine `LIB$ESTABLISH` or the mechanism supplied by your language.  
 On Alpha systems, `LIB$ESTABLISH` is not supported, though high-level languages may support it for compatibility.
- **Language-supplied condition handlers**

## Condition-Handling Routines and Services

### 9.9 Types of Condition Handlers

Many high-level languages provide a means for setting up handlers that are global to a single routine. If your language provides a condition-handling mechanism, you should always use it. If you also try to establish a condition handler using `LIB$ESTABLISH`, the two methods of handling exception conditions conflict, and the results are unpredictable.

- System default condition handlers

The operating system provides a set of default condition handlers. These take over if there are no other condition handler addresses on the stack, or if all the previous condition handlers have passed on (resignaled) the indication of the exception condition.

#### 9.9.1 Default Condition Handlers

The operating system establishes the following default condition handlers each time a new image is started. The default handlers are shown in the order they are encountered when the operating system processes a signal. These three handlers are the only handlers that output error messages.

- Traceback handler

The traceback handler is established on the stack after the catchall handler. This enables the traceback handler to get control first. This handler performs three functions in the following order:

1. Outputs an error message using the Put Message (`SYS$PUTMSG`) system service. `SYS$PUTMSG` formats the message using the Formatted ASCII Output (`SYS$FAO`) system service and sends the message to the devices identified by the logical names `SYS$ERROR` and `SYS$OUTPUT` (if it differs from `SYS$ERROR`). That is, it displays the message associated with the signaled condition code, the traceback message, the program unit name and line number of the statement that signaled the condition code, and the relative and absolute program counter values. (On a warning or error, the number of the next statement to be executed is displayed.)
2. Issues a symbolic traceback, which shows the state of the routine stack at the time of the exception condition. That is, it displays the names of the program units in the calling hierarchy and the line numbers of the invocation statements.

## Condition-Handling Routines and Services

### 9.9 Types of Condition Handlers

3. Decides whether to continue executing the image or to force an exit based on the severity field of the condition value:

Severity	Error Type	Action
1	Success	Continue
3	Information	Continue
0	Warning	Continue
2	Error	Continue
4	Severe	Exit

The traceback handler is in effect if you link your program with the /TRACEBACK qualifier of the LINK command (the default). Once you have completed program development, you generally link your program with the /NOTRACEBACK qualifier and use the catchall handler.

- Catchall handler

The operating system establishes the catchall handler in the first stack frame and thus calls it last. This handler performs the same functions as the traceback handler except for the stack traceback. That is, it issues an error message and decides whether to continue execution. The catchall is called only if you link with the /NOTRACEBACK qualifier. It displays the message associated with the condition code and then continues program execution or, if the error is severe, terminates execution.

- Last-chance handler

The operating system establishes the last-chance handler with a system exception vector. In most cases, this vector contains the address of the catchall handler, so that these two handlers are actually the same. The last-chance handler is called only if the stack is invalid or all the handlers on the stack have resigned. If the debugger is present, the debugger's own last-chance handler replaces the system last-chance handler.

Displays the message associated with the condition code and then continues program execution or, if the error is severe, terminates execution. The catchall handler is not invoked if the traceback handler is enabled.

In the following example, if the condition code INCOME\_LINELOST is signaled at line 496 of GET\_STATS, regardless of which default handler is in effect, the following message is displayed:

```
%INCOME-W-LINELOST, Statistics on last line lost due to CTRL/Z
```

If the traceback handler is in effect, the following text is also displayed:

```
%TRACE-W-TRACEBACK, symbolic stack dump follows
module name      routine name      line      rel PC      abs PC
GET_STATS        GET_STATS        497      00000306   00008DA2
INCOME           INCOME           148      0000015A   0000875A
                  0000A5BC        0000A5BC
                  00009BDB        00009BDB
                  0000A599        0000A599
```

Because INCOME\_LINELOST is a warning, the line number of the next statement to be executed (497), rather than the line number of the statement that signaled the condition code, is displayed. Line 148 of the program unit INCOME invoked GET\_STATS.

## Condition-Handling Routines and Services

### 9.9 Types of Condition Handlers

#### 9.9.2 Interaction Between Default and User-Supplied Handlers

Several results are possible after a routine signals, depending on a number of factors, such as the severity of the error, the method of generating the signal, and the action of the condition handlers you have defined and the default handlers. Given the severity of the condition and the method of signaling, Figure 9–12 lists all combinations of interaction between user condition handlers and default condition handlers.

**Figure 9–12 Interaction Between Handlers and Default Handlers**

Severity of Condition	User Handler Specifies CONTINUE	User Handler Specifies UNWIND	Default Handler Gets Control	No Handler Found (Bad Stack)
<b>Exception Condition Is Signaled by a Call to LIB\$SIGNAL or Detected by Hardware</b>				
WARNING, INFO, or ERROR	RETURN	UNWIND	Issue Condition Message RETURN	Call Last-Chance Handler EXIT
SEVERE	RETURN	UNWIND	Issue Condition Message EXIT	Call Last-Chance Handler EXIT
<b>Exception Condition Is Signaled by a Call to LIB\$STOP</b>				
LIB\$STOP Forces Severity to SEVERE	Message: "Attempt to continue from stop" EXIT	UNWIND	Issue Condition Message EXIT	Call Last-Chance Handler EXIT

ZK-4257-GE

## 9.10 Types of Actions Performed by Condition Handlers

When a condition handler returns control to the OpenVMS Condition Handling facility (CHF), the facility takes one of the following types of actions, depending on the value returned by the condition handler:

- Signal a condition

Signaling a condition initiates the search for an established condition handler.

- Continue

The condition handler may or may not be able to fix the problem, but the program can attempt to continue execution. The handler places the return status value `SS$_CONTINUE` in R0 and issues a `RET` instruction to return control to the dispatcher. If the exception was a fault, the instruction that caused it is reexecuted; if the exception was a trap, control is returned at the instruction following the one that caused it. A condition handler cannot continue if the exception condition was signaled by calling `LIB$STOP`.

Section 9.12.1 contains more information about continuing.

- Resignal

The handler cannot fix the problem, or this condition is one that it does not handle. It places the return status value `SS$_RESIGNAL` in R0 and issues a `RET` instruction to return control to the exception dispatcher. The dispatcher resumes its search for a condition handler. If it finds another condition handler, it passes control to that routine. A handler can alter the severity of the signal before resignaling.

Section 9.12.2 contains more information about resignaling.

- Unwind

The condition handler cannot fix the problem, and execution cannot continue while using the current flow. The handler issues the Unwind Call Stack (`SYS$UNWIND`) system service to unwind the call stack. Call frames can then be removed from the stack and the flow of execution modified, depending on the arguments to the `SYS$UNWIND` service.

When a condition handler has already called `SYS$UNWIND`, any return status from the condition handler is ignored by the CHF. The CHF now unwinds the stack.

Unwinding the routine call stack first removes call frames, starting with the frame in which the condition occurred, and then returns control to an earlier routine in the calling sequence. You can unwind the stack whether the condition was detected by hardware or signaled using `LIB$SIGNAL` or `LIB$STOP`. Unwinding is the only way to continue execution after a call to `LIB$STOP`.

Section 9.12.3 describes how to write a condition handler that unwinds the call stack.

- Perform a nonlocal GOTO unwind

On Alpha systems, a GOTO unwind operation is a transfer of control that leaves one procedure invocation and continues execution in a prior (currently active) procedure. This unified GOTO operation gives unterminated procedure invocations the opportunity to clean up in an orderly way. See Section 9.10.2 for more information about GOTO unwind operations.

## Condition-Handling Routines and Services

### 9.10 Types of Actions Performed by Condition Handlers

#### 9.10.1 Unwinding the Call Stack

One type of action a condition handler can take is to unwind the procedure call stack. The unwind operation is complex and should be used only when control must be restored to an earlier procedure in the calling sequence. Moreover, use of the SYS\$UNWIND system service requires the calling condition handler to be aware of the calling sequence and of the exact point to which control is to return.

SYS\$UNWIND accepts two optional arguments:

- The depth to which the unwind is to occur. If the depth is 1, the call stack is unwound to the caller of the procedure that incurred the exception. If the depth is 2, the call stack is unwound to the caller's caller, and so on. By specifying the depth in the mechanism array, the handler can unwind to the procedure that established the handler.
- The address of a location to receive control when the unwind operation is complete, that is, a PC to replace the current PC in the call frame of the procedure that will receive control when all specified frames have been removed from the stack.

If no argument is supplied to SYS\$UNWIND, the unwind is performed to the caller of the procedure that established the condition handler that is issuing the SYS\$UNWIND service. Control is returned to the address specified in the return PC for that procedure. Note that this is the default and the normal case for unwinding.

Another common case of unwinding is to unwind to the procedure that declared the handler. On VAX systems, this is done by using the depth value from the exception mechanism array (CHF\$L\_MCH\_DEPTH) as the depth argument to SYS\$UNWIND. On Alpha systems, this is done by using the depth value from the exception mechanism array (CHF\$IS\_MCH\_DEPTH) as the depth argument to SYS\$UNWIND.

Therefore, it follows that the default unwind (no depth specified) is equivalent to specifying CHF\$L\_MCH\_DEPTH plus 1 on VAX systems. On Alpha systems, the default unwind (no depth specified) is equivalent to specifying CHF\$IS\_MCH\_DEPTH plus 1. In certain instances of nested exceptions, however, this is not the case. Compaq recommends that you omit the depth argument when unwinding to the caller of the routine that established the condition handler.

Figure 9–13 illustrates an unwind situation and describes some of the possible results.

The unwind operation consists of two parts:

1. In the call to SYS\$UNWIND, the return PCs saved in the stack are modified to point into a routine within the SYS\$UNWIND service, but the entire stack remains present.
2. When the handler returns, control is directed to this routine by the modified PCs. It proceeds to return to itself, removing the modified stack frames, until the stack has been unwound to the proper depth.

For this reason, the stack is in an intermediate state directly after calling SYS\$UNWIND. Handlers should, in general, return immediately after calling SYS\$UNWIND.

## Condition-Handling Routines and Services

### 9.10 Types of Actions Performed by Condition Handlers

During the actual unwinding of the call stack, the unwind routine examines each frame in the call stack to see whether a condition handler has been declared. If a handler has been declared, the unwind routine calls the handler with the status value `SS$_UNWIND` (indicating that the call stack is being unwound) in the condition name argument of the signal array. When a condition handler is called with this status value, it can perform any procedure-specific cleanup operations required. For example, the handler should deallocate any processwide resources that have been allocated. Then, the handler returns control to the OpenVMS Condition Handling facility. After the handler returns, the call frame is removed from the stack.

When a condition handler is called during the unwinding operation, the condition handler must not generate a new signal. A new signal would result in unpredictable behavior.

Thus, in Figure 9–13, handler B can be called a second time, during the unwind operation. Note that handler B does not have to be able to interpret the `SS$_UNWIND` status value specifically; the `RET` instruction merely returns control to the unwind procedure, which does not check any status values.

Handlers established by the primary, secondary, or last-chance vector are not called, because they are not removed during an unwind operation.

While it is unwinding the stack, the OpenVMS Condition Handling facility ignores any function value returned by a condition handler. For this reason, a handler cannot both resignal and unwind. Thus, the only way for a handler to both issue a message and perform an unwind is to call `LIB$SIGNAL` and then call `$UNWIND`. If your program calls `$UNWIND` before calling `LIB$SIGNAL`, the result is unpredictable.

When the OpenVMS Condition Handling facility calls the condition handler that was established for each frame during unwind, the call is of the standard form, described in Section 9.2. The arguments passed to the condition handler (the signal and mechanism argument vectors) are shown in Section 9.8.2, Section 9.8.3, and Section 9.8.4.

On VAX systems, if the handler is to specify the function value of the last function to be unwound, it should modify the saved copies of R0 and R1 (`CHF$L_MCH_SAVR0` and `CHF$L_MCH_SAVR1`) in the mechanism argument vector.

On Alpha systems, the handler should modify the saved copies of R0 and R1 (`CHF$IH_MCH_SAVRnn`).

R0 and R1 are restored from the mechanism argument vector at the end of the unwind.

# Condition-Handling Routines and Services

## 9.10 Types of Actions Performed by Condition Handlers

Figure 9–13 Unwinding the Call Stack

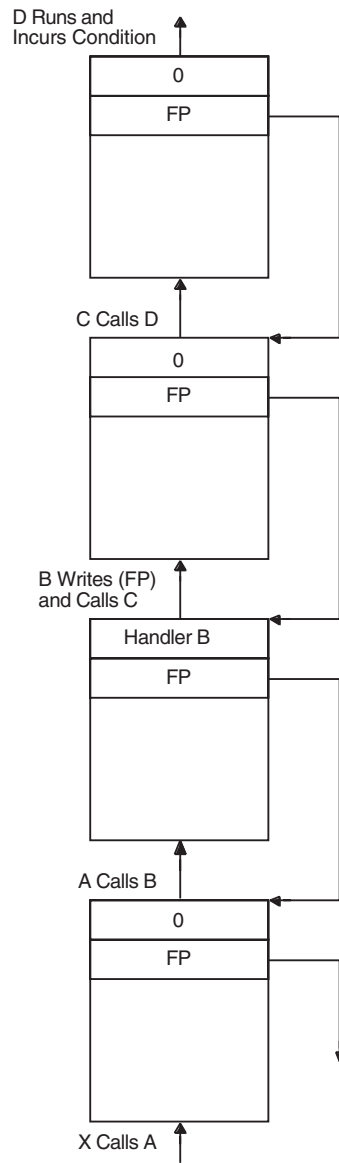

- 1 The procedure call stack is as shown. Assume that no exception vectors are declared for the process and that the exception occurs during the execution of procedure D.
- 2 Because neither procedure D nor procedure C has established a condition handler, handler B receives control.
- 3 If handler B issues the \$UNWIND system service with no arguments, the call frames for B, C, and D are removed from the stack (along with the call frame for handler B itself), and control returns to procedure A. Procedure A receives control at the point following its call to procedure B.
- 4 If handler B issues the \$UNWIND system service specifying a depth of 2, call frames for C and D are removed, and control returns to procedure B.

ZK-0860-GE



## Condition-Handling Routines and Services

### 9.10 Types of Actions Performed by Condition Handlers

#### 9.10.2 GOTO Unwind Operations (Alpha Only)

On Alpha systems, a current procedure invocation is one in whose context the thread of execution is currently executing. At any instant, a thread of execution has exactly one current procedure. If code in the current procedure calls another procedure, then the called procedure becomes the current procedure. As each stack frame or register frame procedure is called, its invocation context is recorded in a procedure frame. The invocation context is mainly a snapshot of process registers at procedure invocation. It is used during return from the called procedure to restore the calling procedure's state. The chain of all procedure frames starting with the current procedure and going all the way back to the first procedure invocation for the thread is called the **call chain**. While a procedure is part of the call chain, it is called an **active procedure**.

When a current procedure returns to its calling procedure, the most recent procedure frame is removed from the call chain and used to restore the now current procedure's state. As each current procedure returns to its calling procedure, its associated procedure frame is removed from the call chain. This is the normal unwind process of a call chain.

You can bypass the normal return path by forcibly unwinding the call chain. The Unwind Call Chain (SYS\$UNWIND) system service allows a condition handler to transfer control from a series of nested procedure invocations to a previous point of execution, bypassing the normal return path. The Goto Unwind (SYS\$GOTO\_UNWIND) system service allows any procedure to achieve the same effect. SYS\$GOTO\_UNWIND restores saved register context for each nested procedure invocation, calling the condition handler, if any, for each procedure frame that it unwinds. Restoring saved register context from each procedure frame from the most recent one to the target procedure frame ensures that the register context is correct when the target procedure gains control. Also, each condition handler called during unwind can release any resources acquired by its establishing procedure.

For information about the GOTO unwind operations and how to use the SYS\$GOTO\_UNWIND system service, see the *OpenVMS Calling Standard* and the *OpenVMS System Services Reference Manual*.

### 9.11 Displaying Messages

The standard format for a message is as follows:

%facility-l-ident, message-text

<i>facility</i>	Abbreviated name of the software component that issued the message
<i>l</i>	Indicator showing the severity level of the exception condition that caused the message
<i>ident</i>	Symbol of up to nine characters representing the message
<i>message-text</i>	Brief definition of the cause of the message

The message can also include up to 255 formatted ASCII output (FAO) arguments. These arguments can be used to display variable information about the condition that caused the message. In the following examples, the file specification is an FAO argument:

```
%TYPE-W-OPENIN, error opening _DB0:[FOSTER]AUTHOR.DAT; as input
```

For information about specifying FAO parameters, see Section 9.11.4.3.

## Condition-Handling Routines and Services

### 9.11 Displaying Messages

#### Signaling

Signaling provides a consistent and unified method for displaying messages. This section describes how the OpenVMS Condition Handling facility translates the original signal into intelligible messages.

Signaling is used to signal exception conditions generated by Compaq software. When software detects an exception condition, it signals the exception condition to the user by calling LIB\$SIGNAL or LIB\$STOP. The signaling routine passes a signal argument list to these run-time library routines. This signal argument list is made up of the condition value and a set of optional arguments that provide information to condition handlers.

You can use the signaling mechanism to signal messages that are specific to your application. Further, you can chain your own message to a system message. For more information, see Section 9.11.3.

LIB\$SIGNAL and LIB\$STOP copy the signal argument list and use it to create the signal argument vector. The signal argument vector serves as part of the input to the user-established handlers and the system default handlers.

If all intervening handlers have resigned, the system default handlers take control. The system-supplied default handlers are the only handlers that should actually issue messages, whether the exception conditions are signaled by Compaq software or your own programs. That is, a routine should signal exception conditions rather than issue its own messages. In this way, other applications can call the routine and override its signal in order to change the messages. Further, this technique decides formatting details, and it also keeps wording centralized and consistent.

The system default handlers pass the signal argument vector to the Put Message (SYS\$PUTMSG) system service. SYS\$PUTMSG formats and displays the information in the signal argument vector.

SYS\$PUTMSG performs the following steps:

1. Interprets the signal argument vector as a series of one or more message sequences. Each message sequence starts with a 32-bit, systemwide condition value that identifies a message in the system message file. SYS\$PUTMSG interprets the message sequences according to type defined by the facility of the condition.
2. Obtains the text of the message using the Get Message (SYS\$GETMSG) system service. The message text definition is actually a SYS\$FAO control string. It may contain embedded FAO directives. These directives determine how the FAO arguments in the signal argument vector are formatted. (For more information about SYS\$FAO, see the *OpenVMS System Services Reference Manual*.)
3. Calls SYS\$FAO to format the message, substituting the values from the signal argument list.
4. Issues the message on device SYS\$OUTPUT. If SYS\$ERROR is different from SYS\$OUTPUT, and the severity field in the condition value is not success, \$PUTMSG also issues the message on device SYS\$ERROR.

## Condition-Handling Routines and Services

### 9.11 Displaying Messages

You can use the signal array that the operating system passes to the condition handler as the first argument of the SYS\$PUTMSG system service. The signal array contains the condition code, the number of required FAO arguments for each condition code, and the FAO arguments (see Figure 9–14). The *OpenVMS System Services Reference Manual* contains complete specifications for SYS\$PUTMSG.

See Section 9.11.2 for information about how to create and suppress messages on a running log using SYS\$PUTMSG.

The last two array elements, the PC and PSL, are not FAO arguments and should be deleted before the array is passed to SYS\$PUTMSG. Because the first element of the signal array contains the number of longwords in the array, you can effectively delete the last two elements of the array by subtracting 2 from the value in the first element. Before exiting from the condition handler, you should restore the last two elements of the array by adding 2 to the first element in case other handlers reference the array.

In the following example, the condition handler uses the SYS\$PUTMSG system service and then returns a value of SS\$\_CONTINUE so that the default handler is not executed.

```
INTEGER*4 FUNCTION SYMBOL (SIGARGS,
2                          MECHARGS)
.
.
.
INDEX = LIB$MATCH_COND (SIGARGS(2),
2                          LIB$_NOSUCHSYM)
IF (INDEX .GT. 0) THEN
    ! If condition code is LIB$_NOSUCHSYM,
    ! change the severity to informational
    CALL MVBITS (STS$_INFO,
2                0,
2                3,
2                SIGARGS(2),
2                0)

    ! Display the message
    SIGARGS(1) = SIGARGS(1) - 2 ! Subtract last two elements
    CALL SYS$PUTMSG (SIGARGS,,,)
    SIGARGS(1) = SIGARGS(1) + 2 ! Restore last two elements

    ! Continue program execution;
    SYMBOL = SS$_CONTINUE
ELSE
    ! Otherwise, resignal the condition
    SYMBOL = SS$_RESIGNAL
END IF

END
```

Each message sequence in the signal argument list produces one line of output. Figure 9–14 illustrates the three possible message sequence formats.

## Condition-Handling Routines and Services

### 9.11 Displaying Messages

Figure 9–14 Formats of Message Sequences

#### No FAO (Formatted ASCII Output) Arguments

Condition Value
-----------------

Note that a condition value of zero results in no message.

#### Variable Number of FAO Arguments

Condition Value
FAO_count
FAO arg1
FAO arg2
⋮
FAO argn

Condition Value

Number of FAO Arguments

#### VAX–11 RMS Error with STV (Status Value)

VAX–11 RMS Condition Value (STS)
Associated Status Value (STV)

Condition Value

One FAO Argument or  
SS\$\_... Condition Value

ZK–1967–GE

OpenVMS RMS system services return two related completion values: the completion code and the associated status value. The completion code is returned in R0 using the function value mechanism. The same value is also placed in the Completion Status Code field of the RMS file access block (FAB) or record access block (RAB) associated with the file (FAB\$L\_STS or RAB\$L\_STS). The status value is returned in the Status Value field of the same FAB or RAB (FAB\$L\_STV or RAB\$L\_STV). The meaning of this secondary value is based on the corresponding STS (Completion Status Code) value. Its meaning could be any of the following:

- An operating system condition value of the form SS\$\_ . . .
- An RMS value, such as the size of a record that exceeds the buffer size
- Zero

Rather than have each calling program determine the meaning of the STV value, SYS\$PUTMSG performs the necessary processing. Therefore, this STV value must always be passed in place of the FAO argument count. In other words, an RMS message sequence always consists of two arguments (passed by immediate value): an STS value and an STV value.

### 9.11.1 Chaining Messages

You can use a condition handler to add condition values to an originally signaled condition code. For example, if your program calculates the standard deviation of a series of numbers and the user only enters one value, the operating system signals the condition code `SS$_INTDIV` when the program attempts to divide by zero. (In calculating the standard deviation, the divisor is the number of values entered minus 1.) You could use a condition handler to add a user-defined message to the original message to indicate that only one value was entered.

To display multiple messages, pass the condition values associated with the messages to the RTL routine `LIB$SIGNAL`. To display the message associated with an additional condition code, the handler must pass `LIB$SIGNAL` the condition code, the number of FAO arguments used, and the FAO arguments. To display the message associated with the originally signaled condition codes, the handler must pass `LIB$SIGNAL` each element of the signal array as a separate argument. Because the signal array is a variable-length array and `LIB$SIGNAL` cannot accept a variable number of arguments, when you write your handler you must pass `LIB$SIGNAL` more arguments than you think will be required. Then, during execution of the handler, zero the arguments that you do not need (`LIB$SIGNAL` ignores zero values), as described in the following steps:

1. Declare an array with one element for each argument that you plan to pass `LIB$SIGNAL`. Fifteen elements are usually sufficient.

```
INTEGER*4 NEWSIGARGS(15)
```

2. Transfer the condition values and FAO information from the signal array to your new array. The first element and the last two elements of the signal array do not contain FAO information and should not be transferred.
3. Fill any remaining elements of your new array with zeros.

The following example demonstrates steps 2 and 3:

```
DO I = 1, 15
  IF (I .LE. SIGARGS(1) - 2) THEN
    NEWSIGARGS(I) = SIGARGS(I+1) ! Start with SIGARGS(2)
  ELSE
    NEWSIGARGS(I) = 0           ! Pad with zeros
  END IF
END DO
```

Because the new array is a known-length array, you can specify each element as an argument to `LIB$SIGNAL`.

The following condition handler ensures that the signaled condition code is `SS$_INTDIV`. If it is, the user-defined message `ONE_VALUE` is added to `SS$_INTDIV`, and both messages are displayed.

```
INTEGER FUNCTION HANDLER (SIGARGS,
2                          MECHARGS)

! Declare dummy arguments
INTEGER SIGARGS(*),
2      MECHARGS(*)
! Declare new array for SIGARGS
INTEGER NEWSIGARGS (15)
! Declare index variable for LIB$MATCH_COND
INTEGER INDEX
! Declare procedures
INTEGER LIB$MATCH_COND
```

## Condition-Handling Routines and Services

### 9.11 Displaying Messages

```

! Declare condition codes
EXTERNAL ONE_VALUE
INCLUDE '($SSDEF)'
INDEX = LIB$MATCH_COND (SIGARGS(2),
2                          SS$_INTDIV)
IF (INDEX .GT. 0) THEN

    DO I=1,15
        IF (I .LE. SIGARGS(1) - 2) THEN
            NEWSIGARGS(I) = SIGARGS(I+1) ! Start with SIGARGS(2)
        ELSE
            NEWSIGARGS(I) = 0             ! Pad with zeros
        END IF
    END DO

    ! Signal messages
    CALL LIB$SIGNAL (%VAL(NEWSIGARGS(1)),
2                  %VAL(NEWSIGARGS(2)),
2                  %VAL(NEWSIGARGS(3)),
2                  %VAL(NEWSIGARGS(4)),
2                  %VAL(NEWSIGARGS(5)),
2                  %VAL(NEWSIGARGS(6)),
2                  %VAL(NEWSIGARGS(7)),
2                  %VAL(NEWSIGARGS(8)),
2                  %VAL(NEWSIGARGS(9)),
2                  %VAL(NEWSIGARGS(10)),
2                  %VAL(NEWSIGARGS(11)),
2                  %VAL(NEWSIGARGS(12)),
2                  %VAL(NEWSIGARGS(13)),
2                  %VAL(NEWSIGARGS(14)),
2                  %VAL(NEWSIGARGS(15)),
2                  %VAL(%LOC(ONE_VALUE)),
2                  %VAL(0))

    HANDLER = SS$_CONTINUE
ELSE
    HANDLER = SS$_RESIGNAL
END IF
END

```

A signal argument list may contain one or more condition values and FAO arguments. Each condition value and its FAO arguments is “chained” to the next condition value and its FAO arguments. You can use chained messages to provide more specific information about the exception condition being signaled, along with a general message.

The following message source file defines the exception condition `PROG__FAIGETMEM`:

```

.FACILITY      PROG,1 /PREFIX=PROG__
.SEVERITY      FATAL
.BASE          100
FAIGETMEM     <failed to get !UL bytes of memory>/FAO_COUNT=1
.END

```

This source file sets up the exception message as follows:

- The `.FACILITY` directive specifies the facility, `PROG`, and its number, `1`. It also adds the `/PREFIX` qualifier to determine the prefix to be used in the message.

## Condition-Handling Routines and Services

### 9.11 Displaying Messages

- The `.SEVERITY` directive specifies that `PROG__FAIGETMEM` is a fatal exception condition. That is, the `SEVERITY` field in the condition value for `PROG__FAIGETMEM` is set to severe (bits `<0:3> = 4`).
- The `BASE` directive specifies that the condition identification numbers in the `PROG` facility will begin with 100.
- `FAIGETMEM` is the symbol name. This name is combined with the prefix defined in the facility definition to make the message symbol. The message symbol becomes the symbolic name for the condition value.
- The text in angle brackets is the message text. This is actually a `SYS$FAO` control string. When `$PUTMSG` calls the `$FAO` system service to format the message, `$FAO` includes the `FAO` argument from the signal argument vector and formats the argument according to the embedded `FAO` directive (`!UL`).
- The `.END` statement terminates the list of messages for the `PROG` facility.

#### 9.11.2 Logging Error Messages to a File

You can write a condition handler to obtain a copy of a system error message text and write the message into an auxiliary file, such as a listing file. In this way, you can receive identical messages at the terminal (or batch log file) and in the auxiliary file.

To log messages, you must write a condition handler and an action subroutine. Your handler calls the Put Message (`SYS$PUTMSG`) system service explicitly. The operation of `SYS$PUTMSG` is described in Section 9.11. The handler passes to `SYS$PUTMSG` the signal argument vector and the address of the action subroutine. `SYS$PUTMSG` passes to the action subroutine the address of a string descriptor that contains the length and address of the formatted message. The action subroutine can scan the message or copy it into a log file, or both.

It is important to keep the display messages centralized and consistent. Thus, you should use only `SYS$PUTMSG` to display or log system error messages. Further, because the system default handlers call `SYS$PUTMSG` to display error messages, your handlers should avoid displaying the error messages. You can do this in two ways:

- Your handler should not call `SYS$PUTMSG` directly to display an error message. Instead, your handler should resignal the error. This allows other calling routines either to change or suppress the message or to recover from the error. The system default condition handlers display the message.
- If the action subroutine that you supply to `SYS$PUTMSG` returns a success code, `SYS$PUTMSG` displays the error message on `SYS$OUTPUT` or `SYS$ERROR`, or both. When a program executes interactively or from within a command procedure, the logical names `SYS$OUTPUT` and `SYS$ERROR` are both equated to the user's terminal by default. Thus, your action routine should process the message and then return a failure code so that `SYS$PUTMSG` does not display the message at this point.

To write the error messages displayed by your program to a file as well as to the terminal, equate `SYS$ERROR` to a file specification. When a program executes as a batch job, the logical names `SYS$OUTPUT` and `SYS$ERROR` are both equated to the batch log by default. To write error messages to the log file and a second file, equate `SYS$ERROR` to the second file.

## Condition-Handling Routines and Services

### 9.11 Displaying Messages

Figure 9–15 shows the sequence of events involved in calling SYS\$PUTMSG to log an error message to a file.

**Figure 9–15 Using a Condition Handler to Log an Error Message**

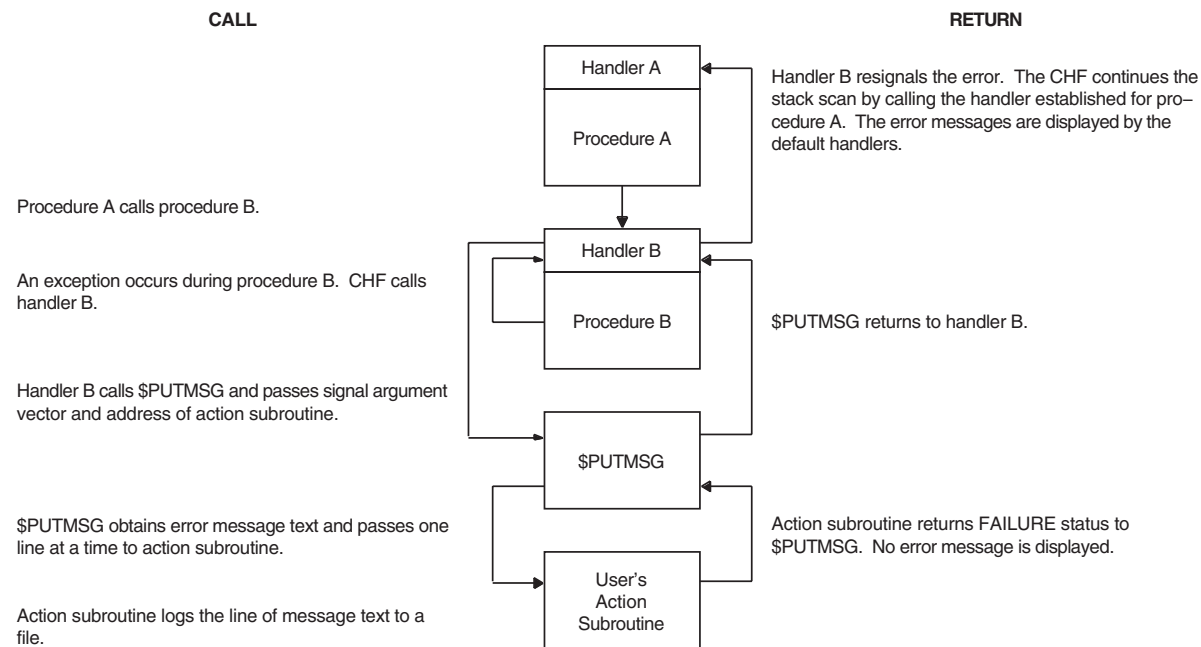

ZK-1934-GE

#### 9.11.2.1 Creating a Running Log of Messages Using SYS\$PUTMSG

To keep a running log (that is, a log that is resumed each time your program is invoked) of the messages displayed by your program, use SYS\$PUTMSG. Create a condition handler that invokes SYS\$PUTMSG regardless of the signaled condition code. When you invoke SYS\$PUTMSG, specify a function that writes the formatted message to your log file and then returns with a function value of 0. Have the condition handler resignal the condition code. One of the arguments of SYS\$PUTMSG allows you to specify a user-defined function that SYS\$PUTMSG invokes after formatting the message and before displaying the message. SYS\$PUTMSG passes the formatted message to the specified function. If the function returns with a function value of 0, SYS\$PUTMSG does not display the message; if the function returns with a value of 1, SYS\$PUTMSG displays the message. The *OpenVMS System Services Reference Manual* contains complete specifications for SYS\$PUTMSG.

#### 9.11.2.2 Suppressing the Display of Messages in the Running Log

To keep a running log of messages, you might have your main program open a file for the error log, write the date, and then establish a condition handler to write all signaled messages to the error log. Each time a condition is signaled, a condition handler like the one in the following example invokes SYS\$PUTMSG and specifies a function that writes the message to the log file and returns with a function value of 0. SYS\$PUTMSG writes the message to the log file but does not display the message. After SYS\$PUTMSG writes the message to the log file, the condition handler resignals to continue program execution. (The condition handler uses LIB\$GET\_COMMON to read the unit number of the file from the per-process common block.)



## Condition-Handling Routines and Services

### 9.11 Displaying Messages

#### ERR.FOR

```
INTEGER FUNCTION ERRLOG (SIGARGS,
2          MECHARGS)
! Writes the message to file opened on the
! logical unit named in the per-process common block
! Define the dummy arguments
INTEGER SIGARGS(*),
2          MECHARGS(*)
INCLUDE '$SSDEF'

EXTERNAL PUT_LINE
INTEGER PUT_LINE
! Pass signal array and PUT_LINE routine to SYS$PUTMSG
SIGARGS(1) = SIGARGS(1) - 2 ! Subtract PC/PSL from signal array
CALL SYS$PUTMSG (SIGARGS,
2          PUT_LINE, )
SIGARGS(1) = SIGARGS(1) + 2 ! Replace PC/PSL

ERRLOG = SS$_RESIGNAL

END
```

#### PUT\_LINE.FOR

```
INTEGER FUNCTION PUT_LINE (LINE)
! Writes the formatted message in LINE to
! the file opened on the logical unit named
! in the per-process common block
! Dummy argument
CHARACTER*(*) LINE
! Logical unit number
CHARACTER*4 LOGICAL_UNIT
INTEGER UNIT_NUM
! Indicates that SYS$PUTMSG is not to display the message
PUT_LINE = 0
! Get logical unit number and change to integer
STATUS = LIB$GET COMMON (LOGICAL_UNIT)
READ (UNIT = LOGICAL_UNIT,
2          FMT = '(I4)') UNIT_NUMBER
! The main program opens the error log
WRITE (UNIT = UNIT_NUMBER,
2          FMT = '(A)') LINE

END
```

### 9.11.3 Using the Message Utility to Signal and Display User-Defined Messages

Section 9.11 explains how the OpenVMS Condition Handling facility displays messages. The signal argument list passed to LIB\$SIGNAL or LIB\$STOP can be seen as one or more message sequences. Each message sequence consists of a condition value, an FAO count, which specifies the number of FAO arguments to come, and the FAO arguments themselves. (The FAO count is omitted in the case of system and RMS messages.) The message text definition itself is actually a SYS\$FAO control string, which may contain embedded \$FAO directives. The *OpenVMS System Services Reference Manual* describes the Formatted ASCII Output (SYS\$FAO) system service in detail.

The Message utility is provided for compiling message sequences specific to your application. When you have defined an exception condition and used the Message utility to associate a message with that exception condition, your program can call LIB\$SIGNAL or LIB\$STOP to signal the exception condition. You signal a message that is defined in a message source file by calling LIB\$SIGNAL or LIB\$STOP, as for any software-detected exception condition. Then the system default condition handlers display your error message in the standard operating system format.

## Condition-Handling Routines and Services

### 9.11 Displaying Messages

To use the Message utility, follow these steps:

1. Create a source file that specifies the information used in messages, message codes, and message symbols.
2. Use the MESSAGE command to compile this source file.
3. Link the resulting object module, either by itself or with another object module containing a program.
4. Run your program so that the messages are accessed, either directly or through the use of pointers.

See also the description of the Message utility in the *OpenVMS Command Definition, Librarian, and Message Utilities Manual*.

#### 9.11.3.1 Creating the Message Source File

A message source file contains definition statements and directives. The following message source file defines the error messages generated by the sample INCOME program:

##### INCMMSG.MSG

```
.FACILITY INCOME, 1 /PREFIX=INCOME__  
.SEVERITY WARNING  
  LINELOST  "Statistics on last line lost due to Ctrl/Z"  
.SEVERITY SEVERE  
  BADFIXVAL "Bad value on /FIX"  
  CTRLZ     "Ctrl/Z entered on terminal"  
  FORIOERR  "Fortran I/O error"  
  INSFIXVAL "Insufficient values on /FIX"  
  MAXSTATS  "Maximum number of statistics already entered"  
  NOACTION  "No action qualifier specified"  
  NOHOUSE   "No such house number"  
  NOSTATS   "No statistics to report"  
.END
```

The default file type of a message source file is .MSG. For a complete description of the Message utility, see the *OpenVMS Command Definition, Librarian, and Message Utilities Manual*.

**9.11.3.1.1 Specifying the Facility** To specify the name and number of the facility for which you are defining the error messages, use the .FACILITY directive. For instance, the following .FACILITY directive specifies the facility (program) INCOME and a facility number of 1:

```
.FACILITY INCOME, 1
```

In addition to identifying the program associated with the error messages, the .FACILITY directive specifies the facility prefix that is added to each condition name to create the symbolic name used to reference the message. By default, the prefix is the facility name followed by an underscore. For example, a condition name BADFIXVAL defined following the previous .FACILITY directive is referenced as INCOME\_BADFIXVAL. You can specify a prefix other than the specified program name by specifying the /PREFIX qualifier of the .FACILITY directive.

By convention, system-defined condition values are identified by the facility name, followed by a dollar sign (\$), an underscore (\_), and the condition name. User-defined condition values are identified by the facility name, followed by two underscores (\_ \_), and the condition name. To include two underscores in the symbolic name, use the /PREFIX qualifier to specify the prefix:

## Condition-Handling Routines and Services

### 9.11 Displaying Messages

```
.FACILITY INCOME, 1 /PREFIX=INCOME__
```

A condition name BADFIXVAL defined following this .FACILITY directive is referenced as INCOME\_\_BADFIXVAL.

The facility number, which must be between 1 and 2047, is part of the condition code that identifies the error message. To prevent different programs from generating the same condition values, the facility number must be unique. A good way to ensure uniqueness is to have the system manager keep a list of programs and their facility numbers in a file.

All messages defined after a .FACILITY directive are associated with the specified program. Specify either an .END directive or another .FACILITY directive to end the list of messages for that program. Compaq recommends that you have one .FACILITY directive per message file.

**9.11.3.1.2 Specifying the Severity** Use the .SEVERITY directive and one of the following keywords to specify the severity of one or more condition values:

- Success
- Informational
- Warning
- Error
- Severe or fatal

All condition values defined after a .SEVERITY directive have the specified severity (unless you use the /SEVERITY qualifier with the message definition statement to change the severity of one particular condition code). Specify an .END directive or another .SEVERITY directive to end the group of errors with the specified severity. Note that when the .END directive is used to end the list of messages for a .SEVERITY directive, it also ends the list of messages for the previous .FACILITY directive. The following example defines one condition code with a severity of warning and two condition values with a severity of severe. The optional spacing between the lines and at the beginning of the lines is used for clarity.

```
.SEVERITY WARNING
    LINELOST "Statistics on last line lost due to Ctrl/Z"

.SEVERITY SEVERE
    BADFIXVAL "Bad value on /FIX"
    INSFIXVAL "Insufficient values on /FIX"

.END
```

**9.11.3.1.3 Specifying Condition Names and Messages** To define a condition code and message, specify the condition name and the message text. The condition name, when combined with the facility prefix, can contain up to 31 characters. The message text can be up to 255 characters but only one line long. Use quotation marks ( " ") or angle brackets (<>) to enclose the text of the message. For example, the following line from INCMSG.MSG defines the condition code INCOME\_\_BADFIXVAL:

```
BADFIXVAL "Bad value on /FIX"
```

## Condition-Handling Routines and Services

### 9.11 Displaying Messages

**9.11.3.1.4 Specifying Variables in the Message Text** To include variables in the message text, specify formatted ASCII output (FAO) directives. For details, see the description of the Message utility in the *OpenVMS Command Definition, Librarian, and Message Utilities Manual*. Specify the `/FAO_COUNT` qualifier after either the condition name or the message text to indicate the number of FAO directives that you used. The following example includes an integer variable in the message text:

```
NONUMBER <No such house number: !UL. Try again.>/FAO_COUNT=1
```

The FAO directive `!UL` converts a longword to decimal notation. To include a character string variable in the message, you could use the FAO directive `!AS`, as shown in the following example:

```
NOFILE <No such file: !AS. Try again.>/FAO_COUNT=1
```

If the message text contains FAO directives, you must specify the appropriate variables when you signal the condition code (see Section 9.11.4).

**9.11.3.1.5 Compiling and Linking the Messages** Use the DCL command `MESSAGE` to compile a message source file into an object module. The following command compiles the message source file `INCMSG.MSG` into an object module named `INCMSG` in the file `INCMSG.OBJ`:

```
$ MESSAGE INCMSG
```

To specify an object file name that is different from the source file name, use the `/OBJECT` qualifier of the `MESSAGE` command. To specify an object module name that is different from the source file name, use the `.TITLE` directive in the message source file.

**9.11.3.1.6 Linking the Message Object Module** The message object module must be linked with your program so the system can reference the messages. To simplify linking a program with the message object module, include the message object module in the program's object library. For example, to include the message module in `INCOME`'s object library, enter the following:

```
$ LIBRARY INCOME.OLB INCMSG.OBJ
```

**9.11.3.1.7 Accessing the Message Object Module from Multiple Programs**

Including the message module in the program's object library does not allow other programs access to the module's condition values and messages. To allow several programs access to a message module, create a default message library as follows:

1. Create the message library—Create an object module library and enter all of the message object modules into it.
2. Make the message library a default library—Equate the complete file specification of the object module library with the logical name `LNK$LIBRARY`. (If `LNK$LIBRARY` is already assigned a library name, you can create `LNK$LIBRARY_1`, `LNK$LIBRARY_2`, and so on.) By default, the linker searches any libraries equated with the `LNK$LIBRARY` logical names.

The following example creates the message library `MESSAGLIB.OLB`, enters the message object module `INCMSG.OBJ` into it, and makes `MESSAGLIB.OLB` a default library:

```
$ LIBRARY/CREATE MESSAGLIB
$ LIBRARY/INSERT MESSAGLIB INCMSG
$ DEFINE LNK$LIBRARY SYS$DISK:MESSAGLIB
```

**9.11.3.1.8 Modifying a Message Source Module** To modify a message in the message library, modify and recompile the message source file, and then replace the module in the object module library. To access the modified messages, a program must relink against the object module library (or the message object module). The following command enters the module INCMMSG into the message library MESSAGLIB; if MESSAGLIB already contains an INCMMSG module, it is replaced:

```
$ LIBRARY/REPLACE MESSAGLIB INCMMSG
```

**9.11.3.1.9 Accessing Modified Messages Without Relinking** To allow a program to access modified messages without relinking, create a message pointer file. Message pointer files are useful if you need either to provide messages in more than one language or frequently change the text of existing messages. See the description of the Message utility in the *OpenVMS Command Definition, Librarian, and Message Utilities Manual*.

## 9.11.4 Signaling User-Defined Values and Messages with Global and Local Symbols

To signal a user-defined condition value, you use the symbol formed by the facility prefix and the condition name (for example, INCOME\_\_BADFIXVAL). Typically, you reference a condition value as a global symbol; however, you can create an include file (similar to the modules in the system library SYS\$LIBRARY:FORSTSDEF.TLB) to define the condition values as local symbols. If the message text contains FAO arguments, you must specify parameters for those arguments when you signal the condition value.

### 9.11.4.1 Signaling with Global Symbols

To signal a user-defined condition value using a global symbol, declare the appropriate condition value in the appropriate section of the program unit, and then invoke the RTL routine LIB\$SIGNAL to signal the condition value. The following statements signal the condition value INCOME\_\_NOHOUSE when the value of FIX\_HOUSE\_NO is less than 1 or greater than the value of TOTAL\_HOUSES:

```
EXTERNAL INCOME__NOHOUSE
.
.
.
IF ((FIX_HOUSE_NO .GT. TOTAL_HOUSES) .OR.
2  FIX_HOUSE_NO .LT. 1) THEN
    CALL LIB$SIGNAL (%VAL (%LOC (INCOME__NOHOUSE)))
END IF
```

### 9.11.4.2 Signaling with Local Symbols

To signal a user-defined condition value using a local symbol, you must first create a file containing PARAMETER statements that equate each condition value with its user-defined condition value. To create such a file, do the following:

1. Create a listing file—Compile the message source file with the /LIST qualifier to the MESSAGE command. The /LIST qualifier produces a listing file with the same name as the source file and a file type of .LIS. The following line might appear in a listing file:

```
08018020      11 NOHOUSE      "No such house number"
```

## Condition-Handling Routines and Services

### 9.11 Displaying Messages

The hexadecimal value in the left column is the value of the condition value, the decimal number in the second column is the line number, the text in the third column is the condition name, and the text in quotation marks is the message text.

2. Edit the listing file—For each condition name, define the matching condition value as a longword variable, and use a language statement to equate the condition value to its hexadecimal condition value.

Assuming a prefix of INCOME\_\_, editing the previous statement results in the following statements:

```
INTEGER INCOME_NOHOUSE
PARAMETER (INCOME_NOHOUSE = '08018020'X)
```

3. Rename the listing file—Name the edited listing file using the same name as the source file and a file type for your programming language (for example, .FOR for Compaq Fortran).

In the definition section of your program unit, declare the local symbol definitions by naming your edited listing file in an INCLUDE statement. (You must still link the message object file with your program.) Invoke the RTL routine LIB\$SIGNAL to signal the condition code. The following statements signal the condition code INCOME\_\_NOHOUSE when the value of FIX\_HOUSE\_NO is less than 1 or greater than the value of TOTAL\_HOUSES:

```
! Specify the full file specification
INCLUDE '$DISK1:[DEV.INCOME]INCMMSG.FOR'
:
:
:
IF ((FIX_HOUSE_NO .GT. TOTAL_HOUSES) .OR.
2  FIX_HOUSE_NO .LT. 1) THEN
    CALL LIB$SIGNAL (%VAL (INCOME__NOHOUSE))
END IF
```

#### 9.11.4.3 Specifying FAO Parameters

If the message contains FAO arguments, you must specify the number of FAO arguments as the second argument of LIB\$SIGNAL, the first FAO argument as the third argument, the second FAO argument as the fourth argument, and so on. Pass string FAO arguments by descriptor (the default). For example, to signal the condition code INCOME\_\_NONUMBER, where FIX\_HOUSE\_NO contains the erroneous house number, specify the following:

```
EXTERNAL INCOME__NONUMBER
:
:
:
IF ((FIX_HOUSE_NO .GT. TOTAL_HOUSES) .OR.
2  FIX_HOUSE_NO .LT. 1) THEN
    CALL LIB$SIGNAL (%VAL (%LOC (INCOME__NONUMBER)),
2                    %VAL (1),
2                    %VAL (FIX_HOUSE_NO))
END IF
```

To signal the condition code NOFILE, where FILE\_NAME contains the invalid file specification, specify the following:

```
EXTERNAL INCOME__NOFILE
      .
      .
      .
IF (IOSTAT .EQ. FOR$IOS FILNOTFOU)
2  CALL LIB$SIGNAL (%VAL (%LOC (INCOME__NOFILE)),
2      %VAL (1),
2      FILE_NAME)
```

Both of the previous examples use global symbols for the condition values. Alternatively, you could use local symbols, as described in Section 9.11.4.2.

## 9.12 Writing a Condition Handler

When you write a condition handler into your program, the process involves one or more of the following actions:

- Establish the handler in the stack frame of your routine.
- Write a condition-handling routine, or choose one of the run-time library routines that handles exception conditions.
- Include a call to a run-time library signal-generating routine.
- Use the Message utility to define your own exception conditions.
- Include a call to the SYS\$PUTMSG system service to modify or log the system error message.

You can write a condition handler to take action when an exception condition is signaled. When the exception condition occurs, the OpenVMS Condition Handling facility sets up the signal argument vector and mechanism argument vector and begins the search for a condition handler. Therefore, your condition-handling routine must declare variables to contain the two argument vectors. Further, the handler must indicate the action to be taken when it returns to the OpenVMS Condition Handling facility. The handler uses its function value to do this. Thus, the calling sequence for your condition handler has the following format:

```
handler signal-args ,mechanism-args
```

### signal-args

The address of a vector of longwords indicating the nature of the condition. See Section 9.8.2 for a detailed description.

### mechanism-args

The address of a vector of longwords that indicates the state of the process at the time of the signal. See Section 9.8.3 and Section 9.8.4 for more details.

### result

A condition value. Success (bit <0> = 1) causes execution to continue at the PC; failure (bit <0> = 0) causes the condition to be resignaled. That is, the system resumes the search for other handlers. If the handler calls the Unwind (SYS\$UNWIND) system service, the return value is ignored and the stack is unwound. (See Section 9.12.3.)

Handlers can modify the contents of either the **signal-args** vector or the **mechanism-args** vector.

## Condition-Handling Routines and Services

### 9.12 Writing a Condition Handler

In order to protect compiler optimization, a condition handler and any routines that it calls can reference only arguments that are explicitly passed to handlers. They cannot reference COMMON or other external storage, and they cannot reference local storage in the routine that established the handler unless the compiler considers the storage to be volatile. Compilers that do not adhere to this rule must ensure that any variables referenced by the handler are always kept in memory, not in a register.

As mentioned previously, a condition handler can take one of three actions:

- Continue execution
- Resignal the exception condition and resume the stack scanning operation
- Call SYS\$UNWIND to unwind the call stack to an earlier frame

The sections that follow describe how to write condition handlers to perform these three operations.

#### 9.12.1 Continuing Execution

To continue execution from the instruction following the signal, with no error messages or traceback, the handler returns with the function value SS\$\_CONTINUE (bit <0> = 1). If, however, the condition was signaled with a call to LIB\$STOP, the SS\$\_CONTINUE return status causes an error message (Attempt To Continue From Stop), and the image exits. The only way to continue from a call to LIB\$STOP is for the condition handler to request a stack unwind.

If execution is to continue after a hardware fault (such as a reserved operand fault), the condition handler must correct the cause of the condition before returning the function value SS\$\_CONTINUE or requesting a stack unwind. Otherwise, the instruction that caused the fault executed again.

---

#### Note

---

On most VAX systems, hardware floating-point traps have been changed to hardware faults. If you still want floating-point exception conditions to be treated as traps, use LIB\$SIM\_TRAP to simulate the action of floating-point traps.

---

On Alpha systems, LIB\$SIM\_TRAP is not supported. Table 9-4 lists the run-time library routines that are supported and not supported on Alpha systems.

#### 9.12.2 Resignaling

Condition handlers check for specific errors. If the signaled condition is not one of the expected errors, the handler resignals. That is, it returns control to the OpenVMS Condition Handling facility with the function value SS\$\_RESIGNAL (with bit <0> clear). To alter the severity of the signal, the handler modifies the low-order 3 bits of the condition value and resignals.

For an example of resignaling, see Section 9.8.5.

#### 9.12.3 Unwinding the Call Stack

A condition handler can dismiss the signal by calling the system service SYS\$UNWIND. The stack unwind is initiated when a condition handler that has called SYS\$UNWIND returns to OpenVMS Condition Handling facility. For an explanation of unwinding, see Section 9.10.1; for an example of using SYS\$UNWIND to return control to the program, see Section 9.12.4.5.



### 9.12.4 Example of Writing a Condition Handler

The operating system passes two arrays to a condition handler. Any condition handler that you write should declare two dummy arguments as variable-length arrays, as in the following:

```
INTEGER*4 FUNCTION HANDLER (SIGARGS,  
2                          MECHARGS)  
  
INTEGER*4 SIGARGS(*),  
2        MECHARGS(*)  
  
:  
:  
:
```

#### 9.12.4.1 Signal Array

The first dummy argument, the signal array, describes the signaled condition codes that indicate which error occurred and the state of the process when the condition code was signaled. For the structure of the signal array, see Section 9.8.2.

#### 9.12.4.2 Mechanism Array

The second dummy argument, the mechanism array, describes the state of the process when the condition code was signaled. Typically, a condition handler references only the call depth and the saved function value. Currently, the mechanism array contains exactly five elements; however, because its length is subject to change, you should declare the dummy argument as a variable-length array. For the structure of the mechanism array, see Section 9.8.3.

Usually you write a condition handler in anticipation of a particular set of condition values. Because a handler is invoked in response to any signaled condition code, begin your handler by comparing the condition code passed to the handler (element 2 of the signal array) against the condition codes expected by the handler. If the signaled condition code is not one of the expected codes, resignal the condition code by equating the function value of the handler to the global symbol `SS$_RESIGNAL`.

#### 9.12.4.3 Comparing the Signaled Condition with an Expected Condition

You can use the RTL routine `LIB$MATCH_COND` to compare the signaled condition code to a list of expected condition values. The first argument passed to `LIB$MATCH_COND` is the signaled condition code, the second element of the signal array. The rest of the arguments passed to `LIB$MATCH_COND` are the expected condition values. `LIB$MATCH_COND` compares the first argument with each of the remaining arguments and returns the number of the argument that matches the first one. For example, if the second argument matches the first argument, `LIB$MATCH_COND` returns a value of 1. If the first argument does not match any of the other arguments, `LIB$MATCH_COND` returns 0.

The following condition handler determines whether the signaled condition code is one of four Compaq Fortran I/O errors. If it is not, the condition handler resignals the condition code. Note that, when a Compaq Fortran I/O error is signaled, the signal array describes operating system's condition code, not the Compaq Fortran error code.

## Condition-Handling Routines and Services

### 9.12 Writing a Condition Handler

```
INTEGER FUNCTION HANDLER (SIGARGS,  
2                      MECHARGS)  
  
! Declare dummy arguments  
INTEGER*4 SIGARGS(*),  
2      MECHARGS(*)  
INCLUDE '($FORDEF)' ! Declare the FOR$_ symbols  
INCLUDE '($SDEF)'   ! Declare the SS$_ symbols  
INTEGER INDEX  
! Declare procedures  
INTEGER LIB$MATCH_COND  
INDEX = LIB$MATCH_COND (SIGARGS(2),  
2                      FOR$_FILNOTFOU,  
2                      FOR$_OPEFAI,  
2                      FOR$_NO_SUCDEV,  
2                      FOR$_FILNAM_SPE)  
IF (INDEX .EQ. 0) THEN  
! Not an expected condition code, resignal  
HANDLER = SS$_RESIGNAL  
ELSE IF (INDEX .GT. 0) THEN  
! Expected condition code, handle it  
.  
.  
.  
END IF  
  
END
```

#### 9.12.4.4 Exiting from the Condition Handler

You can exit from a condition handler in one of three ways:

- Continue execution of the program—If you equate the function value of the condition handler to `SS$_CONTINUE`, the condition handler returns control to the program at the statement that signaled the condition (fault) or the statement following the one that signaled the condition (trap). The RTL routine `LIB$SIGNAL` generates a trap so that control is returned to the statement following the call to `LIB$SIGNAL`.

In the following example, if the condition code is one of the expected codes, the condition handler displays a message and then returns the value `SS$_CONTINUE` to resume program execution. (Section 9.11 describes how to display a message.)

```
INTEGER FUNCTION HANDLER (SIGARGS,  
2                      MECHARGS)  
  
! Declare dummy arguments  
INTEGER*4 SIGARGS(*),  
2      MECHARGS(*)  
INCLUDE '($FORDEF)'  
INCLUDE '($SDEF)'  
INTEGER*4 INDEX,  
2      LIB$MATCH_COND  
INDEX = LIB$MATCH_COND (SIGARGS(2),  
2                      FOR$_FILNOTFOU,  
2                      FOR$_OPEFAI,  
2                      FOR$_NO_SUCDEV,  
2                      FOR$_FILNAM_SPE)
```

## Condition-Handling Routines and Services

### 9.12 Writing a Condition Handler

```
IF (INDEX .GT. 0) THEN
  .
  .
  .           ! Display the message
  .
  .
  .
  HANDLER = SS$_CONTINUE
END IF
```

- Resignal the condition code—If you equate the function value of the condition handler to `SS$_RESIGNAL` or do not specify a function value (function value of 0), the handler allows the operating system to execute the next condition handler. If you modify the signal array or mechanism array before resignaling, the modified arrays are passed to the next condition handler.

In the following example, if the condition code is not one of the expected codes, the handler resignals:

```
INDEX = LIB$MATCH_COND (SIGARGS(2),
2                       FOR$_FILNOTFOU,
2                       FOR$_OPEFAI,
2                       FOR$_NO_SUCDEV,
2                       FOR$_FILNAMSPE)

IF (INDEX .EQ. 0) THEN
  HANDLER = SS$_RESIGNAL
END IF
```

- Continue execution of the program at a previous location—If you call the `SYS$UNWIND` system service, the condition handler can return control to any point in the program unit that incurred the exception, the program unit that invoked the program unit that incurred the exception, and so on back to the program unit that established the condition handler.

#### 9.12.4.5 Returning Control to the Program

Your handlers should return control either to the program unit that established the handler or to the program unit that invoked the program unit that established the handler.

To return control to the program unit that established the handler, invoke `SYS$UNWIND` and pass the call depth (third element of the mechanism array) as the first argument with no second argument.

```
! Declare dummy arguments
INTEGER*4 SIGARGS(*),
2         MECHARGS(*)
.
.
.
CALL SYS$UNWIND (MECHARGS(3),)
```

To return control to the caller of the program unit that established the handler, invoke `SYS$UNWIND` without passing any arguments.

```
! Declare dummy arguments
INTEGER*4 SIGARGS(*),
2         MECHARGS(*)
.
.
.
CALL SYS$UNWIND (,)
```

## Condition-Handling Routines and Services

### 9.12 Writing a Condition Handler

The first argument `SYS$UNWIND` specifies the number of program units to unwind (remove from the stack). If you specify this argument at all, you should do so as shown in the previous example. (`MECHARGS(3)` contains the number of program units that must be unwound to reach the program unit that established the handler that invoked `SYS$UNWIND`.) The second argument `SYS$UNWIND` contains the location of the next statement to be executed. Typically, you omit the second argument to indicate that the program should resume execution at the statement following the last statement executed in the program unit that is regaining control.

Each time `SYS$UNWIND` removes a program unit from the stack, it invokes any condition handler established by that program unit and passes the condition handler the `SS$_UNWIND` condition code. To prevent the condition handler from resignaling the `SS$_UNWIND` condition code (and so complicating the unwind operation), include `SS$_UNWIND` as an expected condition code when you invoke `LIB$MATCH_COND`. When the condition code is `SS$_UNWIND`, your condition handler might perform necessary cleanup operations or do nothing.

In the following example, if the condition code is `SS$_UNWIND`, no action is performed. If the condition code is another of the expected codes, the handler displays the message and then returns control to the program unit that called the program unit that established the condition handler.

```
INTEGER FUNCTION HANDLER (SIGARGS,
2                          MECHARGS)

! Declare dummy arguments
INTEGER*4 SIGARGS(*),
2        MECHARGS(*)
INCLUDE '($FORDEF)'
INCLUDE '($SDEF)'
INTEGER*4 INDEX,
2        LIB$MATCH_COND
INDEX = LIB$MATCH_COND (SIGARGS(2),
2                          SS$_UNWIND,
2                          FOR$_FILNOTFOU,
2                          FOR$_OPEFAI,
2                          FOR$_NO_SUCDEV,
2                          FOR$_FILNAMSPE)
IF (INDEX .EQ. 0) THEN
    ! Unexpected condition, resignal
    HANDLER = SS$_RESIGNAL
ELSE IF (INDEX .EQ. 1) THEN
    ! Unwinding, do nothing
ELSE IF (INDEX .GT. 1) THEN
    .
    .
    .
        ! Display the message
    .
    .
    .
    CALL SYS$UNWIND (,)
END IF
```

### 9.12.5 Example of Condition-Handling Routines

The following example shows two procedures, A and B, that have declared condition handlers. The notes describe the sequence of events that would occur if a call to a system service failed during the execution of procedure B.

```

/* PGMA */
#include <stdio.h>
#include <ssdef.h>
unsigned int sigargs[],mechargs[];
main() {
    unsigned int status, vector=0, old_handler;
        old_handler = LIB$ESTABLISH( handlera );           ❶
        status = pgmb (arglst);                             ❷
        .
        .
    }
/* PGMB */
#include <stdio.h>
#include <ssdef.h>
main() {
    old_handler = LIB$ESTABLISH( handlerb );           ❸
        .
        .
    }                                           ❹
/* Handler A */                                           ❺
int handlera( sigargs, mechargs ) {
/* Compare condition value signalled with expected value */
        if (sigargs[1] != SS$_SSFAIL)                   ❻
            goto no_fail;
        .
        .
/* Signal to continue */
        return SS$_CONTINUE;
/* Signal to resignal */
no_fail:
        return SS$_RESIGNAL;
}
/* Handler B */
int handlerb( sigargs, mechargs ) {
/* Compare condition value signalled with expected value */
        if (sigargs[1] != SS$_BREAK)                       ❼
            goto no_fail;
        .
        .
        return SS$_CONTINUE;
}

```

## Condition-Handling Routines and Services

### 9.12 Writing a Condition Handler

```
no_fail:
    return SS$_RESIGNAL;
}
```

- ❶ Procedure A executes and establishes condition handler HANDLER A. HANDLER A is set up to respond to exceptions caused by failures in system service calls.
- ❷ During its execution, procedure A calls procedure B.
- ❸ Procedure B establishes condition handler HANDLER B. HANDLER B is set up to respond to breakpoint faults.
- ❹ While procedure B is executing, an exception occurs caused by a system service failure.
- ❺ The dispatcher returns control to procedure B, and execution of procedure B resumes at the instruction following the system service failure.
- ❻ The exception dispatcher resumes its search for a condition handler and calls HANDLER A.
- ❼ HANDLER A handles the system service failure exception, corrects the condition, places the return value SS\$\_CONTINUE in R0, and returns control to the exception dispatcher.

### 9.13 Debugging a Condition Handler

You can debug a condition handler as you would any subprogram, except that you cannot use the `DEBUG` command `STEP/INTO` to enter a condition handler. You must set a breakpoint in the handler and wait for the debugger to invoke the handler.

Typically, to trace execution of a condition handler, you set breakpoints at the statement in your program that should signal the condition code, at the statement following the one that should signal, and at the first executable statement in your condition handler.

The `SET BREAK` debugger command with the `/HANDLER` qualifier causes the debugger to scan the call stack and attempt to set a breakpoint on every established frame-based handler whenever the program being debugged has an exception. The debugger does not discriminate between standard RTL handlers and user-defined handlers.

### 9.14 Run-Time Library Condition-Handling Routines

The following sections present information about Alpha systems RTL jacket handlers, and RTL routines that can be either established as condition handlers or called from a condition handler to handle signaled exception conditions.

## Condition-Handling Routines and Services

### 9.14 Run-Time Library Condition-Handling Routines

#### 9.14.1 RTL Jacket Handlers (Alpha Only)

On Alpha systems, many RTLs establish a jacket RTL handler on a frame where the user program has defined its own handler. This RTL jacket does some setup and argument manipulation before actually calling the handler defined by the user. When processing the exception, the debugger sets the breakpoint on the jacket RTL jacket handler, because that is the address on the call stack. If the debugger suspends program execution at a jacket RTL handler, it is usually possible to reach the user-defined handler by entering a STEP/CALL command followed by a STEP/INTO command. Some cases might require that additional sequences of STEP/CALL and STEP/INTO commands be entered. For more information on frame-based handlers, see *OpenVMS Calling Standard*.

If the jacket RTL handler is part of an installed shared image such as ALPHA LIBOTS, the debugger cannot set a breakpoint on it. In this case, activate the RTL as a private image by defining the RTL as a logical name, as in the following example:

```
$DEFINE LIBOTS SYS$SHARE:LIBOTS.EXE;
```

---

#### Note

---

In the previous example, the trailing semicolon (;) is required.

---

#### 9.14.2 Converting a Floating-Point Fault to a Floating-Point Trap (VAX Only)

On VAX systems, a trap is an exception condition that is signaled after the instruction that caused it has finished executing. A fault is an exception condition that is signaled during the execution of the instruction. When a trap is signaled, the program counter (PC) in the signal argument vector points to the next instruction after the one that caused the exception condition. When a fault is signaled, the PC in the signal argument vector points to the instruction that caused the exception condition. See the *VAX Architecture Reference Manual* for more information about faults and traps.

LIB\$SIM\_TRAP can be established as a condition handler or be called from a condition handler to convert a floating-point fault to a floating-point trap. After LIB\$SIM\_TRAP is called, the PC points to the instruction after the one that caused the exception condition. Thus, your program can continue execution without fixing up the original condition. LIB\$SIM\_TRAP intercepts only floating-point overflow, floating-point underflow, and divide-by-zero faults.

#### 9.14.3 Changing a Signal to a Return Status

When it is preferable to detect errors by signaling but the calling routine expects a returned status, LIB\$SIG\_TO\_RET can be used by the routine that signals. For instance, if you expect a particular condition code to be signaled, you can prevent the operating system from invoking the default condition handler by establishing a different condition handler. LIB\$SIG\_TO\_RET is a condition handler that converts any signaled condition to a return status. The status is returned to the caller of the routine that established LIB\$SIG\_TO\_RET. You may establish LIB\$SIG\_TO\_RET as a condition handler by specifying it in a call to LIB\$ESTABLISH.

On Alpha systems, LIB\$ESTABLISH is not supported, though high-level languages may support it for compatibility.

## Condition-Handling Routines and Services

### 9.14 Run-Time Library Condition-Handling Routines

LIB\$SIG\_TO\_RET can also be called from another condition handler. If LIB\$SIG\_TO\_RET is called from a condition handler, the signaled condition is returned as a function value to the caller of the establisher of that handler when the handler returns to the OpenVMS Condition Handling facility. When a signaled exception condition occurs, LIB\$SIG\_TO\_RET routine does the following:

- Places the signaled condition value in the image of R0 that is saved as part of the mechanism argument vector.
- Calls the Unwind (SYS\$UNWIND) system service with the default arguments. After returning from LIB\$SIG\_TO\_RET (when it is established as a condition handler) or after returning from the condition handler that called LIB\$SIG\_TO\_RET (when LIB\$SIG\_TO\_RET is called from a condition handler), the stack unwinds to the caller of the routine that established the handler.

Your calling routine can now both test R0, as if the called routine had returned a status, and specify an error recovery action.

The following paragraphs describe how to establish and use the system-defined condition handler LIB\$SIG\_TO\_RET, which changes a signal to a return status that your program can examine.

To change a signal to a return status, you must put any code that might signal a condition code into a function where the function value is a return status. The function containing the code must perform the following operations:

- Declare LIB\$SIG\_TO\_RET—Declare the condition handler LIB\$SIG\_TO\_RET.
- Establish LIB\$SIG\_TO\_RET—Invoke the run-time library procedure LIB\$ESTABLISH to establish a condition handler for the current program unit. Specify the name of the condition handler LIB\$SIG\_TO\_RET as the only argument.
- Initialize the function value—Initialize the function value to SS\$\_NORMAL so that, if no condition code is signaled, the function returns a success status to the invoking program unit.
- Declare necessary dummy arguments—If any statement that might signal a condition code is a subprogram that requires dummy arguments, pass the necessary arguments to the function. In the function, declare each dummy argument exactly as it is declared in the subprogram that requires it and specify the dummy arguments in the subprogram invocation.

If the program unit GET\_1\_STAT in the following function signals a condition code, LIB\$SIG\_TO\_RET changes the signal to the return status of the INTERCEPT\_SIGNAL function and returns control to the program unit that invoked INTERCEPT\_SIGNAL. (If GET\_1\_STAT has a condition handler established, the operating system invokes that handler before invoking LIB\$SIG\_TO\_RET.)

```
FUNCTION INTERCEPT_SIGNAL (STAT,  
2                               ROW,  
2                               COLUMN)  
  
! Dummy arguments for GET_1_STAT  
INTEGER STAT,  
2       ROW,  
2       COLUMN  
! Declare SS$ NORMAL  
INCLUDE '($SSDEF)'
```



## Condition-Handling Routines and Services

### 9.14 Run-Time Library Condition-Handling Routines

```
! Declare condition handler
EXTERNAL LIB$SIG_TO_RET
! Declare user routine
INTEGER GET_1_STAT
! Establish LIB$SIG_TO_RET
CALL LIB$ESTABLISH (LIB$SIG_TO_RET)
! Set return status to success
INTERCEPT_SIGNAL = SS$ NORMAL
! Statements and/or subprograms that
! signal expected error condition codes
STAT = GET_1_STAT (ROW,
2          COLUMN)

END
```

When the program unit that invoked INTERCEPT\_SIGNAL regains control, it should check the return status (as shown in Section 9.5.1) to determine which condition code, if any, was signaled during execution of INTERCEPT\_SIGNAL.

#### 9.14.4 Changing a Signal to a Stop

LIB\$SIG\_TO\_STOP causes a signal to appear as though it had been signaled by a call to LIB\$STOP.

LIB\$SIG\_TO\_STOP can be enabled as a condition handler for a routine or be called from a condition handler. When a signal is generated by LIB\$STOP, the severity code is forced to severe, and control cannot return to the routine that signaled the condition. See Section 9.12.1 for a description of continuing normal execution after a signal.

#### 9.14.5 Matching Condition Values

LIB\$MATCH\_COND checks for a match between two condition values to allow a program to branch according to the condition found. If no match is found, the routine returns zero. The routine matches only the condition identification field (STS\$V\_COND\_ID) of the condition value; it ignores the control bits and the severity field. If the facility-specific bit (STS\$V\_FAC\_SP = bit <15>) is clear in **cond-val** (meaning that the condition value is systemwide), LIB\$MATCH\_COND ignores the facility code field (STS\$V\_FAC\_NO = bits <27:17>) and compares only the STS\$V\_MSG\_ID fields (bits <15:3>).

#### 9.14.6 Correcting a Reserved Operand Condition (VAX Only)

On VAX systems, after a signal of SS\$\_ROPRAND during a floating-point instruction, LIB\$FIXUP\_FLT finds the operand and changes it from -0.0 to a new value or to +0.0.

#### 9.14.7 Decoding the Instruction That Generated a Fault (VAX Only)

On VAX systems, LIB\$DECODE\_FAULT locates the operands for an instruction that caused a fault and passes the information to a user action routine. When called from a condition handler, LIB\$DECODE\_FAULT locates all the operands and calls an action routine that you supply. Your action routine performs the steps necessary to handle the exception condition and returns control to LIB\$DECODE\_FAULT. LIB\$DECODE\_FAULT then restores the operands and the environment, as modified by the action routine, and continues execution of the instruction.

## Condition-Handling Routines and Services

### 9.15 Exit Handlers

#### 9.15 Exit Handlers

When an image exits, the operating system performs the following operations:

- Invokes any user-defined exit handlers.
- Invokes the system-defined default exit handler, which closes any files that were left open by the program or by user-defined exit handlers.
- Executes a number of cleanup operations collectively known as image rundown. The following is a list of some of these cleanup operations:
  - Canceling outstanding ASTs and timer requests.
  - Deassigning any channel assigned by your program and not already deassigned by your program or the system.
  - Deallocating devices allocated by the program.
  - Disassociating common event flag clusters associated with the program.
  - Deleting user-mode logical names created by the program. (Unless you specify otherwise, logical names created by SYS\$CRELNM are user-mode logical names.)
  - Restoring internal storage (for example, stacks or mapped sections) to its original state.

If any exit handler exits using the EXIT (SYS\$EXIT) system service, none of the remaining handlers is executed. In addition, if an image is aborted by the DCL command STOP (the user presses Ctrl/Y and then enters STOP), the system performs image rundown and does not invoke any exit handlers. Like the DCL STOP/ID, SYS\$DELPRC bypasses all exit handlers, except the rundown specified in the privileged library vector (PLV) privileged shareable images, and deletes the process. (The DCL command EXIT invokes the exit handlers before running down the image.)

When a routine is active under OpenVMS, it has available to it temporary storage on a stack, in a construct known as a stack frame, or call frame. Each time a subroutine call is made, another call frame is pushed onto the stack and storage is made available to that subroutine. Each time a subroutine returns to its caller, the subroutine's call frame is pulled off the stack, and the storage is made available for reuse by other subroutines. Call frames therefore are nested. Outer call frames remain active longer, and the outermost call frame, the call frame associated with the main routine, is normally always available.

A primary exception to this call frame condition is when an exit handler runs. With an exit handler running, only static data is available. The exit handler effectively has its own call frame. Exit handlers are declared with the SYS\$DCLEXH system service.

The use of call frames for storage means that all routine-local data is reentrant; that is, each subroutine has its own storage for the routine-local data.

The allocation of storage that is known to the exit handler must be in memory that is not volatile over the possible interval the exit handler might be pending. This means you must be familiar with how the compilers allocate routine-local storage using the stack pointer and the frame pointer. This storage is valid only while the stack frame is active. Should the routine that is associated with the stack frame return, the exit handler cannot write to this storage without having the potential for some severe application data corruptions.

A hang-up to a terminal line causes DCL to delete the master process's subprocesses. However, if the subprocesses's exit handler is in a main image installed with privilege, then that exit handler is run even with the DCL command STOP. Also, if the subprocess was spawned NOWAIT, then the spawning process's exit handler is run as well.

Use exit handlers to perform any cleanup that your program requires in addition to the normal rundown operations performed by the operating system. In particular, if your program must perform some final action regardless of whether it exits normally or is aborted, you should write and establish an exit handler to perform that action.

### 9.15.1 Establishing an Exit Handler

To establish an exit handler, use the SYS\$DCLEXH system service. The SYS\$DCLEXH system service requires one argument—a variable-length data structure that describes the exit handler. Figure 9–16 illustrates the structure of an exit handler.

**Figure 9–16 Structure of an Exit Handler**

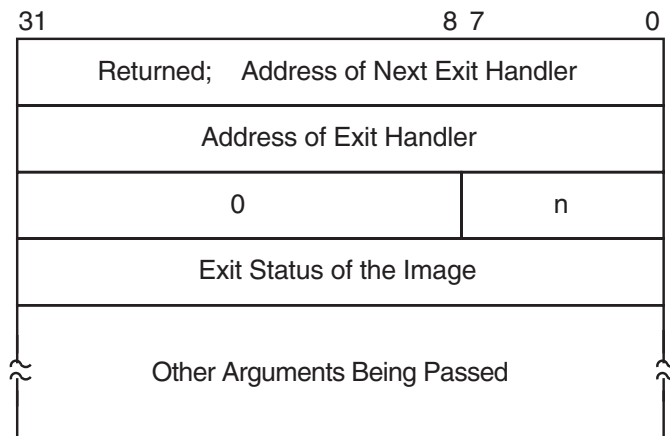

n = The number of arguments being passed to the exit handler; the exit status counts as the first argument.

ZK-2053-GE

The first longword of the structure contains the address of the next handler. The operating system uses this argument to keep track of the established exit handlers; do not modify this value. The second longword of the structure contains the address of the exit handler being established. The low-order byte of the third longword contains the number of arguments to be passed to the exit handler. Each of the remaining longwords contains the address of an argument.

The first argument passed to an exit handler is an integer value containing the final status of the exiting program. The status argument is mandatory. However, do not supply the final status value; when the operating system invokes an exit handler, it passes the handler the final status value of the exiting program.

## Condition-Handling Routines and Services

### 9.15 Exit Handlers

To pass an argument with a numeric data type, use programming language statements to assign the address of a numeric variable to one of the longwords in the exit-handler data structure. To pass an argument with a character data type, create a descriptor of the following form:

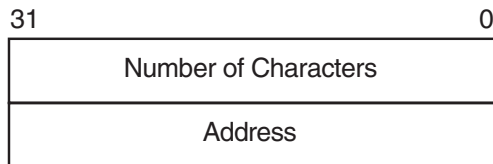

ZK-2054-GE

Use the language statements to assign the address of the descriptor to one of the longwords in the exit-handler data structure.

The following program segment establishes an exit handler with two arguments, the mandatory status argument and a character argument:

```

      .
      .
      .
      ! Arguments for exit handler
      INTEGER EXIT_STATUS      ! Status
      CHARACTER*12 STRING      ! String
      STRUCTURE /DESCRIPTOR/
        INTEGER SIZE,
        2      ADDRESS
      END STRUCTURE
      RECORD /DESCRIPTOR/ EXIT_STRING
      ! Setup for exit handler
      STRUCTURE /EXIT_DESCRIPTOR/
        INTEGER LINK,
        2      ADDR,
        2      ARGS /2/,
        2      STATUS_ADDR,
        2      STRING_ADDR
      END STRUCTURE
      RECORD /EXIT_DESCRIPTOR/ HANDLER
      ! Exit handler
      EXTERNAL EXIT_HANDLER
      .
      .
      .
      ! Set up descriptor
      EXIT_STRING.SIZE = 12      ! Pass entire string
      EXIT_STRING.ADDRESS = %LOC (STRING)
      ! Enter the handler and argument addresses
      ! into the exit handler description
      HANDLER.ADDR = %LOC(EXIT_HANDLER)
      HANDLER.STATUS_ADDR = %LOC(EXIT_STATUS)
      HANDLER.STRING_ADDR = %LOC(EXIT_STRING)
      ! Establish the exit handler
      CALL SYS$DCLEXH (HANDLER)
      .
      .
      .

```

An exit handler can be established at any time during your program and remains in effect until it is canceled (with SYS\$CANEXH) or executed. If you establish more than one handler, the handlers are executed in reverse order: the handler established last is executed first; the handler established first is executed last.

### 9.15.2 Writing an Exit Handler

Write an exit handler as a subroutine, because no function value can be returned. The dummy arguments of the exit subroutine should agree in number, order, and data type with the arguments you specified in the call to SYS\$DCLEXH.

In the following example, assume that two or more programs are cooperating with each other. To keep track of which programs are executing, each has been assigned a common event flag (the common event flag cluster is named ALIVE). When a program begins, it sets its flag; when the program terminates, it clears its flag. Because it is important that each program clear its flag before exiting, you create an exit handler to perform the action. The exit handler accepts two arguments, the final status of the program and the number of the event flag to be cleared. In this example, since the cleanup operation is to be performed regardless of whether the program completes successfully, the final status is not examined in the exit routine. (This subroutine would not be used with the exit handler declaration in the previous example.)

#### **CLEAR\_FLAG.FOR**

```
SUBROUTINE CLEAR_FLAG (EXIT_STATUS,  
2 FLAG)  
! Exit handler clears the event flag  
  
! Declare dummy argument  
INTEGER EXIT_STATUS,  
2 FLAG  
! Declare status variable and system routine  
INTEGER STATUS,  
2 SYS$ASCEFC,  
2 SYS$CLREF  
! Associate with the common event flag  
! cluster and clear the flag  
STATUS = SYS$ASCEFC (%VAL(FLAG),  
2 'ALIVE',,  
IF (.NOT. STATUS) CALL LIB$SIGNAL (%VAL(STATUS))  
STATUS = SYS$CLREF (%VAL(FLAG))  
IF (.NOT. STATUS) CALL LIB$SIGNAL (%VAL (STATUS))  
  
END
```

If for any reason you must perform terminal I/O from an exit handler, use appropriate RTL routines. Trying to access the terminal from an exit handler using language I/O statements may cause a redundant I/O error.

### 9.15.3 Debugging an Exit Handler

To debug an exit handler, you must set a breakpoint in the handler and wait for the operating system to invoke that handler; you cannot use the DEBUG command STEP/INTO to enter an exit handler. In addition, when the debugger is invoked, it establishes an exit handler that exits using the SYS\$EXIT system service. If you invoke the debugger when you invoke your image, the debugger's exit handler does not affect your program's handlers because the debugger's handler is established first and so executes last. However, if you invoke the debugger after your program begins executing (the user presses Ctrl/Y and then types DEBUG), the debugger's handler may affect the execution of your program's exit handlers, because one or more of your handlers may have been established before the debugger's handler and so is not executed.

## Condition-Handling Routines and Services

### 9.15 Exit Handlers

#### 9.15.4 Example of Exit Handler

As in the example in Section 9.15.2, write the exit handler as a subroutine because no function value can be returned. The dummy arguments of the exit subroutine should agree in number, order, and data type with the arguments you specify in the call to SYS\$DCLEXH.

In the following example, assume that two or more programs are cooperating. To keep track of which programs are executing, each has been assigned a common event flag (the common event flag cluster is named ALIVE). When a program begins, it sets its flag; when the program terminates, it clears its flag. Because each program must clear its flag before exiting, you create an exit handler to perform the action. The exit handler accepts two arguments: the final status of the program and the number of the event flag to be cleared.

In the following example, because the cleanup operation is to be performed regardless of whether the program completes successfully, the final status is not examined in the exit routine.

```
! Arguments for exit handler
INTEGER*4 EXIT_STATUS      ! Status
INTEGER*4 FLAG /64/
! Setup for exit handler
STRUCTURE /EXIT_DESCRIPTOR/
  INTEGER LINK,
  2      ADDR,
  2      ARGS /2/,
  2      STATUS_ADDR,
  2      FLAG_ADDR
END STRUCTURE
RECORD /EXIT_DESCRIPTOR/ HANDLER

! Exit handler
EXTERNAL CLEAR_FLAG

INTEGER*4 STATUS,
  2      SYS$ASCEFC,
  2      SYS$SETEF

! Associate with the common event flag
! cluster and set the flag.
STATUS = SYS$ASCEFC (%VAL(FLAG),
  2      'ALIVE',)
IF (.NOT. STATUS) CALL LIB$SIGNAL (%VAL(STATUS))
STATUS = SYS$SETEF (%VAL(FLAG))
IF (.NOT. STATUS) CALL LIB$SIGNAL (%VAL (STATUS))
! Do not exit until cooperating program has a chance to
! associate with the common event flag cluster.

! Enter the handler and argument addresses
! into the exit handler description.
HANDLER.ADDR = %LOC(CLEAR_FLAG)
HANDLER.STATUS_ADDR = %LOC(EXIT_STATUS)
HANDLER.FLAG_ADDR = %LOC(FLAG)
! Establish the exit handler.
CALL SYS$DCLEXH (HANDLER)

! Continue with program
.
.
.
END

! Exit Subroutine
```

## Condition-Handling Routines and Services 9.15 Exit Handlers

```
SUBROUTINE CLEAR_FLAG (EXIT_STATUS,  
2          FLAG)  
! Exit handler clears the event flag  
  
! Declare dummy argument  
INTEGER EXIT_STATUS,  
2          FLAG  
  
! Declare status variable and system routine  
INTEGER STATUS,  
2          SYSSASCEFC,  
2          SYSSCLREF  
  
! Associate with the common event flag  
! cluster and clear the flag  
STATUS = SYSSASCEFC (%VAL(FLAG),  
2          'ALIVE',,  
2          'ALIVE',,  
IF (.NOT. STATUS) CALL LIB$SIGNAL (%VAL(STATUS))  
STATUS = SYSSCLREF (%VAL(FLAG))  
IF (.NOT. STATUS) CALL LIB$SIGNAL (%VAL (STATUS))
```





# Part III

---

## Addressing and Memory Management

This part describes 32-bit and 64-bit address space, and the support offered for 64-bit addressing. It also gives guidelines for 64-bit application programming interfaces (APIs); OpenVMS Alpha, VAX, and VLM memory management with run-time routines for memory management, and alignment on OpenVMS Alpha and VAX systems.



---

## Overview of Alpha Virtual Address Space

As of Version 7.0, the OpenVMS Alpha operating system provides support for 64-bit virtual memory addressing. This capability makes the 64-bit virtual address space, defined by the Alpha architecture, available to the OpenVMS Alpha operating system and to application programs. OpenVMS Alpha Version 7.1 provided extended, additional memory management Very Large Memory (VLM) features. For information about Very Large Memory, see Chapter 16.

### 10.1 Using 64-Bit Addresses

Many OpenVMS Alpha tools and languages (including the Debugger, run-time library routines, and Compaq C) support 64-bit virtual addressing. Input and output operations can be performed directly to and from the 64-bit addressable space by means of RMS services, the \$QIO system service, and most of the device drivers supplied with OpenVMS Alpha systems.

Underlying this are system services that allow an application to allocate and manage the 64-bit virtual address space, which is available for process-private use.

By using the OpenVMS Alpha tools and languages that support 64-bit addressing, programmers can create images that map and access data beyond the limits of 32-bit virtual addresses. The 64-bit virtual address space design ensures upward compatibility of programs that execute under versions of OpenVMS Alpha prior to Version 7.0, while providing a flexible framework that allows 64-bit addresses to be used in many different ways to solve new problems.

Nonprivileged programs can optionally be modified to take advantage of 64-bit addressing features. OpenVMS Alpha 64-bit virtual addressing does not affect nonprivileged programs that are not explicitly modified to exploit 64-bit support. Binary and source compatibility of existing 32-bit nonprivileged programs is guaranteed.

By using 64-bit addressing capabilities, application programs can map large amounts of data into memory to provide high levels of performance and make use of very large memory (VLM) systems. In addition, 64-bit addressing allows for more efficient use of system resources, allowing for larger user processes, as well as higher numbers of users and client/server processes for virtually unlimited scalability.

This chapter describes the layout and components of the OpenVMS Alpha 64-bit virtual memory address space.

For more information about the OpenVMS Alpha programming tools and languages that support 64-bit addressing and recommendations for enhancing applications to support 64-bit addressing and VLM, refer to the subsequent chapters in this guide.

# Overview of Alpha Virtual Address Space

## 10.2 Traditional OpenVMS 32-Bit Virtual Address Space Layout

### 10.2 Traditional OpenVMS 32-Bit Virtual Address Space Layout

In previous versions of the OpenVMS Alpha operating system, the virtual address space layout was largely based upon the 32-bit virtual address space defined by the VAX architecture. Figure 10–1 illustrates the OpenVMS Alpha implementation of the OpenVMS VAX layout.

**Figure 10–1 32-Bit Virtual Address Space Layout**

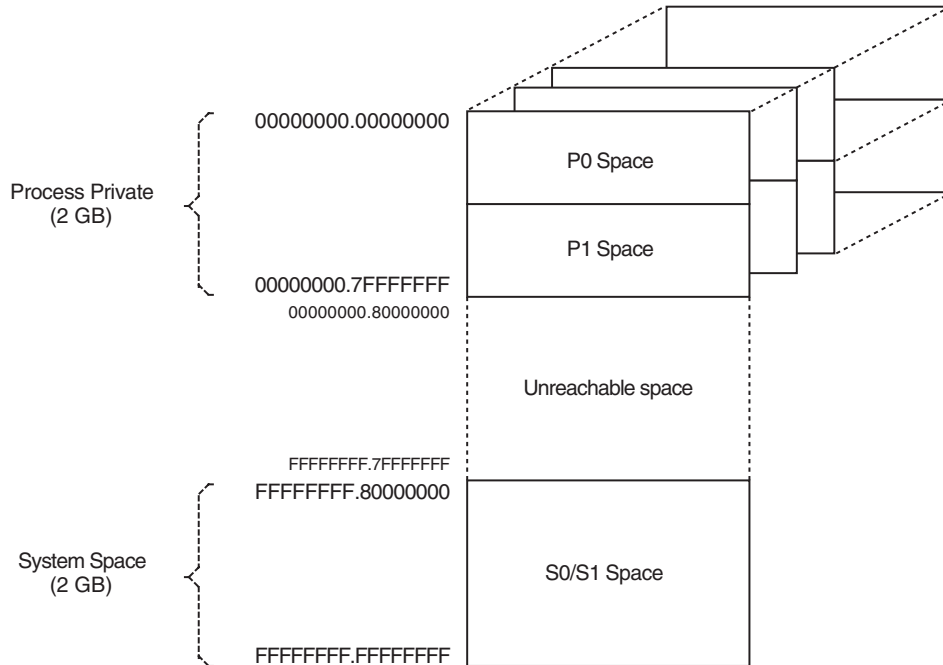

ZK-8383A-GE

The lower half of the OpenVMS VAX virtual address space (addresses between 0 and  $7FFFFFFF_{16}$ ) is called **process-private space**. This space is further divided into two equal pieces called P0 space and P1 space. Each space is 1 GB long. The P0 space range is from 0 to  $3FFFFFFF_{16}$ . P0 space starts at location 0 and expands toward increasing addresses. The P1 space range is from  $40000000_{16}$  to  $7FFFFFFF_{16}$ . P1 space starts at location  $7FFFFFFF_{16}$  and expands toward decreasing addresses.

The upper half of the VAX virtual address space is called **system space**. The lower half of system space (the addresses between  $80000000_{16}$  and  $BFFFFFFF_{16}$ ) is called S0 space. S0 space begins at  $80000000_{16}$  and expands toward increasing addresses.

The VAX architecture associates a page table with each region of virtual address space. The processor translates system space addresses using the system page table. Each process has its own P0 and P1 page tables. A VAX page table does not map the full virtual address space possible; instead, it maps only the part of its region that has been created.

## 10.3 OpenVMS Alpha 64-Bit Virtual Address Space Layout

The OpenVMS Alpha 64-bit address space layout is an extension of the traditional OpenVMS 32-bit address space layout.

Figure 10–2 illustrates the 64-bit virtual address space layout design.

**Figure 10–2 64-Bit Virtual Address Space Layout**

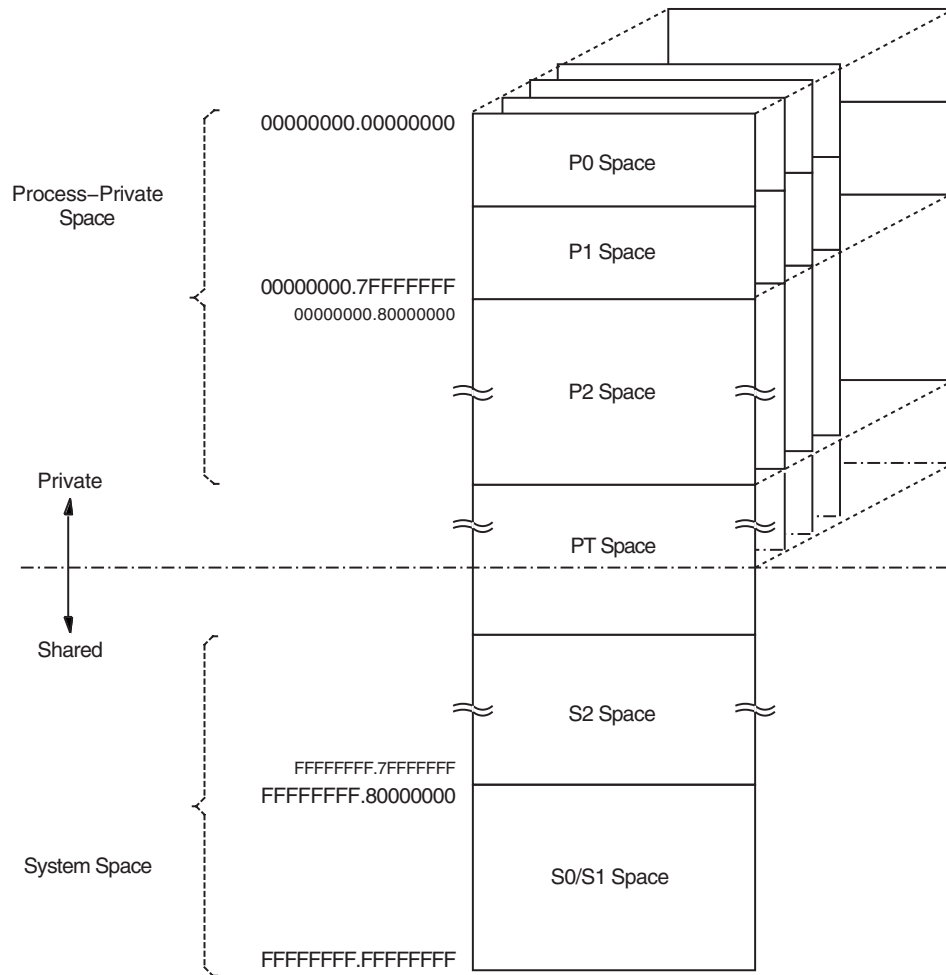

ZK-8384A-GE

The 64-bit virtual address space layout is designed to accommodate the current and future needs of the OpenVMS Alpha operating system and its users. The new address space consists of the following fundamental areas:

- Process-private space
- System space
- Page table space

## Overview of Alpha Virtual Address Space

### 10.3 OpenVMS Alpha 64-Bit Virtual Address Space Layout

#### 10.3.1 Process-Private Space

Supporting process-private address space is a focus of much of the memory management design within the OpenVMS operating system.

**Process-private space**, or process space, contains all virtual addresses below PT space. As shown in Figure 10–2, the layout of process space is further divided into the P0, P1, and P2 spaces. P0 space refers to the program region. P1 space refers to the control region. P2 space refers to the 64-bit program region.

The **P0** and **P1 spaces** are defined to equate to the P0 and P1 regions defined by the VAX architecture. Together, they encompass the traditional 32-bit process-private region that ranges from  $0.00000000_{16}$  to  $0.7FFFFFFF_{16}$ . **P2 space** encompasses all remaining process space that begins just above P1 space,  $0.80000000_{16}$ , and ends just below the lowest address of PT space.

Note that P2 space addresses can be positive or negative when interpreted as signed 64-bit integers.

#### 10.3.2 System Space

**64-bit system space** refers to the portion of the entire 64-bit virtual address range that is higher than that which contains PT space. As shown in Figure 10–2, system space is further divided into the S0, S1, and S2 spaces.

The **S0** and **S1 spaces** are defined to equate to the S0 and S1 regions defined by the VAX architecture. Together they encompass the traditional 32-bit system space region that ranges from  $FFFFFFFF.80000000_{16}$  to  $FFFFFFFF.FFFFFFFF_{16}$ . **S2 space** encompasses all remaining system spaces between the highest address of PT space and the lowest address of the combined S0/S1 space.

S0, S1, and S2 are fully shared by all processes. S0/S1 space expands toward increasing virtual addresses. S2 space generally expands toward lower virtual addresses.

Addresses within system space can be created and deleted only from code that is executing in kernel mode. However, page protection for system space pages can be set up to allow any less privileged access mode read and/or write access.

**System space base** is controlled by the S2\_SIZE system parameter. S2\_SIZE is the number of megabytes to reserve for S2 space. The default value is based on the sizes required by expected consumers of 64-bit (S2) system space. Consumers set up by OpenVMS at boot time are the **page frame number** (PFN) database and the global page table. (For more information about setting system parameters with SYSGEN, see the *OpenVMS System Management Utilities Reference Manual: M–Z*.)

The **global page table**, also known as the **GPT**, and the PFN database reside in the lowest-addressed portion of S2 space. By moving the GPT and PFN database to S2 space, the size of these areas is no longer constrained to a small portion of S0/S1 space. This allows OpenVMS to support much larger physical memories and much larger global sections.

## Overview of Alpha Virtual Address Space

### 10.3 OpenVMS Alpha 64-Bit Virtual Address Space Layout

#### 10.3.3 Page Table Space

In versions of OpenVMS Alpha prior to Version 7.0, **page table space** (also known as **PT space**) was addressable in more than one way. The PALcode translation buffer miss handler used addresses starting at  $2.00000000_{16}$  to read PTEs, while memory management code addressed the page tables primarily within the traditional 32-bit system space. The process page tables were within the process header (PHD), and the system space page tables were located in the highest virtual addresses, all within the traditional 32-bit system space.

As of OpenVMS Alpha Version 7.0, page tables are addressed primarily within 64-bit PT space. Page tables refer to this virtual address range; they are no longer in 32-bit shared system address space.

The dotted line in Figure 10–2 marks the boundary between process-private space and shared space. This boundary is in PT space and further serves as the boundary between the process-private page table entries and the shared page table entries. Together, these sets of entries map the entire address space available to a given process. PT space is mapped to the same virtual address for each process, typically a very high address such as  $FFFFFFFFC.00000000_{16}$ .

#### 10.3.4 Virtual Address Space Size

The Alpha architecture supports 64-bit addresses. OpenVMS Alpha Version 7.0 dramatically increased the total amount of virtual address space from 4 GB (gigabytes) to the 8 TB (terabytes) supported by the current Alpha architecture implementations.

The Alpha architecture requires that all implementations must use or check all 64 bits of a virtual address during the translation of a virtual address into a physical memory address. However, implementations of the Alpha architecture are allowed to materialize a subset of the virtual address space. Current Alpha hardware implementations support 43 significant bits within a 64-bit virtual address. This results in an 8-TB address space.

On current Alpha architecture implementations, bit 42 within a virtual address must be sign-extended or propagated through bit 63 (the least significant bit is numbered from 0). Virtual addresses where bits 42 through 63 are not all zeros or all ones result in an access violation when referenced. Therefore, the valid 8-TB address space is partitioned into two disjoint 4-TB ranges separated by a **no access** range in the middle.

The layout of the OpenVMS Alpha address space transparently places this no access range within P2 space. (The OpenVMS Alpha memory management system services always return virtually contiguous address ranges.) The result of the OpenVMS Alpha address space layout design is that valid addresses in P2 space can be positive or negative values when interpreted as signed 64-bit integers.

Note that to preserve 32-bit nonprivileged code compatibility, bit 31 in a valid 32-bit virtual address can still be used to distinguish an address in P0/P1 space from an address in S0/S1 space.

## Overview of Alpha Virtual Address Space

### 10.4 Virtual Regions

#### 10.4 Virtual Regions

A **virtual region** is a reserved range of process-private virtual addresses. It may be either a **user-defined** virtual region reserved by the user program at run time or a **process-permanent** virtual region reserved by the system on behalf of the process during process creation.

Three process-permanent virtual regions are defined by OpenVMS at the time the process is created:

- Program region (in P0 space)
- Control region (in P1 space)
- 64-bit program region (in P2 space)

These three process-permanent virtual regions exist so that programmers do not have to create virtual regions if their application does not need to reserve additional ranges of address space.

Virtual regions promote modularity within applications by allowing different components of the application to manipulate data in different virtual regions. When a virtual region is created, the caller of the service is returned a region ID to identify that virtual region. The region ID is used when creating, manipulating, and deleting virtual addresses within that region. Different components within an application can create separate virtual regions so that their use of virtual memory does not conflict.

Virtual regions exhibit the following characteristics.

- A virtual region is a **light-weight** object. That is, it does not consume pagefile quota or working set quota for the virtual addresses specified. Creating a user-defined virtual region by calling a new OpenVMS system service merely defines a virtual address range as a distinct address object within which address space can be created, manipulated, and deleted.
- Virtual regions do not overlap. When creating address space within a virtual region, the programmer must specify a region ID to the OpenVMS system service. The programmer must specify the virtual region in which the address space is to be created.
- The programmer cannot create, manipulate, or delete address space that does not lie entirely within the bounds of a defined virtual region.
- Each user-defined virtual region's size is fixed at the time it is created. Given the large range of virtual addresses in P2 space and the light-weight nature of virtual regions, it is not costly to reserve more address space than the application component immediately needs within that virtual region.

Note the exception of process-permanent regions, which have no fixed size.

The 64-bit program virtual region is the only virtual region whose size is not fixed when it is created. At process creation, the 64-bit program region encompasses all of P2 space. When a user-defined virtual region is created in P2 space, OpenVMS memory management shrinks the 64-bit program region so that no two regions overlap. When a user-defined virtual region is deleted, the 64-bit program region expands to encompass the virtual addresses within the deleted virtual region if no other user-defined virtual region exists at lower virtual addresses.



## Overview of Alpha Virtual Address Space

### 10.4 Virtual Regions

- Each virtual region has an owner mode and a create mode associated with it. Access modes that are less privileged than the owner of the virtual region cannot delete the virtual region. Access modes that are less privileged than the create mode set for the virtual region cannot create virtual addresses within the virtual region. Owner and create modes are set at the time the virtual region is created and cannot be changed. The create mode for a virtual region cannot be more privileged than the owner mode.
- When virtual address space is created within a virtual region, allocation generally occurs within the virtual region in a densely expanding manner, as is done within the program (P0 space) and control (P1 space) regions. At the time it is created, each virtual region is set up for the virtual addresses within that virtual region to expand toward either increasing virtual addresses, like P0 space, or decreasing virtual addresses, like P1 space. Users can override this allocation algorithm by explicitly specifying starting addresses.
- All user-defined virtual regions are deleted along with the pages created within each virtual region at image rundown.

#### 10.4.1 Regions Within P0 Space and P1 Space

There is one process-permanent virtual region for all of P0 space that starts at virtual address 0 and ends at virtual address  $0.3FFFFFFF_{16}$ . This is called the **program region**. There is also one process-permanent region for all of P1 space that starts at virtual address  $0.40000000_{16}$  and ends at virtual address  $0.7FFFFFFF_{16}$ . This is called the **control region**.

The program and control regions are considered to be owned by kernel mode and have a create mode of user, because user mode callers can create virtual address space within these virtual regions. This is upwardly compatible with OpenVMS Alpha releases prior to Version 7.0.

These program and control regions cannot be deleted. They are considered to be **process-permanent**.

#### 10.4.2 64-Bit Program Region

P2 space has a densely expandable virtual region starting at the lowest virtual address of P2 space,  $0.80000000_{16}$ . This region is called the **64-bit program region**. Having a 64-bit program region in P2 space allows an application that does not need to take advantage of explicit virtual regions to avoid incurring the overhead of creating a virtual region in P2 space. This virtual region always exists, so addresses can be created within P2 space immediately.

As described in Section 10.4.3, a user can create a virtual region in otherwise unoccupied P2 space. If the user-defined virtual region is specified to start at the lowest address of the 64-bit program region, then any subsequent attempt to allocate virtual memory within the region will fail.

The region has a user create mode associated with it, that is, any access mode can create virtual address space within it.

The 64-bit program region cannot be deleted. It is considered to be process-permanent and survives image rundown. Note that all created address space within the 64-bit program region is deleted and the region is reset to encompass all of P2 space as a result of image rundown.

## Overview of Alpha Virtual Address Space

### 10.4 Virtual Regions

#### 10.4.3 User-Defined Virtual Regions

A user-defined virtual region is a virtual region created by calling the new OpenVMS `SYS$CREATE_REGION_64` system service. The location at which a user-defined virtual region is created is generally unpredictable. In order to maximize the expansion room for the 64-bit program region, OpenVMS memory management allocates virtual regions starting at the highest available virtual address in P2 space that is lower than any existing user-defined virtual region.

For maximum control of the process-private address space, the application programmer can specify the starting virtual address when creating a virtual region. This is useful in situations when it is imperative that the user be able to specify exact virtual memory layout.

Virtual regions can be created so that allocation occurs with either increasing addresses or decreasing virtual addresses. This allows applications with stacklike structures to create virtual address space and expand naturally.

Virtual region creation gives OpenVMS subsystems and the application programmer the ability to reserve virtual address space for expansion. For example, an application can create a large virtual region and then create some virtual addresses within that virtual region. Later, when the application requires more virtual address space, it can expand within the virtual region and create more address space in a virtually contiguous manner to the previous addresses allocated within that virtual region.

Virtual regions can also be created within P0 and P1 space by specifying `VA$M_P0_SPACE` or `VA$M_P1_SPACE` in the flags argument to the `SYS$CREATE_REGION_64` service.

If you do not explicitly delete a virtual region with the `SYS$DELETE_REGION_64` system service, the user-defined virtual region along with all created address space is deleted when the image exits.

---

## Support for 64-Bit Addressing (Alpha Only)

This chapter describes the following features that support 64-bit addressing:

- System services, descriptors, and item lists
- RMS interfaces
- File systems
- OpenVMS Alpha 64-bit API guidelines
- OpenVMS Alpha tools and utilities
- Language and pointers
- Compaq C RTLs

### 11.1 System Services Support for 64-Bit Addressing

New OpenVMS system services are available, and many existing services have been enhanced to manage 64-bit address space. This chapter describes the OpenVMS Alpha system services that support 64-bit addressing and VLM. It explains the changes made to 32-bit services to support 64-bit addresses, and it lists the new 64-bit system services.

To see examples of system services that support 64-bit addressing in an application program, refer to Appendix B. For complete information about the OpenVMS system services listed in this chapter, see the *OpenVMS System Services Reference Manual: A-GETUAI* and *OpenVMS System Services Reference Manual: GETUTC-Z*.

#### 11.1.1 System Services Terminology

The following system services definitions are used throughout this guide.

##### **32-bit system service**

A 32-bit system service is a system service that only supports 32-bit addresses on any of its arguments that specify addresses. If passed by value, on OpenVMS Alpha a 32-bit virtual address is actually a 64-bit address that is sign-extended from 32 bits.

##### **64-bit friendly interface**

A 64-bit friendly interface is an interface that can be called with all 64-bit addresses. A 32-bit system service interface is 64-bit friendly if it needs no modification to handle 64-bit addresses. The internal code that implements the system service might need modification, but the system service interface will not.

## Support for 64-Bit Addressing (Alpha Only)

### 11.1 System Services Support for 64-Bit Addressing

The majority of OpenVMS Alpha system services prior to OpenVMS Alpha Version 7.0 have 64-bit friendly interfaces for the following reasons:

- Chapter 17 defines arguments to standard routines to be 64 bits wide. The caller of a routine sign-extends 32-bit arguments to be 64 bits.
- 64-bit string descriptors can be distinguished from 32-bit string descriptors at run time. (See Chapter 17 for more information about 64-bit descriptors.)
- User-visible RMS data structures contain embedded type information such that the RMS routines can tell whether an extended form of a structure is being used. (See Section 11.2 for more details about RMS 64-bit addressing support.)

Examples of 64-bit friendly system services are \$QIO, \$SYNCH, \$ENQ, and \$FAO.

Examples of routines with 64-bit unfriendly interfaces are most of the memory management system services, such as \$CRETVA, \$DELTVA, and \$CRMPSC. The INADR and RETADR argument arrays do not promote easily to hold 64-bit addresses.

#### 64-bit system service

A 64-bit system service is a system service that is defined to accept all address arguments as 64-bit addresses (not necessarily 32-bit, sign-extended values). Also, a 64-bit system service uses the entire 64 bits of all virtual addresses passed to it.

The 64-bit system services include the **\_64** suffix for services that accept 64-bit addresses by reference. For promoted services, this distinguishes the 64-bit capable version from its 32-bit counterpart. For new services, it is a visible reminder that a 64-bit wide address cell will be read/written. This is also used when a structure is passed that contains an embedded 64-bit address, if the structure is not self-identifying as a 64-bit structure. Hence, a routine name need not include “\_64” simply because it receives a 64-bit descriptor. Remember that passing an arbitrary value by reference does not mean the suffix is required; passing a 64-bit address by reference does.

#### 11.1.2 Comparison of 32-Bit and 64-Bit Descriptors

This section describes 32-bit and 64-bit descriptors. Descriptors are a mechanism for passing parameters where the address of a descriptor is an entry in the argument list. Descriptors contain the address of the parameter, data type, size, and any additional information needed to describe the passed data.

There are two forms of descriptors:

- One form for use with 32-bit addresses
- One form for use with 64-bit addresses

The two forms are compatible, because they can be identified dynamically at run time, and except for the size and placement of fields, 32-bit and 64-bit descriptors are identical in content and interpretation.

Both OpenVMS VAX and OpenVMS Alpha systems use 32-bit descriptors. When used on OpenVMS Alpha systems, 32-bit descriptors provide full compatibility with their use on OpenVMS VAX. The 64-bit descriptors are used only on OpenVMS Alpha systems. They have no counterparts and are not recognized on OpenVMS VAX systems.

## Support for 64-Bit Addressing (Alpha Only)

### 11.1 System Services Support for 64-Bit Addressing

The following figure shows the general descriptor format for a 32-bit descriptor.

**Figure 11–1 General Format of a 32-Bit Descriptor**

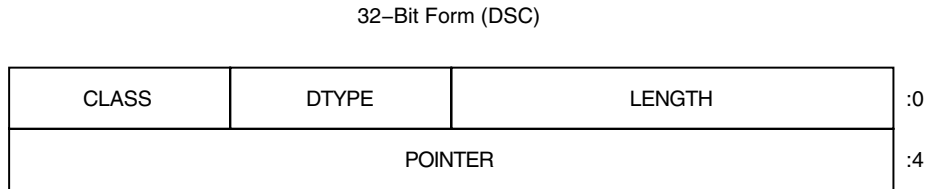

ZK-4663A-GE

The following figure shows the general descriptor format for a 64-bit descriptor.

**Figure 11–2 General Format of a 64-Bit Descriptor**

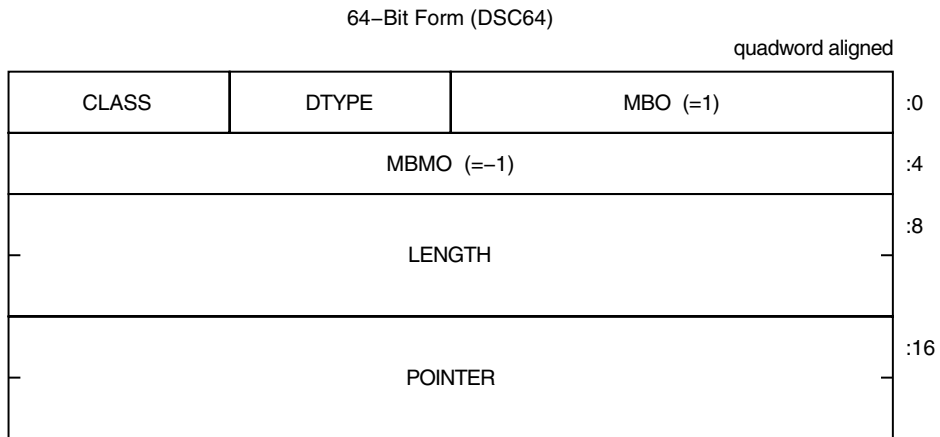

ZK-7656A-GE

When 32-bit descriptors are used on OpenVMS Alpha systems, they have no required alignment for compatibility with OpenVMS VAX systems, even though longword alignment usually promotes better performance. The 64-bit descriptors on OpenVMS Alpha systems must be quadword aligned.

Table 11–1 shows the fields and meanings for both 32-bit and 64-bit descriptors. Because CLASS and DTYPE fields occupy the same offsets in both 32-bit and 64-bit descriptors, these two fields have the same definition, and can contain the same values with the same meanings in both 32-bit and 64-bit forms.

## Support for 64-Bit Addressing (Alpha Only)

### 11.1 System Services Support for 64-Bit Addressing

**Table 11–1 Contents of the General Descriptor Format**

Field	Description
Length	The data item length specific to the descriptor class.
MBO	In a 64-bit descriptor, this field must contain the value 1. This field overlays the length field of a 32-bit descriptor and the value 1 is necessary to distinguish correctly between the two forms.
Dtype	A data-type code.
Class	A descriptor class code that identifies the format and interpretation of the other fields of the descriptor.
Pointer	The address of the first byte of the data element described.
MBMO	In a 64-bit descriptor, this field must contain the value -1 (all 1 bits). This field overlays the pointer field of a 32-bit descriptor and the value -1 is necessary to distinguish correctly between the two forms.

For extensive information about 32-bit and 64-bit descriptors, see Chapter 17. Section 11.4 provides several recommendations and guidelines on implementing 64-bit descriptors.

It is recommended programming practice to use STR\$ Run-Time Library routines when using descriptors. Using STR\$ RTL procedures helps ensure correct operation of complex language features and enforces consistent operations on data access languages. For example, STR\$ANALYZE\_SDESC and STR\$ANALYZE\_SDESC\_64 take as input a 32-bit or 64-bit descriptor argument and extract from the descriptor the length of the data and the address at which the data starts for a variety of string descriptor classes. For complete information on using STR\$ routines, see *OpenVMS RTL String Manipulation (STR\$) Manual*.

#### 11.1.3 Comparison of 32-Bit and 64-Bit Item Lists

The following sections describe item lists and compare the 32-bit and 64-bit type of item lists. Item lists are a mechanism used in OpenVMS system services to pass a list of options and/or data descriptors to a service. Occasionally, item lists are used elsewhere, such as in a single routine in LIBRTL, but they are generally considered specific to the OpenVMS system programming interface. They are not in the OpenVMS Calling Standard.

Item lists that are of the 32-bit type are structures or arrays that consist of one or more item descriptors and the list of the item is terminated by a longword containing a zero. Each item descriptor is either a two or three longword structure that contains either three or four fields.

Like 32-bit item lists, 64-bit item lists are structures or arrays that consist of one or more item descriptors, but unlike the 32-bit item lists, the list of the item is terminated by a quadword containing a zero, instead of a longword.

##### Item List Chaining and Segments

An item list is an array structure that occupies contiguous memory. Some system services support item codes that allow item lists that are non-contiguous and scattered throughout memory to be chained or linked together. Chained item lists are distinct item lists because they are directly linked. For example, the NSA\$\_CHAIN item code of the \$AUDIT\_EVENT system service specifies the item list to process immediately after the current one. The buffer address field

## Support for 64-Bit Addressing (Alpha Only)

### 11.1 System Services Support for 64-Bit Addressing

in the item descriptor specifies the address of the next item list to be processed. Similarly, the LNM\$\_CHAIN item code of \$CRELNM and JPI\$\_CHAIN item code of \$GETJPI system services, point to another item list that the respective system service is to process immediately after it has processed the current item list.

Item lists of 32-bits and 64-bits can be chained together.

Item list segments are the elements that get linked together to form item lists.

#### 11.1.3.1 32-Bit Item Lists

Item lists do not have a formal definition. As a result, there is some variance in their use, but nearly every use consists of a list of one of two forms, referred to as the following:

- item\_list\_2
- item\_list\_3

In both forms, an item code typically identifies the data item to be set or fetched, and a buffer length and address describe the buffer to be read from or written to. The item codes are specific to the facility being called.

The following figure shows the format of the item\_list\_2 item entry.

**Figure 11–3 Item\_list\_2 Format**

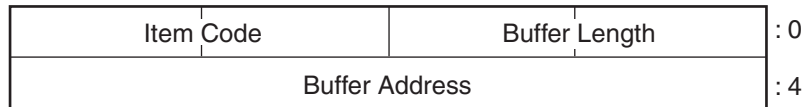

VM-0971A-AI

The following figure shows the format of the item\_list\_3 item entry.

**Figure 11–4 Item\_list\_3 Format**

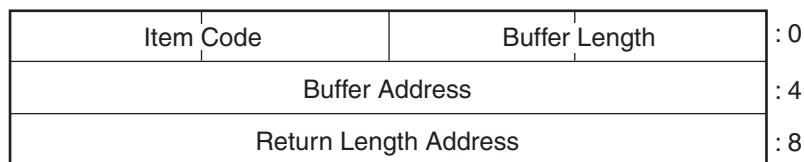

VM-0972A-AI

# Support for 64-Bit Addressing (Alpha Only)

## 11.1 System Services Support for 64-Bit Addressing

The following table defines the fields for 32-bit item list entries:

Field	Description
Buffer length	A word containing a user-supplied integer specifying the length (in bytes) of the buffer in which the service is to write the information. The length of the buffer needed depends on the item code specified in the item code field of the item descriptor.
Item code	A word containing a user-supplied symbolic code specifying the item of information that a service is to return.
Buffer address	A longword containing the user-supplied 32-bit address of the buffer in which a service is to write the information.
Return length address	A longword containing the user-supplied 32-bit address of a word in which a service writes the length (in bytes) of the information it actually returned.

You typically use the `item_list_3` format when the list describes a series of data items to be returned. This format includes a return length address longword, which is the address of a location in which to write the (word) length of data actually written to the buffer.

For `item_list_3` entries, you can set the Return Length Address field to point to the Buffer Length field in the item list entry itself. As a result, the "descriptor-like" portion of the entry is updated by the routine returning the value.

### 11.1.3.2 64-Bit Item Lists

To maintain a degree of compatibility with the 32-bit item lists, 64-bit item lists mirror the definition of 64-bit descriptors.

The names of 32-bit item lists (`item_list_2` and `item_list_3`), which expose the number of longwords in the structure in the name itself, do not apply to 64-bit item lists. The 64-bit versions (`item_list_64a` and `item_list_64b`) do not include an element count.

The following figure shows the format of the `item_list_64a` item entry.

**Figure 11–5 Item\_list\_64a Format**

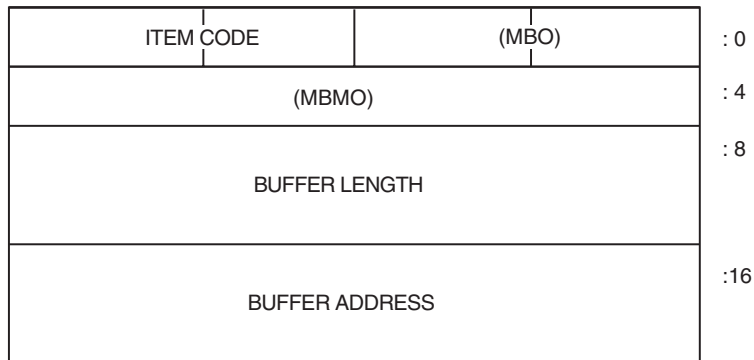

ZK-9016A-GE



## Support for 64-Bit Addressing (Alpha Only)

### 11.1 System Services Support for 64-Bit Addressing

The following shows the format of the item\_list\_64b item entry.

**Figure 11–6 Item\_list\_64b Format**

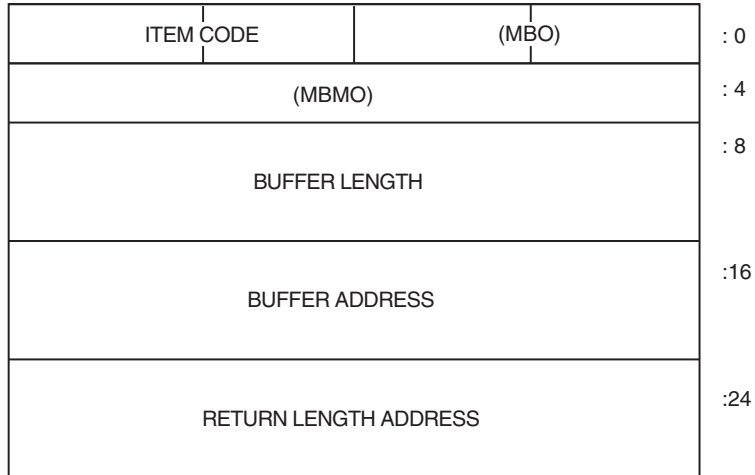

ZK-9017A-GE

The following table defines the item descriptor fields for 64-bit item list entries:

Field	Description
MBO	The field must contain a 1. The MBO and MBMO fields are used to distinguish 32-bit and 64-bit item list entries.
Item code	A word containing a user-supplied symbolic code that describes the information in the buffer or the information to be returned to the buffer, pointed to by the buffer address field.
MBMO	The field must contain a -1. The MBMO and MBO fields are used to distinguish 32-bit and 64-bit item list entries.
Buffer length	A quadword containing a user-supplied integer specifying the length (in bytes) of the buffer in which a service is to write the information. The length of the buffer needed depends on the item code specified in the item code field of the item descriptor.
Buffer address	A quadword containing the user-supplied 64-bit address of the buffer in which a service is to write the information.
Return length address	A quadword containing the user-supplied 64-bit address of a word in which a service writes the length (in bytes) of the information it actually returned.

Because they contain quadword entries, 64-bit item lists should be quadword aligned. If a misaligned list is specified, the called routine still functions properly, but a performance penalty results due to alignment faults.

By maintaining a degree of compatibility between 32-bit and 64-bit item lists, the following advantages result:

- The 64-bit form is easily distinguished from the 32-bit form by routines receiving them as arguments.

## Support for 64-Bit Addressing (Alpha Only)

### 11.1 System Services Support for 64-Bit Addressing

- The item lists continue to demonstrate the behavior that if a 32-bit facility is incorrectly handed as a 64-bit item list, it fails predictably. The buffer address of -1 and the length field of 1 are guaranteed to result in an access violation. The same result comes from passing a 64-bit item list entry to a routine expecting a 32-bit string descriptor. Passing a 64-bit item list element to a routine expecting a 64-bit descriptor is as reliable as it is for their 32-bit counterparts.

Section 11.4 provides several recommendations and guidelines on implementing 64-bit item lists.

#### 11.1.4 System Services That Support 64-Bit Addresses

Table 11–2 summarizes the OpenVMS Alpha system services that support 64-bit addresses.

Although RMS system services provide some 64-bit addressing capabilities, they are not listed in this table because they are not full 64-bit system services. See Section 11.2 for more details.

**Table 11–2 64-Bit System Services**

Service	Arguments
<b>Alignment System Services</b>	
\$GET_ALIGN_FAULT_DATA	buffer_64, buffer_size, return_size_64
\$GET_SYS_ALIGN_FAULT_DATA	buffer_64, buffer_size, return_size_64
\$INIT_SYS_ALIGN_FAULT_REPORT	match_table_64, buffer_size, flags
<b>AST System Service</b>	
\$DCLAST	astadr_64, astprm_64, acmode
<b>Condition Handling System Services</b>	
\$FAO	ctrstr_64, outlen_64, outbuf_64, p1_64...pn_64
\$FAOL	ctrstr_64, outlen_64, outbuf_64, long_prmlst_64
\$FAOL_64	ctrstr_64, outlen_64, outbuf_64, quad_prmlst_64
\$GETMSG	msgid, msglen_64, bufadr_64, flags, outadr_64
\$PUTMSG	msgvec_64, actrtn_64, facnam_64, actprm_64
\$SIGNAL_ARRAY_64	mcharg, sigarg_64

(continued on next page)

## Support for 64-Bit Addressing (Alpha Only)

### 11.1 System Services Support for 64-Bit Addressing

**Table 11–2 (Cont.) 64-Bit System Services**

Service	Arguments
<b>CPU Scheduling System Services</b>	
\$CPU_CAPABILITIES	cpu_id, select_mask, modify_mask, prev_mask, flags
\$CPU_TRANSITION(W)	tran_code, cpu_id, nodename, node_id, flags, efn, iosb, astadr_64, astprm_64
\$FREE_USER_CAPABILITY	cap_num, prev_mask, flags
\$GET_USER_CAPABILITY	cap_num, select_num, select_mask, prev_mask, flags
\$PROCESS_AFFINITY	pidadr, prcnam, select_mask, modify_mask, prev_mask, flags
\$PROCESS_CAPABILITIES	pidadr, prcnam, select_mask, modify_mask, prev_mask, flags
\$SET_IMPLICIT_AFFINITY	pidadr, prcnam, state, cpu_id, prev_mask
<b>Event Flag System Service</b>	
\$READEF	efn, state_64
<b>Fast-I/O System Services</b>	
\$IO_CLEANUP	fandle
\$IO_PERFORM	fandle, chan, iosadr, bufadr, buflen, porint
\$IO_PERFORMW	fandle, chan, iosadr, bufadr, buflen, porint
\$IO_SETUP	func, bufobj, iosobj, astadr, flags, return_fandle
<b>Intra-Cluster Communications System Services</b>	
SYS\$ICC_ACCEPT	conn_handle, accept_buf, accept_len, user_context, flags
SYS\$ICC_CONNECT(W)	ios_icc, astadr, astprm, assoc_handle, conn_handle, remote_assoc, remote_node, user_context, conn_buf, conn_buf_len, return_buf, return_buf_len, retlen_addr, flags
SYS\$ICC_DISCONNECT(W)	conn_handle, iosb, astadr, astprm, disc_buf, disc_buf_len
SYS\$ICC_OPEN_ASSOC	asoc_handle, assoc_name, logical_name, logical_table, conn_event_rtn, disc_event_rtn, rcv_rtn, maxflowbufcut, prot
SYS\$ICC_RECEIVE(W)	conn_handle, ios_icc, astadr, astprm, rcv_buf, rcv_buf_len
SYS\$ICC_REJECT	conn_handle, reject_buf, reject_buf_len, reason
SYS\$ICC_REPLY(W)	conn_handle, ios_icc, astadr, astprm, reply_buf, reply_len
SYS\$ICC_TRANSCEIVE(W)	conn_handle, ios_icc, astadr, astprm, send_buf, send_len
SYS\$ICC_TRANSMIT(W)	conn_handle, ios_icc, astadr, astprm, send_buf, send_len
<b>I/O System Services</b>	
\$ASSIGN	devnam, chan, acmode, mbxnam, flags
\$QIO(W) <sup>1</sup>	efn, chan, func, iosb_64, astadr_64, astprm_64, p1_64, p2_64, p3_64, p4_64, p5_64, p6_64
\$QIOSERVERW	efn, func, context, itmlst, iosb, astadr, astprm

<sup>1</sup>For more information about the \$QIO(W) arguments that support 64-bit addressing, see *Writing OpenVMS Alpha Device Drivers in C*, and *OpenVMS Alpha Guide to Upgrading Privileged-Code Applications*.

(continued on next page)

## Support for 64-Bit Addressing (Alpha Only)

### 11.1 System Services Support for 64-Bit Addressing

**Table 11–2 (Cont.) 64-Bit System Services**

<b>Service</b>	<b>Arguments</b>
<b>I/O System Services</b>	
\$SYNCH	efn, iosb_64
<b>Locking System Services</b>	
\$DEQ	lkid, vablk_64, acmode, flags
\$ENQ(W)	efn, lkmode, lksb_64, flags, resnam_64, parid, astadr_64, astprm_64, blkast_64, acmode
<b>Logical Name System Services</b>	
\$CRELNM	attr, tabnam, lognam, acmode, itmlst
\$CRELNT	ttr, resnam, reslen, quota, promsk, tabnam, partab, acmode
\$DELLNM	tabnam, lognam, acmode
\$TRNLNM	attr, tabnam, lognam, acmode, itmlst
<b>Memory Management System Services</b>	
\$ADJWSL	pagcnt, wsetlm_64
\$CREATE_BUFOBJ_64	start_va_64, length_64, acmode, flags, return_va_64, return_length_64, return_buffer_handle_64
\$CREATE_GDZRO	gsdnam_64, ident_64, prot, length_64, acmode, flags, ...
\$CRMPSC_GDZRO_64	gsdnam_64, ident_64, prot, length_64, region_id_64, section_offset_64, acmode, flags, return_va_64, return_length_64, ...
\$CREATE_GFILE	gsdnam_64, ident_64, file_offset_64, length_64, chan, acmode, flags, return_length_64, ...
\$CREATE_GPFILE	gsdnam_64, ident_64, prot, length_64, acmode, flags
\$CREATE_GPFN	gsdnam_64, ident_64, prot, start_pfn, page_count, acmode, flags
\$CREATE_REGION_64	length_64, region_prot, flags, return_region_id_64, return_va_64, return_length_64, ...
\$CRETVA_64	region_id_64, start_va_64, length_64, acmode, flags, return_va_64, return_length_64
\$CRMPSC_FILE_64	region_id_64, file_offset_64, length_64, chan, acmode, flags, return_va_64, return_length_64, ...
\$CRMPSC_GFILE_64	gsdnam_64, ident_64, file_offset_64, length_64, chan, region_id_64, section_offset, acmode, flags, return_va_64, return_length_64, ...
\$CRMPSC_GPFILE_64	gsdnam_64, ident_64, prot, length_64, region_id_64, section_offset_64, acmode, flags, return_va_64, return_length_64, ...
\$CRMPSC_GPFN_64	gsdnam_64, ident_64, prot, start_pfn, page_count, region_id_64, relative_page, acmode, flags, return_va_64, return_length_64, ...
\$CRMPSC_PFN_64	region_id_64, start_pfn, page_count, acmode, flags, return_va_64, return_length_64, ...
\$DELETE_BUFOBJ	buffer_handle_64

(continued on next page)

## Support for 64-Bit Addressing (Alpha Only)

### 11.1 System Services Support for 64-Bit Addressing

**Table 11–2 (Cont.) 64-Bit System Services**

Service	Arguments
<b>Memory Management System Services</b>	
\$DELETE_REGION_64	region_id_64, acmode, return_va_64, return_length_64
\$DELTVA_64	region_id_64, start_va_64, length_64, acmode, return_va_64, return_length_64
\$DGBLSC	flags, gsdnam_64, ident_64
\$EXPREG_64	region_id_64, length_64, acmode, flags, return_va_64, return_length_64
\$GET_REGION_INFO	function_code, region_id_64, start_va_64, ,buffer_length, buffer_address_64, return_length_64
\$LCKPAG_64	start_va_64, length_64, acmode, return_va_64, return_length_64
\$LKWSET_64	start_va_64, length_64, acmode, return_va_64, return_length_64
\$MGBLSC_64	gsdnam_64, ident_64, region_id_64, section_offset_64, length_64, acmode, flags, return_va_64, return_length_64, ...
\$MGBLSC_GPFN_64	gsdnam_64, ident_64, region_id_64, relative_page, page_count, acmode, flags, return_va_64, return_length_64, ...
\$PURGE_WS	start_va_64, length_64
\$SETPRT_64	start_va_64, length_64, acmode, prot, return_va_64, return_length_64, return_prot_64
\$ULKPAG_64	start_va_64, length_64, acmode, return_va_64, return_length_64
\$ULWSET_64	start_va_64, length_64, acmode, return_va_64, return_length_64
\$UPDSEC_64(W)	start_va_64, length_64, acmode, updfg, efn, ios_a_64, return_va_64, return_length_64, ...
<b>Process Control System Services</b>	
\$GETJPI(W)	efn, pidadr, prenam, itmlst, iosb, astadr, astprm
\$PROCESS_SCAN	pidctx, itmlst
\$WAKE	pidadr, prenam
<b>Time System Services</b>	
\$ASCTIM	timlen, timbuf, timadr, cvtflg
\$ASCUTC	timlen, timbuf, utcadr, cvtflg
\$BINTIM	timbuf, timadr
\$BINUTC	timbuf, utcadr
\$CANTIM	reqidt_64, acmode
\$GETTIM	timadr_64
\$GETUTC	utcadr
\$NUMTIM	timbuf, timadr

(continued on next page)

## Support for 64-Bit Addressing (Alpha Only)

### 11.1 System Services Support for 64-Bit Addressing

Table 11–2 (Cont.) 64-Bit System Services

Service	Arguments
<b>Time System Services</b>	
\$NUMUTC	timbuf, utcadr
\$SETIME	timadr
\$SETIMR	efn, daytim_64, astadr_64, reqidt_64, flags
\$TIMCON	timadr, utcadr, cvtflg
<b>Other System Services</b>	
\$ASCTOID	name, id, attrib
\$CMEXEC_64	routine_64, quad_arglst_64
\$CMKRNL_64	routine_64, quad_arglst_64
\$FINISH_RDB	context
\$GETSYI(W)	efn, csidadr, nodename, itmlst, iosb, astadr, astprm
\$IDTOASC	id, namlen, nambuf, resid, attrib, contxt

#### 11.1.5 Sign-Extension Checking

OpenVMS system services not listed in Table 11–2 and all user-written system services that are not explicitly enhanced to accept 64-bit addresses will receive sign-extension checking. Any argument passed to these services that is not properly sign-extended will cause the error status `SS$_ARG_GTR_32_BITS` to be returned.

#### 11.1.6 Language Support for 64-Bit System Services

C function prototypes for system services are available in `SYS$LIBRARY:SYS$STARLET_C.TLB` (or `STARLET`).

No 64-bit MACRO-32 macros are available for system services. The MACRO-32 caller must use the AMACRO built-in `EVAX_CALLG_64` or the `$CALL64` macro. For more information about MACRO-32 programming support for 64-bit addressing, see *OpenVMS MACRO-32 Porting and User's Guide*.

#### 11.1.7 NEW STARLET Definitions for C

As of OpenVMS Alpha Version 7.0, `SYS$LIBRARY:SYS$STARLET_C.TLB` (or `STARLET`) provides C function prototypes for system services, as well as new and enhanced data structure definitions. The new definitions are more consistent with the OpenVMS C language coding conventions and definitions (typedefs) used in `SYS$LIBRARY:SYS$LIB_C.TLB`.

To maintain source compatibility for existing users of `STARLET.H`, the **old style** function declarations and definitions are still provided by default. To take advantage of the new system service function prototypes and type definitions, you must explicitly enable them.

You can either define the `__NEW_STARLET` symbol with a Compaq C command line qualifier or include the definition directly in your source program. For example:

- Define the `__NEW_STARLET` symbol with the Compaq C command line qualifier as follows:

## Support for 64-Bit Addressing (Alpha Only)

### 11.1 System Services Support for 64-Bit Addressing

```
/DEFINE=(__NEW_STARLET=1)
```

or

- Define the `__NEW_STARLET` symbol in your C source program before including the `SYS$STARLET_C.TLB` header files:

```
#define __NEW_STARLET 1
#include <starlet.h>
#include <vodef.h>
```

To see the currently available system service function prototypes in `STARLET.H`, you can use the Librarian Utility, as shown in the following example:

```
$ LIBRARY/OUTPUT=STARLET.H SYS$LIBRARY:SYS$STARLET_C.TLB/EXTRACT=STARLET
```

The following example shows a new system service function prototype as it is defined in `STARLET.H`:

```
#pragma __required_pointer_size __long
int sys$expreg_64(
    struct_generic_64 *region_id_64,
    unsigned __int64 length_64,
    unsigned int acmode,
    unsigned int flags,
    void *(*(return_va_64)),
    unsigned __int64 *return_length_64);
#pragma __required_pointer_size __short
```

For more information about Compaq C pointer size pragmas, see the *DEC C User's Guide for OpenVMS Systems*.

The following source code example shows the `sys$expreg_64` function prototype referenced in a program.

```
#define __NEW_STARLET 1                /* Enable "New Starlet" features */
#include <starlet.h>                    /* Declare prototypes for system services */
#include <gen64def.h>                  /* Define GENERIC_64 type */
#include <vodef.h>                     /* Define VA$ constants */
#include <ints.h>                      /* Define 64-bit integer types */
#include <far_pointers.h>              /* Define 64-bit pointer types */
{
    int status;                        /* Ubiquitous VMS status value */
    GENERIC_64 region = { VA$C_P2 };  /* Expand in "default" P2 region */
    VOID_PQ_p2_va;                    /* Returned VA in P2 space */
    uint64 length;                    /* Allocated size in bytes */
    extern uint64 page_size;          /* Page size in bytes */
    status = sys$expreg_64( &region, request_size, 0, 0, &p2_va, &length );
    ...
}
```

Table 11-3 lists the data structures that are used by the new function prototypes.

## Support for 64-Bit Addressing (Alpha Only)

### 11.1 System Services Support for 64-Bit Addressing

Table 11–3 Structures Used by `_NEW_STARLET` Prototypes

Structure Used by Prototype	Defined by Header File	Common Prefix for Structure Member Names	Description
<code>struct _cluevthndl</code>	<code>cluevthndl.h</code>	<code>cluevthndl\$</code>	Cluster event handle
<code>struct _fabdef</code>	<code>fabdef.h</code>	<code>fab\$</code>	File access block
<code>struct _generic_64</code>	<code>gen64def.h</code>	<code>gen64\$</code>	Generic quadword structure
<code>struct _ieee</code>	<code>ieeedef.h</code>	<code>ieee\$</code>	IEEE floating point control structure
<code>struct _ile2</code> <sup>1</sup>	<code>iledef.h</code>	<code>ile2\$</code>	Item list entry 2
<code>struct _ile3</code> <sup>1</sup>	<code>iledef.h</code>	<code>ile3\$</code>	Item list entry 3
<code>struct _ilea_64</code> <sup>1</sup>	<code>ilea_64\$</code>	<code>iledef.h</code>	64-bit item list entry A structure
<code>struct _ileb_64</code> <sup>1</sup>	<code>ileb_64\$</code>	<code>iledef.h</code>	64-bit item list entry B structure
<code>struct _iosa</code>	<code>iosadef.h</code>	<code>iosa\$</code>	I/O status area
<code>struct _iosb</code>	<code>iosbdef.h</code>	<code>iosb\$</code>	I/O status block
<code>struct _lksb</code>	<code>lksbdef.h</code>	<code>lksb\$</code>	Lock status block
<code>struct _rabdef</code>	<code>rabdef.h</code>	<code>rab\$</code>	RMS record access block
<code>struct _secid</code>	<code>seciddef.h</code>	<code>secid\$</code>	Global section identifier
<code>struct _va_range</code>	<code>va_rangedef.h</code>	<code>va_range\$</code>	32-bit virtual address range

<sup>1</sup>Use of this structure type is not required by the function prototypes in `starlet.h`. This structure type is provided as a convenience and can be used where it is appropriate.

## 11.2 RMS Interface Enhancements for 64-Bit Addressing

This section summarizes changes to the RMS interface that support 64-bit addressing and enable you to use RMS to perform input and output operations to P2 or S2 space. You can take full advantage of these RMS enhancements by making only minor modifications to existing RMS code.

For complete information about RMS support for 64-bit addressing, see the *OpenVMS Record Management Services Reference Manual*.

The RMS user interface consists of a number of control data structures (FAB, RAB, NAM, XABs). These are linked together with 32-bit pointers and contain embedded pointers to I/O buffers and various user data buffers, including file name strings and item lists. RMS support for 64-bit addressable regions allows 64-bit addresses for the following user I/O buffers:

- UBF (user record buffer)
- RBF (record buffer)
- RHB (fixed-length record header buffer; fixed portion of VFC record format)
- KBF (key buffer containing the key value for random access)

The prompt buffer pointed to by `RAB$L_PBF` is excluded because the terminal driver does not allow 64-bit addresses.



## Support for 64-Bit Addressing (Alpha Only)

### 11.2 RMS Interface Enhancements for 64-Bit Addressing

Specific enhancements to the RMS interface for 64-bit addressing are as follows:

- Data buffers can be placed in P2 or S2 space for the following user I/O services:
  - Record I/O services: \$GET, \$FIND, \$PUT, \$UPDATE
  - Block I/O services: \$READ, \$WRITE
- The RAB structure points to the record and data buffers used by these services.
- An extension of the existing RAB structure is used to specify 64-bit buffer pointers and sizes.
- The buffer size maximum for RMS block I/O services (\$READ and \$WRITE) has been increased from 64 KB to 2 GB, with two exceptions:
  - For RMS journaling, a journaled \$WRITE service is restricted to the current maximum (65535 minus 99 bytes of journaling overhead). An RSZ error is returned to RAB\$L\_STS if the maximum is exceeded.
  - Magnetic tape is still limited to 65535 bytes at the device driver level.Buffer size maximums for RMS record I/O services (\$GET, \$PUT, \$UPDATE) have not changed. Prior RMS on-disk record size limits still apply.

The rest of the RMS interface currently is restricted to 32-bit pointers:

- FAB, RAB, NAM, and XABs must still be allocated in 32-bit space.
- Any descriptors or embedded pointers to file names, item lists, and so on, must continue to use 32-bit pointers.
- Any arguments passed to the RMS system services remain 32-bit arguments. If you attempt to pass a 64-bit argument, the SS\$\_ARG\_GTR\_32\_BITS error is returned.

#### 11.2.1 RAB64 Data Structure

The RAB64, a RMS user interface structure, is an extended RAB that can accommodate 64-bit buffer addresses. The RAB64 data structure consists of a 32-bit RAB structure followed by a 64-bit extension as shown below:

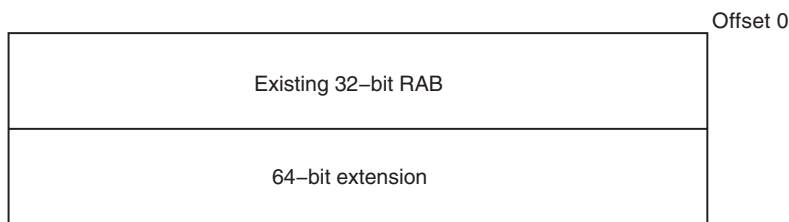

ZK-8425A-GE

The RAB64 contains fields identical to all of the RAB fields except that field names have the RAB64 prefix instead of the RAB prefix. In addition, RAB64 has the following fields in the extension:

## Support for 64-Bit Addressing (Alpha Only)

### 11.2 RMS Interface Enhancements for 64-Bit Addressing

This field...	Is an extension of this field	Description
RAB64\$Q_CTX	RAB64\$L_CTX	User context. This field is not used by RMS but is available to the user. The CTX field is often used to contain a pointer. For asynchronous I/O, it provides the user with the equivalent of an AST parameter.
RAB64\$PQ_KBF	RAB64\$L_KBF	Key buffer address containing the key value for random access (for \$GET and \$FIND).
RAB64\$PQ_RBF	RAB64\$L_RBF	Record buffer address (for \$PUT, \$UPDATE, and \$WRITE).
RAB64\$PQ_RHB	RAB64\$L_RHB	Record header buffer address (fixed portion of VFC record format).
RAB64\$Q_RSZ	RAB64\$W_RSZ	Record buffer size.
RAB64\$PQ_UBF	RAB64\$L_UBF	User buffer address (for \$GET and \$READ).
RAB64\$Q_USZ	RAB64\$W_USZ	User buffer size.

Note that the fields with the PQ tag in their names can hold either a 64-bit address or a 32-bit address sign-extended to 64 bits. Therefore, you can use the fields in all applications whether or not you are using 64-bit addresses.

For most record I/O service requests, there is an RMS internal buffer between the device and the user's data buffer. The one exception occurs with the RMS service \$PUT. If the device is a unit record device and it is not being accessed over the network, RMS passes the address of the user record buffer (RBF) to the \$QIO system service. If you inappropriately specify a record buffer (RBF) allocated in 64-bit address space for a \$PUT to a unit record device that does not support 64-bit address space (for example, a terminal), the \$QIO service returns SS\$\_NOT64DEVFUNC. (See *Writing OpenVMS Alpha Device Drivers in C* and *OpenVMS Alpha Guide to Upgrading Privileged-Code Applications* for more information about \$QIO.) RMS returns the error status RMS\$\_SYS with SS\$\_NOT64DEVFUNC as the secondary status value in RAB64\$L\_STV.

RMS system services support the RAB structure as well as the RAB64 structure.

#### 11.2.2 Using the 64-Bit RAB Extension

Only minimal source code changes are required for applications to use 64-bit RMS support.

RMS allows you to use the RAB64 wherever you can use a RAB. For example, you can use RAB64 in place of a RAB as the first argument passed to any of the RMS record or block I/O services.

Because the RAB64 is an upwardly compatible extension of the existing RAB, most source modules can treat references to fields in a RAB64 as if they were references to a RAB. The 64-bit buffer address counterpart is used by the source module only if the following two conditions are met:

- The RAB64\$B\_BLN field has been initialized to RAB64\$C\_BLN64 to show that the extension is present.
- The 32-bit address field in the 32-bit portion of the RAB contains -1.

## Support for 64-Bit Addressing (Alpha Only)

### 11.2 RMS Interface Enhancements for 64-Bit Addressing

The source module uses the value in the quadword size field only if the contents of the 32-bit address field designate its use. For example:

If this address field contains -1	The address in this field is used	And the size in this field is used
RAB64\$L_UBF	RAB64\$PQ_UBF <sup>1</sup>	RAB64\$Q_USZ
RAB64\$L_RBF	RAB64\$PQ_RBF <sup>1</sup>	RAB64\$Q_RSZ
RAB64\$L_KBF	RAB64\$PQ_KBF	RAB64\$B_KSZ
RAB64\$L_RHB	RAB64\$PQ_RHB	FAB\$B_FSZ

<sup>1</sup>This field can contain either a 64-bit address or a 32-bit address sign-extended to 64 bits.

While RMS allows you to use the RAB64 wherever you can use a RAB, some source languages may impose other restrictions. Consult the documentation for your source language for more information.

#### 11.2.3 Macros to Support User RAB Structure

The following new MACRO-32 and BLISS macros have been implemented to support the 64-bit extension to the user RAB structure:

- MACRO-32 macros

- \$RAB64 (counterpart to \$RAB)
- \$RAB64\_STORE (counterpart to \$RAB\_STORE)

Using these macros has the following results:

- RAB\$B\_BLN is assigned the constant of RAB\$C\_BLN64.
- The original longword I/O buffers are initialized to -1, and the USZ and RSZ word sizes are initialized to 0.
- Values specified using the UBF, USZ, RBF, RSZ, RHB, or KBF keywords are moved into the quadword fields for these keywords. (In contrast, the \$RAB and \$RAB\_STORE macros move these values into the longword [or word] fields for these keywords.)

- BLISS macros

The following BLISS macros are available only in the STARLET.R64 library because they use the QUAD keyword, which is available only to BLISS-64. Thus, any BLISS routines referencing them must be compiled using the BLISS-64 compiler.

- \$RAB64 (counterpart to \$RAB)
- \$RAB64\_INIT (counterpart to \$RAB\_INIT)
- \$RAB64\_DECL (counterpart to \$RAB\_DECL)

Using the first two macros has these results:

- RAB\$B\_BLN is assigned the constant of RAB\$C\_BLN64.
- The original longword I/O buffers are initialized to -1, and the USZ and RSZ word sizes are initialized to 0.

## Support for 64-Bit Addressing (Alpha Only)

### 11.2 RMS Interface Enhancements for 64-Bit Addressing

- Values assigned to the keywords UBF, USZ, RBF, RSZ, RHB, or KBF are moved into the quadword fields for these keywords. (In contrast, the \$RAB and \$RAB\_INIT macros move these values into the longword [or word] fields for these keywords.)

The third macro allocates a block structure of bytes with a length of RAB\$C\_BLN64.

### 11.3 File System Support for 64-Bit Addressing

The Extended QIO Processor (XQP) file system, which implements the Files-11 On-Disk Structure Level 2 (ODS-2) and the Magnetic Tape Ancillary Control Process both provide support for the use of 64-bit buffer addresses for virtual read and write functions.

The XQP and ACP translate a virtual I/O request to a file into one or more logical I/O requests to a device. Because the buffer specified with the XQP or ACP request is passed on to the device driver, the support for buffers in P2 or S2 space is also dependent on the device driver used by the XQP and ACP.

All OpenVMS supplied disk and tape drivers support 64-bit addresses for data transfers to and from disk and tape devices on the virtual, logical, and physical read and write functions. Therefore, the XQP and Magnetic Tape ACP support buffers in P2 or S2 space on the virtual read and write functions.

The XQP and ACP do not support buffer addresses in P2 or S2 space on the control functions (IO\$\_ACCESS, IO\$\_DELETE, IO\$\_MODIFY, and so on).

For more information about device drivers that support 64-bit buffer addresses, see *Writing OpenVMS Alpha Device Drivers in C*.

### 11.4 OpenVMS Alpha 64-Bit API Guidelines

This section describes the guidelines used to develop 64-bit interfaces to support OpenVMS Alpha 64-bit virtual addressing. Application programmers who are developing their own 64-bit application programming interfaces (APIs) might find this information useful.

These recommendations are not hard and fast rules. Most are examples of good programming practices.

For more information about C pointer pragmas, see the *DEC C User's Guide for OpenVMS Systems*.

#### 11.4.1 Quadword/Longword Argument Pointer Guidelines

Because OpenVMS Alpha 64-bit addressing support allows application programs to access data in 64-bit address spaces, pointers that are not 32-bit sign-extended values (64-bit pointers) will become more common within applications. Existing 32-bit APIs will continue to be supported, and the existence of 64-bit pointers creates some potential pitfalls that programmers must be aware of.

For example, 64-bit addresses may be inadvertently passed to a routine that can handle only a 32-bit address. Another dimension of this would be a new API that includes 64-bit pointers embedded in data structures. Such pointers might be restricted to point to 32-bit address spaces initially, residing within the new data structure as a sign-extended 32-bit value.

## Support for 64-Bit Addressing (Alpha Only)

### 11.4 OpenVMS Alpha 64-Bit API Guidelines

Routines should guard against programming errors where 64-bit addresses are being passed instead of 32-bit addresses. This type of checking is called **sign-extension checking**, which means that the address is checked to ensure that the upper 32 bits are all zeros or all ones, matching the value of bit 31. This checking can be performed at the routine interface that is imposing this restriction.

When defining a new routine interface, you should consider the ease of programming a call to the routine from a 32-bit source module. You should also consider calls written in all OpenVMS programming languages, not just those languages initially supporting 64-bit addressing. To avoid promoting awkward programming practices for the 32-bit caller of a new routine, you should accommodate 32-bit callers as well as 64-bit callers.

**Arguments passed by reference that are restricted to reside in a 32-bit address space (P0/P1/S0/S1) should have their reference addresses sign-extension checked.**

The OpenVMS Calling Standard requires that 32-bit values passed to a routine be sign-extended to 64-bits before the routine is called. Therefore, the called routine always receives 64-bit values. A 32-bit routine cannot tell if its caller correctly called the routine with a 32-bit address, unless the reference to the argument is checked for sign-extension.

This sign-extension checking would also apply to the reference to a descriptor when data is being passed to a routine by descriptor.

The called routine should return the error status `SS$_ARG_GTR_32_BITS` if the sign-extension check fails.

Alternately, if you want the called routine to accept the data being passed in a 64-bit location without error and if the sign-extension check fails, the data can be copied by the called routine to a 32-bit address space. The 32-bit address space to which the routine copies the data can be local routine storage (that is, the current stack). If the data is copied to a 32-bit location other than local storage, memory leaks and reentrancy issues must be considered.

When new routines are developed, pointers to code and all data pointers passed to the new routines should be accommodated in 64-bit address spaces where possible. This is desirable even if the data is a routine or is typically considered **static data**, which the programmer, compiler, or linker would not normally put in a 64-bit address space. When code and static data is supported in 64-bit address spaces, this routine should not need additional changes.

**32-bit descriptor arguments should be validated to be 32-bit descriptors.**

Routines that accept descriptors should test the fields that allow you to distinguish the 32-bit and 64-bit descriptor forms. If a 64-bit descriptor is received, the routine should return an error.

Most existing 32-bit routines will return or signal the error status `SS$_ACCVIO` when incorrectly presented with a 64-bit descriptor for the following reasons:

- The 64-bit form of a descriptor contains an MBO (must be one) word at offset 0, where the 32-bit descriptor LENGTH is located, and
- An MBMO (must be minus one) longword at offset 4, where the 32-bit descriptor's POINTER is located, as shown in the following figure:

## Support for 64-Bit Addressing (Alpha Only)

### 11.4 OpenVMS Alpha 64-Bit API Guidelines

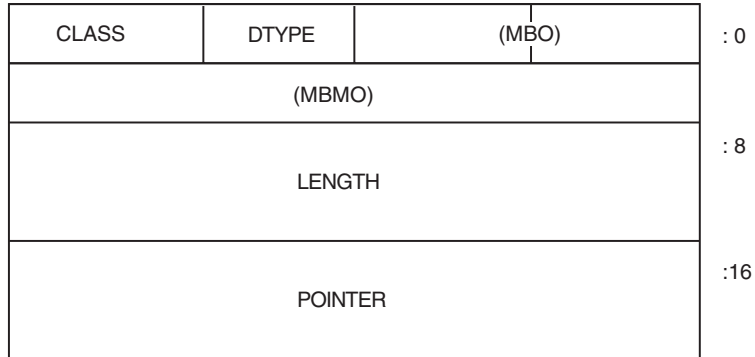

ZK-8489A-GE

#### **Routines that accept arguments passed by 64-bit descriptors should accommodate 32-bit descriptors as well as 64-bit descriptors.**

New routines should accommodate 32-bit and 64-bit descriptors within the same routine. The same argument can point to either a 32-bit or 64-bit descriptor. The 64-bit descriptor MBO word at offset 0 should be tested for 1, and the 64-bit descriptor MBMO longword at offset 4 should be tested for a -1 to distinguish between a 64-bit and 32-bit descriptor.

Consider an existing 32-bit routine that is being converted to handle 64-bit as well as 32-bit descriptors. If the input descriptor is determined to be a 64-bit descriptor, the data being pointed to by the 64-bit descriptor can first be copied to a 32-bit memory location, then a 32-bit descriptor would be created in 32-bit memory. This new 32-bit descriptor can then be passed to the existing 32-bit code, so that no further modifications need to be made internally to the routine.

#### **32-bit item list arguments should be validated to be 32-bit item lists.**

Two forms of item lists are defined: `item_list_2` and `item_list_3`. The `item_list_2` form of an item list consists of two longwords with the first longword containing a length and item code fields, while the second longword typically contains a buffer address.

The `item_list_3` form of an item list consists of three longwords with the first longword containing a length and item code fields, while the second and third longwords typically contain a buffer address and a return length address field.

Since two forms of 32-bit item lists exist, two forms of a 64-bit item list are defined. Dubbed `item_list_64a` and `item_list_64b`, these item list forms parallel their 32-bit counterparts. Both forms of item list contain the MBO and MBMO fields at offsets 0 and 4 respectively. They also each contain a word-sized item code field, a quadword-sized length field, and a quadword-sized buffer address field. The `item_list_64b` form of an item list contains an additional quadword for the return length address field. The returned length is 64-bits.

Routines that accept item lists should test the fields that allow you to distinguish the 32-bit and 64-bit item list forms. If a 64-bit item list is received, the routine should return an error.

Most existing 32-bit routines will return or signal the error status `SS$_ACCVIO` when incorrectly presented with a 64-bit item list for the following reasons:

- The 64-bit form of an item list contains an MBO (must be one) word at offset 0, where the 32-bit item list LENGTH is located, and

## Support for 64-Bit Addressing (Alpha Only)

### 11.4 OpenVMS Alpha 64-Bit API Guidelines

- An MBMO (must be minus one) longword at offset 4, where the 32-bit item list's BUFFER ADDRESS is located as shown in Figure 11–7 and Figure 11–8.

**Figure 11–7 item\_list\_64a**

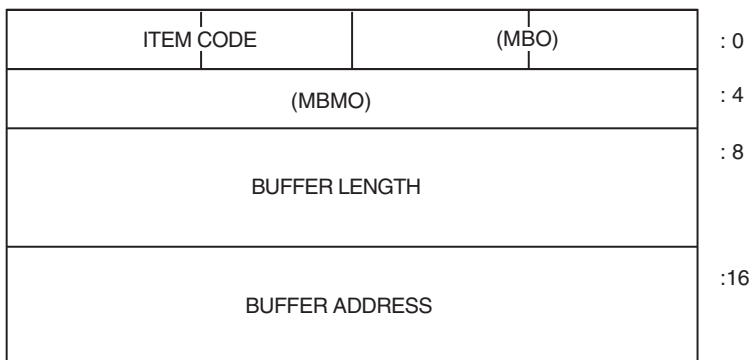

ZK-9016A-GE

**Figure 11–8 item\_list\_64b**

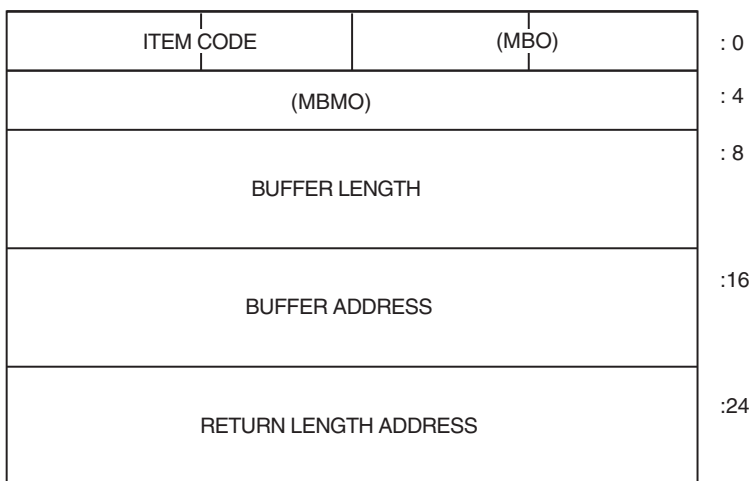

ZK-9017A-GE

**Routines that accept arguments passed by 64-bit item list arguments should accommodate 32-bit item lists as well as 64-bit item lists.**

New routines should accommodate 32-bit and 64-bit item lists within the same routine. The same argument can point to either a 32-bit or 64-bit item list. The 64-bit item list MBO word at offset 0 should be tested for 1, and the 64-bit item list MBMO longword at offset 4 should be tested for a -1 to distinguish between a 64-bit and 32-bit item list.

**Avoid passing pointers by reference.**

If passing a pointer by reference is necessary, as with certain memory management routines, the pointer should be defined to be 64-bit wide.

Mixing 32-bit and 64-bit pointers can cause programming errors when the caller incorrectly passes a 32-bit wide pointer by reference when a 64-bit wide pointer is expected.

## Support for 64-Bit Addressing (Alpha Only)

### 11.4 OpenVMS Alpha 64-Bit API Guidelines

If the called routine reads a 64-bit wide pointer that was allocated only one longword by the programmer, the wrong address could be used by the routine.

If the called routine returns a 64-bit pointer, and therefore writes a 64-bit wide address into a longword allocated by the programmer, data corruption can occur.

Existing routines that are passed pointers by reference require new interfaces for 64-bit support. Old routine interfaces would still be passed the pointer in a 32-bit wide memory location and the new routine interface would require that the pointer be passed in a 64-bit wide memory location. Keeping the same interface and passing it 64-bit wide pointers would break existing programs.

**Example:** The return virtual address used in the SYS\$CRETVA\_64 service is an example of when it is acceptable to pass a pointer by reference. Virtual addresses created in P0 and P1 space are guaranteed to have only 32 bits of significance, however all 64 bits are returned. SYS\$CRETVA\_64 can also create address space in 64-bit space and thus return a 64-bit address. The value that is returned must always be 64 bits because a 64-bit address can be returned.

Memory allocation routines should return the pointer to the data allocated by value (that is, in R0), if possible. The C allocation routines, malloc, calloc, and realloc are examples of this.

New interfaces for routines that are not memory management routines should avoid defining output arguments to receive addresses. Problems will arise whenever a 64-bit subsystem allocates memory and then returns a pointer back to a 32-bit caller in an output argument. The caller may not be able to support or express a 64-bit pointer. Instead of returning a pointer to some data, the caller should provide a pointer to a buffer and the called routine should copy the data into the user's buffer.

A 64-bit pointer passed by reference should be defined by the programmer in such a way that a call to the routine can be written in a 64-bit language or a 32-bit language. It should be clearly indicated that a 64-bit pointer is required to be passed by all callers.

#### **Routines must not return 64-bit addresses unless they are specifically requested.**

It is extremely important that routines that allocate memory and return an address to their callers always allocate 32-bit addressable memory, unless it is known absolutely that the caller is capable of handling 64-bit addresses. This is true for both function return values and output parameters. This rule prevents 64-bit addresses from *creeping in* to applications that do not expect them. As a result, programmers developing callable libraries should be particularly careful to follow this rule.

Suppose an existing routine returns the address of memory it has allocated, such as the routine value. If the routine accepts an input parameter that in some way allows it to determine that the caller is 64-bit capable, it is safe to return a 64-bit address. Otherwise, it *must* continue to return a 32-bit, sign-extended address. In the latter case, a new version of the routine could be provided, which 64-bit callers could invoke instead of the existing version if they prefer that 64-bit memory be allocated.

**Example:** The routines in LIBRTL that manipulate string descriptors can be sure that a caller is 64-bit capable if the descriptor passed in is in the new 64-bit format. As a result, it is safe for them to allocate 64-bit memory for string data, in that case. Otherwise, they will continue to use only 32-bit addressable memory.



## Support for 64-Bit Addressing (Alpha Only)

### 11.4 OpenVMS Alpha 64-Bit API Guidelines

#### Avoid embedded pointers in data structures in public interfaces.

If embedded pointers are necessary for a new structure in a new interface, provide storage within the structure for a 64-bit pointer (quadword aligned). The called routine, which may have to read the pointer from the structure, simply reads all 64 bits.

If the pointer must be a 32-bit, sign-extended address (for example, because the pointer will be passed to a 32-bit routine) a sign-extension check should be performed on the 64-bit pointer at the entrance to the routine. If the sign-extension check fails, the error status `SS$_ARG_GTR_32_BITS` may be returned to the caller, or the data in a 64-bit address space may be copied to a 32-bit address space.

The new structure should be defined by the programmer in such a way that a 64-bit caller or a 32-bit caller does not contain awkward code. The structure should provide a quadword field for the 64-bit caller overlaid with two longword fields for the 32-bit caller. The first of these longwords is the 32-bit pointer field and the next is an MBSE (must be sign-extension) field. For most 32-bit callers, the MBSE field will be zero because the pointer will be a 32-bit process space address. The key here is to define the pointer as a 64-bit value and make it clear to the 32-bit caller that the full quadword must be filled in.

In the following example, both 64-bit and 32-bit callers would pass a pointer to the **block** structure and use the same function prototype when calling the function routine. (Assume *data* is an unknown structure defined in another module.)

```
#pragma required_pointer_size save
#pragma required_pointer_size 32

typedef struct block {
    int blk_l_size;
    int blk_l_flags;
    union {
#pragma required_pointer_size 64
        struct data *blk_pq_pointer;
#pragma required_pointer_size 32
        struct {
            struct data *blk_ps_pointer;
            int blk_l_mbse;
        } blk_r_long_struct;
    } blk_r_pointer_union;
} BLOCK;

#define blk_pq_pointer    blk_r_pointer_union.blk_pq_pointer
#define blk_r_long_struct blk_r_pointer_union.blk_r_long_struct
#define blk_ps_pointer    blk_r_long_struct.blk_ps_pointer
#define blk_l_mbse        blk_r_long_struct.blk_l_mbse

/* Routine accepts 64-bit pointer to the "block" structure */
#pragma required_pointer_size 64
int routine(struct block*);

#pragma required_pointer_size restore
```

For an existing 32-bit routine specifying an input argument, which is a structure that embeds a pointer, you can use a different approach to preserve the existing 32-bit interface. You can develop a 64-bit form of the data structure that is distinguished from the 32-bit form of the structure at run time. Existing code that accepts only the 32-bit form of the structure should automatically fail when presented with the 64-bit form.

## Support for 64-Bit Addressing (Alpha Only)

### 11.4 OpenVMS Alpha 64-Bit API Guidelines

The structure definition for the new 64-bit structure should contain the 32-bit form of the structure. Including the 32-bit form of the structure allows the called routine to declare the input argument as a pointer to the 64-bit form of the structure and cleanly handle both cases.

Two different function prototypes can be provided for languages that provide type checking. The default function prototype should specify the argument as a pointer to the 32-bit form of the structure. The programmer can select the 64-bit form of the function prototype by defining a symbol, specified by documentation.

The 64-bit versus 32-bit descriptor is an example of how this can be done.

**Example:** In the following example, the state of the symbol FOODEF64 selects the 64-bit form of the structure along with the proper function prototype. If the symbol FOODEF64 is undefined, the old 32-bit structure is defined and the old 32-bit function prototype is used.

The source module that implements the function `foo_print` would define the symbol FOODEF64 and be able to handle calls from 32-bit and 64-bit callers. The 64-bit caller would set the field `foo64$l_mbmo` to -1. The routine `foo_print` would test the field `foo64$l_mbmo` for -1 to determine if the caller used either the 64-bit form of the structure or the 32-bit form of the structure.

```
#pragma required_pointer_size save
#pragma required_pointer_size 32

typedef struct foo {
    short int    foo$w_flags;
    short int    foo$w_type;
    struct data * foo$ps_pointer;
} FOO;

#ifndef FOODEF64

/* Routine accepts 32-bit pointer to "foo" structure */
int foo_print(struct foo * foo_ptr);

#endif

#ifdef FOODEF64

typedef struct foo64 {
    union {
        struct {
            short int    foo64$w_flags;
            short int    foo64$w_type;
            int           foo64$l_mbmo;
#pragma required_pointer_size 64
            struct data * foo64$ps_pointer;
#pragma required_pointer_size 32
        } foo64$r_foo64_struct;
        FOO foo64$r_foo32;
    } foo64$r_foo_union;
} FOO64;

#define foo64$w_flags    foo64$r_foo_union.foo64$r_foo64_struct.foo64$w_flags
#define foo64$w_type    foo64$r_foo_union.foo64$r_foo64_struct.foo64$w_type
#define foo64$l_mbmo    foo64$r_foo_union.foo64$r_foo64_struct.foo64$l_mbmo
#define foo64$ps_pointer foo64$r_foo_union.foo64$r_foo64_struct.foo64$ps_pointer
#define foo64$r_foo32    foo64$r_foo_union.foo64$r_foo32

/* Routine accepts 64-bit pointer to "foo64" structure */
#pragma required_pointer_size 64
int foo_print(struct foo64 * foo64_ptr);

#endif
```

## Support for 64-Bit Addressing (Alpha Only)

### 11.4 OpenVMS Alpha 64-Bit API Guidelines

```
#pragma required_pointer_size restore
```

In the previous example, if the structures `foo` and `foo64` will be used interchangeably within the same source module, you can eliminate the symbol `FOODEF64`. The routine `foo_print` would then be defined as follows:

```
int foo_print (void * foo_ptr);
```

Eliminating the `FOODEF64` symbol allows 32-bit and 64-bit callers to use the same function prototype; however less strict type checking is then available during the C source compilation.

#### 11.4.2 Alpha/VAX Guidelines

The following sections provide guidelines about using arguments on Alpha and VAX systems.

##### **Only address, size, and length arguments should be passed as quadwords by value.**

Arguments passed by value are restricted to longwords on VAX. To be compatible with VAX APIs, quadword arguments should be passed by reference instead of by value. However, addresses, sizes and lengths are examples of arguments which, because of the architecture, could logically be longwords on OpenVMS VAX and quadwords on OpenVMS Alpha.

Even if the API will not be available on OpenVMS VAX, this guideline should still be followed for consistency across all APIs.

##### **Avoid page size dependent units.**

Arguments such as lengths and offsets should be represented in units that are page size independent, such as bytes.

A pagelet is an awkward unit. It was invented for compatibility with VAX and is used on OpenVMS Alpha within OpenVMS VAX compatible interfaces. A pagelet is equivalent in size to a VAX page and should not be considered a page size independent unit because it is often confused with a CPU-specific page on Alpha.

**Example:** `Length_64` argument in `EXPREG_64` is passed as a quadword byte count by value.

##### **Naturally align all data passed by reference.**

The called routine should specify to the compiler that arguments are aligned, and the compiler can perform more efficient load and store sequences. If the data is not naturally aligned, users will experience performance penalties.

If the called routine can execute incorrectly because the data passed by reference is not naturally aligned, the called routine should do explicit checking and return an error if not aligned. For example, if a load/locked, store/conditional is being done internally in the routine on the data, and the data is not aligned, the load/locked, store/conditional will not work properly.

#### 11.4.3 Promoting an API from a 32-Bit API to a 64-Bit API

For ease of use, it is best to separate promoting an API from improving the 32-bit design or adding new functionality. Calling a routine within the new 64-bit API should be an easy programming task.

## Support for 64-Bit Addressing (Alpha Only)

### 11.4 OpenVMS Alpha 64-Bit API Guidelines

**64-bit routines should accept 32-bit forms of structures as well as 64-bit forms.**

To make it easy to modify calls to an API, the 32-bit form of a structure should be accepted by the interface as well as the 64-bit form.

**Example:** If the 32-bit API passed information by descriptor, the new interface should pass the same information by descriptor.

**64-bit routines should provide the same functionality as the 32-bit routines.**

An application currently calling the 32-bit API should be able to completely upgrade to calling the 64-bit API without having to preserve some of the old calls to the old 32-bit API just because the new 64-bit API is not a functional superset of the old API.

**Example:** SYS\$EXPREG\_64 works for P0, P1 and P2 process space. Callers can replace all calls to SYS\$EXPREG since SYS\$EXPREG\_64 is a functional superset of \$EXPREG.

**Use the suffix “\_64” when appropriate.**

For system services, this suffix is used for routines that accept 64-bit addresses by reference. For promoted routines, this distinguishes the 64-bit capable version from its 32-bit counterpart. For new routines, it is a visible reminder that a 64-bit wide address cell will be read/written. This is also used when a structure is passed that contains an embedded 64-bit address, if the structure is not self-identifying as a 64-bit structure. Hence, a routine name need not include “\_64” simply because it receives a 64-bit descriptor. Remember that passing an arbitrary value by reference does not mean the suffix is required, passing a 64-bit address by reference does.

This practice is recommended for other routines as well.

**Examples:**

```
SYS$EXPREG_64 (region_id_64, length_64, acmode, return_va_64, return_
length_64)
SYS$CMKRNL_64 (routine_64, quad_arglst_64)
```

#### 11.4.4 Example of a 32-Bit Routine and a 64-Bit Routine

The following example illustrates a 32-bit routine interface that has been promoted to support 64-bit addressing. It handles several of the issues addressed in the guidelines.

The C function declaration for an old system service SYS\$CRETVA looks like the following:

```
#pragma required_pointer_size save
#pragma required_pointer_size 32
int sys$cretva (
    struct _va_range * inadr,
    struct _va_range * retadr,
    unsigned int      acmode);
#pragma required_pointer_size restore
```

The C function declaration for a new system service SYS\$CRETVA\_64 looks like the following:

```
#pragma required_pointer_size save
#pragma required_pointer_size 64
int sys$cretva_64 (
    struct _generic_64 * region_id_64,
    void * start_va_64,
    unsigned __int64 length_64,
    unsigned int acmode,
    void ** return_va_64,
    unsigned __int64 * return_length_64);
#pragma required_pointer_size restore
```

The new routine interface for SYS\$CRETVA\_64 corrects the embedded pointers within the `_va_range` structure, passes the 64-bit `region_id_64` argument by reference and passes the 64-bit `length_64` argument by value.

## 11.5 OpenVMS Alpha Tools and Utilities That Support 64-Bit Addressing

This section briefly describes the following OpenVMS Alpha tools that have been enhanced to support 64-bit virtual addressing:

- OpenVMS Debugger
- System-code debugger
- XDELTA
- LIB\$ and CVT\$ Facilities of the OpenVMS Run-Time Library
- Watchpoint utility
- SDA

### 11.5.1 OpenVMS Debugger

On OpenVMS Alpha systems, the Debugger can access the extended memory made available by 64-bit addressing support. You can examine and manipulate data in the complete 64-bit address space.

You can examine a variable as a quadword by using the new option `Quad`, which is on the `Typecast` menu of both the `Monitor` pull-down menu and the `Examine` dialog box.

The default type for the debugger is **longword**, which is appropriate for debugging 32-bit applications. You should change the default type to **quadword** for debugging applications that use the 64-bit address space. To do this, use the `SET TYPE QUADWORD` command.

Note that hexadecimal addresses are now 16-digit numbers on Alpha. For example,

```
DBG> EVALUATE/ADDRESS/HEX %hex 000004A0
00000000000004A0
DBG>
```

The debugger supports 32-bit and 64-bit pointers.

For more information about using the OpenVMS Debugger, see the *OpenVMS Debugger Manual*.

## Support for 64-Bit Addressing (Alpha Only)

### 11.5 OpenVMS Alpha Tools and Utilities That Support 64-Bit Addressing

#### 11.5.2 OpenVMS Alpha System-Code Debugger

The OpenVMS Alpha system-code debugger accepts 64-bit addresses and uses full 64-bit addresses to retrieve information.

#### 11.5.3 Delta/XDelta

XDELTA has always supported 64-bit addressing on OpenVMS Alpha. Quadword display mode displays full quadwords of information. 64-bit address display mode accepts and displays all addresses as 64-bit quantities.

XDELTA has predefined command strings for displaying the contents of the PFN database. With the PFN database layout changes in OpenVMS Alpha Version 7.0, the command strings and the format of the displays have changed accordingly.

For more information about Delta/XDelta, see the *OpenVMS Delta/XDelta Debugger Manual*.

#### 11.5.4 LIB\$ and CVT\$ Facilities of the OpenVMS Run-Time Library

For more information about 64-bit addressing support for the LIB\$ and CVT\$ facilities of the OpenVMS RTL library, refer to the *OpenVMS RTL Library (LIB\$) Manual*.

#### 11.5.5 Watchpoint Utility

The Watchpoint utility is a debugging tool that maintains a history of modifications that are made to a particular location in shared system space by setting watchpoints on 64-bit addresses. It watches any system address, whether in S0, S1, or S2 space.

A \$QIO interface to the Watchpoint utility supports 64-bit addresses. The WATCHPOINT command interpreter (WP) issues \$QIO requests to the WATCHPOINT driver (WPDRIVER) from commands that follow the standard rules of DCL grammar.

Enter commands at the WATCHPOINT> prompt to set, delete, and obtain information from watchpoints. Before invoking the WATCHPOINT command interpreter (WP) or loading the WATCHPOINT driver, you must set the SYSGEN MAXBUF dynamic parameter to 64000, as follows:

```
$ RUN SYS$SYSTEM:SYSGEN
SYSGEN> SET MAXBUF 64000
SYSGEN> WRITE ACTIVE
SYSGEN> EXIT
```

Before invoking WP, you must install the WPDRIVER with SYSMAN, as follows:

```
$ RUN SYS$SYSTEM:SYSMAN
SYSMAN> IO CONNECT WPA0/DRIVER=SYS$WPDRIVER/NOADAPTER
SYSMAN> EXIT
```

You can then invoke WP with the following command:

```
$ RUN SYS$SYSTEM:WP
```

Now you can enter commands at the WATCHPOINT> prompt to set, delete, and obtain information from watchpoints.

You can best view the WP help screens as well as the output to the Watchpoint utility using a terminal set to 132 characters, as follows:

```
$ SET TERM/WIDTH=132
```

## Support for 64-Bit Addressing (Alpha Only)

### 11.5 OpenVMS Alpha Tools and Utilities That Support 64-Bit Addressing

#### 11.5.6 SDA

As of OpenVMS Alpha Version 7.0, SDA allows a user to specify 64-bit addresses and 64-bit values in expressions. It will also display full 64-bit values where appropriate.

For more information about using SDA 64-bit addressing support, see the *OpenVMS Alpha System Analysis Tools Manual*.

### 11.6 Language and Pointer Support for 64-Bit Addressing

Full support in Compaq C and the Compaq C Run-Time Library (RTL) for 64-bit addressing make C the preferred language for programming 64-bit applications, libraries, and system code for OpenVMS Alpha. The 64-bit pointers can be seamlessly integrated into existing C code, and new 64-bit applications can be developed, with natural C coding styles, that take advantage of the 64-bit address space provided by OpenVMS Alpha.

Support for all 32-bit pointer sizes (the default), all 64-bit pointer sizes, and the mixed 32-bit and 64-bit pointer size environment provide compatibility as well as flexibility for programming 64-bit OpenVMS applications in Compaq C.

The ANSI-compliant, #pragma approach for supporting the mixed 32-bit and 64-bit pointer environment is common to Tru64 UNIX. Features of 64-bit C support include memory allocation routine name mapping (transparent support for `_malloc64` and `_malloc32`) and C-type checking for 32-bit versus 64-bit pointer types.

The *OpenVMS Calling Standard* describes the techniques used by all OpenVMS languages for invoking routines and passing data between them. The standard also defines the mechanisms that ensure consistency in error and exception handling routines.

The *OpenVMS Calling Standard* has always specified 64-bit wide parameters. In releases of OpenVMS Alpha prior to Version 7.0, called routines almost always ignored the upper 32-bits of arguments. As of OpenVMS Alpha Version 7.0, the *OpenVMS Calling Standard* provides the following support for 64-bit addresses:

- Called routines can start to use complete 64-bit addresses.
- Callers can pass either 32-bit or 64-bit pointers.
- Pointers passed by reference often require a new 64-bit variant of the original routine.
- Self-identifying structures, such as those defined for descriptors and item lists, enable an existing API to be enhanced compatibly.

OpenVMS Alpha 64-bit addressing support for mixed pointers also includes the following features:

- OpenVMS Alpha 64-bit virtual address space layout that applies to all processes. (There are no special 64-bit processes or 32-bit processes.)
- 64-bit pointer support for addressing the entire 64-bit OpenVMS Alpha address space layout including P0, P1, and P2 address spaces and S0/S1, S2, and page table address spaces.
- 32-bit pointer compatibility for addressing P0, P1, and S0/S1 address spaces.
- Many new 64-bit system services that support P0, P1, and P2 space addresses.

## Support for 64-Bit Addressing (Alpha Only)

### 11.6 Language and Pointer Support for 64-Bit Addressing

- Many existing system services enhanced to support 64-bit addressing.
- 32-bit sign-extension checking for all arguments passed to 32-bit, pointer-only system services.
- C and MACRO-32 macros for handling 64-bit addresses.

### 11.7 Compaq C RTL Support for 64-Bit Addressing

This section describes the 64-bit addressing support provided by the Compaq C Run-Time Library on OpenVMS Alpha Version 7.0 systems and higher.

The Compaq C Run-Time Library includes the following features in support of 64-bit pointers:

- Guaranteed binary and source compatibility of existing programs
- No impact on applications that are not modified to exploit 64-bit support
- Enhanced memory allocation routines that allocate 64-bit memory
- Widened function parameters to accommodate 64-bit pointers
- Dual implementations of functions that need to know the pointer size used by the caller
- New information available to the Compaq C Version 5.2 compiler or higher to seamlessly call the correct implementation
- Ability to explicitly call either the 32-bit or 64-bit form of functions for applications that mix pointer sizes
- A single shareable image for use by 32-bit and 64-bit applications

#### 11.7.1 Using the Compaq C Run-Time Library

The Compaq C Run-Time Library on OpenVMS Alpha Version 7.0 systems and higher can generate and accept 64-bit pointers. Functions that require a second interface to be used with 64-bit pointers reside in the same object libraries and shareable images as their 32-bit counterparts. No new object libraries or shareable images are introduced. Using 64-bit pointers does not require changes to your link command or link options files.

The Compaq C 64-bit environment allows an application to use both 32-bit and 64-bit addresses. For more information about how to manipulate pointer sizes, see the `/POINTER_SIZE` qualifier and `#pragma pointer_size` and `#pragma required_pointer_size` preprocessor directives in the *DEC C User's Guide for OpenVMS Systems*.

The `/POINTER_SIZE` qualifier requires you to specify a value of 32 or 64. This value is used as the default pointer size within the compilation unit. As an application programmer, you can compile one set of modules using 32-bit pointers and another set using 64-bit pointers. Use care when these two separate groups of modules call each other.

Use of the `/POINTER_SIZE` qualifier also influences the processing of Compaq C RTL header files. For functions that have a 32-bit and 64-bit implementation, specifying `/POINTER_SIZE` enables function prototypes to access both functions, regardless of the actual value supplied to the qualifier. In addition, the value specified to the qualifier determines the default implementation to call during that compilation unit.



## Support for 64-Bit Addressing (Alpha Only)

### 11.7 Compaq C RTL Support for 64-Bit Addressing

You can use the `#pragma pointer_size` and `#pragma required_pointer_size` preprocessor directives to change the pointer size in effect within a compilation unit. You can default pointers to 32-bit pointers and then declare specific pointers within the module as 64-bit pointers. You would also need to specifically call the `_malloc64` form of `malloc` to obtain memory from the 64-bit memory area.

#### 11.7.2 Obtaining 64-Bit Pointers to Memory

The Compaq C RTL has many functions that return pointers to newly allocated memory. In each of these functions, the application owns the memory pointed to and is responsible for freeing that memory.

Functions that allocate memory are:

```
malloc
calloc
realloc
strdup
```

Each of these functions has a 32-bit and 64-bit implementation. When you use the `/POINTER_SIZE` qualifier, the following functions can also be called:

```
_malloc32, _malloc64
_calloc32, _calloc64
_realloc32, _realloc64
_strdup32, _strdup64
```

When you specify `/POINTER_SIZE=32`, all `malloc` calls default to `_malloc32`.

When you specify `/POINTER_SIZE=64`, all `malloc` calls default to `_malloc64`.

Regardless of whether the application calls a 32-bit or 64-bit memory allocation routine, there is still a single `free` function. This function accepts either pointer size.

Note that the memory allocation functions are the only ones that return pointers to 64-bit memory. All Compaq C RTL structure pointers returned to the calling application (such as a `FILE`, `WINDOW`, or `DIR`) are always 32-bit pointers. This allows both 32-bit and 64-bit callers to pass these structure pointers within the application.

#### 11.7.3 Compaq C Header Files

The header files distributed with Compaq C Version 5.2 and higher support 64-bit pointers. Each function prototype whose signature contains a pointer is constructed to indicate the size of the pointer accepted.

A 32-bit pointer can be passed as an argument to functions that accept either a 32-bit or 64-bit pointer for that argument.

A 64-bit pointer, however, cannot be passed as an argument to a function that accepts a 32-bit pointer. Attempts to do this are diagnosed by the compiler with a `MAYLOSEDATA` message. The diagnostic message `IMPLICITFUNC` means the compiler can do no additional pointer-size validation for calls to that function.

You might find the following pointer-size compiler diagnostics useful:

- `%CC-IMPLICITFUNC`

A function prototype was not found before using the specified function. The compiler and run-time system rely on prototype definitions to detect incorrect pointer-size usage. Failure to include the proper header files can lead to incorrect results or pointer truncation.

## Support for 64-Bit Addressing (Alpha Only)

### 11.7 Compaq C RTL Support for 64-Bit Addressing

- `%CC-MAYLOSEDATA`

A truncation is necessary to do this operation. The operation could be passing a 64-bit pointer to a function that does not support a 64-bit pointer in the given context. It could also be a function returning a 64-bit pointer to a calling application that is trying to store that return value in a 32-bit pointer.
- `%CC-MAYHIDELOSS`

This message (when enabled) helps expose real `MAYLOSEDATA` messages that are being suppressed because of a cast operation.

#### 11.7.4 Functions Affected

The Compaq C RTL shipped with OpenVMS Alpha Version 7.0 accommodates applications that use only 32-bit pointers, only 64-bit pointers, or a combination of both. To use 64-bit memory, you must, at a minimum, recompile and relink an application. The amount of source code change required depends on the application itself, calls to other run-time libraries, and the combinations of pointer sizes used.

With respect to 64-bit pointer support, the functions in the Compaq C RTL fall into four categories:

- Functions not impacted by choice of pointer size
- Functions enhanced to accept either pointer size
- Functions having a 32-bit and 64-bit implementation
- Functions that accept only 32-bit pointers

From an application developer's perspective, the first two types of functions are the easiest to use in either a single-pointer or mixed-pointer mode.

The third type requires no modifications when used in a single-pointer compilation but might require source code changes when used in a mixed-pointer mode.

The fourth type requires careful attention whenever 64-bit pointers are used.

##### 11.7.4.1 No Pointer-Size Impact

The choice of pointer-size has no impact on a function if its prototype contains no pointer-related parameters or return values. The mathematical functions are good examples of this.

Even some functions in this category that do have pointers in their prototype are not impacted by pointer size. For example, `strerror` has the prototype:

```
char * strerror (int error_number);
```

This function returns a pointer to a character string, but this string is allocated by the Compaq C RTL. As a result, to support both 32-bit and 64-bit applications, these types of pointers are guaranteed to fit in a 32-bit pointer.

##### 11.7.4.2 Functions Accepting Both Pointer Sizes

The Alpha architecture supports 64-bit pointers. The OpenVMS Alpha Calling Standard specifies that all arguments are actually passed as 64-bit values. Before OpenVMS Alpha Version 7.0, all 32-bit addresses passed to procedures were sign-extended into this 64-bit parameter. The called function declared the parameters as 32-bit addresses, which caused the compiler to generate 32-bit instructions (such as `LDL`) to manipulate these parameters.

## Support for 64-Bit Addressing (Alpha Only)

### 11.7 Compaq C RTL Support for 64-Bit Addressing

Many functions in the Compaq C RTL are enhanced to receive the full 64-bit address. For example, consider `strlen`:

```
size_t strlen (const char *string);
```

The only pointer in this function is the character-string pointer. If the caller passes a 32-bit pointer, the function works with the sign-extended 64-bit address. If the caller passes a 64-bit address, the function works with that address directly.

The Compaq C RTL continues to have only a single entry point for functions in this category. There are no source-code changes required to add any of the four pointer-size options for functions of this type. The OpenVMS documentation refers to these functions as 64-bit friendly.

#### 11.7.4.3 Functions with Two Implementations

There are many reasons why a function might need two implementations—one for 32-bit pointers, the other for 64-bit pointers. Some of these reasons include:

- The pointer size of the return value is the same size as the pointer size of one of the arguments. If the argument is 32 bits, the return value is 32 bits. If the argument is 64 bits, the return value is 64 bits.
- One of the arguments is a pointer to an object whose size is pointer-size sensitive. To know how many bytes are being pointed to, the function must know whether the code was compiled in 32-bit or 64-bit pointer-size mode.
- The function returns the address of dynamically allocated memory. The memory is allocated in 32-bit space when compiled for 32-bit pointers and in 64-bit space when compiled for 64-bit pointers.

From the application developer's point of view, there are three function prototypes for each of these functions. The `<string.h>` header file contains many functions whose return value is dependent upon the pointer size used as the first argument to the function call. For example, consider the `memset` function. The header file defines three entry points for this function:

```
void * memset (void *memory_pointer, int character, size_t size);  
void * _memset32 (void *memory_pointer, int character, size_t size);  
void * _memset64 (void *memory_pointer, int character, size_t size);
```

The first prototype is the function that your application would currently call if using this function. The compiler changes a call to `memset` into a call to either `_memset32` when compiled `/POINTER_SIZE=32`, or `_memset64` when compiled `/POINTER_SIZE=64`.

You can override this default behavior by directly calling either the 32-bit or the 64-bit form of the function. This accommodates applications using mixed pointer sizes, regardless of the default pointer size specified with the `/POINTER_SIZE` qualifier.

Note that if the application is compiled without specifying the `/POINTER_SIZE` qualifier, *neither* the 32-bit specific nor the 64-bit specific function prototypes are defined. In this case, the compiler automatically calls the 32-bit interface for all interfaces having dual implementations.

Table 11–4 shows the Compaq C RTL functions that have dual implementations in support of 64-bit pointer size. When compiling with the `/POINTER_SIZE` qualifier, calls to the unmodified function names are changed to calls to the function interface that matches the pointer size specified with the qualifier.

## Support for 64-Bit Addressing (Alpha Only)

### 11.7 Compaq C RTL Support for 64-Bit Addressing

**Table 11–4 Functions with Dual Implementations**

basename	malloc	strpbrk	wcsncat
bsearch	mbsrtowcs	strptime	wcsncpy
calloc	memccpy	strrchr	wcspbrk
catgets	memchr	strsep	wcsrchr
ctermid	memcpy	strstr	wcsrtombs
cuserid	memmove	strtod	wcsstr
dirname	memset	strtok	wcstok
fgetname	mktemp	strtol	wcstol
fgets	mmap	strtoll	wcstoul
fgetws	qsort	strtoq	wcswcs
fullname	realloc	strtoul	wmemchr
gcvt	rindex	strtoull	wmemcpy
getcap	strcat	strtouq	wmemmove
getcwd	strchr	tgetstr	wmemset
getname	strcpy	tmpnam	
gets	strdup	wscat	
index	strncat	wcschr	
longname	strncpy	wcscpy	

#### 11.7.4.4 Functions Restricted to 32-Bit Pointers

Some functions in the Compaq C RTL do not support 64-bit pointers. If you try to pass a 64-bit pointer to one of these functions, the compiler generates a %CC-W-MAYLOSEDATA warning. Applications compiled with /POINTER\_SIZE=64 might need to be modified to avoid passing 64-bit pointers to these functions.

Table 11–5 shows the functions restricted to using 32-bit pointers. The Compaq C RTL offers no 64-bit support for these functions. You must ensure that only 32-bit pointers are used with these functions.

**Table 11–5 Functions Restricted to 32-Bit Pointers**

atexit	getopt	modf	setstate
execve	iconv	recvmsg	setvbuf
execvp	initstate	sendmsg	
frexp	ioctl	setbuf	

Table 11–6 shows functions that make callbacks to user-supplied functions as part of processing that function call. The callback procedures are not passed 64-bit pointers.

**Table 11–6 Callbacks That Pass Only 32-Bit Pointers**

from_vms	to_vms
ftw	tputs

## Support for 64-Bit Addressing (Alpha Only)

### 11.7 Compaq C RTL Support for 64-Bit Addressing

#### 11.7.5 Reading Header Files

This section introduces the pointer-size manipulations used in the Compaq C RTL header files. Use the following examples to become more comfortable reading these header files and to help modify your own header files.

##### Examples

```
1. :
   :
   #if INITIAL_POINTER_SIZE ❶
   #  if (VMS_VER < 70000000) || !defined __ALPHA ❷
   #    error " Pointer size usage not permitted before OpenVMS Alpha V7.0"
   #  endif
   #  pragma __pointer_size __save ❸
   #  pragma __pointer_size 32 ❹
   #endif
   :
   :
   #if __INITIAL_POINTER_SIZE ❺
   #  pragma __pointer_size 64
   #endif
   :
   :
   #if __INITIAL_POINTER_SIZE ❻
   #  pragma __pointer_size __restore
   #endif
   :
```

All Compaq C compilers that support the `/POINTER_SIZE` qualifier predefine the macro `__INITIAL_POINTER_SIZE`. The Compaq C RTL header files take advantage of the ANSI rule that if a macro is not defined, it has an implicit value of 0.

The macro is defined as 32 or 64 when the `/POINTER_SIZE` qualifier is used. It is defined as 0 if the qualifier is not used. The statement shown as ❶ can be read as "if the user has specified either `/POINTER_SIZE=32` or `/POINTER_SIZE=64` on the command line."

Compaq C Version 5.2 and higher is supported on many OpenVMS platforms. The lines shown as ❷ generate an error message if the target of the compilation is one that does not support 64-bit pointers.

A header file cannot assume anything about the actual pointer-size context in effect at the time the header file is included. Furthermore, the Compaq C compiler offers only the `__INITIAL_POINTER_SIZE` macro and a mechanism to change the pointer size, but no way to determine the current pointer size.

All header files that have a dependency on pointer sizes are responsible for saving ❸, initializing ❹, altering ❺, and restoring ❻ the pointer-size context.

## Support for 64-Bit Addressing (Alpha Only)

### 11.7 Compaq C RTL Support for 64-Bit Addressing

```
2. :
   :
   #ifndef __CHAR_PTR32 ❶
   #   define __CHAR_PTR32 1
   #   typedef char * __char_ptr32;
   #   typedef const char * __const_char_ptr32;
   #endif
   :
   :
   #if __INITIAL_POINTER_SIZE
   #   pragma __pointer_size 64
   #endif
   :
   :
   #ifndef __CHAR_PTR64 ❷
   #   define __CHAR_PTR64 1
   #   typedef char * __char_ptr64;
   #   typedef const char * __const_char_ptr64;
   #endif
   :
```

Some function prototypes need to refer to a 32-bit pointer when in a 64-bit pointer-size context. Other function prototypes need to refer to a 64-bit pointer when in a 32-bit pointer-size context.

Compaq C binds the pointer size used in a typedef at the time the typedef is made. The typedef declaration of `__char_ptr32` ❶ is made in a 32-bit context. The typedef declaration of `__char_ptr64` ❷ is made in a 64-bit context.

```
3. :
   :
   #if __INITIAL_POINTER_SIZE
   #   if (__VMS_VER < 70000000) || !defined __ALPHA
   #       error " Pointer size usage not permitted before OpenVMS Alpha V7.0"
   #   endif
   #   pragma __pointer_size save
   #   pragma __pointer_size 32
   #endif
   :
   ❶
   :
   #if __INITIAL_POINTER_SIZE ❷
   #   pragma __pointer_size 64
   #endif
   :
   ❸
   :
   int abs (int __j); ❹
   :
   __char_ptr32 strerror (int __errno); ❺
   :
```

Before declaring function prototypes that support 64-bit pointers, the pointer context is changed ❷ from 32-bit pointers to 64-bit pointers.

Functions restricted to 32-bit pointers are placed in the 32-bit pointer context section ❶ of the header file. All other functions are placed in the 64-bit context section ❸ of the header file.

Functions that have no pointer-size impact (❹ and ❺) are located in the 64-bit section. Functions that have no pointer-size impact, except for a 32-bit address return value ❺, are also in the 64-bit section, and use the 32-bit specific typedefs previously discussed.

## Support for 64-Bit Addressing (Alpha Only)

### 11.7 Compaq C RTL Support for 64-Bit Addressing

```
4. :
   :
   #if __INITIAL_POINTER_SIZE
   # pragma __pointer_size 64
   #endif
   :
   :
   #if __INITIAL_POINTER_SIZE == 32 ❶
   # pragma __pointer_size 32
   #endif
   :
   char *strcat (char *__s1, __const_char_ptr64 __s2); ❷
   :
   #if __INITIAL_POINTER_SIZE
   # pragma __pointer_size 32
   :
   char *_strcat32 (char *__s1, __const_char_ptr64 __s2); ❸
   :
   # pragma __pointer_size 64
   :
   char *_strcat64 (char *__s1, const char *__s2); ❹
   :
   #endif
   :
```

This example shows declarations of functions that have both a 32-bit and 64-bit implementation. These declarations are located in the 64-bit section of the header file.

The normal interface to the function ❷ is declared using the pointer size specified on the `/POINTER_SIZE` qualifier. Because the header file is in 64-bit pointer context and because of the statements at ❶, the declaration at ❷ is made using the same pointer size context as the `/POINTER_SIZE` qualifier.

The 32-bit specific interface ❸ and the 64-bit specific interface ❹ are declared in 32-bit and 64-bit pointer-size context, respectively.





---

## Memory Management Services and Routines on OpenVMS Alpha

This chapter describes the use of memory management system services and run-time routines on Alpha systems. Although the operating system's memory management concepts are much the same on VAX systems and Alpha systems, details of the memory management system are different. These details may be critical to certain uses of the operating system's memory management system services and routines on an Alpha system. This chapter highlights those differences by using the Alpha icon.

This chapter contains the following sections:

Section 12.1 describes the page sizes of Alpha systems.

Section 12.2 describes the three levels of the operating system's memory allocation routines.

Section 12.3 discusses how to use system services to add virtual address space, adjust working sets, control process swapping, and create and manage sections.

Section 12.4 describes large page-file sections.

### 12.1 Virtual Page Sizes (Alpha Only)

On Alpha systems, in order to facilitate memory protection and mapping, the virtual address space is subdivided into segments of 8 KB, 16 KB, 32 KB, or 64 KB sizes called **CPU-specific pages**. On VAX systems, the page sizes are 512 bytes.

Wherever possible, the Alpha system's versions of the system services and run-time library routines that manipulate memory attempt to preserve compatibility with the VAX system's services and routines. The Alpha system's versions of the routines that accept page count values as arguments still interpret these arguments in 512-byte quantities, which are called **pagelets** to distinguish them from CPU-specific page sizes. The routines convert pagelet values into CPU-specific pages. The routines that return page count values convert from CPU-specific pages to pagelets, so that return values expected by applications are still measured in the same 512-byte units.

This difference in page size does not affect memory allocation using higher-level routines, such as run-time library routines that manipulate virtual memory zones or language-specific memory allocation routines such as the *malloc* and *free* routines in C.

To determine system page size, you make a call to the SYS\$GETSYI system service, specifying the SYI\$\_PAGE\_SIZE item code. See the description of SYS\$GETSYI and SYI\$\_PAGE\_SIZE in the *OpenVMS System Services Reference Manual* for details.

## 12.2 Levels of Memory Allocation Routines

Sophisticated software systems must often create and manage complex data structures. In these systems, the size and number of elements are not always known in advance. You can tailor the memory allocation for these elements by using **dynamic memory allocation**. By managing the memory allocation, you can avoid allocating fixed tables that may be too large or too small for your program. Managing memory directly can improve program efficiency. By allowing you to allocate specific amounts of memory, the operating system provides a hierarchy of routines and services for memory management. Memory allocation and deallocation routines allow you to allocate and free storage within the virtual address space available to your process.

There are three levels of memory allocation routines:

1. Memory management system services

The memory management system services comprise the lowest level of memory allocation routines. These services include, but are not limited to, the following:

- SYS\$EXPREG (Expand Region)
- SYS\$CRETVA (Create Virtual Address Space)
- SYS\$DELTVA (Delete Virtual Address Space)
- SYS\$CRMPSC (Create and Map Section)
- SYS\$MGBLSC (Map Global Section)
- SYS\$DGBLSC (Delete Global Section)

For most cases in which a system service is used for memory allocation, the Expand Region (SYS\$EXPREG) system service is used to create pages of virtual memory.

Because system services provide more control over allocation procedures than RTL routines, you must manage the allocation precisely. System services provide extensive control over address space allocation by allowing you to do the following types of tasks:

- Add or delete virtual address space to the process's program region (P0) or control region (P1)
- Add or delete virtual address space at a specific range of addresses
- Increase or decrease the number of pages in a program's working set
- Lock or delete pages of a program's working set in memory
- Lock the entire program's working set in memory (by disabling process swapping)
- Define disk files containing data or shareable images and map the files into the virtual address space of a process

2. RTL page management routines

The RTL routines exist for creating, deleting, and accessing information about virtual address space. You can either allocate a specified number of contiguous pages or create a zone of virtual address space. A **zone** is a logical unit of the memory pool or subheap that you can control as an independent area. It can be any size required by your program. Refer to Chapter 14 for more information about zones.

## Memory Management Services and Routines on OpenVMS Alpha

### 12.2 Levels of Memory Allocation Routines

The RTL page management routines LIB\$GET\_VM\_PAGE and LIB\$FREE\_VM\_PAGE provide a convenient mechanism for allocating and freeing pages of memory.

These routines maintain a processwide pool of free pages. If unallocated pages are not available when LIB\$GET\_VM\_PAGE is called, it calls SYS\$EXPREG to create the required pages in the program region (P0 space).

#### 3. RTL heap management routines

The RTL heap management routines LIB\$GET\_VM and LIB\$FREE\_VM provide a mechanism for allocating and freeing blocks of memory of arbitrary size.

The following are heap management routines based on the concept of zones:

```
LIB$CREATE_VM_ZONE  
LIB$CREATE_USER_VM_ZONE  
LIB$DELETE_VM_ZONE  
LIB$FIND_VM_ZONE  
LIB$RESET_VM_ZONE  
LIB$SHOW_VM_ZONE  
LIB$VERIFY_VM_ZONE
```

If an unallocated block is not available to satisfy a call to LIB\$GET\_VM, LIB\$GET\_VM calls LIB\$GET\_VM\_PAGE to allocate additional pages.

Modular application programs can call routines in any or all levels of the hierarchy, depending on the kinds of services the application program needs. You must observe the following basic rule when using multiple levels of the hierarchy:

Memory that is allocated by an allocation routine at one level of the hierarchy must be freed by calling a deallocation routine at the same level of the hierarchy. For example, if you allocated a page of memory by calling LIB\$GET\_VM\_PAGE, you can free it only by calling LIB\$FREE\_VM\_PAGE.

Figure 12–1 shows the three levels of memory allocation routines.

## Memory Management Services and Routines on OpenVMS Alpha

### 12.2 Levels of Memory Allocation Routines

Figure 12–1 Hierarchy of Alpha Memory Management Routines

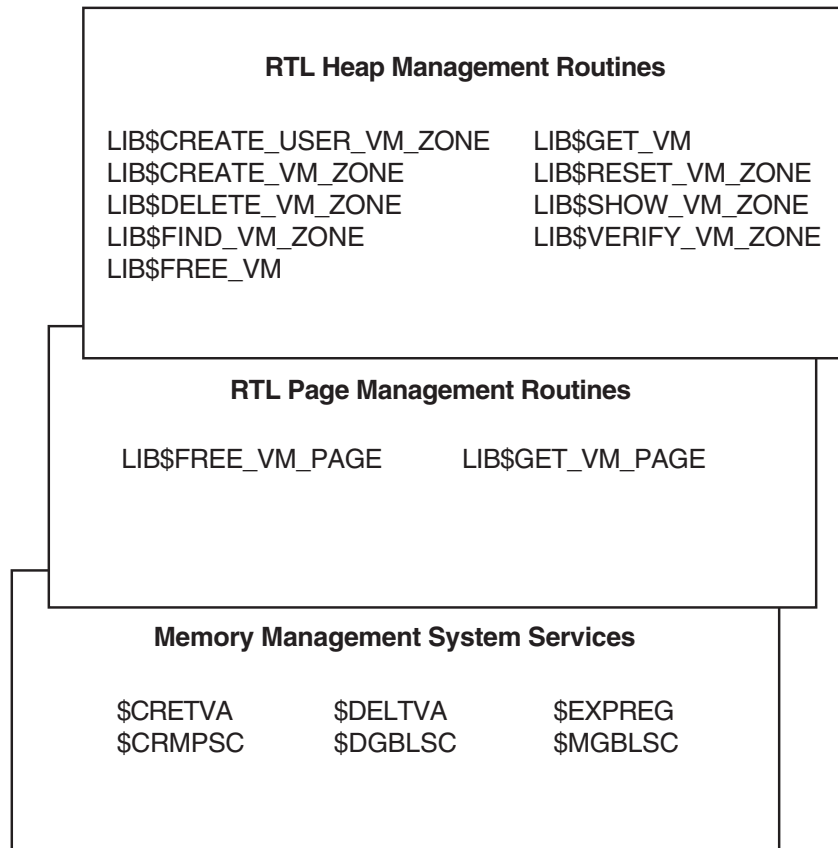

ZK-4146-GE

For information about using memory management RTLs, see Chapter 14.

## 12.3 Using System Services for Memory Allocation

This section describes how to use system services to perform the following tasks:

- Increase and decrease virtual address space
- Input and return address arrays
- Control page ownership and protection
- Control working set paging
- Control process swapping

### 12.3.1 Increasing and Decreasing Virtual Address Space

The system services allow you to add address space anywhere within the process's program region (P0) or control region (P1). To add address space at the end of P0 or P1, use the Expand Program/Control Region (SYS\$EXPREG) system service. SYS\$EXPREG optionally returns the range of virtual addresses for the new pages. To add address space in other portions of P0 or P1, use SYS\$CRETVA.

The format for SYS\$EXPREG is as follows:

```
SYS$EXPREG (pagcnt [,retadr] [,acmode] [,region])
```

## Memory Management Services and Routines on OpenVMS Alpha

### 12.3 Using System Services for Memory Allocation

#### Specifying the Number of Pages

On Alpha systems, use the **pagcnt** argument to specify the number of pagelets to add to the end of the region. The Alpha system rounds the specified pagelet value to the next integral number of Alpha pages for the system where it is executing. To check the exact boundaries of the memory allocated by the system, specify the optional **retadr** argument. The **retadr** argument contains the start address and the end address of the memory allocated by the system service.

#### Specifying the Access Mode

Use the **acmode** argument to specify the access to be assigned to the newly created pages.

#### Specifying the Region

Use the **region** argument to specify whether to add the pages to the end of the P0 or P1 region.

To deallocate pages allocated with SYS\$EXPREG and SYS\$CRETVA, use SYS\$DELTVA.

For Alpha systems, the following example illustrates the addition of 4 pagelets to the program region of a process by writing a call to the SYS\$EXPREG system service.

```
#include <stdio.h>
#include <ssdef.h>

main() {
    unsigned int status, retadr[2], pagcnt=4, region=0;
    /* Add 4 pages to P0 space */
    status = SYS$EXPREG( pagcnt, &retadr, 0, region);
    if (( status & 1) != 1)
        LIB$SIGNAL( status );
    else
        printf("Starting address: %d Ending address: %d\n",
            retadr[0], retadr[1]);
}
```

The value 0 is passed in the **region** argument to specify that the pages are to be added to the program region. To add the same number of pages to the control region, you would specify REGION=1.

Note that the **region** argument to the SYS\$EXPREG service is optional; if it is not specified, the pages are added to or deleted from the program region by default.

On Alpha systems, the SYS\$EXPREG service can add pagelets only in the direction of the growth of a particular region. When you need to add pages to the middle of these regions, you can use the Create Virtual Address Space (SYS\$CRETVA) system service. Likewise, when you need to delete pages created by either SYS\$EXPREG or SYS\$CRETVA, you can use the Delete Virtual Address Space (SYS\$DELTVA) system service. For example, if you have used the SYS\$EXPREG service twice to add pages to the program region and want to delete the first range of pages but not the second, you could use the SYS\$DELTVA system service, as shown in the following example:

## Memory Management Services and Routines on OpenVMS Alpha

### 12.3 Using System Services for Memory Allocation

```
#include <stdio.h>
#include <ssdef.h>

struct {
    unsigned int lower, upper;
}retadr1, retadr2, retadr3;

main() {
    unsigned int status, pagcnt=4, region=0;

    /* Add 4 pages to P0 space */
    status = SYS$EXPREG( pagcnt, &retadr1, 0, region);
    if (( status & 1) != 1)
        LIB$SIGNAL( status );
    else
        printf("Starting address: %d ending address: %d\n",
            retadr1.lower,retadr1.upper);

    /* Add 3 more pages to P0 space */

    pagcnt = 3;
    status = SYS$EXPREG( pagcnt, &retadr2, 0, region);
    if (( status & 1) != 1)
        LIB$SIGNAL( status );
    else
        printf("Starting address: %d ending address: %d\n",
            retadr2.lower,retadr2.upper);

    /* Delete original allocation */
    status = SYS$DELTVA( &retadr1, &retadr3, 0 );
    if (( status & 1) != 1)
        LIB$SIGNAL( status );
    else
        printf("Starting address: %d ending address: %d\n",
            retadr1.lower,retadr1.upper);

}
```

In this example, the first call to `SYS$EXPREG` rounds up the requested pagelet count to an integral number of CPU-specific pages and adds that number of pages to the program region; the virtual addresses of the created pages are returned in the 2-longword array at `retadr1`. The second request converts the pagelet count to pages, adds them to the program region, and returns the addresses at `retadr2`. The call to `SYS$DELTVA` deletes the area created by the first `SYS$EXPREG` call.

# Memory Management Services and Routines on OpenVMS Alpha

## 12.3 Using System Services for Memory Allocation

---

### Caution

---

Be aware that using SYS\$CRETVA presents some risk because it can delete pages that already exist if those pages are not owned by a more privileged access mode. Further, if those pages are deleted, notification is not sent. Therefore, unless you have complete control over an entire system, use SYS\$EXPREG or the RTL routines to allocate address space.

---

Section 12.3.3 mentions some other possible risks in using SYS\$CRETVA for allocating memory.

### 12.3.2 Input Address Arrays and Return Address Arrays

When the SYS\$EXPREG system service adds pages to a region, it adds them in the normal direction of growth for the region. The return address array, if requested, indicates the order in which the pages were added. For example:

- If the program region is expanded, the starting virtual address is smaller than the ending virtual address.
- If the control region is expanded, the starting virtual address is larger than the ending virtual address.

The addresses returned indicate the first byte in the first page that was added or deleted and the last byte in the last page that was added or deleted, respectively.

When input address arrays are specified for the Create and Delete Virtual Address Space (SYS\$CRETVA and SYS\$DELTVA, respectively) system services, these services add or delete pages beginning with the address specified in the first longword and ending with the address specified in the second longword.

On Alpha systems, the order in which the pages are added or deleted does not have to be in the normal direction of growth for the region. Moreover, because these services add or delete only whole pages, they ignore the low-order bits of the specified virtual address (the low-order bits contain the byte offset within the page). Table 12–1 shows the page size and byte offset.

**Table 12–1 Page and Byte Offset Within Pages on Alpha Systems**

Page Size (Bytes)	Byte Within Page (Bits)
8K	13
16K	14
32K	15
64K	16

Table 12–2 shows some sample virtual addresses in hexadecimal that may be specified as input to SYS\$CRETVA or SYS\$DELTVA and shows the return address arrays if all pages are successfully added or deleted. Table 12–2 assumes a page size of 8 KB = 2000 hex.

## Memory Management Services and Routines on OpenVMS Alpha

### 12.3 Using System Services for Memory Allocation

**Table 12–2 Sample Virtual Address Arrays on Alpha Systems**

Input Array			Output Array		Number of Pages
Start	End	Region	Start	End	
1010	1670	P0	0	1FFF	1
2450	2451	P0	2000	3FFF	1
4200	A500	P0	4000	BFFF	5
9450	9450	P0	8000	9FFF	1
7FFEC010	7FFEC010	P1	7FFEDFFF	7FFEC000	1
7FFEC010	7FFEBCA0	P1	7FFEDFFF	7FFEA000	2

For SYS\$CRETVA and SYS\$DELTVA, note that if the input virtual addresses are the same, as in the fourth and fifth items in Table 12–2, a single page is added or deleted. The return address array indicates that the page was added or deleted in the normal direction of growth for the region.

Note that for SYS\$CRMPSC and SYS\$MGBLSC, which are discussed in Section 12.3.7, the sample virtual address arrays in Table 12–2 do not apply. The reason is that the lower address value has to be an even multiple of the machine page size; that is, it must be rounded down to an even multiple page size. In addition, the higher address value must be one less than the even multiple page size, representing the last byte on the last page. That is, it must be rounded up to an even multiple page size, minus 1.

The procedure for determining start and end virtual addresses is as follows:

1. Obtain the page size in bytes.
2. Subtract 1 to obtain the byte-with-page mask.
3. Mask the low bits of lower virtual address, which is a round-down operation to round it to the next lower page boundary.
4. Perform a logical OR operation on the higher virtual address, which is a round-up operation to round it to the highest address in the last page.

#### 12.3.3 Allocating Memory in Existing Virtual Address Space on Alpha Systems (Alpha Only)

On Alpha systems, if you reallocate memory that is already in its virtual address space by using the SYS\$CRETVA system service, you may need to modify the values of the following arguments to SYS\$CRETVA:

- If your application explicitly rounds the lower address specified in the **inadr** argument to be a multiple of 512 in order to align on a page boundary, you need to modify the address. The Alpha system's version of the SYS\$CRETVA system service rounds down the start address to a CPU-specific page boundary, which will vary with different implementations. It also rounds up the end address to the last byte in a CPU-specific page boundary.
- The size of the reallocation, specified by the address range in the **inadr** argument, may be larger on an Alpha system than on a VAX system because the request is rounded up to CPU-specific pages. This can cause the unintended destruction of neighboring data, which may also occur with



## Memory Management Services and Routines on OpenVMS Alpha

### 12.3 Using System Services for Memory Allocation

single-page allocations. (When the start address and the end address specified in the **inadr** argument match, a single page is allocated.)

To determine whether you must modify the address as specified in **inadr**, specify the optional **retadr** argument to determine the exact boundaries of the memory allocated by the call to SYS\$CRETVA.

#### 12.3.4 Page Ownership and Protection

Each page in the virtual address space of a process is owned by the access mode that created the page. For example, pages in the program region that initially provided for the execution of an image are owned by user mode. Pages that the image creates dynamically are also owned by user mode. Pages in the control region, except for the pages containing the user stack, are normally owned by more privileged access modes.

Only the owner access mode or a more privileged access mode can delete the page or otherwise affect it. The owner of a page can also indicate, by means of a protection code, the type of access that each access mode will be allowed.

The Set Protection on Pages (SYS\$SETPRT) system service changes the protection assigned to a page or group of pages. The protection is expressed as a code that indicates the specific type of access (none, read-only, read/write) for each of the four access modes (kernel, executive, supervisor, user). Only the owner access mode or a more privileged access mode can change the protection for a page.

When an image attempts to access a page that is protected against the access attempted, a hardware exception called an **access violation** occurs. When an image calls a memory management system service, the service probes the pages to be used to determine whether an access violation would occur if the image attempts to read or write one of the pages. If an access violation occurs, the service exits with the status code SS\$\_ACCVIO.

Because the memory management services add, delete, or modify a single page at a time, one or more pages can be successfully changed before an access violation is detected. If the **retadr** argument is specified in the service call, the service returns the addresses of pages changed (added, deleted, or modified) before the error. If no pages are affected, that is, if an access violation occurs on the first page specified, the service returns a -1 in both longwords of the return address array.

If the **retadr** argument is not specified, no information is returned.

#### 12.3.5 Working Set Paging (Alpha Only)

On Alpha systems, when a process is executing an image, a subset of its pages resides in physical memory; these pages are called the **working set** of the process. The working set includes pages in both the program region and the control region. The initial size of a process's working set is defined by the process's working set default (WSDEFAULT) quota, which is specified in pagelets. When ample physical memory is available, a process's working-set upper growth limit can be expanded to its working set extent (WSEXTENT).

When the image refers to a page that is not in memory, a page fault occurs, and the page is brought into memory, possibly replacing an existing page in the working set. If the page that is going to be replaced is modified during the execution of the image, that page is written into a paging file on disk. When this page is needed again, it is brought back into memory, again replacing a current

## Memory Management Services and Routines on OpenVMS Alpha

### 12.3 Using System Services for Memory Allocation

page from the working set. This exchange of pages between physical memory and secondary storage is called **paging**.

The paging of a process's working set is transparent to the process. However, if a program is very large or if pages in the program image that are used often are being paged in and out frequently, the overhead required for paging may decrease the program's efficiency. The SYS\$ADJWSL, SYS\$PURGWS, and SYS\$LKWSET system services allow a process, within limits, to counteract these potential problems.

#### **SYS\$ADJWSL System Service**

The Adjust Working Set Limit (SYS\$ADJWSL) system service increases or decreases the maximum number of pages that a process can have in its working set. The format for this routine is as follows:

```
SYS$ADJWSL ([pagcnt],[wsetlm])
```

On Alpha systems, use the **pagcnt** argument to specify the number of pagelets to add or subtract from the current working set size. The Alpha system rounds the specified number of pagelets to a multiple of the system's page size. The new working set size is returned in **wsetlm** in units of pagelets.

#### **SYS\$PURGWS System Service**

The Purge Working Set (SYS\$PURGWS) system service removes one or more pages from the working set.

#### **SYS\$LKWSET System Service**

The Lock Pages in Working Set (SYS\$LKWSET) system service makes one or more pages in the working set ineligible for paging by locking them in the working set. Once locked into the working set, those pages remain in the working set until they are unlocked explicitly with the Unlock Pages in Working Set (SYS\$ULWSET) system service, or program execution ends. The format is as follows:

```
SYS$LKWSET (inadr ,[retadr] ,[acmode])
```

**Specifying a Range of Addresses** On Alpha systems, use the **inadr** argument to specify the range of addresses to be locked. SYS\$LKWSET rounds the addresses to CPU-specific page boundaries, if necessary. The range of addresses of the pages actually locked are returned in the **retadr** argument.

However, because the Alpha system's instructions cannot contain full virtual addresses, the Alpha system's images must reference procedures and data indirectly through a pointer to a procedure descriptor. The procedure descriptor contains information about the procedure, including the actual code address. These pointers to procedure descriptors and data are collected into a program section called a **linkage section**. Therefore, it is not sufficient simply to lock a section of code into memory to improve performance. You must also lock the associated linkage section into the working set.

To lock the linkage section into memory, you must determine the start and end addresses that encompass the linkage section and pass these addresses as values in the **inadr** argument to a call to SYS\$LKWSET. For more information about linking, see *Migrating to an OpenVMS AXP System: Recompiling and Relinking Applications*. Note that this manual has been archived but is available on the OpenVMS Documentation CD-ROM.

**Specifying the Access Mode** Use the **acmode** argument to specify the access mode to be associated with the pages you want locked.

## Memory Management Services and Routines on OpenVMS Alpha

### 12.3 Using System Services for Memory Allocation

#### 12.3.6 Process Swapping

The operating system balances the needs of all the processes currently executing, providing each with the system resources it requires on an as-needed basis. The memory management routines balance the memory requirements of the process. Thus, the sum of the working sets for all processes currently in physical memory is called the **balance set**.

When a process whose working set is in memory becomes inactive—for example, to wait for an I/O request or to hibernate—the entire working set or part of it may be removed from memory to provide space for another process's working set to be brought in for execution. This removal from memory is called **swapping**.

The working set may be removed in two ways:

- Partially—Also called **swapper trimming**. Pages are removed from the working set of the target process so that the number of pages in the working set is fewer, but the working set is not swapped.
- Entirely—Called swapping. All pages are swapped out of memory.

When a process is swapped out of the balance set, all the pages (both modified and unmodified) of its working set are swapped, including any pages that had been locked in the working set.

A privileged process may lock itself in the balance set. While pages can still be paged in and out of the working set, the process remains in memory even when it is inactive. To lock itself in the balance set, the process issues the Set Process Swap Mode (SYS\$SETSWM) system service, as follows:

```
$SETSWM_S SWPFLG=#1
```

This call to SYS\$SETSWM disables process swap mode. You can also disable swap mode by setting the appropriate bit in the STSFLG argument to the Create Process (SYS\$CREPRC) system service; however, you need the PSWAPM privilege to alter process swap mode.

A process can also lock particular pages in memory with the Lock Pages in Memory (SYS\$LCKPAG) system service. These pages are forced into the process's working set if they are not already there. When pages are locked in memory with this service, the pages remain in memory even when the remainder of the process's working set is swapped out of the balance set. These remaining pages stay in memory until they are unlocked with SYS\$ULKPAG. The SYS\$LCKPAG system service can be useful in special circumstances, for example, for routines that perform I/O operations to devices without using the operating system's I/O system.

You need the PSWAPM privilege to issue the SYS\$LCKPAG or SYS\$ULKPAG system service.

#### 12.3.7 Sections

A **section** is a disk file or a portion of a disk file containing data or instructions that can be brought into memory and made available to a process for manipulation and execution. A section can also be one or more consecutive page frames in physical memory or I/O space; such sections, which require you to specify page frame number (PFN) mapping, are discussed in Chapter 13, Section 13.5.6.15.

## Memory Management Services and Routines on OpenVMS Alpha

### 12.3 Using System Services for Memory Allocation

Sections are either private or global (shared).

- **Private sections** are accessible only by the process that creates them. A process can define a disk data file as a section, map it into its virtual address space, and manipulate it.
- **Global sections** can be shared by more than one process. One copy of the global section resides in physical memory, and each process sharing it refers to the same copy, except for copy-on-reference sections. For a copy-on-reference section, each process refers to the same global section, but each process gets its own copy of each page upon reference. A global section can contain shareable code or data that can be read, or read and written, by more than one process. Global sections are either temporary or permanent and can be defined for use within a group or on a systemwide basis. Global sections can be mapped to a disk file or created as a global page-file section, or they can be a PFN mapped section.

When modified pages in writable disk file sections are paged out of memory during image execution, they are written back into the section file rather than into the paging file, as is the normal case with files. (However, copy-on-reference sections are not written back into the section file.)

The use of disk file sections involves these two distinct operations:

1. The creation of a section defines a disk file as a section and informs the system what portions of the file contain the section.
2. The mapping of a section makes it available to a process and establishes the correspondence between virtual blocks in the file and specific addresses in the virtual address space of a process.

The Create and Map Section (SYS\$CRMPSC) system service creates and maps a private section or a global section. Because a private section is used only by a single process, creation and mapping are simultaneous operations. In the case of a global section, one process can create a permanent global section and not map to it; other processes can map to it. A process can also create and map a global section in one operation.

The following sections describe the creation, mapping, and use of disk file sections. In each case, operations and requirements that are common to both private sections and global sections are described first, followed by additional notes and requirements for the use of global sections. Section 12.3.7.9 discusses global page-file sections.

#### 12.3.7.1 Creating Sections

To create a disk file section, you must follow these steps:

1. Open or create the disk file containing the section.
2. Define which virtual blocks in the file comprise the section.
3. Define the characteristics of the section.

## Memory Management Services and Routines on OpenVMS Alpha

### 12.3 Using System Services for Memory Allocation

#### 12.3.7.2 Opening the Disk File

Before you can use a file as a section, you must open it using OpenVMS RMS. The following example shows the OpenVMS RMS file access block (\$FAB) and \$OPEN macros used to open the file and the channel specification to the SYS\$CRMPSC system service necessary for reading an existing file:

```
SECFAB: $FAB    FNM=<SECTION.TST>, ; File access block
              FOP=UFO
              RTV= -1
.
.
.
$OPEN  FAB=SECFAB
$CRMPSC_S -
      _CHAN=SECFAB+FAB$L_STV,...
```

The file options parameter (FOP) indicates that the file is to be opened for user I/O; this option is required so that OpenVMS RMS assigns the channel using the access mode of the caller. OpenVMS RMS returns the channel number on which the file is accessed; this channel number is specified as input to the SYS\$CRMPSC system service (**chan** argument). The same channel number can be used for multiple create and map section operations.

The option RTV=-1 tells the file system to keep all of the pointers to be mapped in memory at all times. If this option is omitted, the SYS\$CRMPSC service requests the file system to expand the pointer areas if necessary. Storage for these pointers is charged to the BYTLM quota, which means that opening a badly fragmented file can fail with an EXBYTLM failure status. Too many fragmented sections may cause the byte limit to be exceeded.

The file may be a new file that is to be created while it is in use as a section. In this case, use the \$CREATE macro to open the file. If you are creating a new file, the file access block (FAB) for the file must specify an allocation quantity (ALQ parameter).

You can also use SYS\$CREATE to open an existing file; if the file does not exist, it is created. The following example shows the required fields in the FAB for the conditional creation of a file:

```
GBLFAB: $FAB    FNM=<GLOBAL.TST>, -
              ALQ=4, -
              FAC=PUT,-
              FOP=<UFO,CIF,CBT>, -
              SHR=<PUT,UPI>
.
.
.
$CREATE FAB=GBLFAB
```

When the \$CREATE macro is invoked, it creates the file GLOBAL.TST if the file does not currently exist. The CBT (contiguous best try) option requests that, if possible, the file be contiguous. Although section files are not required to be contiguous, better performance can result if they are.

## Memory Management Services and Routines on OpenVMS Alpha

### 12.3 Using System Services for Memory Allocation

#### 12.3.7.3 Defining the Section Extents

After the file is opened successfully, the SYS\$CRMPSC system service can create a section from the entire file or from only certain portions of it. The following arguments to SYS\$CRMPSC define the extents of the file that comprise the section:

- **pagcnt** (page count). On Alpha systems, this argument is optional. It indicates the size of the space that will be mapped. The **pagcnt** argument is in units of page frames (PFNs) for a PFN-mapped section and in units of pagelets (512-byte blocks) for disk-backed sections, including page file sections.

If **pagcnt** is not supplied, then the section size defaults either to the file size for a section being created and not mapped or to the minimum of the file size and the size specified by **inadr** for a section being created and mapped simultaneously. You can map only what you have access to. Once a starting point is established, you can map **pagcnt** more space as long as you do not exceed the total size of the item you are mapping, such as the remaining blocks of a file or the remaining space in a global section.

- **vbn** (virtual block number). This argument is optional. It defines the number of the virtual block in the file that is the beginning of the section. If you do not specify this argument, the value 1 is passed (the first virtual block in the file is the beginning of the section). If you have specified physical page frame number (PFN) mapping, the **vbn** argument specifies the starting PFN.

#### 12.3.7.4 Defining the Section Characteristics

The **flags** argument to the SYS\$CRMPSC system service defines the following section characteristics:

- Whether it is a private section or a global section. The default is to create a private section.
- How the pages of the section are to be treated when they are copied into physical memory or when a process refers to them. The pages in a section can be either or both of the following:
  - Read/write or read-only
  - Created as demand-zero pages or as copy-on-reference pages, depending on how the processes are going to use the section and whether the file contains any data (see Section 12.3.7.12)
- Whether the section is to be mapped to a disk file or to specific physical page frames (see Section 12.3.7.18).

Table 12–3 shows the flag bits that must be set for specific characteristics on Alpha systems.

## Memory Management Services and Routines on OpenVMS Alpha

### 12.3 Using System Services for Memory Allocation

**Table 12–3 Flag Bits to Set for Specific Section Characteristics on Alpha Systems**

Correct Flag Combinations	Section to Be Created			
	Private	Global	PFN Private	PFN Global
SEC\$M_GBL	0	1	0	1
SEC\$M_CRF	Optional	Optional	0	0
SEC\$M_DZRO	Optional	Optional	0	0
SEC\$M_WRT	Optional	Optional	Optional	Optional
SEC\$M_PERM	Not used	Optional	Not used	1
SEC\$M_SYSGBL	Not used	Optional	Not used	Optional
SEC\$M_PFNMAP	0	0	1	1
SEC\$M_EXPREG	Optional	Optional	Optional	Optional
SEC\$M_PAGFIL	0	Optional	0	0

When you specify section characteristics, the following restrictions apply:

- Global sections cannot be both demand-zero and copy-on-reference.
- Demand-zero sections must be writable.

#### 12.3.7.5 Defining Global Section Characteristics

If the section is a global section, you must assign a character string name (**gsdnam** argument) to it so that other processes can identify it when they map it. The format of this character string name is explained in Section 12.3.7.6.

The **flags** argument specifies the following types of global section:

- Group temporary (the default)
- Group permanent
- System temporary
- System permanent

Group global sections can be shared only by processes executing with the same group number. The name of a group global section is implicitly qualified by the group number of the process that created it. When other processes map it, their group numbers must match.

A temporary global section is automatically deleted when no processes are mapped to it, but a permanent global section remains in existence even when no processes are mapped to it. A permanent global section must be explicitly marked for deletion with the Delete Global Section (SYS\$DGBLSC) system service.

You need the user privileges PRMGBL and SYSGBL to create permanent group global sections or system global sections (temporary or permanent), respectively.

A system global section is available to all processes in the system.

Optionally, a process creating a global section can specify a protection mask (**prot** argument) to restrict all access or a type of access (read, write, execute, delete) to other processes.

## Memory Management Services and Routines on OpenVMS Alpha

### 12.3 Using System Services for Memory Allocation

#### 12.3.7.6 Global Section Name

The **gsdnam** argument specifies a descriptor that points to a character string.

Translation of the **gsdnam** argument proceeds in the following manner:

1. The current name string is prefixed with GBL\$ and the result is subject to logical name translation.
2. If the result is a logical name, step 1 is repeated until translation does not succeed or until the number of translations performed exceeds the number specified by the system parameter LNM\$C\_MAXDEPTH.
3. The GBL\$ prefix is stripped from the current name string that could not be translated. This current string is the global section name.

For example, assume that you have made the following logical name assignment:

```
$ DEFINE GBL$GSDATA GSDATA_001
```

Your program contains the following statements:

```
#include <descrip.h>
.
.
.
  $DESCRIPTOR(gsdnam, "GSDATA");
.
.
.
  status = sys$crmpsc(&gsdnam, . . . );
```

The following logical name translation takes place:

1. GBL\$ is prefixed to GSDATA.
2. GBL\$GSDATA is translated to GSDATA\_001. (Further translation is not successful. When logical name translation fails, the string is passed to the service.)

There are three exceptions to the logical name translation method discussed in this section:

- If the name string starts with an underscore (\_), the operating system strips the underscore and considers the resultant string to be the actual name (that is, further translation is not performed).
- If the name string is the result of a logical name translation, then the name string is checked to see if it has the **terminal** attribute. If the name string is marked with the **terminal** attribute, the operating system considers the resultant string to be the actual name (that is, further translation is not performed).
- If the global section has a name in the format *name\_nnn*, the operating system first strips the underscore and the digits (*nnn*), then translates the resultant name according to the sequence discussed in this section, and finally reappends the underscore and digits. The system uses this method in conjunction with known images and shared files installed by the system manager.



## Memory Management Services and Routines on OpenVMS Alpha

### 12.3 Using System Services for Memory Allocation

#### 12.3.7.7 Mapping Sections

When you call the SYS\$CRMPSC system service to create or map a section, or both, you must provide the service with a range of virtual addresses (**inadr** argument) into which the section is to be mapped.

On Alpha systems, the **inadr** argument specifies the size and location of the section by its start and end addresses. SYS\$CRMPSC interprets the **inadr** argument in the following ways:

- If both addresses specified in the **inadr** argument are the same and the SEC\$M\_EXPREG bit is set in the **flags** argument, SYS\$CRMPSC allocates the memory in whichever program region the addresses fall but does not use the specified location.
- If both addresses are different, SYS\$CRMPSC maps the section into memory using the boundaries specified.

On Alpha systems, if you know specifically which pages the section should be mapped into, you provide these addresses in a 2-longword array. For example, to map a private section of 10 pages into virtual pages 10 through 19 of the program region, specify the input address array as follows:

```
unsigned int maprange[1]; /* Assume page size = 8 KB */
maprange[0] = 0x14000;    /* Address (hex) of page 10 */
maprange[1] = 0x27FFF;    /* Address (hex) of page 19 */
```

On Alpha systems, the **inadr** argument range must have a lower address on an even page boundary and a higher address exactly one less than a page boundary. You do this to avoid programming errors that might arise because of incorrect programming assumptions about page sizes. For example, the range can be expressed as the following on an 8 KB page system:

```
0 ----> 1FFF
2000 ----> 7FFF
or
inadr[0] = first byte in range
inadr[1] = last byte in range
```

If the range is not expressed in terms of page-inclusive boundaries, then an SS\$\_INVARG condition value is returned.

You do not need to know the explicit addresses to provide an input address range. If you want the section mapped into the first available virtual address range in the program region (P0) or control region (P1), you can specify the SEC\$M\_EXPREG flag bit in the **flags** argument. In this case, the addresses specified by the **inadr** argument control whether the service finds the first available space in the P0 or P1. The value specified or defaulted for the **pagent** argument determines the amount of space mapped.

On Alpha systems, the **relpag** argument specifies the location in the section file at which you want mapping to begin.

On Alpha systems, the SYS\$CRMPSC and SYS\$MGBLSC system services map a minimum of one CPU-specific page. If the section file does not fill a single page, the remainder of the page is filled with zeros after faulting the page into memory. The extra space on the page should not be used by your application because only the data that fits into the section file will be written back to the disk.

## Memory Management Services and Routines on OpenVMS Alpha

### 12.3 Using System Services for Memory Allocation

The following example shows part of a program used to map a section at the current end of the program region:

```
    unsigned int status, inadr[1], retadr[1], flags;
/*
   This range used merely to indicate P0 space since SEC$M_EXPREG
   is specified
*/
    inadr[0]= 0x200; /* Any program (P0) region address */
    inadr[1]= 0x200; /* Any P0 address (can be same) */
    .
    .
    .
/* Address range returned in retadr */
    flags = SEC$M_EXPREG;
    status = sys$crmpsc(&inadr, &retadr, flags, ... );
```

The addresses specified do not have to be currently in the virtual address space of the process. The SYS\$CRMPSC system service creates the required virtual address space during the mapping of the section. If you specify the **retadr** argument, the service returns the range of addresses actually mapped.

On Alpha systems, the starting **retadr** address should match **inadr**, plus **relpag** if specified. The ending (higher) address will be limited by the lower of:

- The value of the **pagcnt** argument
- The actual remaining block count in the file starting with specified starting **vbn**, or **relpag**
- The bound dictated by the **inadr** argument

After a section is mapped successfully, the image can refer to the pages using one of the following:

- A base register or pointer and predefined symbolic offset names
- Labels defining offsets of an absolute program section or structure

The following example shows part of a program used to create and map a process section on Alpha systems:

```
SECFAB: $FAB      FNM=<SECTION.TST>, -
                FOP=UFO, -
                FAC=PUT, -
                SHR=<GET,PUT,UPI>

;
MAPRANGE:
    .LONG      ^X14000                ; First 8 KB page
    .LONG      ^X27FFF                ; Last page
RETRANGE:
    .BLKL      1                      ; First page mapped
ENDRANGE:
    .BLKL      1                      ; Last page mapped
    .
    .
    $OPEN      FAB=SECFAB              ; Open section file
    BLBS       R0,10$
    BSBW       ERROR
```

## Memory Management Services and Routines on OpenVMS Alpha

### 12.3 Using System Services for Memory Allocation

```
10$:   $CRMPSC _S -
        INADR=MAPRANGE,-           ; Input address array
        RETADR=RETRANGE,-         ; Output array
        PAGCNT=#4,-               ; Map four pagelets
        FLAGS=#SEC$M WRT,-        ; Read/write section
        CHAN=SECFAB+FAB$L_STV     ; Channel number
        BLBS   R0,20$
        BSBW   ERROR
20$:   MOVL   RETRANGE,R6           ; Point to start of section
```

#### Notes on Example

1. The OPEN macro opens the section file defined in the file access block SECFAB. (The FOP parameter to the \$FAB macro must specify the UFO option.)
2. The SYS\$CRMPSC system service uses the addresses specified at MAPRANGE to specify an input range of addresses into which the section will be mapped. The **pagcnt** argument requests that only 4 pagelets of the file be mapped.
3. The **flags** argument requests that the pages in the section have read/write access. The symbolic flag definitions for this argument are defined in the \$SECDEF macro. Note that the file access field (FAC parameter) in the FAB also indicates that the file is to be opened for writing.
4. When SYS\$CRMPSC completes, the addresses of the 4 pagelets that were mapped are returned in the output address array at RETRANGE. The address of the beginning of the section is placed in register 6, which serves as a pointer to the section.

#### 12.3.7.8 Mapping Global Sections

A process that creates a global section can map that global section. Then other processes can map it by calling the Map Global Section (SYS\$MGBLSC) system service.

When a process maps a global section, it must specify the global section name assigned to the section when it was created, whether it is a group or system global section, and whether it desires read-only or read/write access. The process may also specify the following:

- A version identification (**ident** argument), indicating the version number of the global section (when multiple versions exist) and whether more recent versions are acceptable to the process.
- A relative pagelet number (**relpag** argument), specifying the pagelet number, relative to the beginning of the section, to begin mapping the section. In this way, processes can use only portions of a section. Additionally, a process can map a piece of a section into a particular address range and subsequently map a different piece of the section into the same virtual address range.

On Alpha systems, you should specify the **retadr** argument to determine the exact boundaries of the memory that was mapped by the call. If your application specifies the **relpag** argument, you *must* specify the **retadr** argument. In this case, it is not an optional argument.

Cooperating processes can both issue a SYS\$CRMPSC system service to create and map the same global section. The first process to call the service actually creates the global section; subsequent attempts to create and map the section result only in mapping the section for the caller. The successful return status code SS\$\_CREATED indicates that the section did not already exist when the

## Memory Management Services and Routines on OpenVMS Alpha

### 12.3 Using System Services for Memory Allocation

SYS\$CRMPSC system service was called. If the section did exist, the status code SS\$\_NORMAL is returned.

The example in Section 12.3.7.12 shows one process (ORION) creating a global section and a second process (CYGNUS) mapping the section.

#### 12.3.7.9 Global Page-File Sections

Global page-file sections are used to store temporary data in a global section. A global page-file section is a section of virtual memory that is not mapped to a file. The section can be deleted when processes have finished with it. (Contrast this with demand-zero section file pages where no initialization is necessary, but the pages are saved in a file.) The system parameter GBLPAGFIL controls the total number of global page-file pages in the system.

To create a global page-file section, you must set the flag bits SEC\$\_M\_GBL and SEC\$\_M\_PAGFIL in the **flags** argument to the Create and Map Section (SYS\$CRMPSC) system service. The channel (**chan** argument) must be 0.

You cannot specify the flag bit SEC\$\_M\_CRF with the flag bit SEC\$\_M\_PAGFIL.

#### 12.3.7.10 Mapping into a Defined Address Range (Alpha Only)

On Alpha systems, SYS\$CRMPSC and SYS\$MGBLSC interpret some of the arguments differently than on VAX systems if you are mapping a section into a defined area of virtual address space. The differences are as follows:

- The addresses specified as values in the **inadr** argument must be aligned on CPU-specific page boundaries. On VAX systems, SYS\$CRMPSC and the SYS\$MGBLSC round these addresses to page boundaries for you. On Alpha systems, SYS\$CRMPSC does not round the addresses you specify to page boundaries, because rounding to CPU-specific page boundaries on Alpha system affects a much larger portion of memory than it does on VAX systems, where page sizes are much smaller. Therefore, on Alpha systems, you must explicitly state where you want the virtual memory space mapped. If the addresses you specify are not aligned on CPU-specific page boundaries, SYS\$CRMPSC returns an invalid arguments error (SS\$\_INVARG).

In particular, the lower **inadr** address must be on a CPU-specific page boundary, and the higher **inadr** address must be one less than a CPU-specific page; that is, it indicates the highest-addressed byte of the **inadr** range.

- The addresses returned in the **retadr** argument reflect only the usable portion of the actual memory mapped by the call, not the entire amount mapped. The usable amount is either the value specified in the **pagcnt** argument (measured in pagelets) or the size of the section file, whichever is smaller. The actual amount mapped depends on how many CPU-specific pages are required to map the section file. If the section file does not fill a CPU-specific page, the remainder of the page is filled with zeros. The excess space on this page should not be used by your application. The end address specified in the **retadr** argument specifies the upper limit available to your application. Also note that, when the **relpag** argument is specified, the **retadr** argument *must* be included. It is not optional on Alpha systems.

## Memory Management Services and Routines on OpenVMS Alpha

### 12.3 Using System Services for Memory Allocation

#### 12.3.7.11 Mapping from an Offset into a Section File (Alpha Only)

On Alpha systems, you can map a portion of a section file by specifying the address at which to start the mapping as an offset from the beginning of the section file. You specify this offset by supplying a value to the **relpag** argument of SYS\$CRMPSC. The value of the **relpag** argument specifies the pagelet number relative to the beginning of the file at which the mapping should begin.

To preserve compatibility, SYS\$CRMPSC interprets the value of the **relpag** argument in 512-byte units on both VAX systems and Alpha systems. However, because the CPU-specific page size on the Alpha system is larger than 512 bytes, the address specified by the offset in the **relpag** argument probably does not fall on a CPU-specific page boundary on an Alpha system. SYS\$CRMPSC can map virtual memory in CPU-specific page increments only. Therefore, on Alpha systems, the mapping of the section file will start at the beginning of the CPU-specific page that contains the offset address, not at the address specified by the offset.

---

#### Note

---

Even though the routine starts mapping at the beginning of the CPU-specific page that contains the address specified by the offset, the start address returned in the **retadr** argument is the address specified by the offset, not the address at which mapping actually starts.

---

If you map from an offset into a section file, you must still provide an **inadr** argument that abides by the requirements presented in Section 12.3.7.10 when mapping into a defined address range.

#### 12.3.7.12 Section Paging

The first time an image executing in a process refers to a page that was created during the mapping of a disk file section, the page is copied into physical memory. The address of the page in the virtual address space of a process is mapped to the physical page. During the execution of the image, normal paging can occur; however, pages in sections are not written into the page file when they are paged out, as is the normal case. Rather, if they have been modified, they are written back into the section file on disk. The next time a page fault occurs for the page, the page is brought back from the section file.

If the pages in a section were defined as demand-zero pages or copy-on-reference pages when the section was created, the pages are treated differently, as follows:

- If the call to SYS\$CRMPSC requested that pages in the section be treated as demand-zero pages, these pages are initialized to zeros when they are created in physical memory. If the file is either a new file being created as a section or a file being completely rewritten, demand-zero pages provide a convenient way of initializing the pages. The pages are paged back into the section file.
- When the section is deleted, all unreferenced pages are written back to the file as zeros. This causes the file to be initialized, no matter how few pages were modified.

See Section 12.3.7.14 for details about deleting sections.

## Memory Management Services and Routines on OpenVMS Alpha

### 12.3 Using System Services for Memory Allocation

- If the call to SYS\$CRMPSC requested that pages in the section be copy-on-reference pages, each process that maps to the section receives its own copy of the section, on a page-by-page basis from the file, as it refers to them. These pages are never written back into the section file but are paged to the paging file as needed.

In the case of global sections, more than one process can be mapped to the same physical pages. If these pages need to be paged out or written back to the disk file defined as the section, these operations are done only when the pages are not in the working set of any process.

In the following example for Alpha systems, process ORION creates a global section and process CYGNUS maps to that section:

```
/* Process ORION */
#include <rms.h>
#include <rmsdef.h>
#include <literal>(<string.h>)
#include <secdef.h>
#include <descrip.h>

struct FAB gblfab;

main() {
    unsigned short chan;
    unsigned int status, flags, efn=65;
    char *fn = "SECTION.TST";
    $DESCRIPTOR(name, "FLAG_CLUSTER"); /* Common event flag cluster name */
    $DESCRIPTOR(gsdnam, "GLOBAL_SECTION"); /* Global section name */
    ❶status = SYS$ASCEFC(efn, &name, 0);
    if ((status & 1) != 1)
        LIB$SIGNAL( status );
    /* Initialize FAB fields */
    gblfab = cc$rms_fab;
    gblfab.fab$l_alq = 4;
    gblfab.fab$b_fac = FAB$M_PUT;
    gblfab.fab$l_fnm = fn;
    gblfab.fab$l_fop = FAB$M_CIF || FAB$M_CBT;
    .
    .
    .
    /* Create a file if none exists */
    ❷status = SYS$CREATE( &gblfab, 0, 0 );
    if ((status & 1) != 1)
        LIB$SIGNAL( status );
    flags = SEC$M_GBL | SEC$M_WRT;
    status = SYS$CRMPSC(0, 0, 0, flags, &gsdnam, . . . );
    if ((status & 1) != 1)
        LIB$SIGNAL( status );
    status = SYS$SETEF(efn);
    if ((status & 1) != 1)
        LIB$SIGNAL( status );
    .
    .
    .
}
/* Process CYGNUS */
```

## Memory Management Services and Routines on OpenVMS Alpha

### 12.3 Using System Services for Memory Allocation

```
    unsigned int status, efn=65;
    $DESCRIPTOR(cluster,"FLAG_CLUSTER");
    $DESCRIPTOR(section,"GLOBAL_SECTION");
    .
    .
    .
    ③status = SYS$ASCEFC(efn, &cluster, 0);
        if ((status & 1) != 1)
            LIB$SIGNAL( status );

    status = SYS$WAITFR(efn);
    if ((status & 1) != 1)
        LIB$SIGNAL( status );

    status = SYS$MGBLSC(&inadr, &retadr, 0, flags, &section, 0, 0);
    if ((status & 1) != 1)
        LIB$SIGNAL( status );
}
```

- ① The processes ORION and CYGNUS are in the same group. Each process first associates with a common event flag cluster named FLAG\_CLUSTER to use common event flags to synchronize its use of the section.
- ② The process ORION creates the global section named GLOBAL\_SECTION, specifying section flags that indicate that it is a global section (SEC\$M\_GBL) and has read/write access. Input and output address arrays, the page count parameter, and the channel number arguments are not shown; procedures for specifying them are the same, as shown in this example.
- ③ The process CYGNUS associates with the common event flag cluster and waits for the flag defined as FLGSET; ORION sets this flag when it has finished creating the section. To map the section, CYGNUS specifies the input and output address arrays, the flag indicating that it is a global section, and the global section name. The number of pages mapped is the same as that specified by the creator of the section.

#### 12.3.7.13 Reading and Writing Data Sections

Read/write sections provide a way for a process or cooperating processes to share data files in virtual memory.

The sharing of global sections may involve application-dependent synchronization techniques. For example, one process can create and map to a global section in read/write fashion; other processes can map to it in read-only fashion and interpret data written by the first process. Alternatively, two or more processes can write to the section concurrently. (In this case, the application must provide the necessary synchronization and protection.)

After data in a process private section is modified, the process can release (or unmap) the section. The modified pages are then written back into the disk file defined as a section.

After data in a global section is modified, the process or processes can release (or unmap) the section. The modified pages are still maintained in memory until the section is deleted. The data is then written back into the disk file defined as a section. Applications relying on modified data to be in the file at a specific point in time must use the SYS\$UPDSEC(W) system service to force the write action. See Section 12.3.7.15.

## Memory Management Services and Routines on OpenVMS Alpha

### 12.3 Using System Services for Memory Allocation

When the section is deleted, the revision number of the file is incremented, and the version number of the file remains unchanged. A full directory listing indicates the revision number of the file and the date and time that the file was last updated.

#### 12.3.7.14 Releasing and Deleting Sections

A process unmaps a section by deleting the virtual addresses in its own virtual address space to which it has mapped the section. If a return address range was specified to receive the virtual addresses of the mapped pages, this address range can be used as input to the Delete Virtual Address Space (SYS\$DELTVA) system service, as follows:

```
$DELTVA_S INADR=RETRANGE
```

When a process unmaps a private section, the section is deleted; that is, all control information maintained by the system is deleted. A temporary global section is deleted when all processes that have mapped to it have unmapped it. Permanent global sections are not deleted until they are specifically marked for deletion with the Delete Global Section (SYS\$DGBLSC) system service; they are then deleted when no more processes are mapped.

Note that deleting the pages occupied by a section does not delete the section file, but rather cancels the process's association with the file. Moreover, when a process deletes pages mapped to a process private read/write section, all modified pages are written back into the section file. For global sections, the system's modified page writer starts writing back modified pages when the section is deleted and all mapping processes have deleted their associated virtual address space. Applications relying on modified data to be in the file at a specific point in time must use the SYS\$UPDSEC(W) system service to force the write action. See Section 12.3.7.15.

After a process private section is deleted, the channel assigned to it can be deassigned. The process that created the section can deassign the channel with the Deassign I/O Channel (SYS\$DASSGN) system service, as follows:

```
$DASSGN_S CHAN=GBLFAB+FAB$L_STV
```

For global sections, the channel is only used to identify the file to the system. The system then assigns a different channel to use for future paging I/O to the file. The used assigned channel can be deleted immediately after the global section is created.

#### 12.3.7.15 Writing Back Sections

Because read/write sections are not normally updated on disk until either the physical pages they occupy are paged out, or until the section is deleted, a process should ensure that all modified pages are successfully written back into the section file at regular intervals.

The Update Section File on Disk (SYS\$UPDSEC) system service writes the modified pages in a section into the disk file. The SYS\$UPDSEC system service is described in the *OpenVMS System Services Reference Manual*.



## Memory Management Services and Routines on OpenVMS Alpha

### 12.3 Using System Services for Memory Allocation

#### 12.3.7.16 Memory-Resident Global Sections

Memory-resident global sections allow a database server to keep larger amounts of currently used data cached in physical memory. The database server then accesses the data directly from physical memory without performing I/O read operations from the database files on disk. With faster access to the data in physical memory, runtime performance increases dramatically.

Memory-resident global sections are non-file-backed global sections. Pages within a memory-resident global section are not backed by the pagefile or by any other file on disk. Thus, no pagefile quota is charged to any process or to the system. When a process maps to a memory-resident global section and references the pages, working set list entries are not created for the pages. No working set quota is charged to the process.

For further information about memory-resident global sections, see Chapter 16.

#### 12.3.7.17 Image Sections

Global sections can contain shareable code. The operating system uses global sections to implement shareable code, as follows:

1. The object module containing code to be shared is linked to produce a shareable image. The shareable image is not, in itself, executable. It contains a series of sections, called **image sections**.
2. You link private object modules with the shareable image to produce an executable image. No code or data from the shareable image is put into the executable image.
3. The system manager uses the INSTALL command to create a permanent global section from the shareable image file, making the image sections available for sharing.
4. When you run the executable image, the operating system automatically maps the global sections created by the INSTALL command into the virtual address space of your process.

For details on how to create and identify shareable images and how to link them with private object modules, see the *OpenVMS Linker Utility Manual*. For information about how to install shareable images and make them available for sharing as global sections, see the *OpenVMS System Manager's Manual*.

#### 12.3.7.18 Page Frame Sections

A **page frame section** is one or more contiguous pages of physical memory or I/O space that have been mapped as a section. One use of page frame sections is to map to an I/O page, thus allowing a process to read device registers.

A page frame section differs from a disk file section in that it is not associated with a particular disk file and is not paged. However, it is similar to a disk file section in most other respects: you create, map, and define the extent and characteristics of a page frame section in essentially the same manner as you do for a disk file section.

To create a page frame section, you must specify page frame number (PFN) mapping by setting the SEC\$M\_PFNMAP flag bit in the **flags** argument to the Create and Map Section (SYS\$CRMPSC) system service. The **vbn** argument is now used to specify that the first page frame is to be mapped instead of the first virtual block. You must have the user privilege PFNMAP to either create or delete a page frame section but not to map to an existing one.

## Memory Management Services and Routines on OpenVMS Alpha

### 12.3 Using System Services for Memory Allocation

Because a page frame section is not associated with a disk file, you do not use the **chan**, and **pfc** arguments to the SYS\$CRMPSC service to create or map this type of section. For the same reason, the SEC\$M\_CRF (copy-on-reference) and SEC\$M\_DZRO (demand-zero) bit settings in the **flags** argument do not apply. Pages in page frame sections are not written back to any disk file (including the paging file). The **pagcnt** and **relpag** arguments are in units of CPU-specific pages for page frame sections.

---

#### Caution

---

You must use caution when working with page frame sections. If you permit write access to the section, each process that writes to it does so at its own risk. Serious errors can occur if a process writes incorrect data or writes to the wrong page, especially if the page is also mapped by the system or by another process. Thus, any user who has the PFNMAP privilege can damage or violate the security of a system.

---

#### 12.3.7.19 Partial Sections (Alpha Only)

On Alpha systems, a **partial section** is one where not all of the defined section, whether private or global, is entirely backed up by disk blocks. In other words, a partial section is where a disk file does not map completely onto an Alpha system page.

For example, suppose a file for which you wish to create a section consists of 17 virtual blocks on disk. To map this section, you would need two whole Alpha 8 KB pages, the smallest size Alpha page available. The first Alpha page would map the first 16 blocks of the section, and the second Alpha page would map the 17th block of the section. (A block on disk is 512 bytes, same as on OpenVMS VAX.) This results in 15/16ths of the second Alpha page not being backed up by the section file. This is called a partial section because the second Alpha page of the section is only partially backed up.

When the partial page is faulted in, a disk read is issued for only as many blocks as actually back up that page, which in this case is 1. When that page is written back, only the one block is actually written.

If the upper portion of the second Alpha page is used, it is done so at some risk, because only the first block of that page is saved on a write-back operation. This upper portion of the second Alpha page is not really useful space to the programmer, because it is discarded during page faulting.

#### 12.3.8 Example of Using Memory Management System Services (Alpha Only)

In the following example, two programs are communicating through a global section. The first program creates and maps a global section (by using SYS\$CRMPSC) and then writes a device name to the section. This program also defines the device terminal and process names and sets the event flags that synchronize the processes.

The second program maps the section (by using SYS\$MGBLSC) and then reads the device name and the process that allocated the device and any terminal allocated to that process. This program also writes the process named to the terminal global section where the process name can be read by the first program.

## Memory Management Services and Routines on OpenVMS Alpha

### 12.3 Using System Services for Memory Allocation

The common event cluster is used to synchronize access to the global section. The first program sets REQ\_FLAG to indicate that the device name is in the section. The second program sets INFO\_FLAG to indicate that the process and terminal names are available.

Data in a section must be page aligned. The following is the option file used at link time that causes the data in the common area named DATA to be page aligned:

```
PSECT_ATTR = DATA, PAGE
```

For high-level language usage, use the **solitary** attribute of the linker. See the *OpenVMS Linker Utility Manual* for an explanation of how to use the **solitary** attribute. The address range requested for a section must end on a page boundary, so SYS\$GETSYI is used to obtain the system page size.

Before executing the first program, you need to write a user-open routine that sets the user-open bit (FAB\$V\_UFO) of the FAB options longword (FAB\$L\_FOP). Because the Fortran OPEN statement specifies that the file is new, you should use \$CREATE to open it rather than \$OPEN. No \$CONNECT should be issued. The user-open routine reads the channel number that the file is opened on from the status longword (FAB\$L\_STV) and returns that channel number to the main program by using a common block (CHANNEL in this example).

!This is the program that creates the global section.

```
! Define global section flags
INCLUDE '($SECDEF)'
! Mask for section flags
INTEGER SEC_MASK

! Logical unit number for section file
INTEGER INFO_LUN
! Channel number for section file
! (returned from useropen routine)
INTEGER SEC_CHAN
COMMON /CHANNEL/ SEC_CHAN
! Length for the section file
INTEGER SEC_LEN
! Data for the section file
CHARACTER*12 DEVICE,
2          PROCESS
CHARACTER*6  TERMINAL
COMMON /DATA/ DEVICE,
2          PROCESS,
2          TERMINAL
! Location of data
INTEGER PASS_ADDR (2),
2          RET_ADDR (2)

! Two common event flags
INTEGER REQUEST_FLAG,
2          INFO_FLAG
DATA REQUEST_FLAG /70/
DATA INFO_FLAG /71/
```

## Memory Management Services and Routines on OpenVMS Alpha

### 12.3 Using System Services for Memory Allocation

```

! Data for SYS$GETSYI
INTEGER PAGE_SIZE
INTEGER*2 BUFF_LEN, ITEM_CODE
INTEGER BUFF_ADDR, LENGTH, TERMINATOR
EXTERNAL SYI$PAGE_SIZE
COMMON /GETSYI_ITEMLIST/ BUFF_LEN,
2                               ITEM_CODE,
2                               BUFF_ADDR,
2                               LENGTH,
2                               TERMINATOR

! User-open routines
INTEGER UFO_CREATE
EXTERNAL UFO_CREATE
.
.
.
! Open the section file
STATUS = LIB$GET_LUN (INFO_LUN)
IF (.NOT. STATUS) CALL LIB$SIGNAL(%VAL(STATUS))
SEC_MASK = SEC$M_WRT .OR. SEC$M_DZRO .OR. SEC$M_GBL
! (Last element - first element + size of last element + 511)/512
SEC_LEN = ( (%LOC(TERMINATOR) - %LOC(DEVICE) + 6 + 511)/512 )
OPEN (UNIT=INFO_LUN,
2     FILE='INFO.TMP',
2     STATUS='NEW',
2     INITIALSIZE = SEC_LEN,
2     USEROPEN = UFO_CREATE)
! Free logical unit number and map section
CLOSE (INFO_LUN)

! Get the system page size
BUFF_LEN = 4
ITEM_CODE = %LOC(SYI$PAGE_SIZE)
BUFF_ADDR = %LOC(PAGE_SIZE)
LENGTH = 0
TERMINATOR = 0

STATUS = SYS$GETSYI(,,,BUFF_LEN,,,)

! Get location of data
PASS_ADDR (1) = %LOC (DEVICE)
PASS_ADDR (2) = PASS_ADDR(1) + PAGE_SIZE - 1

STATUS = SYS$CRMPSC (PASS_ADDR, ! Address of section
2                   RET_ADDR, ! Addresses mapped
2                   ,
2                   %VAL(SEC_MASK), ! Section mask
2                   'GLOBAL_SEC', ! Section name
2                   ,,
2                   %VAL(SEC_CHAN), ! I/O channel
2                   ,,,)
IF (.NOT. STATUS) CALL LIB$SIGNAL(%VAL(STATUS))

! Create the subprocess
STATUS = SYS$CREPRC (,
2                   'GETDEVINF', ! Image
2                   ,,,
2                   'GET_DEVICE', ! Process name
2                   %VAL(4),,,) ! Priority
IF (.NOT. STATUS) CALL LIB$SIGNAL(%VAL(STATUS))

! Write data to section
DEVICE = '$DISK1'

```

## Memory Management Services and Routines on OpenVMS Alpha 12.3 Using System Services for Memory Allocation

```

! Get common event flag cluster and set flag
STATUS = SYS$ASCEFC (%VAL(REQUEST_FLAG),
2          'CLUSTER',,)
IF (.NOT. STATUS) CALL LIB$SIGNAL(%VAL(STATUS))
STATUS = SYS$SETEF (%VAL(REQUEST_FLAG))
IF (.NOT. STATUS) CALL LIB$SIGNAL(%VAL(STATUS))

! When GETDEVINF has the information, INFO_FLAG is set
STATUS = SYS$WAITFR (%VAL(INFO_FLAG))
IF (.NOT. STATUS) CALL LIB$SIGNAL(%VAL(STATUS))
.
.
.

! This is the program that maps to the global section
! created by the previous program.

! Define section flags
INCLUDE '($SECDEF)'
! Mask for section flags
INTEGER SEC_MASK
! Data for the section file
CHARACTER*12 DEVICE,
2          PROCESS
CHARACTER*6  TERMINAL
COMMON /DATA/ DEVICE,
2          PROCESS,
2          TERMINAL

! Location of data
INTEGER PASS_ADDR (2),
2          RET_ADDR (2)

! Two common event flags
INTEGER REQUEST_FLAG,
2          INFO_FLAG
DATA REQUEST_FLAG /70/
DATA INFO_FLAG /71/

! Data for SYS$GETSYI
INTEGER PAGE_SIZE
INTEGER*2 BUFF_LEN, ITEM_CODE
INTEGER BUFF_ADDR, LENGTH, TERMINATOR
EXTERNAL SYI$PAGE_SIZE
COMMON /GETSYI_ITEMLIST/ BUFF_LEN,
2          ITEM_CODE,
2          BUFF_ADDR,
2          LENGTH,
2          TERMINATOR
.
.
.

! Get the system page size
BUFF_LEN = 4
ITEM_CODE = %LOC(SYI$PAGE_SIZE)
BUFF_ADDR = %LOC(PAGE_SIZE)
LENGTH = 0
TERMINATOR = 0

STATUS = SYS$GETSYI(,,,BUFF_LEN,,,)

! Get common event flag cluster and wait
! for GBL1.FOR to set REQUEST_FLAG
STATUS = SYS$ASCEFC (%VAL(REQUEST_FLAG),
2          'CLUSTER',,)
IF (.NOT. STATUS) CALL LIB$SIGNAL (%VAL(STATUS))
STATUS = SYS$WAITFR (%VAL(REQUEST_FLAG))
IF (.NOT. STATUS) CALL LIB$SIGNAL (%VAL(STATUS))

```

## Memory Management Services and Routines on OpenVMS Alpha

### 12.3 Using System Services for Memory Allocation

```
! Get location of data
PASS_ADDR (1) = %LOC (DEVICE)
PASS_ADDR (2) = PASS_ADDR(1) + PAGE_SIZE - 1

! Set write flag
SEC_MASK = SEC$M_WRT

! Map the section
STATUS = SYS$MGBLSC (PASS_ADDR, ! Address of section
2                RET_ADDR, ! Address mapped
2                /
2                %VAL(SEC_MASK), ! Section mask
2                'GLOBAL_SEC',,) ! Section name
IF (.NOT. STATUS) CALL LIB$SIGNAL (%VAL(STATUS))

! Call GETDVI to get the process ID of the
! process that allocated the device, then
! call GETJPI to get the process name and terminal
! name associated with that process ID.
! Set PROCESS equal to the process name and
! set TERMINAL equal to the terminal name.
.
.
.
! After information is in GLOBAL_SEC
STATUS = SYS$SETEF (%VAL(INFO_FLAG))
IF (.NOT. STATUS) CALL LIB$SIGNAL (%VAL(STATUS))

END
```

### 12.4 Large Page-File Sections (Alpha Only)

Page-file sections are used to store temporary data in private or global (shared) sections of memory. In releases prior to OpenVMS Alpha Version 7.3, the maximum amount of data that could be backed up to page files was 32 GB per process (4 process page files, each 8 GB) and 504 GB per system (63 page files, each 8 GB).

With OpenVMS Alpha Version 7.3, the previous limits for page-file sections were extended significantly to take advantage of larger physical memory. Now images that use 64-bit addressing can map and access an amount of dynamic virtual memory that is larger than the amount of physical memory available on the system.

With this design, if a process requires additional page-file space, page files can be allocated dynamically. Space is no longer reserved in a distinct page file, and pages are no longer bound to an initially assigned page file. Instead, if modified pages must be written back, they are written to the best available page file.

Each page or swap file can hold approximately 16 million pages (128 GB), and up to 254 page or swap files can be installed. Files larger than 128 GB are installed as multiple files.

Note the following DCL command display changes and system parameter changes as a result of the larger page-file section design:

- The SHOW MEMORY/FILES display reflects the nonreservable design. For example:

## Memory Management Services and Routines on OpenVMS Alpha 12.4 Large Page-File Sections (Alpha Only)

```
$ SHOW MEMORY/FILES
```

```

System Memory Resources on 22-MAY-2000 19:04:19.67
Swap File Usage (8KB pages):
DISK$ALPHASYS:[SYS48.SYSEXE]SWAPFILE.SYS
Index ❶ Free Size
1 904 904
DISK$SWAP:[SYS48.SYSEXE]SWAPFILE.SYS;1
2 1048 1048
Total size of all swap files:
1952
Paging File Usage (8KB pages):
DISK$PAGE:[SYS48.SYSEXE]PAGEFILE.SYS;1
Index ❷ Free Size
253 16888 16888
DISK$ALPHASYS:[SYS48.SYSEXE]PAGEFILE.SYS
254 16888 16888
Total size of all paging files: 33776
Total committed paging file usage: ❸ 1964

```

- ❶ Number of swap files. Begins with an index value of 1 and increases in count.
- ❷ Number of page files. Begins with an index value of 254 and decreases in count.
- ❸ Total committed page file usage. As in previous releases, more pages can reside in page-file sections systemwide than would fit into installed page files.
- The SHOW MEMORY/FILES/FULL display no longer contains separate usage information for page and swap files. Because page-file information is no longer reserved, the system does not need to maintain the number of processes interested in a distinct page or swap file. For example:

```
$ SHOW MEMORY/FILES/FULL
```

```

System Memory Resources on 22-MAY-2000 18:47:10.21
Swap File Usage (8KB pages):
DISK$ALPHASYS:[SYS48.SYSEXE]SWAPFILE.SYS
Index Free Size
1 904 904
Paging File Usage (8KB pages):
DISK$ALPHASYS:[SYS48.SYSEXE]PAGEFILE.SYS
Index Free Size
254 16888 16888
Total committed paging file usage: 1960

```

- System parameters PAGFILCNT and SWPFILCNT are now obsolete. Up to 254 page and swap files can be installed.





---

## Memory Management Services and Routines on OpenVMS VAX

This chapter describes the use of system services and run-time routines that VAX systems use to manage memory. It contains the following sections:

Section 13.1 describes the page size on VAX systems.

Section 13.2 describes the layout of virtual address space.

Section 13.3 describes extended addressing enhancements on selected VAX systems.

Section 13.4 describes the three levels of memory allocation routines.

Section 13.5 discusses how to use system services to add virtual address space, adjust working sets, control process swapping, and create and manage sections.

### 13.1 Virtual Page Size

To facilitate memory protection and mapping, the virtual address space on VAX systems is subdivided into segments of 512-byte sizes called **pages**. (On Alpha systems, memory page sizes are much larger and vary from system to system. See Chapter 12 for information about Alpha page sizes.) Versions of system services and run-time library routines that accept page-count values as arguments interpret these arguments in 512-byte quantities. Services and routines automatically round the specified addresses to page boundaries.

### 13.2 Virtual Address Space

The initial size of a process's virtual address space depends on the size of the image being executed. The virtual address space of an executing program consists of the following three regions:

- Process program region (P0)

The process program region is also referred to as P0 space. P0 space contains the instructions and data for the current image.

Your program can dynamically allocate storage in the process program region by calling run-time library (RTL) dynamic memory allocation routines or system services.

- Process control region (P1)

The process control region is also referred to as P1 space. P1 space contains system control information and the user-mode process stack. The user mode stack expands as necessary toward the lower-addressed end of P1 space.

# Memory Management Services and Routines on OpenVMS VAX

## 13.2 Virtual Address Space

- Common system region (S0)  
The common system region is also referred to as S0 space. S0 space contains the operating system. Your program cannot allocate or free memory within the common system region from the user access mode.  
This common system region (S0) of system virtual address space can have appended to it additional virtual address space, known as a reserved region, or S1 space, that creates a single region of system space. As a result, the system virtual address space increases from 1 GB to 2 GB.

A summary of these regions appears in Figure 13–1.

**Figure 13–1 Virtual Address Overview on VAX Systems**

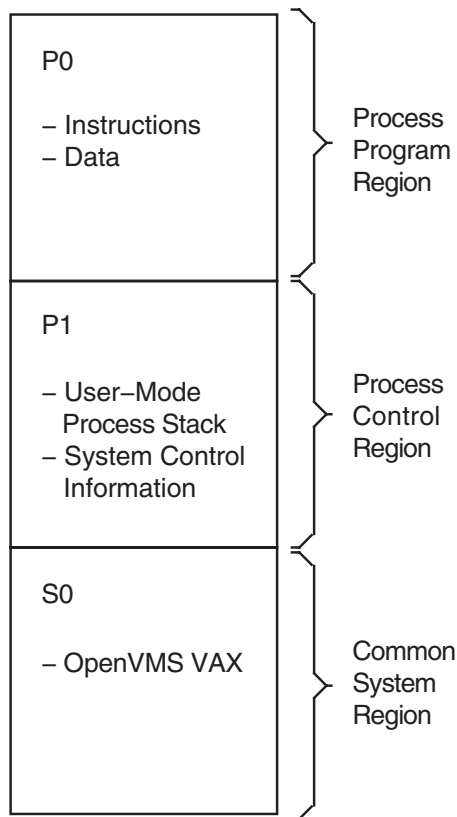

ZK-4145-GE

The memory management routines map and control the relationship between physical memory and the virtual address space of a process. These activities are, for the most part, transparent to you and your programs. In some cases, however, you can make a program more efficient by explicitly controlling its virtual memory usage.

The maximum size to which a process can increase its address space is controlled by the system parameter `VIRTUALPAGECNT`.

Using memory management system services, a process can add a specified number of pages to the end of either the program region or the control region. Adding pages to the program region provides the process with additional space for image execution, for example, for the dynamic creation of tables or data areas. Adding pages to the control region increases the size of the user stack.

## Memory Management Services and Routines on OpenVMS VAX

### 13.2 Virtual Address Space

As new pages are referenced, the stack is automatically expanded, as shown in Figure 13–2. (By using the `STACK=` option in a linker options file, you can also expand the user stack when you link the image.)

Figure 13–2 illustrates the layout of a process's virtual memory. The initial size of a process's virtual address space depends on the size of the image being executed.

**Figure 13–2 Layout of VAX Process Virtual Address Space**

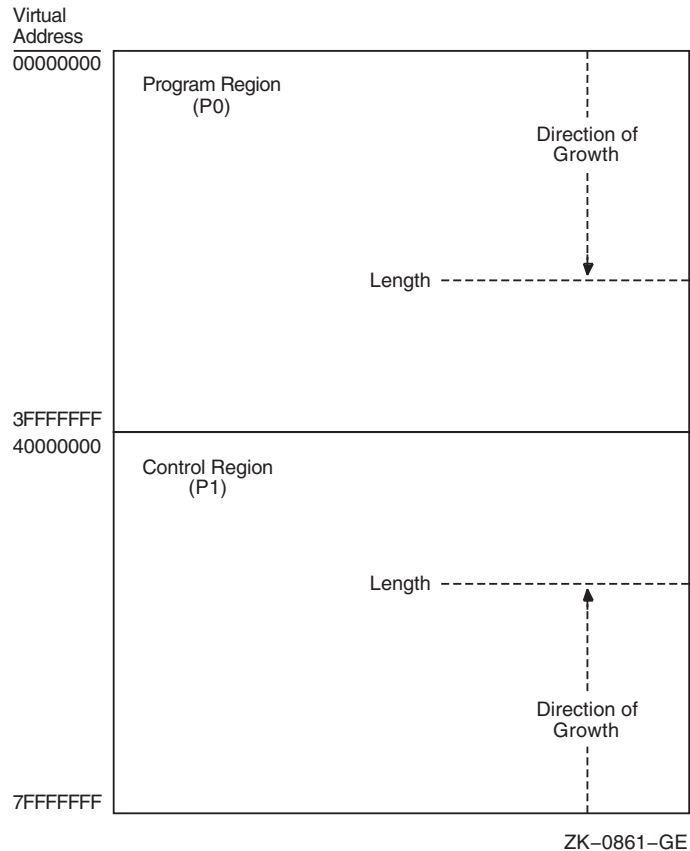

### 13.3 Extended Addressing Enhancements on Selected VAX Systems

Selected VAX systems have extended addressing (XA) as part of the memory management subsystem. Extended addressing enhancement is supported on the VAX 6000 Model 600, VAX 7000 Model 600, and VAX 10000 Model 600 systems. Extended addressing contains the following two major enhancements that affect system images, system integrated products (SIPs), privileged layered products (LPs), and device drivers:

- Extended physical addressing (XPA)
- Extended virtual addressing (XVA)

# Memory Management Services and Routines on OpenVMS VAX

## 13.3 Extended Addressing Enhancements on Selected VAX Systems

Extended physical addressing increases the size of a physical address from 30 bits to 32 bits. This increases the capacity for physical memory from 512 MB to 3.5 GB as shown in Figure 13–3. The 512 MB is still reserved for I/O and adapter space.

**Figure 13–3 Physical Address Space for VAX Systems with XPA**

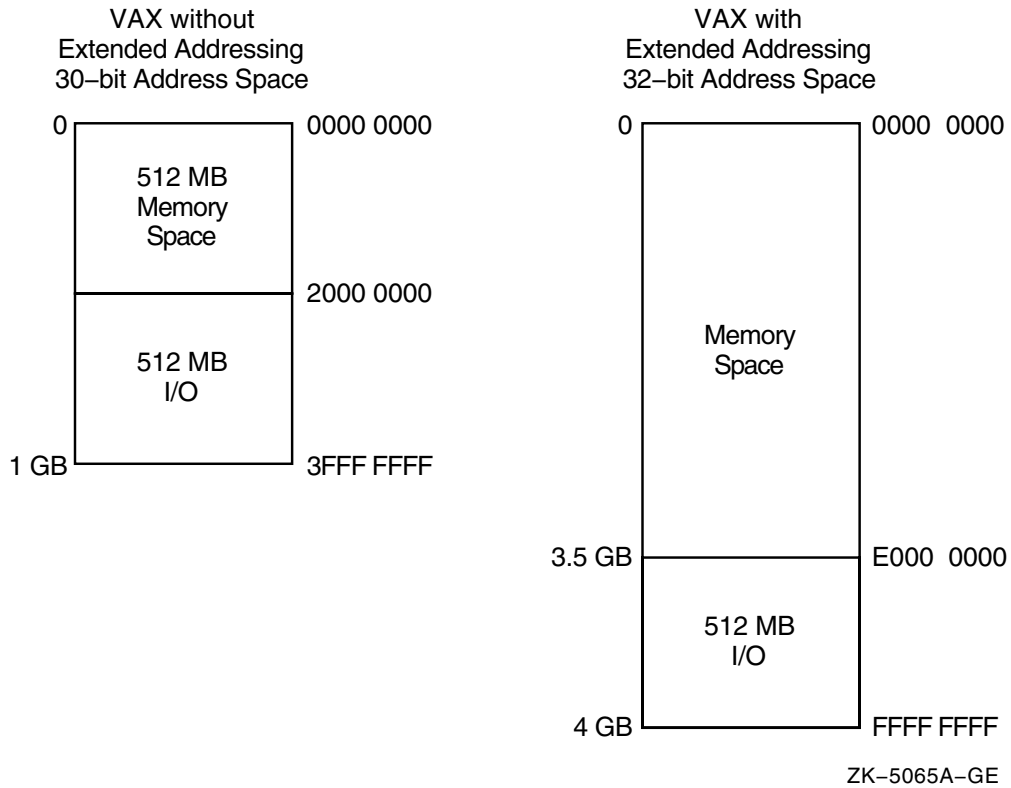

Extended virtual addressing (XVA) increases the size of the virtual page number field in the format of a system space address from 21 bits to 22 bits. The region of system virtual address space, known as the reserved region or S1 space, is appended to the existing region of system virtual address space known as S0 space, thereby creating a single region of system space. As a result, the system virtual address space increases from 1 GB to 2 GB as shown in Figure 13–4.

# Memory Management Services and Routines on OpenVMS VAX

## 13.3 Extended Addressing Enhancements on Selected VAX Systems

Figure 13–4 Virtual Address Space for VAX Systems with XVA

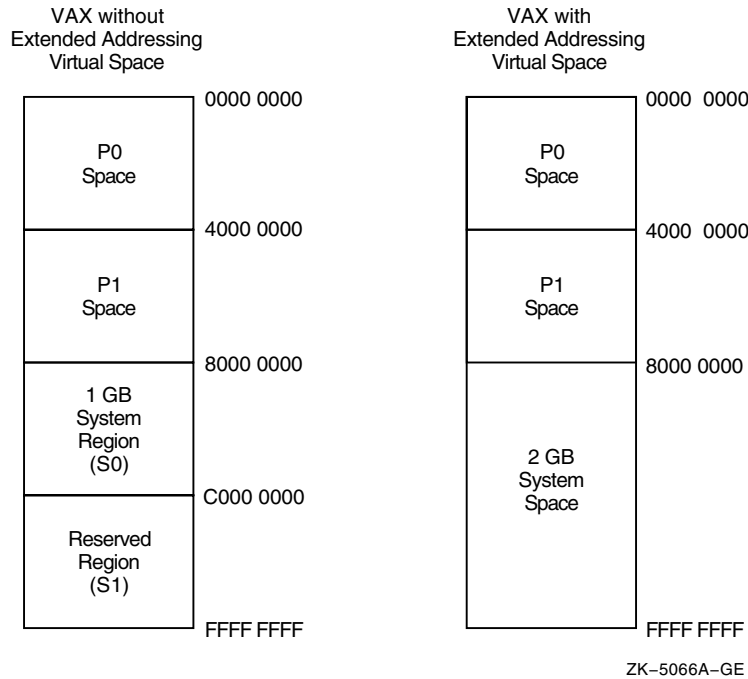

### 13.3.1 Page Table Entry for Extended Addresses on VAX Systems

As shown in Figure 13–3, extended addressing increases the maximum physical address space supported by VAX systems from 1 GB to 4 GB. This is accomplished by expanding the page frame number (PFN) field in a page table entry (PTE) from 21 bits to 23 bits, and implementing changes in the memory management arrays that are indexed by PFN. Both the process page table entry and system page table entry are changed.

## 13.4 Levels of Memory Allocation Routines

Sophisticated software systems must often create and manage complex data structures. In these systems, the size and number of elements are not always known in advance. You can tailor the memory allocation for these elements by using **dynamic memory allocation**. By managing the memory allocation, you can avoid allocating fixed tables that may be too large or too small for your program. Managing memory directly can improve program efficiency. By allowing you to allocate specific amounts of memory, the operating system provides a hierarchy of routines and services for memory management. Memory allocation and deallocation routines allow you to allocate and free storage within the virtual address space available to your process.

There are three levels of memory allocation routines:

1. Memory management system services

The memory management system services comprise the lowest level of memory allocation routines. These services include, but are not limited to, the following:

- SYS\$EXPREG (Expand Region)
- SYS\$CRETVA (Create Virtual Address Space)
- SYS\$DELTVA (Delete Virtual Address Space)

## Memory Management Services and Routines on OpenVMS VAX

### 13.4 Levels of Memory Allocation Routines

SYS\$CRMPSC (Create and Map Section)  
SYS\$MGBLSC (Map Global Section)  
SYS\$DGBLSC (Delete Global Section)

For most cases in which a system service is used for memory allocation, the Expand Region (SYS\$EXPREG) system service is used to create pages of virtual memory.

Because system services provide more control over allocation procedures than RTL routines, you must manage the allocation precisely. System services provide extensive control over address space allocation by allowing you to do the following types of tasks:

- Add or delete virtual address space to the process program region (P0) or process control region (P1)
- Add or delete virtual address space at a specific range of addresses
- Increase or decrease the number of pages in a program's working set
- Lock or delete pages of a program's working set in memory
- Lock the entire program's working set in memory (by disabling process swapping)
- Define disk files containing data or shareable images and map the files into the virtual address space of a process

#### 2. RTL page management routines

RTL routines are available for creating, deleting, and accessing information about virtual address space. You can either allocate a specified number of contiguous pages or create a zone of virtual address space. A **zone** is a logical unit of the memory pool or subheap that you can control as an independent area. It can be any size required by your program. Refer to Chapter 14 for more information about zones.

The RTL page management routines LIB\$GET\_VM\_PAGE and LIB\$FREE\_VM\_PAGE provide a convenient mechanism for allocating and freeing pages of memory.

These routines maintain a processwide pool of free pages. If unallocated pages are not available when LIB\$GET\_VM\_PAGE is called, it calls SYS\$EXPREG to create the required pages in the program region (P0 space).

#### 3. RTL heap management routines

The RTL heap management routines LIB\$GET\_VM and LIB\$FREE\_VM provide a mechanism for allocating and freeing blocks of memory of arbitrary size.

The following are heap management routines based on the concept of zones:

LIB\$CREATE\_VM\_ZONE  
LIB\$CREATE\_USER\_VM\_ZONE  
LIB\$DELETE\_VM\_ZONE  
LIB\$FIND\_VM\_ZONE  
LIB\$RESET\_VM\_ZONE  
LIB\$SHOW\_VM\_ZONE  
LIB\$VERIFY\_VM\_ZONE

If an unallocated block is not available to satisfy a call to LIB\$GET\_VM, LIB\$GET\_VM calls LIB\$GET\_VM\_PAGE to allocate additional pages.

## Memory Management Services and Routines on OpenVMS VAX

### 13.4 Levels of Memory Allocation Routines

Modular application programs can call routines at any or all levels of the hierarchy, depending on the kinds of services the application program needs. You must observe the following basic rule when using multiple levels of the hierarchy:

Memory that is allocated by an allocation routine at one level of the hierarchy must be freed by calling a deallocation routine at the same level of the hierarchy. For example, if you allocated a page of memory by calling LIB\$GET\_VM\_PAGE, you can free it only by calling LIB\$FREE\_VM\_PAGE.

Figure 13–5 shows the three levels of memory allocation routines.

**Figure 13–5 Hierarchy of VAX Memory Management Routines**

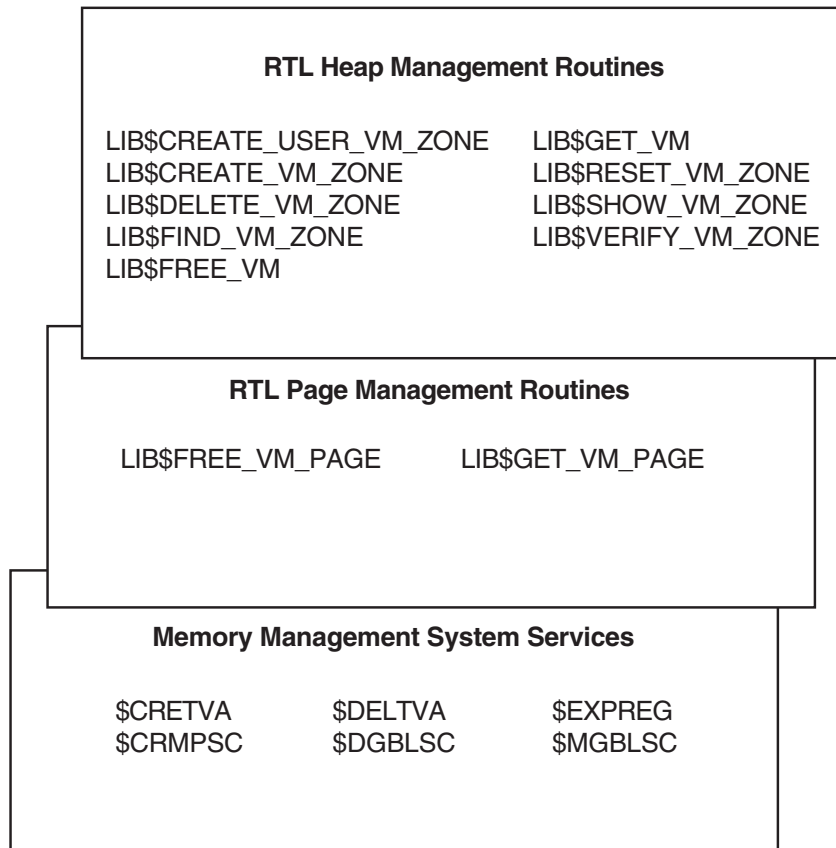

ZK-4146-GE

For information about using memory management RTLs, see Chapter 14.

### 13.5 Using System Services for Memory Allocation

This section describes how to use system services to perform the following tasks:

- Increase and decrease virtual address space
- Input and return address arrays
- Control page ownership and protection
- Control working set paging
- Control process swapping

## Memory Management Services and Routines on OpenVMS VAX

### 13.5 Using System Services for Memory Allocation

#### 13.5.1 Increasing and Decreasing Virtual Address Space

The system services allow you to add address space anywhere within the process's program region (P0) or control region (P1). To add address space at the end of P0 or P1, use the Expand Program/Control Region (SYS\$EXPREG) system service. SYS\$EXPREG optionally returns the range of virtual addresses for the new pages. To add address space in other portions of P0 or P1, use SYS\$CRETVA.

The format for SYS\$EXPREG is as follows:

```
SYS$EXPREG (pagcnt ,[retadr] ,[acmode] ,[region])
```

##### Specifying the Number of Pages

Use the **pagcnt** argument to specify the number of pages to add to the end of the region. The range of addresses where the new pages are added is returned in **retadr**.

##### Specifying the Access Mode

Use the **acmode** argument to specify the access to be assigned to the newly created pages.

##### Specifying the Region

Use the **region** argument to specify whether to add the pages to the end of the P0 or P1 region. This argument is optional.

To deallocate pages allocated with SYS\$EXPREG, use SYS\$DELTVA.

The following example illustrates how to add 4 pages to the program region of a process by writing a call to the SYS\$EXPREG system service:

```
#include <stdio.h>
#include <ssdef.h>

main() {
    unsigned int status, retadr[1], pagcnt=4, region=0;
    /* Add 4 pages to P0 space */
    status = SYS$EXPREG( pagcnt, &retadr, 0, region);
    if (( status & 1) != 1)
        LIB$SIGNAL( status );
    else
        printf("Starting address: %d Ending address: %d\n",
            retadr.lower, retadr.upper);
}
```

The value 0 is passed in the **region** argument to specify that the pages are to be added to the program region. To add the same number of pages to the control region, you would specify REGION=#1.

Note that the **region** argument to SYS\$EXPREG is optional; if it is not specified, the pages are added to or deleted from the program region by default.

The SYS\$EXPREG service can add pages only to the end of a particular region. When you need to add pages to the middle of these regions, you can use the Create Virtual Address Space (SYS\$CRETVA) system service. Likewise, when you need to delete pages created by either SYS\$EXPREG or SYS\$CRETVA, you can use the Delete Virtual Address Space (SYS\$DELTVA) system service. For example, if you have used the SYS\$EXPREG service twice to add pages to the program region and want to delete the first range of pages but not the second, you could use the SYS\$DELTVA system service, as shown in the following example:



## Memory Management Services and Routines on OpenVMS VAX

### 13.5 Using System Services for Memory Allocation

```
#include <stdio.h>
#include <ssdef.h>

struct {
    unsigned int lower, upper;
}retadr1, retadr2, retadr3;

main() {
    unsigned int status, pagcnt=4, region=0;

    /* Add 4 pages to P0 space */
    status = SYS$EXPREG( pagcnt, &retadr1, 0, region);
    if (( status & 1) != 1)
        LIB$SIGNAL( status );
    else
        printf("Starting address: %d ending address: %d\n",
            retadr1.lower,retadr1.upper);

    /* Add 3 more pages to P0 space */

    pagcnt = 3;
    status = SYS$EXPREG( pagcnt, &retadr2, 0, region);
    if (( status & 1) != 1)
        LIB$SIGNAL( status );
    else
        printf("Starting address: %d ending address: %d\n",
            retadr2.lower,retadr2.upper);

    /* Delete original allocation */
    status = SYS$DELTVA( &retadr1, &retadr3, 0 );
    if (( status & 1) != 1)
        LIB$SIGNAL( status );
    else
        printf("Starting address: %d ending address: %d\n",
            retadr1.lower,retadr1.upper);
}
```

In this example, the first call to SYS\$EXPREG adds 4 pages to the program region; the virtual addresses of the created pages are returned in the 2-longword array at retadr1. The second call adds 3 pages and returns the addresses at retadr2. The call to SYS\$DELTVA deletes the first 4 pages that were added.

---

#### Caution

---

Be aware that using SYS\$CRETVA presents some risk because it can delete pages that already exist if those pages are not owned by a more privileged access mode. Further, if those pages are deleted, no notification is sent. Therefore, unless you have complete control over an entire system, use SYS\$EXPREG or the RTL routines to allocate address space.

---

#### 13.5.2 Input Address Arrays and Return Address Arrays

When the SYS\$EXPREG system service adds pages to a region, it adds them in the normal direction of growth for the region. The return address array, if requested, indicates the order in which the pages were added. For example:

- If the program region is expanded, the starting virtual address is smaller than the ending virtual address.
- If the control region is expanded, the starting virtual address is larger than the ending virtual address.

# Memory Management Services and Routines on OpenVMS VAX

## 13.5 Using System Services for Memory Allocation

The addresses returned indicate the first byte in the first page that was added or deleted and the last byte in the last page that was added or deleted.

When input address arrays are specified for the Create and Delete Virtual Address Space (SYS\$CRETVA and SYS\$DELTVA, respectively) system services, these services add or delete pages beginning with the address specified in the first longword and ending with the address specified in the second longword.

---

### Note

---

The operating system always adjusts the starting and ending virtual addresses up or down to fit page boundaries.

---

The order in which the pages are added or deleted does not have to be in the normal direction of growth for the region. Moreover, because these services add or delete only whole pages, they ignore the low-order 9 bits of the specified virtual address (the low-order 9 bits contain the byte offset within the page). The virtual addresses returned indicate the byte offsets.

Table 13–1 shows some sample virtual addresses in hexadecimal that may be specified as input to SYS\$CRETVA or SYS\$DELTVA and shows the return address arrays if all pages are successfully added or deleted.

**Table 13–1 Sample Virtual Address Arrays on VAX Systems**

Input Array			Output Array		Number of Pages
Start	End	Region	Start	End	
1010	1670	P0	1000	17FF	4
1450	1451	P0	1400	15FF	1
1200	1000	P0	1000	13FF	2
1450	1450	P0	1400	15FF	1
7FFEC010	7FFEC010	P1	7FFEC1FF	7FFEC000	1
7FFEC010	7FFEBCA0	P1	7FFEC1FF	7FFEB000	3

Note that if the input virtual addresses are the same, as in the fourth and fifth items in Table 13–1, a single page is added or deleted. The return address array indicates that the page was added or deleted in the normal direction of growth for the region.

### 13.5.3 Page Ownership and Protection

Each page in the virtual address space of a process is owned by the access mode that created the page. For example, pages in the program region that are initially provided for the execution of an image are owned by user mode. Pages that the image creates dynamically are also owned by user mode. Pages in the control region, except for the pages containing the user stack, are normally owned by more privileged access modes.

Only the owner access mode or a more privileged access mode can delete the page or otherwise affect it. The owner of a page can also indicate, by means of a protection code, the type of access that each access mode will be allowed.

## Memory Management Services and Routines on OpenVMS VAX

### 13.5 Using System Services for Memory Allocation

The Set Protection on Pages (SYS\$SETPRT) system service changes the protection assigned to a page or group of pages. The protection is expressed as a code that indicates the specific type of access (none, read-only, read/write) for each of the four access modes (kernel, executive, supervisor, user). Only the owner access mode or a more privileged access mode can change the protection for a page.

When an image attempts to access a page that is protected against the access attempted, a hardware exception called an **access violation** occurs. When an image calls a system service, the service probes the pages to be used to determine whether an access violation would occur if the image attempts to read or write one of the pages. If an access violation would occur, the service exits with the status code SS\$\_ACCVIO.

Because the memory management services add, delete, or modify a single page at a time, one or more pages can be successfully changed before an access violation is detected. If the **retadr** argument is specified in the service call, the service returns the addresses of pages changed (added, deleted, or modified) before the error. If no pages are affected, that is, if an access violation would occur on the first page specified, the service returns a value of -1 in both longwords of the return address array.

If the **retadr** argument is not specified, no information is returned.

#### 13.5.4 Working Set Paging

When a process is executing an image, a subset of its pages resides in physical memory; these pages are called the **working set** of the process. The working set includes pages in both the program region and the control region. The initial size of a process's working set is usually defined by the process's working set default (WSDEFAULT) quota. The maximum size of a process's working set is normally defined by the process's working set quota (WSQUOTA). When ample memory is available, a process's working-set upper growth limit can be expanded by its working set extent (WSEXTENT).

When the image refers to a page that is not in memory, a page fault occurs and the page is brought into memory, replacing an existing page in the working set. If the page that is going to be replaced is modified during the execution of the image, that page is written into a paging file on disk. When this page is needed again, it is brought back into memory, again replacing a current page from the working set. This exchange of pages between physical memory and secondary storage is called **paging**.

The paging of a process's working set is transparent to the process. However, if a program is very large or if pages in the program image that are used often are being paged in and out frequently, the overhead required for paging may decrease the program's efficiency. The SYS\$ADJWSL, SYS\$PURGWS, and SYS\$LKWSET system services allow a process, within limits, to counteract these potential problems.

##### **SYS\$ADJWSL System Service**

The Adjust Working Set Limit (SYS\$ADJWSL) system service increases or decreases the maximum number of pages that a process can have in its working set. The format for this routine is as follows:

```
SYS$ADJWSL ([pagcnt],[wsetlm])
```

Use the **pagcnt** argument to specify the number of pages to add or subtract from the current working set size. The new working set size is returned in **wsetlm**.

## Memory Management Services and Routines on OpenVMS VAX

### 13.5 Using System Services for Memory Allocation

#### **SYS\$PURGWS System Service**

The Purge Working Set (SYS\$PURGWS) system service removes one or more pages from the working set.

#### **SYS\$LKWSET System Service**

The Lock Pages in Working Set (SYS\$LKWSET) system service makes one or more pages in the working set ineligible for paging by locking them in the working set. Once locked into the working set, those pages remain until they are explicitly unlocked with the Unlock Pages in Working Set (SYS\$ULWSET) system service or until program execution ends. The format is as follows:

```
SYS$LKWSET (inadr [,retadr] [,acmode])
```

**Specifying a Range of Addresses** Use the **inadr** argument to specify the range of addresses to be locked. The range of addresses of the pages actually locked are returned in the **retadr** argument.

**Specifying the Access Mode** Use the **acmode** argument to specify the access mode to be associated with the pages you want locked.

#### 13.5.5 Process Swapping

The operating system balances the needs of all the processes currently executing, providing each with the system resources it requires on an as-needed basis. The memory management routines balance the memory requirements of the process. Thus, the sum of the working sets for all processes currently in physical memory is called the **balance set**.

When a process whose working set is in memory becomes inactive—for example, to wait for an I/O request or to hibernate—the entire working set or part of it may be removed from memory to provide space for another process's working set to be brought in for execution. This removal from memory is called **swapping**.

The working set may be removed in two ways:

- Partially—Also called **swapper trimming**. Pages are removed from the working set of the target process so that the number of pages in the working set is fewer, but the working set is not swapped.
- Entirely—Called swapping. All pages are swapped out of memory.

When a process is swapped out of the balance set, all the pages (both modified and unmodified) of its working set are swapped, including any pages that had been locked in the working set.

A privileged process may lock itself in the balance set. While pages can still be paged in and out of the working set, the process remains in memory even when it is inactive. To lock itself in the balance set, the process issues the Set Process Swap Mode (SYS\$SETSWM) system service, as follows:

```
$SETSWM _S SWPFLG=#1
```

This call to SYS\$SETSWM disables process swap mode. You can also disable swap mode by setting the appropriate bit in the STSFLG argument to the Create Process (SYS\$CREPRC) system service; however, you need the PSWAPM privilege to alter process swap mode.

A process can also lock particular pages in memory with the Lock Pages in Memory (SYS\$LCKPAG) system service. These pages are not part of the process's working set, but they are forced into the process's working set. When pages are locked in memory with this service, the pages remain in memory even when the

## Memory Management Services and Routines on OpenVMS VAX

### 13.5 Using System Services for Memory Allocation

remainder of the process's working set is swapped out of the balance set. These remaining pages stay in memory until they are unlocked with SYS\$ULKPAG. SYS\$LCKPAG can be useful in special circumstances, for example, for routines that perform I/O operations to devices without using the operating system's I/O system.

You need the PSWAPM privilege to issue SYS\$LCKPAG or SYS\$ULKPAG.

#### 13.5.6 Sections

A **section** is a disk file or a portion of a disk file containing data or instructions that can be brought into memory and made available to a process for manipulation and execution. A section can also be one or more consecutive page frames in physical memory or I/O space; such sections, which require you to specify page frame number (PFN) mapping, are discussed in Section 13.5.6.15.

Sections are either private or global (shared).

- **Private sections** are accessible only by the process that creates them. A process can define a disk data file as a section, map it into its virtual address space, and manipulate it.
- **Global sections** can be shared by more than one process. One copy of the global section resides in physical memory, and each process sharing it refers to the same copy. A global section can contain shareable code or data that can be read, or read and written, by more than one process. Global sections are either temporary or permanent and can be defined for use within a group or on a systemwide basis. Global sections can be either mapped to a disk file or created as a global page-file section.

When modified pages in writable disk file sections are paged out of memory during image execution, they are written back into the section file rather than into the paging file, as is the normal case with files. (However, copy-on-reference sections are not written back into the section file.)

The use of disk file sections involves these two distinct operations:

- The creation of a section defines a disk file as a section and informs the system what portions of the file contain the section.
- The mapping of a section makes it available to a process and establishes the correspondence between virtual blocks in the file and specific addresses in the virtual address space of a process.

The Create and Map Section (SYS\$CRMPSC) system service creates and maps a private section or a global section. Because a private section is used only by a single process, creation and mapping are simultaneous operations. In the case of a global section, one process can create a permanent global section and not map to it; other processes can map to it. A process can also create and map a global section in one operation.

The following sections describe the creation, mapping, and use of disk file sections. In each case, operations and requirements that are common to both private sections and global sections are described first, followed by additional notes and requirements for the use of global sections. Section 13.5.6.9 discusses global page-file sections.

# Memory Management Services and Routines on OpenVMS VAX

## 13.5 Using System Services for Memory Allocation

### 13.5.6.1 Creating Sections

To create a disk file section, follow these steps:

1. Open or create the disk file containing the section.
2. Define which virtual blocks in the file constitute the section.
3. Define the characteristics of the section.

### 13.5.6.2 Opening the Disk File

Before you can use a file as a section, you must open it using OpenVMS Record Management Services (RMS). The following example shows the OpenVMS RMS file access block (\$FAB) and \$OPEN macros used to open the file and the channel specification to the SYS\$CRMPSC system service necessary for reading an existing file:

```
#include <rms.h>
#include <rmsdef.h>
#include <string.h>
#include <secdef.h>

struct FAB secfab;

main() {
    unsigned short chan;
    unsigned int status, retadr[1], pagcnt=1, flags;
    char *fn = "SECTION.TST";

    /* Initialize FAB fields */
    secfab = cc$rms_fab;
    secfab.fab$l_fnā = fn;
    secfab.fab$b_fns = strlen(fn);
    secfab.fab$l_fop = FAB$M_CIF;
    secfab.fab$b_rtv = -1;

    /* Create a file if none exists */
    status = SYS$CREATE( &secfab, 0, 0 );
    if ((status & 1) != 1)
        LIB$SIGNAL( status );

    flags = SEC$M_EXPREG;
    chan = secfab.fab$l_stv;
    status = SYS$CRMPSC(0, &retadr, 0, 0, 0, 0, flags, chan, pagcnt, 0, 0, 0);
    if ((status & 1) != 1)
        LIB$SIGNAL( status );
}
```

In this example, the file options parameter (FOP) indicates that the file is to be opened for user I/O; this parameter is required so that OpenVMS RMS assigns the channel using the access mode of the caller. OpenVMS RMS returns the channel number on which the file is accessed; this channel number is specified as input to SYS\$CRMPSC (**chan** argument). The same channel number can be used for multiple create and map section operations.

The option RTV=-1 tells the file system to keep all of the pointers to be mapped in memory at all times. If this option is omitted, SYS\$CRMPSC requests the file system to expand the pointer areas, if necessary. Storage for these pointers is charged to the BYTLM quota, which means that opening a badly fragmented file can fail with an EXBYTLM failure status. Too many fragmented sections may cause the byte limit to be exceeded.

## Memory Management Services and Routines on OpenVMS VAX

### 13.5 Using System Services for Memory Allocation

The file may be a new file that is to be created while it is in use as a section. In this case, use the \$CREATE macro to open the file. If you are creating a new file, the file access block (FAB) for the file must specify an allocation quantity (ALQ parameter).

You can also use SYS\$CREATE to open an existing file; if the file does not exist, it is created. The following example shows the required fields in the FAB for the conditional creation of a file:

```
GBLFAB: $FAB      FNM=<GLOBAL.TST>, -
                  ALQ=4, -
                  FAC=PUT, -
                  FOP=<UFO,CIF,CBT>, -
                  SHR=<PUT,UPI>
.
.
.
$CREATE FAB=GBLFAB
```

When the \$CREATE macro is invoked, it creates the file GLOBAL.TST if the file does not currently exist. The CBT (contiguous best try) option requests that, if possible, the file be contiguous. Although section files are not required to be contiguous, better performance can result if they are.

#### 13.5.6.3 Defining the Section Extents

After the file is opened successfully, SYS\$CRMPSC can create a section either from the entire file or from certain portions of it. The following arguments to SYS\$CRMPSC define the extents of the file that constitute the section:

- **pagcnt** (page count). This argument is required. It indicates the number of virtual blocks that will be mapped. These blocks correspond to pages in the section.
- **vbn** (virtual block number). This argument is optional. It defines the number of the virtual block in the file that is the beginning of the section. If you do not specify this argument, the value 1 is passed (the first virtual block in the file is the beginning of the section). If you have specified physical page frame number (PFN) mapping, the **vbn** argument specifies the starting PFN. The system does not allow you to specify a virtual block number outside of the file.

#### 13.5.6.4 Defining the Section Characteristics

The **flags** argument to SYS\$CRMPSC defines the following section characteristics:

- Whether it is a private section or a global section. The default is to create a private section.
- How the pages of the section are to be treated when they are copied into physical memory or when a process refers to them. The pages in a section can be either or both of the following:
  - Read/write or read-only
  - Created as demand-zero pages or as copy-on-reference pages, depending on how the processes are going to use the section and whether the file contains any data (see Section 13.5.6.10)
- Whether the section is to be mapped to a disk file or to specific physical page frames (see Section 13.5.6.15).

## Memory Management Services and Routines on OpenVMS VAX

### 13.5 Using System Services for Memory Allocation

Table 13–2 shows the flag bits that must be set for specific characteristics.

**Table 13–2 Flag Bits to Set for Specific Section Characteristics on VAX Systems**

Correct Flag Combinations	Section to Be Created				
	Private	Global	PFN Private	PFN Global	Shared Memory
SEC\$M_GBL	0	1	0	1	1
SEC\$M_CRF	Optional	Optional	0	0	0
SEC\$M_DZRO	Optional	Optional	0	0	Optional
SEC\$M_WRT	Optional	Optional	Optional	Optional	Optional
SEC\$M_PERM	Not used	Optional	Optional	1	1
SEC\$M_SYSGBL	Not used	Optional	Not used	Optional	Optional
SEC\$M_PFNMAP	0	0	1	1	0
SEC\$M_EXPREG	Optional	Optional	Optional	Optional	Optional
SEC\$M_PAGFIL	0	Optional	0	0	0

When you specify section characteristics, the following restrictions apply:

- Global sections cannot be both demand-zero and copy-on-reference.
- Demand-zero sections must be writable.
- Shared memory private sections are not allowed.

#### 13.5.6.5 Defining Global Section Characteristics

If the section is a global section, you must assign a character string name (**gsdnam** argument) to it so that other processes can identify it when they map it. The format of this character string name is explained in Section 13.5.6.6.

The **flags** argument specifies the following types of global sections:

- Group temporary (the default)
- Group permanent
- System temporary
- System permanent

Group global sections can be shared only by processes executing with the same group number. The name of a group global section is implicitly qualified by the group number of the process that created it. When other processes map it, their group numbers must match.

A temporary global section is automatically deleted when no processes are mapped to it, but a permanent global section remains in existence even when no processes are mapped to it. A permanent global section must be explicitly marked for deletion with the Delete Global Section (SYS\$DGBLSC) system service.

You need the user privileges PRMGBL and SYSGBL to create permanent group global sections or system global sections (temporary or permanent), respectively.

A system global section is available to all processes in the system.



## Memory Management Services and Routines on OpenVMS VAX

### 13.5 Using System Services for Memory Allocation

Optionally, a process creating a global section can specify a protection mask (**prot** argument), restricting all access or a type of access (read, write, execute, delete) to other processes.

#### 13.5.6.6 Global Section Name

The **gsdnam** argument specifies a descriptor that points to a character string.

Translation of the **gsdnam** argument proceeds in the following manner:

1. The current name string is prefixed with GBL\$ and the result is subject to logical name translation.
2. If the result is a logical name, step 1 is repeated until translation does not succeed or until the number of translations performed exceeds the number specified by the system parameter LNM\$C\_MAXDEPTH.
3. The GBL\$ prefix is stripped from the current name string that could not be translated. This current string is the name of the global section.

For example, assume that you have made the following logical name assignment:

```
$ DEFINE GBL$GSDATA GSDATA_001
```

Your program contains the following statements:

```
#include <descrip.h>
.
.
.
  $DESCRIPTOR(gsdnam, "GSDATA");
.
.
.
  status = sys$crmpsc(&gsdnam, . . . );
```

The following logical name translation takes place:

1. GBL\$ is prefixed to GSDATA.
2. GBL\$GSDATA is translated to GSDATA\_001. (Further translation is not successful. When logical name translation fails, the string is passed to the service.)

There are three exceptions to the logical name translation method discussed in this section:

- If the name string starts with an underscore (\_), the operating system strips the underscore and considers the resultant string to be the actual name (that is, further translation is not performed).
- If the name string is the result of a logical name translation, then the name string is checked to see whether it has the **terminal** attribute. If the name string is marked with the **terminal** attribute, the operating system considers the resultant string to be the actual name (that is, further translation is not performed).
- If the global section has a name in the format *name\_nnn*, the operating system first strips the underscore and the digits (*nnn*), then translates the resultant name according to the sequence discussed in this section, and finally reappends the underscore and digits. The system uses this method in conjunction with known images and shared files installed by the system manager.

## Memory Management Services and Routines on OpenVMS VAX

### 13.5 Using System Services for Memory Allocation

#### 13.5.6.7 Mapping Sections

When you call SYS\$CRMPSC to create or map a section, or both, you must provide the service with a range of virtual addresses (**inadr** argument) into which the section is to be mapped.

If you know specifically which pages the section should be mapped into, you provide these addresses in a 2-longword array. For example, to map a private section of 10 pages into virtual pages 10 through 19 of the program region, specify the input address array as follows:

```
unsigned int maorange[1];
maorange[0]= 0x1400; /* Address (hex) of page 10 */
maorange[1]= 0x2300; /* Address (hex) of page 19 */
```

You do not need to know the explicit addresses to provide an input address range. If you want the section mapped into the first available virtual address range in the program region (P0) or the control region (P1), you can specify the SEC\$M\_EXPREG flag bit in the **flags** argument. In this case, the addresses specified by the **inadr** argument control whether the service finds the first available space in P0 or P1. The value specified or defaulted for the **pagcnt** argument determines the number of pages mapped. The following example shows part of a program used to map a section at the current end of the program region:

```
unsigned int status, inadr[1], retadr[1], flags;
inadr[0]= 0x200; /* Any program (P0) region address */
inadr[1]= 0x200; /* Any P0 address (can be same) */
.
.
.
/* Address range returned in retadr */
flags = SEC$M_EXPREG;
status = sys$crmpsc(&inadr, &retadr, flags, ... );
```

The addresses specified do not have to be currently in the virtual address space of the process. SYS\$CRMPSC creates the required virtual address space during the mapping of the section. If you specify the **retadr** argument, the service returns the range of addresses actually mapped.

After a section is mapped successfully, the image can refer to the pages using one of the following:

- A base register or pointer and predefined symbolic offset names
- Labels defining offsets of an absolute program section or structure

The following example shows part of a program used to create and map a process section:

```
#include <rms.h>
#include <rmsdef.h>
#include <string.h>
#include <secdef.h>

struct FAB secfab;

main() {
    unsigned short chan;
    unsigned int status, inadr[1], retadr[1], pagcnt=1, flags;
    char *fn = "SECTION.TST";
```

## Memory Management Services and Routines on OpenVMS VAX

### 13.5 Using System Services for Memory Allocation

```
/* Initialize FAB fields */
    secfab = cc$rms_fab;
    secfab.fab$b_fac = FAB$M_PUT;
    secfab.fab$b_shr = FAB$M_SHRGET || FAB$V_SHRPUT || FAB$V_UPI;
    secfab.fab$l_fna = fn;
    secfab.fab$b_fns = strlen(fn);
    secfab.fab$l_fop = FAB$V_CIF;
    secfab.fab$b_rtv = -1;
/* Create a file if none exists */
    status = SYS$CREATE( &secfab, 0, 0 );
    if ((status & 1) != 1)
        LIB$SIGNAL( status );

    inadr[0] = X1400;
    inadr[1] = X2300;
    flags = SEC$M_WRT;
    chan = secfab.fab$l_stv;
    status = SYS$CRMPSC(&inadr, &retadr, 0, 0, 0, 0, flags, chan, pagcnt, 0, 0, 0);
    if ((status & 1) != 1)
        LIB$SIGNAL( status );
}
```

#### Notes on Example

1. The OPEN macro opens the section file defined in the file access block SECFAB. (The FOP parameter to the \$FAB macro must specify the UFO option.)
2. SYS\$CRMPSC uses the addresses specified at MAPRANGE to specify an input range of addresses into which the section will be mapped. The **pagcnt** argument requests that only 4 pages of the file be mapped.
3. The **flags** argument requests that the pages in the section have read/write access. The symbolic flag definitions for this argument are defined in the \$SECDEF macro. Note that the file access field (FAC parameter) in the FAB also indicates that the file is to be opened for writing.
4. When SYS\$CRMPSC completes, the addresses of the 4 pages that were mapped are returned in the output address array at RETRANGE. The address of the beginning of the section is placed in general register 6, which serves as a pointer to the section.

#### 13.5.6.8 Mapping Global Sections

A process that creates a global section can map that global section. Then other processes can map it by calling the Map Global Section (SYS\$MGBLSC) system service.

When a process maps a global section, it must specify the global section name assigned to the section when it was created, whether it is a group or system global section, and whether it wants read-only or read/write access. The process may also specify the following:

- A version identification (**ident** argument), indicating the version number of the global section (when multiple versions exist) and whether more recent versions are acceptable to the process.

## Memory Management Services and Routines on OpenVMS VAX

### 13.5 Using System Services for Memory Allocation

- A relative page number (**relpag** argument) that specifies the page number relative to the beginning of the section to begin mapping the section. In this way, processes can use only portions of a section. Additionally, a process can map a piece of a section into a particular address range and subsequently map a different piece of the section into the same virtual address range.

To specify that the global section being mapped is located in physical memory that is being shared by multiple processors, you can include the shared memory name in the **gsdnam** argument character string (see Section 13.5.6.6). A demand-zero global section in memory shared by multiple processors must be mapped when it is created.

Cooperating processes can issue a call to SYS\$CRMPSC to create and map the same global section. The first process to call the service actually creates the global section; subsequent attempts to create and map the section result only in mapping the section for the caller. The successful return status code SS\$\_CREATED indicates that the section did not already exist when the SYS\$CRMPSC system service was called. If the section did exist, the status code SS\$\_NORMAL is returned.

The example in Section 13.5.6.10 shows one process (ORION) creating a global section and a second process (CYGNUS) mapping the section.

#### 13.5.6.9 Global Page-File Sections

Global page-file sections are used to store temporary data in a global section. A global page-file section is a section of virtual memory that is not mapped to a file. The section can be deleted when processes have finished with it. (Contrast this to demand-zero pages, where initialization is not necessary but the pages are saved in a file.) The system parameter GBLPAGFIL controls the total number of global page-file pages in the system.

To create a global page-file section, you must set the flag bits SEC\$\_M\_GBL and SEC\$\_M\_PAGFIL in the **flags** argument to the Create and Map Section (SYS\$CRMPSC) system service. The channel (**chan** argument) must be 0.

You cannot specify the flag bit SEC\$\_M\_CRF with the flag bit SEC\$\_M\_PAGFIL.

#### 13.5.6.10 Section Paging

The first time an image executing in a process refers to a page that was created during the mapping of a disk file section, the page is copied into physical memory. The address of the page in the virtual address space of a process is mapped to the physical page. During the execution of the image, normal paging can occur; however, pages in sections are not written into the page file when they are paged out, as is the normal case. Rather, if they have been modified, they are written back into the section file on disk. The next time a page fault occurs for the page, the page is brought back from the section file.

If the pages in a section were defined as demand-zero pages or copy-on-reference pages when the section was created, the pages are treated differently, as follows:

- If the call to SYS\$CRMPSC requested that pages in the section be treated as demand-zero pages, these pages are initialized to zero when they are created in physical memory. If the file is either a new file being created as a section or a file being completely rewritten, demand-zero pages provide a convenient way of initializing the pages. The pages are paged back into the section file.
- When the virtual address space is deleted, all unreferenced pages are written back to the file as zeros. This causes the file to be initialized, no matter how few pages were modified.

## Memory Management Services and Routines on OpenVMS VAX

### 13.5 Using System Services for Memory Allocation

- If the call to SYS\$CRMPSC requested that pages in the section be copy-on-reference pages, each process that maps to the section receives its own copy of the section, on a page-by-page basis from the file, as it refers to them. These pages are never written back into the section file but are paged to the paging file as needed.

In the case of global sections, more than one process can be mapped to the same physical pages. If these pages need to be paged out or written back to the disk file defined as the section, these operations are done only when the pages are not in the working set of any process.

In the following example, process ORION creates a global section, and process CYGNUS maps to that section:

```
/* Process ORION */

#include <rms.h>
#include <rmsdef.h>
#include <string.h>
#include <secdef.h>
#include <descrip.h>

struct FAB gblfab;

main() {
    unsigned short chan;
    unsigned int status, flags, efn=65;
    char *fn = "SECTION.TST";
    $DESCRIPTOR(name, "FLAG_CLUSTER"); /* Common event flag cluster name */
    $DESCRIPTOR(gsdnam, "GLÖBAL_SECTION"); /* Global section name */

    ❶status = SYS$ASCEFC(efn, &name, 0);
    if ((status & 1) != 1)
        LIB$SIGNAL( status );

    /* Initialize FAB fields */

    gblfab = cc$rms_fab;
    gblfab.fab$l_alq = 4;
    gblfab.fab$b_fac = FAB$M_PUT;
    gblfab.fab$l_fnm = fn;
    gblfab.fab$l_fop = FAB$M_CIF | FABM$_CBT;

    .
    .
    .

    /* Create a file if none exists */

    ❷status = SYS$CREATE( &gblfab, 0, 0 );
    if ((status & 1) != 1)
        LIB$SIGNAL( status );

    flags = SEC$M_GBL || SEC$M_WRT;
    status = SYS$CRMPSC(0, 0, 0, flags, &gsdnam, . . . );
    if ((status & 1) != 1)
        LIB$SIGNAL( status );

    status = SYS$SETEF(efn);
    if ((status & 1) != 1)
        LIB$SIGNAL( status );

    .
    .
    .
}

/* Process CYGNUS */
```

## Memory Management Services and Routines on OpenVMS VAX

### 13.5 Using System Services for Memory Allocation

```
    unsigned int status, efn=65;
    $DESCRIPTOR(cluster,"FLAG_CLUSTER");
    $DESCRIPTOR(section,"GLOBAL_SECTION");
    .
    .
    .
    ③status = SYS$ASCEFC(efn, &cluster, 0);
        if ((status & 1) != 1)
            LIB$SIGNAL( status );

        status = SYS$WAITFR(efn);
        if ((status & 1) != 1)
            LIB$SIGNAL( status );

        status = SYS$MGBLSC(&inadr, &retadr, 0, flags, &section, 0, 0);
        if ((status & 1) != 1)
            LIB$SIGNAL( status );
    }
```

- ① The processes ORION and CYGNUS are in the same group. Each process first associates with a common event flag cluster named FLAG\_CLUSTER to use common event flags to synchronize its use of the section.
- ② The process ORION creates the global section named GLOBAL\_SECTION, specifying section flags that indicate that it is a global section (SEC\$M\_GBL) and has read/write access. Input and output address arrays, the page count parameter, and the channel number arguments are not shown; procedures for specifying them are the same, as shown in this example.
- ③ The process CYGNUS associates with the common event flag cluster and waits for the flag defined as FLGSET; ORION sets this flag when it has finished creating the section. To map the section, CYGNUS specifies the input and output address arrays, the flag indicating that it is a global section, and the global section name. The number of pages mapped is the same as that specified by the creator of the section.

#### 13.5.6.11 Reading and Writing Data Sections

Read/write sections provide a way for a process or cooperating processes to share data files in virtual memory.

The sharing of global sections may involve application-dependent synchronization techniques. For example, one process can create and map to a global section in read/write fashion; other processes can map to it in read-only fashion and interpret data written by the first process. Alternatively, two or more processes can write to the section concurrently. (In this case, the application must provide the necessary synchronization and protection.)

After a file is updated, the process or processes can release (or unmap) the section. The modified pages are then written back into the disk file defined as a section.

When this is done, the revision number of the file is incremented, and the version number of the file remains unchanged. A full directory listing indicates the revision number of the file and the date and time that the file was last updated.

## Memory Management Services and Routines on OpenVMS VAX

### 13.5 Using System Services for Memory Allocation

#### 13.5.6.12 Releasing and Deleting Sections

A process unmaps a section by deleting the virtual addresses in its own virtual address space to which it has mapped the section. If a return address range was specified to receive the virtual addresses of the mapped pages, this address range can be used as input to the Delete Virtual Address Space (SYS\$DELTVA) system service, as follows:

```
$DELTVA_S INADR=RETRANGE
```

When a process unmaps a private section, the section is deleted; that is, all control information maintained by the system is deleted. A temporary global section is deleted when all processes that have mapped to it have unmapped it. Permanent global sections are not deleted until they are specifically marked for deletion with the Delete Global Section (SYS\$DGBLSC) system service; they are then deleted when no more processes are mapped.

Note that deleting the pages occupied by a section does not delete the section file but rather cancels the process's association with the file. Moreover, when a process deletes pages mapped to a read/write section and no other processes are mapped to it, all modified pages are written back into the section file.

After a section is deleted, the channel assigned to it can be deassigned. The process that created the section can deassign the channel with the Deassign I/O Channel (SYS\$DASSGN) system service, as follows:

```
$DASSGN_S CHAN=GBLFAB+FAB$L_STV
```

#### 13.5.6.13 Writing Back Sections

Because read/write sections are not normally updated on disk until the physical pages they occupy are paged out or until all processes referring to the section have unmapped it, a process should ensure that all modified pages are successfully written back into the section file at regular intervals.

The Update Section File on Disk (SYS\$UPDSEC) system service writes the modified pages in a section into the disk file. SYS\$UPDSEC is described in the *OpenVMS System Services Reference Manual*.

#### 13.5.6.14 Image Sections

Global sections can contain shareable code. The operating system uses global sections to implement shareable code, as follows:

1. The object module containing code to be shared is linked to produce a shareable image. The shareable image is not, in itself, executable. It contains a series of sections called **image sections**.
2. You link private object modules with the shareable image to produce an executable image. No code or data from the shareable image is put into the executable image.
3. The system manager uses the INSTALL command to create a permanent global section from the shareable image file, making the image sections available for sharing.
4. When you run the executable image, the operating system automatically maps the global sections created by the INSTALL command into the virtual address space of your process.

## Memory Management Services and Routines on OpenVMS VAX

### 13.5 Using System Services for Memory Allocation

For details about how to create and identify shareable images and how to link them with private object modules, see the *OpenVMS Linker Utility Manual*. For information about how to install shareable images and make them available for sharing as global sections, see the *OpenVMS System Manager's Manual*.

#### 13.5.6.15 Page Frame Sections

A **page frame section** is one or more contiguous pages of physical memory or I/O space that have been mapped as a section. One use of page frame sections is to map to an I/O page, thus allowing a process to read device registers. A process mapped to an I/O page can also connect to a device interrupt vector.

A page frame section differs from a disk file section in that it is not associated with a particular disk file and is not paged. However, it is similar to a disk file section in most other respects: you create, map, and define the extent and characteristics of a page frame section in essentially the same manner as you do for a disk file section.

To create a page frame section, you must specify page frame number (PFN) mapping by setting the SEC\$M\_PFNMAP flag bit in the **flags** argument to the Create and Map Section (SYS\$CRMPSC) system service. The **vbn** argument is now used to specify that the first page frame is to be mapped instead of the first virtual block. You must have the user privilege PFNMAP to either create or delete a page frame section but not to map to an existing one.

Because a page frame section is not associated with a disk file, you do not use the **relpag**, **chan**, and **pfc** arguments to the SYS\$CRMPSC service to create or map this type of section. For the same reason, the SEC\$M\_CRF (copy-on-reference) and SEC\$M\_DZRO (demand-zero) bit settings in the **flags** argument do not apply. Pages in page frame sections are not written back to any disk file (including the paging file).

---

#### Caution

---

You must use caution when working with page frame sections. If you permit write access to the section, each process that writes to it does so at its own risk. Serious errors can occur if a process writes incorrect data or writes to the wrong page, especially if the page is also mapped by the system or by another process. Thus, any user who has the PFNMAP privilege can damage or violate the security of a system.

---



# Memory Management Services and Routines on OpenVMS VAX

## 13.5 Using System Services for Memory Allocation

### 13.5.7 Example of Using Memory Management System Services

In the following example, two programs are communicating through a global section. The first program creates and maps a global section (by using SYS\$CRMPSC) and then writes a device name to the section. This program also defines both the device terminal and process names and sets the event flags that synchronize the processes.

The second program maps the section (by using SYS\$MGBLSC) and then reads the device name and the process that allocated the device and any terminal allocated to that process. This program also writes the process named to the terminal global section where the process name can be read by the first program.

The common event cluster is used to synchronize access to the global section. The first program sets REQ\_FLAG to indicate that the device name is in the section. The second program sets INFO\_FLAG to indicate that the process and terminal names are available.

Data in a section must be page aligned. The following is the option file used at link time that causes the data in the common area named DATA to be page aligned:

```
PSECT_ATTR = DATA, PAGE
```

For high-level language usage, use the **solitary** attribute of the linker. See the *OpenVMS Linker Utility Manual* for an explanation of how to use the **solitary** attribute.

Before executing the first program, you need to write a user-open routine that sets the user open bit (FAB\$V\_UFO) of the FAB options longword (FAB\$L\_FOP). The user-open routine would then read the channel number that the file is opened on from the status longword (FAB\$L\_STV) and return that channel number to the main program by using a common block (CHANNEL in this example).

!This is the program that creates the global section.

```
! Define global section flags
INCLUDE '($SECDEF)'
! Mask for section flags
INTEGER SEC_MASK

! Logical unit number for section file
INTEGER INFO_LUN
! Channel number for section file
! (returned from useropen routine)
INTEGER SEC_CHAN
COMMON /CHANNEL/ SEC_CHAN
! Length for the section file
INTEGER SEC_LEN
! Data for the section file
CHARACTER*12 DEVICE,
2          PROCESS
CHARACTER*6  TERMINAL
COMMON /DATA/ DEVICE,
2          PROCESS,
2          TERMINAL
! Location of data
INTEGER PASS_ADDR (2),
2          RET_ADDR (2)
```

## Memory Management Services and Routines on OpenVMS VAX

### 13.5 Using System Services for Memory Allocation

```

! Two common event flags
INTEGER REQUEST_FLAG,
2     INFO_FLAG
DATA REQUEST_FLAG /70/
DATA INFO_FLAG /71/

! User-open routines
INTEGER UFO_CREATE
EXTERNAL UFO_CREATE
.
.
! Open the section file
STATUS = LIB$GET_LUN (INFO_LUN)
IF (.NOT. STATUS) CALL LIB$SIGNAL(%VAL(STATUS))
SEC_MASK = SEC$M_WRT .OR. SEC$M_DZRO .OR. SEC$M_GBL
! (Last element - first element + size of last element + 511)/512
SEC_LEN = ( (%LOC(TERMINAL) - %LOC(DEVICE) + 6 + 511)/512 )
OPEN (UNIT=INFO_LUN,
2     FILE='INFO.TMP',
2     STATUS='NEW',
2     INITIALSIZE = SEC_LEN,
2     USEROPEN = UFO_CREATE)
! Free logical unit number and map section
CLOSE (INFO_LUN)

! Get location of data
PASS_ADDR (1) = %LOC (DEVICE)
PASS_ADDR (2) = %LOC (TERMINAL)

STATUS = SYS$CRMPSC (PASS_ADDR, ! Address of section
2                 RET_ADDR, ! Addresses mapped
2                 ,
2                 %VAL(SEC_MASK), ! Section mask
2                 'GLOBAL_SEC', ! Section name
2                 ,
2                 %VAL(SEC_CHAN), ! I/O channel
2                 ,,,)
IF (.NOT. STATUS) CALL LIB$SIGNAL(%VAL(STATUS))

! Create the subprocess
STATUS = SYS$CREPRC (,
2                 'GETDEVINF', ! Image
2                 ,
2                 'GET_DEVICE', ! Process name
2                 %VAL(4),,,) ! Priority
IF (.NOT. STATUS) CALL LIB$SIGNAL(%VAL(STATUS))

! Write data to section
DEVICE = '$FLOPPY1'

! Get common event flag cluster and set flag
STATUS = SYS$ASCEFC (%VAL(REQUEST_FLAG),
2                 'CLUSTER',,,)
IF (.NOT. STATUS) CALL LIB$SIGNAL(%VAL(STATUS))
STATUS = SYS$SETEF (%VAL(REQUEST_FLAG))
IF (.NOT. STATUS) CALL LIB$SIGNAL(%VAL(STATUS))

! When GETDEVINF has the information, INFO_FLAG is set
STATUS = SYS$WAITFR (%VAL(INFO_FLAG))
IF (.NOT. STATUS) CALL LIB$SIGNAL(%VAL(STATUS))
.
.
.

! This is the program that maps to the global section
! created by the previous program.

```

## Memory Management Services and Routines on OpenVMS VAX

### 13.5 Using System Services for Memory Allocation

```

! Define section flags
INCLUDE '($SECDEF)'
! Mask for section flags
INTEGER SEC_MASK
! Data for the section file
CHARACTER*12 DEVICE,
2      PROCESS
CHARACTER*6  TERMINAL
COMMON /DATA/ DEVICE,
2      PROCESS,
2      TERMINAL

! Location of data
INTEGER PASS_ADDR (2),
2      RET_ADDR (2)

! Two common event flags
INTEGER REQUEST_FLAG,
2      INFO_FLAG
DATA REQUEST_FLAG /70/
DATA INFO_FLAG /71/
.
.
.
! Get common event flag cluster and wait
! for GBL1.FOR to set REQUEST_FLAG
STATUS = SYSSASCEFC (%VAL(REQUEST_FLAG),
2      'CLUSTER',,,)
IF (.NOT. STATUS) CALL LIB$SIGNAL (%VAL(STATUS))
STATUS = SYSSWAITFR (%VAL(REQUEST_FLAG))
IF (.NOT. STATUS) CALL LIB$SIGNAL (%VAL(STATUS))

! Get location of data
PASS_ADDR (1) = %LOC (DEVICE)
PASS_ADDR (2) = %LOC (TERMINAL)

! Set write flag
SEC_MASK = SEC$M_WRT

! Map the section
STATUS = SYS$MGBLSC (PASS_ADDR, ! Address of section
2      RET_ADDR, ! Address mapped
2      ,
2      %VAL(SEC_MASK), ! Section mask
2      'GLOBAL SEC',, ! Section name
IF (.NOT. STATUS) CALL LIB$SIGNAL (%VAL(STATUS))

! Call GETDVI to get the process ID of the
! process that allocated the device, then
! call GETJPI to get the process name and terminal
! name associated with that process ID.
! Set PROCESS equal to the process name and
! set TERMINAL equal to the terminal name.
.
.
.
! After information is in GLOBAL SEC
STATUS = SYS$SETEF (%VAL(INFO_FLAG))
IF (.NOT. STATUS) CALL LIB$SIGNAL (%VAL(STATUS))

END

```



---

## Using Run-Time Routines for Memory Allocation

This chapter describes the use of run-time routines (RTLs) to allocate and deallocate pages. It contains the following sections:

Section 14.1 describes the allocating and freeing of pages.

Section 14.2 describes the interactions with other RTL routines.

Section 14.3 describes the interactions with system services.

Section 14.4 describes how to use zones.

Section 14.5 describes the mechanism for allocating and freeing blocks of memory.

Section 14.6 describes the RTL algorithms used to allocate and free memory.

Section 14.7 describes how to create and manage user-defined zones.

Section 14.8 describes the methods of debugging programs that use virtual memory zones.

---

### Note

---

In this chapter, all references to *pages* include both the 512-byte page size on VAX systems and the 512-byte pagelet size on Alpha systems. See Chapter 13 and Chapter 12 for a discussion of page sizes on VAX and Alpha systems.

---

## 14.1 Allocating and Freeing Pages

The run-time library page management routines `LIB$GET_VM_PAGE` and `LIB$FREE_VM_PAGE` provide a flexible mechanism for allocating and freeing pages (pagelets on Alpha systems) of memory. In general, modular routines should use these routines rather than direct system service calls to manage memory. The page or pagelet management routines maintain a processwide pool of free pages or pagelets and automatically reuse free pages or pagelets. If your program calls system services directly, it must do the bookkeeping to keep track of free memory.

`LIB$GET_VM_PAGE` and `LIB$FREE_VM_PAGE` are fully reentrant. They can be called by code running at AST level or in an Ada multitasking environment.

Memory space allocated by `LIB$GET_VM_PAGE` are created with user-mode read-write access, even if the call to `LIB$GET_VM_PAGE` is made from a more privileged access mode.

## Using Run-Time Routines for Memory Allocation

### 14.1 Allocating and Freeing Pages

LIB\$GET\_VM\_PAGE and LIB\$FREE\_VM\_PAGE are designed for request sizes ranging from one page to a few hundred pages. If you are using very large request sizes of contiguous space in a single request, the bitmap allocation method that is used may cause fragmentation of your virtual address space because allocated pages are contiguous. For very large request sizes, use direct calls to SYS\$EXPREG and do not use LIB\$GET\_VM\_PAGE.

The format for LIB\$GET\_VM\_PAGE is as follows:

LIB\$GET\_VM\_PAGE (number-of-pages ,base-address)

With this routine, you need to specify only the number of pages you need in the **number-of-pages** argument. The routine returns the base address of the contiguous block of pages that have been allocated in the **base-address** argument.

The rules for using LIB\$GET\_VM\_PAGE and LIB\$FREE\_VM\_PAGE are as follows:

- Any memory you free by calling LIB\$FREE\_VM\_PAGE must have been allocated by a previous call to LIB\$GET\_VM\_PAGE. You cannot allocate memory by calling either SYS\$EXPREG or SYS\$CRETVA and then free it using LIB\$FREE\_VM\_PAGE.
- All memory allocated by LIB\$GET\_VM\_PAGE is page aligned; that is, the low-order 9 bits of the address are all zero. All memory freed by LIB\$FREE\_VM\_PAGE must also be page aligned; an error status is returned if you attempt to free a block of memory that is not page aligned.
- You can free a smaller group of pages than you allocated. That is, if you allocated a group of 4 contiguous pages by a single call to LIB\$GET\_VM\_PAGE, you can free the memory by using several calls to LIB\$FREE\_VM\_PAGE; for example, free 1 page, 2 pages, and 1 page.
- You can combine contiguous groups of pages that were allocated by several calls to LIB\$GET\_VM\_PAGE into one group of pages that are freed by a single call to LIB\$FREE\_VM\_PAGE. Before doing this, however, you must compare the addresses to ensure that the pages you are combining are indeed contiguous. Of course, you must ensure that a routine frees only pages that it has previously allocated and still owns.
- Be especially careful that you do not attempt to free a set of pages twice. You might free a set of pages in one routine and reallocate those same pages from another routine. If the first routine then deallocates those pages a second time, any information that the second routine stored in them is lost. Because the pages are still allocated to your program (even though to a different routine), this type of programming mistake does not generate an error.
- The contents of memory allocated by LIB\$GET\_VM\_PAGE are unpredictable. Your program must assign values to all locations that it uses.
- You should try to minimize the number of request sizes your program uses to avoid fragmentation of the free page pool. This concept is shown in Figure 14-1.

Figure 14–1 Memory Fragmentation

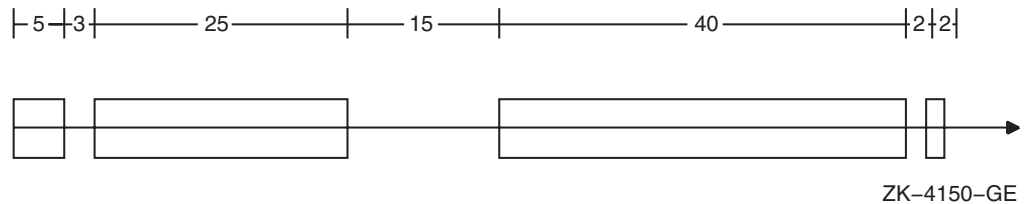

The straight line running across Figure 14–1 represents the memory allocated to your program. The blocks represent memory that has already been allocated. At this point, if you request 16 pages, memory will have to be allocated at the far right end of the memory line shown in this figure, even though there are 20 free pages before that point. You cannot use 16 of these 20 pages because the 20 free pages are “fragmented” into groups of 15, 3, and 2 pages.

Fragmentation is discussed further in Section 14.4.1.

## 14.2 Interactions with Other Run-Time Library Routines

Chapter 13 and Chapter 12 describe a three-level hierarchy of memory allocation routines consisting of the following:

1. Memory management system services
2. Run-time library page management routines `LIB$GET_VM_PAGE` and `LIB$FREE_VM_PAGE`
3. Run-time library heap management routines `LIB$GET_VM` and `LIB$FREE_VM`

The run-time library and various programming languages provide another level of more specialized allocation routines.

- The run-time library dynamic string package provides a set of routines for allocating and freeing dynamic strings. The set of routines includes the following:

```
LIB$SGET1_DD, LIB$SFREE1_DD  
LIB$SFREEN_DD  
STR$GET1_DX, STR$FREE1_DX
```

- VAX Ada provides allocators and the `UNCHECKED_DEALLOCATION` package for allocating and freeing memory.
- VAX Pascal provides the `NEW` and `DISPOSE` routines for allocating and freeing memory.
- VAX PL/I provides `ALLOCATE` and `FREE` statements for allocating and freeing memory.

A program containing routines written in several operating system languages may use a number of these facilities at the same time. This does not cause any problems or impose any restrictions on the user because all of these are layered on the run-time library heap management routines.

## Using Run-Time Routines for Memory Allocation

### 14.2 Interactions with Other Run-Time Library Routines

---

#### Note

---

To ensure correct operation, memory that is allocated by one of the higher-level allocators in the preceding list can be freed only by using the corresponding deallocation routine. That is, memory allocated by PASCAL NEW must be freed by calling PASCAL DISPOSE, and a dynamic string can be freed only by calling one of the string package deallocation routines.

---

### 14.3 Interactions with System Services

The run-time library page management and heap management routines are implemented as layers built on the memory management system services. In general, modular routines should use the run-time library routines rather than directly call memory management system services. However, in some situations you must use both. This section describes relationships between the run-time library and memory management. See the *OpenVMS System Services Reference Manual* for descriptions of the memory management system services.

You can use the Expand Region (SYS\$EXPREG) system service to create pages of virtual memory in the program region (P0 space) for your process. The operating system keeps track of the first free page address at the end of P0 space, and it updates this free page address whenever you call SYS\$EXPREG or SYS\$CRETVA. The LIB\$GET\_VM\_PAGE routine calls SYS\$EXPREG to create pages, so there is no conflicting address assignments when you call SYS\$EXPREG directly.

Avoid using the Create Virtual Address Space (SYS\$CRETVA) system service, because you must specify the range of virtual addresses when it is called. If the address range you specify contains pages that already exist, SYS\$CRETVA deletes those pages and recreates them as demand-zero pages. You may have difficulty avoiding conflicting address assignments if you use run-time library routines and SYS\$CRETVA.

You must not use the Contract Region (SYS\$CNTREG) system service, because other routines or the OpenVMS Record Management Services (RMS) may have allocated pages at the end of the program region.

You can change the protection on pages your program has allocated by calling the Set Protection (SYS\$SETPRT) system service. All pages allocated by LIB\$GET\_VM\_PAGE have user-mode read/write access. If you change protection on pages allocated by LIB\$GET\_VM\_PAGE, you must reset the protection to user-mode read/write before calling LIB\$FREE\_VM\_PAGE to free the pages.

You can use the Create and Map Section (SYS\$CRMPSC) system service to map a file into your virtual address space. To map a file, you provide a range of virtual addresses for the file. One way to do this is to specify the Expand Region option (SEC\$M\_EXPREG) when you call SYS\$CRMPSC. This method assigns addresses at the end of P0 space, similar to the SYS\$EXPREG system service. Alternatively, you can provide a specific range of virtual addresses when you call SYS\$CRMPSC; this is similar to allocating pages by calling SYS\$CRETVA. If you assign a specific range of addresses, you must avoid conflicts with other routines. One way to do this is to allocate memory by calling LIB\$GET\_VM\_PAGE and then use that memory to map the file.



## Using Run-Time Routines for Memory Allocation

### 14.3 Interactions with System Services

The complete sequence of steps is as follows:

1. Call `LIB$GET_VM_PAGE` to allocate a contiguous group of  $(n+1)$  pages. The first  $n$  pages are used to map the file; the last page serves as a guard page.
2. Call `SYS$CRMPSC` using the first  $n$  pages to map the file into your process address space.
3. Process the file.
4. Call `SYS$DELTVA` to delete the first  $n$  pages and unmap the file.
5. Call `SYS$CRETVA` to recreate the  $n$  pages of virtual address space as demand-zero pages.
6. Call `LIB$FREE_VM_PAGE` to free  $(n+1)$  pages of memory and return them to the processwide page pool.

This sequence is satisfactory when mapping small files of a few hundred pages, but it has severe limitations when mapping very large files. As discussed in Section 14.1, you should not use `LIB$GET_VM_PAGE` to allocate very large groups of contiguous pages in a single request. In addition, when you allocate memory by calling `LIB$GET_VM_PAGE` (and thus `SYS$EXPREG`), the pages are charged against your process page file quota. Your page file quota is not charged if you call `SYS$CRMPSC` with the `SEC$M_EXPREG` option.

You can process very large files using `SYS$CRMPSC` by first providing a pool of pages that is sufficient for your program and then by using `SYS$CRMPSC` and `SYS$DELTVA` to map and unmap the file. Use `LIB$SHOW_VM` to obtain an estimate of how much dynamically allocated memory your program requires; round this number up and allow for increased memory usage in the future. You can then use the memory estimate as follows:

1. At the beginning of your program, include code to call `LIB$GET_VM_PAGE` and allocate the estimated number of pages. You should not request a large number of pages in one call to `LIB$GET_VM_PAGE`, because this would require contiguous allocation of the pages.
2. Call `LIB$FREE_VM_PAGE` to free all the pages allocated in step 1; this establishes a pool of free pages for your program.
3. Open files that your program needs; note that RMS may allocate buffers in P0 space.
4. Call `SYS$CRMPSC` specifying `SEC$M_EXPREG` to map the file into your process address space at the end of P0 space.
5. Process the file.
6. Call `SYS$DELTVA`, specifying the address range to release the file. If additional pages were not created after you mapped the file, `SYS$DELTVA` contracts your address space. Your program can repeat the process of mapping a file without continually expanding its address space.

## Using Run-Time Routines for Memory Allocation

### 14.4 Zones

#### 14.4 Zones

The run-time library heap management routines `LIB$GET_VM` and `LIB$FREE_VM` are based on the concept of zones. A **zone** is a logically independent memory pool or subheap that you can control as one unit. A program may use several zones to structure its heap memory management. You might use a zone to:

- Store short-lived data structures that you can subsequently delete all at once
- Store a program that does not reference a wide range of addresses
- Specify a memory allocation algorithm specific to your program
- Specify attributes, like block size and alignment, specific to your program

You create a zone with specified attributes by calling the routine `LIB$CREATE_VM_ZONE`. `LIB$CREATE_VM_ZONE` returns a zone identifier value that you can use in subsequent calls to the routines `LIB$GET_VM` and `LIB$FREE_VM`. When you no longer need the zone, you can delete the zone and free all the memory it controls by a single call to `LIB$DELETE_VM_ZONE`.

The format for this routine is as follows:

```
LIB$CREATE_VM_ZONE zone_id [,algorithm] [,algorithm_arg] [,flags] [,extend_size]
                    [,initial_size] [,block_size] [,alignment] [,page_limit]
                    [,smallest-block-size] [,zone-name] [,get-page] [,free-page]
```

For more information about `LIB$CREATE_VM_ZONE`, refer to the *OpenVMS RTL Library (LIB\$) Manual*.

##### Allocating Address Space

Use the **algorithm** argument to specify how much space should be allocated—as a linked list of free blocks, as a set of lookaside list indexes by request size, as a set of lookaside lists for some block sizes, or as a single queue of free blocks.

##### Allocating Pages Within the Zone

Use the **initial\_size** argument to allocate a specified number of pages from the zone when it is created. After zone creation, you can use `LIB$GET_VM` to allocate space.

##### Specifying the Block Size

Use the **block\_size** argument to specify the block size in bytes.

##### Specifying Block Alignment

Use the **alignment** argument to specify the alignment for each block allocated in bytes.

Once a zone has been created and used, use `LIB$DELETE_VM_ZONE` to delete the zone and return the pages allocated to the processwide page pool. `LIB$RESET_VM_ZONE` frees pages for subsequent allocation but does not delete the zone or return the pages to the processwide page pool. Use `LIB$SHOW_VM_ZONE` to get information about a specific zone.

If you want a program to deal with each VM zone created during the invocation, including those created outside of the program, you can call `LIB$FIND_VM_ZONE`. At each call, `LIB$FIND_VM_ZONE` scans the heap management database and returns the zone identifier of the next valid zone.

## Using Run-Time Routines for Memory Allocation

### 14.4 Zones

`LIB$SHOW_VM_ZONE` returns formatted information about a specified zone, detailing such information as the zone's name, characteristics, and areas, and then passes the information to the specified or default action routine. `LIB$VERIFY_VM_ZONE` verifies the zone header and scans all of the queues and lists maintained in the zone header.

If you call `LIB$GET_VM` to allocate memory from a zone and the zone has no free memory to satisfy the request, `LIB$GET_VM` calls `LIB$GET_VM_PAGE` to allocate a block of contiguous pages for the zone. Each such block of contiguous pages is called an area. You control the number of pages in an area by specifying the area extension size attribute when you create the zone.

The systematic use of zones provides the following benefits:

- Structuring heap memory management

Data structures in your program may have different life spans or dynamic scopes. Some structures may continue to grow during the entire execution of your program, while others exist for a very short time and are then discarded by the program. You can create a separate zone in which you allocate a particular type of short-lived structure. When the program no longer needs any of those structures, you can delete all of them in a single operation by calling `LIB$DELETE_VM_ZONE`.
- Program locality

Program locality is a characteristic of a program that indicates the distance between the references and virtual memory over a period of time. A program with a high degree of program locality does not refer to many widely scattered virtual addresses in a short period of time. Maintaining a high degree of program locality reduces the number of page faults and improves program performance.

It is important to minimize the number of page faults to obtain best performance in a virtual memory system such as VAX and Alpha systems. For example, if your program creates and searches a symbol table, you can reduce the number of page faults incurred by the search operation by using as few pages as possible to hold all the symbol table entries. If you allocate symbol table entries and other items unrelated to the symbol table in the same zone, each page of the symbol table contains both symbol table entries and other items. Because of the extra unrelated entries, the symbol table takes up more pages than it actually needs. A search of the symbol table then accesses more pages, and performance is lower as a result. You may be able to reduce the number of page faults by creating a separate symbol table zone so that pages that contain symbol table entries do not contain any unrelated items.
- Specialized allocation algorithms

No single memory allocation algorithm is ideal for all applications. Section 14.6 describes the run-time library memory allocation algorithms and their performance characteristics so that you can select an appropriate algorithm for each zone that you create.
- Performance tuning

You can specify a number of attributes that affect performance when you create a zone. The allocation algorithm you select can have a significant effect on performance. By specifying the allocation block size, you can improve performance and reduce fragmentation within the zone at the cost of some extra memory. You can also use boundary tags to improve the speed of

## Using Run-Time Routines for Memory Allocation

### 14.4 Zones

LIB\$FREE\_VM at the cost of some extra memory. Boundary tags are further discussed in Section 14.4.1.

#### 14.4.1 Zone Attributes

You can specify a number of zone attributes when you call LIB\$CREATE\_VM\_ZONE to create the zone. The attributes that you specify are permanent; that is, you cannot change the attribute values. They remain constant until you delete the zone. Each zone that you create can have a different set of attribute values. Thus, you can tailor each zone to optimize program locality, execution time, and memory usage.

This section describes each of the zone attributes, suggested values for the attribute, and the effects of the attribute on execution time and memory usage. If you do not specify a complete set of attribute values, LIB\$CREATE\_VM\_ZONE provides defaults for many of the attributes. More detailed information about argument names and the encoding of arguments is given in the description of LIB\$CREATE\_VM\_ZONE in the *OpenVMS RTL Library (LIB\$) Manual*.

The zone attributes are as follows:

- Allocation algorithms

The run-time library heap management routines provide four algorithms to allocate and free memory and to manage blocks of free memory. The algorithms are listed here. (See Section 14.6 for more details.)

- The First Fit algorithm (LIB\$K\_VM\_FIRST\_FIT) maintains a linked list of free blocks, sorted in order of increasing memory address.
- The Quick Fit algorithm (LIB\$K\_VM\_QUICK\_FIT) maintains a set of lookaside lists indexed by request size for request sizes in a specified range. For request sizes that are not in the specified range, a First Fit list of free blocks is maintained by the heap management routines.
- The Frequent Sizes algorithm (LIB\$K\_VM\_FREQ\_SIZES) is similar to Quick Fit in that it maintains a set of lookaside lists for some block sizes. You specify the number of lists when you create the zone; the sizes associated with those lists are determined by the actual sizes of blocks that are freed.
- The Fixed Size algorithm (LIB\$K\_VM\_FIXED) maintains a single queue of free blocks.

- Boundary-tagged blocks

You can specify the use of boundary tags (LIB\$M\_VM\_BOUNDARY\_TAGS) with any of the algorithms that handle variable-sized blocks. The algorithms that handle variable-sized blocks are First Fit, Quick Fit, and Frequent Sizes.

If you specify boundary tags, LIB\$GET\_VM appends two additional longwords to each block that you allocate. LIB\$FREE\_VM uses these tags to speed up the process of merging adjacent free blocks on the First Fit free list. Using the standard First Fit insertion and merge, the execution time and number of page faults to free a block are proportional to the number of items on the list; freeing  $n$  blocks takes time proportional to  $n$  squared. When boundary tags are used, LIB\$FREE\_VM does not have to keep the free list in sorted order. This reduces the time and the number of page faults for freeing one block to a constant value that is independent of the number of free blocks. By using boundary tags, you can improve execution time at the cost of some additional memory for the tags.

## Using Run-Time Routines for Memory Allocation 14.4 Zones

The use of boundary tags can have a significant effect on execution time if *all* of the following three conditions are present:

- You are using the First Fit algorithm.
- There are many calls to `LIB$FREE_VM`.
- The free list is long.

Boundary tags do not improve execution time if you are using Quick Fit or Frequent Sizes and if all the blocks being freed use one of the lookaside lists. Merging or searching is not done for free blocks on a lookaside list.

The boundary tags specify the length of each block that is allocated, so you do not need to specify the length of a tagged block when you free it. This reduces the bookkeeping that your program must perform. Figure 14–2 shows the placement of boundary tags.

**Figure 14–2 Boundary Tags**

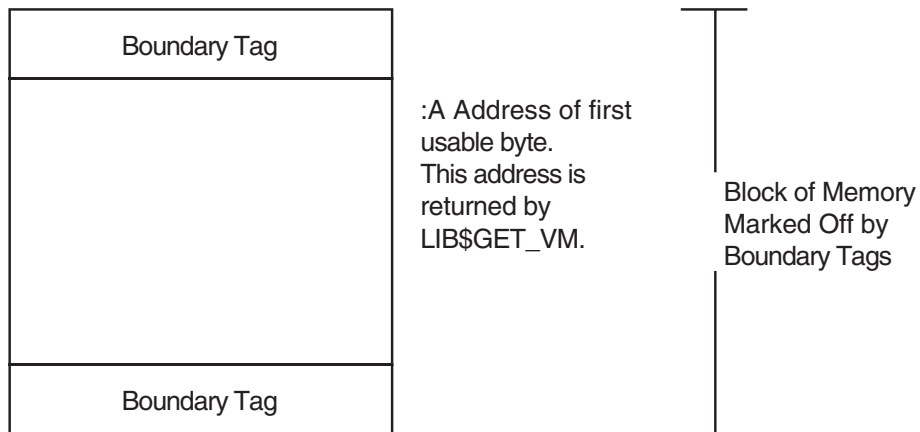

ZK-4149-GE

Boundary tags are not visible to the calling program. The request size you specify when calling `LIB$GET_VM` is the number of usable bytes your program needs. The address returned by `LIB$GET_VM` is the address of the first usable byte of the block, and this same address is used when you call `LIB$FREE_VM`.

- **Area extension size**

Pages of memory are allocated to a zone in contiguous groups called areas. By specifying area extension parameters for the zone, you can tailor the zone to achieve a satisfactory balance between locality, memory usage, and execution time for allocating pages. If you specify a large area size, you improve locality for blocks in the zone, but you may waste a large amount of virtual memory. Pages can be allocated to an area of a zone, but the memory might never be used to satisfy a `LIB$GET_VM` allocation request. If you specify a small area extension size, you reduce the number of pages used, but you may reduce locality and you increase the amount of overhead for area control blocks.

## Using Run-Time Routines for Memory Allocation

### 14.4 Zones

You can specify two area extension size values: an initial size and an extend size. If you specify an initial area size, that number of pages is allocated to the zone when you create the zone. If you do not specify an initial size, no pages are allocated until the first call to `LIB$GET_VM` that references the zone. When an allocation request cannot be satisfied by blocks from the free list or from memory in any of the areas owned by the zone, a new area is added to the zone. The size of this area is the maximum of the area extend size and the current request size. The extend size does not limit the size of blocks you can allocate. If you do not specify extend size when you create the zone, a default of 16 pages is used.

Choose a few area extension sizes, and use them throughout your program. It is also desirable to choose extension sizes that are multiples of each other. Memory for areas is allocated by calling `LIB$GET_VM_PAGE`. You should choose the area extension sizes in order to minimize fragmentation. Software supplied by Compaq uses extension sizes that are a power of 2.

Also consider the overhead for area control blocks when choosing the area extension parameters. Each area control block is 64 bytes long. Table 14–1 shows the overhead for various extension sizes.

**Table 14–1 Overhead for Area Control Blocks**

Area Size (Pages)	Overhead Percentage
1	12.5%
2	6.3%
4	3.1%
16	0.8%
128	0.1%

You can also control the way in which zones are extended by using the `LIB$M_VM_EXTEND_AREA` attribute. This attribute specifies that when new pages are allocated for a zone, they should be appended to an existing area if the pages are adjacent to an existing area.

- Block size

The block size attribute specifies the number of bytes in the basic allocation quantum for the zone.

All allocation requests are rounded up to a multiple of the block size.

The block size must be a power of 2 in the range of 8 to 512. Table 14–2 lists the possible block sizes.

**Table 14–2 Possible Values for the Block Size Attribute**

Block Size (Power of 2)	Actual Block Size
$2^3$	8
$2^4$	16
$2^5$	32

(continued on next page)

**Table 14–2 (Cont.) Possible Values for the Block Size Attribute**

Block Size (Power of 2)	Actual Block Size
2 <sup>6</sup>	64
2 <sup>7</sup>	128
2 <sup>8</sup>	256
2 <sup>9</sup>	512

By adjusting the block size, you can control the effects of internal fragmentation and external fragmentation. Internal fragmentation occurs when the request size is rounded up and more bytes are allocated than are required to satisfy the request. External fragmentation occurs when there are many small blocks on the free list, but none of them is large enough to satisfy an allocation request.

If you do not specify a value for block size, a default of 8 bytes is used.

- **Alignment**

The alignment attribute specifies the required address boundary alignment for each block allocated. The alignment value must be a power of 2 in the range of 4 to 512.

The block size and alignment values are closely related. If you are not using boundary-tagged blocks, the larger value of block size and alignment controls both the block size and alignment. If you are using boundary-tagged blocks, you can minimize the overhead for the boundary tags by specifying a block size of 8 and an alignment of 4 (longword alignment).

On VAX systems, note that the VAX interlocked queue instructions require quadword alignment, so you should not specify longword alignment for blocks that will be inserted on an interlocked queue.

If you do not specify an alignment value, a default of 8 is used (alignment on a quadword boundary).

- **Page limit**

You can specify the maximum number of pages that can be allocated to the zone. If you do not specify a limit, the only limit is the virtual address limit for the total process imposed by process quotas and system parameters.

- **Fill on allocate**

If you do not specify the allocation fill attribute, LIB\$GET\_VM does not initialize the contents of the blocks of memory that it supplies. The contents of the memory are unpredictable, and you must assign a value to each location your program uses.

In many applications, it is convenient to initialize every byte of dynamically allocated memory to the value 0. You can request that LIB\$GET\_VM do this initialization by specifying the allocation fill attribute LIB\$M\_VM\_GET\_FILL0 when you create the zone.

If your program does not use the allocation fill attribute, it may be very difficult to locate bugs where the program does not properly initialize dynamically allocated memory. As a debugging aid, you can request that LIB\$GET\_VM initialize every byte to FF (hexadecimal) by specifying the allocation fill attribute LIB\$M\_VM\_GET\_FILL1 when you create the zone.

## Using Run-Time Routines for Memory Allocation

### 14.4 Zones

- Fill on free

In complex programs using heap storage, it can be very difficult to locate bugs where the program frees a block of memory but continues to make references to that block of memory. As a debugging aid, you can request that `LIB$FREE_VM` write bytes containing 0 or FF (hexadecimal) into each block of memory when it is freed; specify one of the attributes `LIB$M_VM_FREE_FILL0` or `LIB$M_VM_FREE_FILL1`.

#### 14.4.2 Default Zone

The run-time library provides a default zone that is used if you do not specify a **zone-id** argument when you call either `LIB$GET_VM` or `LIB$FREE_VM`. The default zone provides compatibility with earlier versions of `LIB$GET_VM` and `LIB$FREE_VM`, which did not support multiple zones.

Programs that do not place heavy demands on heap storage can simply use the default zone for all heap storage allocation. They do not need to call `LIB$CREATE_VM_ZONE` and `LIB$DELETE_VM_ZONE`, and they can omit the **zone-id** argument when calling `LIB$GET_VM` and `LIB$FREE_VM`. The **zone-id** for the default zone has the value 0.

The default zone has the values shown in Table 14–3.

**Table 14–3 Attribute Values for the Default Zone**

Attribute	Value
Algorithm	First Fit
Area extension size	128 pages
Block size	8 bytes
Alignment	Quadword boundary
Boundary tags	No boundary tags
Page limit	No limit
Fill on allocate	No fill on allocate
Fill on free	No fill on free

#### 14.4.3 Zone Identification

A zone is a logically independent memory pool or subheap. You can create zones by calling either `LIB$CREATE_VM_ZONE` or `LIB$CREATE_USER_VM_ZONE`. These routines return as an output argument a unique 32-bit zone identifier (**zone-id**) that is used in subsequent routine calls where a zone identification is needed.

You can specify the **zone-id** argument as an optional argument when you call `LIB$GET_VM` to allocate a block of memory. If you do specify **zone-id** when you allocate memory, you must specify the same **zone-id** value when you call `LIB$FREE_VM` to free the memory. `LIB$FREE_VM` returns an error status if you do not provide the correct value for **zone-id**.

Modular routines that allocate and free heap storage must use zone identifications in a consistent fashion. You can use one of several approaches in designing a set of modular routines to ensure consistency in using zone identifications:

- Each routine that allocates or frees heap storage has a **zone-id** argument so the caller can specify the zone to be used.



## Using Run-Time Routines for Memory Allocation

### 14.4 Zones

- The modular routine package provides `ALLOCATE` and `FREE` routines for each type of dynamically allocated object. These routines keep track of zone identifications in an implicit argument, in static storage, or in the dynamically allocated objects. The caller need not be concerned with the details of zone identifications.
- By convention, the set of modular routines could do all allocate and free operations in the default zone.

The zone identifier for the default zone has the value 0 (see Section 14.4.2 for more information on the default zone). You can allocate and free blocks of memory in the default zone by either specifying a **zone-id** value of 0 or by omitting the **zone-id** argument when you call `LIB$GET_VM` and `LIB$FREE_VM`. You cannot use `LIB$DELETE_VM_ZONE` or `LIB$RESET_VM_ZONE` on the default zone; these routines return an error status if the value for **zone-id** is 0.

#### 14.4.4 Creating a Zone

The `LIB$CREATE_VM_ZONE` routine creates a new zone and sets zone attributes according to arguments that you supply. `LIB$CREATE_VM_ZONE` returns a **zone-id** value for the new zone that you use in subsequent calls to `LIB$GET_VM`, `LIB$FREE_VM`, and `LIB$DELETE_VM_ZONE`.

#### 14.4.5 Deleting a Zone

The `LIB$DELETE_VM_ZONE` routine deletes a zone and returns all pages owned by the zone to the processwide page pool managed by `LIB$GET_VM_PAGE`. Your program must not perform any more operations on the zone after you call `LIB$DELETE_VM_ZONE`.

It takes less execution time to free memory in a single operation by calling `LIB$DELETE_VM_ZONE` than to account individually for and free every block of memory that was allocated by calling `LIB$GET_VM`. Of course, you must be sure that your program is no longer using the zone or any of the memory in the zone before you call `LIB$DELETE_VM_ZONE`.

If you have specified deallocation filling, `LIB$DELETE_VM_ZONE` fills all of the allocated blocks that are freed.

#### 14.4.6 Resetting a Zone

The `LIB$RESET_VM_ZONE` routine frees all the blocks of memory that were previously allocated from the zone. The memory becomes available to satisfy further allocation requests for the zone; the memory is not returned to the processwide page pool managed by `LIB$GET_VM_PAGE`. Your program can continue to use the zone after you call `LIB$RESET_VM_ZONE`.

It takes less execution time to free memory in a single operation by calling `LIB$RESET_VM_ZONE` than to account individually for and free every block of memory that was allocated by calling `LIB$GET_VM`. Of course, you must be sure that your program is no longer using any of the memory in the zone before you call `LIB$RESET_VM_ZONE`.

If you have specified deallocation filling, `LIB$RESET_VM_ZONE` fills all of the allocated blocks that are freed.

Because `LIB$RESET_VM_ZONE` does not return any pages to the processwide page pool, you should reset a zone only if you expect to reallocate almost all of the memory that is currently owned by the zone. If the next cycle of reallocation

## Using Run-Time Routines for Memory Allocation

### 14.4 Zones

may use much less memory, it is better to delete the zone (with `LIB$DELETE_VM_ZONE`) and create it again (with `LIB$CREATE_VM_ZONE`).

### 14.5 Allocating and Freeing Blocks

The run-time library heap management routines `LIB$GET_VM` and `LIB$FREE_VM` provide the mechanism for allocating and freeing blocks of memory.

The `LIB$GET_VM` and `LIB$FREE_VM` routines are fully reentrant, so they can be called either by code running at AST level or in an Ada multitasking environment. Several threads of execution can be allocating or freeing memory simultaneously either in the same zone or in different zones.

All memory allocated by `LIB$GET_VM` has user-mode read/write access, even if the call to `LIB$GET_VM` is made from a more privileged access mode.

The rules for using `LIB$GET_VM` and `LIB$FREE_VM` are as follows:

- Any memory you free by calling `LIB$FREE_VM` must have been allocated by a previous call to `LIB$GET_VM`. You cannot allocate memory by calling `SYS$EXPREG` or `SYS$CRETVA` and then free it using `LIB$FREE_VM`.
- When you free a block of memory by calling `LIB$FREE_VM`, you must use the same **zone-id** value as when you called `LIB$GET_VM` to allocate the block. If the block was allocated from the default zone, you must either specify a **zone-id** value of 0 or omit the **zone-id** argument when you call `LIB$FREE_VM`.
- You cannot free part of a block that was allocated by a call to `LIB$GET_VM`; the whole block must be freed by a single call to `LIB$FREE_VM`.
- You cannot combine contiguous blocks of memory that were allocated by several calls to `LIB$GET_VM` into one larger block that is freed by a single call to `LIB$FREE_VM`.
- All memory allocated by `LIB$GET_VM` is aligned according to the alignment attribute for the zone; all memory freed by `LIB$FREE_VM` must have the correct alignment for the zone. An error status is returned if you attempt to free a block that is not aligned properly.

### 14.6 Allocation Algorithms

The run-time library heap management routines provide four algorithms, listed in Table 14–4, that are used to allocate and free memory and that are used to manage blocks of free memory.

**Table 14–4 Allocation Algorithms**

Code	Symbol	Description
1	<code>LIB\$K_VM_FIRST_FIT</code>	First Fit
2	<code>LIB\$K_VM_QUICK_FIT</code>	Quick Fit (maintains lookaside list)
3	<code>LIB\$K_VM_FREQ_SIZES</code>	Frequent Sizes (maintains lookaside list)
4	<code>LIB\$K_VM_FIXED</code>	Fixed Size Blocks

The Quick Fit and Frequent Sizes algorithms use lookaside lists to speed allocation and freeing for certain request sizes. A lookaside list is the software

## Using Run-Time Routines for Memory Allocation

### 14.6 Allocation Algorithms

analog of a hardware cache. It takes less time to allocate or free a block that is on a lookaside list.

For each of the algorithms, `LIB$GET_VM` performs one or more of the following operations:

- Tries to allocate a block from an appropriate lookaside list.
- Scans the list of areas owned by the zone. For each area, it tries to allocate a block from the free list and then tries to allocate a block from the block of unallocated memory at the end of the area.
- Adds a new area to the zone and allocates the block from that area.

For each of the algorithms, `LIB$FREE_VM` performs one or more of the following operations:

- Places the block on a lookaside list associated with the zone if there is an appropriate list.
- Locates the area that contains the block. If the zone has boundary tags, the tags encode the area; otherwise, it scans the list of areas owned by the zone to find the correct area.
- Inserts the block on the area free list and checks for merges with adjacent free blocks.

If the zone has boundary tags, `LIB$FREE_VM` checks the tags of adjacent blocks; if a merge does not occur, it inserts the block at the tail of the free list.

If the zone does not have boundary tags, `LIB$FREE_VM` scans the sorted free list to find the correct insertion point. It also checks the preceding and following blocks for merges.

#### 14.6.1 First Fit Algorithm

The First Fit algorithm (`LIB$K_VM_FIRST_FIT`) maintains a linked list of free blocks. If the zone does not have boundary tags, the free list is kept sorted in order of increasing memory address. An allocation request is satisfied by the first block on the free list that is large enough; if the first free block is larger than the request size, it is split and the fragment is kept on the free list. When a block is freed, it is inserted in the free list at the appropriate point; adjacent free blocks are merged to form larger free blocks.

#### 14.6.2 Quick Fit Algorithm

The Quick Fit algorithm (`LIB$K_VM_QUICK_FIT`) maintains a set of lookaside lists indexed by request size for request sizes in a specified range. For request sizes that are not in the specified range, a First Fit list of free blocks is maintained. An allocation request is satisfied by removing a block from the appropriate lookaside list; if the lookaside list is empty, a First Fit allocation is done. When a block is freed, it is placed on either a lookaside list or the First Fit list according to its size.

Free blocks that are placed on a lookaside list are neither merged with adjacent free blocks nor split to satisfy a request for a smaller block.

## Using Run-Time Routines for Memory Allocation

### 14.6 Allocation Algorithms

#### 14.6.3 Frequent Sizes Algorithm

The Frequent Sizes algorithm (`LIB$K_VM_FREQ_SIZES`) is similar to the Quick Fit algorithm in that it maintains a set of lookaside lists for some block sizes. You specify the number of lookaside lists when you create the zone; the sizes associated with those lists are determined by the actual sizes of blocks that are freed. An allocation request is satisfied by searching the lookaside lists for a matching size; if no match is found, a First Fit allocation is done. When a block is freed, the block is placed on a lookaside list with a matching size, on an empty lookaside list, or on the First Fit list if no lookaside list is available. As with the Quick Fit algorithm, free blocks on lookaside lists are not merged or split.

#### 14.6.4 Fixed Size Algorithm

The Fixed Size algorithm (`LIB$K_VM_FIXED`) maintains a single queue of free blocks. There is no First Fit free list, and splitting or merging of blocks does not occur.

### 14.7 User-Defined Zones

When you create a zone by calling `LIB$CREATE_VM_ZONE`, you must select an allocation algorithm from the fixed set provided by the run-time library. You can tailor the characteristics of the zone by specifying various zone attributes. User-defined zones provide additional flexibility and control by letting you supply routines for the allocation and deallocation algorithms.

You create a user-defined zone by calling `LIB$CREATE_USER_VM_ZONE`. Instead of supplying values for a fixed set of zone attributes, you provide routines that perform the following operations for the zone:

- Allocate a block of memory
- Free a block of memory
- Reset the zone
- Delete the zone

Each time that one of the run-time library heap management routines (`LIB$GET_VM`, `LIB$FREE_VM`, `LIB$RESET_VM_ZONE`, `LIB$DELETE_VM_ZONE`) is called to perform an operation on a user-defined zone, the corresponding routine that you specified is called to perform the actual operation. You need not make any changes in the calling program to use user-defined zones; their use is transparent.

You do not need to provide routines for all four of the preceding operations if you know that your program will not perform certain operations. If you omit some of the operations and your program attempts to use them, an error status is returned.

Applications of user-defined zones include the following:

- You can provide your own specialized allocation algorithms. These algorithms can in turn invoke `LIB$GET_VM`, `LIB$GET_VM_PAGE`, `SYS$EXPREG`, or other system services.
- You can use a user-defined zone to monitor memory allocation operations. Example 14–1 shows a monitoring program that prints a record of each call to either allocate or free memory in a zone.

## Using Run-Time Routines for Memory Allocation 14.7 User-Defined Zones

### Example 14–1 Monitoring Heap Operations with a User-Defined Zone

```
C+
C This is the main program that creates a zone and exercises it.
C
C Note that the main program simply calls LIB$GET_VM and LIB$FREE_VM.
C It contains no special coding for user-defined zones.
C-

        PROGRAM MAIN
        IMPLICIT INTEGER(A-Z)

        CALL MAKE_ZONE(ZONE)

        CALL LIB$GET_VM(10, I1, ZONE)
        CALL LIB$GET_VM(20, I2, ZONE)
        CALL LIB$FREE_VM(10, I1, ZONE)
        CALL LIB$RESET_VM_ZONE(ZONE)
        CALL LIB$DELETE_VM_ZONE(ZONE)
        END

C+
C This is the subroutine that creates a user-defined zone for monitoring.
C Each GET, FREE, or RESET prints a line of output on the terminal.
C Errors are signaled.
C-

        SUBROUTINE MAKE_ZONE(ZONE)
        IMPLICIT INTEGER (A-Z)
        EXTERNAL GET_RTN, FREE_RTN, RESET_RTN, LIB$DELETE_VM_ZONE

C+
C Create the primary zone. The primary zone supports
C the actual allocation and freeing of memory.
C-

        STATUS = LIB$CREATE_VM_ZONE(REAL_ZONE)
        IF (.NOT. STATUS) CALL LIB$SIGNAL(%VAL(STATUS))

C+
C Create a user-defined zone that monitors operations on REAL_ZONE.
C-

        STATUS = LIB$CREATE_USER_VM_ZONE(USER_ZONE, REAL_ZONE,
1          GET_RTN,
1          FREE_RTN,
1          RESET_RTN,
1          LIB$DELETE_VM_ZONE)
        IF (.NOT. STATUS) CALL LIB$SIGNAL(%VAL(STATUS))

C+
C Return the zone-id of the user-defined zone to the caller to use.
C-

        ZONE = USER_ZONE
        END

C+
C GET routine for user-defined zone.
C-

        FUNCTION GET_RTN(SIZE, ADDR, ZONE)
        IMPLICIT INTEGER(A-Z)

        STATUS = LIB$GET_VM(SIZE, ADDR, ZONE)
```

(continued on next page)

## Using Run-Time Routines for Memory Allocation

### 14.7 User-Defined Zones

#### Example 14–1 (Cont.) Monitoring Heap Operations with a User-Defined Zone

```
        IF (.NOT. STATUS) THEN
            CALL LIB$SIGNAL(%VAL(STATUS))
        ELSE
            TYPE 10, SIZE, ADDR
10         FORMAT(' Allocated ',I4,' bytes at ',Z8)
        ENDIF
        GET_RTN = STATUS
    END
```

```
C+
C FREE routine for user-defined zone.
C-
```

```
        FUNCTION FREE_RTN(SIZE, ADDR, ZONE)
            IMPLICIT INTEGER(A-Z)

            STATUS = LIB$FREE_VM(SIZE, ADDR, ZONE)
            IF (.NOT. STATUS) THEN
                CALL LIB$SIGNAL(%VAL(STATUS))
            ELSE
                TYPE 20, SIZE, ADDR
20         FORMAT(' Freed ',I4,' bytes at ',Z8)
            ENDIF
            FREE_RTN = STATUS
        END
```

```
C+
C RESET routine for user-defined zone.
C-
```

```
        FUNCTION RESET_RTN(ZONE)
            IMPLICIT INTEGER(A-Z)

            STATUS = LIB$RESET_VM_ZONE(ZONE)
            IF (.NOT. STATUS) THEN
                CALL LIB$SIGNAL(%VAL(STATUS))
            ELSE
                TYPE 30, ZONE
30         FORMAT(' Reset zone at ', Z8)
            ENDIF
            RESET_RTN = STATUS
        END
```

## 14.8 Debugging Programs That Use Virtual Memory Zones

This section discusses some methods and aids for debugging programs that use virtual memory zones. Note that this information is implementation dependent and may change at any time.

The following list offers some suggestions for discovering and tracking problems with memory zone usage:

- Run the program with both free-fill-zero and free-fill-one set. The results from both executions of the program should be the same. If the results differ, this could mean that you are referencing a zone that is already deallocated. It could also mean that, after deallocating a zone, you created a new zone at the same location, so that you now have two pointers pointing to the same zone.
- Call LIB\$FIND\_VM\_ZONE at image termination. If a virtual memory zone is not deleted, LIB\$FIND\_VM\_ZONE returns its zone identifier.
- Use LIB\$SHOW\_VM\_ZONE and LIB\$VERIFY\_VM\_ZONE to print zone information and check for errors in the internal data structures. LIB\$SHOW\_VM\_ZONE allows you to determine whether any linkage pointers for the virtual memory zones are corrupted. LIB\$VERIFY\_VM\_ZONE allows you to request verification of the contents of the free blocks, so that if you call LIB\$VERIFY\_VM\_ZONE with free-fill set, you can determine whether you are writing to any deallocated zones.
- For zones created with the Fixed Size, Quick Fit, or Frequent Size algorithms, some types of errors cannot be detected. For example, in a zone that implements the Fixed Size algorithm (or in a Quick Fit or Frequent Size algorithm when the block is cached on a lookaside list), freeing a block more than once returns SS\$\_NORMAL, but the internal data structures are invalid. In this case, change the algorithm to First Fit. The First Fit algorithm checks whether you are freeing a block that is already on the free list and, if so, returns the error LIB\$\_BADBLOADR.





---

# Alignment on OpenVMS Alpha and VAX Systems

This chapter describes the importance and techniques of alignment for both OpenVMS VAX and OpenVMS Alpha systems.<sup>1</sup> It contains the following subsections:

Section 15.1 describes alignment on OpenVMS VAX and OpenVMS Alpha systems.

Section 15.2 describes using compilers for alignment.

Section 15.3 describes using various tools to uncover unaligned data.

## 15.1 Alignment

Alignment is an aspect of a data item that refers to its placement in memory. The mixing of byte, word, longword, and quadword data types can lead to data that is not aligned on natural boundaries. A naturally aligned datum of size  $2^*N$  is stored in memory at a starting byte address that is a multiple of  $2^*N$ , that is, an address that has  $N$  low-order zero bits. Data is naturally aligned when its address is an integral multiple of the size of the data in bytes (for example, when the following occurs):

- A byte is aligned at any address.
- A word is aligned at any address that is a multiple of 2.
- A longword is aligned at any address that is a multiple of 4.
- A quadword is aligned at any address that is a multiple of 8.

Data that is not aligned is referred to as unaligned. Throughout this chapter, the term aligned is used instead of naturally aligned.

Table 15–1 shows examples of common data sizes, their alignment, the number of zero bits in an aligned address for that data, and a sample aligned address in hexadecimal.

---

<sup>1</sup> Reprinted from an article in the March/April 1993 issue of *Digital Systems Journal*, Volume 15, Number 2, titled "Alpha AXP(TM) Migration: Understanding Data Alignment on OpenVMS AXP Systems" by Eric M. LaFranchi and Kathleen D. Morse. Copyright 1993 by Cardinal Business Media, Inc., 101 Witmer Road, Horsham, PA 19044.

# Alignment on OpenVMS Alpha and VAX Systems

## 15.1 Alignment

**Table 15–1 Aligned Data Sizes**

Data Size	Alignment	Zero Bits	Aligned Address Example
Byte	Byte	0	10001, 10002, 10003, 10004
Word	Word	1	10002, 10004, 10006, 10008
Longword	Longword	2	10004, 10008, 1000C, 10010
Quadword	Quadword	4	10008, 10010, 10018, 10020

An aligned structure has all its members aligned. An unaligned structure has one or more unaligned members. Figure 15–1 shows examples of aligned and unaligned structures.

**Figure 15–1 Aligned and Unaligned Structures**

Aligned Structure:

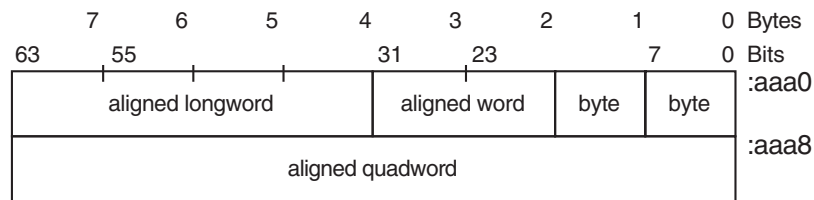

Unaligned Structure:

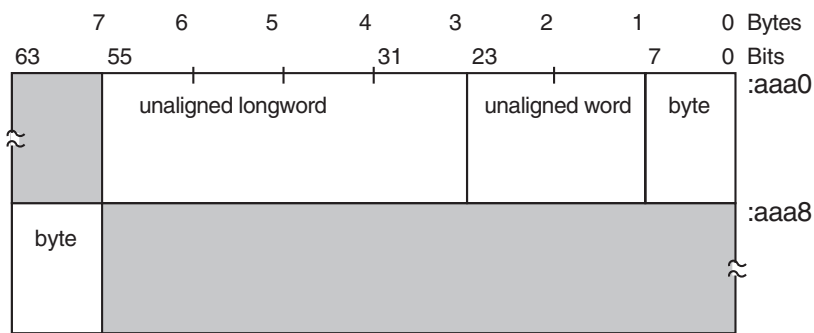

☐ = unaligned quadword

ZK-6999A-GE

### 15.1.1 Alignment and Performance

To achieve optimal performance, use aligned instruction sequence references and naturally aligned data. When unaligned data is referenced, more overhead is required than when referencing aligned data. This condition is true for both OpenVMS VAX and Alpha systems. On both VAX and Alpha systems, data need not be aligned to obtain correct processing results. Alignment is a concern for performance, not program correctness. Because natural alignment is not always possible, both OpenVMS VAX and Alpha systems provide help to manage the impact of unaligned data references.

## Alignment on OpenVMS Alpha and VAX Systems

### 15.1 Alignment

Although alignment is not required on VAX systems for stack, data, or instruction stream references, Alpha systems require that the stack and instructions be longword aligned.

#### 15.1.1.1 Alignment on OpenVMS VAX (VAX Only)

On VAX systems, memory references that are not longword aligned result in a transparent performance degradation. The full effect of unaligned memory references is hidden by microcode, which detects the unaligned reference and generates a microtrap to handle the alignment correction. This fix of alignment is done entirely in microcode. Aligned references, on the other hand, avoid the microtraps to handle fixes. Even with this microcode fix, an unaligned reference can take up to four times longer than an aligned reference.

#### 15.1.1.2 Alignment on OpenVMS Alpha (Alpha Only)

On Alpha systems, you can check and correct alignment the following three ways:

- Allow privileged architecture library code (PALcode) to fix the alignment faults for you.
- Use directives to the compiler.
- Fix the data yourself to make sure data is aligned.

Though Alpha systems do not use microcode to automatically handle unaligned references, PALcode traps the faults and corrects unaligned references as the data is processed. If you use the shorter load/store instruction sequences and your data is unaligned, then you incur an alignment fault PALcode fixup. The use of PALcode to correct alignment faults results in the slowest of the three ways to process your data.

By using directives to the compiler, you can tell your compiler to create a safe set of instructions. If it is unaligned, the compiler uses a set of unaligned load/store instructions. These unaligned load/store instructions are called safe sequences because they never generate unaligned data exceptions. Code sequences that use the unaligned load/store instructions are longer than the aligned load/store instruction sequences. By using unaligned load/store instructions and longer instruction sequences, you can obtain the desired results without incurring an alignment trap. This technique allows you to avoid the significant performance impact of a trap and subsequent data fixes.

By fixing the data yourself so that it is aligned, you can use a short instruction stream. This results in the fastest way to process your data. When aligning data, the following recommendations are suggested:

- If references to the data must be made atomic, then the data *must* be aligned. Otherwise, an unaligned fault causes a fatal reserved operand fault in this case.
- If you fix alignment problems in public interfaces, then you could break existing programs.

To detect unaligned reference information, you can use utilities such as the OpenVMS Debugger and Performance and Coverage Analyzer (PCA). You can also use the OpenVMS Alpha handler to generate optional informational exceptions for process space references. This allows condition handlers to track unaligned references. Alignment fault system services allow you to enable and disable the delivery of these informational exceptions. Section 15.3.3 discusses system services that you can use to report both image and systemwide alignment problems.

## Alignment on OpenVMS Alpha and VAX Systems

### 15.2 Using Compilers for Alignment (Alpha Only)

## 15.2 Using Compilers for Alignment (Alpha Only)

On Alpha systems, compilers automatically align data by default. If alignment problems are not resolved, they are at least flagged. The following sections present how the compilers for Compaq C, BLISS, Compaq Fortran, and MACRO-32 deal with alignment.

### 15.2.1 The Compaq C Compiler (Alpha Only)

On Alpha systems, the Compaq C compiler naturally aligns all explicitly declared data, including the elements of data structures. The pragmas **member\_alignment** and **nomember\_alignment** allow data structures to be aligned or packed (putting the next piece of data on the next byte boundary) in the same manner as the VAX C compiler. Additional pragmas of **member\_alignment save** and **member\_alignment restore** exist to save and restore the state of member alignment. These prevent alignment assumptions in one include file from affecting other source code. The following program examples show the use of these pragmas:

```
#pragma member_alignment save ❶
#pragma nomember_alignment ❷

struct
{
    char byte;
    short word;
    long longword;
} mystruct;
#pragma member_alignment restore ❸
```

- ❶ Saves the current alignment setting.
- ❷ Sets **nomember\_alignment**, which means that the data is to be packed in the structure mystruct.
- ❸ Resets the alignment setting for the code that follows.

The base alignment of a data structure is set to be the alignment of the largest member in the structure. If the largest element of a data structure is a longword, for example, then the base alignment of the data structure is longword alignment.

The **malloc()** function of the Compaq C Run-Time Library retrieves pointers that are at least quadword aligned. Because it is the exception rather than the rule to encounter unaligned data in C programs, the compiler assumes most data references are aligned. Pointers, for example, are always assumed to be aligned; only data structures declared with the pragma **nomember\_alignment** are assumed to contain unaligned data. If the Compaq C compiler believes the data might be unaligned, it generates the safe instruction sequences; that is, it uses the unaligned load/store instructions. Also, you can use the **/WARNING=ALIGNMENT** compiler qualifier to turn on alignment checking by the compiler. This results in a compiler warning for unaligned data references.

## Alignment on OpenVMS Alpha and VAX Systems

### 15.2 Using Compilers for Alignment (Alpha Only)

#### 15.2.1.1 Compiler Example of Memory Structure of VAX C and Compaq C

The following code examples, and Figure 15–2, and Figure 15–3 illustrate a C data structure containing byte, word, and longword data and how it would be laid out in memory by VAX C and Compaq C.

```
struct
{
  char byte;
  short word;
  long longword;
}mystruct;
```

On VAX systems, when compiled using the VAX C compiler, the previous structure has a memory layout as shown in Figure 15–2, where each piece of data begins on the next byte boundary.

**Figure 15–2 Alignment Using VAX C Compiler**

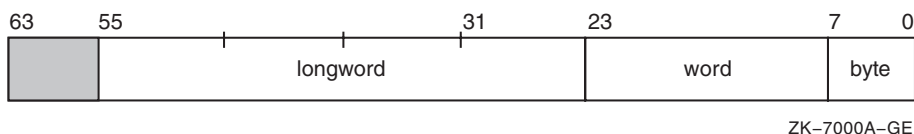

On Alpha systems, when compiled using the Compaq C compiler, the structure is padded to achieve natural alignment, if needed, as shown in Figure 15–3.

**Figure 15–3 Alignment Using Compaq C Compiler**

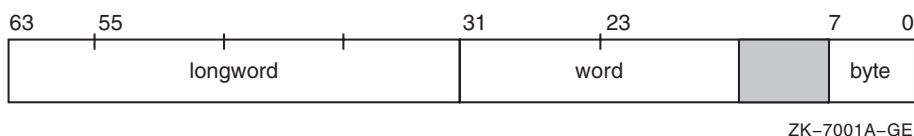

On Alpha systems, note where Compaq C places some padding to align naturally all the data structure elements. Compaq C would also align the structure itself on a longword boundary. The Compaq C compiler aligns the structure on a longword boundary because the largest element in the structure is a longword.

#### 15.2.2 The BLISS Compiler

On Alpha systems, the BLISS compiler provides greater control over alignment than the Compaq C compiler. The BLISS compiler also makes different assumptions about alignment.

Compaq does not ship the BLISS compiler on Alpha systems.

The Alpha BLISS compiler, like the VAX BLISS compiler, allows explicit specification of program section (PSECT) alignment.

On Alpha systems, BLISS compilers align all explicitly declared data on naturally aligned boundaries.

On Alpha systems, you can align declared data in BLISS source code with the **align** attribute, although the alignment specified cannot be greater than that for the PSECT in which the data is contained. The alignment attribute indicates a specific address boundary by means of a boundary value, N, which specifies that the binary address of the data segment must end in at least N zeros. To specify

## Alignment on OpenVMS Alpha and VAX Systems

### 15.2 Using Compilers for Alignment (Alpha Only)

the static byte datum A to be aligned on a longword boundary, for example, use the following declaration:

```
OWN  
A:BYTE ALIGN(2)
```

On Alpha systems, when the BLISS compiler cannot determine the base alignment of a BLOCK, it assumes full word alignment, unless told otherwise by a command qualifier or switch declaration. Like the Compaq C compiler, if the BLISS compilers believe that the data is unaligned, they generate safe instruction sequences. If you specify the qualifier /CHECK=ALIGNMENT in the BLISS command line, then warning information is provided when they detect unaligned memory references.

#### 15.2.3 The Compaq Fortran Compiler (Alpha Only)

On Alpha systems, the defaults for the Compaq Fortran compiler emphasize compatibility and standards conformance. Normal data declarations (data declared outside of COMMON block statements) are aligned on natural boundaries by default. COMMON block statement data is not aligned by default, which conforms to the FORTRAN-77 and FORTRAN-90 standards.

The qualifier /ALIGN=(COMMON=STANDARD) causes COMMON block data to be longword aligned. This adheres with the FORTRAN-77 and FORTRAN-90 standards, which state that the compiler is not allowed to put padding between INTEGER\*4 and REAL\*8 data. This can cause REAL\*8 data to be unaligned. To correct this, apply the NATURAL rule; for instance, apply /ALIGN=(COMMON=NATURAL to get natural alignment up to quadwords and the best performance, though this does not conform to standards.

To pack COMMON block and RECORD statement data, specify /ALIGN=NONE. The qualifier /ALIGN=NONE is equivalent to /NOALIGN, /ALIGN=PACKED, or /ALIGN=(COMMON=PACKED,RECORD=PACKED. To pack just RECORD statement data, specify /ALIGN=(RECORD=PACKED).

Besides command line qualifiers, Compaq Fortran provides two directives to control the alignment of RECORD statement data and COMMON block data. The **CDEC\$OPTIONS** directive controls whether the Compaq Fortran compiler naturally aligns fields in RECORD statements or data items in COMMON blocks for performance reasons, or whether the compiler packs those fields and data items together on arbitrary byte boundaries. The **CDEC\$OPTIONS** directive, like the /ALIGN command qualifier, takes class and rule parameters. Also, the **CDEC\$OPTIONS** directive overrides the compiler option /ALIGN.

By default, the Compaq Fortran compiler emits alignment warnings, but these can be turned off by using the qualifier /WARNINGS=NOALIGNMENT.

#### 15.2.4 The MACRO-32 Compiler (Alpha Only)

On Alpha systems, as with the C, BLISS, and Compaq Fortran languages, unaligned data references in MACRO-32 code work correctly, though they perform slower than aligned references. The MACRO-32 language provides you with direct control over alignment. There is no implicit padding for alignment done by the MACRO-32 compiler; data remains at the alignment you specify.

The MACRO-32 compiler recognizes the alignment of all locally declared data and flags all references to declared data that is unaligned. By default, the MACRO-32 compiler assumes that addresses in registers used as base pointers are longword aligned at routine entry.

## Alignment on OpenVMS Alpha and VAX Systems

### 15.2 Using Compilers for Alignment (Alpha Only)

For the **MOVQ** instruction, the compiler assumes that the base address is longword aligned, unless the compiler determines by its register-tracking logic that the address can not be longword aligned. Only longword alignment is tracked; quadword register alignment is not tracked. If you use the OpenVMS Alpha **MOVQ** instruction, the data must be quadword aligned, because the compiler does not translate it into unaligned loads.

External data is data that is not contained in the current source being compiled. External data is assumed to be longword aligned by the MACRO-32 compiler. The compiler detects and flags unaligned global label references. This enables you to locate external data that is not aligned.

To preserve atomicity, the compiler assumes that the data is longword aligned. Unaligned data causes a trap and voids the atomicity. Therefore, you must ensure that such data is aligned.

To fix unaligned data references, the easiest way is for you to align the data, if possible. If you cannot align the data, the data address can be moved into a register and then the register declared as unaligned. When you compile with **/UNALIGNED**, you tell the compiler to treat all data references as unaligned and to generate safe unaligned sequences. You can also use the **.SET\_REGISTERS** directive, which affects data references only for the specified registers for a section of code.

The **.PSECT** and **.ALIGN** directives are supported. The compiler knows the alignment of locally declared data. The compiler makes certain assumptions about the alignment, but does allow programmer control over those assumptions. The MACRO-32 compiler provides two directives for changing the compiler's assumptions about alignment, which results in letting the compiler produce more efficient code. These two directives are as follows:

- **.SET\_REGISTERS** allows you to specify whether a register points to aligned or unaligned data. You use this directive when the result of an operation is the opposite of what the compiler expects. Also, use the same directive to declare registers that the compiler would not otherwise detect as input or output registers.

For example, consider the **DIVL** instruction. After executing this instruction in the following example, the MACRO-32 compiler assumes that R1 is unaligned. A future attempt at using R1 as a base register will cause the compiler to generate an unaligned fetch sequence. However, suppose you know that R1 is always aligned after the **DIVL** instruction. You can then use the **.SET\_REGISTERS** directive to inform the compiler of this. When the compiler sees the **MOVL** from 8(r1), it knows that it can use the shorter aligned fetch (LDL) to retrieve the data. At run time, however, if R1 is not really aligned, then this results in an alignment trap. The following example shows the setting of a register to be aligned:

```
divl   r0,r1           ;Compiler now thinks R1 unaligned
.set_registers aligned=r1
movl   8(r1),r2       ;Compiler now treats R1 as aligned
```

- **.SYMBOL\_ALIGNMENT** allows you to specify the alignment of any memory reference that uses a symbolic offset. The **.SYMBOL\_ALIGNMENT** directive associates an alignment attribute with a symbol definition used as a register offset; you can use it when you know the base register will be aligned for every use of the symbolic offset. This attribute guarantees to the compiler

## Alignment on OpenVMS Alpha and VAX Systems

### 15.2 Using Compilers for Alignment (Alpha Only)

that the base register has that alignment, and this enables the compiler to generate optimal code.

In the example that follows, **QUAD\_OFF** has a symbol alignment of **QUAD**, **LONG\_OFF**, a symbol alignment of **LONG**, and **NONE\_OFF** has no symbol alignment. In the first **MOVL** instruction, the compiler assumes that R0, since it is used as a base register with **QUAD\_OFF**, is quadword aligned. Since **QUAD\_OFF** has a value of 4, the compiler knows it can generate an aligned longword fetch. For the second **MOVL**, R0 is assumed to be longword aligned, but since **LONG\_OFF** has a value of 5, the compiler realizes that offset+ base is not longword aligned and would generate a safe unaligned fetch sequence. In the third **MOVL**, R0 is assumed to be unaligned, unless the compiler knows otherwise from other register tracking, and would generate a safe unaligned sequence. The **.SYMBOL\_ALIGNMENT** alignment remains in effect until the next occurrence of the directive.

```
.symbol alignment QUAD
quad_off=4
.symbol alignment LONG
long_off=5
.symbol alignment NONE
none_off=6

movl quad_off(r0),r1 ;Assumes R0 quadword aligned
movl long_off(r0),r2 ;Assumes R0 longword aligned
movl none_off(r0),r3 ;No presumed alignment for R0
```

#### 15.2.5 The VAX Environment Software Translator—VEST (Alpha Only)

On Alpha systems, the DECmigrate for OpenVMS Alpha VAX Environment Software Translator (VEST) utility is a tool that translates binary OpenVMS VAX image files into OpenVMS Alpha image files. Image files are also called executable files. Though it is similar to compiler, VEST is for binaries instead of sources.

VEST deals with alignment in two different modes: pessimistic and optimistic. VEST is optimistic by default; but whether optimistic or pessimistic, the alignment of program counter (PC) relative data is known at translation time, and the appropriate instruction sequence can be generated.

In pessimistic mode, all non PC-relative references are treated as unaligned using the safe access sequences. In optimistic mode, the emulated VAX registers (R0–R14) are assumed to be quadword aligned upon entry to each basic block. Autoincrement and autodecrement changes to the base registers are tracked. The offset plus the base register alignment are used to determine the alignment and the appropriate access sequence is generated.

The **/OPTIMIZE=NOALIGN** qualifier on the VEST command tells VEST to be pessimistic; it assumes that base registers are not aligned, and should generate the safe instruction sequence. Doing this can slow execution speed by a factor of two or more, if there are no unaligned data references. On the other hand, it can result in a performance gain if there are a significant number of unaligned references, since safe sequences avoid any unaligned data traps.

Additional controls preserve atomicity in longword data that is not naturally aligned. Wherever possible, data should be aligned in the VAX source code and the image rebuilt before translating the image with DECmigrate. This results in better performance on both VAX and Alpha systems.



## 15.3 Using Tools for Finding Unaligned Data

Tools that aid the uncovering of unaligned data include the OpenVMS Debugger, Performance and Coverage Analyzer (PCA), and eight system services. These tools are discussed in the following sections.

### 15.3.1 The OpenVMS Debugger

By using the OpenVMS Debugger, you can turn on and off unaligned data exception breakpoints by using the commands SET BREAK/UNALIGNED\_DATA and CANCEL BREAK/UNALIGNED\_DATA. These commands must be used with the SET BREAK/EXCEPTION command. When the debugger breaks at the unaligned data exception, the context is like any other exception. You can examine the program counter (PC), processor status (PS), and virtual address of the unaligned data exception. Example 15-1 shows the output from the debugger using the SET OUTPUT LOG command of a simple program.

#### Example 15-1 OpenVMS Debugger Output from SET OUTPUT LOG Command

```
#include <stdio.h>
#include <stdlib.h>

main( )
{
    char *p;
    long *lp;

    /* malloc returns at least quadword aligned pointer */
    p = (char *)malloc( 32 );

    /* construct unaligned longword pointer and place into lp */
    lp = (long *)((char *)(p+1));

    /* load data into unaligned longword */
    lp[0] = 123456;

    printf( "data - %d\n", lp[0] );
    return;
}

----- Compile and Link commands -----
$ cc/debug debug_example
$ link/debug debug_example
$ run debug_example
----- DEBUG session using set output log -----
Go
! break at routine DEBUG EXAMPLE\main
!   598:          p --(char *)malloc( 32 );
set break/unaligned_data
set break/exception
set radix hexadecimal
Go
!Unaligned data access: virtual address - 003CEEA1, PC - 00020048
!break on unaligned data trap preceding DEBUG EXAMPLE\main\%LINE 602
!   602:          printf( "data - %d\n", lp[0] );
ex/inst 00020048-4
!DEBUG_EXAMPLE\main\%LINE 600+4:          STL          R1,(R0)
ex r0
!DEBUG_EXAMPLE\main\%R0: 00000000 003CEEA1
```

## Alignment on OpenVMS Alpha and VAX Systems

### 15.3 Using Tools for Finding Unaligned Data

#### 15.3.2 The Performance and Coverage Analyzer—PCA

The PCA allows you to detect and fix performance problems. Because unaligned data handling can significantly increase overhead, PCA has the capability to collect and present information on aligned data exceptions. PCA commands that collect and display unaligned data exceptions are:

- SET UNALIGNED\_DATA
- PLOT/UNALIGNED\_DATA PROGRAM BY LINE

Also, PCA can display data according to the PC of the fault, or by the virtual address of the unaligned data.

#### 15.3.3 System Services (Alpha Only)

On Alpha systems, there are eight system services to help locate unaligned data. The first three system services establish temporary image reporting; the next two provide process-permanent reporting, and the last three provide for system alignment fault tracking. The symbols used in calling all eight of these system services are located in \$AFRDEF in the OpenVMS Alpha MACRO-32 library, SYS\$LIBRARY:STARLET.MLB. You can also call these system services in C with #include <afndef.h>.

The first three system services can be used together; they report on the currently executing image. They are as follows:

- SYS\$START\_ALIGN\_FAULT\_REPORT. This service enables unaligned data exception for the current image. You can use either a buffered or an exception method of reporting, but you can enable only one method at a time.
  - Buffered method. This method requires that the buffer address and size be specified. You use the SYS\$GET\_ALIGN\_FAULT\_DATA service to retrieve buffered alignment data under program control.
  - Exception method. This method requires no buffer. Unaligned data exceptions are signaled to the image, at which point a user-written condition handler takes whatever action is desired. If no user-written handler is set up, then an informational exception message is broadcast for each unaligned data trap, and the program continues to execute.
- SYS\$STOP\_ALIGN\_FAULT\_REPORT. This service cancels unaligned data exception reporting for the current image if it were previously enabled. If you do not explicitly call this routine, then reporting is disabled by the operating systems' image rundown logic.
- SYS\$GET\_ALIGN\_FAULT\_DATA. This service retrieves the accumulated, buffered alignment data when using the buffered collection method.

You can use two of the eight system services to report unaligned data exceptions for the current process. The two services are as follows:

- SYS\$PERM\_REPORT\_ALIGN\_FAULT. This service enables unaligned data exception reporting for the process. Once you enable this service, the reporting remains in effect for the process until you explicitly disable it. Once enabled, the SS\$\_ALIGN condition is signaled for all unaligned data exceptions while the process is active. By default, if no user-written exception handler handles the condition, this results in an information display message for each unaligned data exception.

## Alignment on OpenVMS Alpha and VAX Systems

### 15.3 Using Tools for Finding Unaligned Data

This service provides a convenient way of running a number of images without modifying the code in each image, and also of recording the unaligned data exception behavior of each image.

- `SY$PERM_DIS_ALIGN_FAULT_REPORT`. This service disables unaligned data exception reporting for the process.

The three system services that allow you to track systemwide alignment faults are as follows:

- `SY$INIT_SYS_ALIGN_FAULT_REPORT`. This service initializes system process alignment fault reporting.
- `SY$STOP_SYS_ALIGN_FAULT_REPORT`. This service disables systemwide alignment fault reporting.
- `SY$GET_SYS_ALIGN_FAULT_DATA`. This service obtains data from the system alignment fault buffer.

These services require `CMKRNL` privilege. Alignment faults for all modes and all addresses can be reported using these services. The user can also set up masks to report only certain types of alignment faults. For example, you can get reports on only kernel modes, only user PC, or only data in system space.



---

## Memory Management with VLM Features

OpenVMS Alpha very large memory (VLM) features for memory management provide extended support for database, data warehouse, and other very large database (VLDB) products. The VLM features enable database products and data warehousing applications to realize increased capacity and performance gains.

By using the extended VLM features, application programs can create large in-memory global data caches that do not require an increase in process quotas. These large memory-resident global sections can be mapped with shared global pages to dramatically reduce the system overhead required to map large amounts of memory.

This chapter describes the following OpenVMS Alpha memory management VLM features:

- Memory-resident global sections
- Fast I/O and buffer objects for global sections
- Shared page tables
- Expandable global page table
- Reserved memory registry

To see an example program that demonstrates many of these VLM features, refer to Appendix C.

### 16.1 Overview of VLM Features

**Memory-resident global sections** allow a database server to keep larger amounts of *hot* data cached in physical memory. The database server then accesses the data directly from physical memory without performing I/O read operations from the database files on disk. With faster access to the data in physical memory, runtime performance increases dramatically.

**Fast I/O** reduces CPU costs per I/O request, which increases the performance of database operations. Fast I/O requires data to be locked in memory through **buffer objects**. In prior versions of OpenVMS Alpha, buffer objects could be created only for process-private virtual address space. As of OpenVMS Alpha 7.2, buffer objects can be created for global pages, including pages in memory-resident sections.

**Shared page tables** allow that same database server to reduce the amount of physical memory consumed within the system. Because multiple server processes share the same physical page tables that map the large database cache, an OpenVMS Alpha system can support more server processes. This increases overall system capacity and decreases response time to client requests.

## Memory Management with VLM Features

### 16.1 Overview of VLM Features

Shared page tables dramatically reduce the database server startup time because server processes can map memory-resident global sections hundreds of times faster than traditional global sections. With a multiple gigabyte global database cache, the server startup performance gains can be significant.

The system parameters **GBLPAGES** and **GBLPAGFIL** are dynamic parameters. Users with the CMKRNL privilege can now change these parameter values on a running system. Increasing the value of the GBLPAGES parameter allows the global page table to expand, on demand, up to the new maximum size.

The **Reserved Memory Registry** supports memory-resident global sections and shared page tables. Through its interface within the SYSMAN utility, the Reserved Memory Registry allows an OpenVMS system to be configured with large amounts of memory set aside for use within memory-resident sections or other privileged code. The Reserved Memory Registry also allows an OpenVMS system to be properly tuned through AUTOGEN, thus accounting for the pre-allocated reserved memory. For information about using the reserved memory registry, see the *OpenVMS System Manager's Manual*.

### 16.2 Memory-Resident Global Sections

Memory-resident global sections are non-file-backed global sections. This means that the pages within a memory-resident global section are not backed by the pagefile or by any other file on disk. Thus, no pagefile quota is charged to any process or charged to the system. When a process maps to a memory-resident global section and references the pages, working set list entries are not created for the pages. No working set quota is charged to the process.

Pages within a memory-resident global demand zero (DZRO) section initially have zero contents.

Creating a memory-resident global DZRO section is performed by calling either the SYS\$CREATE\_GDZRO system service or the SYS\$CRMPSC\_GDZRO\_64 system service.

Mapping to a memory-resident global DZRO section is performed by calling either the SYS\$CRMPSC\_GDZRO\_64 system service or the SYS\$MGBLSC\_64 system service.

To create a memory-resident global section, the process must have been granted the VMS\$MEM\_RESIDENT\_USER rights identifier. Mapping to a memory-resident global section does not require this right identifier.

Two options are available when creating a memory-resident global DZRO section:

- Fault option: allocate pages only when virtual addresses are referenced.
- Allocate option: allocate all pages when section is created.

#### **Fault option**

To use the fault option, it is recommended, but not required that the pages within the memory-resident global section be deducted from the system's fluid page count through the Reserved Memory Registry.

Using the Reserved Memory Registry ensures that AUTOGEN tunes the system properly to exclude memory-resident global section pages in its calculation of the system's fluid page count. AUTOGEN sizes the system pagefile, number of processes, and working set maximum size based on the system's fluid page count.

## Memory Management with VLM Features

### 16.2 Memory-Resident Global Sections

If the memory-resident global section has not been registered through the Reserved Memory Registry, the system service call fails if there are not enough fluid pages left in the system to accommodate the memory-resident global section.

If the memory-resident global section has been registered through the Reserved Memory Registry, the system service call fails if the size of the global section exceeds the size of reserved memory and there are not enough fluid pages left in the system to accommodate the additional pages.

If memory has been reserved using the Reserved Memory Registry, that memory must be used for the global section named in the SYSMAN command. To return the memory to the system, SYSMAN can be run to *free* the reserved memory, thus returning the pages back into the system's count of fluid pages.

If the name of the memory-resident global section is not known at boot time, or if a large amount of memory is to be configured out of the system's pool of fluid memory, entries in the Reserved Memory Registry can be added and the system can be retuned with AUTOGEN. After the system re-boots, the reserved memory can be *freed* for use by any application in the system with the VMS\$MEM\_RESIDENT\_USER rights identifier. This technique increases the availability of fluid memory for use within memory-resident global sections without committing to which applications or named global sections will receive the reserved memory.

#### Allocate option

To use the allocate option, the memory must be pre-allocated during system initialization to attempt to ensure that contiguous, aligned physical pages are available. OpenVMS attempts to allow granularity hints, so that in many or even most cases, pre-allocated resident memory sections will be physically contiguous. However, for example on systems supporting resource affinity domains (RADs), OpenVMS intentionally tries to "stripe" memory across all RADs, unless told to use only a single RAD. Granularity hints may be used when mapping to the memory-resident global section if the virtual alignment of the mapping is on an even 8-page, 64-page, or 512-page boundary. (With a system page size of 8 KB, granularity hint virtual alignments are on 64-KB, 512-KB, and 4-MB boundaries.) The maximum granularity hint on Alpha covers 512 pages. With 8-KB pages, this is 4 MB. If your selection is below this limit, there is an excellent chance that it will be contiguous if at all possible. Currently, there is no guarantee of contiguousness for application software. OpenVMS chooses optimal virtual alignment to use granularity hints if the flag SEC\$M\_EXPREG is set on the call to one of the mapping system services, such as SYS\$MGBLSC.

Sufficiently contiguous, aligned PFNs are reserved using the Reserved Memory Registry. These pages are allocated during system initialization, based on the description of the reserved memory. The memory-resident global section size must be less than or equal to the size of the reserved memory or an error is returned from the system service call.

If memory has been reserved using the Reserved Memory Registry, that memory must be used for the global section named in the SYSMAN command. To return the memory to the system, SYSMAN can be run to free the pre-reserved memory. Once the pre-reserved memory has been freed, the allocate option can no longer be used to create the memory-resident global section.

## Memory Management with VLM Features

### 16.3 Fast I/O and Buffer Objects for Global Sections

### 16.3 Fast I/O and Buffer Objects for Global Sections

As of OpenVMS Alpha 7.2, VLM applications can use Fast I/O for memory shared by processes through global sections. In prior versions of OpenVMS Alpha, buffer objects could be created only for process-private virtual address space. Fast I/O requires data to be locked in memory through buffer objects. Database applications where multiple processes share a large cache can now create buffer objects for the following types of global sections:

- Page file-backed global sections
- Disk file-backed global sections
- Memory-resident global sections

Buffer objects enable Fast I/O system services, which can be used to read and write very large amounts of shared data to and from I/O devices at an increased rate. By reducing the CPU cost per I/O request, Fast I/O increases performance for I/O operations.

Fast I/O improves the ability of VLM applications, such as database servers, to handle larger capacities and higher data throughput rates.

#### 16.3.1 Comparison of \$QIO and Fast I/O

The \$QIO system service must ensure that a specified memory range exists and is accessible for the duration of each direct I/O request. Validating that the buffer exists and is accessible is done in an operation called **probing**. Making sure that the buffer cannot be deleted and that the access protection is not changed while the I/O is still active is achieved by locking the memory pages for I/O and by unlocking them at I/O completion.

The probing and locking/unlocking operations for I/O are costly operations. Having to do this work for each I/O can consume a significant percentage of CPU capacity. The advantage of Fast I/O is that memory is locked only for the duration of a single I/O and can otherwise be paged.

Fast I/O must still ensure that the buffer is available, but if many I/O requests are performed from the same memory cache, performance can increase if the cache is probed and locked only once—instead of for each I/O. OpenVMS must then ensure only that the memory access is unchanged between multiple I/Os. Fast I/O uses buffer objects to achieve this goal. Fast I/O gains additional performance advantages by pre-allocating some system resources and by streamlining the I/O flow in general.

#### 16.3.2 Overview of Locking Buffers

Before the I/O subsystem can move any data into a user buffer, either by moving data from system space in a buffered I/O, or by allowing a direct I/O operation, it must ensure that the user buffer actually exists and is accessible.

For buffered I/O, this is usually achieved by assuming the context of the process requesting the I/O and probing the target buffer. For most QIO requests, this happens at IPL 2 (IPL\$\_ASTDEL), which ensures that no AST can execute between the buffer probing and the moving of the data. The buffer is not deleted until the whole operation has completed. IPL 2 also allows the normal paging mechanisms to work while the data is copied.



## Memory Management with VLM Features

### 16.3 Fast I/O and Buffer Objects for Global Sections

For direct I/O, this is usually achieved by locking the target pages for I/O. This makes the pages that make up the buffer ineligible for paging or swapping. From there on the I/O subsystem identifies the buffer by the page frame numbers, the byte offset within the first page, and the length of the I/O request.

This method allows for maximum flexibility because the process can continue to page and can even be swapped out of the balance set while the I/O is still outstanding or active. No pages need to be locked for buffered I/O, and for direct I/O, most of the process pages can still be paged or swapped. However, this flexibility comes at a price: all pages involved in an I/O must be probed or locked and unlocked for every single I/O. For applications with high I/O rates, the operating system can spend a significant amount of time on these time-consuming operations.

Buffer objects can help avoid much of this overhead.

#### 16.3.3 Overview of Buffer Objects

A buffer object is a process entity that is associated with a virtual address range within a process. When the buffer object is created, all pages in this address range are locked in memory. These pages cannot be freed until the buffer object has been deleted. The Fast I/O environment uses this feature by locking the buffer object itself during `$IO_SETUP`. This prevents the buffer object and its associated pages from being deleted. The buffer object is unlocked during `$IO_CLEANUP`. This replaces the costly probe, lock, and unlock operations with simple checks validating that the I/O buffer does not exceed the buffer object. The trade-off is that the pages associated with the buffer object are permanently locked in memory. An application may need more physical memory but it can then execute faster.

To control this type of access to the system's memory, a user must hold the `VMS$BUFFER_OBJECT_USER` identifier, and the system allows only a certain number of pages locked for use in buffer objects. This number is controlled by the dynamic `SYSGEN` parameter `MAXBOBMEM`.

A second buffer object property allows Fast I/O to perform several I/O-related tasks entirely from system context at high IPL, without having to assume process context. When a buffer object is created, the system maps by default a section of system space (S2) to process pages associated with the buffer object. This system space window is protected to allow read and write access only from kernel mode. Because all of system space is equally accessible from within any context, it is now possible to avoid the still expensive context switch to assume the original user's process context.

The convenience of having system space access to buffer object pages comes at a price. For example, even though S2 space usually measures several gigabytes, this may still be insufficient if several gigabytes of database cache should be shared for Fast I/O by many processes. In such an environment all or most I/O to or from the cache buffers is direct I/O, and the system space mapping is not needed.

As of OpenVMS Version 7.2, buffer objects can be created with or without an associated system space window. Resources used by buffer objects are charged as follows:

- Physical pages are charged against `MAXBOBMEM` unless the page belongs to a memory-resident section, or the page is already associated with another buffer object.

## Memory Management with VLM Features

### 16.3 Fast I/O and Buffer Objects for Global Sections

- By default, system space window pages are charged against MAXBOBS2. They are charged against MAXBOBS0S1 if CBO\$\_SVA\_32 is specified.
- If CBO\$\_NOSVA is set, no system space window is created, and only MAXBOBMEM is charged as appropriate.

For more information about using Fast I/O features, see the *OpenVMS I/O User's Reference Manual*.

#### 16.3.4 Creating and Using Buffer Objects

When creating and using buffer objects, you must be aware of the following:

- Buffer objects can be associated only with process space (P0, P1, or P2) pages.
- PFN-mapped pages cannot be associated with buffer objects.
- The special type of buffer object without associated system space can be used only to describe Fast I/O data buffers. The IOSA must always be associated with a full buffer object with system space.
- Some Fast I/O operations are not fully optimized if the data buffer is associated with a buffer object without system space. Copying of data at the completion of buffered I/O or disk-read I/O through the VIOC cache may happen at IPL 8 in system context for full buffer objects. However, it must happen in process context for buffer objects without system space. If your application implements its own caching, Compaq recommends bypassing the VIOC for disk I/O by setting the IO\$\_M\_NOVCACHE function code modifier. Fast I/O recognizes this condition and uses the maximum level of optimization regardless of the type of buffer object.

## 16.4 Shared Page Tables

Shared page tables enable two or more processes to map to the same physical pages without each process incurring the overhead of page table construction, page file accounting, and working set quota accounting. Internally, shared page tables are treated as a special type of global section and are specifically used to map pages that are part of a memory-resident global section. The special global section that provides page table sharing is called a **shared page table section**. Shared page table sections themselves are memory resident.

Shared page tables are created and propagated to multiple processes by a cooperating set of system services. No special privileges or rights identifiers are required for a process or application to use shared page tables. The VMS\$MEM\_RESIDENT\_USER rights identifier is required only to create a memory-resident global section. Processes that do not have this identifier can benefit from shared page tables (as long as certain mapping criteria prevail).

Similar to memory reserved for memory-resident global sections, memory for shared page tables must be deducted from the system's set of fluid pages. The Reserved Memory Registry allows for this deduction when a memory-resident global section is registered.

### 16.4.1 Memory Requirements for Private Page Tables

Table 16–1 highlights the physical memory requirements for private page tables and shared page tables that map to various sizes of global sections by various numbers of processes. This table illustrates the amount of physical memory saved systemwide through the use of shared page tables. For example, when 100 processes map to a 1 GB global section, 99 MB of physical memory are saved by mapping to the global section with shared page tables.

Overall system performance benefits from this physical memory savings because of the reduced contention for the physical memory system resource. Individual processes benefit from the reduction of working set usage by page table pages, thus allowing a process to keep more private code and data in physical memory.

**Table 16–1 Page Table Size Requirements**

Number of Mapping Processes	Size of Global Section							
	8MB PPT	8MB SHPT	1GB PPT	1GB SHPT	8GB PPT	8GB SHPT	1TB PPT	1TB SHPT
1	8KB	8KB	1MB	1MB	8MB	8MB	1GB	1GB
10	80KB	8KB	10MB	1MB	80MB	8MB	10GB	1GB
100	800KB	8KB	100MB	1MB	800MB	8MB	100GB	1GB
1000	8MB	8KB	1GB	1MB	8GB	8MB	1TB	1GB

*Key*

PPT = Private Page Tables  
SHPT = Shared Page Tables

### 16.4.2 Shared Page Tables and Private Data

To benefit from shared page tables, a process does not require any special privileges or rights identifiers. Only the creator of a memory-resident global section requires the rights identifier `VMS$MEM_RESIDENT_USER`. The creation of the memory-resident global section causes the creation of the shared page tables that map that global section unless the Reserved Memory Registry indicates that no shared page tables are required. At first glance, it may appear that there is a security risk inherent in allowing this greater level of data sharing. There is no security risk for the reasons described in this section.

An application or process that maps to a memory-resident global section with shared page tables must take the following steps:

1. Create a shared page table region by calling the system service `SYS$CREATE_REGION_64`.  
The starting virtual address of the region is rounded down and the length is rounded up such that the region starts and ends on an even page table page boundary.
2. Use either the `SYS$CRMPSC_GDZRO_64` system service or the `SYS$MGBLSC_64` system service to map to a memory-resident global section.

## Memory Management with VLM Features

### 16.4 Shared Page Tables

These services enable the caller to use the shared page tables associated with the global section if the following conditions are met:

- The caller specifies a read/write access mode with the mapping request that is exactly the same as the access mode associated with the global section to map.
- The caller specifies proper virtual addressing alignments with the mapping request.

A shared page table region can only map memory-resident global sections. An application can map more than one memory-resident global section into a shared page table region. The starting virtual address for global sections mapped into a shared page table region are always rounded to a page table page boundary. This prevents two distinct global sections from sharing the same page table page. Attempts to create virtual address space in a shared page table region with any other system service except those listed in Step 2 will fail.

---

#### Note

---

Processes can specify a non-shared page table region for mapping to a memory-resident global section with shared page tables. In this case, process private page tables are used to map to the global section.

---

### 16.5 Expandable Global Page Table

The GBLPAGES system parameter defines the size of the global page table. The value stored in the parameter file is used at boot time to establish the initial size of the global page table.

As of OpenVMS Alpha Version 7.1, the system parameters GBLPAGES and GBLPAGFIL have been modified to become dynamic parameters. Users with the CMKRNL privilege can now change their effective values on the running system. Increasing the value of the GBLPAGES parameter at runtime allows the global page table to expand, on demand, up to the new maximum size. All the following conditions must be met for the global page table to expand or grow:

- The global page table has insufficient contiguous free space to allow the requested creation of a global section.
- The current setting of the GBLPAGES parameter allows the global page table to expand.
- There is sufficient unused virtual memory at the higher end of the global page table to expand into.
- The system has sufficient fluid memory (pages not locked in memory) to allow the global page table to expand.

Because the global page table is mapped in 64-bit S2 space, which is a minimum of 6 GB, these conditions can be met by almost all systems. Only extremely memory-starved systems or systems with applications making extensive use of S2 virtual address space may make it impossible to grow the global page table on demand.

## Memory Management with VLM Features

### 16.5 Expandable Global Page Table

Because global pages are a system resource that also affects other tuning parameters, Compaq recommends using AUTOGEN and rebooting systems to increase GBLPAGES. If a reboot is not possible for operational reasons, you can change the parameter on the running system using the following commands:

```
$ RUN SYS$SYSTEM:SYSGEN
SYSGEN> USE ACTIVE
SYSGEN> SET GBLPAGES new_value
SYSGEN> WRITE ACTIVE
```

The WRITE ACTIVE command requires the CMKRNL privilege.

The same commands also allow you to reduce the effective size of the global page table. The global page table is actually reduced and full pages are released to the system as fluid pages under the following conditions:

- A global section is deleted, thus freeing up global page table entries.
- The value of GBLPAGES indicates a smaller size of the global page table than the current size.
- Unused entries exist at the high address end of the global page table that allow you to contract the structure.

Reducing the active value of GBLPAGES below the number of currently used global pages does not affect currently used global pages. It only prevents the creation of additional global pages.

Increasing the active value of the GBLPAGFIL parameter always succeeds, up to the maximum positive integer value. As with GBLPAGES, reducing the value of GBLPAGFIL below the number of global pages that may be paged against the system's pagefile has no effect on these pages. Doing so simply prevents the creation of additional global pagefile sections.

Note that an increase of GBLPAGFIL may also require that additional pagefile space be satisfied by installing an additional pagefile.



# Part IV

---

## Appendices: Macros and Examples of 64-Bit Programming

This part describes macros used in 64-bit programming and presents two examples of 64-bit programming.





## A

---

## C Macros for 64-Bit Addressing

This appendix describes the following C macros for manipulating 64-bit addresses, for checking the sign extension of the low 32 bits of 64-bit values, and for checking descriptors for the 64-bit format:

- \$DESCRIPTOR64
- \$is\_desc64
- \$is\_32bits

---

### DESCRIPTOR64

Constructs a 64-bit string descriptor.

#### Format

\$DESCRIPTOR64 name, string

#### Description

*name* is name of variable

*string* is address of string

#### Example:

```
int status;
$DESCRIPTOR64 (gblsec, "GBLSEC_NAME");
...
/* Create global page file section */
status = sys$create_gpfile (&gblsec, 0, 0, section_size, 0, 0);
...
```

This macro resides in `descrip.h` in `SYS$LIBRARY:DECC$RTLDEF.TLB`.

## C Macros for 64-Bit Addressing

### `$is_desc64`

---

### `$is_desc64`

Distinguishes a 64-bit descriptor.

#### Format

`$is_desc64 desc`

#### Description

*desc* is address of 32-bit or 64-bit descriptor

#### Returns:

0 if descriptor is 32-bit descriptor

1 if descriptor is 64-bit descriptor

#### Example:

```
#include <descrip.h>
#include <far_pointers.h>
...
    if ($is_desc64 (user_desc))
    {
        /* Get 64-bit address and 64-bit length from descriptor */
        ...
    }
    else
    {
        /* Get 32-bit address and 16-bit length from descriptor */
        ...
    }
```

This macro resides in `descrip.h` in `SYS$LIBRARY:DECC$RTLDEF.TLB`.

---

### `$is_32bits`

Tests if a quadword is 32-bit sign-extended.

#### Format

`$is_32bits arg`

#### Description

**Input:** *arg* is 64-bit value

#### Output:

1 if *arg* is 32-bit sign-extended

0 if *arg* is not 32-bit sign-extended

**Example:**

```
#include <starlet_bigpage.h>
...
if ($is_32bits(user_va))
    counter_32++; /* Count number of 32-bit references */
else
    counter_64++; /* Count number of 64-bit references */
```

This macro resides in starlet\_bigpage.h in SYS\$LIBRARY:SYS\$STARLET\_C.TLB.



# B

## 64-Bit Example Program

This example program demonstrates the 64-bit region creation and deletion system services. It uses `SYS$CREATE_REGION_64` to create a region and then uses `SYS$EXPREG_64` to allocate virtual addresses within that region. The virtual address space and the region are deleted by calling `SYS$DELETE_REGION_64`.

```
/*
This program creates a region in P2 space using the region creation
service and then creates VAs within that region. The intent is to
demonstrate the use of the region services and how to allocate virtual
addresses within a region. The program also makes use of 64-bit
descriptors and uses them to format return values into messages with the
aid of SYS$GETMSG.

To build and run this program type:

$ CC/POINTER SIZE=32/STANDARD=RELAXED/DEFINE=(__NEW_STARLET=1) -
  REGIONS.C
$ LINK REGIONS.OBJ
$ RUN REGIONS.EXE
*/

#include <descrip.h>          /* Descriptor Definitions          */
#include <far_pointers.h>    /* Long Pointer Definitions       */
#include <gen64def.h>        /* Generic 64-bit Data Type Definition */
#include <iledef.h>          /* Item List Entry Definitions    */
#include <ints.h>            /* Various Integer Typedefs       */
#include <iosbdef.h>         /* I/O Status Block Definition    */
#include <psldef.h>          /* PSL$ Constants                 */
#include <ssdef.h>           /* SSS$ Message Codes             */
#include <starlet.h>         /* System Service Prototypes      */
#include <stdio.h>           /* printf                          */
#include <stdlib.h>          /* malloc, free                    */
#include <string.h>          /* memset                           */
#include <syidef.h>          /* $GETSYI Item Code Definitions  */
#include <vadef.h>          /* VA Creation Flags and Constants */

/* Module-wide constants and macros. */

#define BUFFER_SIZE 132
#define HW_NAME_LENGTH 32
#define PAGELET_SIZE 512
#define REGION_SIZE 128

#define good_status(code) ((code) & 1)

/* Module-wide Variables */

int
page_size;

$DESCRIPTOR64 (msgdsc, "");

/* Function Prototypes */
```

## 64-Bit Example Program

```
int get_page_size (void);
static void print_message (int code, char *string);

main (int argc, char **argv)
{
    int
        i,
        status;

    uint64
        length_64,
        master_length_64,
        return_length_64;

    GENERIC_64
        region_id_64;

    VOID_PTR
        master_va_64,
        return_va_64;

    /* Get system page size, using SYS$GETSYSI. */
    status = get_page_size ();
    if (!good_status (status))
        return (status);

    /* Get a buffer for the message descriptor. */
    msgdsc.dsc64$pq_pointer = malloc (BUFFER_SIZE);
    printf ("Message Buffer Address = %016LX\n\n", msgdsc.dsc64$pq_pointer);

    /* Create a region in P2 space. */
    length_64 = REGION_SIZE*page_size;
    status = sys$create_region_64 (
        length_64, /* Size of Region to Create */
        VA$C_REGION_UCREATE_UOWN, /* Protection on Region */
        0, /* Allocate in Region to Higher VAs */
        &region_id_64, /* Region ID */
        &master_va_64, /* Starting VA in Region Created */
        &master_length_64); /* Size of Region Created */
    if (!good_status (status))
    {
        print_message (status, "SYS$CREATE_REGION_64");
        return (status);
    }

    printf ("\nSYS$CREATE_REGION_64 Created this Region: %016LX - %016LX\n",
        master_va_64,
        (uint64) master_va_64 + master_length_64 - 1);

    /* Create virtual address space within the region. */
```

## 64-Bit Example Program

```
for (i = 0; i < 3; ++i)
{
    status = sys$expreg_64 (
        &region_id_64, /* Region to Create VAs In          */
        page_size,    /* Number of Bytes to Create          */
        PSL$C_USER,   /* Access Mode                         */
        0,            /* Creation Flags                      */
        &return_va_64, /* Starting VA in Range Created       */
        &return_length_64); /* Number of Bytes Created            */
    if (!good_status (status))
    {
        print_message (status, "SYS$EXPREG_64");
        return status;
    }
    printf ("Filling %016LX - %16LX with %0ds.\n",
        return_va_64,
        (uint64) return_va_64 + return_length_64 - 1,
        i);
    memset (return_va_64, i, page_size);
}

/* Return the virtual addresses created within the region, as well as the
region itself. */
printf ("\nReturning Master Region: %016LX - %016LX\n",
    master_va_64,
    (uint64) master_va_64 + master_length_64 - 1);

status = sys$delete_region_64 (
    &region_id_64, /* Region to Delete          */
    PSL$C_USER,   /* Access Mode               */
    &return_va_64, /* VA Deleted                */
    &return_length_64); /* Length Deleted           */

if (good_status (status))
    printf ("SYS$DELETE_REGION_64 Deleted VAs Between: %016LX - %016LX\n",
        return_va_64,
        (uint64) return_va_64 + return_length_64 - 1);
else
{
    print_message (status, "SYS$DELTE_REGION_64");
    return (status);
}

/* Return message buffer. */
free (msgdsc.dsc64$pg_pointer);
}

/* This routine obtains the system page size using SYS$GETSYI. The return
value is recorded in the module-wide location, page_size. */
int get_page_size ()
{
    int
        status;
    IOSB
        iosb;
    ILE3
        item_list [2];

    /* Fill in SYI item list to retrieve the system page size. */
```

## 64-Bit Example Program

```
item_list[0].ile3$w_length      = sizeof (int);
item_list[0].ile3$w_code        = SYI$PAGE_SIZE;
item_list[0].ile3$ps_bufaddr    = &page_size;
item_list[0].ile3$ps_retlen_addr = 0;
item_list[1].ile3$w_length      = 0;
item_list[1].ile3$w_code        = 0;

/* Get the system page size. */
status = sys$getsysiw (
    0, /* EFN */
    0, /* CSI address */
    0, /* Node name */
    &item_list, /* Item list */
    &iosb, /* I/O status block */
    0, /* AST address */
    0); /* AST parameter */

if (!good_status (status))
{
    print_message (status, "SYS$GETJPIW");
    return (status);
}
if (!good_status (iosb.iosb$w_status))
{
    print_message (iosb.iosb$w_status, "SYS$GETJPIW IOSB");
    return (iosb.iosb$w_status);
}
return SS$NORMAL;
}

/* This routine takes the message code passed to the routine and then uses
SYS$GETMSG to obtain the associated message text. That message is then
printed to stdio along with a user-supplied text string. */
#pragma inline (print_message)
static void print_message (int code, char *string)
{
    msgdsc.dsc64$q_length = BUFFER_SIZE;
    sys$getmsg (
        code, /* Message Code */
        (unsigned short *) &msgdsc.dsc64$q_length, /* Returned Length */
        &msgdsc, /* Message Descriptor */
        15, /* Message Flags */
        0); /* Optional Parameter */
    *(msgdsc.dsc64$pq_pointer+msgdsc.dsc64$q_length) = '\0';
    printf ("Call to %s returned: %s\n",
        string,
        msgdsc.dsc64$pq_pointer);
}
}
```



---

## VLM Example Program

This example program demonstrates the memory management VLM features described in Chapter 16.

```

/*
This program creates and maps to a memory-resident global section using
shared page tables. The program requires a reserved memory entry
(named In_Memory_Database) in the Reserved Memory Registry.

The entry in the registry is created using SYSMAN as follows:

$ MCR SYSMAN
SYSMAN> RESERVED MEMORY ADD "In_Memory_Database"/ALLOCATE/PAGE_TABLES -
/ZERO/SIZE=64/GROUP=100

The above command creates an entry named In_Memory_Database that is
64M bytes in size and requests that the physical memory be allocated
during system initialization. This enables the physical memory to
be mapped with granularity hints by the SY$CRMPSC_GDZRO_64 system
service. It also requests that physical memory be allocated for
page tables for the named entry, requests the allocated memory be
zeroed, and requests that UIC group number 100 be associated with
the entry.

Once the entry has been created with SYSMAN, the system must be
re-tuned with AUTOGEN. Doing so allows AUTOGEN to re-calculate
values for SYSGEN parameters that are sensitive to changes in
physical memory sizes. (Recall that the Reserved Memory Registry
takes physical pages away from the system.) Once AUTOGEN has
been run, the system must be rebooted.

Use the following commands to compile and link this program:

$ CC/POINTER SIZE=32 shared_page_tables_example
$ LINK shared_page_tables_example

Since 64-bit virtual addresses are used by this program, a Version
5.2 Compaq C compiler or later is required to compile it.
*/
#define    __NEW_STARLET    1

#include    <DESCRIP>
#include    <FAR_POINTERS>
#include    <GEN64DEF>
#include    <INTS>
#include    <PSLDEF>
#include    <SECDEF>
#include    <SSDEF>
#include    <STARLET>
#include    <STDIO>
#include    <STDLIB>
#include    <STRING>
#include    <VADEF>

#define    bad_status(status) (((status) & 1) != 1)
#define    ONE_MEGABYTE    0x100000

```

## VLM Example Program

```
main ()
{
    int
        status;

    $DESCRIPTOR (section_name, "In_Memory_Database");

    uint32
        region_flags = VA$M_SHARED PTS, /* Shared PT region. */
        section_flags = SEC$M_EXPREG;

    uint64
        mapped_length,
        requested_size = 64*ONE_MEGABYTE,
        section_length = 64*ONE_MEGABYTE,
        region_length;

    GENERIC_64
        region_id;

    VOID_PQ
        mapped_va,
        region_start_va;

    printf ("Shared Page Table Region Creation Attempt: Size = %0Ld\n",
        requested_size);

    /* Create a shared page table region. */

    status = sys$create_region_64 (
        requested_size, /* Size in bytes of region */
        VA$C_REGION_UCREATE_UOWN, /* Region VA creation and owner mode */
        region_flags, /* Region Flags: shared page tables */
        &region_id, /* Region ID */
        &region_start_va, /* Starting VA for region */
        &region_length); /* Size of created region */

    if (bad_status (status))
    {
        printf ("ERROR: Unable to create region of size %16Ld\n\n",
            requested_size);
        return;
    }

    printf ("Shared Page Table Region Created: VA = %016LX, Size = %0Ld\n\n",
        region_start_va,
        region_length);

    /* Create and map a memory-resident section with shared page tables
        into the shared page table region. */

    printf ("Create and map to section %s\n", section_name.dsc$a_pointer);
    status = sys$crmpsc_gdzro_64 (
        &section_name, /* Section name */
        0, /* Section Ident */
        0, /* Section protection */
        section_length, /* Length of Section */
        &region_id, /* RDE */
        0, /* Section Offset; map entire section */
        PSL$C_USER, /* Access Mode */
        section_flags, /* Section Creation Flags */
        &mapped_va, /* Return VA */
        &mapped_length); /* Return Mapped Length */
}
```

## VLM Example Program

```
if (bad_status (status))
    printf ("ERROR: Unable to Create and Map Section %s, status = %08x\n\n",
           section_name.dsc$a_pointer,
           status);
else
{
    printf ("Section %s created, Section Length = %0Ld\n",
           section_name.dsc$a_pointer,
           section_length);
    printf ("    Mapped VA = %016LX, Mapped Length = %0Ld\n\n",
           mapped_va,
           mapped_length);
}

/* Delete the shared page table. This will cause the mapping to the
   section and the section itself to be deleted. */

printf ("Delete the mapping to the memory-resident global section");
printf (" and the shared\n    page table region.\n");
status = sys$delete_region_64 (
    &region_id,
    PSL$C_USER,
    &region_start_va,
    &region_length);

if (bad_status (status))
    printf ("ERROR: Unable to delete shared page table region, status = %08x\n\n", status);
else
    printf ("Region Deleted, Start VA = %016LX, Length = %016LX\n\n",
           region_start_va,
           region_length);
printf ("\n");
}
```

This example program displays the following output:

```
Shared Page Table Region Creation Attempt: Size = 67108864
Shared Page Table Region Created: VA = FFFFFFFBFC000000, Size = 67108864

Create and map to section In_Memory_Database
Section In_Memory_Database created, Section Length = 67108864
Mapped VA = FFFFFFFBFC000000, Mapped Length = 67108864

Delete the mapping to the memory-resident global section and the shared
page table region.
Region Deleted, Start VA = FFFFFFFBFC000000, Length = 000000004000000
```



---

# Index

## A

---

- Absolute time, *Vol 2*, 27–1
  - in system format, *Vol 2*, 27–6
- Access, physical I/O, *Vol 2*, 23–6
- Access and protection
  - checking, *Vol 2*, 34–10
- Access control entries
  - See ACEs
- Access control lists
  - See ACLs
- Access entry, in argument descriptions, *Vol 2*, 17–8
- Access mask, *Vol 2*, 32–25
- Access methods, to argument data, *Vol 2*, 17–8
- Access modes, *Vol 2*, 20–2
  - effect on AST delivery, *Vol 1*, 8–10
  - processor, *Vol 2*, B–2
  - specifying, *Vol 2*, 20–3, 34–10
  - with AST, *Vol 1*, 8–6
- Access name table, *Vol 2*, 32–25
- access\_bit\_names data type, *Vol 2*, B–2
- access\_mode data type, *Vol 2*, B–2
- ACEs (access control entries)
  - creating, *Vol 2*, 32–25, 32–26
  - maintaining, *Vol 2*, 32–25, 32–26
  - translating, *Vol 2*, 32–25, 32–26
- ACLs (access control lists), *Vol 2*, 32–2
- ACM client programs
  - reference, *Vol 2*, 33–1, 33–4, 33–5, 33–8, 33–10, 33–11, 33–12
- ACM communications buffer
  - reference, *Vol 2*, 33–7, 33–9, 33–12, 33–13, 33–15, 33–31
- ACM context argument
  - reference, *Vol 2*, 33–6, 33–9, 33–12, 33–14
- ACME agents
  - reference, *Vol 2*, 33–4, 33–5, 33–7, 33–8, 33–10, 33–14, 33–15, 33–16, 33–17, 33–19
- ACME server process
  - reference, *Vol 2*, 33–3, 33–6, 33–11
- Ada, *Vol 1*, 1–11
  - data type declarations, *Vol 2*, B–17
  - implementation table, *Vol 2*, B–17
- address data type, *Vol 2*, B–2
- Addresses, virtual memory, *Vol 2*, 26–3
- Address space
  - allocating by page, *Vol 1*, 12–4, 13–8
  - allocating in zones, *Vol 1*, 14–6
  - deallocating by page, *Vol 1*, 12–5, 13–8, 14–2
  - zones, *Vol 1*, 14–6
- address\_range data type, *Vol 2*, B–2
- Affinity, types of, *Vol 1*, 4–35
- Affinity mechanism, *Vol 1*, 4–32
- AI (argument information), format, *Vol 2*, 18–9
- AI (artificial intelligence), *Vol 1*, 1–12
- Algorithms, for memory allocation, *Vol 1*, 14–7
- Aligning data, *Vol 2*, 28–4
- Alignment, *Vol 1*, 15–1
  - natural, *Vol 1*, 15–2
  - on OpenVMS Alpha systems, *Vol 1*, 6–3
  - on OpenVMS VAX systems, *Vol 1*, 6–3
  - OpenVMS Alpha systems, *Vol 1*, 15–3
  - OpenVMS VAX, *Vol 1*, 15–3
  - system services, *Vol 1*, 15–10
  - with BLISS compiler, *Vol 1*, 15–5
  - with Compaq C compiler, *Vol 1*, 15–4
  - with Compaq Fortran compiler, *Vol 1*, 15–6
  - with compilers, *Vol 1*, 15–4
  - with MACRO-32 compiler, *Vol 1*, 15–6
  - with OpenVMS Debugger, *Vol 1*, 15–9
  - with PCA, *Vol 1*, 15–10
  - with tools, *Vol 1*, 15–9
  - with VEST translator, *Vol 1*, 15–8
- Alignment attribute, *Vol 1*, 14–11
- Alpha architecture, *Vol 1*, 1–4
- Alpha platforms, *Vol 1*, 1–4
- Alpha processors, *Vol 1*, 1–3
- APL (Application Programming Language), *Vol 1*, 1–11
  - data type declarations, *Vol 2*, B–20
  - implementation table, *Vol 2*, B–20
- Applications
  - distributed, *Vol 1*, 1–6
  - graphical user interface, *Vol 1*, 1–20
  - OpenVMS, *Vol 1*, 1–3
  - portable, *Vol 1*, 1–6
  - real-time, *Vol 1*, 1–20
- Architecture
  - Alpha, *Vol 1*, 1–4
  - CISC, *Vol 1*, 1–4
  - RISC, *Vol 1*, 1–4
  - VAX, *Vol 1*, 1–4

Area extension size, *Vol 1*, 14–9

Argument information (AI) format, *Vol 2*, 18–9

Argument lists, *Vol 2*, 17–7, 18–9

- creating, *Vol 2*, A–4
- for AST service routine, *Vol 1*, 8–8
- for condition handler, *Vol 1*, 9–27
- generic macro generated, *Vol 2*, A–1
- using macros, *Vol 2*, A–2

Argument passing

- for RTL routines, *Vol 2*, 19–4
- for system services, *Vol 2*, 20–4

mechanisms, *Vol 2*, 18–11

- by descriptor, *Vol 2*, 18–16
- by reference, *Vol 2*, 18–14
- by value, *Vol 2*, 18–13

Arguments, *Vol 2*, 17–7

- specifying, *Vol 2*, A–4

Arguments, mechanism vector, *Vol 1*, 9–35

Arguments heading, in routine documentation, *Vol 2*, 17–6

arg\_list data type, *Vol 2*, B–2

Arithmetic exceptions, on Alpha systems, *Vol 1*, 9–13

Arrays

- mechanism, *Vol 1*, 9–35
- virtual address, *Vol 1*, 12–7, 13–10

ASCII (American Standard Code for Information Interchange)

- time, *Vol 2*, 27–7

ASCII character set, *Vol 2*, 29–2

Assemblers, *Vol 1*, 1–11

ASSIGN command, *Vol 2*, 34–3

AST routines, *Vol 1*, 8–1

ASTs (asynchronous system traps), *Vol 1*, 1–17, 2–20, 8–1; *Vol 2*, 24–21

- See also Synchronization
- access mode, *Vol 1*, 8–6
- blocking, *Vol 1*, 7–17, 7–23
- call frame, *Vol 1*, 8–3
- declaring, *Vol 1*, 8–2
- delivery, *Vol 1*, 8–6, 8–8
- example, *Vol 1*, 8–10
- execution, *Vol 1*, 8–1
- in target process, *Vol 1*, 4–26
- parameter, *Vol 1*, 8–9
- process wait state, *Vol 1*, 8–13
- queuing, *Vol 1*, 8–2
- quota, *Vol 2*, 23–3
- reentrant code, *Vol 1*, 8–3
- service routine, *Vol 1*, 8–8
- shared data access, *Vol 1*, 8–3
- system service, *Vol 1*, 8–2
- writing, *Vol 1*, 8–2

ASTs delivery

- kernel threads, *Vol 1*, 8–11

AST synchronization, shared data, *Vol 1*, 8–4

ast\_procedure data type, *Vol 2*, B–2

Asynchronous input/output, *Vol 2*, 23–21

Asynchronous system services, *Vol 2*, 20–5

Asynchronous system traps

- See ASTs

Atomic instructions, effect on synchronization, *Vol 1*, 6–5

Atomicity, definition, *Vol 1*, 6–3

Atomic memory reference, *Vol 1*, 6–3

Attributes

- Dynamic, *Vol 2*, 32–5
- Holder Hidden, *Vol 2*, 32–5
- Name Hidden, *Vol 2*, 32–5
- No Access, *Vol 2*, 32–5
- Resource, *Vol 2*, 32–5
- Subsystem, *Vol 2*, 32–5

## B

---

Balance set, swapping, *Vol 1*, 12–11, 13–12

BASIC

- Compaq BASIC for OpenVMS Alpha, *Vol 1*, 1–11
- data type declarations, *Vol 2*, B–22
- implementation table, *Vol 2*, B–22
- VAX BASIC, *Vol 1*, 1–11

BIOLM (buffered I/O limit) quota, *Vol 2*, 23–3

32-bit descriptors, *Vol 1*, 11–2

64-bit descriptors, *Vol 1*, 11–2

32-bit item list formats, *Vol 1*, 11–5

64-bit item list formats, *Vol 1*, 11–6

32-bit item lists, *Vol 1*, 11–5

64-bit item lists, *Vol 1*, 11–6

BLISS

- data type declarations, *Vol 2*, B–25
- implementation table, *Vol 2*, B–25

BLISS-32, *Vol 1*, 1–11

BLISS-64, *Vol 1*, 1–11

BLISS compiler

- alignment, *Vol 1*, 15–5
- consequences of noncompliant code, *Vol 1*, 6–9

Blocking ASTs

- description, *Vol 1*, 7–17
- using, *Vol 1*, 7–23

Block size options, *Vol 1*, 14–10

Boolean data type, *Vol 2*, B–2

Boolean value flag, *Vol 2*, B–2

Boot CPU, *Vol 1*, 5–1

Booting, an SMP system, *Vol 1*, 5–1

Borders, virtual display, *Vol 2*, 22–12

Boundary tags, *Vol 1*, 14–8

Broadcast messages, *Vol 2*, 22–43

buffer data type, *Vol 2*, B–2

Buffered I/O, operations, *Vol 2*, 27–18

Buffer object management, *Vol 2*, 23–50  
Buffer objects, Fast I/O, *Vol 2*, 23–49  
buffer\_length data type, *Vol 2*, B–2  
BYPASS privilege, *Vol 2*, 23–5  
byte\_signed data type, *Vol 2*, B–2  
BYTLM (buffered I/O byte count) quota, *Vol 2*,  
23–3

## C

---

### C

Compaq C for OpenVMS Alpha, *Vol 1*, 1–11  
data type declarations, *Vol 2*, B–28  
implementation table, *Vol 2*, B–28  
VAX C, *Vol 1*, 1–11  
C++, *Vol 1*, 1–11  
data type declarations, *Vol 2*, B–28  
implementation table, *Vol 2*, B–28  
Caching, *Vol 1*, 7–23  
Callable system routines, *Vol 1*, 1–15  
Call entry  
for RTL, *Vol 2*, 19–4  
for system service, *Vol 2*, 20–3  
Call-frame condition handlers, *Vol 1*, 9–24  
Call frames, *Vol 2*, 18–3  
ASTs, *Vol 1*, 8–3  
exit handlers, *Vol 1*, 9–74  
Calling ASTs, *Vol 1*, 8–7  
Calling sequence, system routine, *Vol 2*, 18–5  
Calling standard, *Vol 1*, 1–9, 11–29; *Vol 2*, 19–1  
conventions, *Vol 2*, 18–1  
Call stacks, unwinding, *Vol 1*, 9–46  
Capabilities mechanism, *Vol 1*, 4–32  
Capability masks  
CPU, *Vol 1*, 4–34  
process, *Vol 1*, 4–34  
Capability types, *Vol 1*, 4–33  
Case, preservation of, *Vol 2*, 29–3  
Catchall handlers, *Vol 1*, 9–25, 9–43  
Chaining, *Vol 2*, 24–5  
item lists, *Vol 1*, 11–4  
Change-mode handlers, *Vol 1*, 9–11  
channel data type, *Vol 2*, B–3  
Channels, *Vol 1*, 3–10  
assigning I/O, *Vol 2*, 23–11  
deassigning, *Vol 2*, 23–24  
Character sets, *Vol 2*, 29–2, 29–3  
Character string routines, *Vol 2*, 24–14  
translation routines, *Vol 2*, 24–14  
Character strings, *Vol 2*, B–3  
char\_string data type, *Vol 2*, B–3  
Checking access and protection of logical name  
tables, *Vol 2*, 34–10  
\$CHFDEF2 macro, *Vol 1*, 9–27  
\$CHFDEF macro, *Vol 1*, 9–27  
Circumflex character, *Vol 2*, 29–2, 29–3

CISC, architecture, *Vol 1*, 1–4  
Class scheduler, *Vol 1*, 4–36  
Class scheduler database, *Vol 1*, 4–40  
Class\_schedule, SYSMAN command, *Vol 1*, 4–37  
CLI (command language interpreter), *Vol 1*, 2–4;  
*Vol 2*, 24–2  
CLI access routine, *Vol 2*, 24–2  
Client/server computing, *Vol 1*, 1–6  
Clients, *Vol 1*, 1–6  
Clocks, setting system, *Vol 2*, 27–11  
Cluster-aware services  
SYS\$GETQUI, *Vol 2*, 27–21  
SYS\$BRKTHRU, *Vol 2*, 22–43  
SYS\$BRKTHRUW, *Vol 2*, 22–43  
SYS\$CANWAK, *Vol 2*, 27–13, 27–17  
SYS\$CREPRC, *Vol 1*, 2–12  
SYS\$DELPRC, *Vol 1*, 4–74  
SYS\$DISMOU, *Vol 2*, 23–36  
SYS\$FORCEX, *Vol 1*, 4–70  
SYS\$GETDVI, *Vol 2*, 23–29  
SYS\$GETJPI, *Vol 1*, 4–5, 4–9  
SYS\$GETJPIW, *Vol 1*, 4–9  
SYS\$GETSYI, *Vol 2*, 27–21  
SYS\$GETSYIW, *Vol 2*, 27–21  
SYS\$GETUPIW, *Vol 1*, 4–5  
SYS\$GET\_SECURITY, *Vol 2*, 32–25, 32–26  
SYS\$ICC\_ACCEPT, *Vol 1*, 3–22  
SYS\$ICC\_CLOSE\_ASSOC, *Vol 1*, 3–21  
SYS\$ICC\_CONNECT, *Vol 1*, 3–21  
SYS\$ICC\_CONNECTW, *Vol 1*, 3–21  
SYS\$ICC\_DISCONNECT, *Vol 1*, 3–22  
SYS\$ICC\_DISCONNECTW, *Vol 1*, 3–22  
SYS\$ICC\_OPEN\_ASSOC, *Vol 1*, 3–21  
SYS\$ICC\_RECEIVE, *Vol 1*, 3–22  
SYS\$ICC\_RECEIVEW, *Vol 1*, 3–22  
SYS\$ICC\_REJECT, *Vol 1*, 3–22  
SYS\$ICC\_REPLY, *Vol 1*, 3–22  
SYS\$ICC\_REPLYW, *Vol 1*, 3–22  
SYS\$ICC\_TRANSCEIVE, *Vol 1*, 3–22  
SYS\$ICC\_TRANSCEIVEW, *Vol 1*, 3–22  
SYS\$ICC\_TRANSMITW, *Vol 1*, 3–22  
SYS\$MOUNT, *Vol 2*, 23–34  
SYS\$SCHDWK, *Vol 2*, 27–13  
SYS\$SETIME, *Vol 2*, 27–11  
SYS\$SET\_SECURITY, *Vol 2*, 32–25, 32–26  
SYS\$WAKE, *Vol 1*, 4–65  
Clusterwide logical name tables, *Vol 2*, 34–6,  
34–8, 34–9  
CMS, *Vol 1*, 1–15  
COBOL  
data type declarations, *Vol 2*, B–30  
implementation table, *Vol 2*, B–30  
Code values  
logon types  
ACME\$K\_NETWORK  
reference, *Vol 2*, 33–12  
message categories, *Vol 2*, 33–13

- Code values
  - message categories (cont'd)
    - ACMEMC\$K\_SELECTION, *Vol 2*, 33–13
- Command Definition Utility (CDU), *Vol 1*, 1–14, 1–19
- Command language interpreter, *Vol 1*, 2–4
  - See CLI
- Common areas, per-process, *Vol 1*, 3–6
- Common blocks
  - aligning, *Vol 2*, 28–4
  - installing as a shared image, *Vol 2*, 26–6
  - interprocess, *Vol 2*, 26–6
  - modifying, *Vol 1*, 3–6
- Common event flag clusters, *Vol 1*, 6–25
  - permanent, *Vol 1*, 6–27
  - temporary, *Vol 1*, 6–27
- Compaq C++ compiler, consequences of noncompliant code, *Vol 1*, 6–9
- Compaq C compiler
  - alignment, *Vol 1*, 15–4
  - consequences of noncompliant code, *Vol 1*, 6–9
- Compaq COBOL, *Vol 1*, 1–11
- Compaq DECwindows Motif, *Vol 2*, 22–7
  - creating WSA pseudo workstation devices, *Vol 2*, 22–8
  - height and width restrictions, *Vol 2*, 22–8
- Compaq DECwindows Motif for OpenVMS
  - software, programming libraries and tools, *Vol 1*, 1–19
- Compaq Extended Math Library for OpenVMS, *Vol 1*, 1–17
- Compaq Fortran compiler
  - alignment, *Vol 1*, 15–6
- Compaq language implementation tables
  - See Implementation tables
- Compaq POSIX Threads Library, *Vol 1*, 1–15, 2–18
  - .H file support, *Vol 2*, 21–2
- Comparing 32-bit and 64-bit item lists, *Vol 1*, 11–4
- Compatibility mode handlers, *Vol 1*, 9–11
- Compilers, *Vol 1*, 1–11
  - alignment, *Vol 1*, 15–4
- complex\_number data type, *Vol 2*, B–3
- Components, of item lists, *Vol 2*, B–12
- Condition codes
  - chaining, *Vol 1*, 9–53
  - signaling, *Vol 1*, 9–33
  - SS\$\_EXQUOTA, *Vol 1*, 9–21
  - SS\$\_NOPRIV, *Vol 1*, 9–21
- Condition handlers, *Vol 2*, 17–11
  - See also Signal argument vectors
  - argument list, *Vol 1*, 9–27
  - arithmetic, *Vol 1*, 9–16
  - call frame, *Vol 1*, 9–24
  - catchall, *Vol 1*, 9–25, 9–43
  - condition code, *Vol 1*, 9–65
- Condition handlers (cont'd)
  - continuing execution of, *Vol 1*, 9–64
  - debugging, *Vol 1*, 9–70
  - default, *Vol 1*, 9–42
  - establishing, *Vol 1*, 9–5
  - example, *Vol 1*, 9–69
  - exiting, *Vol 1*, 9–66; *Vol 2*, B–7
  - last-chance, *Vol 1*, 9–43
  - last-chance exception vector, *Vol 1*, 9–25
  - mechanism argument vectors, *Vol 1*, 9–35
  - primary exception vector, *Vol 1*, 9–24
  - resignaling, *Vol 1*, 9–64
  - searching for, *Vol 1*, 9–24
  - secondary exception vectors, *Vol 1*, 9–24
  - signal argument array, *Vol 1*, 9–32
  - software supplied, *Vol 1*, 9–41
  - specifying, *Vol 1*, 9–4
  - traceback, *Vol 1*, 9–25, 9–42
  - types, *Vol 1*, 9–41
  - types of action, *Vol 1*, 9–45
  - unwinding, *Vol 1*, 9–64
  - use of, *Vol 1*, 9–27
  - user-supplied, *Vol 1*, 9–41
  - writing, *Vol 1*, 9–63
- Condition handling, *Vol 1*, 9–3
  - See also Condition handlers
  - See also Condition Handling Facility
  - See also Condition values
  - See also Exception conditions
  - See also Exceptions
  - See also Message utility (MESSAGE)
  - alignment fault reporting, *Vol 1*, 9–15
  - arithmetic exceptions, *Vol 1*, 9–13
  - continuing, *Vol 1*, 9–45
  - displaying messages, *Vol 1*, 9–49
  - GOTO unwind, *Vol 1*, 9–45
  - hardware exception conditions, *Vol 1*, 9–12
  - logging error messages, *Vol 1*, 9–6
  - logging error messages to a file, *Vol 1*, 9–55
  - mechanism argument vectors, *Vol 1*, 9–35, 9–37
  - mechanism array format, *Vol 1*, 9–37
  - resignaling, *Vol 1*, 9–45, 9–67
  - return status, *Vol 1*, 9–21
  - run-time library support routines, *Vol 1*, 9–17
  - signal argument vectors, *Vol 1*, 9–33
  - signaling a condition, *Vol 1*, 9–45
  - stack traceback, *Vol 1*, 9–6
  - stack unwind, *Vol 1*, 9–6, 9–45
  - unwinding, *Vol 1*, 9–67
  - user-defined messages, *Vol 1*, 9–6
  - VAX hardware exceptions, *Vol 1*, 9–12
- Condition Handling Facility (CHF), *Vol 1*, 9–41
  - definition, *Vol 1*, 9–1
  - function, *Vol 1*, 9–4



- Conditions
  - for exception, *Vol 1*, 9–6
- Condition values, *Vol 1*, 9–18 to 9–20, 9–31; *Vol 2*, 18–22, 20–7, B–6
  - definition, *Vol 1*, 9–63
  - information provided by, *Vol 2*, 20–8
  - returned, *Vol 2*, 17–12
    - in I/O status block, *Vol 2*, 17–12
    - in mailbox, *Vol 2*, 17–12
    - in R0, *Vol 2*, 17–4
    - signaled in register, *Vol 2*, 17–6, 17–12
  - RTL symbols, *Vol 2*, 19–6
  - severity, *Vol 1*, 9–19
  - signaled, *Vol 2*, 17–6, 17–12
  - symbolic codes, *Vol 2*, 20–8
  - testing, *Vol 2*, 20–8, 20–9
- Condition Values Returned heading, *Vol 2*, 17–11
- cond\_value data type, *Vol 2*, B–6
- context data type, *Vol 2*, B–7
- Control actions, inhibiting, *Vol 2*, 22–42
- Coordinated Universal Time
  - See UTC system services
- CPU characteristics
  - SMP system, *Vol 1*, 5–1
- CPUs (central processing units)
  - affinity scheduling, *Vol 1*, 4–32
  - capabilities scheduling, *Vol 1*, 4–32
  - class scheduling, *Vol 1*, 4–36
- CPU-specific pages, *Vol 1*, 12–1
- Create Mailbox and Assign Channel system service
  - See also SYS\$CREMBX system service
- credentials
  - reference, *Vol 2*, 33–4, 33–14
- \$CRFCTLTABLE macro, *Vol 2*, 25–1, 25–2
- \$CRFFIELDEND macro, *Vol 2*, 25–1, 25–4
- \$CRFFIELD macro, *Vol 2*, 25–1, 25–3
- Cross-Reference routines, *Vol 2*, 25–1
- C system() call, *Vol 1*, 2–6
- Ctrl/C key sequence, *Vol 2*, 22–33
- Ctrl/Y key sequence, *Vol 2*, 22–33
- Ctrl/Z key sequence, *Vol 2*, 22–5, 23–31
- Current procedure, *Vol 1*, 9–48
- Current time, *Vol 2*, 27–9
- Cursor movement, *Vol 2*, 22–21

## D

### Data

- aligning, *Vol 2*, 28–4
- interprocess, *Vol 2*, 26–6
- sharing, *Vol 2*, 26–6
- Data alignment, *Vol 1*, 15–1
  - exception reporting, *Vol 1*, 9–15
- Databases, record, *Vol 2*, 28–12
- Data Cells, *Vol 1*, 2–23

- Data management, *Vol 1*, 1–20
- Data structures
  - ACMEDLOGFLG
    - ACMEDLOGFLG\$V\_INPUT
      - reference, *Vol 2*, 33–10, 33–11
  - ACMEIS
    - ACMEIS\$L\_FLAGS
      - reference, *Vol 2*, 33–10
    - ACMEIS\$W\_ITEM\_CODE, *Vol 2*, 33–13
    - ACMEIS\$W\_MAX\_LENGTH
      - reference, *Vol 2*, 33–10
    - ACMEIS\$W\_MSG\_TYPE, *Vol 2*, 33–13
      - reference, *Vol 2*, 33–10, 33–11
  - ACMESB
    - ACMESB\$L\_ACME\_ID
      - reference, *Vol 2*, 33–6, 33–19
    - ACMESB\$L\_ACME\_STATUS
      - reference, *Vol 2*, 33–6, 33–19
    - ACMESB\$L\_SECONDARY\_STATUS
      - reference, *Vol 2*, 33–6
    - ACMESB\$L\_STATUS
      - reference, *Vol 2*, 33–6, 33–7, 33–13
- Data types, *Vol 2*, 17–7, B–1
  - Ada declarations, *Vol 2*, B–17
  - APL declarations, *Vol 2*, B–20
  - BASIC declarations, *Vol 2*, B–22
  - BLISS declarations, *Vol 2*, B–25
  - C++ declarations, *Vol 2*, B–28
  - C declarations, *Vol 2*, B–28
  - COBOL declarations, *Vol 2*, B–30
  - Fortran declarations, *Vol 2*, B–34
  - MACRO declarations, *Vol 2*, B–48
  - OpenVMS, *Vol 2*, B–1, B–2
    - standard, *Vol 2*, 17–7
    - usage, *Vol 2*, 17–6
  - Pascal declarations, *Vol 2*, B–38
  - PL/I declarations, *Vol 2*, B–42
  - RPG II declarations, *Vol 2*, B–50
  - SCAN declarations, *Vol 2*, B–52
    - symbolic code, *Vol 2*, 17–7
- Date/time formats, *Vol 2*, 27–22
- Date/time manipulation, converting, *Vol 2*, 27–7
- Date and time format logical names, *Vol 2*, 27–29
- Date format logical names, *Vol 2*, 27–29 to 27–30
- Dates
  - 64-bit system format, *Vol 2*, 27–1
  - 128-bit system format, *Vol 2*, 27–36
    - getting current system, *Vol 2*, 27–10
    - Smithsonian base, *Vol 2*, 27–1
- date\_time data type, *Vol 2*, B–7
- DCOM, *Vol 2*, 29–1, 29–3
- Deadlock detection, *Vol 1*, 7–11
- Debuggers, *Vol 1*, 1–13
- Debugging
  - BUGCHECKFATAL, *Vol 1*, 1–14
  - condition handler, *Vol 1*, 9–70
  - CPUSPINWAIT, *Vol 1*, 1–14
  - detached process, *Vol 1*, 2–15

- Debugging (cont'd)
  - exit handler, *Vol 1*, 9–70
  - MULTIPROCESSING, *Vol 1*, 1–14
  - POOLCHECK, *Vol 1*, 1–14
  - subprocess, *Vol 1*, 2–15
  - SYSTEM\_CHECK, *Vol 1*, 1–14
- DECdns call, timeout, *Vol 2*, C–5
- DECdns naming conventions
  - defining logicals, *Vol 2*, C–16
  - logical names, *Vol 2*, C–16
- DECdns objects
  - creating, *Vol 2*, C–4
  - reading attributes, *Vol 2*, C–10
- DECdtm
  - Distributed Transaction Manager, *Vol 2*, 30–1
  - event notification, *Vol 2*, 30–8
- DECdtm BLISS program example, *Vol 2*, 30–46
- DECdtm C program examples, *Vol 2*, 30–42
- DECdtm Fortran program example, *Vol 2*, 30–39
- DECdtm program examples, *Vol 2*, 30–39
- DECdtm services
  - support for transaction processing, *Vol 1*, 1–18
- DECdtm XA interface (Alpha Only), *Vol 2*, 30–15
- DECforms, *Vol 2*, 22–2
- Declaring ASTs, *Vol 1*, 8–2
- DECnet, file copying, *Vol 2*, 29–5
- DECset, *Vol 1*, 1–20
- DEC Text Processing Utility (DECTPU), *Vol 2*, 22–1
- DECTPU, *Vol 1*, 1–10
- DECW\$TERM\_PORT example program, *Vol 1*, 2–15
- Dedicated CPU Lock Manager, *Vol 1*, 7–2
  - enabling, *Vol 1*, 7–3
  - implementing, *Vol 1*, 7–2
  - setting affinity, *Vol 1*, 7–3
  - supporting fast path devices, *Vol 1*, 7–4
- Default logical name tables
  - group, *Vol 2*, 34–6
  - job, *Vol 2*, 34–5
  - process, *Vol 2*, 34–4
  - quotas, *Vol 2*, 34–15
  - system, *Vol 2*, 34–6
- Default zone, *Vol 1*, 14–12
- DEFINE command, *Vol 2*, 34–3
- /DELETE qualifier
  - LIBRARY command, *Vol 2*, 26–2
- Delta/XDelta Debugger (DELTA/XDELTA), *Vol 1*, 1–13
- Delta time, *Vol 2*, 27–1
  - example, *Vol 2*, 27–6
  - in system format, *Vol 2*, 27–6
- Descriptors
  - class, *Vol 2*, 18–19
  - class codes, *Vol 2*, 17–10
  - data type, *Vol 2*, 18–19
  - fields, *Vol 2*, 18–16
- Detached processes, *Vol 1*, 2–1
  - creating, *Vol 1*, 2–13
  - debugging, *Vol 1*, 2–15
- Developing application programs, *Vol 1*, 1–7
- Device drivers
  - last channel deassign, *Vol 2*, 23–4
  - SHARE privilege, *Vol 2*, 23–4
- Devices
  - allocating, *Vol 2*, 23–32
  - deallocating, *Vol 2*, 23–33
  - default name, *Vol 2*, 23–28
  - getting information about, *Vol 2*, 23–28
  - implicit allocation, *Vol 2*, 23–33
  - names, *Vol 2*, 23–27
  - ownership, *Vol 2*, 23–4
  - protection, *Vol 2*, 23–5
  - SHARE privilege, *Vol 2*, 23–4
- Device types, *Vol 2*, 23–29
- device\_name data type, *Vol 2*, B–7
- dialogue mode
  - reference, *Vol 2*, 33–5, 33–6, 33–8, 33–9, 33–11, 33–12, 33–13, 33–21, 33–31
- DIOLM (direct I/O limit)
  - quota, *Vol 2*, 23–3
- Direct I/O, *Vol 2*, 27–18
- Directives
  - See also Message utility (MESSAGE)
  - .END, *Vol 1*, 9–59
  - .FACILITY, *Vol 1*, 9–58
  - .SEVERITY, *Vol 1*, 9–59
  - .TITLE, *Vol 1*, 9–60
- Directory logical name tables
  - process, *Vol 2*, 34–3
  - system, *Vol 2*, 34–3
- Directory structures
  - limits, *Vol 2*, 29–3
- Directory table quotas, *Vol 2*, 34–15
- Disk files, opening, *Vol 1*, 12–13, 13–14
- Disk volumes
  - mounting, *Vol 2*, 23–34
- Dispatcher, exception, *Vol 1*, 9–24
- Distributed computing, *Vol 1*, 1–6
- Distributed environments, *Vol 1*, 1–6
- Distributed processing, *Vol 1*, 1–5
- Distributed Transaction Manager
  - DECdtm, *Vol 2*, 30–1
- Documentation format
  - See System routine documentation
- DOI
  - reference, *Vol 2*, 33–3, 33–11, 33–15
- Double-width characters
  - See also Screen management
  - See also Virtual displays
  - specifying, *Vol 2*, 22–21
- Dynamic attributes, *Vol 2*, 32–5

Dynamic memory allocation, *Vol 1*, 12–4

## E

---

### Echo

terminal, *Vol 2*, 22–40  
terminators, *Vol 2*, 22–25

### Editors, *Vol 1*, 1–10

EDT, *Vol 1*, 1–10  
EVE, *Vol 1*, 1–10  
TECO, *Vol 1*, 1–10  
vi (POSIX), *Vol 1*, 1–10

### EFN 128 event flag

EFN\$C\_ENF, *Vol 1*, 6–22, 6–23

ef\_cluster\_name data type, *Vol 2*, B–7

ef\_number data type, *Vol 2*, B–7

.END directive, *Vol 1*, 9–59

ENQLM process limit, *Vol 1*, 7–12

Enqueue process limit quota, *Vol 1*, 7–12

Entry masks, *Vol 2*, B–15

### Entry points

CALL entry points, *Vol 2*, 19–4, 20–4  
RTL names, *Vol 2*, 19–3

### Environments

client/server, *Vol 1*, 1–6  
common code, *Vol 1*, 1–9  
common language, *Vol 1*, 1–9  
computing, *Vol 1*, 1–5  
distributed, *Vol 1*, 1–6  
open system, *Vol 1*, 1–5  
production systems, *Vol 1*, 1–5

EOF (end-of-file), *Vol 2*, 22–5

### Equivalence names

defining, *Vol 2*, 34–2  
format convention, *Vol 2*, 34–17

Error checking, *Vol 2*, 20–9

### Error handling

See Condition handling

Error recovery, *Vol 2*, 23–11

Error returns, *Vol 2*, 18–22

### Errors

returning condition value, *Vol 2*, 18–22  
signaling condition value, *Vol 2*, 18–23

Errors, signaling, *Vol 1*, 9–5

Escape sequences, read, *Vol 2*, 23–31

EV6 Alpha processor, *Vol 1*, 6–9

EVE (Extensible Versatile Editor), *Vol 1*, 1–10

### Event flag clusters

deleting, *Vol 1*, 6–27  
disassociating, *Vol 1*, 6–27  
specifying name for, *Vol 1*, 6–26

Event flags, *Vol 1*, 1–17, 2–20, 6–20

See also Synchronization

allocation of, *Vol 2*, 24–17

clearing, *Vol 1*, 6–31

cluster, *Vol 1*, 6–21; *Vol 2*, B–7

common, *Vol 1*, 6–21

### Event flags (cont'd)

for interprocess communication, *Vol 1*, 3–8

local, *Vol 1*, 3–2, 6–21

number, *Vol 2*, B–7

numbers, *Vol 1*, 6–21

setting, *Vol 1*, 6–31

specifying, *Vol 1*, 6–22

wait, *Vol 1*, 6–29

Event flag service, example using, *Vol 1*, 6–34

Event flag zero (0), *Vol 1*, 6–23

### Event notification

DECdtm, *Vol 2*, 30–8

Exception conditions, *Vol 1*, 9–2, 9–6; *Vol 2*, 17–11

returning condition value, *Vol 1*, 9–7

signaling, *Vol 1*, 9–6, 9–7, 9–16, 9–28, 9–49

### Exceptions

definition, *Vol 1*, 9–2

dispatcher, *Vol 1*, 9–24

floating-point underflow, *Vol 1*, 9–16

handling by run-time library, *Vol 1*, 9–15

type, *Vol 1*, 9–6

EXE\$READ\_PROCESS routine, *Vol 1*, 4–43 to 4–45

EXE\$WRITE\_PROCESS routine, *Vol 1*, 4–45 to 4–47

Execution context, *Vol 1*, 2–2

### Executive images

linking, *Vol 1*, 4–51 to 4–52

loading, *Vol 1*, 4–52 to 4–56

unloading, *Vol 1*, 4–56 to 4–58

writing, *Vol 1*, 4–48 to 4–50

### Executive mode

ASTs, *Vol 1*, 8–12

Executive stack, *Vol 1*, 2–22

Exit handlers, *Vol 1*, 4–70, 9–74; *Vol 2*, 23–31

debugging, *Vol 1*, 9–77

establishing, *Vol 1*, 9–75

writing, *Vol 1*, 9–77

### Exits

See also Exit handlers

forced, *Vol 1*, 4–70

image, *Vol 1*, 4–68, 9–74

exit\_handler\_block data type, *Vol 2*, B–7

### Explanatory text

in argument documentation, *Vol 2*, 17–10

in routine documentation, *Vol 2*, 17–4

Explicit affinity, *Vol 1*, 4–35

Extended address space, *Vol 1*, 13–3, 13–4

physical address space, *Vol 1*, 13–3

virtual address space, *Vol 1*, 13–4

Extended File Specifications, *Vol 2*, 29–1

benefits, *Vol 2*, 29–1

features, *Vol 2*, 29–2

long file names, *Vol 2*, 29–2

mixed-architecture support, *Vol 2*, 29–5

mixed-version support, *Vol 2*, 29–4

Extents, defining section, *Vol 1*, 12–14, 13–15  
/EXTRACT qualifier  
LIBRARY command, *Vol 2*, 26–2

## F

FAB data type, *Vol 2*, B–7  
FABs (file access blocks), *Vol 2*, 28–15, B–7  
.FACILITY directive, *Vol 1*, 9–58  
Facility identifiers, *Vol 2*, 32–4  
FAO argument, signaling, *Vol 1*, 9–62  
FAO parameter, specifying, *Vol 1*, 9–62  
Fast I/O, *Vol 2*, 23–48 to 23–51  
    benefits, *Vol 2*, 23–48  
    buffer objects, *Vol 2*, 23–49  
Fast Path, *Vol 2*, 23–48, 23–51 to 23–52  
File access, protection, *Vol 2*, B–8  
File access blocks  
    See FABs  
File access strategies, *Vol 2*, 28–2  
File attributes, *Vol 2*, 28–1  
Files  
    attributes, *Vol 2*, 28–1, 28–2  
    complete access, *Vol 2*, 28–2  
    discrete records access, *Vol 2*, 28–2  
    mapping, *Vol 2*, 28–4  
    record-by-record access, *Vol 2*, 28–2  
    sequential, *Vol 2*, 28–12  
    sequential and indexed access, *Vol 2*, 28–2  
File terminators, *Vol 2*, 23–31  
file\_protection data type, *Vol 2*, B–8  
Fixed-size stack frames, *Vol 2*, 18–5  
Flags  
    See also Event flags  
Flag words, bit mask, *Vol 2*, B–14  
Floating-point numbers, *Vol 2*, B–3 to B–11  
    D\_floating complex, *Vol 2*, B–3  
    D\_floating standard, *Vol 2*, B–9  
    F\_floating complex, *Vol 2*, B–3  
    F\_floating standard, *Vol 2*, B–8  
    G\_floating complex, *Vol 2*, B–4  
    G\_floating standard, *Vol 2*, B–9  
    H\_floating complex, *Vol 2*, B–4  
    H\_floating standard, *Vol 2*, B–10  
    S\_floating complex, *Vol 2*, B–5  
    S\_floating standard, *Vol 2*, B–10  
    T\_floating complex, *Vol 2*, B–5  
    T\_floating standard, *Vol 2*, B–11  
    X\_floating complex, *Vol 2*, B–6  
    X\_floating standard, *Vol 2*, B–11  
Floating-point overflow, *Vol 1*, 9–16  
Floating-Point Registers and Execution Data  
    Blocks  
    See FREDs  
Floating-point register usage, *Vol 2*, 18–3

Floating-point underflow, *Vol 1*, 9–16  
floating\_point data type, *Vol 2*, B–8  
Forced exit, *Vol 1*, 4–70  
Foreign commands, *Vol 2*, 24–3  
Foreign devices, *Vol 2*, 23–5  
Foreign volumes, *Vol 2*, 23–4, 23–6  
Format convention of equivalence names, *Vol 2*,  
    34–17  
Format convention of logical names, *Vol 2*, 34–17  
Format heading, *Vol 2*, 17–2  
    See also System routine documentation  
Fortran  
    Compaq Fortran 90, *Vol 1*, 1–12  
    Compaq Fortran for OpenVMS Alpha, *Vol 1*,  
        1–11  
    Compaq Fortran for OpenVMS VAX, *Vol 1*,  
        1–11  
    data type declarations, *Vol 2*, B–34  
    implementation table, *Vol 2*, B–34  
FREDs (Floating-Point Registers and Execution  
    Data Blocks), *Vol 1*, 2–22  
Function code  
    SYS\$ACM  
        ACME\$\_FC\_AUTHENTICATE\_  
            PRINCIPAL, *Vol 2*, 33–4  
Function codes, *Vol 2*, 23–10  
    SYS\$ACM  
        ACME\$\_FC\_AUTHENTICATE\_  
            PRINCIPAL, *Vol 2*, 33–4  
        ACME\$\_FC\_CHANGE\_PASSWORD, *Vol 2*,  
            33–4  
            reference, *Vol 2*, 33–19  
        ACME\$\_FC\_EVENT, *Vol 2*, 33–5  
        ACME\$\_FC\_FREE\_CONTEXT, *Vol 2*, 33–5  
        ACME\$\_FC\_QUERY, *Vol 2*, 33–4  
        ACME\$\_FC\_RELEASE\_CREDENTIALS,  
            *Vol 2*, 33–4  
Function modifiers, *Vol 2*, 23–11  
    ACME\$\_M\_ACQUIRE\_CREDENTIALS, *Vol 2*,  
        33–5  
    ACME\$\_M\_COPY\_PERSONA, *Vol 2*, 33–5  
    ACME\$\_M\_DEFAULT\_PRINCIPAL, *Vol 2*, 33–5  
    ACME\$\_M\_FOREIGN\_POLICY\_HINTS, *Vol 2*,  
        33–5  
    ACME\$\_M\_MERGE\_PERSONA, *Vol 2*, 33–5  
    ACME\$\_M\_NOAUDIT, *Vol 2*, 33–5  
    ACME\$\_M\_NOAUTHORIZATION, *Vol 2*, 33–5  
    ACME\$\_M\_OVERRIDE\_MAPPING, *Vol 2*, 33–5  
    ACME\$\_M\_UCS2\_4, *Vol 2*, 33–5, 33–8, 33–16  
    IO\$\_M\_INHERLOG, *Vol 2*, 23–6  
    types of  
        IO\$\_M\_DATACHECK, *Vol 2*, 23–11  
        IO\$\_M\_INHRETRY, *Vol 2*, 23–11  
Function value returns, for RTL routines, *Vol 2*,  
    19–6

function\_code data type, *Vol 2*, B-11

## G

Global sections, *Vol 1*, 12-15, 13-16; *Vol 2*, 26-9, B-16  
characteristics, *Vol 1*, 12-15, 13-16  
definition, *Vol 1*, 12-12, 13-13  
for interprocess communication, *Vol 1*, 3-8  
mapping, *Vol 1*, 12-19, 13-19  
multiprocessing, *Vol 1*, 6-19  
name, *Vol 1*, 12-16, 13-17  
paging file, *Vol 1*, 12-20, 13-20  
permanent, *Vol 2*, 26-13  
temporary, *Vol 2*, 26-13  
writable, *Vol 1*, 6-19  
Global symbols, *Vol 2*, 26-4  
  signaling with, *Vol 1*, 9-61  
GMT (Greenwich Mean Time), *Vol 2*, 27-36  
GOTO unwind operations, *Vol 1*, 9-49  
Granularity  
  of resources, *Vol 1*, 7-6  
  on OpenVMS Alpha systems, *Vol 1*, 6-3  
  on OpenVMS VAX systems, *Vol 1*, 6-3  
Graphical interfaces, creating, *Vol 1*, 1-20  
Group logical name tables, *Vol 2*, 34-6

## H

Handlers, change and compatibility modes, *Vol 1*, 9-11  
Hardware process control blocks  
  See HWPCBs  
Hardware registers  
  for Alpha, *Vol 2*, 18-2  
  for VAX, *Vol 2*, 18-1  
.H files  
  from SYS\$STARLET\_C.TLB to support Compaq  
  POSIX Threads Library, *Vol 2*, 21-2  
  provided by SYS\$STARLET\_C.TLB, *Vol 2*, 21-2  
Hibernation, *Vol 1*, 4-63  
  alternate method, *Vol 1*, 4-66  
  and AST, *Vol 1*, 8-13  
  compared with suspension, *Vol 1*, 4-64  
High-performance sort, *Vol 1*, 1-19  
Holder Hidden attribute, *Vol 2*, 32-5  
Holder records, *Vol 2*, 32-8  
  adding, *Vol 2*, 32-12  
  format, *Vol 2*, 32-9  
  modifying, *Vol 2*, 32-14  
  removing, *Vol 2*, 32-16  
HWPCBs (hardware process control blocks), *Vol 1*, 2-21, 2-22

## I

I/O (input/output)  
  asynchronous, *Vol 2*, 23-21  
  checking device type, *Vol 2*, 23-29  
  complex, *Vol 2*, 22-2  
  echo, *Vol 2*, 22-40  
  exit handler, *Vol 2*, 23-31  
  lowercase, *Vol 2*, 22-42  
  reading a single line, *Vol 2*, 22-4  
  reading several lines, *Vol 2*, 22-5  
  screen updates, *Vol 2*, 22-31  
  simple, *Vol 2*, 22-2  
  status, *Vol 2*, 23-22  
  synchronous, *Vol 2*, 23-19  
  terminator, *Vol 2*, 22-4  
    end of file, *Vol 2*, 23-31  
    record, *Vol 2*, 23-31  
  timeout, *Vol 2*, 22-41  
  unsolicited input, *Vol 2*, 22-36  
  uppercase, *Vol 2*, 22-42  
  using SYS\$QIO system service, *Vol 2*, 23-23  
  using SYS\$QIOW system service, *Vol 2*, 23-23  
  writing simple character data, *Vol 2*, 22-6  
I/O channel indexes, *Vol 2*, B-3  
I/O channels, *Vol 2*, 23-11  
  deassigning, *Vol 2*, 23-24  
I/O completion  
  recommended test, *Vol 2*, 23-18  
  status, *Vol 2*, 23-23  
  synchronizing, *Vol 2*, 23-13  
I/O functions  
  codes, *Vol 2*, 23-10, 23-13  
  modifier, *Vol 2*, 23-11  
I/O operations  
  logical, *Vol 2*, 23-6  
  overview, *Vol 2*, 23-2  
  physical, *Vol 2*, 23-5  
  quotas, privileges, and protection, *Vol 2*, 23-2  
  virtual, *Vol 2*, 23-6  
I/O performance  
  Fast I/O, *Vol 2*, 23-48  
  Fast Path, *Vol 2*, 23-48  
I/O requests  
  canceling, *Vol 2*, 23-26  
  queuing, *Vol 2*, 23-12  
I/O services  
  asynchronous version, *Vol 2*, 23-19  
  synchronous version, *Vol 2*, 23-19  
I/O status blocks  
  See IOSBs  
I/O system services, *Vol 1*, 1-18  
ICBs (invocation context blocks), *Vol 2*, B-12  
ICC system services, *Vol 1*, 3-21  
identifier data type, *Vol 2*, B-11

- Identifier names, translating, *Vol 2*, 32–11
- Identifier records, *Vol 2*, 32–8
  - adding to rights database, *Vol 2*, 32–12
  - format, *Vol 2*, 32–8
  - modifying, *Vol 2*, 32–13
  - removing from rights database, *Vol 2*, 32–16
- Identifiers, *Vol 2*, 32–1, 32–2
  - adding to rights database, *Vol 2*, 32–12
  - attributes, *Vol 2*, 32–4, 32–5
  - defining, *Vol 2*, 32–1
  - determining holders of, *Vol 2*, 32–13
  - facility, *Vol 2*, 32–4
  - format, *Vol 2*, 32–2
  - general, *Vol 2*, 32–2
  - global sections, *Vol 2*, B–16
  - new attributes, *Vol 2*, 32–5
  - removing from rights database, *Vol 2*, 32–16
  - rights, *Vol 2*, B–16
  - rights database, *Vol 2*, B–16
  - system-defined, *Vol 2*, 32–3
  - UIC, *Vol 2*, 32–3
  - user, *Vol 2*, B–16, B–17
- Identifier values, translating, *Vol 2*, 32–11
- If states, composed input, *Vol 2*, 22–29
- IMAGELIB.OLB file, *Vol 2*, 26–5
- Image rundown, *Vol 1*, 9–74
- Image rundown, effect on logical names, *Vol 2*, 34–5
- Images
  - exit, *Vol 1*, 4–68
  - exiting, *Vol 1*, 9–74
  - for subprocess, *Vol 1*, 2–12
  - loading site-specific, *Vol 2*, 32–30
  - rundown activity, *Vol 1*, 4–69
  - shareable, *Vol 2*, 26–3
- Image sections, *Vol 1*, 12–25, 13–23
- Impersonation services, *Vol 2*, 32–20
- Implementation tables
  - Ada, *Vol 2*, B–17
  - APL, *Vol 2*, B–20
  - BASIC, *Vol 2*, B–22
  - BLISS, *Vol 2*, B–25
  - C and C++, *Vol 2*, B–28
  - COBOL, *Vol 2*, B–30
  - Fortran, *Vol 2*, B–34
  - MACRO language, *Vol 2*, B–48
  - OpenVMS usage, *Vol 2*, B–1
  - Pascal, *Vol 2*, B–38
  - PL/I, *Vol 2*, B–42
  - RPG II, *Vol 2*, B–50
  - SCAN, *Vol 2*, B–52
- Implicit affinity, *Vol 1*, 4–35
- IM semaphore, *Vol 1*, 6–17
- Initialization
  - argument list, *Vol 2*, 35–5
  - volume
    - from within a program, *Vol 2*, 23–36
    - within a program
- Initialization
  - volume
    - within a program (cont'd)
      - example, *Vol 2*, 23–36
- Initialization routines
  - declaring, *Vol 2*, 35–6
  - dispatching, *Vol 2*, 35–7
  - options, *Vol 2*, 35–7
- INITIALIZATION\_ROUTINE macro, *Vol 1*, 4–50
- Inner mode (IM) semaphore, *Vol 1*, 6–17
- Inner mode access, *Vol 1*, 2–20
- Inner mode ASTs, *Vol 1*, 8–12
- Inner mode synchronization, *Vol 1*, 6–17
- Input address arrays, *Vol 1*, 12–7, 13–9
- Instruction memory barriers, *Vol 1*, 6–16
- Instructions, queue, *Vol 1*, 6–20
- Integer and floating-point routines, *Vol 2*, 24–12
- Integer register usage, *Vol 2*, 18–2
- Interlocked instructions, *Vol 1*, 6–6, 6–15, 6–20
- Interlocked memory instructions, using, *Vol 1*, 6–9
- Internal file identifiers, *Vol 2*, 34–17
- Interpreters, *Vol 1*, 1–11
- Interprocess communication, *Vol 1*, 3–1, 3–7
  - event flags, *Vol 1*, 3–8
  - global sections, *Vol 1*, 3–8
  - lock management services, *Vol 1*, 3–8
  - logical names, *Vol 1*, 3–8
  - mailboxes, *Vol 1*, 3–8
    - using, *Vol 1*, 3–8
  - shareable logical names, *Vol 2*, 34–16
- Interprocess control, *Vol 1*, 3–1
- Interrupt priority level, *Vol 1*, 6–7
  - See IPL
- Interrupt requests, SMP systems, *Vol 1*, 5–2
- Intra-Cluster communications, *Vol 1*, 3–1, 3–21
  - clients, *Vol 1*, 3–26
  - concepts, *Vol 1*, 3–22
  - design considerations, *Vol 1*, 3–23
  - programming considerations, *Vol 1*, 3–25
  - servers, *Vol 1*, 3–25
- Intraprocess communication, *Vol 1*, 3–1
  - common area, *Vol 1*, 3–6
  - global symbols, *Vol 1*, 3–5
- Invocation context blocks
  - See ICBs
- Invocation handles, *Vol 2*, B–12
- invo\_context\_blk data type, *Vol 2*, B–12
- invo\_handle data type, *Vol 2*, B–12
- IOSBs (I/O status blocks), *Vol 1*, 8–4; *Vol 2*, B–12
  - in synchronization, *Vol 2*, 23–13
  - return condition value field, *Vol 2*, 23–23
- io\_status\_block data type, *Vol 2*, B–12
- IPL (interrupt priority level), *Vol 1*, 6–7
- Item codes
  - SYS\$ACM[W]
    - ACME\$\_CONTEXT\_ACME\_ID
      - reference, *Vol 2*, 33–7, 33–15
    - ACME\$\_CONTEXT\_ACME\_NAME

## Item codes

### SYS\$ACM[W]

- ACME\$\_CONTEXT\_ACME\_NAME (cont'd)
    - reference, *Vol 2*, 33-7, 33-15
  - ACME\$\_DIALOGUE\_SUPPORT
    - reference, *Vol 2*, 33-14
  - ACME\$\_EVENT\_DATA\_IN
    - reference, *Vol 2*, 33-17
  - ACME\$\_EVENT\_DATA\_OUT
    - reference, *Vol 2*, 33-17
  - ACME\$\_EVENT\_TYPE
    - reference, *Vol 2*, 33-17
  - ACME\$\_LOGON\_TYPE
    - reference, *Vol 2*, 33-12, 33-13, 33-14
  - ACME\$\_PERSONA\_HANDLE\_IN
    - reference, *Vol 2*, 33-5, 33-22
  - ACME\$\_PERSONA\_HANDLE\_OUT
    - reference, *Vol 2*, 33-5
  - ACME\$\_QUERY\_DATA
    - reference, *Vol 2*, 33-16
  - ACME\$\_QUERY\_KEY\_TYPE
    - reference, *Vol 2*, 33-16
  - ACME\$\_QUERY\_KEY\_VALUE
    - reference, *Vol 2*, 33-16
  - ACME\$\_QUERY\_TYPE
    - reference, *Vol 2*, 33-16
  - ACME\$\_TARGET\_DOI\_ID
    - reference, *Vol 2*, 33-7, 33-15, 33-16
  - ACME\$\_TARGET\_DOI\_NAME
    - reference, *Vol 2*, 33-7, 33-15, 33-16
- Item lists, *Vol 2*, 33-8, 33-13
- chaining, *Vol 1*, 11-4
  - reference, *Vol 2*, 33-9, 33-31
  - segments, *Vol 1*, 11-5
- Itemlists, *Vol 2*, 33-11
- item list segments
- reference, *Vol 2*, 33-9
- itemset, *Vol 2*, 33-9
- reference, *Vol 2*, 33-9, 33-13, 33-31
- itemset entries
- reference, *Vol 2*, 33-8, 33-9, 33-10, 33-12, 33-13, 33-31
- item\_list\_2 data type, *Vol 2*, B-12
- item\_list\_3 data type, *Vol 2*, B-13
- item\_list\_pair data type, *Vol 2*, B-13
- item\_quota\_list data type, *Vol 2*, B-13

## J

Jacket routines, *Vol 2*, 24-1

### JAVA

- applications on OpenVMS, *Vol 2*, 29-1
  - object naming standards, *Vol 2*, 29-1
- Job logical name tables, *Vol 2*, 34-5, 34-15
- JSB call format, *Vol 2*, 17-4
- JSB entry points, *Vol 2*, 19-6

## K

- Kernel mode ASTs, *Vol 1*, 8-12
- Kernel stacks, *Vol 1*, 2-22
- Kernel thread blocks, *Vol 1*, 2-21
- See KTBs
- Kernel threads
- advantages, *Vol 1*, 2-17
  - AST delivery, *Vol 1*, 8-11
  - definition, *Vol 1*, 2-17
  - execution, *Vol 1*, 4-63
  - hibernating, *Vol 1*, 4-63
  - model, *Vol 1*, 2-19
  - priority, *Vol 1*, 4-32
  - region, *Vol 1*, 2-22
  - scheduling, *Vol 1*, 4-32
  - suspending, *Vol 1*, 4-63
- Keypads, reading from, *Vol 2*, 22-26
- Key tables, reading from, *Vol 2*, 22-29
- KTBs (kernel thread blocks), *Vol 1*, 2-21

## L

- Languages
- ANSI/ISO, *Vol 1*, 1-6
  - compilers, *Vol 1*, 1-11
- Large page-file sections, *Vol 1*, 12-30
- Last-chance exception vectors, *Vol 1*, 9-25
- Latin-1 encoding
- reference, *Vol 2*, 33-8
- LDR\$LOAD\_IMAGE routine, *Vol 1*, 4-53 to 4-56
- LDR\$UNLOAD\_IMAGE routine, *Vol 1*, 4-56 to 4-58
- LIB\$ADDDX routine, *Vol 2*, 27-7
- LIB\$ADD\_TIME routine, *Vol 2*, 27-7
- LIB\$ASN\_WTH\_MBX routine, *Vol 1*, 3-10
- LIB\$AST\_IN\_PROG routine, *Vol 2*, 24-22
- LIB\$ATTACH routine, *Vol 2*, 24-9
- LIB\$CALLG routine, *Vol 2*, 24-15
- LIB\$CONVERT\_DATE\_STRING system routine, *Vol 2*, 27-33
- LIB\$CRC routine, *Vol 2*, 24-16
- LIB\$CRC\_TABLE routine, *Vol 2*, 24-16
- LIB\$CREATE\_DIR routine, *Vol 2*, 24-22
- LIB\$CREATE\_USER\_VM\_ZONE routine, *Vol 1*, 14-12, 14-16
- LIB\$CREATE\_VM\_ZONE routine, *Vol 1*, 14-7, 14-16
- LIB\$CRF\_INS\_KEY, *Vol 2*, 25-1
- LIB\$CRF\_INS\_REF, *Vol 2*, 25-1
- LIB\$CRF\_OUTPUT, *Vol 2*, 25-1
- LIB\$CURRENCY system routine, *Vol 2*, 24-20
- LIB\$DATE\_TIME routine, *Vol 2*, 27-9
- LIB\$DAY routine, *Vol 2*, 27-5
- LIB\$DAY\_OF\_WEEK system routine, *Vol 2*, 27-9

LIB\$DECODE\_FAULT routine, *Vol 1*, 9–73  
 LIB\$DEC\_OVER routine, *Vol 1*, 9–16  
 LIB\$DELETE\_LOGICAL routine, *Vol 2*, 24–8  
 LIB\$DELETE\_SYMBOL routine, *Vol 2*, 24–8  
 LIB\$DELETE\_VM\_ZONE routine, *Vol 1*, 14–7, 14–13  
 LIB\$DIGIT\_SEP system routine, *Vol 2*, 24–20  
 LIB\$DISABLE\_CTRL routine, *Vol 2*, 24–9  
 LIB\$DO\_COMMAND routine, *Vol 2*, 24–7  
 LIB\$DT\_FORMAT logical name, *Vol 2*, 27–24, 27–29  
 LIB\$DT\_INPUT\_FORMAT logical name, *Vol 2*, 27–24  
 LIB\$EMUL system routine, *Vol 2*, 24–12  
 LIB\$ENABLE\_CTRL routine, *Vol 2*, 24–9  
 LIB\$ESTABLISH routine, *Vol 1*, 9–4, 9–41  
 LIB\$EXTV system routine, *Vol 2*, 24–10  
 LIB\$EXTZV system routine, *Vol 2*, 24–10  
 LIB\$FFC system routine, *Vol 2*, 24–10  
 LIB\$FFS, *Vol 2*, 24–10  
 LIB\$FILE\_SCAN system routine, *Vol 2*, 24–22, 24–23  
 LIB\$FILE\_SCAN\_END system routine, *Vol 2*, 24–23  
 LIB\$FIND\_FILE system routine, *Vol 2*, 24–22  
 LIB\$FIND\_FILE\_END system routine, *Vol 2*, 24–22  
 LIB\$FIND\_VM\_ZONE routine, *Vol 1*, 14–7  
 LIB\$FIXUP\_FLT routine, *Vol 1*, 9–73  
 LIB\$FLT\_UNDER procedure call, *Vol 2*, 18–14  
 LIB\$FLT\_UNDER routine, *Vol 1*, 9–16  
 LIB\$FREE\_EF system routine, *Vol 2*, 24–16  
 LIB\$FREE\_LUN system routine, *Vol 2*, 24–16  
 LIB\$FREE\_TIMER routine, *Vol 2*, 27–19  
 LIB\$FREE\_VM routine, *Vol 1*, 12–3, 13–6  
 LIB\$FREE\_VM\_PAGE routine, *Vol 1*, 12–3, 13–6  
 LIB\$GETJPI system routine, *Vol 1*, 4–9  
 LIB\$GETQUI routine, *Vol 2*, 27–21  
 LIB\$GET\_COMMON routine, *Vol 1*, 3–6; *Vol 2*, 24–5  
 LIB\$GET\_DATE\_FORMAT system routine, *Vol 2*, 27–34  
 LIB\$GET\_EF system routine, *Vol 2*, 24–16  
 LIB\$GET\_FOREIGN routine, *Vol 2*, 24–3  
 LIB\$GET\_INPUT procedure call, *Vol 2*, 19–4  
 LIB\$GET\_INPUT routine, *Vol 2*, 22–4 to 22–6  
     example, *Vol 2*, 22–4  
     obtaining several lines of input, *Vol 2*, 22–5  
     obtaining single line of input, *Vol 2*, 22–4  
     prompt, *Vol 2*, 22–4  
 LIB\$GET\_LUN system routine, *Vol 2*, 24–16  
 LIB\$GET\_SYMBOL routine, *Vol 2*, 24–8  
 LIB\$GET\_VM routine, *Vol 1*, 12–3, 13–6  
 LIB\$GET\_VM\_PAGE routine, *Vol 1*, 12–3, 13–6  
 LIB\$INITIALIZE routine, *Vol 2*, 35–1  
 LIB\$INIT\_DATE\_TIME\_CONTEXT system routine, *Vol 2*, 27–24  
 LIB\$INIT\_TIMER routine, *Vol 2*, 27–19  
 LIB\$INSERT\_TREE routine, *Vol 2*, 24–29  
 LIB\$INSQHI system routine, *Vol 2*, 24–13  
 LIB\$INSQTI system routine, *Vol 2*, 24–13  
 LIB\$INSV system routine, *Vol 2*, 24–10  
 LIB\$INT\_OVER routine, *Vol 1*, 9–16  
 LIB\$LOCC system routine, *Vol 2*, 24–14  
 LIB\$LOOKUP\_TREE routine, *Vol 2*, 24–29  
 LIB\$LP\_LINES system routine, *Vol 2*, 24–20  
 LIB\$MATCHC system routine, *Vol 2*, 24–14  
 LIB\$MATCH\_COND routine, *Vol 1*, 9–34, 9–65, 9–73  
 LIB\$MOVC3 system routine, *Vol 2*, 24–14  
 LIB\$MOVC5 system routine, *Vol 2*, 24–14  
 LIB\$MOVTC system routine, *Vol 2*, 24–14  
 LIB\$MOVTUC system routine, *Vol 2*, 24–14  
 LIB\$MULTF\_DELTA\_TIME routine, *Vol 2*, 27–7  
 LIB\$MULT\_DELTA\_TIME routine, *Vol 2*, 27–7  
 LIB\$PUT\_COMMON routine, *Vol 1*, 3–6; *Vol 2*, 24–5  
 LIB\$PUT\_OUTPUT routine, *Vol 2*, 22–4  
     example, *Vol 2*, 22–7  
     writing simple output, *Vol 2*, 22–6  
 LIB\$RADIX\_POINT system routine, *Vol 2*, 24–20  
 LIB\$REMQHI system routine, *Vol 2*, 24–13  
 LIB\$REMQTI system routine, *Vol 2*, 24–13  
 LIB\$RESERVE\_EF system routine, *Vol 2*, 24–16  
 LIB\$RESET\_VM\_ZONE routine, *Vol 1*, 14–6, 14–13  
 LIB\$REVERT routine, *Vol 1*, 9–4, 9–5  
 LIB\$RUN\_PROGRAM routine, *Vol 2*, 24–5  
 LIB\$SCANC system routine, *Vol 2*, 24–14  
 LIB\$SET\_LOGICAL routine, *Vol 2*, 24–8  
 LIB\$SET\_SYMBOL routine, *Vol 2*, 24–8  
 LIB\$SHOW\_TIMER procedure call, *Vol 2*, 19–2  
 LIB\$SHOW\_TIMER routine, *Vol 2*, 27–19  
 LIB\$SHOW\_VM\_ZONE routine, *Vol 1*, 14–7  
 LIB\$SIGNAL procedure call, *Vol 2*, 19–2  
 LIB\$SIGNAL routine, *Vol 1*, 9–3, 9–5, 9–16, 9–28, 9–34, 9–35, 9–36, 9–50, 9–57, 9–64  
     generating signals, *Vol 1*, 9–30  
     invoking, *Vol 1*, 9–30  
 LIB\$SIG\_TO\_RET routine, *Vol 1*, 9–71  
     establishing, *Vol 1*, 9–72  
 LIB\$SIG\_TO\_STOP routine, *Vol 1*, 9–72  
 LIB\$SIM\_TRAP routine, *Vol 1*, 9–64, 9–71  
 LIB\$SKPC system routine, *Vol 2*, 24–14  
 LIB\$SPANC system routine, *Vol 2*, 24–14  
 LIB\$SPAWN routine, *Vol 2*, 24–9  
 LIB\$STAT\_TIMER routine, *Vol 2*, 27–19  
 LIB\$STOP routine, *Vol 1*, 9–3, 9–5, 9–7, 9–28, 9–34, 9–36, 9–45, 9–50, 9–57, 9–64  
     generating signals, *Vol 1*, 9–30  
 LIB\$SUBX routine, *Vol 2*, 27–7



LIB\$SUB\_TIME routine, *Vol 2*, 27–7

LIB\$TRAVERSE\_TREE routine, *Vol 2*, 24–29

LIB\$VERIFY\_VM\_ZONE routine, *Vol 1*, 14–7

Librarian utility (LIBRARIAN), *Vol 1*, 1–12

Libraries

- default object, *Vol 2*, 26–2
- macro, *Vol 2*, 26–3, 26–5
- message object module, *Vol 1*, 9–60
- object, *Vol 2*, 26–2, 26–5
  - adding modules, *Vol 2*, 26–2
  - creating, *Vol 2*, 26–2
  - deleting a module, *Vol 2*, 26–2
  - extracting a module, *Vol 2*, 26–2
  - listing modules, *Vol 2*, 26–2
  - replacing modules, *Vol 2*, 26–2
  - system default, *Vol 2*, 26–2
  - user default, *Vol 2*, 26–2
- system default, *Vol 2*, 26–5
- text, *Vol 2*, 26–3
- user default, *Vol 2*, 26–5

LIBRARY command

- /CREATE qualifier, *Vol 2*, 26–2
- /DELETE qualifier, *Vol 2*, 26–3
- /EXTRACT qualifier, *Vol 2*, 26–3
- /LIST qualifier, *Vol 2*, 26–2
- /REPLACE qualifier, *Vol 2*, 26–2

Line editing, inhibiting, *Vol 2*, 22–42

LINK/SHAREABLE command, *Vol 2*, 26–7

Linkage sections, *Vol 1*, 12–10

Linker utility, *Vol 1*, 1–12

Linker utility, searching object libraries, *Vol 2*, 26–2

/LIST qualifier

- LIBRARY command, *Vol 2*, 26–2

LNK\$LIBRARY routine, *Vol 2*, 26–2

See also Libraries

See also Linker utility (LINK)

Load-locked instructions, *Vol 1*, 6–8, 6–20

Local buffer caching, with lock management service, *Vol 1*, 7–23

Local symbols, *Vol 2*, 26–4

- signaling with, *Vol 1*, 9–61

LOCKIDTBL\_MAX parameter, *Vol 1*, 7–13

Lock limits, *Vol 1*, 7–11

Lock management system services

- for interprocess communication, *Vol 1*, 3–8

Lock manager, *Vol 1*, 7–1; *Vol 2*, B–13

See also Synchronization and Distributed lock manager

- ENQLM quota, *Vol 1*, 7–12
- LOCKIDTBL size, *Vol 1*, 7–13
- resource hash table quota, *Vol 1*, 7–13
- sub-resource and sub-lock quota, *Vol 1*, 7–12

Lock quotas, *Vol 1*, 7–11

Lock requests

- queuing, *Vol 1*, 7–9
- queuing a lock request, *Vol 1*, 7–14

Lock requests (cont'd)

- synchronizing, *Vol 1*, 7–16

Locks

- choice of mode, *Vol 1*, 7–7
- concept of, *Vol 1*, 7–5
- conversion, *Vol 1*, 7–10, 7–17, 7–18
- deadlock detection, *Vol 1*, 7–11
- dequeuing, *Vol 1*, 7–21
- level, *Vol 1*, 7–8
- mode, *Vol 1*, 7–7

Lock status blocks, *Vol 1*, 7–16

Lock value blocks

- description, *Vol 1*, 7–20
- using, *Vol 1*, 7–23

Lock values, *Vol 2*, B–13

lock\_id data type, *Vol 2*, B–13

lock\_status\_block data type, *Vol 2*, B–13

lock\_value\_block data type, *Vol 2*, B–14

Logical I/Os

- operations, *Vol 2*, 23–6
- privilege, *Vol 2*, 23–4, 23–5, 23–6

Logical names, *Vol 2*, 23–27, C–16

- attributes, *Vol 2*, 34–13
- creating with SYS\$CRELNM, *Vol 2*, 34–18
- defining, *Vol 2*, 34–2
- deleting with SYS\$DELLNM, *Vol 2*, 34–21
- format convention, *Vol 2*, 34–17
- image rundown, *Vol 2*, 34–5
- LIB\$DT\_FORMAT, *Vol 2*, 27–24
- LIB\$DT\_INPUT\_FORMAT, *Vol 2*, 27–24
- multivalued, *Vol 2*, 34–2
- superseding, *Vol 2*, 34–13
- SYS\$LANGUAGE, *Vol 2*, 27–24
- translating, *Vol 2*, 34–11
- translating with SYS\$TRNLNM, *Vol 2*, 34–22

Logical names, for interprocess communication, *Vol 1*, 3–8

Logical name system service calls

- SYS\$CRELNM system service, *Vol 2*, 34–18
- SYS\$CRELNT system service, *Vol 2*, 34–21
- SYS\$DELLNM system service, *Vol 2*, 34–21
- SYS\$TRNLNM system service, *Vol 2*, 34–22

Logical name table names and search lists, *Vol 2*, 34–7

Logical name tables

- clusterwide, *Vol 2*, 34–6, 34–8
- creating with SYS\$CRELNT, *Vol 2*, 34–21
- default, *Vol 2*, 34–4
- directory, *Vol 2*, 34–3
- group, *Vol 2*, 34–6
- job, *Vol 2*, 34–5
- predefined logical names, *Vol 2*, 34–3
- process, *Vol 2*, 34–4
- process-private, *Vol 2*, 34–8
- quotas, *Vol 2*, 34–15
- search list, *Vol 2*, 34–8
  - modifying, *Vol 2*, 34–8
- shareable, *Vol 2*, 34–8

Logical name tables (cont'd)  
 system, *Vol 2*, 34–6  
 types, *Vol 2*, 34–3  
 user-defined, *Vol 2*, 34–8  
 Logical unit numbers, allocating, *Vol 2*, 24–16  
 logical\_name data type, *Vol 2*, B–14  
 LOGINOUT  
 creating SYS\$LOGIN logical name, *Vol 1*, 2–8  
 creating SYS\$LOGIN\_DEVICE logical name,  
*Vol 1*, 2–8  
 creating SYS\$SCRATCH logical name, *Vol 1*,  
 2–8  
 LOGINOUT sample program, *Vol 1*, 2–8  
 longword\_signed data type, *Vol 2*, B–14  
 longword\_unsigned data type, *Vol 2*, B–14  
 LSE/SCA, *Vol 1*, 1–10

## M

MACRO  
 MACRO-32 Compiler, *Vol 1*, 1–12  
 MACRO-64 Assembler, *Vol 1*, 1–12  
 MACRO-32 compiler  
 alignment, *Vol 1*, 15–6  
 consequences of noncompliant code, *Vol 1*, 6–9  
 MACRO-64 assembler, consequences of  
 noncompliant code, *Vol 1*, 6–9  
 MACRO language  
 data type declarations, *Vol 2*, B–48  
 generating argument lists, *Vol 2*, A–1  
 implementation table, *Vol 2*, B–48  
 VAX MACRO, *Vol 1*, 1–12  
 Macro libraries, *Vol 2*, 26–5  
 Macros  
 calling system services, *Vol 2*, A–5  
 expansion, *Vol 2*, A–4  
 generating argument list  
 CALLG instruction, *Vol 2*, A–6  
 CALLS instruction, *Vol 2*, A–6  
 system services, *Vol 2*, 20–1, A–1  
 Magnetic tapes  
 initializing within a program, *Vol 2*, 23–36  
 example, *Vol 2*, 23–36  
 Mailboxes, *Vol 1*, 3–8, 3–10; *Vol 2*, 20–2, 23–39  
 creating, *Vol 1*, 3–9  
 for interprocess communication, *Vol 1*, 3–8  
 input/output  
 asynchronous, *Vol 1*, 3–11  
 immediate, *Vol 1*, 3–11  
 synchronous, *Vol 1*, 3–11  
 using SYS\$QIO, *Vol 1*, 3–11  
 using SYS\$QIOW, *Vol 1*, 3–11  
 name, *Vol 2*, 23–43  
 permanent, *Vol 1*, 3–9  
 protection, *Vol 2*, 23–4  
 reading data from, *Vol 1*, 3–11  
 system, *Vol 2*, 23–43  
 messages, *Vol 2*, 23–44

Mailboxes (cont'd)  
 temporary, *Vol 1*, 3–9  
 termination, *Vol 1*, 4–74  
 writing data to, *Vol 1*, 3–11  
 Management  
 data, *Vol 1*, 1–20  
 system, *Vol 1*, 1–5  
 Mapped files, *Vol 2*, 28–4  
 closing, *Vol 2*, 28–11  
 saving, *Vol 2*, 28–11  
 mask\_byte data type, *Vol 2*, B–14  
 mask\_longword data type, *Vol 2*, B–14  
 mask\_quadword data type, *Vol 2*, B–14  
 mask\_word data type, *Vol 2*, B–14  
 Mathematical functions, *Vol 1*, 1–16  
 MAXBOBMEN  
 SYSGEN parameter, *Vol 2*, 23–50  
 MAXBOBS0S1  
 SYSGEN parameter, *Vol 2*, 23–50  
 MAXBOBS2  
 SYSGEN parameter, *Vol 2*, 23–50  
 Mechanism argument vectors, *Vol 1*, 9–28, 9–35,  
 9–63; *Vol 2*, B–14  
 on Alpha systems, *Vol 1*, 9–37  
 on VAX systems, *Vol 1*, 9–35  
 Mechanism arrays, format, *Vol 1*, 9–37  
 Mechanism entry, in argument descriptions, *Vol 2*,  
 17–9  
 mechanism\_args data type, *Vol 2*, B–14  
 Memory  
 allocating algorithms, *Vol 1*, 14–7  
 allocating and freeing blocks, *Vol 1*, 14–1  
 allocating and freeing pages, *Vol 1*, 14–1  
 barriers, *Vol 1*, 6–16  
 instructions, *Vol 1*, 6–16  
 locking page into, *Vol 1*, 12–11, 13–13  
 reads and writes  
 on VAX systems, *Vol 1*, 6–4  
 reads and writes on Alpha systems, *Vol 1*, 6–5  
 Memory fragmentation, *Vol 1*, 14–2  
 Memory management system services, *Vol 1*,  
 12–2, 13–5  
 Memory-resident global sections, *Vol 1*, 12–25  
 Menus  
 creating with SMG\$ routines, *Vol 2*, 22–23  
 reading, *Vol 2*, 22–25  
 Messages  
 chaining, *Vol 1*, 9–53  
 displaying, *Vol 1*, 9–50  
 logging, *Vol 1*, 9–56  
 system, *Vol 2*, 20–10  
 Message text, specifying variables in, *Vol 1*, 9–60  
 Message utility (MESSAGE), *Vol 1*, 1–14, 1–19,  
 9–56 to 9–63  
 accessing message object module, *Vol 1*, 9–60  
 associating messages with exception conditions,  
*Vol 1*, 9–57  
 compiling message file, *Vol 1*, 9–60

## Message utility (MESSAGE) (cont'd)

- creating a message object library, *Vol 1, 9–60*
- .END directive, *Vol 1, 9–59*
- .FACILITY directive, *Vol 1, 9–58*
- facility name, *Vol 1, 9–58*
- facility number, *Vol 1, 9–59*
- FAO parameters, *Vol 1, 9–62*
- /FAO\_COUNT qualifier, *Vol 1, 9–60*
- logging messages, *Vol 1, 9–56*
- message object module, *Vol 1, 9–60*
- message text, *Vol 1, 9–59*
- message text variables, *Vol 1, 9–60*
- modifying a message source file, *Vol 1, 9–61*
- .SEVERITY directive, *Vol 1, 9–59*
- source module, *Vol 1, 9–58*
- .TITLE directive, *Vol 1, 9–60*
- Middleware services, *Vol 1, 1–8*
  - client/server software, *Vol 1, 1–7*
- Mixed-language programming, calling conventions,  
*Vol 2, 18–1*
- MMS, *Vol 1, 1–15*
- Modularity, virtual displays, *Vol 2, 22–31*
- MOUNT privilege, *Vol 2, 23–4*
- MTH\$SIN\_R4, *Vol 2, 19–6*
- Multiple execution contexts, *Vol 1, 2–17*
- Multiprocess applications
  - synchronizing, *Vol 1, 6–18*
- Multiprocessor environment, *Vol 1, 6–19*
  - See also Synchronization
  - scheduling, *Vol 1, 6–18*
- Multistreamed work load, *Vol 1, 6–19*

## N

- Name Hidden attribute, *Vol 2, 32–5*
- Name services, *Vol 2, 34–1, C–1*
- Namespaces, listing information, *Vol 2, C–13*
- \$name\_G macro, *Vol 2, A–6*
- \$name\_G macro call, *Vol 2, A–7*
- \$name\_S macro, *Vol 2, A–6*
- \$name\_S macro call, *Vol 2, A–6*
- NARGS keyword, *Vol 2, A–4*
- National Character Set (NCS) utility, *Vol 1, 1–15*
- Natural alignment, *Vol 1, 15–2*
  - performance, *Vol 1, 15–2*
- Network management, *Vol 1, 1–5*
- No Access attribute, *Vol 2, 32–5*
- nondialogue mode
  - reference, *Vol 2, 33–11, 33–12, 33–13, 33–14, 33–24*
- Null devices, *Vol 2, 23–29*
- null\_arg data type, *Vol 2, B–14*
- Numeric time, *Vol 2, 27–7*

## O

- Object files, *Vol 1, 1–11*
- Object libraries, *Vol 2, 26–2, 26–5*
  - adding a module, *Vol 2, 26–2*
  - creating, *Vol 2, 26–2*
  - deleting a module, *Vol 2, 26–2*
  - extracting a module, *Vol 2, 26–2*
  - including message object module, *Vol 1, 9–60*
  - listing modules, *Vol 2, 26–2*
  - replacing a module, *Vol 2, 26–2*
- Object-oriented programming, *Vol 1, 1–11*
- Objects
  - DECdns, *Vol 2, C–4*
  - modifying, *Vol 2, C–6*
  - protected, *Vol 2, 32–23*
- octaword\_signed data type, *Vol 2, B–14*
- octaword\_unsigned data type, *Vol 2, B–14*
- Open standards, *Vol 1, 1–2*
- Open systems, *Vol 1, 1–5*
- Open systems environment, *Vol 1, 1–5*
- OpenVMS Alpha operating systems, *Vol 1, 1–4*
  - migrating to, *Vol 1, 1–4*
- OpenVMS Alpha System-Code Debugger, *Vol 1, 1–13*
- OpenVMS Cluster systems, ICC programming,  
*Vol 1, 3–21*
- OpenVMS Debugger (debugger), *Vol 1, 1–13*
- OpenVMS Debugger utility, *Vol 1, 15–3*
  - alignment, *Vol 1, 15–9*
- OpenVMS RMS
  - See RMS
- OpenVMS systems
  - compatibility, *Vol 1, 1–3*
  - compliance with open standards, *Vol 1, 1–2*
  - configurations, *Vol 1, 1–3*
  - debugger, *Vol 1, 1–13*
  - description, *Vol 1, 1–2*
  - open systems capability, *Vol 1, 1–5*
  - software, *Vol 1, 1–3*
  - system services, *Vol 1, 1–17*
- OpenVMS usage entry, *Vol 2, B–1*
  - in argument descriptions, *Vol 2, 17–6*
- OpenVMS usage implementation table
  - See Implementation tables
- OpenVMS utility routines, *Vol 1, 1–18*
- OPS5, *Vol 1, 1–12*
- Outer mode ASTs, *Vol 1, 8–12*
- Output formatting control routine, *Vol 2, 24–20*
- Overview of the OpenVMS Operating System, *Vol 1, 1–2*

## P

- P0 space, *Vol 1*, 2–22
  - definition, *Vol 1*, 10–2
- P1 space, *Vol 1*, 2–22, 2–23
  - definition, *Vol 1*, 10–2
- Page access, *Vol 2*, B–15
- Page faults, *Vol 2*, 27–18
- Page-file sections
  - larger limits (Alpha), *Vol 1*, 12–30
- Page frame sections, *Vol 1*, 12–25, 13–24
- Pagelets, *Vol 1*, 12–1
- Pages, *Vol 1*, 13–3
  - copy-on-reference, *Vol 1*, 12–15, 13–16
  - demand-zero, *Vol 1*, 12–15, 13–16
  - locking into memory, *Vol 1*, 12–11, 13–13
  - owner, *Vol 1*, 12–9, 13–10
  - ownership and protection, *Vol 1*, 12–9, 13–10
- Page table entries
  - See PTEs
- page\_protection data type, *Vol 2*, B–15
- Paging file sections, *Vol 1*, 12–21, 13–20
  - global, *Vol 1*, 12–20, 13–20
- PALcode (privileged architecture library) code, *Vol 1*, 6–16, 15–3
- Parent lock, *Vol 1*, 7–19
- Partial sections, *Vol 1*, 12–26
- Pascal, *Vol 1*, 1–12
  - data type declarations, *Vol 2*, B–38
  - implementation table, *Vol 2*, B–38
- Passing mechanisms, *Vol 2*, 17–9
  - by descriptor, *Vol 2*, 18–16
    - code, *Vol 2*, 17–10
  - by reference, *Vol 2*, 18–14
  - by value, *Vol 2*, 18–13
  - for arrays, *Vol 2*, 18–18
  - for scalars, *Vol 2*, 18–18
  - for strings, *Vol 2*, 18–18
- Pasteboards, *Vol 2*, 22–10
  - creating, *Vol 2*, 22–11
  - deleting, *Vol 2*, 22–11
  - ID, *Vol 2*, 22–32
  - sharing, *Vol 2*, 22–32
- Patch utility (PATCH), *Vol 1*, 1–15
- PATHWORKS, client/server environment, *Vol 1*, 1–7
- PATHWORKS for OpenVMS, *Vol 2*, 29–1, 29–3
- PCA (performance and coverage analyzer), *Vol 1*, 15–10
  - alignment, *Vol 1*, 15–3
- PCBs (process control blocks), *Vol 1*, 2–21
- Performance, measurement routine, *Vol 2*, 24–17
- Per Kernel Thread Stacks, *Vol 1*, 2–22
- Per-process common areas, *Vol 1*, 3–6
- Persona, *Vol 2*, 32–19
- persona extensions
  - reference, *Vol 2*, 33–24
- Persona extensions, *Vol 2*, 32–22
- personas
  - reference, *Vol 2*, 33–1, 33–5, 33–21, 33–24
- Per-thread security, *Vol 2*, 32–21
- Per-thread security model, *Vol 2*, 32–21
- PFNs (page frame numbers), *Vol 1*, 13–5
- PHDs (process headers), *Vol 1*, 2–21
- Physical device names, *Vol 2*, B–7
- Physical I/Os
  - access checks, *Vol 2*, 23–6
  - operations, *Vol 2*, 23–5
  - privilege, *Vol 2*, 23–3, 23–5, 23–6
- Physical names, *Vol 2*, 23–27
- PID (process identifier), non-existent process, *Vol 2*, 23–12
- PID numbers, *Vol 1*, 4–3, 4–6
  - definition, *Vol 1*, 4–6, 4–9
  - referencing remote processes, *Vol 1*, 4–9
- PL/I
  - Compaq PL/I for OpenVMS Alpha, *Vol 1*, 1–12
  - data type declarations, *Vol 2*, B–42
  - implementation table, *Vol 2*, B–42
  - VAX PL/I, *Vol 1*, 1–12
- Platforms
  - Alpha, *Vol 1*, 1–4
  - VAX, *Vol 1*, 1–4
- Pointers, 64-bit support, *Vol 1*, 11–29, 11–30
- Portability, applications, *Vol 1*, 1–6
- Portable applications, on VAX and Alpha
  - platforms, *Vol 1*, 1–5
- Predefined logical name
  - LN\$M\$FILE\_DEV, *Vol 2*, 34–8
- Primary exception vector, *Vol 1*, 9–24
- primary status
  - reference, *Vol 2*, 33–7, 33–8, 33–9, 33–13, 33–19
- principal names
  - reference, *Vol 2*, 33–14, 33–31
  - reference., *Vol 2*, 33–24
- Printers
  - device widths, *Vol 2*, 22–6
- Private sections, definition, *Vol 1*, 12–12, 13–13
- Privileged architecture library code
  - See PALcode
- Privileged shareable images
  - creating, *Vol 2*, 31–1
  - definition, *Vol 2*, 31–1
- Privileges
  - BYPASS, *Vol 2*, 23–5
  - defined by access mode, *Vol 2*, 20–2
  - I/O operations, *Vol 2*, 23–2
  - IMPERSONATE
    - reference, *Vol 2*, 33–13
  - logical I/Os, *Vol 2*, 23–4 to 23–6

## Privileges (cont'd)

- MOUNT, *Vol 2*, 23–4
  - physical I/Os, *Vol 2*, 23–3, 23–5, 23–6
  - SHARE, *Vol 2*, 23–4, 23–12
  - SS\$\_NOPRIV, *Vol 1*, 9–21
  - SYSTEM, *Vol 2*, 23–5
  - system services, *Vol 2*, 20–2
- Procedure call format, *Vol 2*, 17–3
- Procedure calls, testing for successful completion, *Vol 2*, 18–22, 20–9
- procedure data type, *Vol 2*, B–15
- ## Procedures
- function code, *Vol 2*, B–11
  - operation, *Vol 2*, B–11
  - procedure value, *Vol 2*, 18–8
  - representation, *Vol 2*, 18–8
- Procedure values, *Vol 2*, 18–8, B–15
- Process, directory tables, *Vol 2*, 34–3
- ## Process contexts
- accessing, *Vol 1*, 4–42 to 4–58
  - reading, *Vol 1*, 4–43 to 4–45
  - using with \$GETJPI system service, *Vol 1*, 4–9
  - writing, *Vol 1*, 4–45 to 4–47
- ## Process controls, *Vol 1*, 4–1
- ## Processes
- See also SYS\$GETJPI system service
- See also SYS\$PROCESS\_SCAN system service
- communicating between, *Vol 1*, 3–7
  - communicating within, *Vol 1*, 3–1
    - using logical names, *Vol 1*, 3–2
    - using symbols, *Vol 1*, 3–5
  - creating
    - restrictions, *Vol 1*, 4–3
  - deleting, *Vol 1*, 4–71, 4–74
  - detached, *Vol 1*, 2–1, 2–13
  - disabling swap mode, *Vol 1*, 12–11, 13–12
  - disallowing swapping, *Vol 1*, 12–11, 13–12
  - execution, *Vol 1*, 4–63
  - hibernating, *Vol 1*, 4–63
  - identification, *Vol 1*, 4–3
  - lock information, *Vol 1*, 4–30
  - modes of execution, *Vol 1*, 2–2
  - modifying name, *Vol 1*, 4–41
  - obtaining information about, *Vol 1*, 4–9
    - example, *Vol 1*, 4–9
    - processes on specific nodes, *Vol 1*, 4–21, 4–22
    - synchronously, *Vol 1*, 4–23
    - using LIB\$GETJPI routine, *Vol 1*, 4–5
    - using PIDs, *Vol 1*, 4–5, 4–9
    - using process name, *Vol 1*, 4–6, 4–9
    - using SYS\$GETJPI system service, *Vol 1*, 4–5
    - using SYS\$GETJPIW system service, *Vol 1*, 4–5
  - one process, *Vol 1*, 4–9
  - priority
    - modifying, *Vol 1*, 4–32

## Processes (cont'd)

- privileges
    - setting, *Vol 1*, 4–31
  - scheduling, *Vol 1*, 4–32
  - spawned, *Vol 1*, 2–1
  - subprocess, *Vol 1*, 2–1
  - suspending, *Vol 1*, 4–63, 4–67
  - swapping, *Vol 1*, 12–11, 13–12
  - SYS\$PROCESS\_SCAN system service
    - item lists
      - using to specify selection criteria about processes, *Vol 1*, 4–16, 4–20
      - using with remote procedures, *Vol 1*, 4–24
    - item-specific flags to control selection information, *Vol 1*, 4–16
    - search, *Vol 1*, 4–14
    - termination mailboxes, *Vol 1*, 4–74
    - wildcard search, *Vol 1*, 4–12
- ## Process Header (PHD), *Vol 1*, 2–21
- ## Process identification numbers
- See PID numbers
- ## Processing, distributed, *Vol 1*, 1–5
- ## Process logical name tables, *Vol 2*, 34–4
- ## Process names
- length of for remote processes, *Vol 1*, 4–6
  - obtain information about remote processes
    - example, *Vol 1*, 4–12
  - specifying for local processes, *Vol 1*, 4–6
  - specifying for remote processes, *Vol 1*, 4–6
  - using to obtain information about remote processes, *Vol 1*, 4–6, 4–9, 4–20
- ## Processors
- Alpha, *Vol 1*, 1–3
  - VAX, *Vol 1*, 1–3
- ## Process-private space
- definition, *Vol 1*, 10–2
- ## Process rights lists, *Vol 2*, 32–1
- ## Process searches, *Vol 1*, 4–9 to 4–23
- obtaining information about, *Vol 1*, 4–9
  - searching on all nodes, *Vol 1*, 4–22
  - searching on specific nodes, *Vol 1*, 4–21
  - using item lists
    - with remote procedures, *Vol 1*, 4–24
  - using item-specific flags to control selection information, *Vol 1*, 4–16
  - using SYS\$PROCESS\_SCAN system service
    - item list, *Vol 1*, 4–17
    - using SYS\$PROCESS\_SCAN system service item list to specify processes
      - example, *Vol 1*, 4–20
    - using SYS\$PROCESS\_SCAN system service item list to specify selection criteria about processes, *Vol 1*, 4–20
    - using wildcard on local system, *Vol 1*, 4–12
- ## Process structure, *Vol 1*, 2–19

process\_id data type, *Vol 2*, B-15  
 process\_name data type, *Vol 2*, B-15  
 Production systems, OpenVMS capabilities, *Vol 1*,  
     1-5  
 Program decomposition, *Vol 1*, 6-19  
 Program examples  
     DECdtm, *Vol 2*, 30-39  
 Program execution  
     See also Synchronization  
     specifying a time, *Vol 1*, 4-59, 4-60  
     timed intervals, *Vol 1*, 4-61  
 Programming  
     modular techniques, *Vol 1*, 1-9  
     software development tools, *Vol 1*, 1-9  
     to standards, *Vol 1*, 1-9  
 Programming environment, *Vol 1*, 1-7  
 Programming examples, calling system services,  
     *Vol 2*, 20-11  
 Program regions, *Vol 1*, 12-4, 13-8  
 Prompt for input, with LIB\$GET\_INPUT routine,  
     *Vol 2*, 22-4  
 Protection  
     by access mode, *Vol 2*, 20-2  
     devices, *Vol 2*, 23-5  
     I/O operations, *Vol 2*, 23-2  
     mailboxes, *Vol 2*, 23-4  
     volumes, *Vol 2*, 23-4  
 Protection, page, *Vol 1*, 12-9, 13-10  
 Protection masks, *Vol 2*, 23-4  
 \$PRTDEF macro, *Vol 2*, B-15  
 PTEs (page table entries)  
     extended addresses, *Vol 1*, 13-5

## Q

QIO interface, *Vol 2*, 29-7, 29-8, 29-9  
 quadword\_signed data type, *Vol 2*, B-15  
 quadword\_unsigned data type, *Vol 2*, B-15  
 Queue access routines, *Vol 2*, 24-13  
 Queue information, obtaining, *Vol 2*, 27-21  
 Queues, *Vol 2*, 24-12  
     lock management, *Vol 1*, 7-9  
     self-relative, *Vol 2*, 24-12  
 Queuing ASTs, *Vol 1*, 8-2  
 Quotas, *Vol 2*, B-13  
     AST, *Vol 2*, 23-3  
     buffered I/O, *Vol 2*, 23-3  
     buffered I/O byte count, *Vol 2*, 23-3  
     default logical name table, *Vol 2*, 34-15  
     direct I/O, *Vol 2*, 23-3  
     directory table, *Vol 2*, 34-15  
     I/O operations, *Vol 2*, 23-2  
     job logical name table, *Vol 2*, 34-15  
     logical name tables, *Vol 2*, 34-15  
     SS\$\_EXQUOTA condition value, *Vol 1*, 9-21  
     system service resources, *Vol 2*, 20-2  
     user-defined logical name table, *Vol 2*, 34-16

## R

RAB64 (64-bit record access blocks)  
     data structure, *Vol 1*, 11-15  
     macros, *Vol 1*, 11-17  
     RAB64\$PQ\_x fields, *Vol 1*, 11-15, 11-16  
     RAB64\$Q\_x fields, *Vol 1*, 11-15, 11-16  
 RAB data type, *Vol 2*, B-16  
 RABs (record access blocks), *Vol 2*, 28-15, B-16  
 Read and write operations, ordering, *Vol 1*, 6-4  
 Read-modify-write operations, atomic, *Vol 1*, 6-5  
 Record access blocks  
     See RABs  
 Records, I/O, *Vol 2*, 28-12  
 Records, RMS, *Vol 1*, 1-21  
 Reentrant code, ASTs, *Vol 1*, 8-3  
 Registers  
     data, *Vol 2*, 17-5  
     for returns, *Vol 2*, 17-4, 17-12  
 Register usage  
     for Alpha, *Vol 2*, 18-2  
     for VAX, *Vol 2*, 18-1  
 /REPLACE qualifier  
     LIBRARY command, *Vol 2*, 26-2  
 requests  
     reference, *Vol 2*, 33-14  
 Reserved Memory Registry, *Vol 1*, 16-2  
 Resource attributes, *Vol 2*, 32-5  
 Resource granularity, in lock, *Vol 1*, 7-6  
 Resource quotas, system services, *Vol 2*, 20-2  
 Resources  
     lock management concept, *Vol 1*, 7-5  
     name, *Vol 1*, 7-7  
 Resource wait mode, system service, *Vol 2*, 20-6  
 Return address arrays, *Vol 1*, 12-7, 13-9  
 Return conditions, wait, *Vol 2*, 20-6  
 Return condition values, *Vol 2*, 19-6, 20-7  
 Returns, *Vol 2*, 17-12  
     call frame, *Vol 2*, 18-5  
     condition value, *Vol 2*, 18-22  
     errors, *Vol 2*, 18-22  
     function value, *Vol 2*, 18-22  
     I/O status, *Vol 2*, B-12  
     in I/O status block, *Vol 2*, 17-12  
     in mailbox, *Vol 2*, 17-12  
     object, *Vol 2*, B-11  
     RTL routines, *Vol 2*, 19-6  
     signaled in register, *Vol 2*, 17-12  
     system service condition value, *Vol 2*, 20-7  
 Returns heading, in routine documentation, *Vol 2*,  
     17-4  
 return status  
     reference, *Vol 2*, 33-6, 33-19  
 Return status, *Vol 1*, 9-21  
     from signal, *Vol 1*, 9-72

Return symbols  
 for RTL routines, *Vol 2*, 19–6

Rights databases, *Vol 2*, 32–1, 32–8, 32–16  
 adding to, *Vol 2*, 32–12  
 default protection, *Vol 2*, 32–9  
 elements of, *Vol 2*, 32–10  
 holder record, *Vol 2*, 32–8  
 identifier records, *Vol 2*, 32–8  
 initializing, *Vol 2*, 32–9  
 keys, *Vol 2*, 32–9  
 modifying, *Vol 2*, 32–13, 32–14, 32–16

Rights identifiers  
 See Identifiers

Rights lists  
 process, *Vol 2*, 32–19  
 system, *Vol 2*, 32–19

rights\_holder data type, *Vol 2*, B–16  
 rights\_id data type, *Vol 2*, B–16

RISC architecture, *Vol 1*, 1–4

RMS, *Vol 1*, 1–8, 1–20  
 See also RAB64  
 files and records, *Vol 1*, 1–21  
 interface enhancements, *Vol 1*, 11–14  
 opening file for mapping, *Vol 1*, 12–13, 13–14  
 routines, *Vol 1*, 1–21  
 utilities, *Vol 1*, 1–21

RMS, structures, *Vol 2*, 28–15

RMS files, *Vol 1*, 1–21

Routines  
 callable system, *Vol 1*, 1–15  
 calling, *Vol 2*, 19–1  
 high-performance sort, *Vol 1*, 1–19  
 how to call, *Vol 2*, 19–3  
 processwide resource allocation, *Vol 2*, 24–16  
 RTL, *Vol 1*, 1–16  
 variable-length bit field, *Vol 2*, 24–10

RPG II  
 data type declarations, *Vol 2*, B–50  
 implementation table, *Vol 2*, B–50

RTL jacket handler, *Vol 1*, 9–71

RTL routines  
 See Run-time library routines

RTLs (run-time libraries)  
 condition handling, *Vol 1*, 9–1  
 routines, *Vol 1*, 1–16

Run-time libraries  
 See RTLs

Run-time library routines  
 accessing command language interpreter, *Vol 2*, 24–2  
 accessing operating system components, *Vol 2*, 24–1  
 accessing VAX instruction set, *Vol 2*, 24–9  
 calling, *Vol 2*, 19–1, 19–3  
 entry point, *Vol 2*, 19–3, 19–4, 19–6, 20–4  
 integer and floating-point, *Vol 2*, 24–12  
 interaction with operating system, *Vol 2*, 24–1

Run-time library routines (cont'd)  
 jacket routine, *Vol 2*, 24–1  
 manipulating character string, *Vol 2*, 24–14  
 names, *Vol 2*, 19–3  
 on Alpha systems, *Vol 1*, 9–17  
 output formatting control, *Vol 2*, 24–20  
 performance measurement, *Vol 2*, 24–17  
 queue access, *Vol 2*, 24–12  
 return status, *Vol 1*, 9–21  
 system service access, *Vol 2*, 24–1  
 variable-length bit field instruction, *Vol 2*, 24–10

## S

---

S0 space, definition, *Vol 1*, 10–2

SCAN  
 data type declarations, *Vol 2*, B–52  
 implementation table, *Vol 2*, B–52

Schedulers  
 callback, *Vol 1*, 2–18  
 OpenVMS, *Vol 1*, 2–18  
 POSIX Threads Library, *Vol 1*, 2–18

Scheduling, *Vol 1*, 2–20

Screen management, *Vol 2*, 22–9  
 See also Key tables  
 See also Pasteboards  
 See also Video attributes  
 See also Viewports  
 See also Virtual displays  
 See also Virtual keyboards  
 deleting text, *Vol 2*, 22–23  
 double-width characters, *Vol 2*, 22–20, 22–21  
 drawing lines, *Vol 2*, 22–22  
 inserting characters, *Vol 2*, 22–20  
 menus  
 creating, *Vol 2*, 22–23  
 reading, *Vol 2*, 22–25  
 types of, *Vol 2*, 22–23  
 reading data, *Vol 2*, 22–24  
 scrolling, *Vol 2*, 22–21  
 setting background color, *Vol 2*, 22–11  
 setting screen dimensions, *Vol 2*, 22–11  
 video attributes, *Vol 2*, 22–22  
 viewports, *Vol 2*, 22–19

Scrolling instructions, *Vol 2*, 22–21

Search lists, defining, *Vol 2*, 34–2

Search operations, *Vol 2*, 32–16

Secondary exception vectors, *Vol 1*, 9–24

Sections, *Vol 1*, 12–11, 13–13  
 characteristic, *Vol 1*, 12–14, 13–15  
 creating, *Vol 1*, 12–12, 13–14  
 defining extent, *Vol 1*, 12–14, 13–15  
 deleting, *Vol 1*, 12–24, 13–23; *Vol 2*, 28–11  
 global, *Vol 2*, 26–9  
 global paging file, *Vol 1*, 12–20, 13–20  
 image, *Vol 1*, 12–25, 13–23

Sections (cont'd)

mapping, *Vol 1*, 12–17, 13–18; *Vol 2*, 28–4  
page frame, *Vol 1*, 12–25, 13–24  
paging, *Vol 1*, 12–21, 12–22, 13–20, 13–21  
private, *Vol 2*, 28–5  
releasing, *Vol 1*, 12–24, 13–23  
sharing data, *Vol 1*, 12–23, 13–22  
unmapping, *Vol 1*, 12–24, 13–23  
updating, *Vol 2*, 28–11  
writing back, *Vol 1*, 12–24, 13–23  
section\_id data type, *Vol 2*, B–16  
section\_name data type, *Vol 2*, B–16  
Security model, *Vol 2*, 32–21  
Security profiles  
  displaying, *Vol 2*, 32–24  
  modifying, *Vol 2*, 32–24  
Segments, item lists, *Vol 1*, 11–5  
Sequential files  
  creating, *Vol 2*, 28–12  
  updating, *Vol 2*, 28–13  
Servers, *Vol 1*, 1–6  
Service routines  
  AST, *Vol 1*, 8–8  
SET BREAK debugger command, /HANDLER  
  qualifier, *Vol 1*, 9–70  
SET DISPLAY command  
  creating WSA pseudo workstation devices, *Vol 2*, 22–8  
.SEVERITY directive, *Vol 1*, 9–59  
Shareable images, *Vol 2*, 26–3  
  privileged, *Vol 2*, 31–1  
Shareable logical names, interprocess  
  communication, *Vol 2*, 34–16  
Shared data  
  access, *Vol 1*, 8–3  
  AST synchronization, *Vol 1*, 8–4  
Shared files, *Vol 2*, 26–13  
SHARE privilege, *Vol 2*, 23–4, 23–12  
Sharing data, RMS shared files, *Vol 2*, 26–13  
Signal argument vectors, *Vol 1*, 9–28, 9–32, 9–63  
Signaling, *Vol 1*, 9–33  
  changing to return status, *Vol 1*, 9–72  
SMG\$ADD\_KEY\_DEF routine, *Vol 2*, 22–29  
SMG\$BEGIN\_DISPLAY\_UPDATE routine, *Vol 2*, 22–31  
SMG\$CHANGE\_PBD\_CHARACTERISTICS  
  routine, *Vol 2*, 22–11  
SMG\$CHANGE\_RENDITION routine, *Vol 2*, 22–17  
SMG\$CHANGE\_VIEWPORT routine, *Vol 2*, 22–19  
SMG\$CHANGE\_VIRTUAL\_DISPLAY routine, *Vol 2*, 22–17  
SMG\$CHECK\_FOR\_OCCLUSION routine, *Vol 2*, 22–14

SMG\$CREATE\_KEY\_TABLE routine, *Vol 2*, 22–29  
SMG\$CREATE\_MENU routine, *Vol 2*, 22–24  
SMG\$CREATE\_PASTEBOARD routine, *Vol 2*, 22–10  
SMG\$CREATE\_SUBPROCESS routine, *Vol 2*, 22–18  
SMG\$CREATE\_VIEWPORT routine, *Vol 2*, 22–19  
SMG\$CREATE\_VIRTUAL\_DISPLAY routine, *Vol 2*, 22–10  
SMG\$CREATE\_VIRTUAL\_KEYBOARD routine, *Vol 2*, 22–25  
SMG\$DELETE\_CHARS routine, *Vol 2*, 22–23  
SMG\$DELETE\_LINE routine, *Vol 2*, 22–23  
SMG\$DELETE\_MENU routine, *Vol 2*, 22–24  
SMG\$DELETE\_PASTEBOARD routine, *Vol 2*, 22–11  
SMG\$DELETE\_SUBPROCESS routine, *Vol 2*, 22–18  
SMG\$DELETE\_VIEWPORT routine, *Vol 2*, 22–19  
SMG\$DELETE\_VIRTUAL\_DISPLAY routine, *Vol 2*, 22–16  
SMG\$DRAW\_CHARACTER routine, *Vol 2*, 22–22  
SMG\$DRAW\_CHAR routine, *Vol 2*, 22–20  
SMG\$DRAW\_LINE routine, *Vol 2*, 22–22  
SMG\$DRAW\_RECTANGLE routine, *Vol 2*, 22–22  
SMG\$ENABLE\_UNSOLICITED\_INPUT routine, *Vol 2*, 22–36  
SMG\$END\_DISPLAY\_UPDATE routine, *Vol 2*, 22–31  
SMG\$ERASE\_CHARS routine, *Vol 2*, 22–23  
SMG\$ERASE\_COLUMN routine, *Vol 2*, 22–23  
SMG\$ERASE\_DISPLAY routine, *Vol 2*, 22–23  
SMG\$ERASE\_LINE routine, *Vol 2*, 22–23  
SMG\$ERASE\_PASTEBOARD routine, *Vol 2*, 22–11  
SMG\$EXECUTE\_COMMAND routine, *Vol 2*, 22–18  
SMG\$HOME\_CURSOR routine, *Vol 2*, 22–19  
SMG\$INSERT\_CHARS routine, *Vol 2*, 22–20  
SMG\$INSERT\_LINE routine, *Vol 2*, 22–21  
SMG\$LABEL\_BORDER routine, *Vol 2*, 22–12  
SMG\$LIST\_PASTING\_ORDER routine, *Vol 2*, 22–16  
SMG\$MOVE\_TEXT routine, *Vol 2*, 22–17  
SMG\$MOVE\_VIRTUAL\_DISPLAY routine, *Vol 2*, 22–15  
SMG\$PASTE\_VIRTUAL\_DISPLAY routine, *Vol 2*, 22–10  
SMG\$POP\_VIRTUAL\_DISPLAY routine, *Vol 2*, 22–32  
SMG\$PUT\_CHARS routine, *Vol 2*, 22–20  
SMG\$PUT\_CHARS\_HIGHWIDE routine, *Vol 2*, 22–20  
SMG\$PUT\_CHARS\_MULTI routine, *Vol 2*, 22–20  
SMG\$PUT\_CHARS\_WIDE routine, *Vol 2*, 22–20



SMG\$PUT\_LINE routine, *Vol 2*, 22–21  
 SMG\$PUT\_LINE\_MULTI routine, *Vol 2*, 22–21  
 SMG\$PUT\_LINE\_WIDE routine, *Vol 2*, 22–21  
 SMG\$PUT\_WITH\_SCROLL routine, *Vol 2*, 22–21  
 SMG\$READ\_COMPOSED\_LINE routine, *Vol 2*,  
 22–29  
 SMG\$READ\_FROM\_DISPLAY routine, *Vol 2*,  
 22–25  
 SMG\$READ\_KEYSTROKE routine, *Vol 2*, 22–24  
 SMG\$READ\_STRING routine, *Vol 2*, 22–25  
 SMG\$REPASTE\_VIRTUAL\_DISPLAY routine,  
*Vol 2*, 22–15  
 SMG\$RESTORE\_PHYSICAL\_SCREEN routine,  
*Vol 2*, 22–31  
 SMG\$RETURN\_CURSOR\_POS routine, *Vol 2*,  
 22–19  
 SMG\$SAVE\_PHYSICAL\_SCREEN routine, *Vol 2*,  
 22–31  
 SMG\$SCROLL\_DISPLAY\_AREA routine, *Vol 2*,  
 22–21  
 SMG\$SCROLL\_VIEWPORT routine, *Vol 2*, 22–19  
 SMG\$SELECT\_FROM\_MENU routine, *Vol 2*,  
 22–24  
 SMG\$SET\_BROADCAST\_TRAPPING routine, *Vol*  
*2*, 22–43  
 SMG\$SET\_CURSOR\_ABS routine, *Vol 2*, 22–19  
 SMG\$SET\_CURSOR\_REL routine, *Vol 2*, 22–19  
 SMG\$SET\_DISPLAY\_SCROLL\_REGION routine,  
*Vol 2*, 22–21  
 SMG\$SET\_PHYSICAL\_CURSOR routine, *Vol 2*,  
 22–19  
 SMG\$UNPASTE\_VIRTUAL\_DISPLAY routine,  
*Vol 2*, 22–16  
 SMP (symmetric multiprocessing), *Vol 1*, 5–1  
 goals, *Vol 1*, 5–2  
 Software development life cycle, *Vol 1*, 1–9  
 Software development tools, *Vol 1*, 1–8  
 Software programs, developing, *Vol 1*, 1–7  
 Sort/Merge utility, high-performance routines, *Vol*  
*1*, 1–19  
 Special modes for debugging, *Vol 1*, 1–14  
 Specifying access modes of logical names, *Vol 2*,  
 34–10  
 Specifying attributes of logical names, *Vol 2*,  
 34–13  
 SRM\_CHECK tool  
 location on kit, *Vol 1*, 6–9  
 using to analyze code, *Vol 1*, 6–9  
 SS\$\_ALIGN exception, *Vol 1*, 9–12  
 signal array format, *Vol 1*, 9–15  
 SS\$\_HPARITH exception, *Vol 1*, 9–12  
 signal array format, *Vol 1*, 9–13  
 Stack frames, *Vol 2*, 18–3  
 Stacks  
 for Alpha procedure calls, *Vol 2*, 18–5  
 for VAX procedure calls, *Vol 2*, 18–3  
 Stack usage, *Vol 2*, 18–3, 18–5  
 Standards, open, *Vol 1*, 1–2  
 STARLET.OLB file, *Vol 2*, 26–2, 26–5  
 STARLET data structures and definitions  
 for C programmers, *Vol 2*, 21–1  
 Status codes  
 ACME\$\_INVALIDCTX  
 reference, *Vol 2*, 33–6  
 ACME\$\_NOACMECTX  
 reference, *Vol 2*, 33–7  
 ACME\$\_OPINCOMPL  
 reference, *Vol 2*, 33–7, 33–9, 33–13, 33–31  
 SS\$\_BADBUFLN  
 reference, *Vol 2*, 33–7  
 SS\$\_BADITMCD  
 reference, *Vol 2*, 33–7  
 SS\$\_BADPARAM  
 reference, *Vol 2*, 33–7  
 Store-conditional instructions, *Vol 1*, 6–8  
 Sublock, *Vol 1*, 7–19  
 Subprocesses, *Vol 1*, 2–1  
 connecting to using LIB\$ATTACH routine, *Vol*  
*2*, 24–9  
 creating  
 with LIB\$SPAWN, *Vol 1*, 2–3  
 with SMG\$ routines, *Vol 2*, 22–18  
 with SYS\$CREPRC, *Vol 1*, 2–6  
 creation of using LIB\$SPAWN routine, *Vol 2*,  
 24–9  
 debugging, *Vol 1*, 2–15  
 disk and directory default, *Vol 1*, 2–12  
 image, *Vol 1*, 2–12  
 input, output, and error device, *Vol 1*, 2–7  
 priority setting, *Vol 1*, 4–32  
 Subsystem attribute, *Vol 2*, 32–5  
 Supervisor mode ASTs, *Vol 1*, 8–12  
 Supervisor stack, *Vol 1*, 2–22  
 Suspension, *Vol 1*, 4–63, 4–67  
 compared with hibernation, *Vol 1*, 4–64  
 Swapping  
 by suspension, *Vol 1*, 4–67  
 Symbolic codes, for condition values, *Vol 2*, 20–8  
 Symbolic definition macros, *Vol 2*, A–4  
 Symbolic names, for argument lists, *Vol 2*, A–4  
 Symbols  
 defining, *Vol 2*, 26–3  
 global, *Vol 2*, 26–4  
 local, *Vol 2*, 26–4  
 referring to, *Vol 2*, 26–3  
 storage, *Vol 2*, 26–3  
 unresolved, *Vol 2*, 26–4  
 Symmetric Multiprocessing  
 interrupt requests, *Vol 1*, 5–2  
 tightly coupled, *Vol 1*, 5–1  
 Symmetric Multiprocessing (SMP), *Vol 1*, 5–1  
 Synchronization  
 asynchronous system traps, *Vol 1*, 8–1  
 definition of, *Vol 1*, 6–1

Synchronization (cont'd)

- hardware-level, *Vol 1*, 6–7
- inner mode, *Vol 1*, 6–17
- passing control to another image, *Vol 1*, 4–67
- software-level, *Vol 1*, 6–16
- using detached processes, *Vol 1*, 4–59
- using events flags, *Vol 1*, 6–20
- using process priority, *Vol 1*, 6–18
- using spin locks, *Vol 1*, 6–19
- using subprocesses, *Vol 1*, 4–59
- Synchronous input/output, *Vol 2*, 23–19
- Synchronous system services, *Vol 2*, 20–5
- SYS\$ABORT\_TRANSW system service, *Vol 2*, 30–39
- SYS\$ADD HOLDER system service, *Vol 2*, 32–12
- SYS\$ADD\_IDENT system service, *Vol 2*, 32–12
- SYS\$ADJWSL system service, *Vol 1*, 12–10, 13–11
- SYS\$ALLOC system service
  - example, *Vol 2*, 23–33
- SYS\$ASCEFC system service, *Vol 1*, 6–25
- SYS\$ASCTIM system service, *Vol 2*, 27–6
  - example, *Vol 2*, 27–10
- SYS\$ASCTOID system service, *Vol 2*, 32–11
- SYS\$ASCUTC system service, *Vol 2*, 27–2 to 27–4
- SYS\$ASSIGN system service, *Vol 2*, 23–12
  - example, *Vol 2*, 23–11
- SYS\$BINTIM system service, *Vol 2*, 27–2 to 27–4, 27–6
- SYS\$BINUTC system service, *Vol 2*, 27–2 to 27–4
- SYS\$BRKTHRU system service, *Vol 2*, 22–43
- SYS\$BRKTHRUW system service, *Vol 2*, 22–43
- SYS\$CANCEL system service
  - example, *Vol 2*, 23–26
- SYS\$CANTIM system service, *Vol 2*, 27–13
  - example, *Vol 2*, 27–16
- SYS\$CANWAK system service, *Vol 2*, 27–13, 27–17
- SYS\$CHECK\_ACCESS system service, *Vol 2*, 32–29
- SYS\$CHECK\_PRIVILEGE system service, *Vol 2*, 32–30
- SYS\$CHKPRO system service, *Vol 2*, 32–29
- SYS\$CLREF system service, *Vol 1*, 6–31
- SYS\$COMMAND logical name, *Vol 2*, 34–4
- SYS\$CPU\_CAPABILITIES system service, *Vol 1*, 4–34
- SYS\$CREATE system service, *Vol 2*, 28–10
- SYS\$CREATE\_BUFOBJ\_64 system service, *Vol 2*, 23–49, 23–51
- SYS\$CREATE\_RDB system service, *Vol 2*, 32–9
- SYS\$CREATE\_USER\_PROFILE system service, *Vol 2*, 32–29
- SYS\$CREMBX system service, *Vol 1*, 2–8, 3–9, 4–76
- SYS\$CREPRC system service, example, *Vol 1*, 2–12
- SYS\$CRETVA system service, *Vol 1*, 12–7, 13–9
- SYS\$CRMPSC system service, *Vol 2*, 28–4, 28–5
- SYS\$DACEFC system service, *Vol 1*, 6–27
- SYS\$DALLOC system service, *Vol 2*, 23–33
- SYS\$DASSGN system service, *Vol 2*, 23–12, 28–11
  - example, *Vol 2*, 23–24
- SYS\$DCLAST system service, example, *Vol 1*, 8–10
- SYS\$DCLCMH system service, *Vol 1*, 9–3
- SYS\$DCLEXH system service, *Vol 1*, 9–75
- SYS\$DELETE\_BUFOBJ system service, *Vol 2*, 23–49, 23–51
- SYS\$DELPRC system service, *Vol 1*, 4–74
- SYS\$DELTVA system service, *Vol 2*, 28–11
- SYS\$DEQ system service, example, *Vol 1*, 7–22
- SYS\$DGBLSC system service, *Vol 1*, 13–16
- SYS\$DISMOU system service, *Vol 2*, 23–36
- SYS\$DLCEFC system service, *Vol 1*, 6–27
- SYS\$DNS system service, *Vol 2*, C–1
- SYS\$END\_TRANSW system service, *Vol 2*, 30–39
- SYS\$ENQ system service, example, *Vol 1*, 7–14
- SYS\$ERROR logical name, *Vol 1*, 2–7, 2–8, 2–10, 4–69, 9–42, 9–50, 9–55; *Vol 2*, 34–4
- SYS\$EXIT system service, *Vol 1*, 4–69
- SYS\$EXPREG system service, *Vol 1*, 12–4, 13–8
  - example, *Vol 1*, 12–5, 13–8
- SYS\$FAO system service, *Vol 1*, 9–42, 9–50, 9–55; *Vol 2*, 27–2 to 27–4
  - example, *Vol 2*, 23–38
- SYS\$FIND\_HELD system service, *Vol 2*, 32–13, 32–16
- SYS\$FIND HOLDER system service, *Vol 2*, 32–13, 32–16
- SYS\$FORCEX system service
  - example, *Vol 1*, 4–70
- SYS\$FORMAT\_ACL system service, *Vol 2*, 32–25, 32–26
- SYS\$GETDVI system service, *Vol 2*, 23–29
- SYS\$GETDVIW system service, *Vol 2*, 23–29
- SYS\$GETJPI system service, *Vol 1*, 4–5, 4–9
  - See also SYS\$PROCESS\_SCAN system service
  - AST in target process, *Vol 1*, 4–26
  - buffer, *Vol 1*, 4–24, 4–25
  - control flags, *Vol 1*, 4–26
  - item list
    - specifying criteria to select processes
      - example, *Vol 1*, 4–20
  - item-specific flags, *Vol 1*, 4–16
  - obtaining information about all processes on the local system, *Vol 1*, 4–9 to 4–14
  - obtaining information about one process, *Vol 1*, 4–9
  - obtaining information with wildcard search
    - example, *Vol 1*, 4–13
  - packing information in buffers, *Vol 1*, 4–24, 4–25
  - searching for processes on all nodes, *Vol 1*, 4–22

SYS\$GETJPI system service (cont'd)  
   searching for processes on specific nodes, *Vol 1*,  
     4-21, 4-22  
   searching for selected processes, *Vol 1*, 4-14  
   specifying buffer size, *Vol 1*, 4-24, 4-25  
   specifying criteria to select processes  
     example, *Vol 1*, 4-20  
   swapping processes, *Vol 1*, 4-26  
   synchronizing calls, *Vol 1*, 4-21, 4-22, 4-23  
   using item lists, *Vol 1*, 4-16, 4-24  
     with remote procedures, *Vol 1*, 4-24  
   using multiple \$PROCESS\_SCAN service  
     contexts, *Vol 1*, 4-23  
   using SYS\$PROCESS\_SCAN system service  
     item list to specify selection criteria about  
       processes, *Vol 1*, 4-16, 4-20  
     item-specific flags to control selection  
       information, *Vol 1*, 4-16  
     search, *Vol 1*, 4-14  
   using SYS\$PROCESS\_SCAN system service  
     item list to specify selection criteria about  
       processes, *Vol 1*, 4-17  
   using wildcards, *Vol 1*, 4-9 to 4-14  
     example, *Vol 1*, 4-13  
   using wildcards as pidadr, *Vol 1*, 4-9  
 SYS\$GETJPIW system service, *Vol 1*, 4-5, 4-9  
 SYS\$GETLKI system service, *Vol 1*, 4-30  
 SYS\$GETMSG system service, *Vol 1*, 9-50  
 SYS\$GETQUI system service, *Vol 2*, 27-21  
 SYS\$GETSYI system service, *Vol 2*, 27-21  
 SYS\$GETSYIW system service, *Vol 2*, 27-21  
 SYS\$GETTIM system service, *Vol 2*, 27-2 to 27-4,  
   27-10  
 SYS\$GETUTC system service, *Vol 2*, 27-2 to 27-4  
 SYS\$GET\_ALIGN\_FAULT\_DATA system service,  
   *Vol 1*, 15-10  
 SYS\$GET\_SECURITY system service, *Vol 2*,  
   32-25, 32-26  
 SYS\$GET\_SYS\_ALIGN\_FAULT\_DATA system  
   service, *Vol 1*, 15-11  
 SYS\$GOTO\_UNWIND system service, *Vol 1*,  
   9-45, 9-49  
 SYS\$HIBER system service, *Vol 1*, 4-65  
   example, *Vol 1*, 4-66  
 SYS\$ICC\_ACCEPT system service, *Vol 1*, 3-22,  
   11-9  
 SYS\$ICC\_CLOSE\_ASSOC system service, *Vol 1*,  
   3-21  
 SYS\$ICC\_CONNECT system service, *Vol 1*, 3-21,  
   11-9  
 SYS\$ICC\_CONNECTW system service, *Vol 1*,  
   3-21, 11-9  
 SYS\$ICC\_DISCONNECT system service, *Vol 1*,  
   3-22, 11-9  
 SYS\$ICC\_DISCONNECTW system service, *Vol 1*,  
   3-22, 11-9  
 SYS\$ICC\_OPEN\_ASSOC system service, *Vol 1*,  
   3-21, 11-9  
 SYS\$ICC\_OPEN\_ASSOCW system service, *Vol 1*,  
   11-9  
 SYS\$ICC\_RECEIVE system service, *Vol 1*, 3-22,  
   11-9  
 SYS\$ICC\_RECEIVEW system service, *Vol 1*,  
   3-22, 11-9  
 SYS\$ICC\_REJECT system service, *Vol 1*, 3-22,  
   11-9  
 SYS\$ICC\_REPLY system service, *Vol 1*, 3-22  
 SYS\$ICC\_REPLY system service, *Vol 1*, 11-9  
 SYS\$ICC\_REPLYW system service, *Vol 1*, 3-22,  
   11-9  
 SYS\$ICC\_TRANSCEIVE system service, *Vol 1*,  
   3-22, 11-9  
 SYS\$ICC\_TRANSCEIVEW system service, *Vol 1*,  
   3-22, 11-9  
 SYS\$ICC\_TRANSMIT system service, *Vol 1*, 3-22,  
   11-9  
 SYS\$ICC\_TRANSMITW system service, *Vol 1*,  
   3-22, 11-9  
 SYS\$IDTOASC system service, *Vol 2*, 32-11,  
   32-16  
 SYS\$INIT\_SYS\_ALIGN\_FAULT\_REPORT system  
   service, *Vol 1*, 15-11  
 SYS\$INIT\_VOL system service, *Vol 2*, 23-36  
   example, *Vol 2*, 23-36  
 SYS\$INPUT logical name, *Vol 1*, 2-3, 2-7, 2-8,  
   4-69, 8-5; *Vol 2*, 22-2, 22-4, 22-34, 26-7,  
   34-4, 34-17  
   default value, *Vol 2*, 22-3  
   example, *Vol 1*, 2-4, 2-8, 2-10; *Vol 2*, 22-5,  
     22-33, 24-4, 24-29  
   redefining value, *Vol 2*, 22-3  
   using with LIB\$GET\_INPUT routine, *Vol 2*,  
     22-4  
   using with LIB\$PUT\_OUTPUT routine, *Vol 2*,  
     22-4  
 SYS\$IO\_CLEANUP, *Vol 2*, 23-51  
 SYS\$IO\_PERFORM, *Vol 2*, 23-51  
 SYS\$IO\_SETUP, *Vol 2*, 23-51  
 SYS\$LANGUAGE logical name, *Vol 2*, 27-24  
 SYS\$LCKPAG system service, *Vol 1*, 12-11, 13-12  
 SYS\$LKWSET system service, *Vol 1*, 12-10,  
   13-12  
 SYS\$LOGIN logical name, *Vol 1*, 2-8  
 SYS\$LOGIN\_DEVICE logical name, *Vol 1*, 2-8  
 SYS\$MGBLSC system service, *Vol 2*, 26-9  
 SYS\$MOD\_HOLDER system service, *Vol 2*, 32-14  
 SYS\$MOD\_IDENT system service, *Vol 2*, 32-13  
 SYS\$MOUNT system service, *Vol 2*, 23-34  
 SYS\$NUMTIM system service, *Vol 2*, 27-2 to  
   27-4, 27-7  
 SYS\$NUMUTC system service, *Vol 2*, 27-2 to  
   27-4

SYS\$OPEN system service, *Vol 2*, 28–10  
 SYS\$OUTPUT logical name, *Vol 1*, 2–3, 2–7, 2–8, 4–69, 8–5, 9–42, 9–50, 9–55; *Vol 2*, 22–2, 22–4, 22–6, 22–34, 24–18, 34–4, 34–17  
 default value, *Vol 2*, 22–3  
 example, *Vol 1*, 2–4, 2–10; *Vol 2*, 22–7  
 redefining value, *Vol 2*, 22–3  
 using with LIB\$GET\_INPUT routine, *Vol 2*, 22–4  
 using with LIB\$PUT\_OUTPUT routine, *Vol 2*, 22–4  
 SYS\$PARSE\_ACL system service, *Vol 2*, 32–25, 32–26  
 SYS\$PERM\_DIS\_ALIGN\_FAULT\_REPORT system service, *Vol 1*, 15–10  
 SYS\$PERM\_REPORT\_ALIGN\_FAULT system service, *Vol 1*, 15–10  
 SYS\$PROCESS\_AFFINITY system service, *Vol 1*, 4–36  
 SYS\$PROCESS\_CAPABILITIES system service, *Vol 1*, 4–34  
 SYS\$PROCESS\_SCAN system service, *Vol 1*, 4–5, 4–9  
 See also SYS\$GETJPI system service  
 obtaining information about processes on nodes, *Vol 1*, 4–22 to 4–23  
 obtaining information about processes on specific nodes, *Vol 1*, 4–21, 4–22  
 searching nodes, *Vol 1*, 4–22  
 searching on specific nodes, *Vol 1*, 4–21  
 setting up multiple contexts, *Vol 1*, 4–23  
 termination mailboxes, *Vol 2*, 23–44  
 using item lists, *Vol 1*, 4–16 to 4–24  
 with remote procedures, *Vol 1*, 4–24  
 using item lists to specify selection criteria about processes, *Vol 1*, 4–16, 4–17, 4–20  
 example, *Vol 1*, 4–20  
 using item-specific flags to control selection information, *Vol 1*, 4–16  
 SYS\$PURGWS system service, *Vol 1*, 13–12  
 SYS\$PUTMSG system service, *Vol 1*, 9–6, 9–42, 9–50, 9–55  
 SYS\$QIO system service, *Vol 2*, 23–12  
 example, *Vol 2*, 23–13  
 SYS\$REM HOLDER system service, *Vol 2*, 32–16  
 SYS\$REM\_IDENT system service, *Vol 2*, 32–16  
 SYS\$SCHDWK system service, *Vol 2*, 27–13, 27–16, 27–17  
 canceling, *Vol 2*, 27–17  
 example, *Vol 2*, 27–17  
 request, *Vol 2*, 27–16  
 SYS\$SCRATCH logical name, *Vol 1*, 2–8  
 SYS\$SETEF system service, *Vol 1*, 6–31  
 SYS\$SETEXV system service, *Vol 1*, 9–24  
 example, *Vol 1*, 9–4  
 SYS\$SETIME system service, *Vol 2*, 27–11  
 SYS\$SETIMR system service  
 example with ASTs, *Vol 1*, 8–7  
 routines, *Vol 2*, 27–13  
 SYS\$SETPRN system service, *Vol 1*, 4–41  
 SYS\$SETPRT system service, *Vol 1*, 12–9  
 SYS\$SETPRV system service, *Vol 1*, 4–31  
 SYS\$SETRWM system service, *Vol 2*, 23–2  
 SYS\$SETSWM system service, *Vol 1*, 12–11, 13–12  
 example, *Vol 1*, 12–11, 13–12  
 SYS\$SET\_IMPLICIT\_AFFINITY system service, *Vol 1*, 4–35  
 SYS\$SET\_RESOURCE\_DOMAIN system service, *Vol 1*, 7–7  
 SYS\$SET\_SECURITY system service, *Vol 2*, 32–25, 32–26  
 SYS\$STARLET\_C.TLB  
 adherence to conventions, *Vol 2*, 21–2  
 functional equivalency to STARLETSD.TLB, *Vol 2*, 21–1  
 impact on use of “variant\_struct” and “variant\_union”, *Vol 2*, 21–1  
 potential impact on LIB structures, *Vol 2*, 21–1  
 potential impact on RMS structures, *Vol 2*, 21–1  
 providing .H files, *Vol 2*, 21–2  
 SYS\$START\_ALIGN\_FAULT\_REPORT system service, *Vol 1*, 15–10  
 SYS\$START\_TRANSW system service, *Vol 2*, 30–39  
 SYS\$STOP\_ALIGN\_FAULT\_REPORT system service, *Vol 1*, 15–10  
 SYS\$STOP\_SYS\_ALIGN\_FAULT\_REPORT system service, *Vol 1*, 15–11  
 SYS\$SYNCH system service, *Vol 1*, 6–29; *Vol 2*, 23–18, 23–19  
 SYS\$TIMCON system service, *Vol 2*, 27–2 to 27–4  
 SYS\$ULKPAG system service, *Vol 1*, 12–11, 13–12  
 SYS\$ULWSET system service, *Vol 1*, 12–10, 13–12  
 SYS\$UNWIND system service, *Vol 1*, 9–45, 9–47, 9–49, 9–64, 9–67, 9–72  
 example, *Vol 1*, 9–48  
 SYS\$UPDSEC system service, *Vol 2*, 28–11  
 SYS\$WAITFR system service, *Vol 1*, 6–29  
 SYS\$WAKE system service, *Vol 1*, 4–65  
 example, *Vol 1*, 4–66  
 SYS\$WFLAND system service, *Vol 1*, 6–29  
 SYS\$WFLOR system service, *Vol 1*, 6–29  
 SYSGEN parameter  
 MAXBOBMEN, *Vol 2*, 23–50  
 MAXBOBS0S1, *Vol 2*, 23–50  
 MAXBOBS2, *Vol 2*, 23–50  
 SYSMAN command, class\_schedule, *Vol 1*, 4–37  
 SYSPRV privilege, *Vol 2*, 23–5  
 System, directory table, *Vol 2*, 34–3

- System clock, setting, *Vol 2*, 27–11
- System Dump Analyzer (SDA) utility, *Vol 1*, 1–15
- System information
  - See Timers statistics
- System library, *Vol 2*, 20–1, A–1
- System logical name tables, *Vol 2*, 34–6
- System macro library, default, *Vol 2*, 20–8
- System management, *Vol 1*, 1–5
- System messages, *Vol 2*, 20–10
- System objects, access, *Vol 2*, B–16
- System routine documentation, *Vol 2*, 17–1
  - Arguments heading, *Vol 2*, 17–6
    - access entry, *Vol 2*, 17–8
    - mechanism entry, *Vol 2*, 17–9
    - OpenVMS usage entry, *Vol 2*, 17–6
    - text entry, *Vol 2*, 17–10
    - type entry, *Vol 2*, 17–7
  - Condition Values Returned heading, *Vol 2*, 17–11
    - returns, *Vol 2*, 17–11, 17–12
    - returns in I/O status block, *Vol 2*, 17–12
    - returns in mailbox, *Vol 2*, 17–12
    - returns signaled, *Vol 2*, 17–12
  - Format heading, *Vol 2*, 17–2
    - explanatory text, *Vol 2*, 17–4
    - JSB call format, *Vol 2*, 17–4
    - procedure call format, *Vol 2*, 17–3
  - Returns heading, *Vol 2*, 17–4
    - condition values, *Vol 2*, 17–4
- System routine returns, register data, *Vol 2*, 17–5
- System routines
  - callable, *Vol 1*, 1–8
  - system services
    - asynchronous, *Vol 1*, 6–35
    - synchronous, *Vol 1*, 6–35
- System routine template, understanding, *Vol 2*, 17–1
- Systems
  - exception dispatcher, *Vol 1*, 9–24
- Systems, mailbox, *Vol 2*, 23–43
- System service access, *Vol 2*, 24–1, 24–2
- System services
  - calling, *Vol 2*, 20–1
  - C function prototypes, *Vol 1*, 11–12
  - executing
    - asynchronously, *Vol 2*, 20–5
    - synchronously, *Vol 2*, 20–5
  - execution wait, *Vol 2*, 20–6
  - initializing volumes, *Vol 2*, 23–36
  - loading site-specific, *Vol 2*, 32–30
  - MACRO-32, *Vol 1*, 11–12
  - macros, *Vol 2*, 20–1, A–1
  - obtaining information about processes, *Vol 1*, 4–5, 4–9
  - OpenVMS, *Vol 1*, 1–17
  - privileges, *Vol 2*, 20–2
  - resource wait, *Vol 2*, 20–6

- System services (cont'd)
  - restrictions, *Vol 2*, 20–2
  - return status, *Vol 1*, 9–21
  - SYS\$ACM, *Vol 2*, 33–11
    - reference, *Vol 2*, 33–4, 33–11
  - SYS\$ACMW, *Vol 2*, 33–11
    - testing for successful completion, *Vol 2*, 20–9
- System space, definition, *Vol 1*, 10–2
- System timer
  - canceling, *Vol 1*, 4–63
  - setting, *Vol 1*, 4–62
- system\_access\_id data type, *Vol 2*, B–16

## T

---

- Tape volumes, mounting, *Vol 2*, 23–34
- target DOI
  - reference, *Vol 2*, 33–15
- Terminal characteristics, *Vol 2*, 23–29
- Terminal echo, *Vol 2*, 22–40
  - disabling, *Vol 2*, 22–41
- Terminal I/O, example, *Vol 2*, 23–24
- Terminals, device widths, *Vol 2*, 22–6
- Terminal timeouts, *Vol 2*, 22–41
- Termination mailboxes, *Vol 1*, 4–74; *Vol 2*, 23–44
- Terminators
  - See also I/O (input/output)
  - echos, *Vol 2*, 22–25
  - file, *Vol 2*, 23–31
  - record, *Vol 2*, 23–31
- Text processors, *Vol 1*, 1–10
- Thread manager, *Vol 1*, 2–18
- Threads, *Vol 1*, 9–48
  - Compaq POSIX Threads Library services, *Vol 1*, 1–15
- Time
  - See also Current time
  - absolute, *Vol 2*, 27–1
  - 64-bit system format, *Vol 2*, 27–1
  - 128-bit system format, *Vol 2*, 27–36
  - converting ASCII to binary, *Vol 2*, 27–6
  - delta, *Vol 2*, 27–1
  - getting current system, *Vol 2*, 27–10
  - internal format, *Vol 2*, 27–2
  - numeric and ASCII, *Vol 2*, 27–7
  - setting system, *Vol 2*, 27–11
  - using system services, *Vol 2*, 27–2 to 27–4
- Time, conversions, *Vol 2*, 27–2
- Time, current, *Vol 2*, 27–9
- Time conversions
  - formatting, *Vol 2*, 27–4
- Time format logical names, *Vol 2*, 27–30 to 27–31
- Time manipulation
  - using LIB\$ADDX routine, *Vol 2*, 27–7
  - using LIB\$ADD\_TIMES routine, *Vol 2*, 27–7
  - using LIB\$DAY routine, *Vol 2*, 27–5
  - using LIB\$MULTF\_DELTA\_TIME, *Vol 2*, 27–7

Time manipulation (cont'd)

- using LIB\$MULT\_DELTA\_TIME routine, *Vol 2, 27-7*
- using LIB\$ routines, *Vol 2, 27-5 to 27-7*
- using LIB\$SUBX routine, *Vol 2, 27-7*
- using LIB\$SUB\_TIMES routine, *Vol 2, 27-7*

Timer requests, *Vol 2, 27-13*

- canceling, *Vol 2, 27-16*

Timers

- deallocating, *Vol 2, 27-19*
- initializing, *Vol 2, 27-19*
- obtaining statistics, *Vol 2, 27-19*
- statistics, *Vol 2, 27-18*
  - buffered input/output, *Vol 2, 27-18*
  - CPU time, *Vol 2, 27-18*
  - direct input/output, *Vol 2, 27-18*
  - elapsed time, *Vol 2, 27-18*
  - page faults, *Vol 2, 27-18*

time\_name data type, *Vol 2, B-16*

.TITLE directive, *Vol 1, 9-60*

Tools, alignment, *Vol 1, 15-9*

Traceback handlers, *Vol 1, 9-25*

Transaction processing, distributed environments, *Vol 1, 1-18*

Transactions

- programming, *Vol 2, 30-1*

transaction\_id data type, *Vol 2, B-16*

Translating logical names, *Vol 2, 34-11*

TRM\$M\_TM\_ESCAPE routine, *Vol 2, 22-26*

TRM\$M\_TM\_NOECHO routine, *Vol 2, 22-26*

TRM\$M\_TM\_NOTRMECHO routine, *Vol 2, 22-25*

TRM\$M\_TM\_PURGE routine, *Vol 2, 22-26*

Type-ahead buffers, *Vol 2, 22-39*

Type entry, in argument descriptions, *Vol 2, 17-7*

## U

UFO (user-file open), *Vol 2, 28-10*

- See also User-open routine

uic data type, *Vol 2, B-17*

UICs (user identification codes), *Vol 2, B-16, B-17*

Unalignment, *Vol 1, 15-1*

Unicode (UCS-2), *Vol 2, 29-2*

Unicode encoding

- reference, *Vol 2, 33-8*

Uniprocessor operations, *Vol 1, 6-5*

Unwind condition handlers, *Vol 1, 9-67*

Upcalls, *Vol 1, 2-18*

User capabilities, *Vol 1, 4-33*

User-defined condition values

- signaling, *Vol 1, 9-61*

User-defined logical name tables, *Vol 2, 34-8, 34-16*

User-file open

- See UFO

User identification codes

- See UICs

User interfaces

- programming tools, *Vol 1, 1-19*

User mode ASTs, *Vol 1, 8-12*

User-open routines, *Vol 2, 28-15*

User privileges, *Vol 2, 20-2*

User procedures, *Vol 2, 19-1*

User stacks, *Vol 1, 2-22*

user\_arg data type, *Vol 2, B-17*

Using impersonation system services, *Vol 2, 32-20*

UTC (Coordinated Universal Time)

- system services, *Vol 2, 27-37*

Utility routines, OpenVMS, *Vol 1, 1-18*

## V

Variable-length bit field routine, *Vol 2, 24-10*

Variable-size stack frames, *Vol 2, 18-6*

“variant\_struct”, impact of SYS\$STARLET\_C.TLB, *Vol 2, 21-2*

“variant\_union”, impact of SYS\$STARLET\_C.TLB, *Vol 2, 21-2*

varying\_arg data type, *Vol 2, B-17*

VAX, architecture, *Vol 1, 1-4*

VAX Ada

- See Ada

VAX APL

- See APL

VAX BASIC

- See BASIC

VAX BLISS

- See BLISS

VAX C

- See C

VAXCDEF.TLB

- replaced by new files, *Vol 2, 21-1*

VAX COBOL

- See COBOL

VAX data types

- See Data types

VAX DIBOL, *Vol 1, 1-11*

VAXELN toolkit, *Vol 1, 1-20*

VAX Environment Software Translator

- See VEST

VAX FORTRAN

- See Fortran

VAX instruction set, accessing through run-time library, *Vol 2, 24-9*

VAX language implementation tables

- See Implementation tables

VAX MACRO

- See MACRO

VAX Pascal

- See Pascal

VAX PL/I

- See PL/I

VAX platforms, *Vol 1*, 1–4  
VAX processors, *Vol 1*, 1–3  
VAX RPG II  
    See RPG II  
VAX SCAN  
    See SCAN  
vector\_byte\_signed data type, *Vol 2*, B–17  
vector\_byte\_unsigned data type, *Vol 2*, B–17  
vector\_longword\_signed data type, *Vol 2*, B–17  
vector\_longword\_unsigned data type, *Vol 2*, B–17  
vector\_quadword\_signed data type, *Vol 2*, B–17  
vector\_quadword\_unsigned data type, *Vol 2*, B–17  
vector\_word\_signed data type, *Vol 2*, B–17  
vector\_word\_unsigned data type, *Vol 2*, B–17  
VEST (VAX Environment Software Translator)  
    alignment, *Vol 1*, 15–8  
Video attributes, *Vol 2*, 22–12, 22–18, 22–22  
    current, *Vol 2*, 22–18  
    default, *Vol 2*, 22–18  
vi editor, *Vol 1*, 1–10  
Viewports, *Vol 2*, 22–19  
Virtual address space, *Vol 1*, 12–5, 13–1, 13–8  
    increasing and decreasing, *Vol 1*, 12–4, 13–8  
    mapping section of, *Vol 1*, 12–18, 13–18  
    specifying array, *Vol 1*, 12–7, 13–10  
Virtual displays, *Vol 2*, 22–12  
    See also Viewports  
    checking occlusion, *Vol 2*, 22–14  
    creating, *Vol 2*, 22–12  
    creating a subprocess from, *Vol 2*, 22–18  
    cursor movement, *Vol 2*, 22–21  
    deleting, *Vol 2*, 22–16  
    deleting text, *Vol 2*, 22–23  
    drawing lines, *Vol 2*, 22–22  
    erasing, *Vol 2*, 22–16  
    ID, *Vol 2*, 22–12, 22–33  
    inserting text, *Vol 2*, 22–20, 22–21  
    list pasting order of, *Vol 2*, 22–16  
    logical cursor position, *Vol 2*, 22–19  
    modifying, *Vol 2*, 22–17  
    obtaining the pasting order, *Vol 2*, 22–16  
    overwriting text, *Vol 2*, 22–20, 22–21  
    pasting, *Vol 2*, 22–13  
    physical cursor position, *Vol 2*, 22–19  
    popping, *Vol 2*, 22–16  
    reading data from, *Vol 2*, 22–24  
    rearranging, *Vol 2*, 22–15  
    scrolling, *Vol 2*, 22–21  
    sharing, *Vol 2*, 22–33  
    specifying double-size characters, *Vol 2*, 22–21  
    specifying video attributes, *Vol 2*, 22–12  
    viewports, *Vol 2*, 22–19  
    writing double-width characters, *Vol 2*, 22–20  
    writing text to, *Vol 2*, 22–19  
Virtual I/O, *Vol 2*, 23–6

Virtual keyboards  
    reading data from, *Vol 2*, 22–24, 22–25  
Virtual page size, *Vol 1*, 13–1  
VMS ACME  
    reference, *Vol 2*, 33–5, 33–15  
VMS user names  
    reference, *Vol 2*, 33–5, 33–14  
Volume protection, *Vol 2*, 23–4  
Volumes  
    initializing  
        within a program, *Vol 2*, 23–36  
        example, *Vol 2*, 23–36  
    mounting, *Vol 2*, 23–34

## W

WAIT form services, *Vol 1*, 6–29  
Wait mode, system service, *Vol 2*, 20–6  
Wakeup requests, scheduling, *Vol 2*, 27–16  
Web-enabling tools, *Vol 1*, 1–8  
well-known items  
    reference, *Vol 2*, 33–8  
Wildcard searches  
    obtaining information about processes  
        example, *Vol 1*, 4–13  
    using SYS\$GETJPI system service, *Vol 1*, 4–12  
word\_signed data type, *Vol 2*, B–17  
word\_unsigned data type, *Vol 2*, B–17  
Working sets  
    adjusting size, *Vol 1*, 12–10, 13–11  
    paging, *Vol 1*, 12–9, 13–11  
Write-back sections, *Vol 1*, 12–24, 13–23  
Writing a condition handler  
    example, *Vol 1*, 9–65

## X

X/Open Distributed Transaction Processing  
    XA interfaces, *Vol 2*, 30–1  
XA interface  
    DECdtm, *Vol 2*, 30–15  
XA interfaces  
    X/Open Distributed Transaction Processing, *Vol 2*, 30–1

## Z

Zones, *Vol 1*, 14–6 to 14–14  
    allocation algorithm, *Vol 1*, 14–14  
    attributes, *Vol 1*, 14–8  
    creating, *Vol 1*, 14–7  
    default, *Vol 1*, 14–12  
    deleting, *Vol 1*, 14–7  
    identifier, *Vol 1*, 14–12  
    resetting, *Vol 1*, 14–13  
    user-created, *Vol 1*, 14–6

