

HP ACMS for OpenVMS

Managing Applications

Order Number: AA-N689K-TE

January 2006

This manual describes how to authorize, install, run, and manage *HP ACMS for OpenVMS* applications. It also provides information about controlling the *HP ACMS for OpenVMS* system and its components. For information about managing ACMS systems remotely across a network, see the *HP ACMS for OpenVMS Remote Systems Management Guide*.

Revision/Update Information:	This manual supersedes <i>HP ACMS for OpenVMS Managing Applications, Version 4.5A</i> .
Operating System:	OpenVMS Alpha Version 8.2 OpenVMS I64 Version 8.2-1
Software Version:	<i>HP ACMS for OpenVMS, Version 5.0</i>

Hewlett-Packard Company, L.P.
Palo Alto, California

© Copyright 2006 Hewlett-Packard Development Company, L.P.

Confidential computer software. Valid license from HP required for possession, use or copying. Consistent with FAR 12.211 and 12.212, Commercial Computer Software, Computer Software Documentation, and Technical Data for Commercial Items are licensed to the U.S. Government under vendor's standard commercial license.

The information contained herein is subject to change without notice. The only warranties for HP products and services are set forth in the express warranty statements accompanying such products and services. Nothing herein should be construed as constituting an additional warranty. HP shall not be liable for technical or editorial errors, or omissions contained herein.

Motif is a registered trademark of The Open Group.

Oracle is a registered US trademark of Oracle Corporation, Redwood City, California.

Oracle CODASYL DBMS, Oracle CDD/Administrator, Oracle CDD/Repository, Oracle Rdb, Oracle SQL/Services, Oracle Trace, and Oracle Trace Collector are registered US trademarks of Oracle Corporation, Redwood City, California.

Printed in the US

Contents

Preface	xvii
Part I Managing the ACMS System and ACMS Applications	
1 Introduction to Application Management	
1.1 ACMS Authorization Tools	1-1
1.2 Controlling ACMS Operations	1-2
1.3 Monitoring an ACMS System	1-2
1.4 Tuning an ACMS System	1-3
1.5 ACMS Application Management Tools	1-3
1.6 Learning to Manage an ACMS System	1-4
2 Authorizing and Controlling Terminals	
2.1 How DDU Works	2-1
2.2 How to Run DDU	2-2
2.3 Creating a DDU Definition	2-2
2.4 Copying DDU Definitions	2-3
2.5 Modifying DDU Definitions	2-3
2.5.1 Enabling Autologin Terminals	2-4
2.5.2 Using the /PRINTFILE Qualifier	2-4
2.6 Renaming Device Names in DDU Definitions	2-5
2.7 Removing DDU Definitions	2-5
2.8 DDU DEFAULT Definition	2-5
2.9 Displaying DDU Definitions	2-6
2.10 Defining ACMS-Controlled Terminals	2-7
2.11 Authorizing LAT Terminal Ports as Controlled Terminals	2-8
2.12 Controlling LAT Terminals	2-9
2.12.1 LAT Setup for an Applications Port	2-9
2.12.2 LAT Setup for a Dedicated Service Port	2-10
2.12.2.1 Setup of the Terminal Server Port	2-11
2.12.2.2 Creation of a Service	2-11
2.12.2.3 Creation of Dedicated Service Ports	2-12
2.12.2.4 Association of the Dedicated Service Port with the Desired Service	2-12
2.12.2.5 Terminal Setup	2-13
2.12.2.6 Using a Dedicated Service Port	2-13
2.13 Enabling Automatic User Sign-ins	2-15
2.14 Summary of DDU Commands and Qualifiers	2-15

3 Authorizing Users

3.1	How UDU Works	3-1
3.2	How to Run UDU	3-1
3.3	Running UDU the First Time	3-2
3.4	Authorizing New Users	3-3
3.4.1	Authorizing Users with ADD, COPY, DEFAULT, and \$ALL	3-3
3.4.2	Defining User Initial and Final Tasks	3-4
3.4.3	Defining the Initial Menu Display	3-5
3.4.4	Specifying a Language for a User	3-6
3.4.5	Specifying a Printfile for a User	3-8
3.4.6	Authorizing User Names as Agents	3-9
3.5	Working with Existing UDU Definitions	3-10
3.5.1	Looking at UDU Definitions with SHOW and LIST	3-10
3.5.2	Deleting UDU Definitions	3-11
3.5.3	Renaming UDU Definitions	3-11
3.6	Summary of UDU Commands and Qualifiers	3-11

4 Authorizing Applications

4.1	How AAU Works	4-1
4.2	How to Run AAU	4-2
4.3	Before Authorizing Applications	4-3
4.4	Authorizing New Applications	4-4
4.4.1	Authorizing All Applications with \$ALL	4-4
4.4.2	Authorizing Individual Applications	4-5
4.4.3	Authorizing Applications with /[NO]WILD_SUFFIX	4-5
4.5	Working with Existing AAU Authorizations	4-5
4.5.1	Looking at AAU Authorizations with SHOW and LIST	4-6
4.5.2	Deleting Authorizations from ACMSAAF.DAT	4-6
4.5.3	Renaming AAU Authorizations	4-7
4.6	Summary of AAU Commands and Qualifiers	4-7

5 Creating and Managing Queues

5.1	How ACMSQUEMGR Works	5-1
5.2	How to Run ACMSQUEMGR	5-2
5.3	Managing Task Queues	5-3
5.3.1	Creating Task Queues	5-4
5.3.2	Setting the Characteristics of Task Queues	5-4
5.3.3	Modifying Task Queues	5-4
5.3.4	Deleting Task Queues	5-5
5.3.5	Displaying Task Queue Information	5-5
5.4	Managing Queued Task Elements	5-6
5.4.1	Setting the Characteristics of Queued Task Elements	5-7
5.4.2	Deleting Queued Task Elements	5-7
5.4.3	Displaying Queued Task Elements	5-8
5.5	Backing Up Task Queue Files Online	5-10
5.6	Summary of ACMSQUEMGR Commands and Qualifiers	5-10

6 Using Distributed Forms Processing

6.1	What Is Distributed Forms Processing?	6-1
6.2	Preparing Your System for Distributed Forms Processing	6-2
6.2.1	Common Setup Tasks for Distributed Forms Processing	6-2
6.2.2	Actions Required on Submitter Nodes	6-3
6.2.3	Actions Required on Application Nodes	6-3
6.2.3.1	Assigning Individual Proxy Accounts	6-4
6.2.3.1.1	How ACMS Searches for a User's Proxy	6-4
6.2.3.1.2	Deciding Which Proxy to Use	6-4
6.2.3.1.3	Setting Up the ACMS Proxy File	6-5
6.2.3.1.4	Creating ACMS Proxies	6-6
6.2.3.1.5	Creating OpenVMS Proxies	6-7
6.2.3.2	Assigning a Default Submitter User Name Account	6-7
6.2.3.3	Assigning Proxy Accounts in an OpenVMS Cluster Environment	6-8
6.2.4	File Protection for Application and Form Files	6-8
6.3	Defining Application Specifications	6-9
6.3.1	Using Logical Names for Applications	6-9
6.3.2	Search Lists and Primitive Failover	6-11
6.3.3	Redirecting Users to Other Applications at Run Time	6-12
6.4	Distributed Operations ACMS Performs Automatically	6-13
6.4.1	Automatic File Distribution	6-13
6.4.2	ACMS Systemwide Cache Directory	6-14
6.5	Tailoring ACMS Distributed Forms Processing to Your Site	6-17
6.5.1	Manually Distributing Applications	6-17
6.5.2	Creating Agent-Specific Cache Directories	6-19
6.5.3	Accessing Remote Application Files	6-20
6.6	Managing and Caching HP DECforms Escape Routine Files	6-20
6.6.1	Making Escape Routines Available to the CP Agent	6-20
6.6.2	Privileged Agents that Execute Escape Routines	6-21

7 Using Data Compression

7.1	Overview of Data Compression	7-1
7.1.1	Purpose of Data Compression	7-1
7.1.2	How ACMS Uses Data Compression	7-1
7.1.3	How Data Compression Works	7-2
7.2	How to Use Data Compression	7-2
7.2.1	Rules for Defining Logical Names	7-3
7.2.2	Using Restricted and Unrestricted Modes	7-3
7.2.2.1	Enabling Data Compression in Unrestricted Mode	7-4
7.2.2.2	Enabling Data Compression in Restricted Mode	7-5
7.2.3	Disabling Data Compression	7-7
7.2.4	Enabling Logging of Data Compression	7-7
7.2.4.1	Entries Written to the Audit Log When a New Process Is Started	7-8
7.2.4.2	Entries Written to the Audit Log When Network Connection Is Established	7-8
7.2.5	Disabling Logging of Network Connections	7-10
7.3	Monitoring Data Compression	7-11

8 Controlling the ACMS System

8.1	Starting the ACMS System	8-1
8.1.1	Starting ACMS Automatically	8-2
8.1.2	Starting ACMS Interactively	8-3
8.2	Stopping the ACMS System	8-3
8.2.1	Stopping ACMS Automatically	8-3
8.2.2	Stopping ACMS Interactively	8-4
8.3	Displaying System Information	8-4
8.4	Terminal Subsystem Controller	8-7
8.4.1	Starting the TSC	8-7
8.4.2	Stopping the TSC	8-7
8.5	Operator Terminals	8-7
8.5.1	Enabling Operator Terminals	8-8
8.5.2	Disabling Operator Terminals	8-8
8.6	Queued Task Initiator	8-9
8.6.1	Starting the QTI	8-9
8.6.2	Stopping the QTI	8-9
8.6.3	Displaying QTI Information	8-9
8.7	Task Queues	8-10
8.7.1	Starting Task Queues	8-10
8.7.2	Stopping Task Queues	8-11
8.7.3	Displaying Task Queue Information	8-11
8.8	Canceling ACMS Users	8-12
8.8.1	Canceling Users with the ACMS/CANCEL USER Command	8-12
8.8.2	Canceling Users with ACMSCANCEL.COM	8-12
8.8.3	Displaying User Information	8-13
8.9	Summary of Operator Commands and Qualifiers	8-14

9 Installing and Managing Applications

9.1	Installing Applications	9-1
9.2	Removing Applications	9-2
9.3	Starting Applications	9-3
9.4	Stopping Applications	9-3
9.5	Displaying Application Information	9-4
9.5.1	Displaying Static Information	9-4
9.5.2	Displaying Dynamic Information	9-7
9.6	Modifying Active Applications	9-9
9.6.1	Modifying Application Attributes	9-9
9.6.2	Modifying Server Attributes	9-10
9.6.3	Modifying Task Attributes	9-10
9.7	Replacing a Server Image	9-11
9.8	Maintaining Application Availability	9-12
9.9	Canceling Tasks	9-12
9.10	Displaying Task Information	9-13
9.11	Directing TDMS Hardcopy	9-18

10 Setting ACMS Quotas, Parameters, and Privileges

10.1	Introduction	10-1
10.2	Calculating Parameters and Quotas with ACMSPARAM.COM	10-2
10.2.1	Running ACMSPARAM.COM	10-2
10.2.1.1	GENVAR Phase of ACMSPARAM.COM	10-4
10.2.1.2	GENPAR Phase of ACMSPARAM.COM	10-6
10.2.1.3	WRITEPAR Phase of ACMSPARAM.COM	10-6
10.2.2	Supplying Variable Values for ACMSPARAM.COM	10-8
10.2.2.1	Supplying Variables with ACMS\$MONITOR.COM	10-9
10.2.2.2	Editing ACMVARINI.DAT to Supply Variables to ACMSPARAM.COM	10-13
10.3	Calculating EXC Process Quotas with ACMEXCPAR.COM	10-25
10.3.1	Running ACMEXCPAR.COM	10-26
10.3.2	Supplying Variable Values for ACMEXCPAR.COM	10-29
10.3.3	Modifying Variable Values for Use by ACMEXCPAR.COM	10-32

11 Changing ACMS Parameter Values with the ACMSGEN Utility

11.1	How ACMSGEN Works	11-1
11.2	How to Run the ACMSGEN Utility	11-2
11.3	Types of Parameter Values	11-3
11.4	Changing Parameter Values	11-3
11.4.1	Changing Current Values	11-3
11.4.2	Changing Active Values	11-4
11.5	Using a Parameter Work File	11-5
11.6	Displaying Parameter Values	11-6
11.7	ACMS Parameters	11-9
11.7.1	Types of ACMS Parameters	11-9
11.7.2	Parameter Descriptions	11-11
11.7.3	Parameter Values	11-15
11.8	Summary of ACMSGEN Commands and Qualifiers	11-16

12 Auditing Applications with the Audit Trail Logger

12.1	Understanding the Audit Trail Logger	12-1
12.2	Using the Audit Trail Log File	12-1
12.3	Events Recorded by the Audit Trail Logger	12-3
12.4	Running the ATR Utility	12-5
12.5	Creating Log Reports	12-6
12.5.1	Creating Full Log Reports	12-6
12.5.2	Creating Brief Log Reports	12-8
12.6	Selecting Audit Trail Records	12-9
12.6.1	Selecting Records by Submitter and Task Identification Code	12-9
12.6.2	Selecting Application Information	12-11
12.6.3	Selecting Task Information	12-11
12.6.4	Selecting User Information	12-13
12.6.5	Creating an Audit Trail Record for the QTI Process	12-15
12.6.6	Creating an Audit Trail Record for Application Modification	12-16
12.6.7	Creating an Audit Trail Record for Server Process Dump	12-16
12.6.8	Audit Trail Record for Server Replacement	12-17
12.6.9	Creating an Audit Trail Record for Insufficient Workspace Pool	12-17
12.7	Auditing the System	12-18
12.7.1	Auditing on the Submitter Node	12-18
12.7.2	Auditing on the Application Node	12-19

12.7.3	Auditing on Remote Nodes	12-20
12.8	System Messages from Other Products	12-21
12.9	Summary of the ATR Commands and Qualifiers	12-21
13	Logging Software Events	
13.1	How SWLUP Works	13-1
13.2	How to Run SWLUP	13-2
13.3	Summary of SWLUP Commands and Qualifiers	13-3
14	Tuning Your Application	
14.1	Major Issues in ACMS Application Performance	14-1
14.2	Monitoring Tools	14-2
14.3	ACMS Processes that Affect Performance	14-3
14.4	Configuration of Hardware	14-4
14.4.1	Estimating Memory Requirements	14-4
14.4.2	Estimating CPU Requirements	14-6
14.4.3	Estimating Disk Requirements	14-6
14.4.4	Sample Configuration	14-7
14.5	Configuring the Command Process	14-8
14.6	Configuring the Application Execution Controller	14-9
14.7	Configuring the Server Process	14-9
14.8	Tuning and Maintaining the Queued Task Facility	14-10
14.8.1	Configuring the QTI Process	14-10
14.8.2	QTI Task Execution Threads	14-11
14.8.3	Tuning Task Queue Files	14-11
14.8.4	Maintaining Task Queue Files	14-12
14.9	Tuning Checklist	14-13
15	Using HP DECtrace with ACMS Applications	
15.1	Overview of DECtrace	15-1
15.2	Improving Application Management with HP DECtrace	15-2
15.3	Collecting Event Data for ACMS	15-2
15.3.1	Describing ACMS Events and Items	15-2
15.3.1.1	ACMS Events	15-3
15.3.1.2	HP DECtrace and ACMS Items	15-6
15.3.1.3	DECtrace Cross Facility Items	15-10
15.3.2	How to Use Cross Facility Items	15-11
15.4	ACMS Collection Classes	15-12
15.4.1	Registering the Facility Definition	15-14
15.4.2	Creating a Selection	15-15
15.4.3	Collecting Cross Facility Items	15-16
15.4.4	Scheduling Data Collection	15-16
15.4.5	Using Registration IDs	15-17
15.5	Creating a Report Based on Collected Data	15-18
15.5.1	Formatting and Merging Data Files	15-18
15.5.2	Generating a Report	15-18
15.5.3	Generating a Report with Cross Facility Items	15-21
15.5.4	Creating a Customized Report	15-23
15.6	ACMS Database Relations	15-28

16 Managing ACMS Licensing

16.1	Overview of ACMS Kits and Licensing Options	16-1
16.1.1	ACMS Kits	16-1
16.1.2	ACMS License Types	16-2
16.2	License Unit Allocation	16-3
16.2.1	License Unit Allocation in OpenVMS Clusters	16-4
16.2.2	Concurrent-Use Licenses with the QTI	16-5
16.2.3	Concurrent-Use Licenses with Detached Tasks	16-5
16.3	Managing Systems with Concurrent-Use Licenses	16-5
16.3.1	Releasing License Units	16-6

Part II Reference Section

17 DDU Commands

ADD Command (DDU>)	17-2
COPY Command (DDU>)	17-5
DEFAULT Command (DDU>)	17-8
EXIT Command (DDU>)	17-10
HELP Command (DDU>)	17-11
LIST Command (DDU>)	17-12
MODIFY Command (DDU>)	17-14
REMOVE Command (DDU>)	17-17
RENAME Command (DDU>)	17-18
SHOW Command (DDU>)	17-21

18 UDU Commands

ADD Command (UDU>)	18-2
ADD /PROXY Command (UDU>)	18-7
COPY Command (UDU>)	18-9
CREATE /PROXY Command (UDU>)	18-13
DEFAULT Command (UDU>)	18-14
EXIT Command (UDU>)	18-18
HELP Command (UDU>)	18-19
LIST Command (UDU>)	18-20
LIST /PROXY Command (UDU>)	18-22
MODIFY Command (UDU>)	18-23
REMOVE Command (UDU>)	18-27
REMOVE /PROXY Command (UDU>)	18-28
RENAME Command (UDU>)	18-30
SHOW Command (UDU>)	18-34
SHOW /PROXY Command (UDU>)	18-36

19 AAU Commands

ADD Command (AAU>)	19-2
COPY Command (AAU>)	19-5
DEFAULT Command (AAU>)	19-8
EXIT Command (AAU>)	19-11
HELP Command (AAU>)	19-12
LIST Command (AAU>)	19-14
MODIFY Command (AAU>)	19-16
REMOVE Command (AAU>)	19-19
RENAME Command (AAU>)	19-20
SHOW Command (AAU>)	19-23

20 ACMSQUEMGR Commands

CREATE QUEUE Command (ACMSQUEMGR>)	20-2
DELETE ELEMENT Command (ACMSQUEMGR>)	20-5
DELETE QUEUE Command (ACMSQUEMGR>)	20-9
EXIT Command (ACMSQUEMGR>)	20-10
HELP Command (ACMSQUEMGR>)	20-11
MODIFY QUEUE Command (ACMSQUEMGR>)	20-13
SET ELEMENT Command (ACMSQUEMGR>)	20-15
SET QUEUE Command (ACMSQUEMGR>)	20-19
SHOW ELEMENT Command (ACMSQUEMGR>)	20-21
SHOW QUEUE Command (ACMSQUEMGR>)	20-25

21 Operator Commands

ACMS/CANCEL TASK Command	21-2
ACMS/CANCEL USER Command	21-5
ACMS/DEBUG Command	21-8
ACMS/ENTER Command	21-10
ACMS/INSTALL Command	21-11
ACMS/MODIFY APPLICATION Command	21-13
ACMS/REPLACE SERVER Command	21-17
ACMS/REPROCESS APPLICATION_SPEC Command	21-19
ACMS/RESET AUDIT Command	21-21
ACMS/RESET TERMINALS Command	21-22
ACMS/SET QUEUE Command	21-23
ACMS/SET SYSTEM Command	21-24
ACMS/SHOW APPLICATION Command	21-26
ACMS/SHOW APPLICATION/CONTINUOUS Command	21-31
ACMS/SHOW QTI Command	21-33
ACMS/SHOW QUEUE Command	21-34
ACMS/SHOW SERVER Command	21-35
ACMS/SHOW SYSTEM Command	21-37
ACMS/SHOW TASK Command	21-39
ACMS/SHOW USER Command	21-41

ACMS/START APPLICATION Command	21-46
ACMS/START QTI Command	21-48
ACMS/START QUEUE Command	21-49
ACMS/START SYSTEM Command	21-51
ACMS/START TASK Command	21-53
ACMS/START TERMINALS Command	21-55
ACMS/STOP APPLICATION Command	21-56
ACMS/STOP QTI Command	21-58
ACMS/STOP QUEUE Command	21-59
ACMS/STOP SYSTEM Command	21-60
ACMS/STOP TERMINALS Command	21-61

22 ACMSGEN Commands

EXIT Command (ACMSGEN>)	22-2
HELP Command (ACMSGEN>)	22-3
SET Command (ACMSGEN>)	22-4
SHOW Command (ACMSGEN>)	22-5
USE Command (ACMSGEN>)	22-7
USE ACTIVE Command (ACMSGEN>)	22-8
USE CURRENT Command (ACMSGEN>)	22-10
USE DEFAULT Command (ACMSGEN>)	22-11
WRITE Command (ACMSGEN>)	22-12
WRITE ACTIVE Command (ACMSGEN>)	22-13
WRITE CURRENT Command (ACMSGEN>)	22-15

23 ATR Commands

EXIT Command (ATR>)	23-2
HELP Command (ATR>)	23-3
LIST Command (ATR>)	23-4

24 SWLUP Commands

@ (At sign) Command (SWLUP>)	24-2
EDIT Command (SWLUP>)	24-3
EXIT Command (SWLUP>)	24-5
HELP Command (SWLUP>)	24-6
LIST Command (SWLUP>)	24-7
RENEW Command (SWLUP>)	24-10
SAVE Command (SWLUP>)	24-11
SET [NO]LOG Command (SWLUP>)	24-12
SET [NO]VERIFY Command (SWLUP>)	24-13
SHOW CURRENT Command (SWLUP>)	24-14
SHOW LOG Command (SWLUP>)	24-15
SHOW VERSION Command (SWLUP>)	24-16
STOP Command (SWLUP>)	24-17

A Parameter and Quota Calculations

A.1	Calculating OpenVMS SYSGEN Parameters Affected by ACMS	A-2
A.1.1	Calculating the Value of CHANNELCNT	A-2
A.1.2	Calculating the Value of GBLPAGES	A-2
A.1.3	Calculating the Value of GBLPAGFIL	A-3
A.1.4	Calculating the Value of GBLSECTIONS	A-3
A.1.5	Calculating the Value of LOCKIDTBL	A-3
A.1.6	Task Debugger Parameters and Values	A-3
A.2	Calculating Quotas for OpenVMS User Names of ACMS Processes	A-4
A.2.1	User Name Setup for the ACC	A-4
A.2.1.1	How ACMSPARAM.COM Calculates Values for the ACC	A-5
A.2.2	User Name Setup for the TSC	A-6
A.2.2.1	How ACMSPARAM.COM Calculates Values for the TSC	A-7
A.2.3	User Name Setup for the CP	A-7
A.2.3.1	How ACMSPARAM.COM Calculates Values for the CP	A-8
A.2.4	User Name Setup for the QTI	A-9
A.2.4.1	How ACMSPARAM.COM Calculates Values for the QTI	A-10
A.2.5	User Name Setup for the EXC	A-11
A.2.5.1	How ACMEXCPAR.COM Calculates Values for the EXC	A-12
A.2.6	Calculating Quotas for ACMS Server Processes	A-13
A.3	Calculating Quotas for Using the ADU Utility	A-14
A.4	Calculating Quotas for Using the ACMS Task Debugger	A-15
A.5	Calculating Values for Certain ACMSGEN Parameters	A-15
A.5.1	Calculating the Value of MAX_LOGINS	A-15
A.5.2	Calculating the Value of MSS_MAXOBJ	A-16
A.5.3	Calculating the Value of MSS_MAXBUF	A-16
A.5.4	Calculating the Value of MSS_POOLSIZ	A-18
A.5.5	Calculating the Value of MSS_PROCESS_POOL	A-18
A.5.6	Calculating the Value of PERM_CPS	A-19
A.5.7	Calculating ACMS Workspace Pools	A-19
A.5.7.1	Types of Workspace Pools	A-19
A.5.7.2	Workspace Pool Allocation Failures	A-20
A.5.7.3	ACMS Workspace Pool Requirements	A-20
A.5.7.3.1	Task Instance Workspace Pool Requirements	A-21
A.5.7.3.2	Task Instance Control Pool Requirements	A-21
A.5.7.3.3	Group Workspace Pool Requirements	A-21
A.5.7.3.4	User Workspace Pool Requirements	A-21
A.5.7.4	Calculating Workspace Pool Sizes	A-22
A.5.7.4.1	Calculating the Value of TWS_POOLSIZ and TWSC_POOLSIZ	A-22
A.5.7.4.2	Calculating the Value of WS_POOLSIZ and WSC_POOLSIZ	A-23
A.5.7.4.3	Defining Logical Names for Workspace Pool Sizes	A-24

B Error Messages

B.1	ACMS Error Messages	B-1
B.2	Error Messages from Other Products	B-1

C Requirements for Successful ACMS Sign-Ins

C.1	ACMS Sign-In Requirements	C-1
-----	-------------------------------------	-----

Index

Examples

2-1	DDU SHOW Command	2-6
4-1	AAU SHOW Command	4-6
5-1	ACMSQUEMGR SHOW QUEUE Command	5-5
5-2	ACMSQUEMGR SHOW ELEMENT/FULL	5-8
6-1	Using a Logical Name for a Node	6-10
6-2	Using a Logical Name for an Application	6-10
7-1	Data Compression Is Not Enabled	7-8
7-2	Data Compression Is Disabled	7-8
7-3	Data Compression Is Enabled in Unrestricted Mode	7-8
7-4	Data Compression Is Enabled in Restricted Mode	7-8
7-5	Data Compression Is Not Enabled at Local Node	7-9
7-6	Data Compression Is Not Fully Enabled	7-9
7-7	Data Compression Is Not Enabled at the Remote Node Initiating the Network Connection	7-9
7-8	Data Compression Is Enabled at the Remote Node, But Is Not Enabled at the Local Node	7-10
7-9	Data Compression Is Enabled with Network Connection to the Remote Node	7-10
7-10	Data Compression Is Enabled with Network Connection from the Remote Node	7-10
8-1	ACMS/SHOW SYSTEM Command	8-5
8-2	ACMS/SHOW SYSTEM/POOL Command	8-6
8-3	ACMS/SHOW QTI Command	8-9
8-4	ACMS/SHOW QUEUE Command	8-11
8-5	ACMS/SHOW USER/FULL Command	8-13
9-1	ACMS/SHOW APPLICATION Command	9-4
9-2	ACMS/SHOW APPLICATION/POOL TEST Command	9-6
9-3	ACMS/SHOW APPLICATION/CONTINUOUS Command	9-7
9-4	ACMS/SHOW TASK Command	9-14
10-1	Modified Variable Values in the ACMVARINI.DAT File	10-14
10-2	Variables in ACMEXCPAR_GENVAR.DAT Template	10-29
11-1	ACMSGEN SHOW/ALL Command (on Alpha)	11-7
11-2	ACMSGEN SHOW/TSC Command	11-8
12-1	ATR LIST Command	12-6
12-2	ATR LIST/BRIEF Command	12-8
12-3	Using the LIST/TYPE=TASK Command to Display Task Information	12-11
12-4	ATR LIST/USERNAME/TYPE Command	12-14
12-5	QTI Audit Entry	12-16
12-6	Application Modification Audit Entry	12-16

12-7	Server Process Dump Audit Entry	12-17
12-8	Server Process Dump Failure Audit Entry	12-17
12-9	Server Replacement Audit Entry	12-17
12-10	Insufficient Workspace Audit Entry	12-18
12-11	Authentication Request Record	12-19
12-12	Authentication Success Record	12-19
12-13	Audited Authentication Failure Record	12-20
15-1	Summary Report for ACMS Event Data	15-19
15-2	DETrace Summary Report	15-22
15-3	Using Reporting Options to Generate a Customized Report	15-23
15-4	Sample HP DETrace Customized Report Based on ACMS Data	15-25

Figures

4-1	AAU Application Authorization Process	4-1
4-2	Conditions for Installing an Application	4-4
6-1	Distributed Forms Processing	6-1
7-1	Simple Mixed-Interconnect Network	7-4
7-2	Complex Mixed-Interconnect Network	7-6
9-1	Process of Installing an Application	9-1
10-1	Setting System Parameters and Process Quotas with ACMSPARAM.COM	10-4
10-2	Setting EXC Process Quotas with ACMEXCPAR.COM	10-27
14-1	Sample Distributed ACMS Configuration	14-8
15-1	Measuring the SUB_RESPONSE Event	15-4
15-2	Measuring the APL_RESPONSE Event	15-6
15-3	Relating the ACMS PROCEDURE_CALL and Rdb TRANSACTION Events	15-11
A-1	Minimum Quotas for Server Processes	A-14
A-2	Minimum Quotas for Using ADU	A-14
A-3	Minimum Quotas for Using the Task Debugger	A-15

Tables

1-1	ACMS Application Management Tools	1-4
2-1	DDU Group Device Names	2-3
2-2	OpenVMS AUTHORIZE Qualifiers Affecting Sign-in to ACMS-Controlled Terminals	2-8
2-3	Summary of DDU Commands	2-15
3-1	Summary of UDU Commands	3-11
4-1	Initial Settings for the DEFAULT Authorization	4-3
4-2	Summary of AAU Commands	4-7
5-1	Summary of ACMSQUEMGR Commands	5-10
6-1	Proxy Choices	6-5
7-1	Information Collected for Compressed Messages	7-11
8-1	Summary of Operator Commands	8-14
9-1	Task States	9-15

10-1	Phases of ACMSPARAM.COM	10-7
10-2	ACMS\$START_MONITOR.COM Parameters	10-10
10-3	Variables Required for ACMSPARAM.COM	10-15
10-4	Phases of ACMEXCPAR.COM	10-28
10-5	Variables Required for ACMEXCPAR.COM	10-30
11-1	ACMS Components Affected by ACMSGEN Parameters	11-2
11-2	ACMS Parameters	11-9
11-3	ACMSGEN Parameter Values	11-15
11-4	Summary of ACMSGEN Commands	11-16
12-1	Events Logged by the Audit Trail Logger	12-4
12-2	Summary of ATR Commands	12-21
13-1	Summary of SWLUP Commands	13-3
15-1	Resource Utilization Items	15-6
15-2	ACMS Data Items	15-7
15-3	Cross Facility Items	15-10
15-4	ACMS Collection Classes	15-12
15-5	Events and Items Available in the ALL Collection Class for ACMS...	15-12
15-6	Events and Items Available in the PERFORMANCE Class for ACMS	15-13
15-7	Events and Items Available in the RESPONSE Collection Class for ACMS	15-14
15-8	DETrace Reports	15-18
15-9	Columns for Table EPC\$1_253_APL_RESPONSE	15-29
15-10	Columns for Table EPC\$1_253_APL_RESPONSE_ST	15-29
15-11	Columns for Table EPC\$1_253_COMPRESSED_MSG	15-30
15-12	Columns for Table EPC\$1_253_COMPRESSED_MSG_ST	15-30
15-13	Columns for Table EPC\$1_253_EXCHANGE_STEP	15-30
15-14	Columns for Table EPC\$1_253_EXCHANGE_STEP_ST	15-31
15-15	Columns for Table EPC\$1_253_FORMS_ENABLE	15-31
15-16	Columns for Table EPC\$1_253_FORMS_ENABLE_ST	15-32
15-17	Columns for Table EPC\$1_253_FORMS_REQUEST	15-32
15-18	Columns for Table EPC\$1_253_FORMS_REQUEST_ST	15-33
15-19	Columns for Table EPC\$1_253_PROCEDURE_CALL	15-33
15-20	Columns for Table EPC\$1_253_PROCEDURE_CALL_ST	15-35
15-21	Columns for Table EPC\$1_253_PROCESSING_STEP	15-35
15-22	Columns for Table EPC\$1_253_PROCESSING_STEP_ST	15-36
15-23	Columns for Table EPC\$1_253_REMOTE_REQUEST	15-36
15-24	Columns for Table EPC\$1_253_REMOTE_REQUEST_ST	15-37
15-25	Columns for Table EPC\$1_253_SUB_RESPONSE	15-38
15-26	Columns for Table EPC\$1_253_SUB_RESPONSE_ST	15-38
15-27	Columns for Table EPC\$1_253_TASK	15-39
15-28	Columns for Table EPC\$1_253_TASK_ST	15-39
15-29	Columns for Table EPC\$1_253_TASK_WAIT	15-39
15-30	Columns for Table EPC\$1_253_TASK_WAIT_ST	15-40
15-31	Columns for Table EPC\$1_253_TRANSACTION	15-41
15-32	Columns for Table EPC\$1_253_TRANSACTION_ST	15-41
16-1	ACMS Licenses	16-2

A-1	Minimum Quotas for the ACC User Name Process	A-5
A-2	Minimum Quotas for the TSC User Name Process	A-6
A-3	Minimum Quotas for the CP User Name Process	A-7
A-4	Minimum Quotas for the QTI User Name Process	A-10
A-5	Minimum Quotas for the EXC User Name Process	A-11
A-6	Types of ACMS Workspace Pools	A-19

Preface

This manual explains how to manage the *HP ACMS for OpenVMS* (ACMS) software, and the applications running under ACMS. It also provides reference information for the utilities and commands you use in working with ACMS.

Intended Audience

Chapter 1 provides a general introduction to ACMS system and application management. This manual should be read by people responsible for:

- Authorizing ACMS users, terminals, and applications
See Chapter 2, Chapter 3, and Chapter 4. You should be familiar with the HP OpenVMS (OpenVMS) Authorize Utility. See the OpenVMS documentation for a description of the Authorize Utility.
- Creating and managing ACMS task queues
Chapter 5 describes how to create and manage ACMS task queues.
- Preparing your ACMS system for distributed processing
Chapter 6 describes how to set up and use ACMS as a distributed system.
- Managing and operating an ACMS application system
Chapter 8 describes how to start and stop the ACMS system and its components, as well as how to monitor system resources.
- Installing and managing ACMS applications
Chapter 9 describes the installation and management of ACMS applications.
- Monitoring ACMS application and system use
In addition to the system monitoring described in Chapter 8, Chapter 12 and Chapter 13 provide information on ACMS monitoring tools. Chapter 15 describes the use of HP DECtrace for collection of event-based data.
- Tuning ACMS to improve system performance
Chapter 10, Chapter 11, and Chapter 14 describe how to set OpenVMS and ACMS system parameters and ACMS run-time process quotas, and how to further tune the ACMS system to improve performance.

Document Structure

This manual contains 24 chapters, 3 appendixes, and an index. The chapters are grouped into two parts. The first part groups chapters in the order you would most likely use them as you prepare the ACMS environment for use. The second part contains reference chapters for each of the utilities used in managing and controlling the ACMS system and applications. An appendix section follows the second part.

Chapter 1	Introduces ACMS application management, explaining the activities that such management involves and the ACMS tools you use in managing applications.
Part I	Managing the ACMS System and ACMS Applications
Chapter 2	Explains how to authorize terminals for access to ACMS with the Device Definition Utility (DDU) and how to define local terminals to log in directly to ACMS.
Chapter 3	Explains how to authorize users to access ACMS with the User Definition Utility (UDU).
Chapter 4	Explains how to use the Application Authorization Utility (AAU) to authorize ACMS applications.
Chapter 5	Describes how to create and manage ACMS task queues and queued task elements using the ACMS Queue Manager (ACMSQUEMGR) Utility.
Chapter 6	Describes how to set up ACMS for distributed processing.
Chapter 7	Describes how to use the data compression feature.
Chapter 8	Describes how to start and stop the ACMS system and its components, as well as monitor system resources.
Chapter 9	Describes how to install and run ACMS applications, cancel tasks, and modify active applications.
Chapter 10	Explains how to set and modify the values of ACMS system parameters, OpenVMS SYSGEN parameters affected by ACMS, and ACMS process quotas using the ACMSPARAM.COM and ACMEXCPAR.COM command procedures.
Chapter 11	Explains how to change the values of ACMS parameters with the ACMMSGEN Utility, independent of the ACMSPARAM.COM command procedure. The second part of the chapter provides reference information for the ACMMSGEN Utility commands.
Chapter 12	Explains how to get information about application and user activity by using the Audit Trail Report (ATR) Utility.
Chapter 13	Describes the ACMS Software Event Logger (SWL), which logs ACMS internal software errors. It also describes how to generate SWL reports by using the ACMS Software Event Log Utility Program (SWLUP).
Chapter 14	Describes the major issues in ACMS application performance, ACMS components that affect system performance, and tools for monitoring an ACMS system, and also provides a tuning checklist.
Chapter 15	Describes the use of DECtrace for collecting event-based data gathered from ACMS applications.
Chapter 16	Describes the kits and licenses available in ACMS. It also describes how to manage ACMS systems with concurrent-use licenses, unlimited-use licenses, or both.
Part II	Reference Section
Chapter 17	Provides reference information for DDU commands.
Chapter 18	Provides reference information for UDU commands.
Chapter 19	Provides reference information for AAU commands.
Chapter 20	Provides reference information for ACMSQUEMGR Utility commands.
Chapter 21	Provides reference information for ACMS operator commands.
Chapter 22	Provides reference information for ACMMSGEN Utility commands.
Chapter 23	Provides reference information for ATR Utility commands.

Chapter 24 Provides reference information for SWLUP commands.

Appendixes

Appendix A Describes the formulas used in the calculation of various parameters and quotas by ACMSPARAM.COM and ACMEXCPAR.COM, as well as further calculations that can be made to fine-tune the system.

Appendix B Explains how error message codes are returned by ACMS for the ACMS application management utilities and for messages returned at run time.

Appendix C Gives guidelines to ensure successful user logins.

Related Documents

The following table lists the books in the *HP ACMS for OpenVMS* documentation set.

ACMS Information	Description
<i>HP ACMS Version 5.0 for OpenVMS Release Notes</i> †	Information about the latest release of the software
<i>HP ACMS Version 5.0 for OpenVMS Installation Guide</i>	Description of installation requirements, the installation procedure, and postinstallation tasks.
<i>HP ACMS for OpenVMS Getting Started</i>	Overview of ACMS software and documentation. Tutorial for developing a simple ACMS application. Description of the AVERTZ sample application.
<i>HP ACMS for OpenVMS Concepts and Design Guidelines</i>	Description of how to design an ACMS application.
<i>HP ACMS for OpenVMS Writing Applications</i>	Description of how to write task, task group, application, and menu definitions using the Application Definition Utility. Description of how to write and migrate ACMS applications on an OpenVMS Alpha system.
<i>HP ACMS for OpenVMS Writing Server Procedures</i>	Description of how to write programs to use with tasks and how to debug tasks and programs. Description of how ACMS works with the APPC/LU6.2 programming interface to communicate with IBM CICS applications. Description of how ACMS works with third-party database managers, with Oracle used as an example.
<i>HP ACMS for OpenVMS Systems Interface Programming</i>	Description of using Systems Interface (SI) Services to submit tasks to an ACMS system.
<i>HP ACMS for OpenVMS ADU Reference Manual</i>	Reference information about the ADU commands, phrases, and clauses.
<i>HP ACMS for OpenVMS Quick Reference</i>	List of ACMS syntax with brief descriptions.
<i>HP ACMS for OpenVMS Managing Applications</i>	Description of authorizing, running, and managing ACMS applications, and controlling the ACMS system.
<i>HP ACMS for OpenVMS Remote Systems Management Guide</i>	Description of the features of the Remote Manager for managing ACMS systems, how to use the features, and how to manage the Remote Manager.
Online help†	Online help about ACMS and its utilities.

†Available on line only.

For additional information on the compatibility of other software products with this version of ACMS, refer to the *HP ACMS for OpenVMS Software Product Description* (SPD 25.50.xx).

For additional information about the Open Systems Software Group (OSSG) products and services, access the following OpenVMS World Wide Web address:

<http://h71000.www7.hp.com/openvms>

ACMS Help

ACMS and its components provide extensive online help.

- DCL-level help

Enter `HELP ACMS` at the DCL prompt for complete help about the ACMS command and qualifiers, and for other elements of ACMS for which independent help systems do not exist. DCL-level help also provides brief help messages for elements of ACMS that contain independent help systems (such as the ACMS utilities) and for related products used by ACMS (such as DECforms or Oracle CDD/Repository).

- ACMS utilities help

Each of the following ACMS utilities has an online help system:

- ACMS Debugger
- ACMSGEN Utility
- ACMS Queue Manager (ACMSQUEMGR)
- Application Definition Utility (ADU)
- Application Authorization Utility (AAU)
- Device Definition Utility (DDU)
- User Definition Utility (UDU)
- Audit Trail Report Utility (ATR)
- Software Event Log Utility Program (SWLUP)

The two ways to get utility-specific help are:

- Run the utility and type `HELP` at the utility prompt.
- Use the DCL `HELP` command. At the “Topic?” prompt, type `@` followed by the name of the utility. Use the ACMS prefix, even if the utility does not have an ACMS prefix (except for SWLUP). For example:

```
Topic? @ACMSQUEMGR
```

```
Topic? @ACMSADU
```

However, do not use the ACMS prefix with SWLUP:

```
Topic? @SWLUP
```

Note that if you run the ACMS Debugger Utility and then type `HELP`, you must specify a file. If you ask for help from the DCL level with `@`, you do not need to specify a file.

- ACMSPARAM.COM and ACMEXCPAR.COM help

Help for the command procedures that set parameters and quotas is a subset of the DCL-level help. You have access to this help from the DCL prompt, or from within the command procedures.

- LSE help

ACMS provides ACMS-specific help within the LSE templates that assist in the creation of applications, tasks, task groups, and menus. The ACMS-specific LSE help is a subset of the ADU help system. Within the LSE templates, this help is context-sensitive. Type `HELP/IND` (PF1-PF2) at any placeholder for which you want help.

- **Error help**
ACMS and each of its utilities provide error message help. Use `HELP ACMS ERRORS` from the DCL prompt for ACMS error message help. Use `HELP ERRORS` from the individual utility prompts for error message help for that utility.
- **Terminal user help**
At each menu within an ACMS application, ACMS provides help about terminal user commands, special key mappings, and general information about menus and how to select tasks from menus.
- **Forms help**
For complete help for HP DECforms or TDMS, use the help systems for these products.

Conventions

The following conventions are used in this manual:

<code>Ctrl/x</code>	A sequence such as <code>Ctrl/x</code> indicates that you must press and hold the key labeled <code>Ctrl</code> while you press another key or a pointing device button.
<code>PF1 x</code>	A sequence such as <code>PF1 x</code> indicates that you must first press and release the key labeled <code>PF1</code> and then press and release another key or a pointing device button.
<code>Return</code>	In examples, a key name enclosed in a box indicates that you press a key on the keyboard. (In text, a key name is not enclosed in a box.) In the HTML version of this document, this convention appears as brackets rather than a box.
<code>...</code>	A horizontal ellipsis in examples indicates one of the following possibilities: <ul style="list-style-type: none"> • Additional optional arguments in a statement have been omitted. • The preceding item or items can be repeated one or more times. • Additional parameters, values, or other information can be entered.
<code>. . . .</code>	A vertical ellipsis indicates the omission of items from a code example or command format; the items are omitted because they are not important to the topic being discussed.
Monospace text	Monospace type indicates code examples and interactive screen displays. In the C programming language, monospace type in text identifies the following elements: keywords, the names of independently compiled external functions and files, syntax summaries, and references to variables or identifiers introduced in an example. In the HTML version of this document, this text style may appear as italics.
-	A hyphen at the end of a command format description, command line, or code line indicates that the command or statement continues on the following line.

numbers	All numbers in text are assumed to be decimal unless otherwise noted. Nondecimal radices—binary, octal, or hexadecimal—are explicitly indicated.
bold text	Bold text represents the introduction of a new term or the name of an argument, an attribute, or a reason. In the HMTL version of this document, this text style may appear as italics.
<i>italic text</i>	Italic text indicates important information, complete titles of manuals, or variables. Variables include information that varies in system output (Internal error <i>number</i>), in command lines (<i>/PRODUCER=name</i>), and in command parameters in text (where <i>dd</i> represents the predefined code for the device type).
UPPERCASE	Uppercase text indicates the name of a routine, the name of a file, the name of a file protection code, or the abbreviation for a system privilege. In command format descriptions, uppercase text is an optional keyword.
<u>UPPERCASE</u>	In command format descriptions, uppercase text that is underlined is required. You must include it in the statement if the clause is used.
lowercase	In command format descriptions, a lowercase word indicates a required element.
<lowercase>	In command format descriptions, lowercase text in angle brackets indicates a required clause or phrase.
()	In command format descriptions, parentheses indicate that you must enclose the options in parentheses if you choose more than one.
[]	In command format descriptions, vertical bars within square brackets indicate that you can choose any combination of the enclosed options, but you can choose each option only once.
{ }	In command format descriptions, vertical bars within braces indicate that you must choose one of the options listed, but you can use each option only once.

References to Products

The ACMS documentation set to which this manual belongs often refers to certain products by abbreviated names:

Abbreviation	Product
ACMS	<i>HP ACMS for OpenVMS Alpha, and HP ACMS for OpenVMS I64</i>
Ada	HP Ada for OpenVMS Alpha Systems, and HP Ada for OpenVMS I64 Systems
BASIC	HP BASIC for OpenVMS
C	HP C for OpenVMS Alpha Systems, and HP C for OpenVMS I64 Systems
CDD	Oracle CDD/Administrator, and Oracle CDD/Repository
COBOL	HP COBOL for OpenVMS Alpha Systems, and HP COBOL for OpenVMS I64 Systems
DATATRIEVE	HP DATATRIEVE for OpenVMS Alpha, and HP DATATRIEVE for OpenVMS I64
DBMS	Oracle CODASYL DBMS

Abbreviation	Product
DECforms	HP DECforms
FORTRAN	HP Fortran for OpenVMS Alpha Systems, and HP Fortran for OpenVMS I64 Systems
OpenVMS	The OpenVMS Alpha operating system, and the OpenVMS I64 operating system
Pascal	HP Pascal for OpenVMS Alpha, and HP Pascal for OpenVMS I64
Rdb	Oracle Rdb
SQL	The SQL interface to Oracle Rdb

Note

The HP DECTrace product is the predecessor of the Oracle Trace product. Some information in the ACMS documentation, particularly in some examples, refers to HP DECTrace. Except where version-specific, the information applies to the Oracle Trace product as well. As you read the information, you can use the product name Oracle Trace instead of the product name DECTrace with no significant difference in meaning.

Part I

Managing the ACMS System and ACMS Applications

This part of the manual contains information about managing the ACMS system and its components. Part I also contains information about authorizing, installing, running, and monitoring ACMS applications. In addition, it provides information on system tuning and describes how to set up your ACMS system for distributed processing.

Introduction to Application Management

The ACMS software helps you develop, use, and maintain online applications. Once you define and test an ACMS application, you can make it available to users. Before users can run tasks in the application, you must authorize the users and their terminals for access to ACMS. You can also optionally authorize ACMS applications and the users who can install them. Finally, you can start the ACMS system and applications.

These activities are all part of managing ACMS applications. Other aspects of managing ACMS applications include:

- Maintaining the security of applications
- Controlling their day-to-day operation
- Monitoring applications
- Managing ACMS task queues and queued task elements
- Tuning the ACMS system

This guide discusses the work involved in managing ACMS applications and the tools ACMS provides for this work. Practice using the ACMS management tools discussed in this book by installing and running the ACMS sample application.

See Chapter 9 for information about how to install and manage ACMS applications.

This manual does not discuss using the ACMS Remote Manager to manage ACMS systems remotely across a network. For information about managing ACMS systems remotely across a network, see the *HP ACMS for OpenVMS Remote Systems Management Guide* in the ACMS documentation set.

1.1 ACMS Authorization Tools

When many users share one OpenVMS system, it is important for the ACMS system manager to control the facilities to which each user has access. For example, some users' jobs require access only to ACMS, while others require access to OpenVMS as well as ACMS.

The five tools that the system manager uses to authorize access to ACMS are:

- The OpenVMS Authorize Utility authorizes users to log in to OpenVMS. All ACMS users must be authorized OpenVMS users, whether they log in to OpenVMS or directly in to ACMS.
- The ACMS User Definition Utility (UDU) controls who can sign in to ACMS and whether a user receives a menu or just a selection prompt after signing in. The system manager must also use UDU to define the user name of ACMS processes. See Chapter 3 for information about UDU.

Introduction to Application Management

1.1 ACMS Authorization Tools

- The ACMS Device Definition Utility (DDU) authorizes the terminals at which users can sign in to ACMS and controls whether a user signs in directly to ACMS, or logs in to OpenVMS and then ACMS. See Chapter 2 for information about DDU.
- The system manager can use the ACMS Application Authorization Utility (AAU) to authorize users to install applications in the directory associated with the logical name ACMS\$DIRECTORY. See Chapter 4 for information about AAU.
- The Access Control List (ACL) subclause, used in the application definition, specifies by User Identification Code (UIC) or identifier which users can run certain tasks in an application. See *HP ACMS for OpenVMS ADU Reference Manual* for information on the ACCESS application-task subclause.

1.2 Controlling ACMS Operations

Controlling the overall operations of an ACMS system includes using the ACMS operator commands to:

- Install ACMS applications
- Set up terminals as ACMS operator terminals
- Control the ACMS system, including starting and stopping the system, and changing system characteristics
- Control the queued task initiator (QTI) and ACMS task queues
- Control ACMS applications, including starting and stopping applications
- Enable and disable tasks
- Enable and disable application auditing
- Control the terminals from which users can sign in to ACMS by starting and stopping the terminal subsystem controller (TSC)
- Cancel tasks when necessary
- Cancel users when necessary
- Display system and application information

Most ACMS operator commands require the OpenVMS OPER privilege. The only commands that do not require the OPER privilege are the ACMS/SHOW commands and ACMS/INSTALL. See Chapter 8, Chapter 9, and Chapter 21 for more information on the ACMS operator commands.

1.3 Monitoring an ACMS System

ACMS supplies several monitoring tools to help observe the system and its users:

- The Audit Trail Logger gathers information about an active ACMS system (for example, system and application starts and stops, user sign-ins and sign-outs, processing errors, user task selections, task completions and task cancellations) and generates records of ACMS user and application activity. Use the Audit Trail Report (ATR) Utility to produce reports containing audit trail information. See Chapter 12 for information about the ATL and the ATR Utility.

Introduction to Application Management

1.3 Monitoring an ACMS System

- The ACMS/SHOW commands display information about an active ACMS system and its applications. See Chapter 21 for information about the ACMS/SHOW commands.
- The Software Event Logger (SWL) reports internal software errors that occur during run time. Use the Software Event Log Utility Program (SWLUP) to generate reports containing SWL information. See Chapter 13 for information about SWL and SWLUP.

1.4 Tuning an ACMS System

Normally, you set OpenVMS and ACMS system parameters and ACMS run-time process quotas after an installation or an upgrade, or when the ACMS system load changes with, for example, additional applications or users. Use the ACMSPARAM.COM and ACMEXCPAR.COM command procedures to set parameters and quotas.

After you are familiar with the requirements of your system, you might need to change some of the default system parameter values. For example, you might need to change the value set for the maximum number of users who can sign in to ACMS. You can make system parameter changes with the ACMSPARAM and ACMEXCPAR command procedures.

You can also use the ACMSGEN Utility to set or change ACMS parameters. However, the use of ACMSPARAM.COM is preferred because this command procedure automatically changes other parameters related to the ones you modify. ACMSGEN changes values of ACMS parameters similar to the way the OpenVMS SYSGEN Utility lets you change OpenVMS parameters.

You can use ACMSGEN parameters to control the ACMS TSC, the ACC, the CP, the EXC, and the QTI, as well as ACMS message services and workspace pools. These components start and control other ACMS components.

Chapter 14 discusses tuning considerations, monitoring tools, and ACMS components that affect ACMS performance. It also provides a tuning checklist. Chapter 10 and Chapter 11 describe the ACMS system parameters in detail and explain how to change their values using the ACMSPARAM.COM and the ACMEXCPAR.COM procedures and the ACMSGEN Utility.

1.5 ACMS Application Management Tools

ACMS has several application management tools. Table 1–1 lists the ACMS application management tools and tells you where you can find further details on each tool in this book.

Introduction to Application Management

1.5 ACMS Application Management Tools

Table 1–1 ACMS Application Management Tools

Management Tool	Function
ACMS Operator Commands	Perform standard operator functions such as starting and stopping the ACMS system, the TSC, and the QTI. Other operator commands allow you to start and stop ACMS applications and display application and system information. See Chapter 8, Chapter 9, and Chapter 21 for information.
ACMSGEN Utility	Changes the values of ACMS parameters. See Chapter 11 and Chapter 22 for information.
ACMSPARAM.COM and ACMEXCPAR.COM procedures	Change the values of OpenVMS and ACMS system parameters, and ACMS run-time process quotas. See Chapter 10 for information.
Application Authorization Utility (AAU)	Authorizes applications to be installed in the directory associated with the logical name ACMS\$DIRECTORY. See Chapter 4 and Chapter 19 for information.
Audit Trail Report (ATR) Utility	Returns records of application and user activity. See Chapter 12 and Chapter 23 for information.
Device Definition Utility (DDU)	Authorizes ACMS terminals and, optionally, defines terminals to sign in directly to ACMS. See Chapter 2 and Chapter 17 for information.
Queue Manager Utility (ACMSQUEMGR)	Creates and manages ACMS task queues and queued task elements. See Chapter 5 and Chapter 20 for information.
Software Event Log Utility Program (SWLUP)	Creates reports of selected events recorded by the Software Event Logger. See Chapter 13 and Chapter 24 for information.
User Definition Utility (UDU)	Authorizes users to sign in to ACMS and assigns sign-in displays, including default menus, to ACMS users. See Chapter 3 and Chapter 18 for information.

1.6 Learning to Manage an ACMS System

While running the sample applications, you learn to authorize users and terminals and how to start and stop the ACMS system by using ACMS operator commands. In addition, the sample applications help you learn how to:

- Perform other functions with the operator commands, such as enabling and disabling ACMS operator terminals or the Audit Trail Logger.
- Run the ATR Utility to examine an ACMS log report and to familiarize yourself with the LIST command and its qualifiers.
- Run the ACMSPARAM.COM and ACMEXCPAR.COM command procedures to familiarize yourself with ACMS system parameters and run-time process quotas.

It is recommended that you run the ACMS sample applications if you are a new ACMS user.

Authorizing and Controlling Terminals

Authorized ACMS users must sign in from terminals that have been authorized for access to ACMS. This chapter describes how to use the ACMS Device Definition Utility (DDU) to authorize terminals by creating DDU device definitions. See Section 2.14 for a summary of DDU commands and qualifiers. For reference information on the commands described in this chapter, refer to Chapter 17.

2.1 How DDU Works

System managers use DDU commands and qualifiers to create a device authorization file (ACMSDDF.DAT) that contains authorizations for ACMS terminals. This information includes:

- Device name of the terminal. Use physical device names or group device names to authorize terminals. Table 2–1 lists the DDU group device names.
- Terminal sign-in characteristics.

When a user tries to sign in to ACMS from a terminal, ACMS checks the ACMSDDF.DAT for a device definition for the user's terminal. If the authorization file does not contain a definition for that device, ACMS then checks for the group device name \$ALL to see if *all* devices are authorized for ACMS access. If there is no \$ALL definition, ACMS denies access to the terminal. See Table 2–1 for more information about the \$ALL group device name.

When the TSC is started, or when the ACMS operator command ACMS/RESET TERMINALS is issued, ACMS reads the device authorization file and establishes the sign-in characteristics for terminals. You can assign the following sign-in characteristics to ACMS terminals:

- **Controlled or Not Controlled**
Users at application port terminals with the Controlled sign-in characteristic sign in directly to ACMS. Users at dedicated service port terminals sign in either directly to ACMS or not, depending on the node they connect to at the "Local>" prompt. See Section 2.11 for a description of application ports and dedicated service ports. A terminal with a Not Controlled characteristic has access to both OpenVMS and ACMS. See Section 2.10 for information on how to assign the /[NO]CONTROLLED sign-in characteristic.
- **Autologin or No Autologin**
A terminal with the Autologin characteristic allows users to sign in without typing a user name. A terminal with the No Autologin characteristic requires that the user enter a user name before gaining access to ACMS. See Section 2.5.1 for information on how to assign the Autologin or No Autologin characteristic.

Authorizing and Controlling Terminals

2.2 How to Run DDU

2.2 How to Run DDU

You can start DDU from DCL level by using either of the following commands:

```
$ RUN SYS$SYSTEM:ACMSDDU
DDU>
```

or

```
$ MCR ACMSDDU
DDU>
```

When you start DDU, ACMS displays the DDU prompt (DDU>). You can then enter any DDU command (including the DDU command HELP to get online help information) or press **PF1** and **PF2** for access to a keypad of DDU commands. Use **Ctrl/B** to recall each DDU command you enter. To exit from DDU, use the DDU command EXIT.

DDU stores device definitions in the device authorization file ACMSDDF.DAT. When you run DDU to authorize terminals, DDU searches for the device authorization file in your current default directory. If ACMSDDF.DAT does not exist, ACMS creates it and places it in your current default directory.

At run time, ACMS looks in SYS\$SYSTEM by default to find the device authorization file. If you choose to place the authorization file in a directory other than SYS\$SYSTEM, you must direct the ACMS system to that directory location by defining the executive mode system logical name ACMSDDF. You can define ACMSDDF as an executive mode system logical name with the DCL DEFINE command and the /SYSTEM and /EXECUTIVE qualifiers. The following command defines ACMSDDF to be the directory DISK1:[SMITH]. You need the SYSNAM privilege to execute this command.

```
$ DEFINE/SYSTEM/EXECUTIVE ACMSDDF DISK1:[SMITH]ACMSDDF.DAT
```

When you run DDU for the first time, ACMS creates a new device authorization file and assigns all devices the characteristics defined by the DDU DEFAULT definition. The initial DEFAULT definition contains the sign-in characteristics Not Controlled and No Autologin. Because of this default, if you use the DDU command ADD without qualifiers after running DDU for the first time, all new terminals have access to both OpenVMS and ACMS.

Since DDU only contains the default definition when you run DDU for the first time, you must authorize a terminal name or a group device name before users have access to the ACMS system.

You can change the sign-in characteristics in the DDU default definition by using the DDU command DEFAULT. The DEFAULT command is described in Section 2.8.

2.3 Creating a DDU Definition

Authorize terminal access to ACMS by creating a DDU definition in the ACMSDDF.DAT. To create a new DDU definition, use the DDU command ADD and specify a device name. The ADD command creates a new DDU definition for the device in the device authorization file. Do not specify a colon at the end of device names. The following command authorizes terminal TTE6. When this command executes, DDU displays a message confirming that the device has been added to the device authorization file.

```
DDU> ADD TTE6
Device TTE6      has been added to the database
```

Authorizing and Controlling Terminals

2.3 Creating a DDU Definition

Instead of specifying a physical device name like TTE6 when you use the ADD command, you can quickly create authorizations for all terminals by specifying the group device name \$ALL. The \$ALL device name is described in Table 2–1, with other DDU group device names.

Table 2–1 DDU Group Device Names

Device Name	Description
\$ALL	Authorizes all terminals. If you create a \$ALL definition, you do not need to create any LT, PT, RT, or VT definitions. The \$ALL definition authorizes all of those types of terminals as well as any unauthorized local terminals. Restrict terminal access to ACMS by creating individual definitions instead of using the \$ALL device name.
LT	Authorizes all LAT terminals. You <i>can</i> authorize individual LAT terminals.
PT	Authorizes all pseudoterminals. You should only use pseudoterminals when you run HP DEC/Test Manager (DTM) sessions. You <i>must</i> authorize the PT device name if you want to run ACMS tasks from DTM. You <i>cannot</i> authorize individual pseudo terminals.
RT	Authorizes all remote terminals. You <i>cannot</i> authorize individual remote terminals.
TT	Authorizes all local terminals. You <i>can</i> authorize individual local terminals.
VT	Authorizes all virtual terminals. You assign virtual terminals for your system with the OpenVMS SYSGEN Utility. You <i>cannot</i> authorize individual virtual terminals.

Display the device names and sign-in characteristics for authorized devices by specifying the DDU SHOW command. See Section 2.9 for information on the SHOW command as well as an example of the output from the SHOW command.

2.4 Copying DDU Definitions

When a definition already exists with characteristics similar to a definition you want to create, you can use the DDU command COPY to create a new definition based on information in an existing DDU definition. The following command authorizes all local terminals using the device definition for terminal TTB6. When this command executes, DDU displays a message confirming that the device definition has been copied.

```
DDU> COPY TTB6 TT
Device TTB6      has been copied to device TT
```

The first device name you specify with the COPY command is the name of the device in the existing device definition. The second device name is the name of the new device. A device name can be a logical name, a physical device name, or a group device name. See Table 2–1 for a list of DDU group device names. See Chapter 17 for more information on the COPY command.

2.5 Modifying DDU Definitions

Use the DDU MODIFY command to change the login characteristics in a device definition. The following subsections explain how to enable Autologin and how to use the /PRINTFILE qualifier.

Authorizing and Controlling Terminals

2.5 Modifying DDU Definitions

2.5.1 Enabling Autologin Terminals

The following command modifies terminal TTE6 so that it is an ACMS-controlled terminal with Autologin enabled. TURKLES is the user name used for automatic login. When this command executes, DDU displays a message confirming that the device definition has been modified.

```
DDU> MODIFY TTE6 /CONTROLLED /AUTOLOGIN=TURKLES
Device(s) has been modified
```

When users press the Return on terminal TTE6, they are prompted for a password (if a password is required) and are logged in to ACMS under the user name TURKLES. The device name you specify with the MODIFY command can be a logical name, a physical device name, or a group device name.

2.5.2 Using the /PRINTFILE Qualifier

The /PRINTFILE qualifier feature provides hardcopy capability for HP DECforms panels. In other words, HP DECforms allows users to send a copy of one or more panel displays to a printer or to a file for subsequent printing. Using DDU, you can specify a Printfile device or file for a terminal. If you specify a device, then it must be a spooled device. (Specifying a Printfile for a user is explained in Chapter 3).

To use the /PRINTFILE qualifier to specify a device or a file name:

1. Use a HP DECforms PRINT response step in a form source IFDL file wherever a response step can be used; for example, you can place it in a field exit response or in a panel exit response. You can also define a key that the user can press to issue the PRINT response. See *HP DECforms Reference Manual* for details about response steps and key definitions.

Note

If you do not enter a /PRINTFILE qualifier either for a device (using DDU) or for a user (with UDU), HP DECforms nevertheless creates a file if a user presses the key associated with the PRINT response. HP DECforms names the file form-name.TXT and places it in the default directory of the agent program.

2. To use the /PRINTFILE qualifier to specify a printfile name or a spooled device, you use the DDU MODIFY command, the device name, the /PRINTFILE qualifier, and the name of the spooled device or printfile specification:

```
DDU> MODIFY <device-name> /PRINTFILE=<spooled-device-name>
```

or

```
DDU> MODIFY <device-name> /PRINTFILE=<print-file-spec>
```

Following is an example of how you might enter the command for a spooled device:

```
DDU> MODIFY TTE5 /PRINTFILE=SPOOLDEV::TXA0:
```

According to the instructions in the preceding example, ACMS modifies the record for the terminal TTE5 in ACMSDDU.DAT to specify that HP DECforms panel screens are to be output on spooled device SPOOLDEV::TXA0:.

Authorizing and Controlling Terminals

2.5 Modifying DDU Definitions

3. After you modify an ACMSDDU.DAT record, use the SHOW command, followed by the device name. DDU displays the /PRINTFILE specification that you have entered, for example:

```
DDU> SHOW TTE5
Device Name:          TTE5          NOT CONTROLLED
No Autologin
Printfile:           SPOOLDEV::TXA0:
```

See Table 2–1 for a list of DDU group device names. See Chapter 17 for more information on the MODIFY command.

2.6 Renaming Device Names in DDU Definitions

Change the device name in a DDU definition by using the RENAME command. The following command changes the device name of terminal TTE6 to TTE7. DDU displays a confirmation message when the device name is renamed.

```
DDU> RENAME TTE6 TTE7
Device TTE6      has been renamed to device TTE7
```

A device name can be a logical name, a physical device name, or a group device name. See Table 2–1 for a list of DDU group device names.

Change the login characteristics of a device by using the /[NO]CONTROLLED and /[NO]AUTOLOGIN qualifiers with the RENAME command. See Section 2.10 and Section 2.5.1 for descriptions of these qualifiers.

You cannot use the RENAME command to modify the default DDU definition. See Chapter 17 for more information on the RENAME command.

2.7 Removing DDU Definitions

If you want to restrict a terminal from accessing ACMS, use the REMOVE command to remove its device definition from the DDU authorization file. The REMOVE command deletes the device definition and displays a message confirming the deletion. The following command removes the DDU definitions for all LAT terminals:

```
DDU> REMOVE LT
Device LT      has been removed from the database
```

A device name can be a logical name, a physical device name, or a group device name. See Table 2–1 for a list of DDU group device names. See Chapter 17 for more information on the REMOVE command.

2.8 DDU DEFAULT Definition

The DDU command DEFAULT changes information in the DDU default definition. When you use the ADD command without any qualifiers, all new terminals receive the characteristics defined in the DDU default definition. The ADD command is the only command affected by the DDU default definition.

The first time you run DDU, the DDU default definition specifies that terminals receive the Not Controlled and No Autologin sign-in characteristics. You can use the /[NO]CONTROLLED, /[NO]AUTOLOGIN, and /PRINTFILE qualifiers with the DEFAULT command to change characteristics in the default definition.

Authorizing and Controlling Terminals

2.8 DDU DEFAULT Definition

The following DEFAULT command changes the DDU default definition so that new terminals receive the Controlled sign-in characteristic. You can use the /NOCONTROLLED qualifier to override the default definition. DDU displays a confirmation message when this command executes.

```
DDU> DEFAULT/CONTROLLED
Device(s) has been modified
```

You can display the sign-in characteristics currently defined in the DDU default definition by using the DDU command SHOW and specifying DEFAULT as a device name. For example:

```
DDU> SHOW DEFAULT
Device Name:      DEFAULT      CONTROLLED
No Autologin
Printfile:
```

The output display tells you that the default sign-in characteristics are Controlled, No Autologin, and No Printfile. All new terminals added with the ADD command without qualifiers are designated as ACMS-controlled terminals with automatic sign-ins disabled and No Printfile.

See Section 2.9 and Chapter 17 for more information about the SHOW command.

2.9 Displaying DDU Definitions

When you add or change device information, you can verify the terminal names and sign-in characteristics in the device authorization file with the DDU SHOW command. Specify a device name with the SHOW command to display all definitions that contain a particular device name, or use the wildcard character (*) to display all current DDU definitions. Example 2–1 shows the output from the SHOW command.

Example 2–1 DDU SHOW Command

```
DDU> SHOW *
Device Name:      $ALL          NOT CONTROLLED
Printfile:

Device Name:      DEFAULT      CONTROLLED
No Autologin
Printfile:

Device Name:      LT           NOT CONTROLLED
No Autologin
Printfile:
```

(continued on next page)

Authorizing and Controlling Terminals

2.9 Displaying DDU Definitions

Example 2–1 (Cont.) DDU SHOW Command

```
Device Name:          LTA12          CONTROLLED
Autologin Username:   SMITH
Printfile:

Device Name:          TT             NOT CONTROLLED
No Autologin
Printfile:

Device Name:          TTE5           NOT CONTROLLED
No Autologin
Printfile:          SPOOLDEV::TXA0:

Device Name:          TTE6           CONTROLLED
Autologin Username:   TURKLES
Printfile:

Device Name:          VTA65         NOT CONTROLLED
No Autologin
Printfile:
```

The SHOW command displays the name of the device, the sign-in characteristic of the device (whether it is controlled or not controlled), whether the autologin option was chosen for sign-in, whether a Printfile option was used and, if so, which one: print-file-spec or spooled-device-name. If the autologin option was chosen for sign-in, the user name used for automatic sign-in also appears.

To have the device information written to a file instead of displayed on a terminal, use the DDU command LIST. See Chapter 17 for more information about the LIST and SHOW commands.

2.10 Defining ACMS-Controlled Terminals

You can define local and LAT terminals as ACMS-controlled terminals. Specify the /CONTROLLED qualifier with the ADD, COPY, DEFAULT, MODIFY, or RENAME commands to control ACMS terminals. The /CONTROLLED qualifier assigns the sign-in characteristic Controlled to a terminal.

The following ADD command creates a device definition with the Controlled sign-in characteristic for local terminal TTE6:

```
$ RUN SYS$SYSTEM:ACMSDDU
DDU> ADD TTE6 /CONTROLLED
Device TTE6 has been added to the database
DDU> EXIT
$
```

The following ADD command creates a device definition with the Controlled sign-in characteristic for LAT terminal LTA11:

```
$ RUN SYS$SYSTEM:ACMSDDU
DDU> ADD LTA11 /CONTROLLED
Device LTA11 has been added to the database
DDU> EXIT
$
```

You can only use the /CONTROLLED qualifier with physical device names or the group device names LT or TT. You receive an error if you use the /CONTROLLED qualifier for definitions with the group device names \$ALL, PT, RT, and VT.

Authorizing and Controlling Terminals

2.10 Defining ACMS-Controlled Terminals

To release a terminal from ACMS control, use the `/NOCONTROLLED` qualifier with the `MODIFY` command. See Section 2.5 for information about the `MODIFY` command.

ACMS makes use of login features set by the OpenVMS `AUTHORIZE` command. Table 2-2 lists the `AUTHORIZE` qualifiers affecting sign-in to ACMS-controlled terminals.

Table 2-2 OpenVMS AUTHORIZE Qualifiers Affecting Sign-in to ACMS-Controlled Terminals

Qualifier	Description
<code>/PASSWORD=(password1 [,password2])</code>	Allows for processing of multiple passwords.
<code>/FLAGS=DISUSER</code>	Disables account.
<code>/EXPIRATION=time</code>	Sets user account expiration.
<code>/ACCESS</code>	Checks user day and hour restrictions.
<code>/FLAGS=DISREPORT</code>	Disables the display of the last date and time of interactive and non-interactive sign-ins. Also disables the display of the number of failed sign-ins since the last successful sign-in.
<code>/FLAGS=DISNEWMAIL</code>	Disables the display of the number of new mail messages.

2.11 Authorizing LAT Terminal Ports as Controlled Terminals

You can use `DDU` to authorize two types of LAT terminal ports as controlled terminals:

- Application ports
With an application port, control passes to ACMS as soon as a key is pressed.
- Dedicated service ports
With a dedicated service port, control passes at the connection to the dedicated service associated with ACMS.

Use `LATCP` to create both application ports and dedicated service ports. Application ports are mapped directly to a physical port on a specific terminal server, while dedicated service ports are mapped to a service name which may be available on a number of nodes. A dedicated service port does not necessarily map to any specific physical terminal port. Rather, a physical terminal becomes associated with an available dedicated service port name (`LTAn:`) when that terminal's user connects to the service with which the port is associated (the service to which it is "dedicated").

From a user perspective, there are two major differences between LAT application ports and dedicated service ports:

- User sign-in
An application port which is an ACMS-controlled terminal requires only that the user press any typing key to begin signing in to ACMS. When using a dedicated service port as an ACMS-controlled terminal, the user must connect to a predetermined LAT service before pressing any key to begin the ACMS sign-in.

Authorizing and Controlling Terminals

2.11 Authorizing LAT Terminal Ports as Controlled Terminals

- Connections to other LAT services

An application port which is an ACMS-controlled terminal gives access only to ACMS. With a dedicated service port, the terminal can be used for purposes other than ACMS application. The user can connect to other LAT services and the terminal is only controlled by ACMS if the user connects to the LAT service being used by ACMS.

When deciding which type of LAT terminal to use as an ACMS-controlled terminal, there are two major factors to consider:

- Availability

If the terminal server to which a controlled terminal (application port) is connected suffers a power failure, that terminal can not function again as a controlled terminal until ACMS/STOP TERMINALS and ACMS/START TERMINALS commands are issued. This means that all ACMS terminal users have to be interrupted before those affected by the power failure can continue working.

In contrast, dedicated service ports continue to be available as controlled terminals as soon as the terminal server has recovered from the power failure; no intervention is required. If this kind of availability is an important issue, dedicated service ports would be the best choice.

- Versatility

When an application port is an ACMS-controlled terminal, it cannot be used for anything else. To do so would require “uncontrolling” it by setting the /NOCONTROLLED attribute in ACMSDDU and issuing the ACMS/RESET TERMINALS command. Dedicated service ports, however, are not actually controlled by ACMS in the same sense that application ports are. A dedicated service port which is a controlled terminal behaves in the same way that an application port does once the user chooses to connect to the appropriate service. But the user can also connect to any other service which is available to the terminal server. As a result, dedicated service ports are a better choice if you wish to use the same terminal for ACMS and non-ACMS work on a regular basis. Conversely, application ports would be a better choice if you wish to restrict a terminal to ACMS use exclusively.

2.12 Controlling LAT Terminals

As described in Section 2.10, you can use the /CONTROLLED qualifier to define LAT terminals as ACMS-controlled terminals. However, before you can control a LAT terminal, you must use the OpenVMS LAT Control Program (LATCP) Utility to define the terminal as an applications port or a dedicated service port and map the port to a terminal server. The following sections explain how to do this.

2.12.1 LAT Setup for an Applications Port

After you have used ACMSDDU to specify that certain terminals are controlled, take the following steps to define the terminal as an applications port:

1. Invoke the LATCP Utility and use the LATCP command CREATE PORT with the /APPLICATION qualifier to define the LAT terminal as an applications port. For example:

```
$ RUN SYS$SYSTEM:LATCP
LCP> CREATE PORT LTA11: /APPLICATION
```

Authorizing and Controlling Terminals

2.12 Controlling LAT Terminals

2. Use the SET PORT command to map the LAT terminal to a port on the terminal server and then exit from the LATCP Utility:

```
LCP> SET PORT LTA11: /APPLICATION /NODE=SAILS /PORT=PORT_1
LCP> EXIT
```

This command specifies that the applications port LTA11 is associated with the port named PORT_1 on the server named SAILS.

3. To use a LAT terminal as an application port, you must set access on the corresponding physical port to remote. Use the SHOW PORT command at the terminal server's "Local>" prompt to determine the access type of the LAT terminal at which you are working. If your terminal is defined as a local or dynamic LAT terminal, you must redefine your terminal to be remote by using the DEFINE PORT command. This command is a privileged LAT command that requires you to use the SET PRIVILEGED command and enter the server's privileged password to enable LAT privileges.

Use the following commands to define your port to be remote:

```
Local> SHOW PORT
Local> SET PRIVILEGED
Password>
Local> DEFINE PORT <port-number> ACCESS REMOTE
```

4. Use the DCL SET TERMINAL command to set the device type of the terminal and the ACMS/RESET TERMINALS command to set the new terminal characteristics:

```
$ SET TERMINAL LTA11 /PERM /DEVICE=VT200
$ ACMS/RESET TERMINALS
```

LTA11 can now be used as an ACMS-controlled terminal. See *VMS LAT Control Program (LATCP) Manual* for more information about LAT terminals.

Instead of using this sequence of commands to define LAT terminals each time you start OpenVMS, you can create a command file of LATCP Utility commands. Create a file called LAT\$SYSTARTUP.COM in SYS\$MANAGER, and include the commands. OpenVMS provides you with a template LAT definition command file, LAT\$SYSTARTUP.TEMPLATE, which is copied to SYS\$MANAGER when you install OpenVMS.

2.12.2 LAT Setup for a Dedicated Service Port

Creating a LAT dedicated service port involves the following steps, which are discussed in the following sections:

- Setup of the terminal server port (using terminal server local mode at the "Local>" prompt)
- Creation of a service (using LATCP)
- Creation of dedicated service ports (using LATCP)
- Association of the dedicated service with the desired service (using LATCP)

Authorizing and Controlling Terminals

2.12 Controlling LAT Terminals

2.12.2.1 Setup of the Terminal Server Port

Dedicated service ports which are used as ACMS-controlled terminals should be placed in local access mode:

```
Local> SHOW PORT
Local> SET PRIVILEGED
Password>
Local> DEFINE PORT <port-number> ACCESS LOCAL
```

See Section 2.12.1 for a description of DEFINE PORT.

You may want to make the service which will be used for dedicated service port connections the preferred service for a LAT terminal which will be controlled by ACMS. Once the preferred service attribute is in effect, the specified service becomes the default parameter of the LAT CONNECT command. This means that the ACMS user can connect to an ACMS application by following this sequence:

1. Enter the CONNECT command at the “Local>” prompt
2. Press Return
3. Press any typing key

This minimizes the difference between the two types of controlled terminals. Preferred service setup is accomplished with the following commands:

```
Local> SET PORT <port-number> PREFERRED <service name>
Local> DEFINE PORT <port-number> PREFERRED <service name>
```

The SET PORT command takes effect immediately and lasts only until the current user logs out of the terminal server. If you wish to make any port attribute last beyond the current login, you must also use the DEFINE PORT command.

As a further convenience to the ACMS user, you may wish to enable the Autoconnect port attribute. This has two results:

- When a new LAT login is initiated, the terminal server will automatically attempt to connect to the preferred service (if one has been defined).
- If the user attempts to connect to any service which is not currently available, the terminal server will periodically attempt to connect to that service for the user.

The LAT commands used to enable the Autoconnect attribute are:

```
Local> SET PORT <port-number> AUTOCONNECT ENABLED
Local> DEFINE PORT <port-number> AUTOCONNECT ENBABLED
```

2.12.2.2 Creation of a Service

Terminal servers make various nodes or applications running on those nodes available to all the terminals connected to the server. A node or application known to a terminal server is called a LAT service.

Note

An “application” LAT service could be ACMS, not to be confused with an application within ACMS.

Authorizing and Controlling Terminals

2.12 Controlling LAT Terminals

Dedicated service ports must be associated with a LAT service before they can be used. The following LATCP command creates a service named ACMS_SERVICE:

```
LCP> CREATE SERVICE /APPLICATION ACMS_SERVICE
```

The service type (APPLICATION) and service name (ACMS_SERVICE) will be referred to later when setting up dedicated service ports in LATCP. You can also associate a dedicated service port with a service which is a node. This can create complications for other LAT terminal users on the node in question, however, and is not recommended for that reason. For example, if you associate a node name with a dedicated service port and not all dedicated service ports are currently in use, no one will be able to connect to that node from the “Local>” prompt without ACMS controlling the terminal.

Care should be taken when creating service names on particular nodes. If a given service is defined on two different nodes known to the terminal server in use, connections will only complete to the node on which the service has the highest rating. If the ACMS Terminal Subsystem Controller (TSC) is not started on the node on which the connection is completed, no connection will occur (unless a program running on the node happens to have opened a channel to the terminal — in that case, the connection will be established and the terminal will be usable by that program). If the service is defined on different nodes with the same static rating, it is unpredictable which node will receive a given connection. Therefore, it is recommended that each service be defined on only one node unless ACMS (including TSC) will generally be started on all nodes on which the service is defined.

2.12.2.3 Creation of Dedicated Service Ports

It is important to understand that there is no direct correlation between a particular physical port on a DECserver and a dedicated service port created with LATCP. When a terminal connects to a service for which dedicated service ports exist, that terminal becomes associated with an available dedicated service port name for the duration of the connection. Typically, there will be a many-to-one mapping between dedicated service ports and a service name.

If a direct correspondence between physical ports and dedicated service ports is desired, it can only be achieved by creating a service for each port, and connecting to only that service when using the given terminal.

The names of dedicated service ports must be of the form LTAn:, where n is a number. One such port name should be created for each terminal which is to be used as a controlled dedicated service port. To do this, use the following command:

```
LCP> CREATE PORT LTAn: /DEDICATED
```

2.12.2.4 Association of the Dedicated Service Port with the Desired Service

Once a dedicated service port has been created, it must be associated with a service before it can be used. This is done with the LATCP SET PORT command:

```
LCP> SET PORT LTAn: /DEDICATED/SERVICE=<service name>
```

Note that the /SERVICE qualifier cannot be used with the CREATE PORT command.

Authorizing and Controlling Terminals

2.12 Controlling LAT Terminals

2.12.2.5 Terminal Setup

Once a dedicated service port has been created, its terminal type should be identified on the node to which it will connect. For example, if LTA1 is a VT300, the following command should be entered:

```
$ SET TERMINAL LTA1: /DEVICE=VT300/PERMANENT
```

This should be done for all dedicated service ports when they are created in LATCP. It is possible (and most probably desirable) to create dedicated service ports, associate them with a service, and set the terminal type using DCL command procedure(s).

2.12.2.6 Using a Dedicated Service Port

Before a dedicated service port can be used as an ACMS-controlled terminal, the user must connect to the correct service. When the connect command has been issued at the “Local>” prompt, one of three responses should occur. If the connection is possible, the following message will be displayed:

```
Local -010- Session 1 to ACMS_CT on node ORANGE established
```

This assumes that this is the user’s only current connection and that the service name is ACMS_CT on node ORANGE.

At this point, TSC will begin listening for a keystroke at the terminal. When one is detected, the process of signing the terminal in to ACMS will proceed in the same way as it does for application ports.

If the service is known but a connection could not be established, the following message will be displayed:

```
Local -011- Connection to ACMS_CT not established
          Insufficient Node resources
```

This message is displayed when there are no channels open to the dedicated service port on the node with which LAT attempted to establish a connection. In some cases, it is normal to see this message after a hangup occurs; this is because of a necessary delay in opening a new channel to the terminal.

If repeated attempts to connect result in this message, the ACMS terminal subsystem may need to be started on that node. Because the message can be displayed for a variety of reasons, the system manager or person in charge of managing the ACMS application should be notified.

If the connection cannot be connected because the service has not been created, the following message will be displayed:

```
Local -711- Service ACMS_CT not known
```

If this occurs, refer to the instructions for creating services with LATCP.

A dedicated service port user signs out of ACMS exactly as if using an application port. The only difference is that a dedicated service port will return the user to the “Local>” prompt; with an application port, TSC would display a logout message and immediately begin listening again.

The following example illustrates all the steps involved in setting up dedicated service ports for use as ACMS-controlled terminals. A new service is created for controlled terminal connections, and three ports dedicated to the new service are created. Terminal output from LATCP and ACMSDDU is omitted.

Authorizing and Controlling Terminals

2.12 Controlling LAT Terminals

Note that with the exception of the ACMSDDU portion, all of these actions need to be taken each time the system is booted. As a result, it is recommended that they be included in a system startup command procedure, such as the following:

```
$!  
$! Create service and ports in LATCP  
$!  
$ RUN SYS$SYSTEM:LATCP  
LCP> CREATE SERVICE /APPLICATION ACMS_CT  
LCP> CREATE PORT LTA101: /DEDICATED  
LCP> SET PORT LTA101: /DEDICATED/SERVICE=ACMS_CT  
LCP> CREATE PORT LTA102: /DEDICATED  
LCP> SET PORT LTA102: /DEDICATED/SERVICE=ACMS_CT  
LCP> CREATE PORT LTA103: /DEDICATED  
LCP> SET PORT LTA103: /DEDICATED/SERVICE=ACMS_CT  
LCP> EXIT  
$!  
$! Define terminal device type  
$!  
$ SET TERM LTA101: /DEV=VT300/PERM  
$ SET TERM LTA102: /DEV=VT300/PERM  
$ SET TERM LTA103: /DEV=VT300/PERM  
$!  
$! Authorize terminals in ACMSDDU  
$!  
$ RUN SYS$SYSTEM:ACMSDDU  
DDU>ADD LTA101: /CONTROLLED  
DDU>ADD LTA102: /CONTROLLED  
DDU>ADD LTA103: /CONTROLLED  
DDU>EXIT  
$!  
$! Terminals LTA101:, LTA102: and LTA103: are now ready for use  
$!
```

The following is an example of what the user sees when using a dedicated service port as an ACMS-controlled terminal.

If the terminal is not logged in to the terminal server, the user should press **Return** twice. A display similar to this will appear:

```
DECserver 200 Terminal Server V3.0 (BL31) - LAT V5.1  
Please type HELP if you need assistance  
Enter username>
```

At the username prompt, the user should enter a string (this is not subject to any verification) and press **Return**.

If the autoconnect attribute has been enabled for the user's port, the terminal server will immediately attempt to connect to any preferred service that may have been defined; otherwise, the user must connect to the appropriate service (in this example, we assume that the service name for ACMS sign-ins is ACMS_CT).

If ACMS_CT is the preferred service, the following will suffice:

```
Local> CONNECT
```

If ACMS_CT is not the preferred service, the user must enter:

```
Local> CONNECT ACMS_CT
```

The connection will be established or fail, accompanied by the messages detailed earlier.

Between the time the LAT connection is established and when the user signs out of ACMS, there is no visible difference between the types of LAT terminals. In both cases, the user presses any typing key in order to begin signing in to ACMS. A prompt for user name and password may or may not follow, depending on how the user's account and ACMS authorization are defined.

When the user signs out of ACMS, control will be returned to the terminal server's "Local>" prompt.

2.13 Enabling Automatic User Sign-ins

Use the /AUTOLOGIN qualifier with the ADD, COPY, DEFAULT, MODIFY or RENAME commands to allow users of ACMS-controlled terminals to sign in directly to ACMS without typing a user name. When a user presses Return on an ACMS-controlled terminal with Autologin enabled, ACMS retrieves the user name for that terminal from the device authorization file. If no password is required, the user is signed in automatically.

The /AUTOLOGIN qualifier enables automatic sign-ins for controlled terminals only. If a terminal has the Not Controlled sign-in characteristic, the Autologin characteristic has no effect; users must use the ACMS/ENTER command for access to ACMS from DCL as usual.

You can disable automatic sign-ins by using the /NOAUTOLOGIN qualifier. The /NOAUTOLOGIN qualifier is the default.

2.14 Summary of DDU Commands and Qualifiers

DDU commands allow you to display, create, modify, and remove device definitions stored in the DDU device authorization file. Table 2-3 lists the DDU commands and qualifiers and provides a brief description of each command. For more detailed information on a DDU command, see Chapter 17.

Table 2-3 Summary of DDU Commands

Commands and Qualifiers	Description
ADD /[NO]AUTOLOGIN=username /[NO]CONTROLLED /PRINTFILE[=print-file-spec/spooled-device-name]	Authorizes and assigns sign-in characteristics to ACMS terminals by adding DDU definitions to the device authorization file. If you omit qualifiers, the new definition takes information from the DDU default definition.
COPY /[NO]AUTOLOGIN=username /[NO]CONTROLLED /PRINTFILE[=print-file-spec/spooled-device-name]	Authorizes and assigns sign-in characteristics to ACMS terminals by copying information from an existing DDU definition.
DEFAULT /[NO]AUTOLOGIN=username /[NO]CONTROLLED /PRINTFILE[=print-file-spec/spooled-device-name]	Changes information in the DEFAULT definition. If you omit qualifiers from the ADD command, the new definition takes information from the existing DDU default definition.
EXIT	Ends the DDU session and returns you to the DCL prompt.

(continued on next page)

Authorizing and Controlling Terminals

2.14 Summary of DDU Commands and Qualifiers

Table 2–3 (Cont.) Summary of DDU Commands

Commands and Qualifiers	Description
HELP /[NO]PROMPT	Displays information about DDU commands, qualifiers, and parameters.
LIST /BRIEF /OUTPUT[=file-spec]	Writes DDU definitions to ACMSDDU.LIS in your default directory, or to the output file you specify.
MODIFY /[NO]AUTOLOGIN=username /[NO]CONTROLLED /PRINTFILE[=print-file-spec/spooled-device-name]	Changes information in DDU definitions.
REMOVE	Removes DDU definitions from the device authorization file.
RENAME /[NO]AUTOLOGIN=username /[NO]CONTROLLED /PRINTFILE[=print-file-spec/spooled-device-name]	Changes the device name and, optionally, the sign-in characteristic information in DDU definitions.
SHOW /BRIEF	Displays DDU definitions at your terminal.

Authorizing Users

This chapter describes how to use the ACMS User Definition Utility (UDU) to create or change user definitions that UDU stores in the user authorization file (ACMSUDF.DAT). Section 3.6 provides a summary of UDU commands and qualifiers. For reference information on the commands described in this chapter, refer to Chapter 18.

3.1 How UDU Works

Use UDU commands and qualifiers to create a database user authorization file (ACMSUDF.DAT) that contains records of individual user information. Using UDU is similar to using the OpenVMS Authorize Utility. With UDU, you define the characteristics under which a user signs in to ACMS. These characteristics include:

- The name of the user
- Whether or not a user name can submit tasks to ACMS for other users
- Whether or not the user runs an initial task when signing in
- What the terminal screen displays upon sign-in: either a menu and a selection prompt, or just a selection prompt
- Which menu ACMS should display if the initial sign-in screen displays a menu
- Whether or not the user runs a final task when signing out

When a user tries to sign in to ACMS, ACMS checks the user authorization file for a definition with that user name. If the authorization file does not contain a definition for that user name, ACMS checks for a \$ALL definition to see if all OpenVMS user names are authorized for ACMS access. If there is no \$ALL definition, ACMS denies access to the user.

3.2 How to Run UDU

Before using UDU to authorize ACMS users, you must authorize users to log in to the OpenVMS operating system. ACMS users must first be authorized OpenVMS users because their OpenVMS user names and passwords are verified against the OpenVMS SYSUAF.DAT file. See the OpenVMS documentation on the Authorize Utility for information about authorizing OpenVMS users.

When you run UDU to authorize users, UDU creates the user authorization file in your current default directory. By default, at run time ACMS looks in SYS\$SYSTEM to find the user authorization file. If you choose to place the authorization file in a directory other than SYS\$SYSTEM, you must direct the ACMS system to that location by defining an EXEC mode system logical name, called ACMSUDF, to point to that directory.

Authorizing Users

3.2 How to Run UDU

For example:

```
$ DEFINE/SYSTEM/EXEC ACMSUDF DEVDISK:ACMSUDF.DAT
```

Run UDU by entering either of the following commands:

```
$ RUN SYS$SYSTEM:ACMSUDU
UDU>
```

or

```
$ MCR ACMSUDU
UDU>
```

When you see the UDU prompt (UDU>), you can begin entering UDU commands. If you enter a UDU command and want to include several qualifiers, you can include all the qualifiers on one line, for example:

```
ADD user-name /MDB=ACMS.MDB /MENU=EMPLOYEE /AGENT
```

The same command can be entered on several lines if you use the hyphen (–) to indicate a continuation line. For example:

```
UDU> ADD user-name -
_UDU> /MDB=ACMS.MDB /MENU=EMPLOYEE /AGENT
```

You can recall each UDU command you enter by pressing **Ctrl/B**. UDU also supplies a keypad of UDU commands. Press **PF1** and **PF2** to see the keypad display. Type EXIT or press **Ctrl/Z** to exit from UDU.

Chapter 18 contains information about each UDU command and its qualifiers. You can also get information by using the UDU HELP command followed by the command name:

```
UDU> HELP ADD
```

General information about UDU is available at the DCL prompt by typing:

```
$ HELP @ACMSUDU
```

3.3 Running UDU the First Time

ACMS creates a default definition the first time you run UDU, or when you create a new user authorization file. At run time, ACMS assigns the top-level menu and selection prompt, the menu database file specification ACMS\$DIRECTORY:ACMS.MDB, and a blank menu path name to the DEFAULT definition.

When you use the ADD command to create a new UDU definition, the new definition takes the default information defined in the DEFAULT definition. You can use qualifiers with the ADD command to override information from the DEFAULT definition.

Before authorizing multiple new users, it might be convenient to change the initial values in the DEFAULT definition. For example, if you plan to authorize 10 users, all of whom use the menu database PERS_MENU.MDB, you can change the name of the menu database using the UDU DEFAULT or MODIFY command. For example:

```
UDU> DEFAULT /MDB=PERS_MENU
UDU> ADD $ALL
```

When you authorize the 10 users with the ADD command, you do not need to use the /MDB qualifier because the ADD command uses the default value from the UDU DEFAULT definition.

When you specify a menu database with the /MDB qualifier, ACMS assumes the default menu database is in the directory that the logical ACMS\$DIRECTORY points to. However, if the database is in another location, you must include in the DEFAULT command the device and directory name where the file is stored. For example:

```
UDU> MODIFY DEFAULT /MDB=DISKNAME:[GORDON]ACMS.MDB
```

If you do not specify a file type, UDU assumes the .MDB file type by default.

3.4 Authorizing New Users

The following sections show several different approaches to take when authorizing users. For example, if you have few users to authorize, you may want to write individual authorizations for each user. If you have many users to authorize, you may want to take advantage of the DEFAULT authorization and the \$ALL user name.

The next six sections describe the UDU commands you use to authorize new ACMS users and give examples of how to use these commands.

3.4.1 Authorizing Users with ADD, COPY, DEFAULT, and \$ALL

Use the ADD or COPY commands to create definitions that authorize ACMS users. Using the ADD command, you create a new definition by either allowing the user information to come from the UDU DEFAULT definition, or typing in the necessary qualifier information yourself. This example adds the user name RICHARDS to ACMSUDU.DAT, taking all information from the UDU DEFAULT definition except the menu database file:

```
UDU> ADD RICHARDS /MDB=DISK02:[USERMENUS]ADDTASKS
```

When a definition already exists with characteristics similar to one you want to create, you can use the COPY command to create a new definition based on information from the existing UDU definition. This example copies information from the RICHARDS user definition to create the new GORDON definition:

```
UDU> COPY RICHARDS GORDON
```

You can quickly create authorizations for all OpenVMS users by specifying \$ALL as the user name with the ADD or COPY command. A \$ALL definition authorizes all users at once, assigning them the same sign-in display, default menu, and menu database file.

If the user authorization file does not contain a \$ALL definition, each ACMS user must have a separate user definition. With separate user definitions, you can restrict some OpenVMS users from signing in to ACMS.

Depending on how many users you are authorizing and the characteristics you want to assign them, you might want to use a \$ALL definition to provide generic definitions for all users. Then, you can create separate definitions for those users who need characteristics that most other users do not, such as the agent qualifier.

You must create at least two user definitions: one to authorize the ACMS user (or a \$ALL definition to authorize all OpenVMS users), and one to authorize the user name of the ACMS Command Process (see Section 3.4.6 for information on authorizing the Command Process).

Authorizing Users

3.4 Authorizing New Users

3.4.2 Defining User Initial and Final Tasks

As system manager, you can specify that a user runs a specific task when signing in to ACMS and that the user runs a specific task when signing out of ACMS. For example, you can specify that whenever a user signs in, a task asks for the user's name and telephone number. Or, if a user only runs one particular task all the time, you can specify that that task runs whenever the user signs in without having to select that task from a menu. When the user signs out, you can specify that an accounting task runs to log the user's work for the day — sign in and sign out time, number of files created, amount of disk space used, and so forth.

To specify an initial or final task for a user, use the `/INITIAL` or `/FINAL` qualifier with the `UDU ADD`, `COPY`, `MODIFY`, `DEFAULT`, or `RENAME` commands. The `/INITIAL` qualifier specifies the name of a task the user runs when signing in. The `/FINAL` qualifier specifies the name of a task the user runs when signing out.

The following command specifies that a user runs the task `BOOKING_INFO` in the application `RESERVATIONS` whenever signing in to ACMS:

```
UDU> ADD FORRESTER/INITIAL=(APPLICATION=RESERVATIONS,TASK =
_UDU> =BOOKING_INFO)
```

This command specifies that a user runs the task `ACCOUNTING` in the application `CLERK_REC` whenever signing out of ACMS:

```
UDU> ADD KNUTH/FINAL=(APPLICATION=CLERK_REC,TASK=ACCOUNTING)
```

You can use keywords to the `/INITIAL` and `/FINAL` qualifiers to specify how errors are handled if an error occurs in an initial or final task. By default, if the specified initial task fails, UDU displays an error message describing the reason for the failure, records the task's status in the Audit Trail Log, and signs the user out of ACMS. The final task (if one is specified) does not execute. You can specify that ACMS ignore errors in an initial task by specifying the `IGNORE_ERROR` keyword with the `/INITIAL` qualifier. When an error occurs in the initial task, the user remains signed in. For example:

```
UDU> ADD EINSTEIN/INITIAL=(APPLICATION=RESOURCES,TASK=ACCT, -
_UDU> IGNORE_ERROR)
```

If an error occurs in a final task, ACMS displays the error message "Final task failed" and records the reason for the error in the Audit Trail Log. You can use the `IGNORE_ERROR` keyword with the `/FINAL` qualifier to specify that ACMS ignore an error in the final task. For example:

```
UDU> ADD PLATO/FINAL=(APPLICATION=REC_APPL,TASK=UPDATE,IGNORE_ERROR)
```

When you use the `IGNORE_ERROR` keyword for a final task, ACMS does not issue an error message or record the error in the Audit Trail Log when an error occurs.

Specify a parameter (such as a file name) with an initial or final task, by using the `SELECTION_STRING` keyword. The following command specifies that a user run the final task `SHOW_TRANSACTIONS` whenever signing out of ACMS. `SHOW_TRANSACTIONS` displays a file containing a record of the day's events. `TRANSACTION_OUTPUT.DAT` is the log file displayed:

```
UDU> ADD TOLSTOY/FINAL=(APPLICATION=ACCOUNTING,TASK= -
_UDU> SHOW_TRANSACTIONS, SELECTION_STRING="TRANSACTION_OUTPUT.DAT")
```

Authorizing Users

3.4 Authorizing New Users

You can display the initial and final tasks defined for a user by using the SHOW command. For example:

```
UDU> SHOW TOLSTOY

User Name:      TOLSTOY          DISPLAY MENU
Default Menu:
Default MDB:    INVENTORY
Initial Task:   IGNORE ERROR
  Application:  RESOURCE
  Task:         ACCT
  Selection:
Final Task:    IGNORE ERROR
  Application:  ACCOUNTING
  Task:         SHOW_TRANSACTIONS
  Selection:    TRANSACTION_OUTPUT.DAT
Language:
Printfile:
```

ACMS has a special menu called ACMS\$EXIT to use when no menu processing should be performed for a user. For example, if users have an initial task established that performs menu control for those users, you can assign the ACMS\$EXIT menu to those users to perform an exit from ACMS whenever they exit from the initial task. For example:

```
UDU> MODIFY LAO/MDB=ACMS /MENU=ACMS$EXIT/INITIAL= -
_UDU> (APPLICATION=RESERVATIONS,TASK=RESERVE_MENU)
```

This example defines an initial task for user LAO that serves as a menu control task. When this task exits, user LAO does not have a menu displayed at the terminal. Instead, the user is signed out of the ACMS system.

The TDMS request for the ACMS\$EXIT menu returns "Exit" as if it were typed by the user at the selection prompt, but does this without terminal interaction.

3.4.3 Defining the Initial Menu Display

Menu displays help users to select tasks. Upon signing in, each ACMS user sees either a menu and a selection prompt, or just a selection prompt. For users who need a menu and a selection prompt, specify a default menu in the user definition by assigning each user a menu database file with the /MDB qualifier, and a menu path name with the /MENU qualifier. If you do not include this information in the UDU definition, the ACMS default is to assign the user the top-level menu in the menu tree. This feature provides security to the system, because it enables you to restrict certain menus to selected users.

Menus offer a limited amount of task protection, since a menu can restrict the tasks that a user can select (if the SELECT command is disabled). However, other measures are required for adequate task protection. For more information on task protection, refer to *HP ACMS for OpenVMS ADU Reference Manual*.

For users who need only the selection prompt, specify that no menu be displayed by using the /NODISPLAY_MENU qualifier in the user definition. For example, you might want to suppress the menu display for more experienced users. Or, if the default menu is the highest menu in the menu tree, you might want to reduce the need to page through several levels of menus by having the initial menu display be lower in the menu tree.

Authorizing Users

3.4 Authorizing New Users

The following example shows how the /NODISPLAY_MENU qualifier suppresses the menu display for the user name WINSTON:

```
UDU> SHOW WINSTON
User name:      WINSTON      DISPLAY MENU
Default menu:
Default MDB:    EMPLOYEE
Initial Task:
  Application:
  Task:
  Selection:
Final Task:          IGNORE ERROR
  Application:    PAYROLL
  Task:          SHOW_CHANGES
  Selection:      PAYROLL.DAT

Language:
Printfile:
```

```
UDU> MODIFY WINSTON /NODISPLAY_MENU
```

```
UDU> SHOW WINSTON
User name:      WINSTON
Default menu:
Default MDB:    EMPLOYEE
Initial Task:
  Application:
  Task:
  Selection:
Final Task:          IGNORE ERROR
  Application:    PAYROLL
  Task:          SHOW_CHANGES
  Selection:      PAYROLL.DAT

Language:
Printfile:
```

The sign-in display you define with UDU is only the initial display characteristic. Users can modify their sign-in displays at run time by selecting the MENU and NOMENU commands in the ACMS command menu. The online *ACMS Terminal User's Guide* describes the MENU and NOMENU commands. It is available in the SYS\$HELP directory.

3.4.4 Specifying a Language for a User

With HP DECforms, you can create a number of different layouts for a form. One way to use the multiple-layout feature is to specify a natural language for each layout in a form. For example, within the same form, use one layout for panels in French, another layout for panels in Spanish, and a third layout for panels in English.

Note

If you define several layouts in a form, you **must** specify a language for each layout if you want to display any layout other than the first one.

To specify a language for an existing form, first select the "Modify Layout" option on the HP DECforms FDE Main Menu. HP DECforms then displays the Modify Layout Screen, where the "Language" prompt appears. To assign a language to a layout, enter the name of the language, for example:

Authorizing Users

3.4 Authorizing New Users

```
Layout Name: FRENCH_PANEL
.
.
Language: FRENCH
```

You can use the language specification for purposes other than to associate a natural language with a layout. You can, for example, use the layout language specification to distinguish panels designed for novice, experienced, and expert users.

To select a layout for each user of HP DECforms forms, you assign a language to a user by adding a language specification to the UDU utility database. You do this by using the `MODIFY` command with the `/LANGUAGE` qualifier. To select panels in French for the user LeBlanc, for example, you enter the following:

```
UDU> MODIFY LEBLANC/LANGUAGE=FRENCH
```

When you specify a language for a user in UDU, the language is used to select the appropriate layout among HP DECforms forms and to display the correct panels to the user. The name of the language also appears when you use the `SHOW` command to display a user's record, for example:

```
UDU> SHOW LEBLANC
User name:          LEBLANC          DISPLAY MENU
.
.
Language:   FRENCH
```

You can specify a language for HP DECforms forms that is used both in ACMS tasks and in ACMS menus. The HP DECforms menu form supplied by ACMS contains a standard layout without any language name. You need to specify a language in a menu form to display the menu to users who enter through the Command Process (CP) and who have a corresponding language specified in the `ACMSUDU.DAT` file.

By specifying a language for a menu form layout, you can update the prompt and the instruction line of the menu to use the appropriate language. To translate the header and the entries of the menu, however, you must use a different menu definition (`.MDF`) for each language.

You can display the same menu to all users, whether they have a language specified for them or not. In this case, use only one language for the prompt and instruction line; this saves the step of adding a layout for each language in the menu form. An additional benefit is to keep the size of the menu form to a minimum.

To specify a language for a user for all forms except menu forms, you use the `/SKIPMENULANGUAGE` qualifier. To select NOVICE forms to be displayed to Smith for tasks but not for menus, you enter the following:

```
UDU> MODIFY SMITH/LANGUAGE=NOVICE/SKIPMENULANGUAGE
```

After you add the `SKIPMENULANGUAGE` qualifier, it appears on the user's record when you issue the `SHOW` command:

Authorizing Users

3.4 Authorizing New Users

```
UDU> SHOW LEBLANC
User name:          LEBLANC          DISPLAY MENU
.
.
.
Language:   FRENCH          SKIPMENULANGUAGE
```

3.4.5 Specifying a Printfile for a User

Besides using the /PRINTFILE qualifier to specify a printfile name or a spooled device name for a terminal device (which is explained in Chapter 2), you can also use this qualifier to specify a printfile name or spooled device name for a user.

When a form is enabled, ACMS uses the Printfile characteristic for the terminal device, if it is available. If the characteristic is not found, ACMS uses the Printfile characteristic for the user. If neither has been specified, but a PRINT response and a print key are defined in the form source IFDL file, a file with the name <form-name>.TXT is placed in the SYS\$MANAGER directory (if the CP is the agent), or in the default directory of the agent.

To use the /PRINTFILE qualifier for a user, follow these steps:

1. Use a HP DECforms PRINT response step in a form source IFDL file wherever a response step can be used; for example, you can place it in a field exit response or in a panel exit response. Also define a print key that users press when they want to print a panel. See *HP DECforms Reference Manual* for details about response steps and defining HP DECforms keys.
2. To specify a printfile for a user in ACMS, use UDU to enter your printfile specification:

```
UDU> MODIFY <username>/PRINTFILE=<print-file-spec>/<spooled-device-name>
```

When you enter a printfile specification, ACMS uses this name for the HP DECforms panel screen. When you enter a spooled device name, ACMS sends any panel screen for this user to the spooled device that you specify.

After you modify a user's record with the /PRINTFILE qualifier, the new specification appears when you display user information using the SHOW command, for example:

```
UDU> MODIFY WINSTON /PRINTFILE=SPOOLDEV::TXA0:
UDU> SHOW WINSTON
User name:          WINSTON
Default menu:
Default MDB:       EMPLOYEE
Initial Task:
Application:
Task:
Selection:
Final Task:                IGNORE ERROR
Application:   PAYROLL
Task:          SHOW_CHANGES
Selection:     PAYROLL.DAT
Language:
Printfile:   SPOOLDEV::TXA0:
```

When a form is enabled, ACMS uses the printfile specification for a device assigned by the Device Definition Utility (DDU), if it is available. If it is not, ACMS uses the printfile specification for the user, as specified in UDU.

3.4.6 Authorizing User Names as Agents

Normally, ACMS users can submit tasks only under their own user names. An agent is an OpenVMS process that submits ACMS tasks for processing on behalf of ACMS users whose user names are different from the agent's user name. For security reasons, you must authorize agents by adding the user name of the agent process and including the /AGENT qualifier.

The CP and the Queued Task Initiator (QTI) are agents supplied by ACMS. ACMS requires that you create separate user definitions using the /AGENT qualifier to authorize the CP and the QTI as agents. If your system does not have any agents created with the ACMS Systems Interface (SI), you need only authorize the user name of the CP and QTI as agents.

Although ACMS assigns the user name SYSTEM to the Command Process when you install ACMS, it does not automatically authorize the SYSTEM user name. You must authorize the user name of the Command Process as an agent before it can handle sign-ins, task submission, and interaction between ACMS and ACMS users. (If you wish to change the user name of the Command Process to something other than SYSTEM, you can do so using the ACMSGEN Utility.) To authorize the Command Process with the SYSTEM user name, use these UDU commands:

```
UDU> ADD SYSTEM/AGENT
User SYSTEM          has been added to the data base
UDU> SHOW SYSTEM
User name:          SYSTEM          DISPLAY MENU          AGENT
Default menu:
Default MDB:
Initial Task:
  Application:
  Task:
  Selection:
Final Task:
  Application:
  Task:
  Selection:

Language:
Printfile:
```

If your system has agents that were created using the ACMS Systems Interface (SI), you must authorize the user names of these OpenVMS processes using the /AGENT qualifier. For example, to authorize an SI agent with the user name SI_AGENT, use these commands:

```
UDU> ADD SI_AGENT/AGENT -
_UDU> /MDB=DISK$:[TOPLEVEL]ACMS.MDB -
_UDU> /MENU=PERSONNEL
User SI_AGENT has been added to the data base
UDU> SHOW SI_AGENT
User name:          SI_AGENT          AGENT
Default menu:      PERSONNEL
Default MDB:       DISK$:[TOPLEVEL]ACMS.MDB
Initial Task:
  Application:
  Task:
  Selection:
Final Task:
  Application:
  Task:
  Selection:
```

Authorizing Users

3.4 Authorizing New Users

Language:
Printfile:

As the example shows, when authorizing a user name with the /AGENT qualifier, you must explicitly assign the display characteristic and a menu database file to that user name. You can also assign a default menu path name. With its user name defined in the user authorization file, SI_AGENT can submit tasks to ACMS under any user name. See *HP ACMS for OpenVMS Systems Interface Programming* for more information on the SI.

3.5 Working with Existing UDU Definitions

From time to time you have to update UDU definitions. During a UDU session you may need to display, list, delete, or rename the user definitions in the user authorization file. This section shows you how to manipulate existing UDU definitions.

3.5.1 Looking at UDU Definitions with SHOW and LIST

When you add or change user information, you can verify information in the authorization file with either the SHOW or the LIST command.

UDU provides a SHOW command to display information on your terminal and a LIST command to copy UDU definitions to an output file. Use the SHOW and the LIST commands to verify the names and default menus after you have added several users. For example:

```
UDU> SHOW *

User name:      $ALL          DISPLAY MENU
Default Menu:
Default MDB:    INVENTORY
Initial Task:   IGNORE ERROR
  Application:  VALIDATE_APPL
  Task:        ACCESS_RIGHTS
  Selection:
Final Task:
  Application:
  Task:
  Selection:

Language:
Printfile:

User name:      CRAWFORD      DISPLAY MENU
Default Menu:
Default MDB:    ACCOUNTING
Initial Task:
  Application:
  Task:
  Selection:
Final Task:    IGNORE ERROR
  Application:  PAYROLL
  Task:        SHOW_CHANGES
  Selection:   PAYROLL.DAT

Language:
Printfile:
```

When you specify the wildcard character (*), UDU displays all definitions in the user authorization file. To see a particular user definition, specify the user name with the SHOW command.

Authorizing Users

3.5 Working with Existing UDU Definitions

To copy information from the user authorization file to the ACMSUDU.LIS file, type the LIST command with the user name or wildcard character (*) at the UDU prompt:

```
UDU> LIST GORDON
```

This command copies the GORDON definition to the ACMSUDU.LIS file in your default directory.

3.5.2 Deleting UDU Definitions

If a user is no longer a valid ACMS user, remove the user definition from the user authorization file with the REMOVE command. The REMOVE command deletes the user definition from ACMSUDEF.DAT and displays a message confirming the action. For the user name parameter, you can use an OpenVMS user name or \$ALL.

3.5.3 Renaming UDU Definitions

Use the RENAME command when you want to change a user name. Because the RENAME command uses the same qualifiers as the ADD, COPY, DEFAULT, and MODIFY commands, you can change any of the original characteristics while you change the user name.

3.6 Summary of UDU Commands and Qualifiers

UDU commands allow you to create, change, and remove user definitions, and change user names. Table 3–1 lists the UDU commands and qualifiers and provides a brief description of each command. For a complete description of the UDU commands and qualifiers, see Chapter 18.

Table 3–1 Summary of UDU Commands

Commands and Qualifiers	Description
ADD /[NO]AGENT /[NO]DISPLAY_MENU /[NO]FINAL /[NO]INITIAL /LANGUAGE[=language-name] /MDB=menu-database-file /MENU[=menu-path-name] /PRINTFILE[=print-file-spec/spooled-device-name] /[NO]SKIPMENULANGUAGE	Adds a new user record to the user authorization file. Unless qualifiers are included, the user information comes from the DEFAULT definition.
ADD /PROXY	Adds a user proxy to the ACMS proxy file (ACMSPROXY.DAT). Before you can use the ADD /PROXY command, you must have already created a proxy file with the CREATE /PROXY command.

(continued on next page)

Authorizing Users

3.6 Summary of UDU Commands and Qualifiers

Table 3–1 (Cont.) Summary of UDU Commands

Commands and Qualifiers	Description
COPY /[NO]AGENT /[NO]DISPLAY_MENU /[NO]FINAL /[NO]INITIAL /LANGUAGE[=language-name] /MDB=menu-database-file /MENU[=menu-path-name] /PRINTFILE[=print-file-spec/spooled-device-name] /[NO]SKIPMENULANGUAGE	Authorizes and assigns sign-in characteristics to new users by copying information from an existing UDU definition.
CREATE /PROXY	Creates an empty ACMS proxy file (ACMSPROXY.DAT).
DEFAULT /[NO]AGENT /[NO]DISPLAY_MENU /[NO]FINAL /[NO]INITIAL /LANGUAGE[=language-name] /MDB=menu-database-file /MENU[=menu-path-name] /PRINTFILE[=print-file-spec/spooled-device-name] /[NO]SKIPMENULANGUAGE	Changes information in the DEFAULT definition. If you omit one or more qualifiers from the ADD command, the new definition takes information from the existing DEFAULT definition.
EXIT	Ends the UDU session and returns you to the DCL prompt.
HELP /[NO]PROMPT	Provides online information about UDU commands.
LIST /BRIEF /output=[file-spec]	Writes UDU definitions to ACMSUDU.LIS in your default directory or to an output file you specify.
LIST /PROXY /OUTPUT=file-spec	Writes all the proxies in the ACMS proxy file to the output file ACMSPROXY.LIS. You can use the /OUTPUT qualifier to specify a different output file name.
MODIFY /[NO]AGENT /[NO]DISPLAY_MENU /[NO]FINAL /[NO]INITIAL /LANGUAGE[=language-name] /MDB=menu-database-file /MENU[=menu-path-name] /PRINTFILE[=print-file-spec/spooled-device-name] /[NO]SKIPMENULANGUAGE	Changes information in UDU definitions.
REMOVE	Removes UDU definitions from the user authorization file, ACMSUDF.DAT.
REMOVE /PROXY	Removes the specified proxy from the ACMS proxy file (ACMSPROXY.DAT).

(continued on next page)

Authorizing Users

3.6 Summary of UDU Commands and Qualifiers

Table 3–1 (Cont.) Summary of UDU Commands

Commands and Qualifiers	Description
RENAME /[NO]AGENT /[NO]DISPLAY_MENU /[NO]FINAL /[NO]INITIAL /LANGUAGE[=language-name] /MDB=menu-database-file /MENU[=menu-path-name] /PRINTFILE[=print-file-spec/spooled-device-name] /[NO]SKIPMENULANGUAGE	Changes the user name and, with qualifiers, other information in UDU definitions.
SHOW /BRIEF	Displays UDU definitions at your terminal.
SHOW /PROXY	Displays one or more proxies in the ACMS proxy file (ACMSPROXY.DAT).

Authorizing Applications

This chapter describes the use of the ACMS Application Authorization Utility (AAU) to authorize ACMS applications. See Section 4.6 for a summary of AAU commands and qualifiers. For reference information on the commands described in this chapter, refer to Chapter 19.

4.1 How AAU Works

System managers use the Application Authorization Utility (AAU) to create an application authorization file (ACMSAAF.DAT) that contains records, called **authorizations**, of an application's information. Authorizing applications lets a system manager define the characteristics of an application, such as:

- Name of the application
- UIC and/or identifier of each user authorized to install the application in ACMS\$DIRECTORY
- User name of the application
- User names of the server processes used by the application
- Specification for whether the application can run with dynamic user names or the user names of terminal users

Figure 4–1 shows the authorization portion of the AAU process.

Figure 4–1 AAU Application Authorization Process

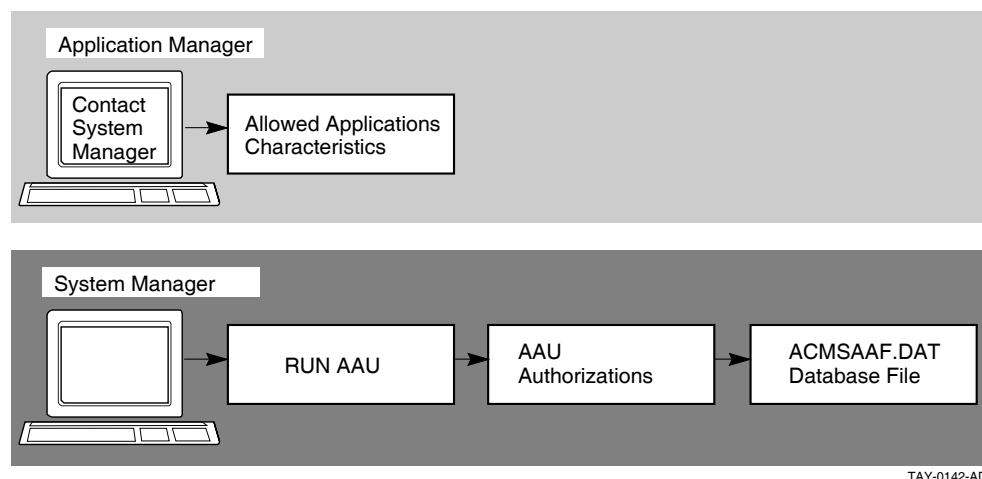

Before users can start an ACMS application, the application database file for that application must be stored in the directory pointed to by the logical name ACMS\$DIRECTORY. For security reasons, this directory is set up as a protected

Authorizing Applications

4.1 How AAU Works

directory to prevent an unauthorized user from storing applications containing tasks that run under privileged user names.

With the AAU commands and qualifiers, a system manager can authorize applications and grant application installation rights to users who otherwise do not have access to ACMS\$DIRECTORY. Users who are authorized to install .ADB files can then install the application in ACMS\$DIRECTORY by using the ACMS/INSTALL operator command.

Using AAU is optional for users who already have access to ACMS\$DIRECTORY. These users can store .ADB files in ACMS\$DIRECTORY without authorization in the AAU. For example, these users could use the DCL COPY command to copy an .ADB file into ACMS\$DIRECTORY.

By authorizing users to install applications, you gain the following benefits:

- Assigning installation of applications to the users most involved with those applications leaves system managers free for other tasks.
- By systematically checking applications, the AAU provides extra security and frees system managers from manually checking applications.
- Users can install applications at their convenience without having privileged access to the ACMS\$DIRECTORY directory. The system manager can also limit the applications a user is allowed to install.

Users named in the AAU database can use the ACMS/INSTALL operator command to install any application for which they have installation authorization. When a user issues this command, ACMS checks the AAU authorization file (ACMSAAF.DAT) to see if the application has an authorization in the file and if the user running the ACMS/INSTALL command is authorized to install the application. If either the application or the user trying to install it is not authorized in the AAU authorization file, ACMS prevents the installation of the application.

4.2 How to Run AAU

Use either of the following commands to run AAU:

```
$ RUN SYS$SYSTEM:ACMSAAU
AAU>
```

or

```
$ MCR ACMSAAU
AAU>
```

When you run AAU, ACMS displays the AAU prompt (AAU<!CLOSE>). Then enter any AAU command (including the AAU command HELP to get online help information) or press the **[PF1]** and **[PF2]** keys for access to a keypad of AAU commands. Press **[Ctrl/B]** to recall each AAU command you enter. To exit from AAU, use the AAU command EXIT or press **[Ctrl/Z]**.

When you run AAU, ACMS searches for the ACMSAAF.DAT in SYS\$SYSTEM. If ACMSAAF.DAT does not exist, you are asked if you want to create a new authorization file. You can store ACMSAAF.DAT in a directory other than SYS\$SYSTEM by defining the executive mode system logical name ACMSAAF:

```
$ DEFINE/SYSTEM/EXEC ACMSAAF DEVDISK:ACMSAAF.DAT
```

ACMS creates a DEFAULT authorization the first time you run AAU, or any time you run AAU from a directory that has no ACMSAAF.DAT. The DEFAULT authorization is created with an empty access control list; by default, no users are authorized to install applications in ACMS\$DIRECTORY. Table 4–1 contains a list of the initial values that AAU assigns to the DEFAULT authorization when it is created.

Table 4–1 Initial Settings for the DEFAULT Authorization

Qualifier	Default Setting
/ACL	(IDENTIFICATION=*, ACCESS=NONE)—the default ACL denies installation rights
/APPL_USERNAME	/APPL_USERNAME=*
/[NO]WILD_SUFFIX	/NOWILD_SUFFIX
/[NO]DYN_USERNAMES	/NODYN_USERNAMES
/SRV_USERNAMES	/SRV_USERNAMES=*

In Table 4–1, the wildcard character (*) indicates that any user name or ID in the application is acceptable. To ensure that an application is running with the right user names, override the wildcard defaults by assigning user names in application authorizations.

4.3 Before Authorizing Applications

Before starting to authorize applications, you may want to change the initial default values in the DEFAULT authorization. Do this with either the DEFAULT or the MODIFY command. The new values should reflect the characteristics that you intend to assign to the majority of applications you plan to authorize.

For example, suppose you have to authorize five applications and plan to give the same users the right to install all the applications. Assign a default value to those users in the DEFAULT authorization. When you authorize the five applications with the ADD command, you do not need to use the /ACL qualifier. The ADD command uses the default /ACL value from the DEFAULT authorization.

Because of privileges and quotas that are associated with certain user names, you must be careful about:

- User name under which an application runs
- User names of server processes for an application
- Whether or not server processes in an application should run with dynamic user names

For example, suppose an application manager decides that several applications should run only with particular user names and server process user names, and that these applications should run without server processes having dynamic user names. The application manager can use AAU to create applications in such a way that the application is not installed unless these settings match the ones found in the .ADB file.

Figure 4–2 shows the information that must match before an application can be installed.

Authorizing Applications

4.3 Before Authorizing Applications

Figure 4–2 Conditions for Installing an Application

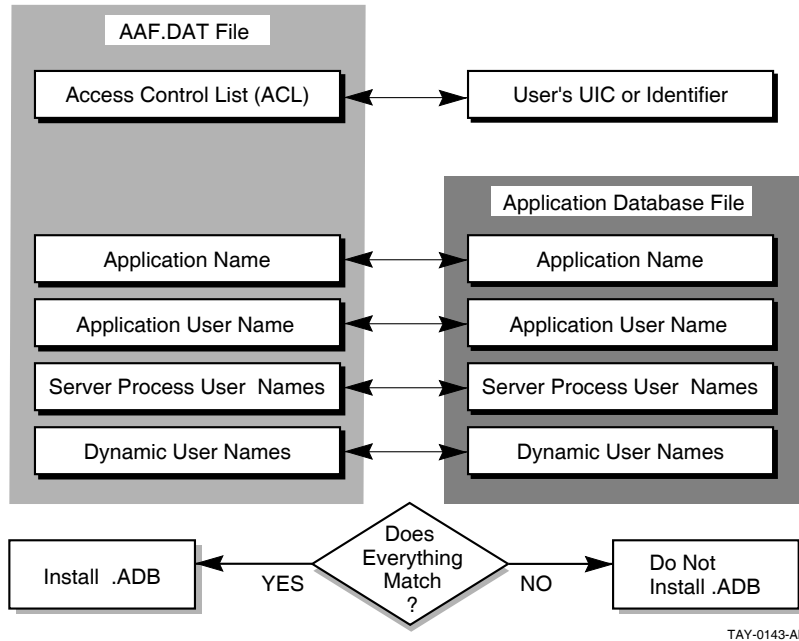

Even if the application information is changed, the application cannot be installed unless it has the same values the application manager originally assigned in the application authorization. This extra layer of security ensures that each application running on an ACMS system has passed a series of tests that protect applications from unauthorized use.

4.4 Authorizing New Applications

The following sections show several different approaches to take when authorizing applications. For example, if you have few applications to authorize, you may want to write individual authorizations for each application. If you have many applications to authorize, you may want to take advantage of the DEFAULT authorization using the \$ALL application name.

4.4.1 Authorizing All Applications with \$ALL

The quickest and simplest way to authorize applications is to create a \$ALL authorization. Use \$ALL as the application name when you enter the ADD command in response to the AAU prompt. For example:

```
AAU> ADD $ALL /ACL=(IDENTIFIER=[GORDON],ACCESS=CONTROL)
```

If you have not altered the DEFAULT authorization, the \$ALL authorization takes the default values that ACMS originally sets for all the qualifiers you do not include with the ADD command. The preceding ADD command, therefore, creates a \$ALL authorization allowing user GORDON to install any application on the system.

4.4.2 Authorizing Individual Applications

If you choose to create individual authorizations for each application, name the application with the ADD command and assign any necessary qualifiers. For example:

```
AAU> ADD INVENTORY /ACL=(ID=[GORDON],ACCESS=CONTROL) -  
_AAU> /APPL_USERNAME=INVTRY -  
_AAU> /SRV_USERNAMES=(PARTS,STOCK) -  
_AAU> /DYNAMIC_USERNAMES -  
_AAU> /NOWILD_SUFFIX
```

This command authorizes user GORDON to install the application INVENTORY if the application database file (.ADB) has the application user name INVTRY and two server processes with user names PARTS and STOCK. The /DYNAMIC_USERNAMES qualifier lets user GORDON install the INVENTORY application with the dynamic user name characteristic. Because all qualifiers are included, the ADD command does not use any default values from the DEFAULT authorization.

When there is an authorization in the AAU authorization file with characteristics similar to one you want to create, you can save time by using the COPY command. For example:

```
AAU> COPY INVENTORY ACCOUNTING /ACL=(ID=[SMITH],ACC=CON) -  
_AAU> /SRV_USERNAMES=(ADD,SUB)
```

Here the COPY command creates an exact copy of the INVENTORY application authorization and names it ACCOUNTING. The qualifiers with the COPY command change the authorized user to SMITH and the two server user names to ADD and SUB.

4.4.3 Authorizing Applications with /[NO]WILD_SUFFIX

The /[NO]WILD_SUFFIX qualifier allows a user to install or prevents a user from installing any application whose name begins with the letters of the application name you are installing.

If your ACMS system has many applications that begin with the same characters, the /WILD_SUFFIX qualifier can save you time and give you additional flexibility when you are creating authorizations. For example:

```
AAU> ADD TEST /WILD_SUFFIX /APPL_USERNAME=TEST_EXE -  
_AAU> /ACL=(ID=[SMITH],ACCESS=CONTROL) -  
_AAU> /SRV_USERNAMES=(TEST1,TEST2) -  
_AAU> /NODYN_USERNAMES
```

This command lets the authorized user SMITH install any application that starts with the letters TEST. SMITH can install applications such as TEST, TESTA, TESTB, TESTC, TEST1.

4.5 Working with Existing AAU Authorizations

During an AAU session you may need to display, list, delete, or rename the application authorizations in the AAU authorization file. The following sections describe these functions.

Authorizing Applications

4.5 Working with Existing AAU Authorizations

4.5.1 Looking at AAU Authorizations with SHOW and LIST

There are many occasions when a quick check of authorizations in the AAU authorization file is helpful. For example, you may need to check the DEFAULT authorization if you cannot remember its current settings. To display application authorizations on your terminal screen, use the SHOW command. The output from the SHOW command is shown in Example 4–1.

When you use the wildcard character (*), AAU displays all authorizations in the AAU authorization file. To see a particular application authorization, include the application name with the SHOW command.

To obtain a hardcopy listing of information in the authorization file, use the LIST command with the application name at the AAU> prompt. For example:

```
AAU> LIST CREDITOR
```

This command copies the contents of the CREDITOR application authorization to the ACMSAAU.LIS file in your default directory.

Example 4–1 AAU SHOW Command

```
AAU> SHOW *
=====
Appl Name: $ALL
Appl Username: *
Server Usernames:
*
Access Control List:
(IDENTIFIER=[*,*],ACCESS=CONTROL)
=====
Appl Name: CREDITOR
Appl Username: CREDIT
Server Usernames:
CREDIT1
CREDIT2
Access Control List:
(IDENTIFIER=[PAYUP,*],ACCESS=CONTROL)
=====
Appl Name: DEFAULT                                WILD SUFFIX
Appl Username: DEBT
Server Usernames:
DEBT1
DEBT2
Access Control List:
(IDENTIFIER=[PERSONNEL,*],ACCESS=CONTROL)
=====
AAU>
```

4.5.2 Deleting Authorizations from ACMSAAF.DAT

If an application is no longer being used, you need to remove its authorization from the AAU authorization file. When you identify unused applications, you can delete them with the REMOVE command. The REMOVE command deletes the application authorization from the authorization file and prints a message confirming the action. The application name can be that of an application, or it can be \$ALL.

Authorizing Applications

4.5 Working with Existing AAU Authorizations

4.5.3 Renaming AAU Authorizations

You can use the RENAME command when you want to change the name of an authorization. Because the RENAME command uses the same qualifiers as the ADD, COPY, DEFAULT, and MODIFY commands, you can change any of the original authorization's characteristics while you change the authorization's name.

4.6 Summary of AAU Commands and Qualifiers

AAU commands allow you to create, change, and remove device definitions stored in the AAU authorization file. Table 4–2 lists the AAU commands and qualifiers and provides a brief description of each command. See Chapter 19 for a complete description of each AAU command and qualifier.

Table 4–2 Summary of AAU Commands

Commands and Qualifiers	Description
ADD /ACL=(ace[,...]) /APPL_USERNAME=appl-username /[NO]DYNAMIC_USERNAMES /[NO]WILD_SUFFIX /SRV_USERNAME [(srv-username[,...])]	Creates authorizations so that AAU authorized users can install application database files in ACMS\$DIRECTORY. If you omit the qualifiers, the new definition takes qualifier information from the DEFAULT definition.
COPY /ACL=(ace[,...]) /APPL_USERNAME=appl-username /[NO]DYNAMIC_USERNAMES /[NO]WILD_SUFFIX /SRV_USERNAME [(srv-username[,...])]	Creates a new authorization by copying information from an existing authorization and, with qualifiers, changes other information.
DEFAULT /ACL=(ace[,...]) /APPL_USERNAME=appl-username /[NO]DYNAMIC_USERNAMES /[NO]WILD_SUFFIX /SRV_USERNAME [(srv-username[,...])]	Changes information in the DEFAULT authorization. If you omit one or more qualifiers from the ADD command, the new authorization takes information from the existing DEFAULT authorization.
EXIT	Ends the AAU session and returns you to the DCL prompt.
HELP /[NO]PROMPT	Displays information about AAU commands, parameters, and qualifiers.
LIST /BRIEF /OUTPUT=[file-spec]	Writes AAU definitions to ACMSAAU.LIS in your default directory or to an output file you specify.
MODIFY /ACL=(ace[,...]) /APPL_USERNAME=appl-username /[NO]DYNAMIC_USERNAMES /[NO]WILD_SUFFIX /SRV_USERNAMES [(srv-username[,...])]	Changes information in AAU authorizations.

(continued on next page)

Authorizing Applications

4.6 Summary of AAU Commands and Qualifiers

Table 4–2 (Cont.) Summary of AAU Commands

Commands and Qualifiers	Description
REMOVE	Deletes an authorization from the authorization file (ACMSAAF.DAT).
RENAME /ACL=(ace[,...]) /APPL_USERNAME=appl-username /[NO]DYNAMIC_USERNAMES /[NO]WILD_SUFFIX /SRV_USERNAMES [(srv-username[,...])]	Changes the name of an application authorization and, with qualifiers, other information in the AAU authorization.
SHOW /BRIEF	Displays application authorizations at your terminal.

Creating and Managing Queues

This chapter describes how to create and manage ACMS queues and how to manage queued task elements using the ACMSQUEMGR Utility. This chapter assumes a general knowledge of the ACMS Queued Task Facility. Please read the description of the ACMS Queued Task Facility in *HP ACMS for OpenVMS Concepts and Design Guidelines* before reading this chapter. See Section 5.6 for a summary of ACMSQUEMGR commands and qualifiers. For reference information on the commands described in this chapter, refer to Chapter 20.

5.1 How ACMSQUEMGR Works

Use ACMS Queue Manager (ACMSQUEMGR) Utility commands to create and manage task queues and to manage the elements in the task queues. In addition to using the ACMSQUEMGR, system managers and application managers who are responsible for the ACMS Queued Task facility may need to:

- Control the Queued Task Initiator (QTI) to process task queues. The QTI must be started before you can start task queues. See Chapter 8 for information on the operator commands you can use to control the QTI and start task queues.
- Set up an OpenVMS user name for the QTI process. See Chapter 11 for information about defining a user name for the QTI.
- Monitor the QTI process by reading the QTI audit reports generated by the Audit Trail Logger. See Chapter 12 for information about monitoring the QTI process.

Use the ACMSQUEMGR commands to perform operations directly on task queues or queued task elements while you use queuing operator commands to control the QTI's processing of task queues.

Note

ACMS task queues are totally independent from OpenVMS task queues.

Use ACMSQUEMGR commands to create and delete task queues and display information about the task queues as well as to modify static and dynamic characteristics of task queues. When you create a task queue, ACMSQUEMGR creates a queue definition file to keep information about each of the queues on a system or cluster. The queue definition file contains the following information about a queue:

- Name of the task queue
- Whether or not tasks can be queued (the enqueue state)
- Whether or not queued task elements in the queue can be read and processed by the QTI (the dequeue state)

Creating and Managing Queues

5.1 How ACMSQUEMGR Works

- Maximum workspace size for a task executing in the task queue
- File specification of the task queue repository file

You can also use ACMSQUEMGR commands to manage any queued task elements in the task queues. When you queue a task, the ACMS\$QUEUE_TASK service creates a record of information for that task called a queued task element. Queued task elements for a queue are stored in a queue repository file. A queued task element contains the following information about a task:

- Task name
- Application name
- Workspace values
- Element priority
- Queue name
- Enqueue user name
- Enqueue time
- Enqueue state
- Element ID
- Error count

The information in a queued task element is specified by using parameters to the ACMS\$QUEUE_TASK service. See *HP ACMS for OpenVMS Writing Applications* for more information about the ACMS Queued Task Services.

An element ID is assigned to the queued task element when it is created with the ACMS\$QUEUE_TASK service. Use the element ID with ACMSQUEMGR commands to set the processing characteristics of a queued task element, delete a queued task element, or display information about queued task elements.

5.2 How to Run ACMSQUEMGR

Use either of the following commands to start the ACMSQUEMGR Utility:

```
$ RUN SYS$SYSTEM:ACMSQUEMGR
ACMSQUEMGR>
```

or

```
$ MCR ACMSQUEMGR
ACMSQUEMGR>
```

When you see the ACMSQUEMGR prompt (ACMSQUEMGR>), you can begin entering ACMSQUEMGR commands, including the HELP command, to get online help information.

Instead of typing in individual ACMSQUEMGR commands, you can enter ACMSQUEMGR commands by pressing keypad keys. Press the **PF1** and **PF2** keypad keys for access to the ACMSQUEMGR command keypad. Press **Ctrl/B** to recall each of the last 20 ACMSQUEMGR commands you entered. To exit from the ACMSQUEMGR, press **Ctrl/Z** or use the EXIT command.

ACMSQUEMGR also supports DCL foreign commands. From DCL level, define the DCL symbol ACMSQUEMGR as a foreign command in your LOGIN.COM file.

Creating and Managing Queues

5.2 How to Run ACMSQUEMGR

For example:

```
$ ACMSQUEMGR:==$SYS$SYSTEM:ACMSQUEMGR
```

Once you define ACMSQUEMGR as a DCL foreign command, you can issue ACMSQUEMGR commands from DCL level. For example:

```
$ ACMSQUEMGR SHOW ELEMENT * PAYROLL_QUEUE
$ ACMSQUEMGR DELETE ELEMENT PAYRL::2F600041 PAYROLL_QUEUE
$ ACMSQUEMGR SET QUEUE PAYROLL_QUEUE /ENQUEUES=SUSPENDED
```

See *OpenVMS DCL Dictionary* for more information on foreign commands.

To run the ACMSQUEMGR, you need:

- Read/write access to the ACMS queue definition file (ACMSQDF.DAT)
- Access to the queue file or files with which you are going to work

When you run ACMSQUEMGR for the first time, it searches for an existing queue definition file and, if it does not find one, asks you if you want to create a new file. For example:

```
%ACMSQUEMGR-I-ERROPNFIL, Unable to open the ACMS Queue Definition File
                        SYS$SYSROOT:[SYSEXE]ACMSQDF.DAT
-RMS-F-FNF, file not found
Do you want to create a new file?
```

If you answer YES to this question, the ACMSQUEMGR creates a new queue definition file. Otherwise, the ACMSQUEMGR exits.

By default, the queue definition file is named SYS\$SYSTEM:ACMSQDF.DAT, but you can define the logical name ACMSQDF to point to a different file specification or location:

```
$ DEFINE /SYSTEM /EXEC ACMSQDF $DISK1:[MYDIR]ACMSQDF.DAT
```

When you are using the ACMSQUEMGR Utility, you can use any access mode for the ACMSQDF logical. However, at run time, ACMS Queued Task Services require that ACMSQDF be an executive-mode logical name. If you expect a queue definition file to exist when you run ACMSQUEMGR, check that the logical name ACMSQDF is pointing to the correct file specification.

5.3 Managing Task Queues

Use the following ACMSQUEMGR commands to create and manage ACMS task queues:

- CREATE QUEUE
- SET QUEUE
- MODIFY QUEUE
- DELETE QUEUE
- SHOW QUEUE

These commands are described in the following sections.

Creating and Managing Queues

5.3 Managing Task Queues

5.3.1 Creating Task Queues

You use the `CREATE QUEUE` command to create a task queue. Once you have created a queue, it can be reached through the `ACMS$QUEUE_TASK` service to enqueue elements to the queue, and also by the `QTI` to process the elements in the queue. The following command creates a queue called `PERS_QUEUE`. Because this command does not include a full file specification for the queue, the `ACMSQUEMGR` Utility creates the queue `SYS$SYSTEM:PERS_QUEUE.DAT`.

```
ACMSQUEMGR> CREATE QUEUE PERS_QUEUE
```

When you use the `CREATE QUEUE` command to create a queue, the `ACMSQUEMGR` Utility sets the owner of the queue file to `[1,4]` and sets the protection of the file to `S:RWED,O:RWED,G,W`. Therefore, to access the queue file, a user must have a system `UIC` or must have the `SYSPRV` privilege.

5.3.2 Setting the Characteristics of Task Queues

You can dynamically control the availability of task queues by using the `SET QUEUE` command. For example, the `SET QUEUE` command can be used to prevent queued task elements from being queued to a task queue. Likewise, the `SET QUEUE` command can prevent queued task elements from being dequeued from a task queue.

When you use the `SET QUEUE` command, you must use either the `/DEQUEUE` or `/ENQUEUE` qualifier.

The `/ENQUEUE` qualifier allows or disallows queued task elements to be queued. The following example disables the queuing of queued task elements to queue `HISTORY_QUE`:

```
ACMSQUEMGR> SET QUEUE /ENQUEUE=SUSPENDED HISTORY_QUE
```

When the enqueue state of a task queue is set to `SUSPENDED`, the `ACMS$QUEUE_TASK` service returns an error when elements are queued to the task queue. Use `/ENQUEUE=RESUMED` to enable queuing of elements.

Allow or disallow the `QTI` to dequeue all queued task elements in a queue by using the `/DEQUEUE` qualifier. Dequeuing is the process whereby the `QTI` reads and then deletes a queued task element to make a task available for processing. The `/DEQUEUE` qualifier in the following command specifies that no queued task elements can be dequeued from `MY_QUE`. No queued task elements are processed until you set the dequeue state to `RESUMED`.

```
ACMSQUEMGR> SET QUEUE /DEQUEUE=SUSPENDED MY_QUE
```

By using the `/DEQUEUE=SUSPENDED` qualifier, you can allow tasks to be queued to a queue, but suspend their processing. When dequeues are suspended, the `ACMS$DEQUEUE_TASK` service returns an error. When you want tasks to be processed by the `QTI`, specify the `/DEQUEUE=RESUMED` qualifier.

5.3.3 Modifying Task Queues

You can modify the static characteristics of a task queue by using the `MODIFY QUEUE` command. This can include changing the disk where a queue repository file is located, or increasing the maximum workspace size for a task queue to allow for the size requirements of a new task in your application. In any case, you do not need to modify the characteristics of a task queue on a frequent basis.

The `MODIFY QUEUE` command requires exclusive access to the task queue. Make sure that no processes have access to the queue by setting the enqueue and dequeue state of the task queue to suspended. To do this, use the `SET QUEUE` command and then stop the queue with the `ACMS/STOP QUEUE` command.

The following command modifies the maximum workspace size allowed for a queued task element in task queue `PAY_QUE`:

```
ACMSQUEMGR> MODIFY QUEUE PAY_QUE/MAX_WORK=450
```

Use the `/FILE_SPECIFICATION` qualifier with the `MODIFY QUEUE` command to specify the name of a new queue repository file. The queue repository file contains the queued task elements for a queue and is created when you create the queue with the `CREATE QUEUE` command. The following command changes the location of the queue repository file for queue `MY_QUE`:

```
ACMSQUEMGR> MODIFY QUEUE MY_QUE/FILE_SPEC=DISK2:MY_QUE.DAT
```

5.3.4 Deleting Task Queues

Use the `ACMSQUEMGR DELETE QUEUE` command to delete a task queue. To delete a task queue, you need to delete access to the queue repository file, and the task queue must be stopped. The following command deletes task queue `PAY_QUE`:

```
ACMSQUEMGR> DELETE QUEUE PAY_QUE
```

The `/PURGE` qualifier deletes all queued task elements in the queue when you delete the queue. For example:

```
ACMSQUEMGR> DELETE QUEUE/PURGE PAY_QUE
```

If you do not specify the `/PURGE` qualifier and there are queued task elements in the task queue, `ACMSQUEMGR` is unable to delete the task queue and displays an error message.

5.3.5 Displaying Task Queue Information

The `SHOW QUEUE` command displays information about task queues currently defined in the queue definition file. The `SHOW QUEUE` command in Example 5–1 displays information about the queue `PAYROLL_QUE`. You can display information about all queues by using the wildcard character (*).

Example 5–1 ACMSQUEMGR SHOW QUEUE Command

```
ACMSQUEMGR> SHOW QUEUE PAYROLL_QUE
```

```
1 Queue Name: PAYROLL_QUE  
2 Enqueues State: RESUMED 3 Dequeues State: RESUMED 4 Max Wsp Size: 256  
5 File Specification: SYS$SYSTEM:PAYROLL_QUE.DAT
```

The following is a description of the numbered items in Example 5–1:

1 Queue Name

The name of the task queue.

2 Enqueues State

Whether or not new tasks can be queued. If the enqueues state is enabled, new tasks can be queued. If it is disabled, they cannot be queued.

Creating and Managing Queues

5.3 Managing Task Queues

3 Dequeues State

If the dequeues state is enabled, queued tasks can be removed from the queue. If it is disabled, they cannot be removed.

4 Max Wsp Size

The maximum total size (in bytes) of workspaces allowed in a queued task element.

5 File Specification

The file specification of the queue repository file. The queue repository file stores the queued task elements. By default, the queue repository file has the file specification `SYS$SYSTEM:queue-name.DAT`; however, you can specify another file specification by using the `/FILE_SPECIFICATION` qualifier with the `CREATE QUEUE` command.

See Chapter 20 for more information about the `SHOW QUEUE` command.

5.4 Managing Queued Task Elements

Use `ACMSQUEMGR` commands to:

- Alter the processing priority or state of a queued task element
- Delete a queued task element
- Display information about a queued task element

The commands you can use to perform these operations are described in the following sections.

Associated with each queued task element is an element ID. The element ID is returned by the `ACMS$QUEUE_TASK` programming service. `ACMSQUEMGR` commands that perform operations on queued task elements require that you specify the element ID of the queued task element. This implies that your application program, which called the `ACMS$QUEUE_TASK` programming service, made available to you the element ID. Another way to obtain an element ID is to display all queued task elements (or a subset thereof) using the `ACMSQUEMGR` command `SHOW ELEMENT` (see Section 5.4.3). Then, once you locate the element you are interested in, note its element ID.

If you specify a partial element ID, the omitted fields are wildcarded. For example, an element ID of `ABCD::` matches all element IDs beginning with `ABCD::`; that is, all elements enqueued from node `ABCD`. See Chapter 20 for more information about specifying an element ID.

Although you can perform operations on specific queued task elements by specifying element IDs, you can use the wildcard character (*) instead of an element ID, and then use the `/SELECT`, `/EXCLUDE`, and `/CONFIRM` qualifiers to limit the scope of the command to the specified elements. This approach is best if you do not know the element ID or you want to perform operations on several elements at once.

For example, the following command deletes all queued task elements in queue `INVENTORY_QUE` for tasks `UPDATE_PART1` and `UPDATE_PART2` that were queued today but are not priority 1 or 2:

```
ACMSQUEMGR> DELETE ELEMENT * INVENTORY_QUE -
_ACMSQUEMGR> /SELECT=(TASK=(UPDATE_PART1,UPDATE_PART2), -
_ACMSQUEMGR> SINCE=TODAY) -
_ACMSQUEMGR> /EXCLUDE=PRIORITY=(1,2)
```

5.4.1 Setting the Characteristics of Queued Task Elements

Set the state or priority of a queued task element with the ACMSQUEMGR SET ELEMENT command. Setting the attributes of a queued task element allows you to control how it is dequeued.

Setting the priority of an element allows you to control when the element is dequeued relative to other elements in the queue. You can specify a priority of 0 through 255. The QTI and the ACMS\$DEQUEUE_TASK service dequeue highest priority elements first, and, within priority, dequeue elements on a first-in/first-out (FIFO) basis. For example, if all queued task elements in a queue are set at priority 10, then normally they would be processed in FIFO order. To cause a particular queued task element to be processed first, you issue the following command:

```
ACMSQUEMGR> ELEMENT NODE1:22D00082-0000000E PARTS_QUE /PRIORITY=11
```

To control whether or not the QTI and the ACMS\$DEQUEUE_TASK service dequeue a queued task element, use the /STATE qualifier with the SET ELEMENT command. For instance, if you set the state of a queued task element to HOLD, then the element is not dequeued from the queue. For example:

```
ACMSQUEMGR> SET ELEMENT NODE1:22D00082-0000000E PARTS_QUE -  
_ACMSQUEMGR> /STATE=HOLD
```

Setting an element to HOLD is useful when you want to start a queue, but do not want certain elements to be processed by the QTI. To allow a queued task element to be dequeued, specify /STATE=NOHOLD.

You can specify a wildcard character (*) instead of an element ID, and use the /SELECT or /EXCLUDE qualifiers to limit the scope of the command.

For example, if you want the QTI to process queued task elements for the task UPDATE_INVENTORY only between the hours of 6:00 and 10:00 at night, then set the state of the queued task elements to HOLD and submit a batch job to run at 6:00 that issues the following command:

```
ACMSQUEMGR> SET ELEMENT * INVENTORY_QUE /STATE=NOHOLD -  
_ACMSQUEMGR> /SELECT=TASK=UPDATE_INVENTORY
```

Assuming that INVENTORY_QUE is started, then these elements are now available for dequeuing and processing by the QTI. If you want processing to stop at 10:00 P.M. that evening, run a batch job at that time containing the following command:

```
ACMSQUEMGR> SET ELEMENT * INVENTORY_QUE /STATE=HOLD -  
_ACMSQUEMGR> /SELECT=TASK=UPDATE_INVENTORY
```

5.4.2 Deleting Queued Task Elements

Use the DELETE ELEMENT command to delete one or more queued task elements in a task queue. Identify a particular element to delete by specifying part or all of an element ID, or use the wildcard character (*) to delete all queued task elements in a queue. This command deletes all queued task elements submitted from node AVERTZ in queue MY_QUE:

```
ACMSQUEMGR> DELETE ELEMENT AVERTZ:: MY_QUE
```

Creating and Managing Queues

5.4 Managing Queued Task Elements

Use the /SELECT or /EXCLUDE qualifiers to select a category of queued task elements to delete, or exclude a category from being deleted. The following command deletes all queued task elements submitted before today on queue PAY_QUE:

```
ACMSQUEMGR> DELETE ELEMENT * PAY_QUE /SELECT=BEFORE=TODAY
```

5.4.3 Displaying Queued Task Elements

The SHOW ELEMENT command displays one or more queued task elements in a queue. Unless you specify the /FULL qualifier, brief information is provided by default. The brief display contains the following information:

- Task name
- Element state
- Application name
- Element priority

When you use the /FULL qualifier, the following additional information is displayed. See Example 5–2 for an example of a full display.

- Enqueuer user name
- Time the task element was created
- Queue name
- Element ID
- Error count (if any) for the queue element
- Task error (if any)

Example 5–2 ACMSQUEMGR SHOW ELEMENT/FULL

```
ACMSQUEMGR> SHOW ELEMENT * INVENTORY_QUE/FULL
```

```
ACMS Queued Tasks                               Current Date/Time: 2-FEB-1994 13:21:31.13
1 Task: PARTS_AVAIL                               2 State: NOHOLD
3 Appl: SITE_INVENT                               4 Priority: 20
5 Username: NORTH                                6 Enq Time: 2-FEB-1994 10:13:17.71
7 Queue Name: PAYROLL_QUEUE
8 Element Id: MYNODE::28C00082-0000000F-FDE272E0-0090AB3F
9 Error Cnt: 1
10 Last Error: %ACMS-E-NOSUCH_PKG, There is no such package defined
11 Error Time: 2-FEB-1994 11:38:39.24

Task: PARTS_REQ                                   State: NOHOLD
Appl: SITE_INVENT                               Priority: 20
Username: JONES                                 Enq Time: 15-JAN-1994 10:13:16.85
Queue Name: PAYROLL_QUEUE
Element Id: MYNODE::28C00082-0000000E-FD5F3920-0090AB3F
Error Cnt: 0
Queued Task total for this display: 2
```

The following is a description of the numbered items in Example 5–2:

- 1 Task
The name of the task.

Creating and Managing Queues

5.4 Managing Queued Task Elements

- 2 State
The processing characteristics of the task element—whether it is set to HOLD or NOHOLD.
- 3 Appl
The name of the application containing the task.
- 4 Priority
The priority of the queued task element.
- 5 Username
The enqueuer user name specified explicitly or implicitly with ACMS\$QUEUE_TASK service.
- 6 Enq time
The time the queued task element was created.
- 7 Queue name
The name of the task queue.
- 8 Element ID
The ID for the queued task element.
- 9 Error cnt
The number of times this queued task element has failed.
- 10 Last error
The last error that occurred while attempting to process the queued task element. This field is not displayed when the error count is zero.
- 11 Error time
The time that the last error occurred. This field is not displayed when the error count is zero.

A queued task element within a queue can have two states: HOLD and NOHOLD. Each of these states can be further qualified to yield a total of four different states/substates:

- NOHOLD—The element is available for processing by the QTI, or available for dequeuing by the ACMS\$DEQUEUE_TASK service.
- NOHOLD (LOCKED)—The element is locked because it is currently being processed by the QTI, or it is being dequeued by the ACMS\$DEQUEUE_TASK service.
- HOLD—The element is not available for processing by the QTI or for dequeuing by the ACMS\$DEQUEUE_TASK service. If an element in this state is set to NOHOLD using the ACMSQUEMGR, then the element immediately becomes a candidate for subsequent dequeue operations (either by the QTI or by the ACMS\$DEQUEUE_TASK service).
- HOLD (RETRY PENDING)—The element has been processed by the QTI and the called task failed. The QTI retries the task call at a later time depending on the value of the ACMSGEN QTI_RETRY_TIMER parameter. At the appropriate time, the QTI sets the element to NOHOLD, allowing the element to become a candidate for subsequent dequeue operations by either the QTI or the ACMS\$DEQUEUE_TASK service. If an element in this state is set to HOLD using ACMSQUEMGR, then the QTI does not

Creating and Managing Queues

5.4 Managing Queued Task Elements

automatically set the element back to NOHOLD. If an element in this state is set to NOHOLD using the ACMSQUEMGR, then the element immediately becomes a candidate for subsequent dequeue operations.

5.5 Backing Up Task Queue Files Online

ACMS task queue files can be backed up without the QTI process being stopped and without terminating programs that call the ACMS\$QUEUE_TASK and ACMS\$DEQUEUE_TASK services. To perform an online backup of your task queue files:

- Use the ACMS operator command ACMS/STOP QUEUE to stop each queue that needs to be backed up.
- Use the ACMSQUEMGR Utility to suspend dequeues and suspend enqueues for each queue that needs to be backed up. This causes ACMS to close the queue files that are opened in processes calling the ACMS\$QUEUE_TASK and ACMS\$DEQUEUE_TASK services. If the queue file is participating in a transaction at the time ACMSQUEMGR suspends the dequeue or enqueue, the queue file cannot be closed. If the queue file cannot be closed for that reason, another close is retried 10 seconds later. If the queue file is not closed after 10 retries then the file is left open and an error is logged to SWL.
- Back up the queue files that need to be backed up.
- Use the ACMSQUEMGR Utility to resume dequeues and resume enqueues for each queue that was backed up.
- Use the ACMS operator command ACMS/START QUEUE for each queue that was backed up.

For programs that call the ACMS\$QUEUE_TASK and ACMS\$DEQUEUE_TASK services to continue while a backup of a queue file is taking place, the programs must check the return statuses of ACMS\$_QUEDEQSUS and ACMS\$_QUEENQSUS. See *HP ACMS for OpenVMS Writing Applications* for details.

5.6 Summary of ACMSQUEMGR Commands and Qualifiers

QUEMGR commands allow you to create and manage ACMS queues. Table 5–1 lists the ACMSQUEMGR commands and qualifiers and provides a brief description of each command. See Chapter 20 for a complete description of the ACMSQUEMGR commands and qualifiers.

Table 5–1 Summary of ACMSQUEMGR Commands

Commands and Qualifiers	Description
CREATE QUEUE /DEQUEUE=keyword /ENQUEUE=keyword /FILE_SPECIFICATION=file-spec /MAX_WORKSPACES_SIZE=n	Creates a queue for queued task elements.
DELETE ELEMENT /[NO]CONFIRM /EXCLUDE=keyword /SELECT=keyword	Deletes one or more queued task elements.

(continued on next page)

Creating and Managing Queues

5.6 Summary of ACMSQUEMGR Commands and Qualifiers

Table 5–1 (Cont.) Summary of ACMSQUEMGR Commands

Commands and Qualifiers	Description
DELETE QUEUE /[NO]PURGE	Deletes a queue.
EXIT	Exits the ACMSQUEMGR Utility.
HELP /[NO]PROMPT	Provides information about ACMSQUEMGR commands.
MODIFY QUEUE /FILE_SPECIFICATION=file-spec /MAX_WORKSPACES_SIZE=n	Modifies the static characteristics of a queue.
SET ELEMENT /[NO]CONFIRM /EXCLUDE=keyword /PRIORITY=n /SELECT=keyword /STATE=[NO]HOLD	Sets the state and/or priority of one or more queued task elements.
SET QUEUE /DEQUEUE=keyword /ENQUEUE=keyword	Dynamically sets the queue state.
SHOW ELEMENT /BRIEF /EXCLUDE=keyword /FULL /OUTPUT[=file-spec] /SELECT=keyword /TOTAL_ONLY	Displays one or more queued task elements in a queue.
SHOW QUEUE /OUTPUT[=file-spec]	Displays the characteristics of a queue.

Using Distributed Forms Processing

This chapter describes how to set up applications with **distributed forms processing** in a transaction processing (TP) system. (Applications with distributed forms processing are sometimes called distributed applications.)

6.1 What Is Distributed Forms Processing?

An ACMS application consists of forms processing and database processing. In a distributed ACMS TP system, one or more nodes, called the **back end**, handle the database processing and computation, while the forms processing is offloaded onto another node or set of nodes called the **front end**. The front end is sometimes referred to as the **submitter** node or nodes, and the back end is sometimes referred to as the **application** node or nodes.

This distribution of tasks over more than one node in a distributed system improves the speed and reliability of ACMS transactions by allowing the configuration of a distributed system where more powerful machines are dedicated to database processing and smaller machines handle the forms processing. You can configure each node in the distributed system for the processing of specific tasks.

Reliability of a system can be enhanced by installing applications on more than one node of a system and using search lists so that, if a node fails, users are switched to a second node where the same application is running.

Figure 6–1 shows an example of a typical distributed ACMS system.

Figure 6–1 Distributed Forms Processing

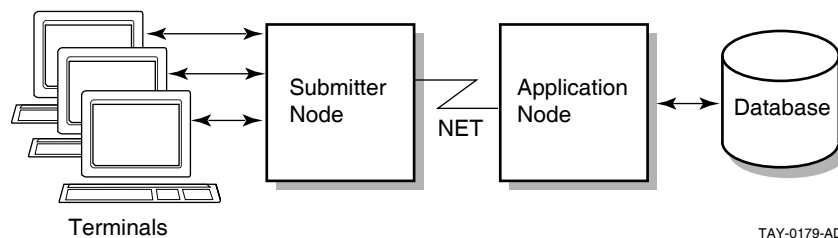

On the front end, or submitter node, terminal users use menus to select tasks for applications running on the application node. The applications, in turn, interact with **resource managers** such as Rdb, DBMS, and RMS. Resource managers are the tools which manipulate your data. A distributed system can be established in an OpenVMS Cluster, a local-area network, or a wide-area network. ACMS uses DECnet to communicate between the front end and the back end of a distributed system.

Using Distributed Forms Processing

6.1 What Is Distributed Forms Processing?

The front-end system is often called the **submitter node** because it refers to a node on which tasks are being selected. The back-end system is often called the **application node** because it refers to the node where the application is executing and where all the actual processing of an application takes place.

Because many applications can run at a single time on one distributed system, it is important that application specifications in menu definitions on the submitter node point to the correct applications on the application node. Section 6.3 describes how you define application specifications for a distributed TP system. The following section describes what you must do to enable your system for distributed forms processing.

6.2 Preparing Your System for Distributed Forms Processing

Once you have designed your distributed system to the extent of deciding which nodes are to be used as the front end and which nodes are to be used as the back end, you can configure each node in your system for distributed forms processing. This section describes actions the system manager takes to enable processing of applications with distributed forms. This includes actions that must be taken in all environments and some actions that are specific to an OpenVMS Cluster environment, submitter nodes, or application nodes.

6.2.1 Common Setup Tasks for Distributed Forms Processing

The following procedures must be performed for both submitter and application nodes to set up your system for processing distributed forms processing:

- You must set the node name parameter in the ACMS parameter file before ACMS makes use of DECnet. The recommended way to set the node name parameter is to edit the ACMVARINI.DAT file in SYS\$MANAGER to include a line that specifies the DECnet node name of the system. For example:

```
.  
. .  
.  
NODE_NAME="MYNODE"  
. .  
.
```

- The node name you specify in the ACMS parameter file must be the same as your DECnet node name. By default, the NODE_NAME parameter is null, and ACMS disables distributed processing. When you assign a node name, ACMS enables distributed processing, provided that DECnet is running.
- Invoke the ACMSPARAM.COM procedure in SYS\$MANAGER to apply the change to the ACMS parameter file.

Note

In an OpenVMS Cluster environment, you must ensure that the ACMS parameter file, ACMSPAR.ACM, is stored in the SYS\$SPECIFIC directory before invoking the ACMSPARAM.COM command procedure. Because each node has a different DECnet node name, each node must have its own node-specific ACMSPAR.ACM file. Check this on each node of the cluster.

Using Distributed Forms Processing

6.2 Preparing Your System for Distributed Forms Processing

- Alternatively, you can run the ACMSGEN Utility directly. Run the ACMSGEN Utility as follows:

```
$ RUN SYS$SYSTEM:ACMSGEN
ACMSGEN> SET NODE_NAME DOVE
ACMSGEN> WRITE CURRENT
```

Note that WRITE CURRENT was used in the preceding example. This ensures that a new ACMSPAR.ACM file is not created where one already exists. It also provides a check that the file exists on each node in an OpenVMS Cluster.

Finally, note that regardless of which method you use to set the node name parameter, you must stop and restart the ACMS system for the change to take effect.

6.2.2 Actions Required on Submitter Nodes

After you have completed the actions listed in Section 6.2.1 detailing common steps that must be taken, the following additional actions are needed to enable distributed processing on a submitter, or front-end, node:

- Ensure that application specifications in menu definitions point to the application, or back-end, node.

Logical names provide a way to ensure that application specifications in menu database files (.MDB files) refer to the correct applications on the application node. See Section 6.3 for information about how to use logical names for application specifications.

- Place HP DECforms escape routines in a protected directory.

A HP DECforms escape routine is an ACMS application program subroutine that is called during the processing of an external HP DECforms exchange request. See Section 6.6 for a description of managing DECforms escape routines.

6.2.3 Actions Required on Application Nodes

Make sure that each step in Section 6.2.1 has been completed. Then, take these additional steps to enable distributed processing by authorizing remote access to ACMS on the application node.

The system manager on an application node can authorize remote task submitter nodes using these methods:

- By assigning individual ACMS proxy accounts to task submitters
- By assigning individual OpenVMS proxy accounts to task submitters
- By assigning a default submitter user name account for those task submitters who do not have individual proxies
- By creating a single wildcard proxy account for all submitters in the case where the submitter and application nodes are in a single OpenVMS Cluster

These methods are described in the following paragraphs.

When ACMS uses a proxy account or a default submitter user name for a remote task submitter, tasks executed by the remote submitter are executed as if they were selected by a local task submitter using the same account. If a proxy or default submitter user name does not exist for a remote task submitter, ACMS rejects the remote task selection.

Using Distributed Forms Processing

6.2 Preparing Your System for Distributed Forms Processing

6.2.3.1 Assigning Individual Proxy Accounts

The ACMS proxy enables system managers to give ACMS users on remote nodes access to ACMS applications on application nodes without granting access to other files and OpenVMS resources on the application node.

Note

For existing ACMS sites, simply adding a new user proxy to the ACMS proxy file does not make a system more secure. You must also remove the user's proxy from the OpenVMS proxy file to deny users on remote nodes access to other files and OpenVMS resources.

6.2.3.1.1 How ACMS Searches for a User's Proxy When a user on a remote node first attempts to select a task on the application node, the following occurs:

1. The ACC on the application node checks that the ACMS proxy file, ACMSPROXY.DAT, exists.
2. If the ACMSPROXY.DAT file exists, the ACC checks the file contents for the proxy of the user on the remote node.
If the remote user's proxy is in the file, the user is authorized to select the task.
If the ACMSPROXY.DAT file does not exist, or if the remote user's proxy is not in the file, the procedure in the next step is followed.
3. The ACC on the application node checks the OpenVMS proxy file, NETPROXY.DAT, for the remote task submitter's proxy.
4. If the proxy file exists and the remote user's proxy is in the NETPROXY.DAT file, the user is authorized to select the task.
5. If the proxy file does not exist or no proxy exists in NETPROXY.DAT, the ACC checks if the USERNAME_DEFAULT parameter is defined in the ACMS parameter file, ACMSPAR.ACM. The USERNAME_DEFAULT parameter defines the default submitter user name account used for remote task submitters that do not have an individual proxy account, or for task submitters from non-ACMS agents.
6. If the parameter is defined in ACMSPAR.ACM, the remote user is authorized to select tasks.
7. If the USERNAME_DEFAULT parameter is not defined and there is no OpenVMS proxy, the ACC rejects the remote user.

6.2.3.1.2 Deciding Which Proxy to Use To decide which type of proxy is appropriate for a user on a remote node, first determine the type of access to the system that the user needs and what level of security is required. Then, decide whether to create an OpenVMS proxy, an ACMS proxy, or both.

Before making changes in the security level of users on remote nodes, consider the needs of the following types of users:

- OpenVMS only user

This user needs to access files and other OpenVMS resources on the application node, but does not need to select ACMS tasks on that node.

Using Distributed Forms Processing

6.2 Preparing Your System for Distributed Forms Processing

- ACMS only user
This user needs to select ACMS tasks on the application node, but does not require access to OpenVMS.
- OpenVMS and ACMS user
This user requires OpenVMS access and also needs to select ACMS tasks on the application node.

Table 6–1 identifies the types of proxies these users require.

Table 6–1 Proxy Choices

	OpenVMS Proxy	ACMS Proxy
OpenVMS Only User	+	
ACMS Only User		+
OpenVMS and ACMS User	+	+

An OpenVMS proxy allows users to select ACMS tasks remotely and users on remote nodes to access other files and OpenVMS resources on the application node.

An ACMS proxy allows users to select ACMS tasks remotely. Unlike an OpenVMS proxy, an ACMS proxy does not grant users on remote nodes access to any other files or OpenVMS resources on the application node, except through an ACMS task.

6.2.3.1.3 Setting Up the ACMS Proxy File Use the ACMS User Definition Utility (UDU) to create and maintain the ACMS proxy file, ACMSPROXY.DAT. This file contains the mapping of <remote-node>::<remote-user> to <local-user>.

You also use UDU to add, remove, and display the proxy specifications in the ACMS proxy file. The UDU interface, including the command syntax and the use of wildcards, is similar to the proxy command interface in the OpenVMS Authorize Utility.

By default, UDU and run-time ACMS look for the ACMS proxy file, ACMSPROXY.DAT, in two different places:

- In the current directory for UDU
- In the file location SYS\$SYSTEM:ACMSPROXY.DAT for run-time ACMS

UDU looks for the default ACMS proxy file ACMSPROXY.DAT in the current directory. You can define the logical name ACMSPROXY to specify another location for the file, define it in any logical name table in your process directory table, and in any access mode.

The SYS\$SYSTEM:ACMSPROXY.DAT file location is the run-time default specification of the proxy file. You can define the system-level executive-mode logical name ACMSPROXY to specify an alternate file location, which the ACMS run-time system uses. For example, issue the following command to create the proxy file FOO.BAR in the SYS\$TEST directory:

```
$ DEFINE/SYSTEM/EXECUTIVE ACMSPROXY SYS$TEST:FOO.BAR
```

If the ACC encounters any problems the first time it opens the ACMS proxy file, an error message is written to the SWL log file.

Using Distributed Forms Processing

6.2 Preparing Your System for Distributed Forms Processing

If you want the proxy file to be in SYS\$SYSTEM and accessible to all nodes in the cluster, you must specify a SYS\$COMMON directory, not SYS\$SPECIFIC. In order for ACMS to search the file for remote proxies, the ACC process must be able to read the ACMS proxy file.

To allow ACC access to the ACMS proxy file, perform one of the following actions:

- Set the ACMS proxy file owner UIC to be the same as the UIC of the ACC or the SYSTEM account.
- Set the ACMS proxy file protection so that the ACC process has read access.

6.2.3.1.4 Creating ACMS Proxies To implement the ACMS proxy, perform the following steps:

1. Create the proxy file and add entries for remote users who need to select tasks in ACMS applications.
2. Create proxies in the OpenVMS proxy file for remote users who additionally require access to other files and OpenVMS resources.
3. Remove proxies in the OpenVMS proxy file for existing users on remote nodes who need only to select tasks in ACMS applications. Add these users to the ACMS proxy instead.

Performing these operations increases security and also ensures that the use of the ACMS proxy mechanism does not cause a degradation in ACMS performance. When ACC needs to search only one proxy file for a proxy, the ACMS performance is the same as in Version 3.2. (However, even when ACMS needs to search both the ACMS and OpenVMS proxy files, there is only slight negative impact on the performance of ACMS.)

The format you choose for creating ACMS proxies has security implications. The following formats are listed from most secure to least secure. The ACC process follows this order when it searches the ACMS proxy file for a match with a remote user proxy. If the ACC finds no match in the search list, it searches the OpenVMS proxy file in the same order for a remote user proxy.

- An exact match of remote-node::remote-user
This is the most secure way to set up ACMS proxies. This format allows only a specified user on a specified node to select tasks on the application node.
- A match of remote-node::*
Use this format to create ACMS proxies in an OpenVMS Cluster environment, where the submitter and application nodes are in the same cluster.
You can also use this format outside an OpenVMS Cluster environment, but you need to understand its security implications; this format allows any user on the submitter node to select tasks on the application node.
- A match of *::remote-user
This format allows a user with a specified user name on any node in the network to select tasks on the application node.
- A match of *::*
This is the least secure format; it allows any user on any node to select tasks on the application node.

Using Distributed Forms Processing

6.2 Preparing Your System for Distributed Forms Processing

The application node ACC checks for a remote task submitter's proxy. In addition, the application node ACC requests that the submitter node ACC validate the task submitter based on a security token and submitter ID that the submitter node ACC assigned to the user. When the task submitter first enters ACMS, the submitter node ACC verifies the following items to make sure that the user is authorized:

- Submitter terminal is in ACMSDDF.DAT
- Submitter user name is in SYSUAF.DAT
- Submitter user name is in ACMSUDF.DAT

6.2.3.1.5 Creating OpenVMS Proxies The OpenVMS proxy file can have more than one <local-user> for each <remote-node>::<remote-user> combination. The ACMS proxy file, on the other hand, can have only one <local-user> for each <remote-node>::<remote-user> combination. Therefore, for an OpenVMS proxy, you must specify a default <local-user>. This allows ACMS, when it searches the OpenVMS proxy file, to find one <local-user> to associate with <remote-node>::<remote-user> for the remote user proxy.

For example, to allow user JONES on the submitter node COWBOY to select tasks under the user name PERS, create an OpenVMS proxy account as follows:

```
UAF> CREATE/PROXY COWBOY::JONES PERS/DEFAULT
```

When starting DECnet, to allow remote users access to files and other OpenVMS resources, issue the NCP command SET KNOWN PROXIES ALL. If you do not execute this command on a node, remote users do not have access to files and other OpenVMS resources. However, ACMS opens and reads the OpenVMS proxy file and the ACMS proxy file whether or not you enable OpenVMS proxy access to files and OpenVMS resources with NCP.

6.2.3.2 Assigning a Default Submitter User Name Account

The recommended way to set the default submitter user name is by editing the ACMVARINI.DAT file in SYS\$MANAGER. Include a line that specifies the default submitter user name.

```
.  
. .  
. .  
USERNAME_DEFAULT = "ACMS_USER"  
. .  
. .  
. .
```

Invoke the ACMSPARAM.COM procedure in SYS\$MANAGER to apply the change to the ACMS parameter file. Note that in an OpenVMS Cluster environment, you must ensure that the ACMS parameter file, ACMSPAR.ACM, is stored in the SYS\$SPECIFIC:[SYSEXE] directory before invoking the ACMSPARAM.COM command procedure. The value you assign to the USERNAME_DEFAULT parameter is used as the submitter user name if ACMS cannot find a specific proxy user name for a remote submitter.

You can also define a default submitter user name using the ACMMSGEN Utility. For example:

```
$ RUN SYS$SYSTEM:ACMSGEN  
ACMSGEN> SET USERNAME_DEFAULT ACMS_USER  
ACMSGEN> WRITE CURRENT
```

Using Distributed Forms Processing

6.2 Preparing Your System for Distributed Forms Processing

The SET command defines ACMS_USER as the new default submitter user name, which the WRITE CURRENT command uses to update the current setting. The user name you set as the USERNAME_DEFAULT must be authorized by the OpenVMS Authorize Utility, and must exist in the ACMS User Definition File.

6.2.3.3 Assigning Proxy Accounts in an OpenVMS Cluster Environment

In an OpenVMS Cluster environment, where the submitter and application nodes are in the same cluster, you can create a wildcard proxy account for all users on a submitter node.

For example, to allow all users on the submitter node, COWBOY, to select tasks on an application node, you create a proxy account for users with the OpenVMS Authorize Utility:

```
UAF> CREATE/PROXY COWBOY::* */DEFAULT
```

Note that this technique can also be used outside an OpenVMS Cluster environment, but the security implications should be well understood. Specifically, the system manager on the application node must understand that this method allows any user on the submitter node access to the application node.

6.2.4 File Protection for Application and Form Files

You must also ensure that application and form files have the correct file protection assigned.

When a terminal user on the submitter node selects a task in an application on the application node, ACMS automatically copies the application database and forms files used by the application from the application node to the submitter node. For ACMS to automatically distribute these files, they must be accessible by the ACMS Central Controller (ACC) and the CP on the submitter node, or remote task selections fail. You can ensure that these files are accessible on the application node by giving them WORLD:RE protection. See Section 6.4 for more information about how ACMS performs this automatic distribution.

Alternatively, if you do not wish to change the protection of the application databases and form files to WORLD:RE, you can create proxy accounts on the application node for the ACC and CP user names on the submitter node. The following example shows how to allow the ACC and CP processes on the submitter node, COWBOY, to access their respective files on an application node. The example assumes that on both the submitter and the application nodes, the ACC and CP processes run under the ACMS\$ACC and ACMS\$CP user names.

```
UAF> ADD/PROXY COWBOY::ACMS$ACC ACMS$ACC/DEFAULT
UAF> ADD/PROXY COWBOY::ACMS$CP ACMS$CP/DEFAULT
```

Note

If a proxy account is created on the application node for the ACC or CP processes on the submitter node, ensure that the account on the application node is authorized for network access and that it is not defined with the /DISUSER qualifier. Failure to do this prevents a cache operation from taking place and causes the task selection to fail.

ACMS uses the DECnet-VAX File Access Listener (FAL) object to copy from one node to another. FAL is a HP-supplied object that is defined by default in the DECnet-VAX configuration database. This FAL object must exist and be enabled for ACMS to distribute needed files from one node to another.

Using Distributed Forms Processing

6.2 Preparing Your System for Distributed Forms Processing

To confirm that the FAL object is present, you can use the Network Control Program (NCP) SHOW command. First use RUN SYS\$SYSTEM:NCP to obtain the NCP> prompt. At the NCP> prompt, type SHOW and at the following prompts type OBJECT and FAL, as shown in the following example:

```
$ RUN SYS$SYSTEM:NCP
NCP> SHOW
(ACTIVE, ADJACENT, AREA, CIRCUIT, EXECUTOR,
KNOWN, LINE, LOGGING, LOOP, MODULE, NODE, OBJECT):OBJECT
Object name (8 characters): FAL

Object Volatile Summary as of 21-JUL-1989 14:57:57

   Object   Number  File/PID           User Id           Password
   -----  -
   FAL      17    FAL.EXE
NCP> EXIT
$
```

You must also ensure that files needed for DECforms escape routines have the correct file protection assigned.

Place HP DECforms escape routines in a restricted directory because they contain user-written code that runs in a privileged process. HP DECforms escape routines are not distributed automatically by ACMS. Hence, the system manager on the submitter node needs to copy these files manually from the application node. Consequently, make sure the files are accessible to the submitter node. See Section 6.6 for a description of managing HP DECforms escape routines.

6.3 Defining Application Specifications

In a distributed TP system, it is important that the application specifications in menu definitions point to the node on which the application is running.

You can "hardcode" an application file name and node name in the menu definition, or use a logical name to reference the application. Logical names allow you to change the application to which a menu definition or definitions refers by simply redefining a logical name. This avoids the need to redefine and rebuild a menu definition. If an application is installed on more than one node in the system, you can define a logical name to translate to a search list specifying all locations for the application. The following sections describe how to define logical names and search lists.

6.3.1 Using Logical Names for Applications

If task submitters on the submitter node access several applications that are always stored together on another node, define a logical name for that node. For example, if the applications ACCOUNTING, PERSONNEL, and BUDGET are all installed on node DOVE, place the following logical name assignment in the system startup file:

```
$ DEFINE/SYSTEM APPL_NODE DOVE::
```

The menu definitions can refer to APPL_NODE::ACCOUNTING, APPL_NODE::PERSONNEL, and APPL_NODE::BUDGET. Then, if you need to move these applications to another node, you can simply redefine APPL_NODE to be the new node name without changing the menu definitions.

Using Distributed Forms Processing

6.3 Defining Application Specifications

Example 6–1 shows how a menu definition refers to the node DOVE after it has been defined with the logical name APPL_NODE as explained in the previous paragraphs.

Example 6–1 Using a Logical Name for a Node

```
ENTRIES ARE:
.
.
.
NEW_EMPLOYEE: TASK IS NEW_EMPL_TASK IN "APPL_NODE::PERSONNEL";
.
.
.
END ENTRIES;
```

If you want control of specific applications rather than groups of applications, define a logical name for that application. For example, if the application PAYROLL is installed on node DOVE, place this command in the system startup file:

```
$ DEFINE/SYSTEM PAYROLL DOVE::PAYROLL
```

The menu definition simply refers to PAYROLL, as in Example 6–2.

Example 6–2 Using a Logical Name for an Application

```
ENTRIES ARE:
.
.
.
NEW_EMPLOYEE: TASK IS NEW_EMPL_TASK IN "PAYROLL";
.
.
.
END ENTRIES;
```

When an ACC on a submitter node asks an application node for an application, the ACC process on the application node attempts to translate the application name locally. If a logical name does exist for the application name, then the translation is used to access the application on the application node.

Any name changes that occur on the application node do not affect the submitter's file name. For example, if a logical name on submitter node ARK exists which defines PAYROLL as DOVE::PAYROLL, node ARK asks application node DOVE for application PAYROLL. On node DOVE, ACMS tries to translate the PAYROLL logical again. If the logical translates to NEW_PAYROLL, for instance, the NEW_PAYROLL application is accessed on node DOVE. When files relating to that application are copied to node ARK, they are stored as PAYROLL.

The copying of application database (.ADB) and form files from a remote node to the local node where users are selecting tasks is referred to as **caching**. This is done to increase system performance, by avoiding the need for network access to the application node for application database and form files. A fuller explanation of this process is found in Section 6.4.

Using Distributed Forms Processing

6.3 Defining Application Specifications

If an application specification or a translation of a logical application specification does not contain a node name, ACMS looks for the application on the submitter's node. If you do use node names, they cannot contain access control strings. For example, ALPHA"ADAMS JOHNQUINCY"::PAYROLL is not a valid application specification because it includes the access control string, "ADAMS JOHNQUINCY".

ACMS follows OpenVMS conventions when translating logical names. For information about how OpenVMS translates logical names and how it translates logical names interactively, refer to *OpenVMS DCL Dictionary*. See *HP ACMS for OpenVMS ADU Reference Manual* for more information about ACMS application specifications.

6.3.2 Search Lists and Primitive Failover

If an application moves between nodes, or you want to provide a backup node for an application in the event that a node fails, use search lists. Search lists are used to specify all locations for an application. For example, if the application PAYROLL is installed on node DOVE *and* on node RAVEN, define the logical name PAYROLL to be the following search list:

```
$ DEFINE/SYSTEM PAYROLL DOVE::PAYROLL,RAVEN::PAYROLL
```

The menu definition then specifies PAYROLL as the application name. ACMS searches for the application on each node listed until it locates an available application, or until it reaches the end of the search list. You can define a search list for an application name, a node name, or both.

For example, if the applications ACCOUNTING, PERSONNEL, and BUDGET are all installed on nodes DOVE, ARK, and BRANCH, you can define the logical name APPL_NODE to be the following search list:

```
$ DEFINE/SYSTEM APPL_NODE DOVE::, ARK::, BRANCH::
```

Menu definitions then specify APPL_NODE::ACCOUNTING. When APPL_NODE::ACCOUNTING is translated, the first available application in the search list is used. Therefore, DOVE::ACCOUNTING is used if it is available. If it is not available, ACMS continues to process the search list from left to right until an available application is located.

Search lists provide a primitive form of failover. When an application goes down, an application node goes down, or the link between the submitter node and the application node is severed for some reason, ACMS cancels all active tasks on the submitter node. When a user attempts to select another task in the same application, ACMS reprocesses the search list for an available application.

Once an available node or application is found, all subsequent task selections are redirected to the available application, and terminal users are once again able to select tasks. No group or user workspace context in the failed application is saved. Users receive an error message when this type of failover situation occurs.

If you want to stop an application and cause users to select tasks in an application executing on another node, you can force failover to another application by using the ACMS/REPROCESS APPLICATION command. This command is described in the next section.

Using Distributed Forms Processing

6.3 Defining Application Specifications

6.3.3 Redirecting Users to Other Applications at Run Time

ACMS translates logical names for applications only when a task is first selected in an application. Once ACMS on a submitter node locates an application node, all task selections from the submitter node go to that application node until that application is either stopped or the link between the submitter node and the application node is broken.

However, you can cause ACMS to direct task selections to another application in a search list (or return users to an application that previously failed), by using the ACMS/REPROCESS APPLICATION command. The ACMS/REPROCESS APPLICATION command causes ACMS to retranslate the search list for a logical name. For example:

```
$ ACMS/REPROCESS APPLICATION PAYROLL
Reprocess Specification for Application PAYROLL (Y/[N]):
```

This command causes ACMS to retranslate the logical name PAYROLL the next time a task submitter selects a task in the application.

The ACMS/REPROCESS APPLICATION command is especially useful for system managers who need to install an updated version of an application, but do not want to cause application downtime during this procedure. Simply redirect user task selections to an application executing on another node by using the ACMS/REPROCESS APPLICATION command; install the updated version; and then issue another ACMS/REPROCESS APPLICATION command to redirect user task selections back to the original node, which is now executing the updated application.

The ACMS/REPROCESS APPLICATION command can also be used to switch between versions of an application where the submitters and the application are running on the same system, as illustrated in the following example.

A site has two copies of an application, PAYROLL_A and PAYROLL_B, with the logical name PAYROLL defined as PAYROLL_A, PAYROLL_B. Note that no node names are used. The assumption is that the system is running and the system manager wants to make a new version of the payroll application available without interrupting the company's flow of work.

The system manager copies the new application database file (the .ADB file) to ACMS\$DIRECTORY and calls it PAYROLL_B. The order of the PAYROLL logical is then redefined to PAYROLL_B, PAYROLL_A. The ACMS/REPROCESS APPLICATION PAYROLL command is then issued, causing all subsequent task selections to go to the new PAYROLL_B application. When there are no more submitters using PAYROLL_A, that application can be stopped. To switch users back to PAYROLL_A after it has been updated, the logical names are reversed, and the process is repeated.

In a distributed ACMS environment, the process goes as follows: If PAYROLL is defined as the search list: DOVE::PAYROLL, ARK::PAYROLL, RAVEN::PAYROLL, and you want to install an updated version of the PAYROLL application on node DOVE (the application currently being used), redefine the search list to point to ARK::PAYROLL, RAVEN::PAYROLL and execute the ACMS/REPROCESS APPLICATION command. Terminal users make new task selections in ARK::PAYROLL. After you install the updated application on node DOVE, redefine the search list to point to DOVE::PAYROLL, ARK::PAYROLL, RAVEN::PAYROLL and issue another ACMS/REPROCESS APPLICATION command. Users make new task selections in the updated application.

The ACMS/REPROCESS APPLICATION command can also be used to cause submitters to “failover” to an application that previously failed but has now been made available. For example, if PAYROLL is defined as the search list: DOVE::PAYROLL, ARK::PAYROLL, RAVEN::PAYROLL, and node DOVE goes down, ACMS automatically retranslates the search list for PAYROLL, and terminal users make new task selections in ARK::PAYROLL. When node DOVE again becomes available, issue the ACMS/REPROCESS APPLICATION command to redirect subsequent user task selections back to the DOVE::PAYROLL application.

6.4 Distributed Operations ACMS Performs Automatically

When an ACMS/START APPLICATION command is issued, the application execution controller (EXC) checks that all form files referenced by task groups in the application definition exist. The EXC uses the default directory and logical names to locate the form files.

Once all the form files are found, EXC stores the full file specification for each form file. When EXC makes a DECforms I/O request to the agent process, it passes the full file specification to the agent process.

In ACMS, all HP DECforms requests run in the agent process, whether the task is submitted locally or remotely. Therefore, the agent process must have access to the form files. If a task is selected from a remote agent, the form files must be distributed to the remote node.

All form files used by an application must be on the application node, because the application execution controller (EXC) checks that all files are present when the application starts. The form files must also be accessible to the submitter node, because code running in the task submitting agent on the submitter node issues the calls to DECforms requests. Escape routine files, however, are *not* checked when the application starts.

Note

ACMS uses the translation of the SYS\$NODE system logical name from an application node to form the directory specification when caching DECforms form files and TDMS request library files. DECnet defines the logical name when it is started. Do not change the definition of this system-defined logical name. If this logical name is changed, then the ACMS caching routines do not function correctly and place files in directories with incorrect names. If this happens, ACMS cannot open the necessary form or request library files and, as a result, cancels tasks.

6.4.1 Automatic File Distribution

When a user selects a task in an application, the ACMS run-time system checks to see if the application and form files are accessible on shared disks available to both the submitter and the application nodes. If the files are not located on shared disks and are not already resident on the submitter node, ACMS automatically copies the application and forms files used by the application from the application node to the submitter node. ACMS does not automatically distribute DECforms escape routines. You must distribute these files manually. See Section 6.5.1 and Section 6.6 for information on how to manually copy DECforms escape routines and where to store them.

Using Distributed Forms Processing

6.4 Distributed Operations ACMS Performs Automatically

These copies are made automatically by ACMS to increase the performance of the system by avoiding having to access these form and application files over a network.

For ACMS to perform this automatic distribution of application and form files, the ACC and the CP must have access to these files. On the application node, you can use proxies for the remote ACC and CP in combination to allow access to these files by the ACC and CP on the submitter node. Alternatively, assigning the files WORLD:RE protection ensures that these files are accessible.

Using proxies allows a submitter node ACC or CP to access the files on the application node as if they were being accessed by the application node's ACC or CP. In this case, the files do not need WORLD:RE access. However, if proxies are not used, the submitter node's ACC and CP are accessing the files as if they were nonprivileged users on the application node, which is why the files must have WORLD:RE protection. If this no-proxy method is used, the application node must have set up a default DECnet account which does not have privileges, but does allow remote nodes to access files which have WORLD:RE protection on the local node. For ACMS caching to work without the use of proxies, this DECnet default account must exist.

6.4.2 ACMS Systemwide Cache Directory

When ACMS automatically distributes files to the submitter node, it places the files in a special directory hierarchy created by ACMS specially for this purpose. This directory structure is known as the ACMS systemwide cache directory. By default, on the submitter node, ACMS creates this systemwide cache directory structure by using the translated directory specification of ACMS\$DIRECTORY with ACMS\$CACHE appended as a rooted directory. For example, if ACMS\$DIRECTORY translates to DRA1:[ACMSDIR], then the systemwide cache directory on submitter node DOVE is DOVE::DRA1:[ACMSDIR.ACMS\$CACHE].

To create and reference files in the systemwide cache directory hierarchy, ACMS uses three logical names:

- ACMS\$ADB_CACHE
- ACMS\$RLB_CACHE
- ACMS\$FORMS_CACHE

ACMS defines these logical names as rooted directories. For example, consider a system where the ACMS\$DIRECTORY logical is defined to be SYS\$SYSDEVICE:[ACMSDIR]. If the physical system disk device name is \$1\$DUA0:, then ACMS defines ACMS\$ADB_CACHE as \$1\$DUA0:[ACMSDIR.ACMS\$CACHE.]. Note that a physical device name must be used when defining a rooted directory logical name.

ACMS creates subdirectories (on the submitter node) for each node to which it copies application databases. Each node needs its own subdirectory in case two nodes have different applications with the same name. ACMS does not create subdirectories if the databases are accessed remotely. The location of these subdirectories is controlled by cache logicals, described in the preceding paragraphs. These subdirectories are used to store the .ADB and form files for applications access on that remote node.

Using Distributed Forms Processing

6.4 Distributed Operations ACMS Performs Automatically

For example, assume that the following nodes are running these applications:

- **NODE COMET**

```
Application AVERTZ      using DRA1:[TWEETY]INVENTORY.FORM
                        and   DRA1:[TWEETY]INVENTORY.EXE

Application PAYROLL     using DRA1:[HECKLE]PAYROLL.RLB
                        and   DRA1:[HECKLE]GENERAL.RLB
                        and   DRA1:[HECKLE]PAYROLL_REQ.RLB

Application STOCK       using DRA1:[JECKLE]GENERAL.RLB
                        and   DRA1:[JECKLE]STOCK.RLB
```

- **NODE STAR**

```
Application PAYROLL     using DRA1:[TWEETY]PAYROLL.RLB

Application AVERTZ      using DRA1:[TWEETY]GENERAL.FORM
                        and   DRA1:[TWEETY]GENERAL.EXE
```

Once a terminal user on submitter node COMET has selected tasks in each of these applications, the `ACMS$CACHE` directory on node COMET contains the subdirectories for the applications on each remote node.

Referred to under node COMET is `PAYROLL.ADB`, `PAYROLL.DIR`, `STOCK.ADB`, and `STOCK.DIR`. Referred to under node STAR is `PAYROLL.ADB` and `PAYROLL.DIR`. In this way, the ACMS system can discriminate among applications with the same name running on different nodes.

Also note that each subdirectory contains an `.ADB` and a `.DIR` for each application. Each `.DIR` contains the application's request libraries (`.RLB`) and/or forms files (`.FORM` and `.EXE`).

In most cases, the file name and type of the request libraries and forms files are the same as the file name and type on the remote node. If a remote application uses two different files with the same file name and type, but the files reside in a different disk or a different directory, the file type is modified to include the index of the task group within the application and of the request libraries and/or forms files of the task group.

This information can be obtained from the `ADU DUMP APPLICATION` and `DUMP GROUP` commands. The file type is modified to be `.file-type_g_r`, where `file-type` is the original file type, "g" is the index of the task group (leading zeros suppressed) as recorded in the `.ADB` and "r" is the index of the request library of forms file (leading zeros suppressed) as recorded in the `.TDB`.

Given that there are two file specifications with the same file name and type, the second file by alphabetical order of the full file specification will have the file type modified. For example, you have this definition in the task group:

```
FORMS ARE
  form_a IN "DISK1$:[USER1]FORM_X.FORM" WITH NAME F1,
  form_b IN "DISK2$:[USER2]FORM_X.FORM" WITH NAME F2;
```

The first file will retain the file name and type. The second file will have `FORM_X.FORM_1_2` as the file type. The same rule applies to request libraries (`.RLB`) and forms image files (`.EXE`). However, you should not use the same file name for forms image files (`.EXE`) because of the restrictions of the OpenVMS image activator. For details about forms image files, see *HP ACMS for OpenVMS Writing Applications*.

Using Distributed Forms Processing

6.4 Distributed Operations ACMS Performs Automatically

When files are updated on the application node, ACMS automatically copies the new version of each file to the submitter node and deletes the old version the next time a user on a submitter node selects a task in an application containing updated files.

Note that ACMS does *not* make the copy at the time the change is made on the application node. The copy is made only when a user on the submitter node selects a task in the updated application. When updating application and form files, ACMS maintains a single copy of each file. It deletes old versions as soon as it makes an updated copy. Once the files are updated, the copies remain on each node until they are superseded by new versions or until they are explicitly deleted.

When a terminal user selects a task, ACMS processes the search list in an application specification from the first specification on the left to subsequent specifications, using the following sequence of actions:

- The Command Process (CP) sends a message to the ACMS Central Controller (ACC) to get information about the application.
- The ACC looks at the application specification and attempts to translate it as a logical name.
- The ACC then finds out if the application is running on the first, and possibly only, node named in the application specification. If it is, ACC uses that application.
- If the node is not reachable, or the application is not running, ACC looks at the next node in the application specification. If there are no more entries in the search list, or the logical name is not a search list, or the application specification contains a single hard-coded node name, then the task selection fails.
- If a usable application is found, however, ACMS then looks for an application database file (.ADB file) in the following manner:
 - First, ACMS translates the ACMS\$ADB_CACHE logical and looks in the first directory specified in the search list (assuming that the logical translates to a search list).
 - If an up-to-date version of the .ADB is found, the task then executes.
 - If the .ADB is out-of-date, ACMS tries to update it. If this is impossible, perhaps because the directory is write-protected, then ACMS proceeds to the next translation of the ACMS\$ADB_CACHE logical name.
 - If, in the process described in the preceding paragraphs, a translation is found that equals “NET”, then ACMS uses DECnet to access the .ADB file.
 - If ACMS reaches the end of the search list and has not found a directory that contains the .ADB file, or found an obsolete file and could not update it, then ACMS starts at the beginning of the search list and tries to copy the .ADB file into each directory on the list.
 - As soon as ACMS finds a directory to which it can copy the .ADB file, it does so, and the task then executes.
 - However, if the end of the search list is reached and ACMS finds that all the directories are write-protected, or perhaps the disk is full or there is no disk quota left, then the task selection fails.

Using Distributed Forms Processing

6.4 Distributed Operations ACMS Performs Automatically

Note that during the preceding sequence of events, ACMS does not attempt to look for another application using the application specification, because a running application has already been found and it is the cache problem that has caused the task cancellation.

Periodically, you may want to delete little-used files in the system cache directory. This could involve rarely used applications or nodes. This ensures that databases and forms that are infrequently used do not consume disk space. However, deleting files in the cache directory can cause slow response time for the first task selected in a remote application while ACMS copies the application and forms files to the submitter node.

On nodes with large disks, you can allow ACMS to automatically distribute all application database and forms files for all applications accessed by terminal users. On nodes with limited disk space, you may want to manually copy the forms and application files most frequently used and use access over the network for other, less frequently used, applications.

However, remember that performance may be affected when one of these less frequently used applications is selected, due to the need for network access to the form and application database files. The following section describes how to determine whether the manual distribution of application and forms files is advantageous for your particular site.

6.5 Tailoring ACMS Distributed Forms Processing to Your Site

You may be a system manager on a submitter node that has limited disk space, and want to avoid allocating the space needed for the automatic distribution of application and forms files. If this is the case, you can perform the following operations:

- Manually copy the application and forms files for the applications you use most often to the cache directory on the submitter node.
- Cause ACMS to search a local cache directory before it searches the systemwide cache directory by redefining cache logical names.
- Allow remote access to application files that are infrequently used.

These methods are described in the following sections.

6.5.1 Manually Distributing Applications

To copy application and forms files when manually populating the system cache directory on a submitter node, you must know the remote file specifications of the application and forms files, and the application names that the files belong to. Assuming you have the needed file specifications and application names, you then take the following steps:

- Copy .ADB files to `ACMS$ADB_CACHE:[node]*`
You must use a wildcard file name to preserve the creation date. If the local application name is different from the remote name, you must rename the file.
- Copy TDMS .RLB files to `ACMS$RLB_CACHE:[node.application]*`
You must use a wildcard file name to preserve the creation date. If the local application name is different from the remote name, you must rename the file. If an index must be attached to the file type, use the `RENAME` command.

Using Distributed Forms Processing

6.5 Tailoring ACMS Distributed Forms Processing to Your Site

- Copy DECforms .FORM and .EXE files to ACMS\$FORMS_CACHE:[node.application]*

You must use a wildcard file name to preserve the creation date. If the local application name is different from the remote name, you must rename the file. If an index must be attached to the file type, use the RENAME command. ACMS does not perform automatic installation of image form files. If you want to make shared image format a known shareable image, you must issue the INSTALL command manually.

You must also manually distribute escape routine files that are not part of a shareable image. An escape routine can do anything that is allowed in the environment in which it runs; it can, for example, call routines in shared images, use logicals, and use global sections. Because it has no way of knowing what parts of the environment must be duplicated on a remote node, ACMS cannot automatically distribute escape routine files. See Section 6.6 for a description of managing DECforms escape routines.

ACMS carefully preserves the original creation date and time on the local copy when it distributes files. You are responsible for this information if you manually distribute application and forms files. If you copy the files over the network using the OpenVMS COPY command, and specify the wildcard output file name and type, the COPY operation maintains the original creation date and time of the file.

If the destination application or forms file names differ from the source file names, you must still use the wildcard output file name and type when you copy the files. You can then use the OpenVMS RENAME command to add the necessary index to the file type of these files or to use the fully translated local application name as the file name of .ADB files. The RENAME command maintains the original creation date and time.

Destination application and forms file names can be different from the source names when an application uses two or more different application or forms files with the same file name and type, or when the local application name differs from the remote application name. If an application node has an application that uses two different forms files with the same file name and file type, there must be some way to distinguish them. This is done by modifying the file type.

For example, if application PAYROLL has two different files both called GENERAL.FORM, the file type is modified to include the index of the task group within the application and the index of the .FORM within the task group. The file index is obtained from the ADU DUMP APPLICATION and DUMP GROUP commands.

For example, the file type is modified to be .FORM_g_r, where *g* is the index of the task group (leading zeros suppressed) as recorded in the .ADB, and *r* is the index of the form file (leading zeros suppressed) as recorded in the .TDB. This method of indexing file types is the same for both DECforms and TDMS forms files.

ACMS automatically updates distributed files whenever they become outdated, however, you can prevent ACMS from automatically updating files by write-protecting the directories in which the files reside. ACMS does not update DECforms escape routines or their resources.

6.5.2 Creating Agent-Specific Cache Directories

An agent must have write access to the cache directory to update it. However, you usually do not want nonprivileged agents to update the cache directory. ACMS defines a nonprivileged agent as one that is not authorized as an agent with the User Definition Utility (UDU), and therefore cannot submit tasks for other users. Examples of nonprivileged agents are:

- ALL-IN-1
- Customer-written agents running the debugger
- Customer-written agents being executed directly by terminal users

An agent image can be installed with privileges; however, do not assign privileges to an agent haphazardly, since an agent process executes under the terminal user's OpenVMS user name. Theoretically, the user whose name the agent process is running under could cause problems by adding an incorrect file to the system cache, thereby denying service to another user. For example, if you made ALL-IN-1 a privileged agent, ALL-IN-1 users would then be able to access the system cache directory with ALL-IN-1 commands. This could corrupt the system cache directory and its files, or cause other unexpected results.

You can avoid giving nonprivileged agents access to the system cache by creating an agent-specific cache directory. The agent-specific cache directory could be shared between agents (for example, all ALL-IN-1 users), or could be separate for each agent (for example, customer-written agents running the debugger).

Create the agent-specific cache directory in SYS\$DISK. Then, define the logical name ACMS\$RLB_CACHE or ACMS\$FORMS_CACHE to point to either the agent-specific cache directory or a search list of directories.

The logical name can point to a local, agent-specific cache, and then to a central cache to which the agent does not have write access. For example:

```
$ DEFINE/EXEC ACMS$FORMS_CACHE -  
_$_$ DRB2: [ALLIN1_CACHE.], DRA1: [ACMSDIR.ACMS$CACHE.]
```

Here, ACMS searches the private cache [ALLIN1_CACHE] for the DECforms file. If ACMS does not find the file there, it searches the public cache [ACMSDIR.ACMS\$CACHE.]. If ACMS still does not locate the file, it creates a new version in the local cache.

The logical name ACMS\$ADB_CACHE, which is normally a system logical name, must be available to the ACC. The ACMS\$RLB_CACHE and ACMS\$FORMS_CACHE logical names, however, can be defined as system, group, job, or user logical names, provided the logical name can be translated by the agent. They are usually defined as system logical names.

The ACMS remote request code in the agent process can only allow an agent to update a cache to which it has write access. If ACMS finds an out-of-date file in the central cache, it updates the file in the agent-specific cache.

If you are supporting multiple caches by using search lists, control where application and forms files are placed the first time they are copied from the application node. This is controlled through the use of a write-protected directory in the search list.

Using Distributed Forms Processing

6.5 Tailoring ACMS Distributed Forms Processing to Your Site

6.5.3 Accessing Remote Application Files

You can allow remote access for infrequently used application and forms files by adding the characters “NET:” to the end of your search list. For example, if you want to allow remote access to all DECforms files that are not found locally in DRA1:[ACMSDIR.ACMS\$CACHE.], you define the ACMS\$FORMS_CACHE logical as follows:

```
$ DEFINE ACMS$FORMS_CACHE DRA1:[ACMSDIR.ACMS$CACHE.],NET:
```

The “NET:” designation tells the ACMS run-time system that if the application or forms file is not found in the local ACMS\$CACHE directory, it must open the application or forms file using remote DECnet file access. This requires that there be a process on the application node for each agent for each application and forms file. ACMS reads the .ADB files once and then keeps them in memory. See Section 6.4 for information on how ACMS updates remote application and forms files.

6.6 Managing and Caching HP DECforms Escape Routine Files

With HP DECforms, application program subroutines can be called during the processing of an external request. These subroutines, called escape routines, are executed in the context of the agent process. Because of this, application and system managers must consider the following:

- Making escape routines available to the CP agent
- Protecting privileged agents that execute escape routines
- Caching escape routines in a distributed environment

Caution

Many agents, including the ACMS-supplied CP agent, perform work on behalf of multiple users. These agents are *multithreaded* or *asynchronous*. However, HP DECforms escape routines provide only a **synchronous** interface. When you use an escape routine in a multithreaded agent, be careful not to do anything that might delay the CP agent in processing other users' requests. For example, do not use an escape routine to perform terminal or disk I/O, because this stalls other users.

6.6.1 Making Escape Routines Available to the CP Agent

The two methods for making escape routines available to the CP agent are: link them with the form image, or link them in a separate image. There are advantages and disadvantages to each method, as follows:

- Linking escape routines with the form image
You can make escape routines available to the CP agent by linking them into the same image as the form. An advantage to this method in a distributed processing environment is that the escape routines are automatically cached, with the forms files, to the remote submitter node.
By using this method, however, you allow application code from a remote system to execute in a privileged environment on your system. But if the remote application node and the local submitter node are in a common security domain, this may not be a concern.

Using Distributed Forms Processing

6.6 Managing and Caching HP DECforms Escape Routine Files

To avoid the possible security problem of executing escape routines that are linked with the forms shareable image, ACMS, by default, does not execute these escape routines. To execute them, you must define the following system-level logical:

```
ACMS$ESC_RTN_IN_FORM
```

If the value of this logical is set to “T”, “t”, “Y”, “y”, or “I”, then ACMS allows these escape routines to run. If this logical is not defined or has another value, ACMS does not execute the escape routines.

- Linking escape routines in a separate image

You can also link escape routines in their own shareable image. You then need to make that image available to the CP agent by defining this logical:

```
FORMS$IMAGE
```

If you have more than one escape routine image, you can make the logical a search list of all images. For the ACMS-supplied CP agent, this logical must be in either the system group name table or the system name table. (Refer to HP DECforms documentation for more information about defining this logical.)

If you use the FORMS\$IMAGE logical to specify escape routine images, these escape routines can be shared by all of the applications that the CP agent references. However, sometimes the different applications may have the same escape routine name for different functions. To settle this possible naming conflict, ACMS provides an additional logical:

```
ACMS$ESC_RTN_<node>_<application>
```

You can use this logical to define an escape routine image for a particular application on a particular node. If the application uses more than one image, this logical can be a search list. When you use this logical name on a system where the NODE_NAME parameter is not defined in ACMSGEN, you must omit the <node> part from the logical name. Therefore, the logical name looks like:

```
ACMS$ESC_RTN_<application>
```

If you do not define this logical, or the specified logical is not on the search list, HP DECforms then uses the FORMS\$IMAGE logical.

6.6.2 Privileged Agents that Execute Escape Routines

Certain agents, such as the ACMS-supplied CP agent, run in a privileged environment. Any escape routines that execute in a privileged agent also execute in the same privileged environment. Be sure to develop escape routines to execute in a privileged agent in the same way as you develop any other privileged code. Carefully review the code for any possible security violations before you run it live on the system.

Place the escape routine images in a write-protected directory; also write-protect the images themselves. After you place the file in a protected directory, you can define the logicals that make the escape routines available to the agent process.

Using Distributed Forms Processing

6.6 Managing and Caching HP DECforms Escape Routine Files

You may not, however, need to place escape routines executed by a nonprivileged agent in a protected directory. In some cases, such as debugging, you may want the person running the CP agent to be able to change the escape routines executed. Use the methods described previously to make the escape routine images available to the CP agent.

Using Data Compression

This chapter describes the data compression feature that can improve system response time and reduce the cost of transmitting data across networks.

For information on designing ACMS applications, refer to *HP ACMS for OpenVMS Concepts and Design Guidelines*.

7.1 Overview of Data Compression

This section provides an overview of data compression, by describing the purpose of data compression and how this feature works.

7.1.1 Purpose of Data Compression

In wide area networks, data must often be transmitted over relatively slow links. Also, many public networks charge for each packet of data transmitted over the network. In these situations, compressing the data before sending it over the link can accomplish one or both of the following:

- Provide a faster response time for the user

Providing high-speed links is often far too costly in an application with a widely distributed user base and relatively few users at each of many different sites. As an alternative to providing high-speed links, data compression can reduce the size of network messages, thereby reducing the time taken for the messages to be transmitted over the network. Thus, data compression can result in an improvement in the response time of an application for a user on a distributed front-end system.

- Reduce the cost of using the system

Many public networks, such as various X.25 packet-switching networks, charge for data sent over the network from one node to another. Clearly, you can realize a cost savings by transmitting less data over the network while still providing the same service to users of applications on that network.

7.1.2 How ACMS Uses Data Compression

You can enable data compression selectively between systems in a network. You might, for example, have a mixed configuration that has both wide area and local area networks. If both the submitter and application nodes exist on the same local area network, the cost of compressing data far outweighs the cost of transmitting uncompressed data over the network.

You can control data compression on a per-process basis. For example, data compression might be beneficial if you enable it for a forms-based agent such as the Command Process (CP). On the other hand, data compression might not be appropriate for a specialized user-written agent, if that agent processes data that is not compressible using the ACMS data compression algorithm.

Using Data Compression

7.1 Overview of Data Compression

ACMS provides system management tools that allow you to control the use of the data compression. One mechanism enables you to verify that data compression is enabled and used correctly. Another mechanism allows you to monitor the efficiency of the data compression algorithm in terms of the amount of data compression that is achieved.

ACMS compresses the following types of workspace data:

- Data in task argument workspaces that an agent sends to and receives from a task
- Data in send and receive workspaces, send and receive shadow workspaces, and send and receive control text workspaces passed to HP DECforms forms
- Data in workspaces passed to TDMS requests
- Data in workspaces read or written using stream I/O

ACMS does not compress other data such as HP DECforms send and receive record names or TDMS request names.

7.1.3 How Data Compression Works

The amount that data can be compressed must be offset against the cost involved in compressing the data before it is sent over the network, and decompressing the data after it has been received. The cost is measured by CPU and memory usage.

To implement data compression, ACMS uses a simple run-length encoding algorithm that aims to provide a reasonable data compression ratio in typical applications, while not consuming excessive CPU or memory resources. In most cases, a higher compression ratio provides better performance in terms of less CPU usage and improved response time. See Table 15–2 for more information about the compression ratio.

Due to the overhead of the information necessary to describe the compressed data, compressed data sometimes occupies the same or more space than its original uncompressed form. In this situation, ACMS uses the uncompressed form when constructing a message to transmit over a network. However, when data compression is enabled, ACMS always sends less data, even if the workspaces data cannot be compressed; at the very least, the message overhead is optimized for space rather than for speed of processing.

In general, applications benefit most when using data compression under the following conditions:

- When minimal data is passed in large workspaces. In this case, the workspace should be space filled or zero filled.
- When large workspaces are sent over relatively low speed links.
- When the data in the workspaces contain long strings of consecutively identical bytes.

7.2 How to Use Data Compression

The following sections describe:

- Managing data compression by defining the logical names `ACMS$ENABLE_DATA_COMPRESSION` and `ACMS$AUDIT_NETWORK_CONNECTIONS` for processes on application and submitter nodes
- Enabling data compression in either the restricted or unrestricted mode

- Disabling data compression
- Enabling logging of data compression
- Disabling logging of data compression

Note

You must upgrade both the submitter and the application nodes to ACMS Version 3.3 or higher before you can use data compression for data in workspaces used in exchange steps.

Also, to use data compression for data in task argument workspaces that agents supply, you must rebuild any application database (ADB) files after you install ACMS.

7.2.1 Rules for Defining Logical Names

ACMS uses two logicals to manage data compression:

- ACMS\$ENABLE_DATA_COMPRESSION
- ACMS\$AUDIT_NETWORK_CONNECTIONS

You must define both the ACMS\$ENABLE_DATA_COMPRESSION and ACMS\$AUDIT_NETWORK_CONNECTIONS logical names as executive mode system logical names or as process logical names.

In an agent process, ACMS translates the logical names when the first submitter signs in. Therefore, for an ACMS-supplied CP agent, define the logical names as system logicals in executive mode before you start the ACMS terminal subsystem. For a user-written agent, you must either define the logical names before the agent program is started, or the agent program itself must define the logical names before calling ACMS\$SIGN_IN to sign in the first submitter.

In the Application Execution Controller (EXC) process, ACMS translates the logical names as part of the application startup processing. Therefore, you either must define the logical names as system logicals in executive mode before you start the application, or you must define them using the APPLICATION LOGICAL NAME clause in the application definition.

If you need to enable or disable data compression or the auditing of network connections after an agent process or an application process has been started, you must restart the process after you define, redefine, or deassign the appropriate logical names.

7.2.2 Using Restricted and Unrestricted Modes

You can enable data compression in one of two modes:

- Unrestricted mode

In unrestricted mode, ACMS uses data compression on all network connections to remote nodes that also have data compression enabled.

- Restricted mode

In restricted mode, ACMS uses data compression only on network connections to a specified set of remote nodes.

Using Data Compression

7.2 How to Use Data Compression

ACMS never uses data compression automatically. You must always explicitly enable data compression on both the application node and the submitter node before ACMS uses data compression between the two nodes. ACMS never uses data compression for communications between processes on the same node.

7.2.2.1 Enabling Data Compression in Unrestricted Mode

To enable data compression in unrestricted mode, define the `ACMS$ENABLE_DATA_COMPRESSION` logical name as the wildcard asterisk character (*).

For example, use the following command to enable data compression in unrestricted mode:

```
$ DEFINE/SYSTEM/EXECUTIVE ACMS$ENABLE_DATA_COMPRESSION *
```

Figure 7–1 illustrates a distributed configuration consisting of three submitter nodes, each connected by a wide area network to a local area network consisting of two application nodes and three more submitter nodes.

Figure 7–1 Simple Mixed-Interconnect Network

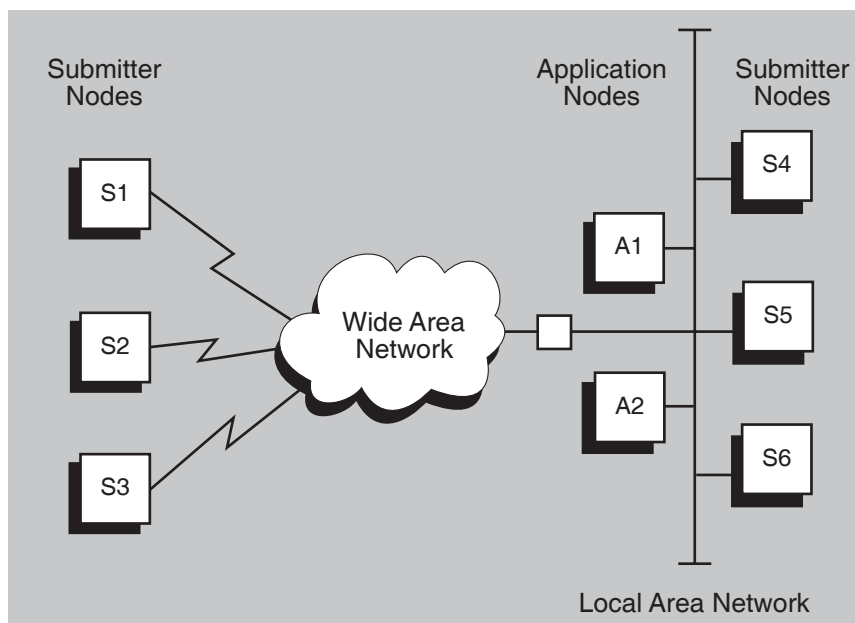

TAY-0006-AF

In the configuration in Figure 7–1, data compression is required between submitter nodes S1, S2, and S3 and application nodes A1 and A2, because the submitter and application nodes are separated by a wide area network. Data compression is not required between submitter nodes S4, S5, and S6 and application nodes A1 and A2, because the submitter and application nodes are on the same local area network.

To use data compression in this configuration, enable data compression in unrestricted mode on submitter nodes S1, S2, and S3 and on application nodes A1 and A2, using the following command:

```
$ DEFINE/SYSTEM/EXECUTIVE ACMS$ENABLE_DATA_COMPRESSION *
```

Because data compression is not enabled on nodes S4, S5, and S6, data compression is not used between these nodes and application nodes A1 and A2.

7.2.2.2 Enabling Data Compression in Restricted Mode

You might sometimes want to limit the use of data compression to network connections between specific nodes in a network. To enable data compression in restricted mode, define the `ACMS$ENABLE_DATA_COMPRESSION` logical name as a search list, with each node name separated by a comma. You can specify node names with or without the trailing double-colon (`::`).

In restricted mode, ACMS uses data compression only for network nodes defined in the `ACMS$ENABLE_DATA_COMPRESSION` logical name. You do not need to enable data compression in restricted mode on both nodes. For example, you can enable data compression on a submitter node in unrestricted mode, and enable data compression on an application node in restricted mode. To do this, include the name of the submitter node in the list of nodes that the `ACMS$ENABLE_DATA_COMPRESSION` logical name identifies.

For example, use the following command to enable data compression in restricted mode from the application node to nodes S1 and S2:

```
$ DEFINE/SYSTEM/EXECUTIVE ACMS$ENABLE_DATA_COMPRESSION S1,S2
```

On nodes S1 and S2, define the logical name in unrestricted mode:

```
$ DEFINE/SYSTEM/EXECUTIVE ACMS$ENABLE_DATA_COMPRESSION *
```

Note

In listing node names as the equivalence names in the search list when you define the `ACMS$ENABLE_DATA_COMPRESSION` logical name, do not specify the unrestricted mode (`*`) symbol as a node name. If you use the unrestricted mode (`*`) symbol in place of a node name in the search list, ACMS writes an error entry to the ACMS audit log and does not enable data compression.

Figure 7–2 extends the example shown in Figure 7–1 by adding a second local area network containing two application nodes in addition to three submitter nodes. In the example, users on any submitter node can select tasks on any of the application nodes.

In the configuration shown in Figure 7–2, data compression is required between submitter nodes S1, S2, and S3 and application nodes A3 and A4, and between submitter nodes S4, S5, and S6 and application nodes A1 and A2. Data compression is not required between any other nodes in this network.

Using Data Compression

7.2 How to Use Data Compression

Figure 7–2 Complex Mixed-Interconnect Network

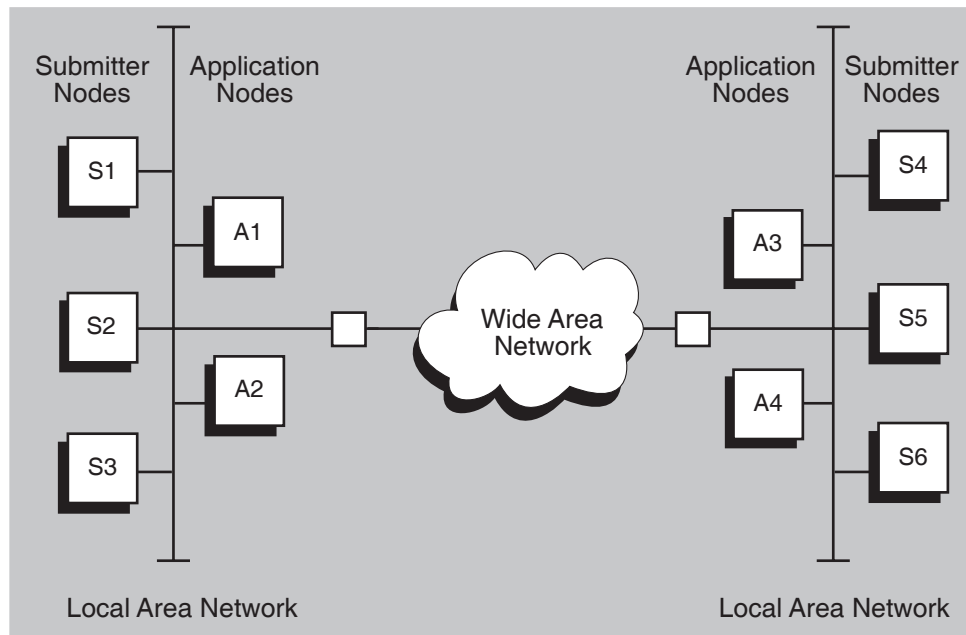

TAY-0007-AF

To use data compression in this configuration, enable data compression in unrestricted mode on the application nodes. On the submitter nodes, enable data compression so that it is used only when communicating with application nodes over the wide area network. Follow these steps:

1. Enable data compression in unrestricted mode on all the application nodes (A1, A2, A3, and A4) as follows:

```
$ DEFINE/SYSTEM/EXECUTIVE ACMS$ENABLE_DATA_COMPRESSION *
```

2. Enable data compression in restricted mode on submitter nodes S1, S2, and S3 as follows:

```
$ DEFINE/SYSTEM/EXECUTIVE ACMS$ENABLE_DATA_COMPRESSION A3, A4
```

3. On submitter nodes S4, S5, and S6, enable data compression in restricted mode as follows:

```
$ DEFINE/SYSTEM/EXECUTIVE ACMS$ENABLE_DATA_COMPRESSION A1, A2
```

An alternative approach in this example is to enable data compression in unrestricted mode on all the submitter nodes and then enable data compression in restricted mode on each application node. Follow these steps:

1. Enable data compression in unrestricted mode on all the submitter nodes (S1, S2, S3, S4, S5, and S6):

```
$ DEFINE/SYSTEM/EXECUTIVE ACMS$ENABLE_DATA_COMPRESSION *
```

2. Enable data compression in restricted mode on application nodes A1 and A2:

```
$ DEFINE/SYSTEM/EXECUTIVE ACMS$ENABLE_DATA_COMPRESSION S4, S5, S6
```

3. Enable data compression in restricted mode on application nodes A3 and A4:

```
$ DEFINE/SYSTEM/EXECUTIVE ACMS$ENABLE_DATA_COMPRESSION S1, S2, S3
```

7.2.3 Disabling Data Compression

You might sometimes want to enable data compression on a general, system-wide basis, but disable it for specific processes. For example, you might want to disable it for a specialized user-written agent, if that agent processes data that cannot be compressed using the ACMS data compression algorithm.

To explicitly disable data compression, define the `ACMS$ENABLE_DATA_COMPRESSION` logical name as a hyphen character enclosed in quotation marks ("-"). For example, use the following command to disable data compression for a specific process:

```
$ DEFINE/PROCESS ACMS$ENABLE_DATA_COMPRESSION "-"
```

Note

DCL uses the hyphen character (-) to indicate the continuation of a DCL command line; therefore, you must enclose the character in quotation marks to differentiate it.

Do not specify the disable symbol ("-") as a node name when you list node names as the equivalence names in the search list when you define the `ACMS$ENABLE_DATA_COMPRESSION` logical name. If you use the disable symbol ("-") in place of a node name in the search list, ACMS writes an error entry to the ACMS audit log and does not enable data compression.

7.2.4 Enabling Logging of Data Compression

To verify that data compression is enabled correctly, enable logging of ACMS network connection information. When you do this, ACMS writes an entry to the ACMS audit log every time a new ACMS process is started and every time a process initiates or accepts a new network connection.

You can enable auditing on a submitter node, an application node, or both. You can then use the information written to the audit log to determine if ACMS is using data compression correctly on network connections to the appropriate remote nodes.

ACMS uses the `ACMS$AUDIT_NETWORK_CONNECTIONS` logical name to enable logging of ACMS network connection information. You must define the `ACMS$AUDIT_NETWORK_CONNECTIONS` logical name as an executive-mode system logical name or as a process logical name in any mode.

To log ACMS network connection information, define the `ACMS$AUDIT_NETWORK_CONNECTIONS` logical name as a string beginning with T or t (true) or, Y or y (yes), or define it as a success status (an odd number). For example, use the following command to log network connection information for all processes on a node:

```
$ DEFINE/SYSTEM/EXECUTIVE ACMS$AUDIT_NETWORK_CONNECTIONS Y
```

Using Data Compression

7.2 How to Use Data Compression

7.2.4.1 Entries Written to the Audit Log When a New Process Is Started

When verification of network connection information is enabled, ACMS writes an entry to the audit log whenever a new process is started. The following examples illustrate each type of entry.

Example 7–1 illustrates the format of the entry ACMS logs when a process is started and data compression has not been enabled.

Example 7–1 Data Compression Is Not Enabled

```
*****  
Type   : OTHER      Time   : 31-Jul-1992 15:20:01.15  
Text   : Process ACMS01EXC001000 started  
Data compression is not enabled  
*****
```

Example 7–2 illustrates the entry ACMS logs when a process is started and data compression has been explicitly disabled.

Example 7–2 Data Compression Is Disabled

```
*****  
Type   : OTHER      Time   : 31-Jul-1992 15:21:02.16  
Text   : Process ACMS01EXC002000 started  
Data compression is explicitly disabled  
*****
```

Example 7–3 illustrates the entry ACMS logs when a process is started and data compression has been enabled in unrestricted mode.

Example 7–3 Data Compression Is Enabled in Unrestricted Mode

```
*****  
Type   : OTHER      Time   : 31-Jul-1992 15:22:03.17  
Text   : Process ACMS01EXC003000 started  
Data compression is enabled for all nodes  
*****
```

Example 7–4 illustrates the entry ACMS logs when a process is started and data compression has been enabled in restricted mode.

Example 7–4 Data Compression Is Enabled in Restricted Mode

```
*****  
Type   : OTHER      Time   : 31-Jul-1992 15:23:04.18  
Text   : Process ACMS01EXC004000 started  
Data compression is enabled for node:  
SUB1, SUB2, SUB3  
*****
```

7.2.4.2 Entries Written to the Audit Log When Network Connection Is Established

When logging network connection information to the ACMS audit log, ACMS writes an entry to the log every time a new ACMS network connection is established. Note that ACMS multiplexes ACMS network connections over a single DECnet logical link. This means that you might see multiple entries in the audit log for the same process. The following examples illustrate the format of each type of network connection entry written to the ACMS audit log.

Using Data Compression 7.2 How to Use Data Compression

Example 7-5 illustrates that a process initiated a network connection but data compression was not used, because it was not enabled for the process at the local node. Note that if data compression is not enabled at the node initiating the network connection, then information about whether data compression is enabled at the remote node is not available.

Example 7-5 Data Compression Is Not Enabled at Local Node

```
*****  
Type   : OTHER      Time   : 31-Jul-1992 15:40:21.45  
Text   : Process ACMS01CP001000 initiated network connection  
to remote node APPL1  
Data compression is disabled (not enabled at local node)  
*****
```

Example 7-6 illustrates that a process initiated a network connection, but data compression was not fully enabled, because the actual application database (ADB) file was built using a version of ACMS prior to Version 3.3. In this case, although a compressed data protocol is used, data in task argument workspaces is not compressed. To fully enable data compression, rebuild the application database (ADB) file using ACMS Version 3.3 or higher.

Example 7-6 Data Compression Is Not Fully Enabled

```
*****  
Type   : OTHER      Time   : 31-Jul-1992 15:41:14.32  
Text   : Process ACMS01QTI001000 initiated network connection  
to remote node APPL2  
Data compression not fully enabled (not enabled in ADB, please rebuild)  
*****
```

Example 7-7 illustrates that a network connection was accepted by a process on the local node. Data compression was not used, however, because it was not enabled for the process at the remote node that initiated the connection.

Example 7-7 Data Compression Is Not Enabled at the Remote Node Initiating the Network Connection

```
*****  
Type   : OTHER      Time   : 31-Jul-1992 15:42:23.76  
Text   : Process ACMS01EXC001000 accepted network connection  
from remote node SUB1  
Data compression is disabled (not enabled at remote node)  
*****
```

Example 7-8 illustrates that a network connection was accepted by a process on the local node. However, data compression was not used, because, although it is enabled at the remote node that initiated the connection, it is not enabled for the process at the local node.

Using Data Compression

7.2 How to Use Data Compression

Example 7–8 Data Compression Is Enabled at the Remote Node, But Is Not Enabled at the Local Node

```
*****
Type   : OTHER      Time   : 31-Jul-1992 15:43:28.54
Text   : Process ACMS01EXC002000 accepted network connection
        from remote node SUB2
Data compression is disabled (not enabled at local node)
*****
```

Example 7–9 and Example 7–10 illustrate network connections that were established with data compression enabled.

Example 7–9 Data Compression Is Enabled with Network Connection to the Remote Node

```
*****
Type   : OTHER      Time   : 31-Jul-1992 15:50:42.50
Text   : Process ACMS01CP001000 initiated network connection
        to remote node YRNODE
Data compression is enabled
*****
```

Example 7–10 Data Compression Is Enabled with Network Connection from the Remote Node

```
*****
Type   : OTHER      Time   : 31-Jul-1992 15:52:55.42
Text   : Process ACMS01EXC003000 accepted network connection
        from remote node YRNODE
Data compression is enabled
*****
```

7.2.5 Disabling Logging of Network Connections

After you verify that data compression is being used only on network connections with the nodes you specified, you might want to disable logging on a per-process basis. To disable logging of network connection information, deassign the `ACMS$AUDIT_NETWORK_CONNECTIONS` logical name. Note that ACMS does not automatically log network connection information.

To explicitly disable logging of network connection information, define the `ACMS$AUDIT_NETWORK_CONNECTIONS` logical name as a string beginning with anything other than T, t, Y, or y, or define it as a failure status (an even number). For example, use the following command to disable logging of network connection information for a process running a user-written agent:

```
$ DEFINE/PROCESS ACMS$AUDIT_NETWORK_CONNECTIONS N
```

After you disable auditing, any processes logging network connection information do not stop logging this information until the processes or the programs they are executing are restarted.

7.3 Monitoring Data Compression

ACMS uses the HP DECtrace layered product to monitor the extent to which messages sent over the network are compressed. ACMS logs an DECtrace point event, called the COMPRESSED_MSG event, every time a network message is sent or received.

By default, HP DECtrace collects items for the COMPRESSED_MSG event whenever data compression is enabled, provided that you specify the PERFORMANCE or ALL collection class in your facility selection. See Section 15.3.1 for more information about the COMPRESSED_MSG event.

Table 7–1 describes the information that DECtrace collects for each network message.

Table 7–1 Information Collected for Compressed Messages

Item	Description
Source node	Name of the node that sent the message
Destination node	Name of the node that received the message
Original message length	Length in bytes of the message before data compression
Compressed message length	Length in bytes of the message after data compression
Compression ratio	Factor by which ACMS compressed the message

Controlling the ACMS System

This chapter describes how to use ACMS operator commands to:

- Start and stop the ACMS system
- Control the Terminal Subsystem Controller (TSC)
- Control operator terminals
- Control the Queued Task Initiator (QTI)
- Start and stop ACMS task queues
- Cancel ACMS users

See Section 8.9 for a summary of ACMS operator commands. For reference information about the operator commands described in this chapter, see Chapter 21.

8.1 Starting the ACMS System

This section describes how to start the ACMS system automatically and interactively. For a complete list of quotas, privileges, and SYSGEN parameters required by ACMS processes, see Chapter 10.

Before you start ACMS for the first time, use the OpenVMS Authorize Utility to make sure that the user names assigned to the following processes are authorized OpenVMS user names with sufficient privileges and quotas:

- ACMS Central Controller (ACC)
- Terminal Subsystem Controller (TSC)
- Command Process (CP)
- Application Execution Controller (EXC)
- Queued Task Initiator (QTI)

If these processes are not authorized, use the OpenVMS Authorize Utility to set up accounts for the user names and then use the ACMS User Definition Utility (UDU) to authorize the user names. The CP and QTI process user names need to be authorized as agents in the UDU authorization file. See Chapter 3 for information about authorizing these processes as agents.

See Chapter 10 for information on setting privileges and quotas for ACMS process user names. See Chapter 3 for information on authorizing ACMS process user names.

After starting ACMS, check the state of the system by using the ACMS/SHOW SYSTEM command as described in Section 8.3. If the ACMS system or applications did not start, use the Software Event Logger Utility Program (SWLUP) and the Audit Trail Report (ATR) Utility for reports of system errors.

Controlling the ACMS System

8.1 Starting the ACMS System

8.1.1 Starting ACMS Automatically

In most cases, you want to start ACMS automatically whenever the OpenVMS system starts. Start the ACMS system automatically when you bring up OpenVMS by editing your site-specific system startup file, `SYS$MANAGER:SYSTARTUP_VMS.COM`.

Note

For sites that have modularized their startup procedures, be sure you add the lines to the correct file. The default startup command file for OpenVMS VAX Version 5.n is `SYS$MANAGER:SYSTARTUP_V5.COM`; for OpenVMS VAX Version 6.n, OpenVMS Alpha and OpenVMS I64, it is `SYSTARTUP_VMS.COM`.

The following steps describe how to edit `SYSTARTUP_VMS.COM` and include operator commands to start up the ACMS system.

1. Include the command that invokes the ACMS startup file, `ACMSTART.COM`, in your OpenVMS system startup file. Position this new command line *after* the line that invokes the network startup command procedure and, if TDMS is installed on your system, *after* the command that invokes TDMS. For example:

```
$ @SYS$MANAGER:STARTNET.COM
.
.
.
$ @SYS$MANAGER:TDMSTRUP.COM
.
.
.
$ @SYS$STARTUP:ACMSTART.COM
```

It is important that the network be started before ACMS is started.

2. For distributed ACMS applications, run the ACMS startup files by including these pointers in your OpenVMS startup file:

```
$ @STARTNET.COM      ! or SUBMIT STARTNET.COM
$ @ACMSTART.COM      ! or SUBMIT ACMSTART.COM
```

3. Include the `ACMS/START SYSTEM /QTI` operator command to start the ACMS system and the ACMS QTI:

```
$ ACMS/START SYSTEM /QTI
```

At this point, you can also include the ACMS operator commands to enable operator terminals and start ACMS applications. For example:

```
$ ACMS/SET SYSTEM /OPERATOR /TERMINAL=(OPA0:)
$ ACMS/START APPLICATION DEPARTMENT, INVENTORY
```

Even if you start ACMS automatically, you can still use ACMS commands to start and stop interactively the ACMS system, ACMS applications, and ACMS components.

Instead of editing `SYSTARTUP_VMS.COM` and adding the commands in step 2 and step 3 manually, you can invoke the postinstallation command procedure `ACMS_POST_INSTALL.COM` to define your system's startup options. However,

even if you do run ACMS_POST_INSTALL.COM, you need to add the commands described in step 1 to invoke the ACMS startup file ACMSTART.COM.

To run ACMS_POST_INSTALL.COM, set your default to SYS\$MANAGER and enter the following command:

```
$ @ACMS_POST_INSTALL.COM
```

ACMS_POST_INSTALL.COM creates the command file ACMS_SETUP.COM which defines ACMS logicals and executes ACMS startup commands each time your system boots. ACMS_POST_INSTALL.COM can also be used to install the ACMS utility images as shared images and to start ACMS applications.

8.1.2 Starting ACMS Interactively

Start ACMS interactively by using the ACMS/START SYSTEM command:

```
$ ACMS/START SYSTEM
```

Once you enter the ACMS/START SYSTEM command, the ACMS ACC (the main control point of the ACMS system) and the ACMS TSC are started. The ACC must be active before you can start an application. The TSC must be active before users can sign in to ACMS and use an application.

When you start the TSC, ACMS allocates any terminal that is currently free. Before you start ACMS, make sure that ACMS-controlled terminals are not being used by OpenVMS users. If users are logged in to OpenVMS, ACMS cannot allocate their terminals as ACMS-controlled terminals. ACMS lists the terminals it cannot allocate in the Audit Trail Log.

Prevent new users from signing in while you are starting ACMS by specifying the /NOTERMINALS qualifier with the ACMS/START SYSTEM command. The /NOTERMINALS qualifier delays sign-ins by not starting the TSC. Once you have started ACMS, you can start the TSC separately by using the ACMS/START TERMINALS command. See Section 8.4 for more information about stopping and starting the TSC.

When you start the ACMS system, you also have the option of starting the ACMS Queued Task Initiator (QTI). To start the QTI, use the /QTI qualifier with the ACMS/START SYSTEM command. For example:

```
$ ACMS/START SYSTEM/QTI
```

Once you start the QTI you can start ACMS task queues. See Section 8.7.1 for more information about starting task queues.

8.2 Stopping the ACMS System

Stop the ACMS system automatically by editing and then executing the SYS\$MANAGER:SYSHUTDOWN.COM command file, or interactively by using the ACMS/STOP SYSTEM command.

8.2.1 Stopping ACMS Automatically

To stop ACMS automatically, include the following command in your OpenVMS site-specific shutdown file SYS\$MANAGER:SYSHUTDOWN.COM:

```
$ ACMS/STOP SYSTEM/CANCEL  
$ @SYS$STARTUP:ACMSTOP.COM
```

Controlling the ACMS System

8.2 Stopping the ACMS System

The first command shuts down the ACMS system, including all applications, the TSC, and the QTI. The /CANCEL qualifier cancels all tasks running in applications or being executed by the QTI. Including the ACMS/STOP SYSTEM/CANCEL command in the system shutdown file ensures that the ACMS system processes are properly run down. If you omit the /CANCEL qualifier and there are active tasks, the ACMS/STOP SYSTEM command does not execute until all tasks stop or until the command times out after five minutes. (Tasks are not canceled when the the ACMS/STOP command times out.)

The second command line invokes the command procedure ACMSTOP.COM. ACMSTOP.COM is a shutdown command file for ACMS. It deinstalls ACMS images (using the OpenVMS Install Utility) and deassigns the logical ACMS\$EXAMPLES.

8.2.2 Stopping ACMS Interactively

You can use the ACMS/STOP SYSTEM command interactively or from a command file to stop ACMS without stopping OpenVMS, but you must first stop all active tasks. Otherwise, ACMS waits for the tasks to complete before executing the ACMS/STOP SYSTEM command. If tasks do not complete within five minutes, the command is ignored and ACMS returns you to the DCL prompt.

You can cancel all tasks and stop the ACMS system simultaneously by using the /CANCEL qualifier with the ACMS/STOP SYSTEM command. The following command cancels all active tasks and stops ACMS applications, the TSC, and the ACMS system software:

```
$ ACMS/STOP SYSTEM/CANCEL
```

As a courtesy to users, use the DCL REPLY command to ask users to finish their tasks and sign out before issuing this command.

Note

When you specify the ACMS/STOP SYSTEM command, the ACC stops all ACMS processes and the TSC before stopping itself. If you issue an ACMS/STOP SYSTEM command when the ACMS Central Controller is not active, all processes whose names begin with ACMS0 are deleted. This provides a way to stop an ACMS system that is in an improper state. If users are signed in with process names that begin with ACMS0, their processes are also stopped.

If you interrupt the ACMS/STOP SYSTEM command by pressing `Ctrl/Y`, the ACMS system may not shut down properly. Issuing subsequent ACMS/STOP SYSTEM commands can cause the error "message truncation" to occur. If you receive this error, shut down the ACMS system by specifying the DCL command STOP to halt the ACC. Then, use the ACMS/STOP SYSTEM command to stop any remaining ACMS processes.

8.3 Displaying System Information

The ACMS/SHOW SYSTEM command provides you with the following information:

1. The state of the system. The four ACMS system states are:
 - Starting

Controlling the ACMS System

8.3 Displaying System Information

- Started
- Stopping
- Stopped

While an ACMS/START SYSTEM command is processing, ACMS is in the starting state. When the command is through processing, ACMS is in a started state. While an ACMS/STOP SYSTEM command is processing, ACMS is in the stopping state. When the ACMS/STOP SYSTEM command is finished processing, ACMS is in a stopped state.

2. Users currently signed in to the system. Information about each user includes:
 - OpenVMS user name
 - Task submitter identification code assigned at sign-in
 - OpenVMS process identification for the Command Process or agent handling the user's terminal
 - Device name for the user's terminal
3. Active Application Execution Controllers. Information about the EXCs includes:
 - The names of all active applications
 - OpenVMS process information for all active applications

Example 8–1 shows the output from the ACMS/SHOW SYSTEM command. To get information about system activity over a period of time, such as the number of sign-ins in the last hour, you can use the ATR Utility, which is described in Chapter 12.

Example 8–1 ACMS/SHOW SYSTEM Command

```
$ ACMS/SHOW SYSTEM
1
ACMS V4.0   Current System State: STARTED Time: 1-MAY-1994 13:34:35.28

2 Terminal Subsystem State:      STARTED
3 Queued Task Initiator State:   STOPPED
4 System Auditing State:        ENABLED

5 Active ACMS Users

User Name      Submitter ID      Agent PID      Device
JONES          ALLDAY::0001000D  22000122      TTB1:
ROBINSON       ALLDAY::00020013  22000122      TTH0:

6 Active Execution Controllers

Application Name      Process Name      EXC PID
DEPARTMENT            ACMS01EXC001000  00610046
MARKETING             ACMS01EXC003000  2200047C
```

The following is a description of the numbered items in Example 8–1.

- 1 System state
Current system state
- 2 Terminal Subsystem State
Current state of the TSC

Controlling the ACMS System

8.3 Displaying System Information

- 3 Queued Task Initiator State
Current state of the QTI
- 4 System Auditing State
Whether system auditing is enabled or disabled
- 5 Active ACMS Users
Information about all active users
- 6 Active Execution Controllers
Information about all active EXCs

You can specify the /POOL qualifier with the ACMS/SHOW SYSTEM command to display pool information for the system. When you specify the /POOL qualifier, information about current users and active EXCs is not displayed. Example 8-2 shows the pool information displayed with the ACMS/SHOW SYSTEM/POOL command.

Example 8-2 ACMS/SHOW SYSTEM/POOL Command

```
$ ACMS/SHOW SYSTEM/POOL
ACMS V4.0          Current System State: STARTED   Time: 1-MAY-1994 11:20:49.66
Terminal Subsystem State:   STARTED
Queued Task Initiator State: STOPPED
System Auditing State:     ENABLED

ACMS System Message Switch Pools
```

1	2	3	4	5	6
Process name	Pool size	Free (pct) bytes	Largest block	Allocation failures	Garbage collections
< Shared Pool >	262144	228056 (86%)	65536	0	0
ACMS01ACC001000	131072	121168 (92%)	65536	0	0
ACMS01ATL001000	131072	127024 (96%)	65536	0	0
ACMS01TSC001000	131072	126544 (96%)	65536	0	0
ACMS01CP001000	131072	123824 (94%)	65536	0	0
ACMS01EXC008000	131072	123312 (94%)	65536	0	0
ACMS008SP001000	131072	125552 (95%)	65536	0	0
ACMS008SP002013	131072	126704 (96%)	65536	0	0

The following is a description of the numbered items in Example 8-2:

- 1 Process name
The process name for which message switch pool information is shown. The pool shared by all processes is shown with the name <Shared Pool>.
- 2 Pool size
The total size of the pool, in bytes.
- 3 Free bytes
The number of free bytes of pool space available and the percentage available.
- 4 Largest block
The size of the largest block of free pool space, in bytes.
- 5 Allocation failures
The number of times ACMS attempted and failed to allocate pool space.

6 Garbage collections

The number of times ACMS attempted to use fragmented pool space.

8.4 Terminal Subsystem Controller

The Terminal Subsystem Controller (TSC) controls which terminals can sign in to ACMS. It also allocates any ACMS-controlled terminals. Before terminal users can sign in to ACMS and use an application, the Terminal Subsystem Controller must be active.

8.4.1 Starting the TSC

Start the TSC either at the same time you start the ACMS system (as described in Section 8.1.2), or after you start the ACMS system and some ACMS applications. If the TSC is not started, users cannot sign in to ACMS. You can start the TSC separately from the ACMS system by issuing the ACMS/START TERMINALS command.

The following sequence of commands starts the ACMS system without starting the TSC, thus disabling sign-ins. The ACMS/START APPLICATION command starts the applications INVENTORY and ACCOUNTING. After the applications are started, the ACMS/START TERMINALS command starts the ACMS TSC. Users can then sign in to ACMS.

```
$ ACMS/START SYSTEM/NOTERMINALS
$ ACMS/START APPLICATION INVENTORY,ACCOUNTING
$ ACMS/START TERMINALS
```

You can start the TSC only when ACMS is active. When you start the TSC, make sure users are not signed in at terminals you have defined to sign in directly to ACMS. If users are signed in at the designated terminals, the terminals cannot be controlled by ACMS. ACMS lists the terminals it cannot control in the Audit Trail Log. Once the users sign out, use the ACMS/RESET TERMINALS command to control the terminals.

8.4.2 Stopping the TSC

The ACMS/STOP TERMINALS command stops the TSC, canceling active tasks and signing users out of ACMS. Until you restart the TSC, users cannot sign in to ACMS. When the TSC is stopped, ACMS-controlled terminals are released. You might want to stop the TSC if you need to keep users from signing in to ACMS or if you need to stop all ACMS activity by users.

The following is an example of the ACMS/STOP TERMINALS command:

```
$ ACMS/STOP TERMINALS
```

Before you stop the TSC, use the DCL REPLY command to ask users to finish their tasks and sign out. Then, use the ACMS/SHOW TASKS command to check that tasks have stopped.

8.5 Operator Terminals

ACMS sends status messages and other operational messages to terminals that you define as ACMS operator terminals. Terminals that you define as operator terminals receive messages if an application, the Audit Trail Log, or the TSC stop unexpectedly. An ACMS operator terminal can also be an OpenVMS operator terminal. ACMS also logs status and operational messages in the Software Event Log (SWL) file (see Chapter 13).

Controlling the ACMS System

8.5 Operator Terminals

8.5.1 Enabling Operator Terminals

Once you start the ACMS system, you can specify the ACMS/SET SYSTEM command with the /OPERATOR qualifier to enable ACMS operator terminals. Either place the ACMS/SET SYSTEM/OPERATOR command in your SYS\$MANAGER:SYSTARTUP_VMS.COM file, or use the command interactively.

Note

For sites that have modularized their startup procedures, be sure you add the lines to the correct file. The default startup command file for OpenVMS VAX Version 5.n is SYS\$MANAGER:SYSTARTUP_V5.COM; for OpenVMS VAX Version 6.n and OpenVMS Alpha and OpenVMS I64, it is SYSTARTUP_VMS.COM.

When you use the /OPERATOR qualifier, you must also use either the /PROCESS or the /TERMINAL qualifier. The /PROCESS qualifier enables your terminal as an ACMS operator terminal for the duration of your process, until ACMS stops, or until you disable the terminal. The /TERMINAL qualifier enables one or more terminals as ACMS operator terminals until ACMS stops or until you disable the terminals.

The following command enables terminals TTE1 and TTE2 as operator terminals:

```
$ ACMS/SET SYSTEM/OPERATOR/TERMINAL=(TTE1,TTE2)
```

When you specify more than one device name with the /TERMINAL qualifier, separate the device names with commas and enclose them in parentheses. Specify a terminal with the /TERMINAL qualifier even if no one is logged in at that terminal.

You can determine which terminals are authorized as ACMS operator terminals by looking at the Audit Trail Log. For each terminal enabled as an operator terminal, the Audit Trail Log contains the entry, "Successful permanent operator enabled", and shows the device name. See Chapter 12 in this manual for more information about the ACMS Audit Trail Log.

8.5.2 Disabling Operator Terminals

To disable ACMS operator terminals, use the ACMS/SET SYSTEM command with the /NOOPERATOR qualifier. When you specify the /NOOPERATOR qualifier, you must also specify either the /PROCESS or the /TERMINAL qualifier. The /PROCESS qualifier disables your own terminal. The /TERMINAL qualifier identifies the terminal to be disabled.

The following command disables your own terminal:

```
$ ACMS/SET SYSTEM/NOOPERATOR/PROCESS
```

This command disables the TTE1 and TTE2 terminals:

```
$ ACMS/SET SYSTEM/NOOPERATOR/TERMINAL=(TTE1,TTE2)
```

For each terminal disabled as an operator terminal, the Audit Trail Log contains the entry, "Successful permanent operator disabled" and shows the device name. See Chapter 12 in this manual for more information about the ACMS Audit Trail Log.

8.6 Queued Task Initiator

The Queued Task Initiator (QTI) is an ACMS run-time component which processes ACMS task queues by dequeuing queued task elements and initiating the associated task. The QTI user name must be authorized as an agent using the UDU. Before you can start ACMS task queues, you must start the QTI. Start the QTI either when you bring up the ACMS system or after ACMS is started. See *HP ACMS for OpenVMS Concepts and Design Guidelines* for detailed information about the QTI and the ACMS queuing facility.

8.6.1 Starting the QTI

To start the QTI after the ACMS system is started, use the ACMS/START QTI command. For example:

```
$ ACMS/START QTI
```

Once the ACMS QTI is started, you can then start task queues by specifying the ACMS/START QUEUE command. See Section 8.7.1 for information about starting task queues.

8.6.2 Stopping the QTI

To stop the QTI, specify the ACMS/STOP QTI command. The ACMS/STOP QTI command also stops all task queues. For example:

```
$ ACMS/STOP QTI
```

Unless you specify the /CANCEL qualifier with the ACMS/STOP QTI command, ACMS waits for all active tasks to complete before stopping the QTI. There is no timeout period. The following command stops the QTI, all task queues, and any active tasks:

```
$ ACMS/STOP QTI/CANCEL
```

8.6.3 Displaying QTI Information

Get information about the QTI by specifying the ACMS/SHOW QTI command. The ACMS/SHOW QTI command displays the run-time characteristics of the QTI. Example 8-3 shows the output from an ACMS/SHOW QTI command.

Example 8-3 ACMS/SHOW QTI Command

```
$ ACMS/SHOW QTI
ACMS V4.0  ACMS QTI - QUEUED TASK INITIATOR  Time:  1-MAY-1994 16:16:05.52
 1 State:  STARTED                               2 User Name:          ROLEX
 3 PID:    11000211                               4 Process Name:     ACMS01QTI00400
 5 Queues: 2                                       6 Submitter count:  6
```

The following is a description of the numbered items in Example 8-3:

1 State

Whether the QTI is started or stopped.

2 User Name

The OpenVMS user name for the QTI. This is defined by the ACMSGEN parameter QTI_USERNAME.

3 PID

Process ID of the QTI process.

Controlling the ACMS System

8.6 Queued Task Initiator

- 4 Process Name
Process name of the QTI process.
- 5 Queues
Number of currently active task queues.
- 6 Submitter count
Number of submitters currently signed in by the QTI.

8.7 Task Queues

Once you create task queues with ACMSQUEMGR and start the QTI, you can start and stop ACMS task queues. See Chapter 5 for information about how to create task queues.

8.7.1 Starting Task Queues

Once you start the QTI, you can start task queues with the ACMS/START QUEUE command. The following command starts the queue MY_QUE:

```
$ ACMS/START QUEUE MY_QUE
```

Once you start a task queue, the QTI begins dequeuing and initiating tasks in the queue.

You must specify at least one queue name with the ACMS/START QUEUE command. You can start more than one queue by separating the queue names with commas.

You can specify the /ERROR_QUEUE and /TASK_THREADS qualifiers with the ACMS/START QUEUE command. The /ERROR_QUEUE qualifier allows you to specify the name of an error queue for a task queue. Tasks that do not complete successfully are placed in the error queue (unless they are to be retried), and ACMS records any errors in the Audit Trail Log. The /TASK_THREADS qualifier allows you to determine the maximum number of concurrent outstanding task elements that the QTI processes for the specified queue.

The error queue you specify with the /ERROR_QUEUE qualifier must exist. You can create an error queue with the ACMS Queue Manager (ACMSQUEMGR) Utility. See Chapter 5 for information about how to create an error queue.

The following command starts the task queues MY_QUE and NEW_QUE and specifies that if a task does not complete successfully in either queue, the task should be placed in the error queue ERR_QUE (unless it is to be retried). Any errors are recorded in the Audit Trail Log.

```
$ ACMS/START QUEUE/ERROR_QUEUE=ERR_QUE MY_QUE,NEW_QUE
```

You can specify a value from 1 through 256 with the /TASK_THREADS qualifier. The default is /TASK_THREADS=1. The following command starts the queue YOUR_QUE and specifies that the maximum number of concurrent tasks that can execute on YOUR_QUE is 12:

```
$ ACMS/START QUEUE YOUR_QUE/TASK_THREADS=12
```

8.7.2 Stopping Task Queues

You can stop a task queue with the ACMS/STOP QUEUE command. The queue you specify must exist and be currently started. You must specify at least one queue name. The following command stops the queue MOD_QUEUE:

```
$ ACMS/STOP QUEUE MOD_QUEUE
```

You can stop more than one queue by separating the queue names with commas.

Unless you specify the /CANCEL qualifier, the ACMS/STOP QUEUE command does not complete until all outstanding tasks in the queues have stopped. The following command stops all outstanding tasks in queue MY_QUEUE and stops queue MY_QUEUE:

```
$ ACMS/STOP QUEUE/CANCEL MY_QUEUE
```

Queued task elements that have been canceled remain in the queue repository file.

8.7.3 Displaying Task Queue Information

You can display information about ACMS task queues by specifying the ACMS/SHOW QUEUE command. The ACMS/SHOW QUEUE command displays information about queues currently being processed by the QTI. Because no queue name is specified, the ACMS/SHOW QUEUE command in Example 8-4 displays queue information for all active queues.

Example 8-4 ACMS/SHOW QUEUE Command

```
$ ACMS/SHOW QUEUE
ACMS V4.0    QUEUED TASK QUEUES                Time: 1-MAY-1994 16:16:05.52
1 Task Queue: MECCAQUEUE
2  Threads:      4      3      Successful tasks invocations:783
4  Active Tasks: 2      5      Failed tasks invocations: 4
6  Error Queue: MECCAERROR_QUEUE
Task Queue: MY_QUEUE
  Threads:      6      Successful tasks invocations: 620
  Active Tasks: 4      Failed tasks invocations: 2
  Error Queue: MYERROR_QUEUE
```

The following is a description of the numbered items in Example 8-4:

- 1 Task Queue
Name of the queue.
- 2 Threads
Maximum number of concurrent tasks that can be processed by the queue.
- 3 Successful task invocations
Number of tasks that completed successfully.
- 4 Active tasks
Number of currently active tasks.
- 5 Failed task invocations
Number of tasks that failed.
- 6 Error Queue
Name of the error queue associated with the task queue.

Controlling the ACMS System

8.8 Canceling ACMS Users

8.8 Canceling ACMS Users

ACMS lets you cancel users manually with the ACMS/CANCEL USER command or automatically by using the SYS\$MANAGER:ACMSCANCEL.COM command procedure. The ACMS/CANCEL USER command allows you to sign out an active ACMS user. The command procedure can be used only to sign out inactive users.

8.8.1 Canceling Users with the ACMS/CANCEL USER Command

Use the ACMS/CANCEL USER command to cancel users before bringing down the ACMS system. When you use the ACMS/CANCEL USER command, you not only sign out the users you specify, you also cancel any tasks they have selected from a menu, plus any tasks that have been called by those tasks.

Use qualifiers to cancel users by user name, device name, or submitter ID. Use the ACMS/SHOW USER command to display user information.

If you do not use qualifiers or specify user names, the ACMS/CANCEL USER command cancels all active users and prompts you to confirm each cancellation.

When you name a user with the ACMS/CANCEL command, you cancel all users with the name you specify. In this example, only one user has the user name ADAMS:

```
$ ACMS/CANCEL USER ADAMS
User Name: ADAMS           Submitter ID: MONEY::00010030
Agent PID: 204002D        Device: RTA6:
Submitter ID: MONEY::00010030 (Y/[N]):Y
```

By default, the ACMS/CANCEL USER command asks that you confirm the cancellation by typing Y, for yes. ACMS cancels users without prompting you if you use the /NOCONFIRM qualifier, but it is safer to confirm each cancellation. In either case, you can include the /LOG qualifier with the ACMS/CANCEL USER command. The /LOG qualifier displays a message that confirms each successful cancellation.

On a distributed ACMS system, ACMS/CANCEL USER cannot cancel remote users (submitters).

8.8.2 Canceling Users with ACMSCANCEL.COM

You can use the command procedure ACMSCANCEL.COM to cancel inactive ACMS users. ACMSCANCEL.COM is located in the directory SYS\$MANAGER. By default, ACMS writes cancellation information to the file ACMS\$CANCEL.LOG in the SYS\$MANAGER directory.

If you do not want cancellation information written to the SYS\$MANAGER directory, define the logical ACMS\$CANCEL_DIR to point to a directory where you want user cancellation information placed. For example:

```
$ DEFINE/SYSTEM ACMS$CANCEL_DIR $DISK1:[MYDIR]
```

If you do not define ACMS\$CANCEL_DIR, you must have write access to the SYS\$MANAGER directory before using ACMSCANCEL.COM.

After you define ACMS\$CANCEL_DIR, or if you have write access to SYS\$MANAGER, run the command procedure by submitting it to a batch queue:

```
$ SUBMIT SYS$MANAGER:ACMSCANCEL.COM
```

By defining the logical name ACMS\$CANCEL_USER_WAIT as a group or system logical, you can choose the length of time that ACMSCANCEL.COM waits before canceling inactive users. By default, ACMSCANCEL.COM cancels all users who have been inactive for one hour. The following command tells ACMSCANCEL.COM to wait 1 hour and 45 minutes before canceling any inactive users:

```
$ DEFINE/SYSTEM ACMS$CANCEL_USER_WAIT 01:45
```

8.8.3 Displaying User Information

The ACMS/SHOW USER command displays information about ACMS users. Include one or more user names as parameters. If you include more than one user name, separate the names with a comma. If you do not include a user name, ACMS displays information about all users signed in to ACMS.

Use the /DEVICE qualifier to display information about a user at a specific terminal. The following command displays information about the user JONES signed in at terminal TTHO:.

```
$ ACMS/SHOW USER JONES/DEVICE=TTHO:
```

By default, ACMS does not display task information when you use the ACMS/SHOW USER command. For information about the tasks that users are running, specify the /FULL qualifier with the ACMS/SHOW USER command. However, the ACMS/SHOW USER /FULL command only displays the task selected by a user from the ACMS menu. It does not display any tasks called by a task. To display all task instances in a sequence of task calls, use the ACMS/SHOW TASKS command. Example 8-5 contains sample output from the ACMS/SHOW USER/FULL command.

Example 8-5 ACMS/SHOW USER/FULL Command

```
$ ACMS/SHOW USER/FULL

ACMS V4.0      CURRENT USERS      Time: 1-MAY-1994 20:11:04.21

1  User Name:   JONES           2  Submitter ID:  KARAT::00010027
3  Agent PID:  22E000A4        4  Device:       VTA5:

   5  Task Name:   DELETE
     6  Task ID:   KARAT::00010029-0000000F
     7  Appl Name: TEST1
     8  Appl Node: ALLDAY::
```

This command displays task information for each local submitter, including their remote task selections. This command does not display information about remote submitters. The following is a description of the numbered items in Example 8-5:

- 1 User Name
OpenVMS user name for a user signed in to ACMS.
- 2 Submitter ID
ACMS task submitter identification code assigned to the user at sign-in. Refer to Chapter 12 for information about submitter identification codes.
- 3 Agent PID
OpenVMS process ID (PID) for a submitter's agent process. For those submitters signed in to the TSC, this is the process ID of the submitter's Command Process.

Controlling the ACMS System

8.8 Canceling ACMS Users

- 4 Device
ACMS login device of the submitter.
- 5 Task Name
Name of the task that the user is running. The task name is the name defined for the task in the task group definition.
- 6 Task ID
ACMS task identification code for the task the user is running. Refer to Chapter 12 for information on task identification codes.
- 7 Appl Name
Name of the application in which the task is running.
- 8 Appl Node
Name of the node on which the application is running.

Example 8–5 shows that JONES is running a task named DELETE on node ALLDAY at terminal VTA5. If more than one user is signed in under the user name JONES, the command displays information about all users named JONES.

8.9 Summary of Operator Commands and Qualifiers

Table 8–1 lists the ACMS operator commands and their qualifiers and provides a brief description of each command. For detailed information about the operator commands and qualifiers, see Chapter 21.

Table 8–1 Summary of Operator Commands

Commands and Qualifiers	Description
ACMS/CANCEL TASK /APPLICATION=application-name /[NO]CONFIRM /DEVICE=device-name /IDENTIFIER=task-id /[NO]LOG /SUBMITTER=submitter-id /USER=user-name	Stops task instances.
ACMS/CANCEL USER /[NO]CONFIRM /DEVICE=device-name /[NO]LOG /SUBMITTER=submitter-id	Stops all tasks for the user and logs the user out of ACMS.
ACMS/DEBUG /AGENT_HANDLE /PID /SERVER /TWS_POOLSIZ[=n] /TWSC_POOLSIZ[=n] /WORKSPACE	Starts the ACMS Task Debugger.

(continued on next page)

Controlling the ACMS System

8.9 Summary of Operator Commands and Qualifiers

Table 8–1 (Cont.) Summary of Operator Commands

Commands and Qualifiers	Description
ACMS/ENTER /[NO]RETURN	Signs users in to ACMS. This command does not require OPERATOR privilege.
ACMS/INSTALL /[NO]REMOVE	Installs an application database (.ADB) file in ACMS\$DIRECTORY.
ACMS/MODIFY APPLICATION /APPLICATION_ATTRIBUTES /[NO]CONFIRM /[NO]LOG /SERVER_ATTRIBUTES /TASK_ATTRIBUTES	Modifies the attributes of an active application.
ACMS/REPLACE SERVER /APPLICATION=application-name /[NO]CONFIRM /[NO]LOG	Replaces a server image with a new version of that image.
ACMS/REPROCESS APPLICATION_SPEC /[NO]CONFIRM /[NO]LOG	Causes ACMS to retranslate the file specification of an application.
ACMS/RESET AUDIT	Creates a new version of the Audit Trail Log file when ACMS is active.
ACMS/RESET TERMINALS	Makes recently assigned sign-in characteristics in DDU definitions available to ACMS.
ACMS/SET QUEUE /TASK_THREADS=n	Sets the processing characteristics of a started queue.
ACMS/SET SYSTEM /[NO]AUDIT /[NO]OPERATOR /PROCESS /TERMINAL=device-name	Depending on the qualifiers used, enables or disables the Audit Trail Log or ACMS operators' terminals.
ACMS/SHOW APPLICATION /CONNECTIONS /DETACHED_TASKS /POOL /SERVER_ATTRIBUTES /TASK_ATTRIBUTES	Displays information about one or more active ACMS applications in static mode.
ACMS/SHOW APPLICATION/CONTINUOUS /[NO]BEGINNING_TIME=time /[NO]ENDING_TIME=time /[NO]INTERVAL[=seconds] /[NO]OUTPUT[=file-spec]	Displays information about one or more active ACMS applications in continuous refresh mode.
ACMS/SHOW QTI	Displays the run-time characteristics of the QTI.
ACMS/SHOW QUEUE	Displays active queue information.
ACMS/SHOW SERVER /APPLICATION=application-name	Displays information about one or more servers.
ACMS/SHOW SYSTEM /POOL /ALL	Displays information about the ACMS run-time system.

(continued on next page)

Controlling the ACMS System

8.9 Summary of Operator Commands and Qualifiers

Table 8–1 (Cont.) Summary of Operator Commands

Commands and Qualifiers	Description
ACMS/SHOW TASK /APPLICATION=application-name /DEVICE=device-name /IDENTIFIER=task-id /SUBMITTER=submitter-id /USER=user-name	Displays information about one or more active ACMS tasks executing on the local node.
ACMS/SHOW USER /ALL /APPLICATION /DEVICE=device-name /[NO]FULL /LOCAL /REMOTE /SUBMITTER	Displays information about ACMS users on the node where you specify the ACMS/SHOW USER command.
ACMS/START APPLICATION	Starts one or more ACMS applications.
ACMS/START QTI	Starts the QTI.
ACMS/START QUEUE /ERROR_QUEUE=error-queue-name /TASK_THREADS=n	Starts a queue and any tasks in the queue.
ACMS/START SYSTEM /[NO]AUDIT /[NO]QTI /[NO]TERMINALS	Starts the ACMS system.
ACMS/START TASK /[NO]LOG /[NO]RETRY_LIMIT[=n] /SELECTION_STRING=selection_string /USERNAME=username /WAIT_TIMER=n	Starts a detached task in the specified application.
ACMS/START TERMINALS	Starts the TSC.
ACMS/STOP APPLICATION /[NO]CANCEL	Stops one or more ACMS applications.
ACMS/STOP QTI /[NO]CANCEL	Stops the QTI and all task queues.
ACMS/STOP QUEUE /[NO]CANCEL	Stops the specified queue.
ACMS/STOP SYSTEM /[NO]CANCEL	Stops ACMS applications, the TSC, and ACMS.
ACMS/STOP TERMINALS	Stops the TSC.

Installing and Managing Applications

This chapter describes the ACMS operator commands you can use to install and run ACMS applications, modify active applications, and cancel tasks. For reference information on the commands described in this chapter, refer to Chapter 21.

9.1 Installing Applications

Before you can install an application, you must first be authorized by the Application Authorization Utility (AAU). See Chapter 4 for information on how to use the AAU to authorize users to install applications.

Once you are authorized by the AAU, install an application by issuing the ACMS/INSTALL command. You do not need any special OpenVMS privileges to install an application. The ACMS/INSTALL command installs applications in the directory pointed to by the logical name ACMS\$DIRECTORY. All applications must be installed in ACMS\$DIRECTORY before they can run on the ACMS system. When you enter the ACMS/INSTALL command, ACMS displays a message confirming that the application has been installed in ACMS\$DIRECTORY. For example:

```
$ ACMS/INSTALL DISK1:[ACCOUNT]INVENTORY.ADB
%ACMSINS-S-ADBINS, Application DISK1:[ACCOUNT] -
INVENTORY.ADB has been installed in ACMS$DIRECTORY
```

This command installs the application INVENTORY in ACMS\$DIRECTORY.

Figure 9–1 shows the steps ACMS takes when installing an application.

Figure 9–1 Process of Installing an Application

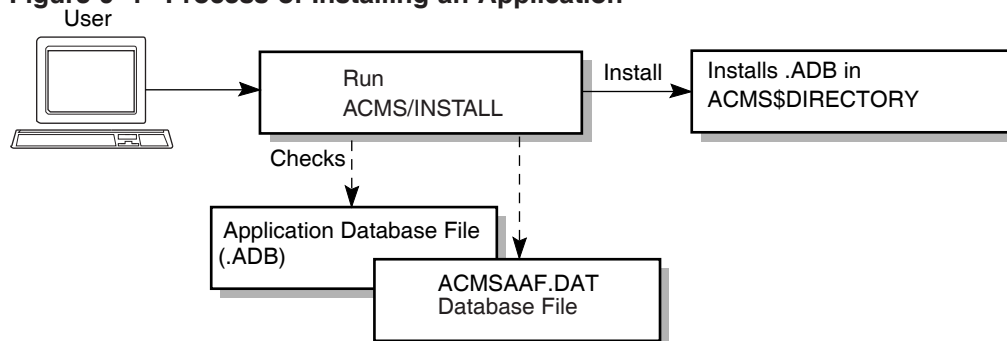

TAY-0145-AD

Installing and Managing Applications

9.1 Installing Applications

If you attempt to install an application you are not authorized to install, ACMS displays the following messages, terminates the installation attempt, and returns you to DCL level:

```
%ACMSINS-E-INSFAIL, INSTALL command failed
-SYSTEM-F-NOPRIV, no privilege for attempted operation
$
```

Include either a file specification or the logical name of an application with the ACMS/INSTALL command. If you specify a logical name that is a search list, ACMS installs only the first available application in the search list.

When you install an application database file, the ACMS/INSTALL command checks the application authorization database file (ACMSAAF.DAT) to confirm that:

- The application named with the ACMS/INSTALL command has an authorization in the ACMSAAF.DAT file.
- The user running the ACMS/INSTALL command is authorized by the ACMSAAF.DAT file to install the application.
- The server user names in the application match the server user names that have been authorized in the ACMSAAF.DAT file.
- The application user name in the application matches the name assigned in the ACMSAAF.DAT file.
- The dynamic user name characteristic in the application matches the name assigned in the ACMSAAF.DAT file.

After checking the ACMSAAF.DAT file, AAU:

- Copies the application database file to the directory pointed to by the logical name ACMS\$DIRECTORY.
- Deletes an earlier version if it exists.
- Changes the application database file UIC to [1,4], which is the SYSTEM account.

Once an application is installed, stop and restart ACMS to make the new version of the application available to users. Chapter 8 describes how to start and stop the ACMS system. If you are reinstalling an application, you must stop the application before you reinstall it.

After you stop and restart ACMS, you can run the application by using the ACMS/START APPLICATION command. See Section 9.3 for information on how to run an ACMS application.

9.2 Removing Applications

To delete an application from ACMS\$DIRECTORY, specify the /REMOVE qualifier with the ACMS/INSTALL command and the file name of the application you want to remove. You must be authorized by the AAU before you can remove an application.

For example, you can delete the application installed in the example in the previous section by typing the following command. Once you enter this command, ACMS displays a message confirming that the application has been removed.

```
$ ACMS/INSTALL INVENTORY/REMOVE
%ACMSINS-S-ADBINSREM, Application INVENTORY
has been removed from ACMS$DIRECTORY
$
```

When you specify the ACMS/INSTALL command with the /REMOVE qualifier to delete an application, ACMS does the following:

- Checks the ACMSAAF.DAT file to confirm that the user running the ACMS/INSTALL command is authorized to delete the application from ACMS\$DIRECTORY.
- Deletes the application database file from ACMS\$DIRECTORY if the user running the ACMS/INSTALL command is authorized.

Specify only a file name when deleting an application from ACMS\$DIRECTORY; do not specify device, directory, or file type. When you have a number of applications with different file names to remove from ACMS\$DIRECTORY, you must remove them one at a time. You cannot specify more than one application, use the keyword \$ALL, or use the wildcard character (*) with the /REMOVE qualifier.

9.3 Starting Applications

Once the ACMS system is up and running, you can start ACMS applications provided you have the OpenVMS OPER privilege. When you start an application, ACMS starts the application execution controller and allocates the resources the application needs. The tasks in the application are then ready for terminal users to select. Terminal users cannot select tasks that belong to an application that is not started.

The ACMS/START APPLICATION command starts one or more applications. Use the command interactively or include it in a command file. For example, the following command starts the application DEPARTMENT:

```
$ ACMS/START APPLICATION DEPARTMENT
```

Starting an application interactively helps you control the use of resources and the availability of required files and databases. You can start an application whenever ACMS is active.

9.4 Stopping Applications

The ACMS/STOP APPLICATION command stops the applications you name. You must have the OpenVMS OPER privilege to stop an application. When you stop an application, ACMS stops the application execution controller and releases the resources for the application. The tasks in the application are no longer available for users to select.

You might want to stop one or more ACMS applications if you:

- Want to free the resources an application has allocated because users are not running tasks in that application.
- Want to keep users from running tasks in an application.
- Need to replace an application database file in ACMS\$DIRECTORY because you have redefined the characteristics of an application, its servers, or its tasks.

Installing and Managing Applications

9.4 Stopping Applications

Unless you specify the /CANCEL qualifier, the ACMS/STOP APPLICATION command does not execute until all tasks in that application finish executing. Before using the /CANCEL qualifier, use the DCL REPLY command to ask users to finish their tasks. Then, use the ACMS/SHOW TASK command to check that users have stopped their tasks. Finally, issue the ACMS/STOP APPLICATION /CANCEL command to stop any remaining active tasks.

The following command cancels all active tasks in the INVENTORY and ACCOUNTING applications and then stops those applications.

```
$ ACMS/STOP APPLICATION INVENTORY, ACCOUNTING /CANCEL
```

9.5 Displaying Application Information

ACMS allows you to display information about applications in static or dynamic mode. **Static mode** displays information reflecting an application's state for an instant in time—that is, the instant in time at which the command executes. **Dynamic mode** displays information about an application continually as it executes. The following sections describe how to display information about your application in either mode.

To get information about software errors that occur during the execution of ACMS application programs, use the ACMS Software Event Log Utility Program (SWLUP) which is discussed in Chapter 13.

9.5.1 Displaying Static Information

The ACMS/SHOW APPLICATION command displays information about active applications in static mode. You can specify the name of one or several applications with the ACMS/SHOW APPLICATION command. If you do not include the name of an application, ACMS displays information about all currently active applications. Example 9–1 displays information about the application INVENTORY.

Example 9–1 ACMS/SHOW APPLICATION Command

```
$ ACMS/SHOW APPLICATION INVENTORY
ACMS V4.0      CURRENT APPLICATIONS      Time: 1-MAY-1994 17:19:40.84
1 Application Name:  INVENTORY
   2 Object Name:    ACMS01EXC001000
   3 User Name:      ACMS                4 PID:                22000123
   5 Max Task Count: 655                  6 Max SP Count:      35
   7 Cur Task Count: 0                    8 Cur SP Count:      7
   9 Auditing:       ON                   10 SP Mon. Interval: 5)

11          12          13          14          15          16
Server Name    max SPs    min SPs    active    free    waiting
                SPs        SPs        SPs        SPs        tasks
INVSrv05         5          0          0          0          0
INVSrv02         1          0          1          0          4
INVSrv06         5          1          1          0          3
INVSrv04         5          2          0          2          0
INVSrv01         5          2          1          1          0
INVSrv03         5          1          1          0          0
```

The following is a description of the numbered items in Example 9–1:

- 1 Application Name
Name of the application.

Installing and Managing Applications

9.5 Displaying Application Information

- 2 Object Name
Object name for the application.
- 3 User Name
OpenVMS user name for the application.
- 4 PID
Process identification code for the application.
- 5 Max Task Count
Maximum number of task instances allowed for the application.
- 6 Max SP Count
Maximum number of server processes allowed for the application.
- 7 Cur Task Count
Current number of active tasks in the application.
- 8 Cur SP Count
Current number of started server processes in the application.
- 9 Auditing
Whether application auditing is enabled or disabled.
- 10 SP Mon. Interval
Server process monitoring interval.
- 11 Server Name
Lists the names assigned in SERVER clauses in the application definition. Each row of the display contains information about server processes, and information about tasks waiting for those server processes.
- 12 max SPs
Maximum number of server processes allowed for this server.
- 13 min SPs
Minimum number of server processes allowed for the server.
- 14 active SPs
Number of server processes currently allocated to tasks for each server named in the application definition. Example 9–1 shows that four server processes are active in the INVENTORY application.
- 15 free SPs
Number of server processes that are started and available for use for each server named in the application definition. Example 9–1 shows that three server processes are free and thus available in the INVENTORY application for tasks that need them.
- 16 waiting tasks
Number of tasks waiting for server processes for each server named in the application definition. If no server processes are available, ACMS holds tasks that need server processes. Example 9–1 shows that a total of seven tasks are waiting for some server processes.

Installing and Managing Applications

9.5 Displaying Application Information

Use the /POOL, /SERVER_ATTRIBUTES, or /TASK_ATTRIBUTES qualifier with the ACMS/SHOW APPLICATION command to display, respectively, pool information, the current settings of modifiable server attributes, and the current settings of modifiable task attributes for an application. Example 9–2 displays pool information for the application TEST.

Example 9–2 ACMS/SHOW APPLICATION/POOL TEST Command

```
$ ACMS/SHOW APPLICATION/POOL TEST
ACMS V4.0          CURRENT APPLICATIONS          Time: 1-MAY-1994 11:21:04.50
Application Name: TEST                               State:  STARTED

Object Name:      ACMS01EXC008000
User Name:        ACMS$EXC                          PID:              25C01337
Max Task Count:   65535                               Max SP Count:     5
Cur Task Count:  0                                   Cur SP Count:     2
Auditing:         ON                                   SP Mon. Interval: 5

Application Workspace and Control Pools

      1          2          3          4          5          6
      Pool      Pool      Free (pct.) Largest Allocation Garbage
      type      size      bytes      block    failures  collections
Group/User workspace pools
7   Control pool  65536      64848 (98%)  32768      0          0
8   Workspace pool 131072     130560 (99%) 65536      0          0
9   TEST_GRP01
10  Control pool  25600      25088 (98%)  16384      0          0
11  Workspace pool 179200     178688 (99%) 65536      0          0
TEST_GRP02
   Control pool  25600      25088 (98%)  16384      0          0
   Workspace pool 179200     178688 (99%) 65536      0          0
DBMS_GRP
   Control pool  25600      25088 (98%)  16384      0          0
   Workspace pool 179200     178688 (99%) 65536      0          0
```

The following is a description of the numbered items in Example 9–2:

- 1 Pool type
Type of pool, either control or workspace pool.
- 2 Pool size
Total size of the pool, in bytes.
- 3 Free bytes
Number of free bytes of pool space available and the percentage available.
- 4 Largest block
Size of the largest block of free pool space, in bytes.
- 5 Allocation failures
Number of times ACMS attempted to allocate pool space but failed.
- 6 Garbage collections
Number of times ACMS attempted to use fragmented pool space.
- 7 Control pool
Control pool information for the application, whose size is controlled by the ACMSGEN parameter WSC_POOLSIZE.

Installing and Managing Applications

9.5 Displaying Application Information

8 Workspace pool

Workspace pool information for the application, whose size is controlled by the ACMSGEN parameter WS_POOLSIZE.

9 TEST_GRP01

Name of the task group for which pool information is displayed.

10 Control pool

Control pool information for the task group, whose size is controlled by the ACMSGEN parameter TWSC_POOLSIZE.

11 Workspace pool

Workspace pool information for the task group, whose size is controlled by the ACMSGEN parameter TWS_POOLSIZE.

Use the information in the pool display to determine the correct sizes for the ACMSGEN parameters for control and workspace pools. See Chapter 11 for more information.

9.5.2 Displaying Dynamic Information

Dynamically display information about a single application by using the ACMS/SHOW APPLICATION/CONTINUOUS command. ACMS/SHOW APPLICATION/CONTINUOUS command allows you to:

- Specify how often you want an application's statistics refreshed.
- Specify when you want the display to begin.
- Specify when you want the display to end.
- Name a file where you want the SHOW output written.

When you specify the ACMS/SHOW APPLICATION/CONTINUOUS command, specify the file name of a started application. If you do not specify an application name, ACMS returns an error. Specify only the file name; do not include device, directory, or file type. You cannot specify more than one application name with the ACMS/SHOW APPLICATION/CONTINUOUS command. Example 9-3 displays dynamic information about the application STORAGE.

Example 9-3 ACMS/SHOW APPLICATION/CONTINUOUS Command

```
$ ACMS/SHOW APPLICATION/CONTINUOUS STORAGE
ACMS V4.0          ACMS CONTINUOUS APPLICATION MONITOR   NODE::MYNODE
                  1-MAY-1994 07:52:04.62
 1 Name:          STORAGE
 2 Process:       ACMS01EXC015000
 3 User:          ACMS$EXC                               4 PID: 22E00563
 5 Max Tasks:    65535                                   6 Max SPs: 22
 7 Cur Tasks:    15                                       8 Cur SPs: 13

 9                10                11                12                13                14
SERVER NAME      Min SP/Max SP Current Average Minimum Maximum
TESTSRV01       3/3
  Active Servers           0           0           0           1
  Free Servers             3           1           0           3
  Waiting Tasks           0           2           0           28
```

(continued on next page)

Installing and Managing Applications

9.5 Displaying Application Information

Example 9–3 (Cont.) ACMS/SHOW APPLICATION/CONTINUOUS Command

```
TLOAD001S          3/3
  Active Servers      2      1      0      3
  Free Servers       1      1      0      3
  Waiting Tasks      0     12      0     92
```

You can control the video display by using the control and arrow keys. Press **Ctrl/C**, **Ctrl/Y**, or **Ctrl/Z** to terminate the display. Press **Ctrl/W** to refresh the screen. The up and down arrow keys scroll the screen forward and backward.

The following is a description of the numbered items in Example 9–3:

- 1 Name
Name of the application.
- 2 Process
Name of the process.
- 3 User
OpenVMS user name for the application.
- 4 PID
Process ID for the application.
- 5 Max Tasks
Maximum number of task instances allowed for the application.
- 6 Max SPs
Maximum number of server processes allowed for the application.
- 7 Cur Tasks
Current number of active tasks in the application.
- 8 Cur SPs
Current number of started server processes in the application.
- 9 SERVER NAME
List of the names assigned in **SERVER** clauses in the application definition. Each row of the display contains information about server processes, and information about tasks waiting for those server processes.
- 10 Min SP/Max SP
Minimum number of server processes and maximum number of server processes allowed for this server.
- 11 Current
Current number of processes started for this server.
- 12 Average
Average number of processes for this server.
- 13 Minimum
Minimum number of processes for this server.

14 Maximum

Maximum number of processes for this server.

ACMS refreshes the screen every 30 seconds by default. If you want the screen to refresh at a different interval, specify in seconds the interval you prefer. For example, the following command causes new information for the BOOKSALES application to display on your terminal screen every 300 seconds (5 minutes):

```
$ ACMS/SHOW APPLICATION/CONTINUOUS/INTERVAL=300 BOOKSALES
```

Begin or end a continuous application display with the /BEGINNING_TIME and /ENDING_TIME qualifiers. Both qualifiers let you specify times in OpenVMS absolute time format, delta time format, or a combination of the two. Refer to *OpenVMS DCL Dictionary* for information about how to create valid time formats.

There are occasions when having hardcopy records of application information is useful. The /OUTPUT qualifier requests ACMS to copy application data to a file you name. Then either display the file at your terminal or print it. If you do not specify a file, ACMS stores information in the file ACMSSHOW.LIS in your current default directory. When you do not use the /OUTPUT qualifier, ACMS sends output to the default output device defined by the SYS\$OUTPUT logical name.

9.6 Modifying Active Applications

Use the ACMS/MODIFY APPLICATION command to modify the application, task, or server attributes of an active application. The attributes you modify are not permanent. If you want a modification to be permanent, you must modify the application definition.

9.6.1 Modifying Application Attributes

Specify the ACMS/MODIFY APPLICATION command with the /APPLICATION_ATTRIBUTES qualifier to modify the attributes of an active application. Keywords to the /APPLICATION_ATTRIBUTES qualifier specify the application attribute you want to modify. For example, the MAX_PROCESS keyword in the following example sets the maximum number of server processes allowed in application AIR_REGISTER to 5:

```
$ ACMS/MODIFY APPLICATION AIR_REGISTER -  
_ $ /APPLICATION_ATTRIBUTES=MAX_PROCESS=5  
Apply Modifications to Application AIR_REGISTER (Y/[N]):
```

Use keywords to the /APPLICATION_ATTRIBUTES qualifier to:

- Enable or disable application-level auditing.
- Specify the maximum number of tasks that can execute simultaneously in an application.
- Specify the maximum number of server processes that can be active simultaneously in an application.
- Specify the interval at which ACMS monitors server processes in an application.

When application-level auditing is enabled, the Audit Trail Logger records any application modifications you make in the Audit Trail Log. See Chapter 12 for an example of an audit trail record for a modified application.

Installing and Managing Applications

9.6 Modifying Active Applications

To display the currently defined attributes for an application, specify the ACMS/SHOW APPLICATION command. Section 9.5.1 describes the ACMS/SHOW APPLICATION command and provides some sample output.

9.6.2 Modifying Server Attributes

Use the ACMS/MODIFY APPLICATION command with the /SERVER_ATTRIBUTES qualifier to modify the attributes of a server in an application. Keywords to the /SERVER_ATTRIBUTES qualifier specify the server attributes you want to modify.

You can modify the attributes of a particular server in an application, the attributes of all servers in an application, or, if you do not specify an application name, the attributes of all servers in all applications. For example, the NAME and PROCESS_DUMPS keywords in the following example cause ACMS to enable server process dumps for server MYSERV in application SANDAPPL:

```
$ ACMS/MODIFY APPLICATION SANDAPPL -
_$ /SERVER_ATTRIBUTES=(NAME=MYSERV,PROCESS_DUMPS)
Apply Modifications to Application SANDAPPL (Y/[N]):
```

Use keywords to the /SERVER_ATTRIBUTES qualifier to:

- Enable or disable server-level auditing in an application.
- Specify the interval or delay time ACMS waits before creating new server processes.
- Specify the interval or delay time ACMS waits before deleting free server processes.
- Enable or disable server process dumps for an application.
- Specify the maximum number of server processes allowed for an application.
- Specify the minimum number of server processes allowed for an application.

Display currently defined server attributes for an application by specifying the ACMS/SHOW APPLICATION/SERVER_ATTRIBUTES command.

When application-level auditing is enabled, the Audit Trail Logger records the modification in the Audit Trail Log file. See Chapter 12 for an example of an audit trail record generated by the ACMS/MODIFY APPLICATION command.

9.6.3 Modifying Task Attributes

The ACMS/MODIFY APPLICATION command with the /TASK_ATTRIBUTES qualifier modifies the attributes of tasks in an application. In the following example, the AUDIT keyword to the /TASK_ATTRIBUTES qualifier enables task-level auditing for all tasks in the application PARTS:

```
$ ACMS/MODIFY APPLICATION PARTS/TASK_ATTRIBUTES=AUDIT
Apply Modifications to Application PARTS (Y/[N]):
```

Modify the attributes of a specific task or tasks in an application by specifying the keyword NAME with the /TASK_ATTRIBUTES qualifier. The following command, for instance, disables tasks BI_MONTHLY and YEARLY in the application PARTS:

```
$ ACMS/MODIFY APPLICATION PARTS -
_$ /TASK_ATTRIBUTES=(NAME=(BI_MONTHLY, YEARLY),DISABLE)
Apply Modifications to Application PARTS (Y/[N]):
```

Use keywords to the /TASK_ATTRIBUTES qualifier to:

- Name a task or tasks whose attributes you wish to modify.
- Enable or disable task-level auditing in an application.
- Enable or disable specific tasks in an application.
- Set a transaction timeout interval or disable transaction timeout for a task or tasks.

If you do not specify a task name or names, all tasks are modified within the selected application with whatever attributes you specify.

When application-level auditing is enabled and you modify the attributes of a task, the modifications are recorded in the Audit Trail Log.

9.7 Replacing a Server Image

Use the ACMS/REPLACE SERVER command to replace a server image in an active application with a new version of that image. Application availability and task execution are not affected by the server replacement. The ACMS/REPLACE SERVER command allows the application manager to dynamically make code changes to the code executed by a procedure server. The application manager can make code changes, relink the server image, place the server image in the location specified by the SERVER IMAGE IS statement in the task group definition, and issue the ACMS/REPLACE SERVER command.

The following command, for example, replaces the server image SORT_IMAGE with a new version of that image in the application RULES_REGS. The name of the server image is defined in the application definition.

```
$ ACMS/REPLACE SERVER SORT_IMAGE/APPLICATION=RULES_REGS  
Replace Server SORT_IMAGE in Application RULES_REGS (Y/[N]):
```

When the application controller receives the ACMS/REPLACE SERVER command, it runs down all free server processes for the specified server and requests all active servers to run down when they are free. A server retaining context does not run down until the context has been released. New server processes are created to meet the minimum and maximum server process requirements of the application. If you attempt to replace an active server image, ACMS replaces it with the new version once it stops executing or is aborted.

If a server image does not stop independently because it contains an infinite loop or some other error, you can force the image to stop. To stop a server image, specify the ACMS/SHOW SERVER command to determine the process ID of the server image, and then issue the DCL command STOP/ID with the server process ID:

```
$ STOP/ID=22E00563
```

When application-level auditing is enabled and a server is replaced, the Audit Trail Logger records the event in the Audit Trail Log. See Chapter 12 for an example of an audit trail record generated by server replacement.

Installing and Managing Applications

9.8 Maintaining Application Availability

9.8 Maintaining Application Availability

As system manager, ensure that the processing workload is distributed evenly throughout all nodes in a cluster. If a heavier workload is concentrated more on one node in the cluster than on others, use the ACMS/REPROCESS APPLICATION_SPEC command to redirect application selections to a node other than the node currently being used. This frees up disk space and memory and allow tasks to execute faster.

The ACMS/REPROCESS APPLICATION_SPEC command allows you to take advantage of logical names and search lists to enhance the current ACMS ability to keep applications available in the event of a system failure.

For example, assume that tasks are being selected in an application pointed to by the application specification PAYROLL , and that PAYROLL has been defined as a logical for NODE1::PAYROLL. If PAYROLL is redefined as a logical for NODE2::PAYROLL, and you issue the following command, then all subsequent task selections for PAYROLL are processed on node NODE2 rather than node NODE1.

```
$ ACMS/REPROCESS APPLICATION_SPEC PAYROLL
```

This command is particularly useful to failback to applications when using search lists for application specifications. Search lists can be used for application specifications to provide for automatic failover to one or more backup applications in the event of a system failure. The ACMS/REPROCESS APPLICATION_SPEC command can be used to failback to the original application when it becomes available. See Chapter 6 for more information on using search lists in application specifications.

9.9 Canceling Tasks

There are several situations in which it might be necessary to cancel a task. Cancel one or more tasks when:

- You want to cancel all tasks in an application before stopping the application.
- The operator wants to cancel a user who has active tasks.
- A task is not executing properly.

To stop either an application or the ACMS system and cancel all active tasks, include a /CANCEL qualifier in the ACMS/STOP SYSTEM or ACMS/STOP APPLICATION command. The /CANCEL qualifier always interrupts any active tasks or users in the system or the application being stopped.

To cancel a task without stopping the ACMS system or application, use the ACMS/CANCEL TASK command. This command results in a non-recoverable exception. However, in distributed transactions the effect of the ACMS/CANCEL TASK command depends upon the task state:

- If the task is not composed (not participating in a distributed transaction started by a parent task or an agent), ACMS always attempts to abort an active DECdtm transaction.
- If a composed task is executing at the time of the cancel, ACMS cancels the task and returns control to the parent task or agent. An exception is returned to the parent task, or the cancel reason is returned to the agent. The parent task or the agent has responsibility for aborting the transaction.

Installing and Managing Applications

9.9 Canceling Tasks

See *HP ACMS for OpenVMS Writing Applications* for complete information about task cancellation and exception handling.

When you use this command without a task name or qualifiers, the command affects all active tasks on the local node, including tasks called by other tasks. By default, ACMS prompts you to confirm the cancellation before canceling a task. However, if you use the `/NOCONFIRM` qualifier, ACMS cancels all tasks without prompting for confirmation. In either case, include the `/LOG` qualifier with the `ACMS/CANCEL TASK` command. The `/LOG` qualifier displays a message confirming each successful cancellation.

The following command cancels `MARKET_TASK1` but not `MARKET_TASK2`:

```
$ ACMS/CANCEL TASK

Task Name: MARKET_TASK1
Task ID:      CARAT::0001000D-00000001
Application:  MARKET_APPL                User Name:   SAMPLE1
Submitter ID: CARAT::0001000D             Device:      TTB1:

Task ID:      CARAT::0001000D-00000001 (Y/[N]):Y

Task Name: MARKET_TASK2
Task ID:      CARAT::00020013-00000001
Application:  MARKET_APPL                User Name:   SAMPLE2
Submitter ID: CARAT::00020013             Device:      TTH0:

Task ID:      CARAT::00020013-00000001 [Y/[N]]:N
```

Other qualifiers available with the `ACMS/CANCEL TASK` command let you identify which task to cancel by one of several characteristics such as task name or user name. See the description of the `ACMS/CANCEL TASK` command in Chapter 21 for a description of these qualifiers.

9.10 Displaying Task Information

The `ACMS/SHOW TASK` command displays information about ACMS tasks running on your node. You can display information about tasks that are selected by a local or a remote submitter. You can include one or more task names as parameters. If you include more than one task name, separate the task names with commas. If you do not include a parameter, ACMS displays information about all active tasks. Example 9–4 shows some sample output from the `ACMS/SHOW TASK` command. Because no task name is specified, ACMS displays information about all active tasks.

Installing and Managing Applications

9.10 Displaying Task Information

Example 9–4 ACMS/SHOW TASK Command

```
$ ACMS/SHOW TASK
ACMS V4.0   CURRENT TASKS           Time: 1-MAY-1994 20:33:14.93
1
Task Name: PERS_ADD_TASK
 2 State:           Active; Executing PROCESSING step WORK
 3 Step label:     $STEP_1
 4 Task ID:        ALLDAY::00010016-0000002
 5 Application:    PERS                6 User Name:      SWEET
 7 Submitter ID:  ALLDAY::00010016     8 Device:         TTB4:
 9 Called Task:    PERS_CALLED_TASK
                State:           Active, executing BLOCK step WORK
                Step label:     $STEP_2
10 Server(s):     PERS_SERVER           Executing, PID 0200010B
11 TID:           0012000B-0120-0260-0006-0000050002101
                Task ID:        ALLDAY::00010016-00000002-00000001
```

The following describes the numbered items in Example 9–4:

- 1 **Task Name**
Name of any task the user is running. The task name is the name defined for the task in the task group definition.
- 2 **State**
Each task exists in one of these states: Starting, Active, Finishing, Completed, Processing Exception, and Cancelling. The Active, Completed, Processing Exception, and Cancelling states each have variations. See Table 9–1 for a complete list and description of the task states.
- 3 **Step label**
Current step label. SHOW TASK only displays the step label line if the task is within a step.
- 4 **Task ID**
ACMS task identification code. The task ID uniquely identifies a task instance.
- 5 **Application**
Name of the application in which the task is running.
- 6 **User Name**
User name of the task submitter. The user name is the proxy user name when the submitter selects tasks from a remote ACMS system.
- 7 **Submitter ID**
ACMS task submitter identification code assigned to the task at sign-in. The node field in the submitter ID lets you distinguish between local and remote submitters.
- 8 **Device**
ACMS login device of the task submitter. All remote task submitters are signed in with the null device (NL).
- 9 **Called Task**
Name of the called task.

- 10 Server(s)
List of the servers the task is using. A task can be executing in a server, retaining a server, or waiting for a server, or any combination of these three. For tasks executing in or retaining a server, the process identification number (PID) is supplied. For tasks waiting for a server, the number of seconds for which it has been waiting is supplied. SHOW TASK only displays the list of servers if the task is currently executing in a server, retaining a server, or waiting for a server.
- 11 TID (DECdtm transaction identification number)
TID associated with the task. The TID is displayed only for a task containing a distributed transaction, and only if it hasn't already been displayed for the task.

Table 9–1 Task States

State	Description
Starting	Task state while EXC initializes a task instance. Task initialization includes writing a "task start" record to the audit trail log.
Active	Task state when a task is currently executing, is not processing an exception, and has not been cancelled. Additional information further specifies the task state in active status.
	Active; Executing BLOCK step WORK The task is executing the work part of a block step. Since the work part of a block step involves executing the nested processing, exchange, and subordinate nested block steps within the block, then a task only maintains this state while ACMS initializes the block step.
	Active; Executing BLOCK step ACTION The task is executing the action part of a block step.
	Active; Executing BLOCK step ACTION, Committing Transaction The task is waiting for notification from DECdtm to commit the transaction as the second step in the 2-phase commit process.
	Active; Executing BLOCK step ACTION, Aborting Transaction The task is waiting for notification from DECdtm to abort the transaction.
	Active; Executing PROCESSING step WORK The task is calling a step procedure in a procedure server, executing a command in a DCL server, or calling another task.
	Active; Executing PROCESSING step ACTION The task is executing the action part of a processing step.
	Active; Executing PROCESSING step ACTION, Committing Transaction The task is waiting for notification from DECdtm to commit the transaction as the second step in the 2-phase commit process.
	Active; Executing PROCESSING step ACTION, Aborting Transaction The task is waiting for notification from DECdtm to abort the transaction.
	Active; Executing EXCHANGE step WORK The task is calling a DECforms form, a TDMS request, or performing stream I/O.
	Active; Executing EXCHANGE step ACTION The task is executing the action part of an exchange step.

(continued on next page)

Installing and Managing Applications

9.10 Displaying Task Information

Table 9–1 (Cont.) Task States

State	Description
Finishing	The task has finished execution and ACMS is completing the task. Task termination processing includes writing a “task end” record to the ACMS Audit Trail Logger.
Completed	A task enters a completed state when it has executed the last step in the task definition and is waiting for a parent task or an agent, such as the QTI, to end or abort the HP DECdtm transaction in which the task participated. When the transaction completes, EXC frees the servers and ends the task. Additional information further specifies the task state in completed status.
Completed; Waiting to Prepare	A composed task has completed, but awaits the end of the transaction. ACMS is waiting to receive a prepare message from HP DECdtm services as the first step in the 2-phase commit process.
Completed; Waiting to Commit	A composed task has ended and is stalled pending the end of the transaction. ACMS is waiting to receive a commit message from DECdtm as the second step in the 2-phase commit process.
Completed; Waiting for End of Transaction	A non-composed task has completed, but awaits the end of the transaction. ACMS is waiting for HP DECdtm to complete the 2-phase commit process.
Processing Exception	A task is processing an exception if it is actively performing the operations necessary to handle a step exception or a transaction exception. Additional information further specifies the task state in processing exception status.
Processing Exception; Cancelling an EXCHANGE step	The task is waiting for an exchange step to be cancelled before the exception handling sequence can continue.
Processing Exception; Cancelling a PROCESSING step	The task is waiting for a processing step to be cancelled before the exception handling sequence can continue.
Processing Exception; Aborting a transaction	ACMS is aborting a HP DECdtm transaction as part of the exception handling sequence.
Processing Exception; Calling server cancel procedure(s)	ACMS is calling one or more server cancel procedures as part of the exception handling sequence.
Processing Exception; Blocked, Waiting to Commit or Abort	The task is associated with a blocked transaction. The task remains in this stalled state until communication is reestablished with the transaction coordinator node, or the LMCP Utility or an Rdb or DBMS utility is used to manually resolve the state of the transaction.
Cancelling	A task is cancelling if it is actively performing the operations necessary to cancel the task following a nonrecoverable exception. Additional information further specifies the task state in cancelling status.

(continued on next page)

Table 9–1 (Cont.) Task States

State	Description
Cancelling; Cancelling an EXCHANGE step	The task is waiting for an exchange step to be cancelled before the processing sequence can continue.
Cancelling; Cancelling a PROCESSING step	The task is waiting for a processing step to be cancelled before the processing sequence can continue.
Cancelling; Aborting a transaction	ACMS is aborting a HP DECdtm transaction as part of the cancel processing sequence.
Cancelling; Calling server cancel procedure(s)	ACMS is calling one or more server cancel procedures as part of the cancel processing sequence.
Cancelling; Auditing task cancel information	ACMS is writing details about the task cancellation to the ACMS Audit Trail Log.
Cancelling; BLOCKED, Waiting to Commit or Abort	The task is associated with a blocked transaction. The task remains in this stalled state until communication is reestablished with the transaction coordinator node, or the LMCP Utility or an Rdb or DBMS utility is used to manually resolve the state of the transaction.
Cancelling; Executing task cancel action	The task is executing the cancel action phrase of the task definition.

The /APPLICATION qualifier lets you restrict the search ACMS makes to find a task. When you name an application with the /APPLICATION qualifier, ACMS searches for the tasks you name in the application you specify. The application name is the file name of the application. Do not include the device, directory, or the file type. For example:

```
$ ACMS/SHOW TASK BASIC/APPLICATION=PAYROLL
```

This command causes ACMS to search only for the task BASIC in the application PAYROLL.

To get a list of all tasks in an application, name an application with the /APPLICATION qualifier but do not name any tasks. The following command displays information on all active tasks in the application DEBTS:

```
$ ACMS/SHOW TASK/APPLICATION=DEBTS
```

Display the tasks running at a specific terminal by using the /DEVICE qualifier. The device name you specify must end with a colon (:). You can also name the null device (NL:) to display information on all remote submitter tasks. For example, the following command displays all tasks running at terminal TTF0:

```
$ ACMS/SHOW TASK/DEVICE=TTF0:
```

Include the /USER qualifier with the ACMS/SHOW TASK command to identify all tasks being run by a specific user. For example, the following command displays all tasks being run by user KURASOWA:

```
$ ACMS/SHOW TASK/USER=KURASOWA
```

Installing and Managing Applications

9.10 Displaying Task Information

The `/IDENTIFIER` and `/SUBMITTER` qualifiers allow you to display information about particular task instances. The `/IDENTIFIER` qualifier displays information about tasks by ACMS identification code, which is assigned to each task a user selects. Use the `/IDENTIFIER` qualifier to display information about a single task or about a task called by another task.

The `/SUBMITTER` qualifier displays tasks by submitter identification code, which is also assigned to each user who signs in to ACMS. Refer to Section 12.6.1 for information on submitter and task identification codes.

When you specify a node name with the `/SUBMITTER` qualifier but do not specify a task name, ACMS displays all active tasks submitted from that node. For example:

```
$ ACMS/SHOW TASK/SUBMITTER=WONDER: :
```

Include double colons (`::`) when specifying a node name.

9.11 Directing TDMS Hardcopy

You can use the `ACMS$TSS_HARDCOPY` shareable logical name table to direct output from the TDMS hardcopy key (PF4 by default) on a per-user basis.

Normally when you press the hardcopy key while executing a TDMS request, the contents of the current form are copied to a file defined by the `TSS$HARDCOPY` logical name. However, if you define the `ACMS$TSS_HARDCOPY` shareable logical name table, you can copy form contents to different files.

ACMS allows you to define multiple locations for different users form outputs by defining a logical name table of user and device names. To specify different hardcopy locations on a per-user basis, define the `ACMS$TSS_HARDCOPY` shareable logical name table under the system directory name table (`LN$SYSTEM_DIRECTORY`). Then define logical names in the `ACMS$TSS_HARDCOPY` table that specify where the contents of the form are to be copied when you press the hardcopy key.

Logical names in the name table can be either user names or physical device names. When determining where a copy of a form is to be sent, ACMS first translates the device name and then translates the user name.

To define a hardcopy location for a user name, define a logical name for the user name that equates to the name of the file where you wish a copy of the form to be sent. Similarly, for a device name, define a logical name for the physical device name (without any leading underscore or trailing colon). For example:

```
$ CREATE/NAME_TABLE ACMS$TSS_HARDCOPY/PARENT:LN$SYSTEM_DIRECTORY
$ DEFINE/TABLE=ACMS$TSS_HARDCOPY SMITH DISK$: [DIRECTORY]SMITH.TXT
$ DEFINE/TABLE=ACMS$TSS_HARDCOPY TTA5 DISK$: [DIRECTORY]TERMINAL1.TXT
```

When user `SMITH` presses the hardcopy key, a copy of the current form is placed in the file `SMITH.TXT`. Similarly, when the person using terminal `TTA5` presses the hardcopy key, a copy of the current form is placed in the file `TERMINAL1.TXT`. If user `SMITH` is logged into terminal `TTA5` then his form is copied to `TERMINAL1.TXT` instead of `SMITH.TXT`.

Installing and Managing Applications

9.11 Directing TDMS Hardcopy

ACMS translates hardcopy locations when the user signs in. If you define a new location for a particular user or device, the user must sign out of ACMS and then sign back in. The logical name table on the submitter node is used to translate a hardcopy location for the user.

See the TDMS documentation for further information on the TSS\$HARDCOPY logical name and the hardcopy key.

Setting ACMS Quotas, Parameters, and Privileges

This chapter describes the ACMS command procedures `ACMSPARAM.COM` and `ACMEXCPAR.COM` which you can use to set ACMS system parameters and process quotas. It also describes the variables used as input to `ACMSPARAM.COM` and `ACMEXCPAR.COM`, and how to gather and supply variable values to the command procedures through user prompts, the ACMS monitor, and the `ACMVARINI.DAT` initialization file.

10.1 Introduction

ACMS provides two command procedures to determine ACMS quotas and parameters after an installation or upgrade, or when you want to tune your ACMS system to reflect a changed workload.

- `SYS$MANAGER:ACMSPARAM.COM`

This command procedure automates the task of modifying OpenVMS system parameters, ACMS system parameters, and ACMS run-time process quotas.

- `SYS$MANAGER:ACMEXCPAR.COM`.

This command procedure modifies Application Execution Controller (EXC) quotas.

These command procedures let you change ACMS parameters in much the same way that the OpenVMS `AUTOGEN` Utility lets you change OpenVMS system parameters.

ACMS also provides `ACMSGEN` as a parallel to the OpenVMS `SYSGEN` Utility for adjustments to ACMS system parameters (see Chapter 11). However, perform such adjustments using `ACMSPARAM.COM` and `ACMEXCPAR.COM` rather than `ACMSGEN`, because the command procedures automatically modify any other parameters that relate to the changed parameters.

Run `ACMSPARAM.COM` and `ACMEXCPAR.COM` whenever a change occurs that could affect any parameters or quotas needed by ACMS. Such changes include, but are not limited to, the following:

- Installation of a new version of ACMS.
- Movement of an application from a development node to a production node.
- Addition of users to the ACMS system.
- Addition of an application to the ACMS system.
- Notification by the Software Event Log Utility Program (SWLUP) that a parameter has been exceeded.
- Change in the number of task queues, Queued Task Initiator (QTI) submitters, or task threads per queue.

Setting ACMS Quotas, Parameters, and Privileges

10.1 Introduction

- Warning from the ACMS monitor that quotas are in danger of being exceeded.

If you do not use ACMSPARAM.COM and ACMEXCPAR.COM, ACMS uses default values for the required quotas and parameters.

Also, although the two command procedures automate the calculation of parameters and quotas, you may still need to make some calculations on your own:

- The two command procedures do not set all of the OpenVMS system parameters required by your ACMS system. There are some OpenVMS system modifications that you might have to perform using OpenVMS AUTOGEN. See *OpenVMS System Manager's Manual* for details of the AUTOGEN Utility and its commands.
- The command procedure calculations may provide only rough approximations for some parameters and quotas based on variable calculations. To fine-tune your system even further, you may want to calculate the variables yourself, based on your particular system. Then include the variable values in the input files to the two command procedures and run the procedures. See Appendix A for a description of how the ACMSPARAM.COM and ACMEXCPAR.COM determine these values, and how you can determine alternate values for use by the command procedures.

10.2 Calculating Parameters and Quotas with ACMSPARAM.COM

The ACMSPARAM.COM command procedure performs these operations:

- Generates default values for all variables that are used to calculate ACMS system parameters (if values do not already exist).
- Calculates values for OpenVMS system parameters that are affected by ACMS.
- Calculates ACMS system parameters.
- Calculates quotas for the user names under which the ACMS Command Process (CP), ACMS Central Controller (ACC), Terminal Subsystem Controller (TSC), and QTI execute. ACMSPARAM.COM also adds accounts and assigns privileges for these user names in the SYS\$SYSTEM:SYSUAF.DAT file.
- Writes the OpenVMS system parameters that need modification to a file. ACMSPARAM.COM gives you the option of automatically updating the OpenVMS AUTOGEN input file MODPARAMS.DAT with values it generates.

10.2.1 Running ACMSPARAM.COM

ACMSPARAM.COM accepts variable values from user input, the ACMS monitor, or the ACMVARINI.DAT initialization file to set OpenVMS and ACMS system parameters and ACMS process quotas. ACMSPARAM.COM is located in the SYS\$MANAGER directory. You need SYSPRV privilege to run it. This section shows how you run ACMSPARAM.COM.

Run ACMSPARAM.COM as follows:

```
$ SET DEFAULT SYS$MANAGER
$ @ACMSPARAM [phase] [execution-mode]
```

Setting ACMS Quotas, Parameters, and Privileges

10.2 Calculating Parameters and Quotas with ACMSPARAM.COM

ACMSPARAM.COM consists of three phases. The three phases are:

- GENVAR—Accepts input from the user, the running system, and ACMS database files for calculating OpenVMS and ACMS system parameters and ACMS run-time process quotas.
- GENPAR—Calculates the parameters and quotas and writes them to a file.
- WRITEPAR—Modifies the appropriate ACMS system parameters and process quotas, and puts new values for OpenVMS system parameters in a file. You can choose to have the new OpenVMS system values automatically placed in the AUTOGEN input file, or you can enter them yourself.

The phase parameter can also take the following input:

- ALL—Runs all three phases consecutively. ALL is the default.
- HELP—You can invoke HELP as the first parameter to ACMSPARAM.COM. If you do not specify a second parameter, you receive a help message for the entire ACMSPARAM.COM procedure. Specify HELP as the first parameter to ACMSPARAM.COM, followed by the name of a single phase as a second parameter to get a help message for that phase only. For example, for help on the GENPAR phase, specify:

```
$ @ACMSPARAM HELP GENPAR
```

You can also get help for a particular variable by specifying the variable name as the second parameter. For example, to get help for the REMOTE_AGENT_CNT variable, specify:

```
$ @ACMSPARAM HELP REMOTE_AGENT_CNT
```

ACMSPARAM.COM runs in one of two execution modes:

- INITIAL mode—Prompts for user input for variables used in calculations.
- FEEDBACK mode—Gathers information from the running ACMS system for variables used in calculations. FEEDBACK mode is the default.

In either INITIAL or FEEDBACK mode, ACMSPARAM.COM also gathers information from the ACMS database files for use in calculations.

Figure 10–1 illustrates the interaction of the three phases of ACMSPARAM.COM. This section describes the details of the three phases of ACMSPARAM.COM.

Before running ACMSPARAM.COM, make sure that all logicals used in application and task definitions and all logicals used to specify the MDB for each user in ACMSUDF.DAT are defined. Otherwise, the procedure may fail.

You can run the entire command procedure or run the phases separately. You will usually want to run the entire command procedure at one time. However, sometimes you may want to run the phases one at a time and check the results before proceeding. For example, you may want to run the phases separately for the following reasons:

- To change intermediate values so that you can increase quotas to allow the application to grow over time without stopping the application.
- If you use task-call-task, after running the GENVAR phase, multiply the value for the TOTAL_TK_INSTANCE_CNT variable by the maximum task-call-task depth to get an accurate value for that variable.

Setting ACMS Quotas, Parameters, and Privileges

10.2 Calculating Parameters and Quotas with ACMSPARAM.COM

The three phases are described in the following sections and summarized in Table 10-1.

Figure 10-1 Setting System Parameters and Process Quotas with ACMSPARAM.COM

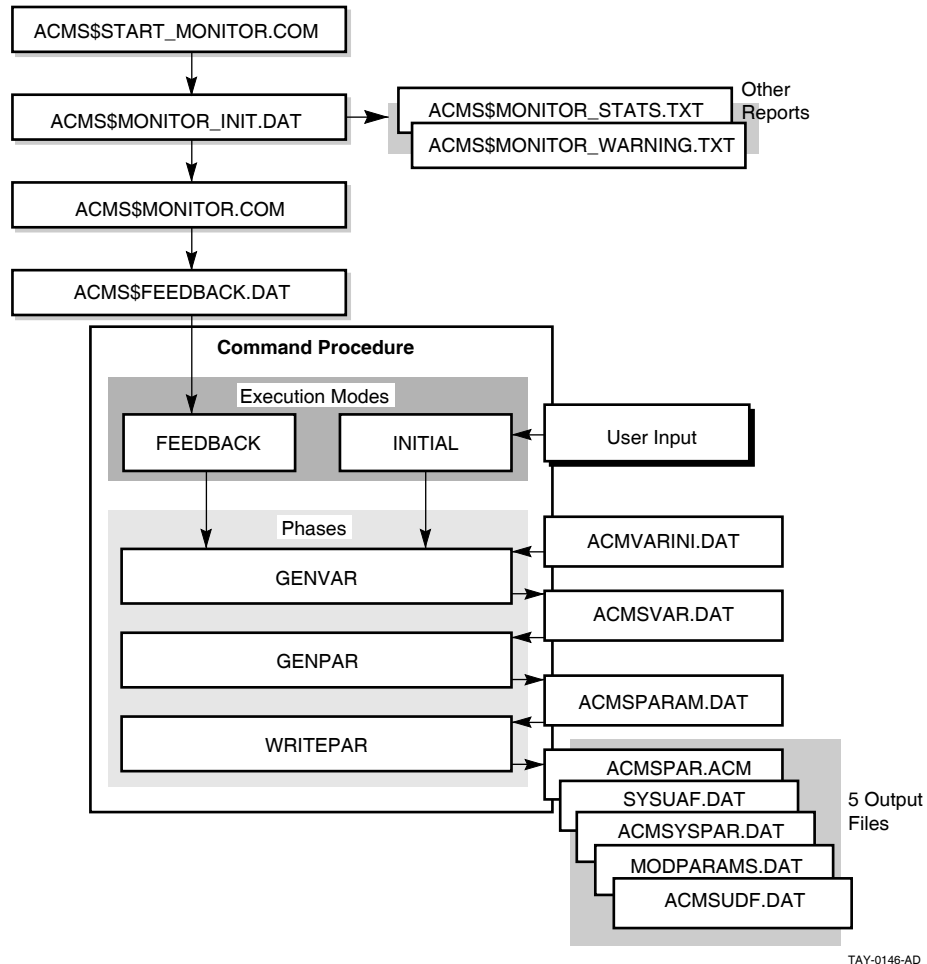

TAY-0146-AD

10.2.1.1 GENVAR Phase of ACMSPARAM.COM

The GENVAR phase creates variables based on values that are supplied as follows:

- By the user, for INITIAL mode.

Run ACMSPARAM.COM in INITIAL mode after installing or upgrading your ACMS system, or at any other time when your system has not had time to experience a typical workload, for example, when you add a new application or new users. When you use INITIAL mode, the command procedure prompts you for the following variables, if they are not specified in the initialization file ACMVARINI.DAT:

```

APPL_NAME
REMOTE_APPL_NAME
REMOTE_NODE_CNT
REMOTE_SUB_CNT
TERMINAL_CNT
  
```

Setting ACMS Quotas, Parameters, and Privileges

10.2 Calculating Parameters and Quotas with ACMSPARAM.COM

TERMINAL_PER_CP
QTI_TASK_THDS
QTI_QUEUES
QTI_SUBMITTERS

- By the ACMSPARAM.COM command procedure, for FEEDBACK mode. Run ACMSPARAM.COM in FEEDBACK mode when:
 - ACMS has run long enough to let the ACMSPARAM.COM command procedure monitor an average workload.
 - The ACMS Software Event Log Utility Program (SWLUP) informs you that a parameter was exceeded.
 - ACMSPARAM.COM issues a warning that a parameter or quota is in danger of being exceeded. FEEDBACK mode uses the data about the running system that was collected by the ACMSPARAM.COM procedure, thereby assuring accurate input for parameter and quota calculations for your specific system.

See Section 10.2.2.1 for details about running the monitor procedure.

ACMSPARAM.COM returns values to ACMSPARAM.DAT for the same variables for which INITIAL mode prompts, as well as for the following variables:

ADB_BLKs
APPL_CNT
REMOTE_APPL_CNT

Table 10–3 describes each of the variables used in ACMSPARAM.COM.

- By the procedure's reading of .ADB, .TDB, ACMSPARAM.DAT, and ACMSPARAM.DAT files.
- By editing the ACMSPARAM.DAT file .
Variable values listed in the ACMSPARAM.DAT file always take precedence. If you edit ACMSPARAM.DAT to include a variable value, ACMSPARAM.COM uses that value as follows:
 - If you use INITIAL mode and ACMSPARAM.DAT contains a value for a variable for which INITIAL mode can prompt, INITIAL mode does not prompt for that value.
 - If you use FEEDBACK mode and ACMSPARAM.DAT contains a value for a variable for which the ACMS monitor can gather information, the command procedure ignores the information gathered by the monitor for that variable.
 - If ACMSPARAM.DAT contains any variable values that can be read by the command procedure from .ADB, .TDB, ACMSPARAM.DAT, and ACMSPARAM.DAT files, the command procedure uses the values in ACMSPARAM.DAT.

Section 10.2.2 describes in detail how to gather the information needed as variable input to ACMSPARAM.COM.

GENVAR places the variable values in ACMSPARAM.DAT, the output file for the GENVAR phase.

Setting ACMS Quotas, Parameters, and Privileges

10.2 Calculating Parameters and Quotas with ACMSPARAM.COM

10.2.1.2 GENPAR Phase of ACMSPARAM.COM

At the beginning of the GENPAR phase, ACMS displays a message explaining the security implications of having multiple accounts with the same UIC. You are then prompted for a unique UIC for each account. If the specified UIC is not a system UIC, the account is granted SYSPRV privilege. The GENPAR phase also takes the variables passed to ACMSSVAR.DAT and calculates the system parameters and process quotas needed by the ACMS system. Table 10–3 describes these variables and the parameters and quotas calculated from the variables. Appendix A describes the calculations of several variables that you may want to calculate yourself and provide to ACMSPARAM.COM for even more accurate parameter and quota settings.

10.2.1.3 WRITEPAR Phase of ACMSPARAM.COM

ACMSPARAM.COM calculates values for the OpenVMS SYSGEN parameters affected by ACMS. Those OpenVMS SYSGEN parameters are:

```
CHANNELCNT
GBLPAGES
GBLPAGFIL
GBLSECTIONS
LOCKIDTBL
VIRTUALPAGECNT
```

ACMSPARAM.COM also calculates the following OpenVMS SYSGEN parameters, which are used when ACMS creates subprocesses:

```
PQL_DASTLM
PQL_DBIOLM
PQL_DDIOLM
PQL_DWSEXTENT
PQL_DWSQUOTA
```

The WRITEPAR phase of ACMSPARAM.COM modifies the ACMS system parameter file and the system user authorization file, sets any ACMSSGEN parameters specified, and displays SYS\$MANAGER:ACMSYSPAR.DAT. ACMSYSPAR.DAT lists the OpenVMS system parameters that need modification. WRITEPAR allows you to update automatically the AUTOGEN input file SYS\$SYSTEM:MODPARAMS.DAT.

ACMSPARAM.COM then reminds you to run AUTOGEN and reboot the system. If you choose not to have ACMSPARAM.COM update MODPARAMS.DAT, ACMSPARAM.COM reminds you to update MODPARAMS.DAT, run AUTOGEN, and reboot the system.

Edit the appended MODPARAMS.DAT before running SYSGEN to combine any duplicate ADD_<system_parameter> statements. ACMSPARAM.COM does not do this automatically. To ensure that this action takes place, the following informational message is displayed:

```
Remember to check the new SYS$SYSTEM:MODPARAMS.DAT to resolve any
duplicate ADD_parameter entries that occurred due to the appending
of ACMSYSPAR.DAT to MODPARAMS.DAT.
```

If an account for an ACMS process is created during the WRITEPAR phase, the procedure prompts the user for an account password and unique UIC. The password for the account must be 8 or more characters, cannot contain the name of the ACMS product, and should not be an easily guessed word. To protect against typing errors that are not seen when entering the password, users must reenter the password to verify it. Users have three chances to verify the

Setting ACMS Quotas, Parameters, and Privileges

10.2 Calculating Parameters and Quotas with ACMSPARAM.COM

password. Valid characters for a password are: A through Z, a through z, 0 through 9, \$ (dollar sign), and _ (underscore).

See Appendix A for the formulas for calculating these OpenVMS system parameter values. Refer to Chapter 11 for information about how these OpenVMS system parameters affect ACMS components.

Remember, you must reboot your OpenVMS system after you change the values of any nondynamic OpenVMS SYSGEN parameters.

Table 10–1 Phases of ACMSPARAM.COM

Phase	Description
GENVAR	
<i>Input file:</i>	SYS\$MANAGER:ACMVARINI.DAT (if available), ACMS\$FEEDBACK.DAT (if using FEEDBACK mode), user input (if using INITIAL mode)
<i>Output File:</i>	SYS\$MANAGER:ACMSVAR.DAT
<i>Function:</i>	GENVAR writes the variables provided by INITIAL or FEEDBACK mode, or by ACMVARINI.DAT, to the ACMSVAR.DAT file. If the ACMVARINI.DAT file does not exist, you can run GENVAR by itself to create a template for ACMVARINI.DAT. GENVAR sets defaults for any variables not set by INITIAL or FEEDBACK mode, or not specified by editing ACMVARINI.DAT. GENVAR overrides the defaults for any variables collected by INITIAL or FEEDBACK mode, or specified in ACMVARINI.DAT. Any variables edited directly in ACMVARINI.DAT override any values collected by INITIAL or FEEDBACK modes.
GENPAR	
<i>Input file:</i>	SYS\$MANAGER:ACMSVAR.DAT
<i>Output File:</i>	SYS\$MANAGER:ACMSPARAM.DAT
<i>Function:</i>	GENPAR performs the second phase of the ACMSPARAM.COM procedure. GENPAR calculates parameter values for the ACMS system. First, GENPAR reads variable values from the ACMSVAR.DAT file and calculates the system parameter values. Then it calculates the user name quotas for the ACC, the TSC, the CP, and the QTI. Finally, GENPAR writes the calculated parameters and quotas to the ACMSPARAM.DAT file.
WRITEPAR	
<i>Input file:</i>	SYS\$MANAGER:ACMSPARAM.DAT
<i>Output Files:</i>	SYS\$SYSTEM:ACMSPAR.ACM SYS\$SYSTEM:SYSUAF.DAT SYS\$MANAGER:ACMSYSPAR.DAT SYS\$SYSTEM:MODPARAMS.DAT SYS\$SYSTEM:ACMSUDF.DAT

(continued on next page)

Setting ACMS Quotas, Parameters, and Privileges

10.2 Calculating Parameters and Quotas with ACMSPARAM.COM

Table 10–1 (Cont.) Phases of ACMSPARAM.COM

Phase	Description
<i>Function:</i>	<p>The WRITEPAR phase is the third phase of the ACMSPARAM.COM procedure. WRITEPAR reads the parameter values from ACMSPARAM.DAT and uses them to:</p> <ul style="list-style-type: none">• Modify the ACMS system parameter file. (SYS\$SYSTEM:ACMSPAR.ACM)• Modify the system user authorization file. (SYS\$SYSTEM:SYSUAF.DAT)• List for modification the OpenVMS system parameters that need modification in SYS\$MANAGER:ACMSYSPAR.DAT. Optionally, update SYS\$SYSTEM:MODPARAMS.DAT with the ACMS required values for OpenVMS systems parameters.• Modify the ACMS User Definition file.

ACMSPARAM.COM requires information from a variety of sources to calculate parameters and quotas. The following section describes the sources and means of collecting that information.

10.2.2 Supplying Variable Values for ACMSPARAM.COM

ACMSPARAM.COM requires initial variables to calculate the OpenVMS and ACMS system parameter and process quota values needed to run ACMS efficiently. Section 10.2.1 explains how to run ACMSPARAM.COM, including when to use INITIAL or FEEDBACK mode. This section offers more detail on how you and the ACMS system gather the information needed by ACMSPARAM.COM.

The variable values come from two types of sources:

- Fixed information from ACMS files, such as task size, number of controlled terminals, and number of .MDB and .RLB files. This information comes from sources such as .ADB, .TDB, ACMSUDF.DAT, and ACMSDDF.DAT files.

Note

ACMSPARAM.COM does not support logical name search lists for TDB file specifications.

The two ways to supply the information from the ACMS files are:

- The GENVAR phase of ACMSPARAM.COM obtains information from the ACMS database files, calculates values based on this information, and places variable values into ACMSSVAR.DAT. ACMSSVAR.DAT is the input file for the GENPAR phase.
- Create and edit ACMVARINI.DAT to include values that you manually calculate for variables based on the fixed information in ACMS files. Any such variables in ACMVARINI.DAT override values collected from database files in GENVAR.
- Dynamic information from the running ACMS system, such as the number and size of the .ADB files of concurrently running applications on the current or remote nodes, or the number of concurrently active remote and local users.

Setting ACMS Quotas, Parameters, and Privileges

10.2 Calculating Parameters and Quotas with ACMSPARAM.COM

This information comes from the running processes, as well as from .ADB database files.

There are three ways to gather the variables used to calculate the parameter and quota values based on the running ACMS system:

- Run ACMSPARAM.COM in INITIAL mode. ACMSPARAM.COM prompts you for values for any variables related to the running system that are not in ACMVARINI.DAT, the GENVAR input file. See Section 10.2.1 for details about running ACMSPARAM.COM in INITIAL mode.
- Run the SYS\$MANAGER:ACMS\$MONITOR.COM procedure and then run the ACMSPARAM.COM procedure in FEEDBACK mode. ACMS\$MONITOR.COM monitors the running ACMS system to collect the most accurate variables, and places the values in ACMS\$FEEDBACK.DAT. See Section 10.2.2.1 for details about the monitor. When you run ACMSPARAM.COM in the default FEEDBACK mode, ACMSPARAM.COM uses any variables in ACMS\$FEEDBACK.DAT that do not exist in ACMVARINI.DAT. See Section 10.2.1 for details about running ACMSPARAM.COM in FEEDBACK mode.
- Create and edit ACMVARINI.DAT to enter values for the variables based on the running ACMS system. Any such variables in ACMVARINI.DAT override the corresponding variable values placed in ACMS\$FEEDBACK.DAT for use by the FEEDBACK mode, or gathered by prompts in INITIAL mode.

Section 10.2.2.2 describes the creation, editing, and use of ACMVARINI.DAT.

10.2.2.1 Supplying Variables with ACMS\$MONITOR.COM

ACMS\$MONITOR.COM periodically examines the running ACMS system and collects current, average, and peak values for ACMS process quotas and ACMS system load. Run ACMS\$MONITOR.COM long enough to gather information about the normal workload. It is recommended that the procedure run at least 24 hours to gather accurate information. Then run ACMSPARAM.COM in the default FEEDBACK mode. See Section 10.2.1 for details about running ACMSPARAM.COM in FEEDBACK mode.

Run SYS\$MANAGER:ACMS\$START_MONITOR.COM to initialize and submit ACMS\$MONITOR.COM to batch. To run ACMS\$START_MONITOR, you must use an account that has the following default privileges: TMPMBX, NETMBX, WORLD, and SYSPRV. It is recommended that you set the CLISYMTBL system parameter to the maximum value with the OpenVMS SYSGEN utility when you run ACMS\$MONITOR.COM on your system. ACMS\$START_MONITOR.COM prompts you for the batch queue on which ACMS\$MONITOR.COM runs. You must enter a queue that is on the current node, because the monitor must run on the same node as the start procedure.

ACMS\$START_MONITOR.COM prompts for parameters that determine the configuration of ACMS\$MONITOR.COM. After you answer the prompts, ACMS\$START_MONITOR.COM displays the user input and asks if you are satisfied. If you are not satisfied with the input, the procedure offers the choice of continuing or quitting. If you continue, the procedure repeats all the questions; otherwise, the procedure ends. Once you are satisfied with the input, ACMS\$START_MONITOR.COM writes the answers to SYS\$MANAGER:ACMS\$MONITOR_INIT.DAT. ACMS\$START_MONITOR.COM creates ACMS\$MONITOR_INIT.DAT the first time it runs, supplying default

Setting ACMS Quotas, Parameters, and Privileges

10.2 Calculating Parameters and Quotas with ACMSPARAM.COM

answers for the prompts. Thereafter, the values supplied by the user are stored in ACMS\$MONITOR_INIT.DAT and become the defaults for the next running of ACMS\$START_MONITOR.COM.

ACMS\$MONITOR.COM stops automatically at the time specified by the END_TIME parameter. You can stop ACMS\$MONITOR.COM before that time by running SYS\$MANAGER:ACMS\$STOP_MONITOR.COM, regardless of the END_TIME parameter value. Table 10–2 describes the ACMS\$START_MONITOR.COM parameters.

Table 10–2 ACMS\$START_MONITOR.COM Parameters

Parameter	
INTERVAL	
<i>Description:</i>	The sampling interval between data collection events, specified in minutes.
<i>Default:</i>	15 minutes
START_TIME	
<i>Description:</i>	The time that ACMS\$MONITOR begins running, specified as absolute time, delta time, or a combination.
<i>Default:</i>	Immediately
END_TIME	
<i>Description:</i>	The time that ACMS\$MONITOR stops running, specified as absolute time, delta time, or a combination.
<i>Default:</i>	The monitor runs until stopped by the user by running ACMS\$STOP_MONITOR.COM.
QUEUE	
<i>Description:</i>	The batch queue on which ACMS\$MONITOR is entered.
<i>Default:</i>	node\$BATCH
REPORT_MAIL_USERNAME	
<i>Description:</i>	User name to receive mail containing the parameter/quota warning reports generated by ACMS\$MONITOR when ACMS system parameters or process quotas approach the limits set by QUOTA_THRESHOLD and POOL_THRESHOLD.
<i>Default:</i>	SYSTEM
REPORT_FREQUENCY	
<i>Description:</i>	The interval at which the warning report is mailed: Once every 24 hours (if the threshold was exceeded during the 24 hours) at a time specified by the user, or immediately at every data collection event during which the threshold was exceeded. Enter either DAILY or IMMEDIATELY at the prompt.
<i>Default:</i>	IMMEDIATELY

(continued on next page)

Setting ACMS Quotas, Parameters, and Privileges

10.2 Calculating Parameters and Quotas with ACMSPARAM.COM

Table 10–2 (Cont.) ACMS\$START_MONITOR.COM Parameters

Parameter	
REPORT_SEND_TIME	<p><i>Description:</i> The time that the daily report is mailed, if you choose the daily option for REPORT_FREQUENCY. The report is mailed only if any quotas or pools exceeded their thresholds in the previous 24 hours.</p> <p><i>Default:</i> 08:00</p>
QUOTA_THRESHOLD	<p><i>Description:</i> Highest percentage of a quota that can be used before the application manager is notified of a possible resource shortage. The threshold must be an integer between 1 and 100, inclusive.</p> <p><i>Default:</i> 80</p>
POOL_THRESHOLD	<p><i>Description:</i> Highest percentage of used bytes in a pool that can be used before the application manager is notified of a possible resource shortage. The threshold must be an integer between 1 and 100, inclusive.</p> <p><i>Default:</i> 80</p>

Once ACMS\$MONITOR.COM starts, it collects information at the interval specified by ACMS\$START_MONITOR.COM in ACMS\$MONITOR_INIT.DAT. ACMS\$MONITOR.COM stores information in three files:

- **SYS\$MANAGER:ACMS\$FEEDBACK.DAT**
This file contains the information about the running ACMS system for ACMSPARAM.COM, such as the number and size of concurrently running applications, and the number of concurrent local and remote users. This is the same information supplied by the user if you use ACMSPARAM.COM in INITIAL mode. See Section 10.2.1 for a full description of this information.
- **SYS\$MANAGER:ACMS\$MONITOR_STATS.TXT**
For each ACMS process, this report provides the following information:
 - Process name, including a string that identifies it as one of the following types: ACC, TSC, QTI, CP, ATL, EXC, SP, ACMS_SWL
 - Process user name
 - Process ID
 - Application name (for EXC)
 - SYSUAF quota name, quota limit, current quota value, used quota percentage, quota usage average, and quota usage peak for these quotas: PRCLM, FILLM, BIOLM, DIOLM, ASTLM, TQLM, ENQLM, BYTLM, PGFLQUOTA, WSEXTENT
 - Workspace pool name, pool size, used bytes, used bytes percentage and average, and the peak bytes used for the task instance and group and user workspace pools: WSC_POOLSIZE, WS_POOLSIZE, TWSC_POOLSIZE, and TWS_POOLSIZE.

Setting ACMS Quotas, Parameters, and Privileges

10.2 Calculating Parameters and Quotas with ACMSPARAM.COM

Report supplies the following information for the ACMS message switch shared and process pools:

- MSS pool name
- Pool size
- Current bytes used
- Used byte percentage
- Average bytes used
- Peak bytes used

The report lists the current, average, and peak:

- Number of remote nodes
 - Number of concurrently active applications
 - Value for the sum of the sizes of concurrently active applications
 - Number of concurrent local users
 - Number of concurrent remote users
- **SY\$MANAGER:ACMS\$MONITOR_WARNING.TXT**

ACMS\$MONITOR.COM calculates the pool and quota usage for the ACMS system and application. If the used byte percentage is greater than specified in the `POOL_THRESHOLD` parameter, the procedure writes the information to the warning report. Similarly, if the quota usage is greater than specified in the `QUOTA_THRESHOLD` parameter, the procedure issues a warning.

When ACMS\$MONITOR.COM issues a warning report, run ACMSPARAM.COM again to recalculate the system parameters. A warning report is created when:

 - A change to the ACMS system requires that ACMSPARAM.COM be rerun to update the variable information.
 - Pool or quota thresholds are exceeded, even if ACMSPARAM.COM correctly calculated the required values. In this case, if you are sure that the calculation is correct, increase the threshold so that you no longer get reports. If you believe that the calculation is incorrect, increase the parameter or quota manually: use `AUTHORIZE` to increase a process quota, or specify a higher value for the parameter in `ACMVARINI.DAT`. Then run all phases of ACMSPARAM.COM. Rerunning ACMSPARAM.COM with higher values may cause other parameters and quotas to be raised. Note that ACMSPARAM.COM never lowers a value for a process quota or an OpenVMS system parameter; however, it may lower an ACMS system parameter.

If any parameters or quotas are in danger of being exceeded, ACMS\$MONITOR.COM mails a report to the user name set in the `REPORT_MAIL_USERNAME` parameter. The procedure issues the warning report as specified in the `REPORT_FREQUENCY` parameter of `ACMS$START_MONITOR.COM` (`DAILY` or `IMMEDIATELY`).

For quotas that exceed `QUOTA_THRESHOLD`, the following are reported:

 - Process name, process ID, and process user name
 - Quota name

Setting ACMS Quotas, Parameters, and Privileges

10.2 Calculating Parameters and Quotas with ACMSPARAM.COM

- Current quota value
- Quota limit
- Percentage of quota limit that is used

For pool parameters that exceed POOL_THRESHOLD, the following are reported:

- Process name, process ID, and process user name
- Pool parameter name
- Current poolsize value
- Application name (for EXC processes)
- Poolsize limit
- Percentage of poolsize limit used

10.2.2.2 Editing ACMVARINI.DAT to Supply Variables to ACMSPARAM.COM

Normally, you run ACMSPARAM.COM in INITIAL or FEEDBACK mode to gather variable values for calculating parameters and quotas. If you use INITIAL mode, the variable values for which you are prompted are used directly in GENVAR phase. If you use FEEDBACK mode, the variable values that are stored in ACMS\$FEEDBACK.DAT are used by the GENVAR phase.

However, you can create ACMVARINI.DAT and edit in variable values to override values otherwise gathered by INITIAL mode or FEEDBACK mode (or gathered in the GENVAR phase from the ACMS database files). If the ACMVARINI.DAT file does not exist, you can create and modify it by following these steps:

1. On an active ACMS system, set your default to SYS\$MANAGER and run the GENVAR phase of ACMSPARAM.COM:

```
$ @ACMSPARAM.COM GENVAR
```

This command creates the file ACMSVAR.DAT that has ACMS default values assigned to all of the variables shown in Table 10–3. The table contains the variable names and their descriptions.

2. Rename ACMSVAR.DAT, the file containing the variable values, to ACMVARINI.DAT:

```
$ RENAME ACMSVAR.DAT ACMVARINI.DAT
```

3. When the GENVAR phase creates the ACMSVAR.DAT file in step 1, it includes all the variables listed in Table 10–3 and generates a default value for each. It is recommended that you delete any variables whose value you do not need to change.

Example 10–1 shows an edited ACMVARINI.DAT file. Each line in the figure contains a new value. All other lines have been deleted. When you edit ACMVARINI.DAT, you can also include variables that map directly to ACMMSGEN parameters but are not used by ACMSPARAM.COM to calculate the parameters. The following ACMMSGEN parameters are not calculated by ACMSPARAM.COM:

```
ACC_PRIORITY  
TSC_PRIORITY  
CP_PRIORITY  
QTL_PRIORITY  
PERM_CPS  
MIN_CPIS
```

Setting ACMS Quotas, Parameters, and Privileges

10.2 Calculating Parameters and Quotas with ACMSPARAM.COM

```
USERNAME_DEFAULT  
NODE_NAME  
MSS_NET_RETRY_TIMER  
QTI_POLLING_TIMER  
QTI_SUB_TIMEOUT  
QTI_RETRY_TIMER
```

Although the ACMSPARAM.COM procedure does not need these parameters to perform its calculations, ACMSPARAM.COM propagates these parameters through the GENVAR and GENPAR phases and set them in the WRITEPAR phase.

Example 10–1 Modified Variable Values in the ACMVARINI.DAT File

```
APPL_CNT = 10  
TERMINAL_CNT = 64  
ADB_BLKs = 48 + 3 + 12 + 9  
TDB_CNT = 12 + 2 + 3 + 2  
TDB_BLKs = 400 + (15 + 45) + (15 + 45 + 33) + (15 + 27)  
CONTROLLED_TERMINAL_CNT = 0  
APPL_NAME := payroll
```

Table 10–3 describes the variables listed in a complete ACMVARINI.DAT file and required by ACMSPARAM.COM. The table lists the SYSGEN parameters and ACMS process quotas whose calculations are affected, in part or in whole, by these variables when used by ACMSPARAM.COM.

Table 10–3 also lists the ACMMSGEN parameters corresponding to the variables in ACMVARINI.DAT. You can set these parameters independently in ACMMSGEN. However, it is advisable to use ACMSPARAM.COM to set these parameters, because the command procedure automatically modifies any other parameters relating to the parameters you changed.

For most variables, ACMSPARAM.COM obtains an accurate value from feedback, user answers, or the ACMS database files. However, some variables cannot be calculated automatically, so they are given a reasonable default value which is accurate for an average system. After running the GENVAR phase, check the ACMSSVAR.DAT file to verify that the values are accurate for your system. If the defaults do not accurately reflect your system, edit ACMVARINI.DAT and rerun ACMSPARAM.COM. The variables for which neither INITIAL nor FEEDBACK supplies a value are:

```
ACC_USERNAME  
AGENT_CNT  
CP_USERNAME  
CP_PROC_CNT  
DBMS_SERVER_CNT
```

Setting ACMS Quotas, Parameters, and Privileges

10.2 Calculating Parameters and Quotas with ACMSPARAM.COM

DEBUGGER_CNT
 OPERATOR_CNT
 REMOTE_AGENT_CNT
 QTI_USERNAME
 TSC_USERNAME

Table 10–3 Variables Required for ACMSPARAM.COM

Variable	
ACC_USERNAME	<p><i>Description:</i> Maps to the ACMSGEN parameter which defines the OpenVMS username of the ACMS Central Controller (ACC). The name must be enclosed in quotes or be assigned the DCL string operator “:=”.</p> <p><i>Default:</i> ACMS\$ACC</p> <p><i>Affects:</i> ACMSGEN parameter ACC_USERNAME ACC user name entry in the system authorization file</p>
ADB_BLKs	<p><i>Description:</i> Total size in blocks of the application database (.ADB) files of applications in use at the same time on the local system.</p> <p><i>Default:</i> Feedback data, or total size of .ADB files for applications listed in APPL_NAME.</p> <p><i>Affects:</i> SYSGEN parameter GBLPAGES</p>
AGENT_CNT	<p><i>Description:</i> Number of agent processes other than the ACMS Command Process (CP) and the QTI running on the local node. This includes the number of ALL-IN-1 processes selecting tasks in ACMS applications, the number of Request Interface (RI) agents, the number of EXCs executing detached tasks, and any customer-supplied agents.</p> <p><i>Default:</i> 2</p> <p><i>Affects:</i> ACMSGEN parameter MSS_MAXOBJ</p>
AGENT_SUB_CNT	<p><i>Description:</i> Number of users selecting tasks in ACMS applications from agent processes other than the ACMS Command Process (CP) and the QTI. This includes users selecting tasks in ACMS applications from ALL-IN-1, from Request Interface (RI) agents, and from any customer-supplied agents. This also includes the number of detached tasks executing at any one time.</p> <p><i>Default:</i> 10</p> <p><i>Affects:</i> ACMSGEN parameter MSS_MAXOBJ</p>

(continued on next page)

Setting ACMS Quotas, Parameters, and Privileges

10.2 Calculating Parameters and Quotas with ACMSPARAM.COM

Table 10–3 (Cont.) Variables Required for ACMSPARAM.COM

Variable	
APPL_CNT	<p><i>Description:</i> Maps to the ACMSGEN parameter which defines the maximum number of applications started on the local system at one time.</p> <p><i>Default:</i> Feedback data, or number of applications listed in APPL_NAME</p> <p><i>Affects:</i> ACMSGEN parameters MAX_APPL and MSS_MAXOBJ SYSGEN parameter GBLSECTIONS ACC process quotas FILLM and PGFLQUOTA</p>
APPL_NAME	<p><i>Description:</i> Names of the applications started on the local system. Supply the APPL_NAME variable once for each application that will be started on the local system. The application name must be enclosed in quotes or be assigned using the DCL string operator “:=”.</p> <p><i>Default:</i> Feedback data, or names of applications prompted for in INITIAL mode.</p> <p><i>Affects:</i> ACMSGEN parameters MAX_APPL and MSS_MAXOBJ SYSGEN parameter GBLSECTIONS ACC process quotas FILLM and PGFLQUOTA</p>
CONTROLLED_TERMINAL_CNT	<p><i>Description:</i> Number of terminals defined as ACMS-controlled in the ACMS Device Definition file (ACMSDDF.DAT).</p> <p><i>Default:</i> Number of terminals defined as ACMS-controlled in the ACMS Device Definition file (ACMSDDF.DAT).</p> <p><i>Affects:</i> SYSGEN parameter CHANNELCNT TSC process quota FILLM</p>
CP_PROC_CNT	<p><i>Description:</i> Maps to the ACMSGEN parameter which defines the maximum number of terminal user command processes (CPs) that can be started on the system at one time.</p> <p><i>Default:</i> TERMINAL_CNT/TERMINALS_PER_CP</p> <p><i>Affects:</i> ACMSGEN parameters CP_SLOTS and MSS_MAXOBJ SYSGEN parameter LOCKIDTBL and CHANNELCNT TSC process quota TQELM</p>
CP_USERNAME	<p><i>Description:</i> Maps to the ACMSGEN parameter which defines the OpenVMS user name of the ACMS Command Process (CP). The name must be enclosed in quotes or be assigned using the DCL string operator “:=”.</p> <p><i>Default:</i> ACMS\$CP</p> <p><i>Affects:</i> ACMSGEN parameter CP_USERNAME CP user name entry in the system authorization file</p>

(continued on next page)

Setting ACMS Quotas, Parameters, and Privileges

10.2 Calculating Parameters and Quotas with ACMSPARAM.COM

Table 10–3 (Cont.) Variables Required for ACMSPARAM.COM

Variable	
DEBUGGER_CNT	<p><i>Description:</i> The maximum number of developers debugging task groups at the same time</p> <p><i>Default:</i> 5</p> <p><i>Affects:</i> ACMSGEN parameter MSS_MAXOBJ SYSGEN parameters CHANNELCNT, GBLPAGES, GBLPAGFIL, GBLSECTIONS</p>
DEBUG_TDB_BLKs	<p><i>Description:</i> Total size in blocks of task group database files (.TDB) that can be debugged by developers at one time.</p> <p><i>Default:</i> (Size of largest .TDB * DEBUGGER_CNT)</p> <p><i>Affects:</i> SYSGEN parameter GBLPAGES</p>
DYN_SP_CNT	<p><i>Description:</i> The maximum number of server processes having DYNAMIC USERNAME that can be started on the local system at any one time.</p> <p><i>Default:</i> 2 * APPL_CNT</p> <p><i>Affects:</i> SYSGEN parameter LOCKIDTBL</p>
ENTERED_TERMINAL_CNT	<p><i>Description:</i> Total number of terminals signing in to ACMS with ACMS/ENTER.</p> <p><i>Default:</i> TERMINAL_CNT - CONTROLLED_TERMINAL_CNT</p> <p><i>Affects:</i> SYSGEN parameter CHANNELCNT TSC process quota TQELM</p>
ESC_RTN_IMAGE_CNT	<p><i>Description:</i> Number of all DECforms escape routine images used by all local applications.</p> <p><i>Default:</i> 5</p> <p><i>Affects:</i> SYSGEN parameter CHANNELCNT CP process quota FILLM</p>
FORM_BLKs	<p><i>Description:</i> The total size in blocks of DECforms form files used by applications started on the local system or accessed remotely at any one time. This includes both .FORM files and .EXE files containing forms. Add the size of a form file once for each different application that refers to it.</p> <p><i>Default:</i> Size of .FORM and .EXE form files referred to by local applications, plus the size of .FORM and .EXE form files in ACMS\$FORM_CACHE.</p> <p><i>Affects:</i> CP process quota PGFLQUOTA</p>

(continued on next page)

Setting ACMS Quotas, Parameters, and Privileges

10.2 Calculating Parameters and Quotas with ACMSPARAM.COM

Table 10–3 (Cont.) Variables Required for ACMSPARAM.COM

Variable	
FORM_CNT	<p><i>Description:</i> The total number of DECforms form files used by applications started on the local system or accessed remotely at any one time. This includes .FORM files and .EXE files containing forms. Count a form file once for each different application that refers to it.</p> <p><i>Default:</i> Number of .FORM and .EXE form files referred to by local applications, plus the number of .FORM and .EXE form files in ACMS\$FORM_CACHE.</p> <p><i>Affects:</i> SYSGEN parameter CHANNELCNT CP process quota FILLM</p>
FORM_TRACE_FILE_CNT	<p><i>Description:</i> Number of concurrently active DECforms trace files.</p> <p><i>Default:</i> FORM_CNT</p> <p><i>Affects:</i> SYSGEN parameter CHANNELCNT</p>
LARGEST_MESSAGE	<p><i>Description:</i> Size of the largest message sent from an application to the local CP (or other agent) during exchange step processing. LARGEST_MESSAGE differs from MSS_MAXBUF in that it includes only the workspace data portion of the message. If the applications are not distributed, do not use the Request Interface (RI); and use only TDMS request I/O, then LARGEST_MESSAGE is not required.</p> <p><i>Default:</i> Largest message used on any exchange step in the application (determined from ADU DUMP GROUP).</p> <p><i>Affects:</i> ACMSGEN parameter MSS_MAXBUF CP process quota PGFLQUOTA</p>
LARGEST_MESSAGE_NUM_WKSP	<p><i>Description:</i> Number of workspaces passed in the largest remote request message.</p> <p><i>Default:</i> Number of workspaces passed in the exchange step with the largest message.</p> <p><i>Affects:</i> ACMSGEN parameter MSS_MAXBUF</p>
MDB_BLKs	<p><i>Description:</i> Total size (in blocks) of all the different menu database (.MDB) files in use at one time. This includes the default menu database (ACMS.MDB), the ACMS command menu database (ACMSCMD.MDB), and all site-defined menu databases.</p> <p><i>Default:</i> Sum of the sizes of all menu databases referred to in the ACMS User Definition file (ACMSUDF.DAT), plus the sizes of ACMS.MDB and ACMSCMD.MDB.</p> <p><i>Affects:</i> SYSGEN parameter GBLPAGES CP process quota PGFLQUOTA</p>

(continued on next page)

Setting ACMS Quotas, Parameters, and Privileges

10.2 Calculating Parameters and Quotas with ACMSPARAM.COM

Table 10–3 (Cont.) Variables Required for ACMSPARAM.COM

Variable	
MDB_CNT	<p><i>Description:</i> Total number of all the different menu database (.MDB) files in use at one time. This includes the default menu database (ACMS.MDB), the ACMS command menu database (ACMSCMD.MDB), and all site-defined menu databases.</p> <p><i>Default:</i> Number of menu databases referred to in the ACMS User Definition file (ACMSUFD.DAT), plus ACMS.MDB and ACMSCMD.MDB.</p> <p><i>Affects:</i> SYSGEN parameter GBLSECTIONS ACC process quota FILLM</p>
MSS_MAXBUF	<p><i>Description:</i> Maps to the ACMSGEN parameter which defines the largest message that can be sent between ACMS processes without incurring message blocking. Message blocking can have an adverse affect on performance, especially on distributed systems.</p> <p><i>Default:</i> Calculated value (see Appendix A)</p> <p><i>Affects:</i> ACMSGEN parameters MSS_MAXBUF, MSS_POOLSIZE, and MSS_PROCESS_POOL ACC, CP, and QTI process quotas BYTLM and PGFLQUOTA</p>
MSS_MAXOBJ	<p><i>Description:</i> The maximum number of message switch objects that can be created on the system at one time. Message switch objects are used for communications between ACMS processes. There are a number of message switch objects for each ACMS process, plus one message switch object for each ACMS task submitter.</p> <p><i>Default:</i> Calculated value (see Appendix A)</p> <p><i>Affects:</i> ACMSGEN parameter MSS_MAXOBJ and MSS_POOLSIZE</p>
MSS_PROCESS_POOL	<p><i>Description:</i> Maps to the ACMSGEN parameter MSS_PROCESS_POOL which defines the size of the communication pool used in each ACMS process. The MSS process pool is used for sending and receiving messages in both local and remote communications. The required value of MSS_PROCESS_POOL depends on the amount of ACMS activity on the system.</p> <p><i>Default:</i> Calculated value (see Appendix A)</p> <p><i>Affects:</i> ACMSGEN parameter MSS_PROCESS_POOL ACC, CP, TSC, and QTI process quota PGFLQUOTA</p>

(continued on next page)

Setting ACMS Quotas, Parameters, and Privileges

10.2 Calculating Parameters and Quotas with ACMSPARAM.COM

Table 10–3 (Cont.) Variables Required for ACMSPARAM.COM

Variable	
MSS_SHARED_POOL	<p><i>Description:</i> Maps to the ACMMSGEN parameter MSS_POOLSIZ which defines the size of the MSS shared pool global section. The MSS shared pool is used for sending and receiving messages in local communications. The required value of MSS_POOLSIZ depends on the amount of ACMS activity on the system.</p> <p><i>Default:</i> Calculated value (see Appendix A)</p> <p><i>Affects:</i> ACMMSGEN parameter MSS_POOLSIZ SYSGEN parameters GBLPAGES and GBLPAGFIL</p>
OPERATOR_CNT	<p><i>Description:</i> Number of users issuing ACMS operator commands (such as ACMS/SHOW, ACMS/START, and so forth) at the same time.</p> <p><i>Default:</i> 5</p> <p><i>Affects:</i> ACMMSGEN parameter MSS_POOLSIZ and MSS_MAXOBJ ACC process quota ASTLM</p>
OPR_ENTER_RETURN_CNT	<p><i>Description:</i> Number of users who entered ACMS using the ACMS/ENTER/RETURN command, which is the default command to enter ACMS. In other words, the user did not type ACMS/ENTER/NORETURN.</p> <p><i>Default:</i> 5</p> <p><i>Affects:</i> ACMMSGEN parameter MSS_MAXOBJ</p>
QTI_MAX_WSP_SIZE	<p><i>Description:</i> The largest value associated with the ACMSQUEMGR qualifier /MAX_WORKSPACES_SIZE for all queues started on the local system. QTI_MAX_WSP_SIZE is used to calculate appropriate process quotas for the ACMS Queued Task Initiator (QTI).</p> <p><i>Default:</i> Largest value defined for a queue in the ACMS Queue Definition File (ACMSQDF.DAT), or 512 if no queues are defined.</p> <p><i>Affects:</i> QTI process quota PGFLQUOTA</p>
QTI_QUEUES	<p><i>Description:</i> The maximum number of queues and error queues active on the local system at the same time. QTI_QUEUES is used to calculate appropriate process quotas for the ACMS Queued Task Initiator (QTI).</p> <p><i>Default:</i> Total number of queues defined in the ACMS Queue Definition File (ACMSQDF.DAT), or 3 if no queues are defined.</p> <p><i>Affects:</i> SYSGEN parameter LOCKIDTBL QTI process quotas ASTLM, BYTLM, ENQLM, FILLM, PGFLQUOTA</p>

(continued on next page)

Setting ACMS Quotas, Parameters, and Privileges

10.2 Calculating Parameters and Quotas with ACMSPARAM.COM

Table 10–3 (Cont.) Variables Required for ACMSPARAM.COM

Variable	
QTI_SUBMITTERS	<p><i>Description:</i> The maximum number of task submitters signed in to ACMS by the ACMS Queued Task Initiator (QTI) at any one time. Set QTI_SUBMITTERS to the maximum number of different user names enqueueing tasks to active queues.</p> <p><i>Default:</i> Feedback data, or 10</p> <p><i>Affects:</i> ACMSGEN parameter MSS_MAXOBJ QTI process quotas ASTLM and PGFLQUOTA</p>
QTI_TASK_THDS	<p><i>Description:</i> The maximum number of concurrent active tasks that will be processed by the ACMS Queued Task Initiator (QTI). Set QTI_TASK_THDS to the sum of task threads specified on the /TASK_THREADS qualifier for all active queues.</p> <p><i>Default:</i> Feedback data or 3</p> <p><i>Affects:</i> SYSGEN parameter LOCKIDTBL QTI process quotas ASTLM, BIOLM, DIOLM, ENQLM, PGFLQUOTA, TQELM, WSDEFAULT, WSQUOTA, and WSEXTENT</p>
QTI_USERNAME	<p><i>Description:</i> Maps to the ACMSGEN parameter which defines the OpenVMS user name of the ACMS Queued Task Initiator (QTI). The name must be enclosed in quotes or be assigned using the DCL string operator “:=”.</p> <p><i>Default:</i> ACMS\$QTI</p> <p><i>Affects:</i> ACMSGEN parameter QTI_USERNAME QTI user name entry in the system authorization file</p>
REMOTE_AGENT_CNT	<p><i>Description:</i> Number of remote agent processes submitting tasks to applications running on the local system at any one time. This includes both ACMS Command Processes (CPs) and any other agents (RI, ALL-IN-1, user-written) submitting tasks from remote systems.</p> <p><i>Default:</i> 2 * APPL_CNT</p> <p><i>Affects:</i> SYSGEN parameter MSS_PROCESS_POOL</p>
REMOTE_APPL_CNT	<p><i>Description:</i> Number of applications running on remote systems in which task submitters on this node select tasks.</p> <p><i>Default:</i> Feedback data, or number of remote applications listed in REMOTE_APPL_NAME.</p> <p><i>Affects:</i> ACMSGEN parameter MSS_PROCESS_POOL ACC process quota ASTLM, FILLM, and PGFLQUOTA; CP process quotas ASTLM, FILLM, BIOLM, and BYTLM; QTI process quotas FILLM and BYTLM</p>

(continued on next page)

Setting ACMS Quotas, Parameters, and Privileges

10.2 Calculating Parameters and Quotas with ACMSPARAM.COM

Table 10–3 (Cont.) Variables Required for ACMSPARAM.COM

Variable	
REMOTE_APPL_NAME	<p><i>Description:</i> Names of the applications on remote systems in which task submitters on this node select tasks. Supply the REMOTE_APPL_NAME variable once for each application that will be accessed remotely from the local system. Specify applications using the form <node-name>:<application-name>. The name must be enclosed in quotes or be assigned using the DCL string operator “:=”.</p> <p><i>Default:</i> Feedback date, or user-supplied names of remote applications.</p> <p><i>Affects:</i> None directly (used to generate REMOTE_APPL_CNT and REMOTE_NODE_CNT variables)</p>
REMOTE_NODE_CNT	<p><i>Description:</i> Number of remote ACMS systems that access the local ACMS system, or are accessed by the local ACMS system. This includes remote systems running applications that are accessed from the local system, and remote systems accessing applications running on the local system.</p> <p><i>Default:</i> Feedback data, or number of unique remote node names from REMOTE_APPL_NAME.</p> <p><i>Affects:</i> ACC process quotas ASTLM, BYTLM, BIOLM, FILLM, and PGFLQUOTA</p>
REMOTE_RLB_BLKs	<p><i>Description:</i> Total size (in blocks) of request library (.RLB) files used by applications accessed remotely from the local system at any one time. Add the size of a request library once for each different remote application that references it.</p> <p><i>Default:</i> Feedback data, or the size of .RLB files in ACMS\$RLB_CACHE.</p> <p><i>Affects:</i> CP process quota PGFLQUOTA</p>
REMOTE_RLB_CNT	<p><i>Description:</i> Total number of request library (.RLB) files used by applications accessed remotely from the local system at any one time. Count a request library once for each different remote application that references it.</p> <p><i>Default:</i> Feedback data, or the number of .RLB files in ACMS\$RLB_CACHE.</p> <p><i>Affects:</i> SYSGEN parameter CHANNELCNT CP process quota FILLM</p>
REMOTE_SUB_CNT	<p><i>Description:</i> Number of submitters on remote systems who will be selecting tasks in applications running on the local system.</p> <p><i>Default:</i> REMOTE_NODE_CNT * 20</p> <p><i>Affects:</i> ACMSGEN parameters WSC_POOLSIZE and WS_POOLSIZE SYSGEN parameter CHANNELCNT ACC process quotas ASTLM and BYTLM</p>

(continued on next page)

Setting ACMS Quotas, Parameters, and Privileges

10.2 Calculating Parameters and Quotas with ACMSPARAM.COM

Table 10–3 (Cont.) Variables Required for ACMSPARAM.COM

Variable	
RLB_CNT	<p><i>Description:</i> Total number of request library (.RLB) files used by applications started on the local system at any one time. Count a request library once for each different application that references it. (Formerly EXC_RLB_CNT)</p> <p><i>Default:</i> Number of .RLB files referenced by task groups in local applications (from ADU DUMP GROUP).</p> <p><i>Affects:</i> SYSGEN parameters CHANNELCNT and LOCKIDTBL</p>
TDB_BLKs	<p><i>Description:</i> Total size (in blocks) of task group database (.TDB) files used by applications started on the local system. Add the size of a task group database once for each different application that references it.</p> <p><i>Default:</i> Sum of sizes of .TDB files referred to by local applications.</p> <p><i>Affects:</i> SYSGEN parameter GBLPAGES</p>
TDB_CNT	<p><i>Description:</i> Total number of task group database (.TDB) files used by applications started on the local system. Count a task group database once for each different application that refers to it.</p> <p><i>Default:</i> Number of .TDB files referred to by local applications (from ADU DUMP APPLICATION).</p> <p><i>Affects:</i> ACMSGEN parameter WSC_POOLSIZE SYSGEN parameters CHANNELCNT, GBLPAGES, GBLPAGFIL and GBLSECTIONS</p>
TERMINAL_CNT	<p><i>Description:</i> Maps to the ACMSGEN parameter which defines the maximum number of ACMS users that can be signed into ACMS through the terminal subsystem (TSC and CPs) at any one time.</p> <p><i>Default:</i> Feedback data, or the number of devices defined in ACMSDDF.DAT if \$ALL is not defined, or the number of TT, RT, LT, WT, VT and OP devices on the system.</p> <p><i>Affects:</i> ACMSGEN parameters MAX_LOGINS, WSC_POOLSIZE, WS_POOLSIZE, CP_SLOTS SYSGEN parameter CHANNELCNT TSC process quotas ASTLM, BIOLM, BYTLM, PGFLQUOTA and TQELM</p>

(continued on next page)

Setting ACMS Quotas, Parameters, and Privileges

10.2 Calculating Parameters and Quotas with ACMSPARAM.COM

Table 10–3 (Cont.) Variables Required for ACMSPARAM.COM

Variable	
TERMINALS_PER_CP	<p><i>Description:</i> Maps to the ACMSGEN parameter which defines the maximum number of terminals handled by one Command Process (CP).</p> <p><i>Default:</i> 20</p> <p><i>Affects:</i> ACMSGEN parameters MAX_TTS_CP, MSS_MAXOBJ, and CP_SLOTS</p> <p>SYSGEN parameter CHANNELCNT</p> <p>CP process quotas FILLM, DIOLM, BIOLM, BYTLM, ASTLM, ENQLM, PGFLQUOTA, TQELM, WSDEFAULT, WSQUOTA and and WSEXTENT</p>
TOTAL_SP_CNT	<p><i>Description:</i> The maximum number of server processes that can be started on the local system at any one time.</p> <p><i>Default:</i> Sum of MAXIMUM SERVER PROCESSES from .ADB files, or 5 times the total number of servers defined in local applications (if maximum server process is UNLIMITED).</p> <p><i>Affects:</i> ACMSGEN parameter MSS_MAXOBJ</p>
TOTAL_TK_INSTANCE_CNT	<p><i>Description:</i> Total number of tasks running concurrently for all applications.</p> <p><i>Default:</i> Sum of MAXIMUM TASK INSTANCES from .ADB files.</p> <p><i>Affects:</i> ACMSGEN parameters MSS_POOLSIZE, TWS_POOLSIZE, TWSC_POOLSIZE,</p>
TSC_USERNAME	<p><i>Description:</i> Maps to the ACMSGEN parameter TSC_USERNAME which defines the OpenVMS user name of the ACMS Terminal Subsystem Controller (TSC). The name must be enclosed in quotes or be assigned using the DCL string operator “:=”.</p> <p><i>Default:</i> ACMS\$TSC</p> <p><i>Affects:</i> ACMSGEN parameter TSC_USERNAME</p> <p>TSC user name in the system authorization file</p>
TWS_POOLSIZE	<p><i>Description:</i> Variable that maps to the ACMSGEN parameter TWS_POOLSIZE which defines the size of pools in which workspaces associated with active task instances are stored. There is one task instance workspace pool for each task group in an application. The required value of TWS_POOLSIZE depends on the number of tasks in each group that will be executing concurrently, and the size of workspaces used by those tasks.</p> <p><i>Default:</i> Calculated value (see Appendix A)</p>

(continued on next page)

Setting ACMS Quotas, Parameters, and Privileges

10.2 Calculating Parameters and Quotas with ACMSPARAM.COM

Table 10–3 (Cont.) Variables Required for ACMSPARAM.COM

Variable	
TWSC_POOLSIZE	<p><i>Affects:</i> ACMSGEN parameter TWS_POOLSIZE SYSGEN parameters GBLPAGES and GBLPAGFIL</p> <p><i>Description:</i> Variable that maps to the ACMSGEN parameter TWSC_POOLSIZE which defines the size of pools used for control information for task instance workspaces. There is one control pool for each task instance workspace pool. The required value of TWSC_POOLSIZE depends on the number of tasks in each group that will be executing concurrently, and the number of workspaces used by those tasks.</p> <p><i>Default:</i> Calculated value (see Appendix A)</p> <p><i>Affects:</i> ACMSGEN parameter TWSC_POOLSIZE SYSGEN parameters GBLPAGES and GBLPAGFIL</p>
WS_POOLSIZE	<p><i>Description:</i> Variable that maps to the ACMSGEN parameter WS_POOLSIZE which defines the size of the pool used for master copies of group and user workspaces. Each application is allocated one group/user workspace pool. The required value of WS_POOLSIZE depends on the number and size of group and user workspaces used by applications.</p> <p><i>Default:</i> Calculated value (see Appendix A)</p> <p><i>Affects:</i> ACMSGEN parameter WS_POOLSIZE SYSGEN parameters GBLPAGES and GBLPAGFIL</p>
WSC_POOLSIZE	<p><i>Description:</i> Variable that maps to the ACMSGEN parameter WSC_POOLSIZE which defines the size of the pool used for control information for group and user workspaces. There is one control pool for each group/user workspace pool. The required value of WSC_POOLSIZE depends on the number of group and user workspaces used by applications.</p> <p><i>Default:</i> Calculated value (see Appendix A)</p> <p><i>Affects:</i> ACMSGEN parameter WSC_POOLSIZE SYSGEN parameters GBLPAGES and GBLPAGFIL</p>

10.3 Calculating EXC Process Quotas with ACMEXCPAR.COM

The ACMEXCPAR.COM procedure performs these operations:

- Ensures that values for all variables necessary to calculate quotas are available in an initialization file created by you or by ACMEXCPAR.COM.
- Reads values from the initialization file.
- Calculates EXC quota values.
- Modifies the system user authorization file SYS\$SYSTEM:SYSUAF.DAT using the EXC quota values.

Setting ACMS Quotas, Parameters, and Privileges

10.3 Calculating EXC Process Quotas with ACMEXCPAR.COM

Always run ACMSPARAM.COM before you run ACMEXCPAR.COM. By so doing, ACMEXCPAR.COM uses the correct ACMSGEN parameter values, as set by ACMSPARAM.COM.

10.3.1 Running ACMEXCPAR.COM

ACMEXCPAR.COM accepts initial values from the <application-name>_GENVAR.DAT file, and modifies EXC quotas. ACMEXCPAR.COM is located in the SYS\$MANAGER directory. You need the SYSPRV privilege to run it. This section shows how to run ACMEXCPAR.COM.

Run ACMEXCPAR.COM as follows:

```
$ SET DEFAULT SYS$MANAGER
$ @ACMEXCPAR [phase] application-name
```

ACMEXCPAR.COM consists of four phases. You can run the command procedure as a whole, or run each phase independently. The four phases are:

- The FINDVAL phase creates a file, <application-name>_GENVAR.DAT, that contains initialization values for the ACMEXCPAR.COM procedure. The <application-name>_GENVAR.DAT file also contains the following ACMSGEN parameters: TWS_POOLSIZE, TWSC_POOLSIZE, WS_POOLSIZE, WSC_POOLSIZE, MSS_MAXBUF, MSS_PROCESS_POOL, and MAX_LOGINS, and the OpenVMS SYSGEN parameter MAXPROCESSCNT.
- The GENVAR phase checks to make sure that all the variables required for the GENPAR phase are in <application-name>_GENPAR.DAT.
- The GENPAR phase prompts you for a unique UIC for each ACMS account and calculates quota values for the EXC.
- The WRITEPAR phase reads the quota values created by the GENPAR phase and uses them to modify the system user authorization file, SYSUAF.DAT.

The phase parameter can also take the following input:

- ALL—Runs all four phases consecutively. ALL is the default.
- CURRENT—Runs the GENVAR, GENPAR, and WRITEPAR phases without running the FINDVAL phase. Use CURRENT when you want to use values previously gathered by FINDVAL, or manually edited in the command procedure's initialization file.
- HELP—You can invoke HELP as the first parameter to ACMEXCPAR.COM. If you do not specify a second parameter, you receive a help message for the entire ACMEXCPAR.COM procedure. Specify HELP as the first parameter to ACMEXCPAR.COM, followed by the name of a single phase as a second parameter to get a help message for that phase only. For example, for help on the GENPAR phase, specify:

```
$ @ACMEXCPAR HELP GENPAR
```

You can also get help for a particular variable by specifying the variable name as the second parameter. For example, to get help for the FORM_CNT variable, specify:

```
$ @ACMEXCPAR HELP FORM_CNT
```

Setting ACMS Quotas, Parameters, and Privileges

10.3 Calculating EXC Process Quotas with ACMEXCPAR.COM

You can run the entire command procedure or run the phases separately. You will usually want to run the entire command procedure at one time. However, sometimes you may want to run the phases one at a time and check the results before proceeding. For example, you may want to check the values placed by FINDVAL in <application-name>_GENVAR.DAT before running the rest of ACMEXCPAR.COM. To do so, run the FINDVAL phase as follows:

```
$ SET DEFAULT SYS$MANAGER
$ @ACMEXCPAR FINDVAL <application-name>
```

FINDVAL edits the <application-name>_GENVAR.DAT file or creates it (if it does not exist) and places variable values in the file. Edit the file, make any changes, and run the final three phases (GENVAR, GENPAR, and WRITEPAR) as follows:

```
$ @ACMEXCPAR CURRENT <application-name>
```

Using the CURRENT parameter invokes the GENVAR, GENPAR, and WRITEPAR phases consecutively.

The ACMEXCPAR procedure uses information in .ADB and .TDB database files, and ACMMSGEN parameters to set the initial variables, and puts them in <application-name>_GENVAR.DAT. The FINDVAL phase takes the application name you supply at the command line and appends “_GENVAR.DAT” to it. This file contains initialization values specific to the application you named.

See Table 10–4 for a summary of the four phases.

Figure 10–2 illustrates the interaction of the four phases of ACMEXCPAR.COM.

Figure 10–2 Setting EXC Process Quotas with ACMEXCPAR.COM

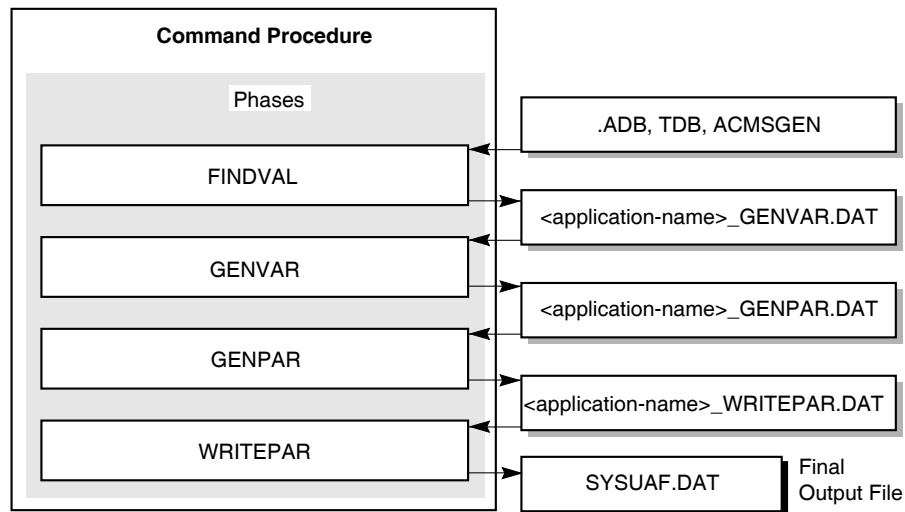

TAY-0147-AD

Before running ACMEXCPAR.COM, make sure that all logicals used in application and task definitions are defined. Otherwise, the procedure may fail.

Setting ACMS Quotas, Parameters, and Privileges

10.3 Calculating EXC Process Quotas with ACMEXCPAR.COM

Table 10–4 Phases of ACMEXCPAR.COM

Phase	Description
FINDVAL	<p><i>Input file:</i> None</p> <p><i>Output File:</i> SYS\$MANAGER:<application-name>_ GENVAR.DAT</p> <p><i>Function:</i> The FINDVAL phase performs the first phase of the ACMEXCPAR.COM procedure. FINDVAL creates a file, <application-name>_GENVAR.DAT, that contains initialization values for the ACMEXCPAR.COM procedure. These values are derived by running ACMSGEN and by using ADU to gather information from the application database and its task group databases. FINDVAL automatically derives the name of the output file from the application name that you supply when you invoke the FINDVAL command procedure. You can also directly create and edit the <application-name>_GENVAR.DAT file. See Section 10.3.2 to create the initialization file without using FINDVAL.</p>
GENVAR	<p><i>Input file:</i> SYS\$MANAGER:<application-name>_ GENVAR.DAT</p> <p><i>Output File:</i> SYS\$MANAGER: <application-name>_GENPAR.DAT</p> <p><i>Function:</i> The GENVAR phase performs the second phase of the ACMEXCPAR.COM procedure. GENVAR ensures that values are specified for all variables necessary to calculate EXC quotas. GENVAR automatically derives the names of the input and output files from the application name that you supply when you run the GENVAR command procedure.</p>
GENPAR	<p><i>Input file:</i> SYS\$MANAGER:<application-name>_ GENPAR.DAT</p> <p><i>Output File:</i> SYS\$MANAGER:<application-name>_ WRITEPAR.DAT</p> <p><i>Function:</i> The GENPAR phase performs the third phase of the ACMEXCPAR.COM procedure. GENPAR calculates quota values for the Application Execution Controller (EXC). The phase reads the variable values from <application-name>_GENPAR.DAT, calculates the quota values, and writes the values to the file <application-name>_WRITEPAR.DAT. GENPAR automatically derives the names of the input and output files from the application name you supply when you run the command procedure.</p>
WRITEPAR	<p><i>Input file:</i> SYS\$MANAGER:<application-name>_ WRITEPAR.DAT</p> <p><i>Output File:</i> SYS\$SYSTEM:SYSUAF.DAT</p> <p><i>Function:</i> The WRITEPAR phase performs the fourth phase of the ACMEXCPAR.COM procedure. WRITEPAR reads the quota values from <application-name>_WRITEPAR.DAT and uses them to modify the system user authorization file, SYSUAF.DAT. WRITEPAR derives the input file name from the application name you supply when you run the procedure.</p>

Setting ACMS Quotas, Parameters, and Privileges

10.3 Calculating EXC Process Quotas with ACMEXCPAR.COM

10.3.2 Supplying Variable Values for ACMEXCPAR.COM

ACMEXCPAR.COM requires initial variables to calculate the EXC process quota values needed to run ACMS. Table 10–5 lists these variables. The variables are stored in SYS\$MANAGER:<application-name>_GENVAR.DAT. ACMEXCPAR.COM derives the variable values by:

- Running ACMMSGEN to gather ACMMSGEN parameters.
- Using ADU to gather information from the .ADB file and its .TDB files.

Note

ACMSEXCPAR.COM does not support logical name search lists for TDB file specifications.

The two ways to gather the variables used to calculate EXC process quotas are:

- Run the ACMEXCPAR.COM FINDVAL phase. FINDVAL derives the variable values by running ACMMSGEN and reading from the application and task group databases. FINDVAL creates the file <application-name>_GENVAR.DAT.
- Copy the template file SYS\$MANAGER:ACMEXCPAR_GENVAR.DAT to SYS\$MANAGER:<application-name>_GENVAR.DAT. Then edit the file and use it for input to the FINDVAL phase rather than having FINDVAL derive the values as described earlier. This allows you to set values for several variables that FINDVAL would otherwise supply with defaults (AGENT_CNT, LOCAL_TDMS_TASK_CNT, REMOTE_AGENT_CNT, REMOTE_TK_INSTANCE_CNT). Example 10–2 shows a copy of the SYS\$MANAGER:ACMEXCPAR_GENVAR.DAT template.

Example 10–2 Variables in ACMEXCPAR_GENVAR.DAT Template

```
AGENT_CNT =
EXC_USERNAME :=
EXC_TK_INSTANCE_CNT =
EXC_RLB_CNT =
EXC_MSG_CNT =
EXC_TDB_CNT =
EXC_RLB_BLKs =
EXC_SERVER_CNT =
EXC_SP_CNT =
FORM_CNT =
LOCAL_TDMS_TASK_CNT =
REMOTE_AGENT_CNT =
REMOTE_TK_INSTANCE_CNT =
```

Section 10.3.1 describes how to run ACMEXCPAR.COM.

After you become familiar with your ACMS system, you might choose to modify EXC quotas by editing the input or output files of FINDVAL, GENVAR, GENPAR, and WRITEPAR and then running each phase individually. Section 10.3.3 describes this method of modifying parameters.

Setting ACMS Quotas, Parameters, and Privileges

10.3 Calculating EXC Process Quotas with ACMEXCPAR.COM

Table 10–5 describes the variables included in the <application-name>_GENVAR.DAT file and required by ACMEXCPAR.COM. The table lists the ACMS EXC process quotas whose calculations are affected, in part or in whole, by the variables from this file. Most of the variables are application-specific. ACMEXCPAR.COM determines these from information in the .ADB and .TDB database files.

Six variables in <application-name>_GENVAR.DAT map directly to the ACMSGEN parameters MSS_MAXBUF, MSS_PROCESS_POOL, TWS_POOLSIZ, TWSC_POOLSIZ, WS_POOLSIZ, and WSC_POOLSIZ. The ACMSGEN parameters are set by ACMSPARAM.COM, and the values are used by ACMEXCPAR.COM to set the appropriate EXC process quotas. Always run ACMSPARAM.COM before running ACMEXCPAR.COM so that these values are set correctly.

Table 10–5 Variables Required for ACMEXCPAR.COM

Variable	
AGENT_CNT	
<i>Description:</i>	Number of agent processes on the local system submitting tasks to this application. This includes CP, QTI, ALL-IN-1 processes, Request Interface (RI) agents, EXC (if application is using detached tasks), and any other customer-supplied agents submitting tasks to this application.
<i>Default:</i>	2
<i>Affects:</i>	ASTLM
EXC_ADB_BLK	
<i>Description:</i>	Size, in blocks, of the application.
<i>Default:</i>	Size, in blocks, of the .ADB file.
<i>Affects:</i>	EXC process quota PGFLQUOTA
EXC_MSG_CNT	
<i>Description:</i>	Number of different message files referred to by all of the task groups in this application.
<i>Default:</i>	Number of message files referred to by task groups in the application (from the ADU DUMP GROUP command).
<i>Affects:</i>	ENQLM, FILLM
EXC_RLB_BLK	
<i>Description:</i>	Total size (in blocks) of request library (.RLB) files referred to by all of the task groups in this application. Add the size of a request library once for each different task group that refers to it.
<i>Default:</i>	Total size of .RLBs from EXC_RLB_CNT variable.
<i>Affects:</i>	PGFLQUOTA

(continued on next page)

Setting ACMS Quotas, Parameters, and Privileges

10.3 Calculating EXC Process Quotas with ACMEXCPAR.COM

Table 10–5 (Cont.) Variables Required for ACMEXCPAR.COM

Variable	
EXC_RLB_CNT	<p><i>Description:</i> Number of different request library (.RLB) files referred to by all of the task groups in this application. Count a request library once for each different task group that refers to it.</p> <p><i>Default:</i> Number of .RLB files referred to by task groups in the application (from the ADU DUMP GROUP command).</p> <p><i>Affects:</i> ENQLM, FILLM</p>
EXC_SERVER_CNT	<p><i>Description:</i> Number of servers defined in the application database (from the ADU DUMP APPLICATION command).</p> <p><i>Default:</i> Number of servers defined in the application database (from the ADU DUMP APPLICATION command).</p> <p><i>Affects:</i> ASTLM, TQELM</p>
EXC_SP_CNT	<p><i>Description:</i> Number of server processes that can be started for the application at any one time.</p> <p><i>Default:</i> Number of servers defined in the application database (from the ADU DUMP APPLICATION command).</p> <p><i>Affects:</i> ASTLM, TQELM</p>
EXC_TDB_BLKs	<p><i>Description:</i> Size, in blocks, of all the TDBs for the application.</p> <p><i>Affects:</i> EXC process quota PGFLQUOTA</p>
EXC_TDB_CNT	<p><i>Description:</i> Number of task group databases referred to in this application.</p> <p><i>Default:</i> Number of .TDB files referred to in the application database (from the ADU DUMP APPLICATION command).</p> <p><i>Affects:</i> ENQLM, FILLM, PGFLQUOTA</p>
EXC_TK_INSTANCE_CT	<p><i>Description:</i> The maximum number of currently executing tasks for this application.</p> <p><i>Default:</i> MAXIMUM TASK INSTANCES from the application database, or 64 if none is specified.</p> <p><i>Affects:</i> ASTLM, BIOLM, BYTLM, DIOLM, PGFLQUOTA, TQELM, WSDEFAULT, WSQUOTA, WSEXTENT</p>

(continued on next page)

Setting ACMS Quotas, Parameters, and Privileges

10.3 Calculating EXC Process Quotas with ACMEXCPAR.COM

Table 10–5 (Cont.) Variables Required for ACMEXCPAR.COM

Variable	
EXC_USERNAME	
<i>Description:</i>	User name for the Application Execution Controller (EXC) process. This user name must match the APPLICATION USERNAME specified in the application definition, and be enclosed in quotes or be assigned using the DCL string operator “:=”.
<i>Default:</i>	APPLICATION USERNAME from the application database (.ADB)
<i>Affects:</i>	EXC user name entry in the system authorization file
FORM_CNT	
<i>Description:</i>	Number of different DECforms form (.FORM) files referred to by all of the task groups in this application. Count a form file once for each different task group that refers to it.
<i>Default:</i>	Number of .FORM files referred to by task groups in the application (from the ADU DUMP GROUP command).
<i>Affects:</i>	ENQLM, FILLM
LOCAL_TDMS_TASK_CNT	
<i>Description:</i>	Number of concurrently active task instances using TDMS that are submitted by users on the local system. Do not include tasks using TDMS that are submitted from Request Interface (RI) agents.
<i>Default:</i>	10
<i>Affects:</i>	PGFLQUOTA
REMOTE_AGENT_CNT	
<i>Description:</i>	Number of remote agents (CP, RI, user-written) submitting tasks to this application from remote systems.
<i>Default:</i>	1
<i>Affects:</i>	BIOLM, BYTLM, FILLM
REMOTE_TK_INSTANCE_CNT	
<i>Description:</i>	Number of concurrently active task instances submitted by users on remote systems. This includes task instances submitted from any type of ACMS agent (including CPs) on remote systems.
<i>Default:</i>	5
<i>Affects:</i>	BYTLM

10.3.3 Modifying Variable Values for Use by ACMEXCPAR.COM

Modify the quota values by editing the input or output files of the ACMEXCPAR.COM phases. To calculate quotas on your ACMS system using this method, run each phase separately. To run a single phase, set your default to SYS\$MANAGER and name the phase when you type the command to run ACMEXCPAR.COM:

Setting ACMS Quotas, Parameters, and Privileges

10.3 Calculating EXC Process Quotas with ACMEXCPAR.COM

```
$ SET DEFAULT SYSS$MANAGER  
$ @ACMEXCPAR.COM GENVAR MYAPPL
```

The ACMEXCPAR procedure uses as input the initialization values in the file MYAPPL_GENVAR.DAT. ACMEXCPAR derives this file name during the GENVAR phase of the procedure. The GENVAR phase takes the MYAPPL application name from the command line and appends “_GENVAR.DAT” to it. The MYAPPL_GENVAR.DAT file contains initialization values that are specific to the MYAPPL application.

Whenever you change a parameter, run all subsequent phases in order to obtain the correct EXC quota values. For example, if you alter a value in the MYAPPL_GENPAR.DAT file, you must invoke GENPAR to perform the calculations, and then invoke WRITEPAR to read the new values and modify the SYSUAF.DAT file.

Enter the following command to run the GENPAR phase using the values in the file MYAPPL_GENPAR.DAT as input:

```
$ @ACMEXCPAR GENPAR MYAPPL
```

HP recommends use of the ACMSPARAM.COM and ACMEXCPAR.COM procedures to set system parameters and quotas because these procedures automatically modify other parameters that relate to the parameters that you are changing. However, there are some variables used by ACMSPARAM.COM and ACMEXCPAR.COM that you may want to calculate independently of the command procedures. Appendix A explains in more detail calculations for these variables. Use these formulas for informational or fine-tuning purposes only.

Changing ACMS Parameter Values with the ACMSGEN Utility

This chapter explains how to use the ACMSGEN Utility to change the values of ACMS system parameters. See Section 11.8 for a summary of ACMSGEN commands and qualifiers. For reference information on the commands described in this chapter, refer to Chapter 22.

You can also adjust the ACMSGEN-generated parameters using the command procedure ACMSPARAM.COM. It is recommended that you use ACMSPARAM.COM rather than the ACMSGEN Utility, because ACMSPARAM.COM not only adjusts the ACMSGEN parameters, but ACMSPARAM.COM also uses the modified ACMSGEN parameters to modify other related parameters and quotas. Chapter 10 describes the ACMSPARAM.COM and ACMEXCPAR.COM command procedures.

11.1 How ACMSGEN Works

The ACMSGEN Utility is an ACMS tool that lets you modify and display ACMS system parameters. ACMSGEN works in much the same way that the OpenVMS SYSGEN Utility lets you change OpenVMS parameters. The ACMSGEN commands are a subset of the OpenVMS SYSGEN commands, but the ACMSGEN parameters are different.

ACMS keeps a set of systemwide parameter values in parameter files. When the ACMS system starts up, it reads in the current parameter file SYS\$SYSTEM:ACMSPAR.ACM.

Once ACMS reads the parameter file, the parameters are stored in the active parameter global section. The ACMSGEN Utility can place the parameter file and the active parameter global section in an ACMSGEN work area. Then use ACMSGEN to examine and change parameter values in the ACMSGEN work area. Finally, you can issue the WRITE command to have ACMSGEN write out the work area to a parameter file or to the active parameter global section. By default, ACMSGEN reads the current parameter file on ACMS system startup and does not write out the work area on exit.

Table 11–1 describes the system components affected by ACMSGEN parameters.

Changing ACMS Parameter Values with the ACMSGEN Utility

11.1 How ACMSGEN Works

Table 11–1 ACMS Components Affected by ACMSGEN Parameters

ACMS Component	Description
ACMS Central Controller (ACC)	Creates and controls ACMS processes. The ACMSGEN parameters affecting the ACC include the priority of the ACC and its OpenVMS user name.
Command Process (CP)	Accepts, interprets, and services task selections. With Command Process parameters, you can control which OpenVMS user name the processes run under, and at what priority the processes run.
Terminal Subsystem Controller (TSC)	Handles ACMS sign-ins and manages Command Processes. With TSC parameters, you can control the maximum and minimum number of Command Processes that can be active, the maximum number of terminals that can be serviced by a single Command Process, the user name the TSC processes run under, and the priority of the TSC processes.
Workspace Pool	Used by the Application Execution Controller for workspace control and manipulation. Use ACMSGEN to specify the number of pagelets (Alpha or I64) that are allocated to the pools used for workspaces.
Message Switch	Helps ACMS processes communicate with each other. Use ACMSGEN parameters to control the size of the messages and the amount of memory that can be used to send messages.
Queued Task Initiator (QTI)	Controls ACMS task queues and dequeues queued task elements for processing. Use ACMSGEN parameters to define the user name and priority for the QTI process.

11.2 How to Run the ACMSGEN Utility

No special privileges are required to use the ACMSGEN Utility, but to make permanent changes to an ACMS system, you need the OpenVMS SYSPRV privilege. To change parameters for an active system, you must have the OpenVMS OPER privilege.

Start the ACMSGEN Utility by using either of the following commands:

```
$ MCR ACMSGEN
ACMSGEN>
```

or

```
$ RUN SYS$SYSTEM:ACMSGEN
ACMSGEN>
```

When you see the ACMSGEN Utility prompt (ACMSGEN>), begin to enter ACMSGEN commands. For example:

```
ACMSGEN> SHOW /ALL
```

To get information about an ACMSGEN Utility command, type HELP followed by the command name. For example:

```
ACMSGEN> HELP SHOW
```

Changing ACMS Parameter Values with the ACMSGEN Utility

11.2 How to Run the ACMSGEN Utility

Press **[Ctrl/B]** to recall each ACMSGEN command you enter.

Instead of typing in ACMSGEN commands individually, use the ACMSGEN command keypad. Press **[PF1]** then **[PF2]** for access to the command keypad. When you are finished with ACMSGEN, type EXIT or press **[Ctrl/Z]** to leave ACMSGEN and return to DCL:

```
ACMSGEN> EXIT
$
```

11.3 Types of Parameter Values

The four types of parameter values for you to work with are:

- **Active values**
Values ACMS uses when active. ACMS keeps active values in a system global section. You can change active values for some ACMS system parameters, called dynamic parameters. Change active values for dynamic parameters by writing new values directly to the system global section. The new active values stay in effect as long as ACMS is active, or until you change the active values again.
- **Current values**
Values ACMS uses for initializing the active values. ACMS keeps current values in the parameter file SYS\$SYSTEM:ACMSPAR.ACM. You can change current values for all ACMS system parameters.
- **Work file values**
Values you have written to a work file with the ACMSGEN Utility. You can write values to a work file, change the values you have saved, and use the work file values later to update current or active values. See Section 11.5 for more information on ACMSGEN work files.
- **Default values**
Values in a default list supplied with the ACMSGEN Utility. Use these default values to reset current, active, or work file values.

11.4 Changing Parameter Values

This section describes how to change current and active parameter values.

11.4.1 Changing Current Values

You can change the current value for any ACMS parameter. However, in addition to SYSPRV privilege, you must have write access to the ACMS parameter file.

To change the current value for one or more parameters, first initialize the work area with the USE CURRENT, USE ACTIVE, USE DEFAULT, or USE command. Then, if necessary, change one or more values in the work area with the SET command. Finally, update current values with the WRITE CURRENT command.

Make all of your changes without using the SET command if you are only:

- Updating current values with values in a work file
- Resetting all parameters to default values
- Updating current values with active values

Changing ACMS Parameter Values with the ACMSGEN Utility

11.4 Changing Parameter Values

The following commands increase the number of ACMS terminals by increasing the values of both the MAX_LOGINS and CP_SLOTS parameters:

```
ACMSGEN> SET MAX_LOGINS 25
ACMSGEN> SET CP_SLOTS 5
ACMSGEN> WRITE CURRENT
```

If this is the first work you do in an ACMSGEN Utility session, the work area contains current values when you begin, so you do not need to use the USE CURRENT command. The SET command places new values for MAX_LOGINS and CP_SLOTS in the work area. The WRITE CURRENT command writes all values from the work area to the SYS\$SYSTEM:ACMSPAR.ACM file as new current values. These new current values take effect the next time you start the ACMS system.

Use these same commands, SET and WRITE CURRENT, to reset some current values to ACMS defaults. If you need to display default values or other parameter information on the terminal, use the SHOW command, as described in Section 11.6.

To reset all current values to ACMS defaults, use the USE DEFAULT and WRITE CURRENT commands:

```
ACMSGEN> USE DEFAULT
ACMSGEN> WRITE CURRENT
```

The USE DEFAULT command places ACMS default values in the work area. The WRITE CURRENT command writes the default values to the SYS\$SYSTEM:ACMSPAR.ACM file as new current values.

If you have created a work file with the ACMSGEN Utility, you can update current values with values from the work file. Use the USE command to initialize the work area with values from the work file you name as a parameter. For example:

```
ACMSGEN> USE WORK
ACMSGEN> WRITE CURRENT
```

The USE command initializes the work area with values from the work file SYS\$SYSTEM:WORK.ACM. The WRITE CURRENT command updates current values in the SYS\$SYSTEM:ACMSPAR.ACM file with values from the work area.

If you change active values and want to make the changes permanent, update the current values for dynamic parameters with their active values. For example:

```
ACMSGEN> USE ACTIVE
ACMSGEN> WRITE CURRENT
```

The USE ACTIVE command initializes the work area with active values from the global section for active values. The WRITE CURRENT command updates the current values in the SYS\$SYSTEM:ACMSPAR.ACM file with values from the work area.

11.4.2 Changing Active Values

You can change the active values only for dynamic parameters. To change active values, you must have SYSPRV privilege. To change the active values for one or more dynamic parameters, first initialize the work area with the USE, USE ACTIVE, USE CURRENT, or USE DEFAULT command. Then, if necessary, change one or more values in the work area with the SET command. Finally, update active values for dynamic parameters with the WRITE ACTIVE command.

Changing ACMS Parameter Values with the ACMSGEN Utility

11.4 Changing Parameter Values

Make all your changes without using the SET command if you are only:

- Updating current values with values in a work file
- Resetting all parameters to default values
- Updating active values for dynamic parameters with current values

For example, to change the active value of the MIN_CPIS parameter to 3, enter:

```
ACMSGEN> USE ACTIVE
ACMSGEN> SET MIN_CPIS 3
ACMSGEN> WRITE ACTIVE
```

The USE ACTIVE command initializes the work area with the values of the active ACMS system. The SET command places the value 3 into the work area as the value for MIN_CPIS. The WRITE ACTIVE command writes values from the work area to the global section for active values. The value 3 is the active value for MIN_CPIS. That value stays in effect until ACMS stops or until you change the value again.

Use these same commands to reset some active values to ACMS defaults. To display default values or other parameter information, use the SHOW command, described in Section 11.6.

Set the active values for all dynamic parameters to default values with the USE DEFAULT and WRITE ACTIVE commands. For example:

```
ACMSGEN> USE DEFAULT
ACMSGEN> WRITE ACTIVE
```

The USE DEFAULT command initializes the work area with ACMS default values for all parameters. The WRITE ACTIVE command makes the ACMS defaults the active values of ACMS, writing values from the work area to the global section for active values.

Update active values with values from a work file. For example:

```
ACMSGEN> USE WORK
ACMSGEN> WRITE ACTIVE
```

The USE command initializes the work area with values from the work file SYS\$SYSTEM:WORK.ACM. The WRITE ACTIVE command updates active values for dynamic parameters with values from the work area.

If you recently updated current values and want the new values to take effect immediately, you can update the active values for dynamic parameters with the new current values. For example:

```
ACMSGEN> USE CURRENT
ACMSGEN> WRITE ACTIVE
```

The USE CURRENT command initializes the work area with values from the SYS\$SYSTEM:ACMSPAR.ACM file. The WRITE ACTIVE command updates the active values of dynamic parameters with values from the work area.

11.5 Using a Parameter Work File

To save current or active values for any reason, copy the values to a work file. Use the ACMSGEN Utility to change values you have saved. Use the values in the work file later as current or active values for ACMS.

Changing ACMS Parameter Values with the ACMSGEN Utility

11.5 Using a Parameter Work File

To save values in a work file, use the `WRITE` command. The `WRITE` command copies values from the work area to the file you name, creating a new version of the file:

```
ACMSGEN> WRITE WORK
```

Because the file specification is not complete, this command writes the values in the work area to the file `SYS$SYSTEM:WORK.ACM`. If this is the first command in an `ACMSGEN` session, the command writes the current values of ACMS system parameters to the file.

To save active values in a work file, use the `USE ACTIVE` and `WRITE` commands:

```
ACMSGEN> USE ACTIVE  
ACMSGEN> WRITE WORK
```

The `USE ACTIVE` command initializes the work area with active values for parameters. The `WRITE` command writes the active values for dynamic ACMS parameters to the file `SYS$SYSTEM:WORK.ACM`, creating a new version of the file.

To copy default values to a work file, use the `USE DEFAULT` and `WRITE` commands:

```
ACMSGEN> USE DEFAULT  
ACMSGEN> WRITE WORK
```

The `USE DEFAULT` command initializes the work area with default values. The `WRITE` command writes the default values for ACMS system parameters to the file `SYS$SYSTEM:WORK.ACM`, creating a new version of the file.

To change the values in a work file, or to use them to update current or active values, use the `USE` command to copy work file values into the work area. If you do not include device and directory in your file specification with the `USE` command, the default is `SYS$SYSTEM`. For example:

```
ACMSGEN> USE WORK  
ACMSGEN> SET MAX_LOGINS 25  
ACMSGEN> SET CP_SLOTS 5  
ACMSGEN> WRITE WORK
```

The `USE` command initializes the work area with values from the work file `SYS$SYSTEM:WORK.ACM`. The `SET` command changes the value for the `MAX_LOGINS` parameter to 25 and the value for the `CP_SLOTS` parameter to 5 in the work area. The `WRITE` command writes values from the work area to the file `SYS$SYSTEM:WORK.ACM`, creating a new version of the file.

To update current values with values from a work file, use the `USE` command and the `WRITE CURRENT` command. To update active values with values from a work file, use the `USE` command and the `WRITE ACTIVE` command. These commands are described in Chapter 22.

11.6 Displaying Parameter Values

Use the `SHOW` command to get information about ACMS parameters, including their current, active, or default values. You can display values before changing them.

You must use either a qualifier or the name of an ACMS parameter with the `SHOW` command.

Changing ACMS Parameter Values with the ACMSGEN Utility

11.6 Displaying Parameter Values

The SHOW command displays the following information for each parameter displayed:

- Name of the parameter
- Value in the work area
- Default value
- Minimum value
- Maximum value
- Unit of measure
- Dynamic/fixed status

To display information about all ACMS parameters including their current values, use the ACMSGEN SHOW/ALL command. Example 11–1 shows a sample display for this command. The display in Example 11–1 is produced on an OpenVMS Alpha system.

Example 11–1 ACMSGEN SHOW/ALL Command (on Alpha)

```
ACMSGEN> SHOW/ALL
1
Parameters in use: CURRENT
```

Parameter Name	2 Current	3 Default	4 Minimum	4 Maximum	5 Unit	6 Dynamic
MAX_LOGINS	60	60	0	-1	submitters	D
MAX_TTS_CP	20	20	0	-1	terminals	D
PERM_CPS	1	1	0	-1	command prcs	D
CP_SLOTS	3	3	0	-1	command prcs	
MIN_CPIS	2	2	0	-1	CP threads	D
TSC_USERNAME	ACMS\$TSC	SYSTEM				
TSC_PRIORITY	6	4	0	31	VMS Priority	
ACC_USERNAME	ACMS\$ACC	SYSTEM				
ACC_PRIORITY	6	4	0	31	VMS Priority	
CP_USERNAME	ACMS\$CP	SYSTEM				
CP_PRIORITY	6	4	0	31	VMS Priority	
MAX_APPL	10	10	0	-1	applications	
MSS_POOLSIZE	512	512	1	-1	Pagelets	
MSS_MAXBUF	1024	1024	512	65535	Bytes	
MSS_MAXOBJ	500	500	1	-1	Objects	
WS_POOLSIZE	256	256	1	-1	Pagelets	
WSC_POOLSIZE	128	128	1	-1	Pagelets	
TWS_POOLSIZE	1600	1600	1	-1	Pagelets	
TWSC_POOLSIZE	50	50	1	-1	Pagelets	
USERNAME_DEFAULT	ACMS_USER					D
NODE_NAME	ARK					

Changing ACMS Parameter Values with the ACMSGEN Utility

11.6 Displaying Parameter Values

MSS_PROCESS_POOL	256	256	1	-1	Pagelets	
MSS_NET_RETRY_TIMER	10	10	1	-1	seconds	D
QTI_USERNAME	QTI_NAME	SYSTEM			VMS username	
QTI_PRIORITY	4	4	0	31	VMS Priority	
QTI_SUB_TIMEOUT	7200	7200	1	-1	seconds	D
QTI_RETRY_TIMER	180	1800	1	-1	seconds	D
QTI_POLLING_TIMER	5000	5000	1	-1	milliseconds	D

The numbers in Example 11–1 correspond to the list that follows:

1 Parameters in use

Displays the source of the values now in the work area. The **CURRENT**, **ACTIVE**, or **DEFAULT** keyword, or a file specification, can follow "Parameters in use". At the start of an ACMSGEN session, the keyword **CURRENT** follows "Parameters in use" because the work area contains current values by default. Each **USE** command changes the information following "Parameters in use".

2 Current

Shows the values that are currently in the work area. Before you use a **USE** or **SET** command, the "Current" column contains current values. **USE** and **SET** commands change the values you see in the "Current" column.

3 Default

Lists ACMS default values.

4 Minimum and Maximum

Contain the limits for parameter values. A value of **-1** means that a parameter has no maximum value.

5 Unit

Displays the units of measure for each parameter value. "CP Threads" refers to Command Process threads. Each user has one Command Process thread. "Submitters" refers to ACMS users.

6 Dynamic

Indicates whether a parameter is dynamic or fixed. A blank in the dynamic column means that a parameter is fixed.

To display values for parameters affecting the TSC, use the ACMSGEN **SHOW/TSC** command. Example 11–2 shows a sample display from this command.

Example 11–2 ACMSGEN SHOW/TSC Command

```
ACMSGEN> USE ACTIVE
ACMSGEN> SHOW/TSC
```

(continued on next page)

Changing ACMS Parameter Values with the ACMSGEN Utility

11.6 Displaying Parameter Values

Example 11–2 (Cont.) ACMSGEN SHOW/TSC Command

```
Parameters in use: ACTIVE
Parameter Name      Current  Default  Minimum  Maximum  Unit      Dynamic
-----
MAX_LOGINS          20      60       0        -1       submitters D
MAX_TTS_CP          5       20       0        -1       terminals  D
PERM_CPS            1       1        0        -1       command prcs D
CP_SLOTS            3       3        0        -1       command prcs
MIN_CPIS            2       2        0        -1       CP threads  D
TSC_USERNAME        SYSTEM  SYSTEM    VMS username
TSC_PRIORITY        6       4        0        31      VMS priority
```

The ACTIVE keyword after "Parameters in use" indicates that the last USE command was USE ACTIVE.

To display a value for one parameter, type SHOW followed by the name of the parameter. For example, the following SHOW command displays a value for the MAX_LOGINS parameter from the work file WORK.ACM in SYS\$SYSTEM:

```
ACMSGEN> USE WORK
ACMSGEN> SHOW MAX_LOGINS
```

The USE command initializes the work area with values from the work file WORK.ACM. The SHOW command displays the value from the work file for the MAX_LOGINS parameter. The following is a sample display for the SHOW MAX_LOGINS command:

```
ACMSGEN>SHOW MAX_LOGINS
MAX_LOGINS          20      60       0        -1       submitters  D
```

When you display information for only one parameter, the display does not contain headers.

11.7 ACMS Parameters

This section lists the types of ACMS parameters and their value ranges, and provides a description of each ACMS parameter.

11.7.1 Types of ACMS Parameters

The six types of ACMS parameters are: ACC, CP, message switch, QTI, TSC, and workspace pool.

Table 11–2 lists the ACMS parameters according to parameter type and lists the commands you can use to display the parameters. See Section 11.7.2 for parameter descriptions.

Table 11–2 ACMS Parameters

Command	Parameter
ACMS Central Controller Parameters	
SHOW/ACC	ACC_PRIORITY
	ACC_USERNAME
	MAX_APPL

(continued on next page)

Changing ACMS Parameter Values with the ACMSGEN Utility

11.7 ACMS Parameters

Table 11–2 (Cont.) ACMS Parameters

Command	Parameter
ACMS Central Controller Parameters	
	USERNAME_DEFAULT
Command Process Parameters	
SHOW/CP	CP_PRIORITY CP_USERNAME
Message Switch Parameters	
SHOW/MSS	MSS_MAXBUF MSS_MAXOBJ MSS_NET_RETRY_TIMER MSS_POOLSIZE MSS_PROCESS_POOL NODE_NAME
Queued Task Initiator Parameters	
SHOW/QTI	QTI_POLLING_TIMER QTI_PRIORITY QTI_RETRY_TIMER QTI_SUB_TIMEOUT QTI_USERNAME
Terminal Subsystem Controller Parameters	
SHOW/TSC	CP_SLOTS MAX_LOGINS MAX_TTS_CP MIN_CPIS PERM_CPS TSC_PRIORITY TSC_USERNAME
Workspace Pool Parameters	
SHOW/EXC	TWS_POOLSIZE TWSC_POOLSIZE WS_POOLSIZE WSC_POOLSIZE

Changing ACMS Parameter Values with the ACMSGEN Utility

11.7 ACMS Parameters

11.7.2 Parameter Descriptions

ACC_PRIORITY

Is the OpenVMS priority used by the ACMS Central Controller. ACC_PRIORITY overrides the SYSUAF default priority. Usually the ACMS default value for ACC_PRIORITY is adequate. Too high a priority can lock out other OpenVMS users. Too low a priority decreases ACMS performance.

ACC_USERNAME

Is the OpenVMS user name used by the ACMS Central Controller. The default user name is SYSTEM. See Chapter 10 for information about the privileges and quotas you assign to ACC_USERNAME.

CP_PRIORITY

Is the OpenVMS priority used by Command Processes. CP_PRIORITY overrides the SYSUAF default priority. Usually the ACMS default value for CP_PRIORITY is adequate. Too high a priority can lock out other OpenVMS users. Too low a priority decreases ACMS performance.

CP_SLOTS

Limits the number of Command Processes that can be active. Because each terminal must be assigned to a Command Process, too low a value limits the number of terminals an active ACMS system can handle. The value for the CP_SLOTS parameter can be high without decreasing performance.

CP_USERNAME

Is the OpenVMS user name used by Command Processes. The default user name is SYSTEM. The user name you assign must have read access to the file pointed to by the logical name ACMS\$NOTICE. See Chapter 10 for information about the privileges and quotas you assign to CP_USERNAME. The CP user name must be authorized as an agent in the UDU authorization file.

MAX_APPL

Limits the number of applications that can be active at any time. When the number of started applications reaches MAX_APPL, any attempt to start an additional application fails. Too high a value allows too many applications to be started, which can decrease system performance. Too low a value unnecessarily restricts the number of applications you can start.

MAX_LOGINS

Limits the number of users who can sign in to ACMS. You can set MAX_LOGINS to 0 if you do not want anyone to sign in. Too high a value for MAX_LOGINS decreases performance by letting too many users sign in to ACMS. See Section A.5.1 for information about changing the value of this parameter.

MAX_TTS_CP

Limits the number of terminals ACMS can assign to a Command Process. ACMS assigns terminals to a Command Process until the number of terminals assigned reaches the MAX_TTS_CP value. Too low a value for MAX_TTS_CP minimizes the advantages of using Command Processes by decreasing the ratio of terminals to processes. Too high a value slows the system.

Changing ACMS Parameter Values with the ACMSGEN Utility

11.7 ACMS Parameters

MIN_CPIS

Prevents delays at sign-in by starting command processes before users need them. ACMS can always assign at least the number of terminals set by the MIN_CPIS value to an active command process. If user's signing in decreases the number of possible assignments to less than the value of MIN_CPIS, ACMS starts another Command Process. If the value for the MIN_CPIS parameter is too low, there is a delay when a user signs in. Too high a value for the MIN_CPIS parameter decreases ACMS performance by increasing overhead.

MSS_MAXBUF

Specifies the maximum size of a message that can be sent without incurring the overhead associated with blocking the message. If MSS_MAXBUF is set at too high a level, there may never be enough memory to allocate to the message. In this case, the message could go into a resource wait state. However, if MSS_MAXBUF is set at too low a level, overhead associated with blocking messages is incurred. See Section A.5.3 for information about changing the value of MSS_MAXBUF.

MSS_MAXOBJ

Specifies the maximum number of message switch objects that can be created on a system at one time. The MSS_MAXOBJ parameter determines the size of the table set up in the message pool. If MSS_MAXOBJ is set at too high a level, this table uses more of the message switch global pool, whose size is affected by the MSS_POOLSIZE parameter. However, if MSS_MAXOBJ is set at too low a level, message switch created objects will fail and cause some ACMS operations to fail. In this case, the Software Event Log contains the message MSS\$_OBJFULL_F object table full, indicating that MSS_MAXOBJ has been exceeded.

MSS_NET_RETRY_TIMER

Defines the number of seconds ACMS waits to retry creating a DECnet object when ACMS distributed processing is enabled. The range for this parameter is 1 to -1 seconds. The default is 10 seconds.

MSS_POOLSIZE

Is the maximum amount of memory that can be used to send messages. The MSS_POOLSIZE parameter sets up a global section backed by the page file. If the MSS_POOLSIZE parameter is set at too high a level, system parameters associated with global sections (gblsections and gblpages) and the page file for global sections (gblpagfil) must be increased. However, if the MSS_POOLSIZE is set at too low a level, messages may be put into a resource wait state or may fail.

MSS_PROCESS_POOL

Defines the size of the ACMS internal message switch process local pool. This pool is used for various data structures for each message switch object and for DECnet input buffers. The range for this parameter is from 1 to -1 pagelets (Alpha and I64). The default is 256 pagelets (Alpha and I64).

Note

MSS_PROCESS_POOL is overridden by the value of logical name ACMS\$MSS_PROCESS_POOLSIZE if that logical name is defined. This can be useful if you need a large process pool, such as for a large number of single-threaded SI agents.

Changing ACMS Parameter Values with the ACMSGEN Utility

11.7 ACMS Parameters

NODE_NAME

Defines the DECnet node name for your ACMS system and enables distributed ACMS processing when defined. When you define NODE_NAME, ACMS allows distributed forms processing provided DECnet is started. By default, the NODE_NAME parameter is null, which disables distributed forms processing.

PERM_CPS

Sets the number of permanently active command processes. The PERM_CPS parameter ensures that some Command Processes are always available when ACMS is active. If the value for PERM_CPS is too low, ACMS can start several Command Processes while ACMS is active. Because the overhead from starting Command Processes is high, too low a value decreases ACMS performance. Too high a value wastes ACMS resources because some Command Processes go unused. See Section A.5.6 for information about changing the value of PERM_CPS.

QTI_POLLING_TIMER

Specifies how long the QTI waits to try to access a queued task when an RMS locking situation was previously encountered the last time the QTI accessed the queue.

QTI_PRIORITY

Defines the OpenVMS priority for the QTI process. A value that is too high locks out other OpenVMS users; a value that is too low can decrease ACMS performance.

QTI_RETRY_TIMER

Specifies how long the QTI waits before attempting to reinvoke a queued task whose previous invocation failed. For example, if the application is not started, then the QTI waits the specified number of seconds before reinvoking the queued task.

When a queued task element does not complete successfully and is to be retried later, the QTI process sets the queued task element on HOLD. These elements, which have been placed on hold by the QTI, have a state value of "HOLD (RETRY PENDING)" when displayed by the ACMSQUEMGR using the SHOW ELEMENT command.

When the number of seconds identified by the QTI_RETRY_TIMER parameter has elapsed, the QTI process resets the element to NOHOLD. Thus, the element becomes a candidate for the next dequeue operation on the queue by a task execution thread. Elements are dequeued by highest priority, and are first-in/first-out (FIFO) within priority.

The effective value of QTI_RETRY_TIMER can be slightly greater than the value you set for the QTI_RETRY_TIMER parameter. That is, the amount of time that the QTI waits before retrying a failed task may be slightly longer than you specify. For the QTI to reset the hold state of queued task elements that are to be retried, it periodically scans all the task queues that are started and inspects the queued task elements that are in the HOLD (RETRY PENDING) state. The frequency at which the QTI performs this scan is 1/10 the value of QTI_RETRY_TIMER, but no less than every second and no more than every 5 minutes. For example, if QTI_RETRY_TIMER is set for 1800 seconds (1/2 hour), then the QTI scans all started queues every 180 seconds (3 minutes). In this example, the actual effective value for QTI_RETRY_TIMER could be as long as 33 minutes even though the QTI_RETRY_TIMER value specified is 30 minutes.

Changing ACMS Parameter Values with the ACMSGEN Utility

11.7 ACMS Parameters

QTI_SUB_TIMEOUT

Specifies the amount of time that an inactive submitter remains signed in to the system before being signed out. The QTI caches submitter sign-ins so that it is not necessary to sign in every time a task is submitted.

Because each submitter that is signed in to ACMS consumes memory resources in the QTI, the ACC, and the EXC processes, the QTI process uses a mechanism that enables it to bypass a submitter sign-in for each task. Specifically, when the QTI process dequeues a queued task element, it checks the user name of that element. If it is the first time the QTI process has dequeued an element with that user name, it signs the submitter in to ACMS. However, the QTI process does not sign out of ACMS as usual. Instead, the QTI process leaves the submitter signed in for a certain amount of time before signing it out. That way, if another queue element with the same user name is dequeued, that user name is already signed in.

Use the ACMSGEN parameter QTI_SUB_TIMEOUT to indicate how long a submitter can remain inactive before the QTI process signs that submitter out of ACMS. To determine how many submitters are signed in under a QTI process, use the ACMS/SHOW QTI command.

QTI_USERNAME

Defines the OpenVMS user name for the queuing process. See Chapter 10 for information about the privileges and quotas you assign to QTI_USERNAME. The QTI user name must be authorized as an agent in the UDU authorization file.

TSC_PRIORITY

Specifies the OpenVMS priority used by the TSC. TSC_PRIORITY overrides the SYSUAF default priority. Usually the ACMS default value for TSC_PRIORITY is adequate. Too high a value for TSC_PRIORITY can lock out other users. Too low a value decreases ACMS performance.

TSC_USERNAME

Is the OpenVMS user name used by the TSC. The default user name is SYSTEM. See Chapter 10 in this manual for information about the privileges and quotas you assign to TSC_USERNAME.

TWS_POOLSIZ

Controls the overall size of the temporary pools that task workspaces use when a task is started. When you start a task, the group and user workspaces the task uses, as well as system workspaces and task workspaces, are copied into temporary workspaces for use by the task. At any given time, the sum of all group, user, system, and task workspaces for all active tasks cannot exceed this number. The default value is 1600 pagelets (Alpha and I64). See Section A.5.7.3 for more information about workspace pools.

TWSC_POOLSIZ

Controls the overall size of the pool used to store information needed to allocate the task instance workspaces stored in the TWS_POOLSIZ pool. The default value of 50 pagelets (Alpha and I64) causes the same amount of pool to be allocated as in previous versions of ACMS. See Section A.5.7.3 for more information about workspace pools.

Changing ACMS Parameter Values with the ACMSGEN Utility

11.7 ACMS Parameters

USERNAME_DEFAULT

Defines a default submitter user name account used for remote task submitters that do not have an individual proxy account, or for task submitters from non-ACMS agents. The default submitter user name account must be authorized by the OpenVMS Authorize Utility in the SYSUAF.DAT file.

WS_POOLSIZ

Specifies the number of OpenVMS pages that are allocated to the workspace pool used for the group and user workspaces. This number of pages is allocated for each application. The default value of 256 pagelets (Alpha and I64) causes the same amount of pool to be allocated as in previous versions of ACMS. See Section A.5.7.3 for more information about workspace pools.

WSC_POOLSIZ

Specifies the number of OpenVMS pages that are allocated to the pool used for the control information for the group and user workspaces. The default value is 128 pagelets (Alpha and I64). See Section A.5.7.3 for more information about workspace pools.

11.7.3 Parameter Values

Table 11–3 lists the ACMS parameters with their value ranges, their default values, and whether or not they are dynamic. The minus one (–1) value in the range column means the upper limit for the parameter is unlimited.

Table 11–3 ACMSGEN Parameter Values

Parameter	Range	Default	Dynamic
ACC_PRIORITY	0 to 31	4	no
ACC_USERNAME	none	SYSTEM	no
CP_PRIORITY	0 to 31	4	no
CP_SLOTS	0 to –1	3	no
CP_USERNAME	none	SYSTEM	no
MAX_APPL	1 to –1	10	no
MAX_LOGINS	0 to –1	60	yes
MAX_TTS_CP	0 to –1	20§	yes
MIN_CPIS	0 to –1	2	yes
MSS_MAXBUF	512 to 65K bytes	1024 bytes	no
MSS_MAXOBJ	1 to –1 objects	500 objects	no
MSS_PROCESS_POOL	1 to –1	256	no
MSS_POOLSIZ	1 to –1 s‡	512 pagelets‡	no
MSS_NET_RETRY_TIMER	1 to –1	10	yes
NODE_NAME	none	none	no
PERM_CPS	0 to –1	1	yes
QTI_POLLING_TIMER	1 to –1	5000 milliseconds	yes

§This value is a guideline. Depending on the complexity of the DECforms IFDL, a smaller value might be more suitable. The value selected is application dependent.

‡This value is Alpha specific.

(continued on next page)

Changing ACMS Parameter Values with the ACMSGEN Utility

11.7 ACMS Parameters

Table 11–3 (Cont.) ACMSGEN Parameter Values

Parameter	Range	Default	Dynamic
QTI_PRIORITY	0 to 31	4	no
QTI_RETRY_TIMER	1 to –1	1800 seconds	yes
QTI_SUB_TIMEOUT	1 to –1	7200 seconds	yes
QTI_USERNAME	none	SYSTEM	no
TSC_PRIORITY	0 to 31	4	no
TSC_USERNAME	none	SYSTEM	no
TWS_POOLSIZE	1 to –1 pages†	350 pages†	no
	1 to –1 pagelets‡	1600 pagelets‡	no
TWSC_POOLSIZE	1 to –1 pages†	50 pages†	no
	1 to –1 pagelets‡	50 pagelets‡	no
USERNAME_DEFAULT	none	none	yes
WS_POOLSIZE	1 to –1 pages†	256 pages†	no
	1 to –1 pagelets‡	256 pagelets‡	no
WSC_POOLSIZE	1 to –1 pages†	128 pages†	no
	1 to –1 pagelets‡	128 pagelets‡	no

‡This value is Alpha specific.

11.8 Summary of ACMSGEN Commands and Qualifiers

ACMSGEN commands allow you to change ACMS system parameters to define lower limits, quotas, process names, user names, proxy accounts, and priorities for components of ACMS. Table 11–4 lists the ACMSGEN commands and qualifiers and provides a brief description of each ACMSGEN command. For detailed information about ACMSGEN commands and qualifiers, see Chapter 22.

Table 11–4 Summary of ACMSGEN Commands

Commands and Qualifiers	Description
EXIT	Ends the ACMSGEN session and returns you to the DCL prompt.
HELP	Displays help information about ACMSGEN commands, parameters, and qualifiers.
SET	Places a new parameter value in the ACMSGEN work area.
SHOW /ACC /ALL /CP /EXC /MSS /QTI /TSC	Displays the value in the work area, the default value, the minimum value, the maximum value, the unit of measure, and the dynamic/fixed status for ACMS system parameters.
USE	Initializes the ACMSGEN work area with values from a work file.

(continued on next page)

Changing ACMS Parameter Values with the ACMSGEN Utility

11.8 Summary of ACMSGEN Commands and Qualifiers

Table 11–4 (Cont.) Summary of ACMSGEN Commands

Commands and Qualifiers	Description
USE ACTIVE	Initializes the ACMSGEN work area with active values for all parameters from an ACMS system global section.
USE CURRENT	Initializes the ACMSGEN work area with current values for all parameters from the SYS\$SYSTEM:ACMSPAR.ACM parameter file.
USE DEFAULT	Initializes the ACMSGEN work area with ACMS default values for all ACMS parameters.
WRITE	Writes values from the ACMSGEN work area to a work file, creating a new version of the file.
WRITE ACTIVE	Changes active values for dynamic parameters by writing values from the ACMSGEN work area to an ACMS system global section.
WRITE CURRENT	Changes current values by writing values from the ACMSGEN work area to the SYS\$SYSTEM:ACMSPAR.ACMS file.

Auditing Applications with the Audit Trail Logger

This chapter explains how to use the Audit Trail Logger (ATL) and the Audit Trail Report (ATR) Utility to monitor the use and misuse of your application. See Section 12.9 for a summary of ATR commands and qualifiers. For reference information on the commands described in this chapter, refer to Chapter 23.

12.1 Understanding the Audit Trail Logger

The Audit Trail Logger records application and user activity in the audit trail log. The Audit Trail Logger records:

- ACMS system starts and stops
- ACMS application starts and stops
- User sign-ins and sign-outs
- What tasks users run and where they encounter errors
- What activities are taking place on distributed ACMS systems
- User errors
- Modifications to application, task, and server attributes
- Server process dumps
- Queued Task Initiator (QTI) process events
- Server image replacement
- Other significant events

The Audit Trail Logger is automatically started with the ACMS system. Disable the Audit Trail Logger by using the `/NOAUDIT` qualifier either on the `ACMS/START SYSTEM` command or the `ACMS/SET SYSTEM` command. When the Audit Trail Logger is disabled, it only records file opens and closes. Use the `/AUDIT` qualifier with either of these commands to reenable auditing.

Use the ATR Utility to display audit trail records or write them to an output file.

12.2 Using the Audit Trail Log File

Each time the ACMS system starts, it creates a new version of the audit trail log file. ACMS writes Audit Trail Logger information to the file `SYS$ERRORLOG:ACMSAUDIT.LOG` by default. The default protection for the audit trail log file is `(S:RD,O:RWED,G:R)`. The Audit Trail Logger must have write access to the audit trail log file for you to start your ACMS system.

Auditing Applications with the Audit Trail Logger

12.2 Using the Audit Trail Log File

The Audit Trail Logger attempts to translate the following logical names, which you can define, and uses the values of the logical names for file allocation when ACMS creates the audit trail log file:

- `ACMS$ATL_DEQ_BLOCKS` — The default extension quantity (DEQ) specifies the number of blocks to be added when the file is extended. Valid values are 0 through 65535.
- `ACMS$ATL_ALQ_BLOCKS` — The allocation quantity (ALQ) specifies the number of blocks to be initially allocated when the log is created. Valid values are 0 through 4,294,967,295.

See the *OpenVMS Record Management Services Reference Manual* for additional information about these fields.

To write audit trail information to a different file on a disk or on a magnetic tape volume set, define the system logical name `ACMS$AUDIT_LOG` to point to that file. If you omit any parts of the file specification in defining the logical name, missing parts are supplied from `SYS$ERRORLOG:ACMSAUDIT.LOG`. For example, the following command defines the audit trail log file as `ACMSAUDIT.LOG` in the directory `[ACMS.AUDIT]` on `SYS$DISK`. The file name and file type are supplied by default.

```
$ DEFINE/SYSTEM ACMS$AUDIT_LOG SYS$DISK:[ACMS.AUDIT]
```

Note the logical must be a system logical so that the Audit Trail Logger has access to it.

If you write audit trail information to a file on disk, take the steps needed to process audit trail log files as ACMS creates them. For example, you can purge audit trail log files or store them on a separate volume.

If the Audit Trail Logger runs out of space for audit trail information on disk, the audit trail logs the error in the software event log (generated by SWL), and the Audit Trail Logger process stops. ACMS sends a message to ACMS operator terminals. Restart the Audit Trail Logger process with the `ACMS/SET SYSTEM /AUDIT` command or the `ACMS/RESET AUDIT` command.

If you write audit trail information to a magnetic tape volume set, define the logical name `ACMS$AUDIT_LOG` to point to a file specification of the form:

```
MTxn:name.ext
```

The components of this file specification are:

- `MT` — Device type for a magnetic tape drive
- `x` — Controller code for the tape drive
- `n` — Unit number of the tape drive
- `name` — File name for the log file
- `ext` — File type for the log file

The following command defines `ACMS$AUDIT_LOG` to point to `ACMSAUDIT.LOG` on the magnetic tape mounted on the `MTA0` device:

```
$ DEFINE /SYSTEM ACMS$AUDIT_LOG MTA0:
```

The default file name and file type are taken from the file specification `SYS$ERRORLOG:ACMSAUDIT.LOG`.

Auditing Applications with the Audit Trail Logger

12.2 Using the Audit Trail Log File

If you write audit trail information to magnetic tape, load and initialize the magnetic tape before you start the ACMS system. If you do not, the ACMS/START SYSTEM command can time out before the initialization is complete. Initialize the magnetic tape with a volume name the same as the first six characters of the file name for the audit trail log file. For example:

```
$ INIT MTA0: ACMSAU
```

If the file name is longer than six characters, the Audit Trail Logger truncates the volume name to six characters. Do not use the MOUNT command after initializing the tape. ACMS logically mounts the magnetic tape when it starts the Audit Trail Logger. If the tape is already mounted, ACMS returns a fatal error on the ACMS/START SYSTEM command.

If the Audit Trail Logger is logging information to magnetic tape, and the end of volume is encountered, OpenVMS sends a message to OpenVMS operator terminals asking the operator to mount the next volume in the volume set. The operator loads the tape on the drive, initializes and mounts the volume, and responds to the operator request with a DCL REPLY command. The Audit Trail Logger then logs information to the new volume.

Note

If the audit trail log file is being written to magnetic tape that runs out of space, ACMS may interrupt its work until a new tape is ready. OpenVMS operator terminals are informed that a new tape must be mounted. Eventually, terminal users do not get any system response. To avoid this problem, store your audit information on large magnetic tapes. Inspect the tape regularly to make sure that it is not full.

For information about magnetic tapes, see *OpenVMS System Manager's Manual, Volume 1: Essentials*. For information about the REPLY command, see the *OpenVMS DCL Dictionary*.

12.3 Events Recorded by the Audit Trail Logger

The Audit Trail Logger logs the following types of events:

- Flagged events — Events flagged when auditing is enabled using the application-level AUDIT clause or subclause, or with the AUDIT keyword in ACMS operator commands.
- Default events — Events that the Audit Trail Logger logs regardless of application definition or operator command. Table 12–1 marks default events in the “When Recorded” column with the word “Always”.

Table 12–1 shows the events logged by the Audit Trail Logger, an explanation of recorded events, and the conditions under which events are recorded.

Auditing Applications with the Audit Trail Logger

12.3 Events Recorded by the Audit Trail Logger

Table 12–1 Events Logged by the Audit Trail Logger

Events Recorded	Explanation	When Recorded
Abnormal terminations of applications	Stopping of applications for any reason other than ACMS/STOP SYSTEM or ACMS/STOP APPLICATION commands	Always
Abnormal terminations of server processes	Stopping of server processes due to error	Always
ACMS errors	ACMS system internal errors	Always
Application starts and stops	Each use of ACMS/START APPLICATION and ACMS/STOP APPLICATION commands	Always
Application modifications	Each use of the ACMS/MODIFY APPLICATION command	Application auditing enabled
Open new audit trail log file	Each use of an ACMS/RESET AUDIT command	Always
Enabling and disabling of the Audit Trail Logger	Each use of the ACMS/SET SYSTEM, ACMS/START SYSTEM, or ACMS/STOP SYSTEM command to enable or disable the Audit Trail Logger	Always
Enabling and disabling of ACMS operator terminals	Each use of the ACMS/SET SYSTEM command to enable or disable ACMS operator terminal	Always
Error allocating ACMS-controlled terminals	Why an ACMS-controlled terminal was unable to be allocated by the ACMS terminal subsystem controller	Always
Errors returned or signaled by cancel handling procedures	Each error encountered by user-written cancel handlers	Always
Errors returned or signaled on initialization and termination procedures	Each error encountered by user-written initialization and termination procedures	Always
Errors signaled by processing steps	Each error signaled during a processing step	Always
Failure to start a server process	Why a server process failed to start	Always
Sign-ins and sign-outs	Who signed in to or out of ACMS and at what time	Always
Queue starts and stops	Each use of the ACMS/START QUEUE, or ACMS/STOP QUEUE commands	Always
Queue modifications	Each use of the ACMS/SET QUEUE command	Always
Queued task failures	Each error that caused the task invocation to fail	Always

(continued on next page)

Auditing Applications with the Audit Trail Logger

12.3 Events Recorded by the Audit Trail Logger

Table 12–1 (Cont.) Events Logged by the Audit Trail Logger

Events Recorded	Explanation	When Recorded
Server replacement	Each use of the ACMS/REPLACE SERVER command	Always
System starts and stops	Each use of ACMS/START SYSTEM or ACMS/STOP SYSTEM command	Always
Task calls	Tasks called by other tasks	Task subclause
Task chains	Tasks chained to from another task	Task auditing enabled
Task cancellations	Tasks canceled by any method	Task auditing enabled
Composed task transaction aborts	When a composed task transaction was aborted	Always
Task completions	Completed tasks, who completed each task, and when	Always
Task selections	Each task selected by a user	Task auditing enabled
User errors not elsewhere reported	User errors, including errors ACMS cannot report back to the user	Always
Submitter authentications in remote applications	As a security measure, when a submitter first selects a task in a remote application, the submitter is authenticated by the application execution controller (ACC) on the submitter node	Always

Use ATR commands to read the events recorded in the audit trail log file or to produce a report that lists the events. The following sections describe how to run the ATR Utility and use ATR commands.

12.4 Running the ATR Utility

Use either of the following commands to run ATR:

```
$ RUN SYS$SYSTEM:ACMSATR
ATR>
```

or

```
$ MCR ACMSATR
ATR>
```

You can also enter ATR Utility commands from DCL level by defining ATR as a DCL foreign command. For example:

```
$ ATR:==$SYS$SYSTEM:ACMSATR
```

Place this command in your login command file to permanently define this foreign command. Once you define ATR as a DCL foreign command, you can use ATR commands from DCL. For example:

```
$ ATR LIST /APPLICATION=EXEX_APPL /BEFORE=14-JAN-1991
```

Auditing Applications with the Audit Trail Logger

12.4 Running the ATR Utility

When you see the ATR> prompt, enter ATR commands. Use the LIST command to display or list audit trail records. Use the HELP command to get information about ATR commands. For example:

```
ATR> HELP LIST
```

Instead of typing ATR commands, you can use keypad keys to enter commands. Press **PF1** and **PF2** for access to the ATR keypad. Press **Ctrl/B** to recall the last 20 ATR commands you enter (one at a time).

When you are finished using the ATR Utility, type EXIT or press **Ctrl/Z** to return to DCL:

```
ATR> EXIT
$
```

In DCL, get help information about the ATR Utility by using the following HELP command:

```
$ HELP @ACMSATR
```

12.5 Creating Log Reports

The ATR Utility LIST command generates an ACMS log report consisting of records from the Audit Trail Logger. Include a file specification with the LIST command to identify a concatenated file containing several audit trail log files, or omit the file specification altogether. If you omit the file specification, ATR searches for a translation for the logical ACMS\$AUDIT_LOG. If ACMS\$AUDIT_LOG is not defined, ATR uses the default file specification, SYS\$ERRORLOG:ACMSAUDIT.LOG.

12.5.1 Creating Full Log Reports

The LIST command with the /OUTPUT qualifier writes full Audit Trail Logger reports to a listing file. If you do not use the /OUTPUT qualifier, the ATR Utility displays information on the terminal.

Example 12–1 provides an sample log report containing a full version of each record in the audit trail log file. Instead of displaying the entire log file on your terminal as shown here, use the /OUTPUT qualifier to send the output to a listing file.

Example 12–1 ATR LIST Command

```
ATR> LIST
1   ACMS Log Report   5-JAN-1991   2 10:08:08.83
   Type   : ALL
   Since  : *
   Before : *
   Appl   : *
   Task   : *           3
   ID     : *
   User   : *
   Sub    : *
   Term   : *
4   File   : SYS$SYSROOT:[SYSERR]ACMSAUDIT.LOG;3
```

```
*****
```

(continued on next page)

Auditing Applications with the Audit Trail Logger

12.5 Creating Log Reports

Example 12–1 (Cont.) ATR LIST Command

```
5   Type   : TASK   6   Time   : 1-JAN-1991 12:16:55.00
7   Appl   : TEST
8   Task   : TSK1M2
9   User   : LTUSER2
10  ID     : CARAT::00010036-00000001-47E6F8C0-008DDDDDE
11  Sub    : CARAT::00010036-00000000-47E6F8C0-008DDDDDE
12  Text   : Task started
      *****

      Type   : TASK       Time   : 1-JAN-1991 12:17:19.06
      Appl   : TEST
      Task   : TSK1M2
      User   : LTUSER2
      ID     : CARAT::00010036-00000001-47E6F8C0-008DDDDDE
      Sub    : CARAT::00010036-00000000-47E6F8C0-008DDDDDE
      Text   : Task end
      Task completion status: Task completed normally
      *****

13  End Report 1-JAN-1991 13:09:01.41
```

The following is a description of the numbered items in Example 12–1.

- 1 ACMS Log Report
The name of the report.
- 2 Date and time
The date and starting time for processing the report.
- 3 The criteria for selecting the records in the report. An asterisk (*) indicates that you did not use a criterion to select records. “ALL” indicates that you did not select records by record type.
- 4 File
The information included to identify the source file, including the file name or file specification.
- 5 Type
The type of information in the record.
- 6 Time
The time the record was created.
- 7 Appl
The application name for an active task.
- 8 Task
The name of the active task.
- 9 User
The OpenVMS user name of the user who submitted the task.
- 10 ID
The ACMS task identification code for one task instance.
- 11 Sub
The ACMS task submitter identification code for an ACMS user running a task.

Auditing Applications with the Audit Trail Logger

12.5 Creating Log Reports

12 Text

A description of the event recorded.

13 End Report

The date and time that report processing concluded.

12.5.2 Creating Brief Log Reports

The /BRIEF qualifier limits how much information is included in the report. Each record in a brief report contains the time of the entry in the Audit Trail Logger and the type of information in the entry. For information about record types, see the description of the /TYPE qualifier. The default is to include full records in the report. Example 12-2 provides an example of an ACMS log report containing a brief version of each record in the Audit Trail Logger.

Example 12-2 ATR LIST/BRIEF Command

ATR> LIST/BRIEF

```
1      ACMS Log Report   5-JAN-1991  2  10:01:02.74
      Type   : ALL
      Since  : *
      Before : *
      Appl   : *
      Task   : *          3
      ID     : *
      User   : *
      Sub    : *
      Term   : *
4      File   : SYS$ERRORLOG:RWGAUDIT.LOG;3

*****
Type   : OTHER      Time   : 1-JAN-1991 11:57:35.03
Type   : COMMAND   Time   : 1-JAN-1991 11:57:42.97
Type   : COMMAND   Time   : 1-JAN-1991 11:59:05.42
Type   : LOGIN     Time   : 1-JAN-1991 11:59:34.61
Type   : LOGIN     Time   : 1-JAN-1991 11:59:35.63
Type   : LOGIN     Time   : 1-JAN-1991 11:59:42.04
Type   : LOGIN     Time   : 1-JAN-1991 11:59:43.05

Type   : TASK      Time   : 1-JAN-1991 12:00:55.00
Type   : TASK      Time   : 1-JAN-1991 12:00:55.92      5
Type   : TASK      Time   : 1-JAN-1991 12:01:06.52
Type   : TASK      Time   : 1-JAN-1991 12:01:09.39
Type   : LOGIN     Time   : 1-JAN-1991 12:02:15.76
Type   : TASK      Time   : 1-JAN-1991 12:02:16.53

Type   : TASK      Time   : 1-JAN-1991 12:02:18.22
Type   : LOGIN     Time   : 1-JAN-1991 12:02:19.82
Type   : TASK      Time   : 1-JAN-1991 12:02:19.87
Type   : LOGIN     Time   : 1-JAN-1991 12:02:19.98
Type   : TASK      Time   : 1-JAN-1991 12:02:20.81
Type   : TASK      Time   : 1-JAN-1991 12:02:22.15
6      End Report   5-JAN-1991 10:01:58.42
```

A brief log report consists of a header and one or more records. The following is a description of the numbered items in Example 12-2.

1 ACMS Log Report

The name of the report.

Auditing Applications with the Audit Trail Logger

12.5 Creating Log Reports

- 2 Date and time
The starting date and time for processing the report.
- 3 The criteria for selecting the records in the report. An asterisk (*) indicates that you did not use a criterion to select records. "ALL" indicates that you did not select records by record type.
- 4 File
The information included to identify the source file, including the file name or file specification.
- 5 Type
A listing of all records that meet your selection criteria. If you do not use qualifiers to select records for the report, the report contains all records in the input file.
- 6 End Report
The time report processing concluded.

12.6 Selecting Audit Trail Records

Use LIST command qualifiers to select records from the Audit Trail Logger. Which qualifier or qualifiers you use depends on the kind of application or task information you want or on how much information you want.

The /SINCE and /BEFORE qualifiers let you select records by time range. The /APPLICATION, /IDENTIFICATION, /SUBMITTER, /TASK, /TERMINAL, /TYPE, and /USERNAME qualifiers each select records containing the information you include on the qualifier. For example, the /APPLICATION qualifier selects records containing the application name you include. Combinations of qualifiers further restrict the information in the report.

12.6.1 Selecting Records by Submitter and Task Identification Code

Every submitter that signs in to ACMS receives a submitter identification code, or **submitter ID**, that ACMS associates with the submitter until the submitter signs out. Every submitter ID is unique. Similarly, each task instance receives a task identification code, or **task ID**, that is also unique.

Use submitter and task IDs with operator commands and with the ATR LIST command. Submitter and task IDs on command qualifiers limit the scope of the command you use. For example, a submitter ID on the /SUBMITTER qualifier of the LIST command defines which audit trail records are extracted from the audit trail log.

Both a submitter ID and a task ID have the following format:

```
<node::><local-id>-<sequence-no>-<boot-time1>-<boot-time2>
```

A called task ID has the following format:

```
<node::><local-id>-<sequence-no>-<boot-time1>-<boot-time2>-task-call
```

For example, this is a submitter ID:

```
CARAT::0455002C-00000000-F7B46260-008DEB44
```

This is a task ID:

```
MYOHMY::0001002F-00000017-F7B46260-008DEB44
```

Auditing Applications with the Audit Trail Logger

12.6 Selecting Audit Trail Records

This is the task ID of a called task:

```
MYOHMY::0001002F-00000017-F7B46260-008DEB44-00000001
```

The sequence number in a submitter ID is always zero. A dash (–) separates boot-time fields for readability, but both fields are considered one field. A task ID is the same as the task submitter’s submitter ID, except that the sequence number field contains a hexadecimal number that is incremented for each task selection.

If a task is a called task (that is, a task called by another task) the task ID contains an additional field called the task-call field. The task call field is a hexadecimal number that is incremented each time a task calls another task. This field is only displayed for tasks called by other tasks.

Because the boot-time field is useful mainly in the Audit Trail Logger, ACMS does not display this field when you use ACMS operator commands. Because the sequence number field of a submitter ID is always zero, ACMS does not display the sequence number field either. The ACMS operator command display formats of the IDs are:

- Submitter ID display format:

```
<node::><local-id>
```

For example:

```
NODE1::0455002C
```

- Task ID display format:

```
node::local-id–sequence-number–task-call
```

For example:

```
NODE1::0455002C-0000001A-00000001
```

When you specify a submitter or task ID with an operator or ATR Utility command, any of the fields that you do not specify are implicitly wildcarded. A dash (–) separates fields, such as local-id and sequence-no, to allow you to omit leading fields. You can omit leading zeros in any of the fields, except the node field.

To see all current task instances submitted by task submitters on node ROW that are executing on your node, specify just the node name on the /SUBMITTER qualifier of the ACMS/SHOW TASK command. For example:

```
$ ACMS/SHOW TASK/SUBMITTER=ROW: :
```

To see what the first task selection was for each submitter in an Audit Trail Logger, specify only the sequence number field on the /IDENTIFIER qualifier of the LIST command. Because you are not specifying the local ID field, indicate that you are omitting that leading field by using a dash. For example:

```
ATR> LIST/IDENTIFIER=-1
```

When you specify a full task ID, the report only contains records generated by that particular task.

Auditing Applications with the Audit Trail Logger

12.6 Selecting Audit Trail Records

12.6.2 Selecting Application Information

Use the /APPLICATION qualifier to create an audit log report of only application information.

12.6.3 Selecting Task Information

These qualifiers return information about ACMS tasks:

- /APPLICATION
- /BEFORE
- /IDENTIFICATION
- /SINCE
- /TYPE

The LIST command with the /TYPE=TASK qualifier causes the ATR Utility to display information about all tasks. Use the /IDENTIFICATION qualifier to display information about a particular task by specifying the task ID. See Section 12.6.1 for information on specifying a task ID. You can use more than one of these qualifiers on the LIST command to select information. For example, the /TASK qualifier and the /BEFORE and /SINCE qualifiers return information about tasks in a time range.

Example 12-3 provides output from the LIST/TYPE=TASK command. It includes records about two different tasks: DBMS_SINGLE_TASK is a task in the TESTB application and TSK0101R is a task in the TESTB application.

Example 12-3 Using the LIST/TYPE=TASK Command to Display Task Information

```
ATR> LIST/TYPE=TASK
1   ACMS Log Report   4-JAN-1991   2   16:05:08.02
   Type   : TASK
   Since  : *
   Before : *
   Appl   : *
   Task   : *           3
   ID     : *
   User   : *
   Sub    : *
   Term   : *
4   File   : SYS$SYSROOT:[SYSERR]ACMSAUDIT.LOG;3
*****
5   Type   : TASK       6   Time   : 1-JAN-1991 13:50:59.58
7   Appl   : TESTB
8   Task   : DBMS_SINGLE_TASK
9   User   : LTUSER28
10  ID     : CARAT::00010045-0000000A-38A21C80-008DDDE5
11  Sub    : CARAT::00010045-00000000-38A21C80-008DDDE5
12  Text   : Task started
*****
   Type   : TASK       Time   : 1-JAN-1991 13:51:34.88
   Appl   : TESTB
   Task   : TSK0101R
   User   : LTUSER46
   ID     : CARAT::0001005B-00000013-38A21C80-008DDDE5
   Sub    : CARAT::0001005B-00000000-38A21C80-008DDDE5
```

(continued on next page)

Auditing Applications with the Audit Trail Logger

12.6 Selecting Audit Trail Records

Example 12-3 (Cont.) Using the LIST/TYPE=TASK Command to Display Task Information

```
Text : Task started
*****

Type : TASK           Time : 1-JAN-1991 13:50:59.58
Appl : TESTB
Task : DBMS_SINGLE_TASK
User : LTUSER28
ID   : CARAT::00010045-0000000A-38A21C80-008DDDE5
Sub  : CARAT::00010045-00000000-38A21C80-008DDDE5
Text : Task end
13 Task completion status: Task completed normally
*****

Type : TASK           Time : 1-JAN-1991 13:51:34.88
Appl : TESTB
Task : TSK0101R
User : LTUSER46
ID   : CARAT::0001005B-00000013-38A21C80-008DDDE5
Sub  : CARAT::0001005B-00000000-38A21C80-008DDDE5
Text : Task end
Task completion status: Task completed normally
*****
End Report 1-JAN-1991 14:10:40.27
```

- 1 ACMS Log Report
The name of the report.
- 2 Date and time
The date and starting time for processing the report.
- 3 The criteria for selecting the records in the report. An asterisk (*) indicates that you did not use a criterion to select records. "ALL" indicates that you did not select records by record type.
- 4 File
The information you included to identify the source file, including the file name or file specification.
- 5 Type
Type of audit record.
- 6 Time
Date and time the record was written.
- 7 Appl
Application name.
- 8 Task
Task name.
- 9 User
User name of the task submitter.
- 10 ID
Task ID.

Auditing Applications with the Audit Trail Logger

12.6 Selecting Audit Trail Records

- 11 Sub
Submitter ID.
- 12 Text
Message text.
- 13 Task completion status
Additional status text.

Use the /TASK qualifier to list information about particular tasks. The following command lists information about all tasks with the name DBMS_SINGLE_TASK:

```
ATR> LIST/TASK=DBMS_SINGLE_TASK
```

If more than one application has a task with the name TSK0101R, use the /APPLICATION qualifier with the /TASK qualifier to return information about only one of these tasks. For example:

```
ATR> LIST/TASK=TSK0101R /APPLICATION=TESTB
```

To return records involving only a particular task instance, use the /IDENTIFICATION qualifier. You only have to enter the node name and the first two long words to uniquely identify a task instance. This example uses the task identification code for the DBMS_SINGLE_TASK task from Example 12–3:

```
ATR> LIST/IDENTIFICATION=CARAT::10045-A
```

This example shows how you can drop leading and trailing zeros from task identification codes; however, do not drop significant digits.

12.6.4 Selecting User Information

These qualifiers return information about ACMS users:

- /SUBMITTER
- /TERMINAL
- /TYPE=LOGIN
- /USERNAME

You can use more than one qualifier on a LIST command to return information. For example, to return information about sign-ins and sign-outs under one user name, use the /USERNAME qualifier and the /TYPE qualifier with the LOGIN keyword. Example 12–4 shows some sample output from a LIST command with these qualifiers.

Auditing Applications with the Audit Trail Logger

12.6 Selecting Audit Trail Records

Example 12-4 ATR LIST/USERNAME/TYPE Command

```

ATR> LIST/USERNAME=PERSONNEL/TYPE=LOGIN

1  ACMS Log Report  4-JAN-1991  2  15:24:49.88
   Type   : LOGIN
   Since  : *
   Before : *
   Appl   : *
   Task   : *           3
   ID     : *
   User   : PERSONNEL
   Sub    : *
   Term   : *

4  File    : SYS$SYSROOT:[SYSERR]ACMSAUDIT.LOG;3
*****
5  Type   : LOGIN           6  Time   : 1-JAN-1991 13:04:50.16
7  User   : PERSONNEL      8  Term   : TTA4:
9  Sub    : ALLDAY::00020036-00000000-BCC34BC0-008DDDE4
10 Text   : Login request
*****
   Type   : LOGIN           Time   : 1-JAN-1991 13:04:55.95
   User   : PERSONNEL      Term   : TTA5:
   Sub    : ALLDAY::00270001-00000000-BCC34BC0-008DDDE4
   Text   : Login request
*****
   Type   : LOGIN           Time   : 1-JAN-1991 13:05:19.05
   User   : PERSONNEL      Term   : TTA4:
   Sub    : ALLDAY::00020036-00000000-BCC34BC0-008DDDE4
   Text   : Successful login
*****
   Type   : LOGIN           Time   : 1-JAN-1991 13:05:25.25
   User   : PERSONNEL      Term   : TTA5:
   Sub    : ALLDAY::00270001-00000000-BCC34BC0-008DDDE4
   Text   : Successful login
*****
11 End Report  4-JAN-1991 15:32:35.86

```

- 1 ACMS Log Report
Name of the report.
- 2 Date and time
The date and starting time for processing the report.
- 3 Criteria for selecting the records in the report. An asterisk (*) indicates that you did not use a criterion to select records. "ALL" indicates that you did not select records by record type.
- 4 File
Information you included to identify the source file, including the file name or file specification.
- 5 Type
Type of audit record.
- 6 Time
Date and time the record was written.
- 7 User
User name of the task submitter.

Auditing Applications with the Audit Trail Logger

12.6 Selecting Audit Trail Records

- 8 Term
Device name.
- 9 Sub
Submitter ID.
- 10 Text
Message text.
- 11 End Report
Date and time report processing concluded.

The display contains all records of sign-ins or sign-outs involving the user name PERSONNEL from the current version of the Audit Trail Logger.

Qualifiers let you find a small number of user records in the Audit Trail Logger containing the task submitter identification code from that session.

Example 12–4 contains two task submitter identification codes:

- ALLDAY::00020036-00000000-BCC34BC0-008DDDE4
- ALLDAY::00270001-00000000-BCC34BC0-008DDDE4

To display all records involving the user session identified by this submitter identification, use the following command:

```
ATR> LIST/SUBMITTER=ALLDAY::20036
```

You have to type only the node name and the first longword to uniquely identify a submitter. You can even omit leading zeros from the first long word to make entry easier.

Example 12–4 contains records of sign-ins at two terminals: TTA4 and TTA5. To list sign-ins and sign-outs at the ACMS-controlled terminal TTA4, use the following command:

```
ATR> LIST/TERMINAL=TTA4:
```

12.6.5 Creating an Audit Trail Record for the QTI Process

The Audit Trail Logger audits all ACMS operator commands that start, stop, or set the QTI or ACMS task queues. In addition, the Audit Trail Logger records all task invocations which fail. The audit trail record of failed task invocations shows the following:

- The error that caused the task invocation to fail
- What the QTI has done with the queued task element

Example 12–5 shows a sample QTI audit entry.

Auditing Applications with the Audit Trail Logger

12.6 Selecting Audit Trail Records

Example 12–5 QTI Audit Entry

```
*****
Type   : ERROR      Time   : 6-APR-1991 13:04:31.81
Queue  : KEV_QUE
ErrQue :
Text   : Error processing queued task
-ACMSQUE-E-ERRREADQ, Error reading the queue file
-SYSTEM-F-ACCVIO, access violation, reason mask=00, virtual address=010E0007,
PC=000009B0, PSL=5F56454B
*****
Type   : ERROR      Time   : 6-APR-1991 13:04:36.44
Queue  : KEV_QUE
ErrQue :
Appl   : SWISS
Task   : CHEESE
User   : MCCARTHY
Elem Id: 218001A3-00000002-D9F83F60-00910F15
Text   : Error processing queued task
-ACMSQUE-E-ERRGETPROC, Error returned from ACMS$GET_PROCEDURE_INFO
-ACMS-E-NOSUCH_PKG, There is no such package defined
-ACMSQUE-I-QTRETRY, Queued task will be retried later
*****
```

See Chapter 8 for information about the operator commands which control the QTI and ACMS task queues. See Chapter 5 for information about managing task queues and queued task elements.

12.6.6 Creating an Audit Trail Record for Application Modification

When you enable application-level auditing and use the ACMS/MODIFY APPLICATION command, the audit trail records any application modifications you make in the Audit Trail Logger. As described in Chapter 9, you can use the ACMS/MODIFY APPLICATION command to modify task, application, or server attributes in active applications. Example 12–6 contains an audit trail record recording a change in the maximum number of task instances allowed in application AIR_REGISTER.

Example 12–6 Application Modification Audit Entry

```
*****
Type   : COMMAND   Time   : 26-JAN-1991 16:52:38.00
Appl   : AIR_REGISTER
User   : KINK
Text   : Attributes for application AIR_REGISTER have been modified
Maximum number of task instances has been changed to 5
*****
```

See Chapter 9 for information about the ACMS/MODIFY APPLICATION command.

12.6.7 Creating an Audit Trail Record for Server Process Dump

If server process dumps have been enabled in the application definition and the server process stops unexpectedly, an OpenVMS process dump is generated and the event is recorded in an audit trail record. Example 12–7 is an example of an audit trail record containing server process dump information.

Auditing Applications with the Audit Trail Logger

12.6 Selecting Audit Trail Records

Example 12–7 Server Process Dump Audit Entry

```
*****
Type   : ERROR      Time   : 27-JAN-1991 09:46:04.95
Appl   : SANDAPPL
Text   : Server process death has generated a VMS process dump
        Process dump for server PROC_DUMP_SRV is
        DISK1$: [TWEPE.TEST]PROC_DUMP_SRV.DMP;
*****
```

Example 12–8 contains an example of an audit trail record generated when the attempt to generate a server process dump failed.

Example 12–8 Server Process Dump Failure Audit Entry

```
*****
Type   : ERROR      Time   : 27-JAN-1991 09:48:26.95
Appl   : SANDAPPL
Text   : Server process death has generated a VMS process dump
        Error writing process dump for server PROC_DUMP_SRV to
        SYS$SYSROOT:[SYSERR]PROC_DUMP_SRV.DMP;
        Insufficient privilege or file protection violation
*****
```

See *HP ACMS for OpenVMS Writing Applications* for information about enabling server process dumps.

12.6.8 Audit Trail Record for Server Replacement

When you use the ACMS/REPLACE SERVER command to replace a server image in an application with a new version of that image, the event is recorded in the Audit Trail Logger. Example 12–9 is an example of an audit report generated by a server replacement.

Example 12–9 Server Replacement Audit Entry

```
*****
Type   : COMMAND    Time   : 26-JAN-1991 14:58:53.52
Appl   : RULES_REGS
User   : SANDY
Text   : Replace Server
        Replace server command issued for RULES_REGS
*****
```

For more information on the ACMS/REPLACE SERVER command, see Chapter 9.

12.6.9 Creating an Audit Trail Record for Insufficient Workspace Pool

If a user initiates a task, but the application execution controller (EXC) is unable to allocate sufficient memory for the task, the user receives an error and the event is recorded in the Audit Trail Logger. Example 12–10 shows an example of an audit trail record generated by insufficient workspace space.

Auditing Applications with the Audit Trail Logger

12.6 Selecting Audit Trail Records

Example 12–10 Insufficient Workspace Audit Entry

```
*****
Type   : TASK Time   : 26-JAN-1991 14:58:53.52
Appl   : ORDER_ENTRY
Task   : ORDER_ENTRY_TASK
User   : OPER_42
ID     : NODEA::00050021-00000002-3D208320-009113BE
Sub    : NODEA::00050021-00000000-3D208320-009113BE
Text   : Task start failed during initialization
Error starting task: Unable to allocate workspace resources, please try later
%ACMSWSP-E-ERRCTLPOO, Error allocating 132 bytes in TWSC pool 3 for workspaces
%ACMSPOO-E-POOL_EXHAUSTED, Insufficient free memory available for request
*****
```

See Chapter 11 for information about the causes of workspace pool allocation failures and how to correct such errors.

12.7 Auditing the System

As a security measure, when an application receives the first task selection from a submitter, the application requests submitter authentication from the ACMS Central Controller (ACC) on the submitter node. This authentication checking ensures that malicious code cannot claim to be a valid submitter. If the application is on a node that is different from the node of the submitter (for example, a remote task selection), then auditing occurs on both the submitter and an application node. The audit trail record indicates the success or failure of task submitter attempts to select a task in a remote application. System authentication auditing provides a way to track the task activity of a task submitter selecting tasks in remote applications.

The following sections describe authentication auditing on submitter and application nodes.

12.7.1 Auditing on the Submitter Node

When the ACC on a submitter node authenticates a submitter for a remote application, an “authentication provided or rejected” record is audited. Here is an example of such a record:

```
*****
Type   : LOGIN      Time   : 11-JUL-1991 09:23:24.73
User   : JONES      Term   : LTA38:
Sub    : CARAT::00020033-00000000-1323F040-008E2DEB
Text   : Authentication provided to node CARAT for application PAYROLL
*****
```

This record indicates that on the submitter node (JONES) was authenticated for task selections in the remote application (PAYROLL on node CARAT).

Because the Audit Trail Logger audits remote task selections on the application node and not the submitter node, the Audit Trail Logger on a submitter node does not show task selections in remote applications. The record includes a pointer to the application node. The Audit Trail Logger on that application node can help you track task activity.

Auditing Applications with the Audit Trail Logger

12.7 Auditing the System

This record can indicate that either a submitter was not authenticated or was not signed in. Records that show a submitter was not authenticated may indicate that an unauthorized user tried to select a task. Records that show a submitter was not signed in may indicate that the submitter was canceled after a task selection was initiated to a remote application. An example of a record where the authentication was rejected follows:

```
*****
Type   : LOGIN      Time   : 11-JUL-1991 09:23:24.73
User   :           Term   :
Sub    : CARAT::00020033-00000000-1323F040-008E2DEB
Text   : Authentication rejected to node CARAT for application PAYROLL
        -ACMSACC-W-SUBNOTAUTH, Unable to authenticate submitter
*****
```

12.7.2 Auditing on the Application Node

When an application receives a task selection from a remote submitter for the first time, the application asks the ACC on the submitter node for submitter authentication. The Audit Trail Logger audits this request as an “authentication request” record. An example of such a record is shown in Example 12–11.

Example 12–11 Authentication Request Record

```
*****
Type   : LOGIN      Time   : 11-JUL-1991 09:23:23.66
User   :           Term   :
Sub    : CARAT::00020033-00000000-1323F040-008E2DEB
Text   : Submitter authentication request for application PAYROLL
*****
```

The authentication request record includes the submitter ID and the application that requests authentication.

After ACC on the submitter node authenticates the submitter, then an authentication success or failure record is audited. Example 12–12 contains an example of an audited success record for the application PAYROLL.

Example 12–12 Authentication Success Record

```
*****
 1 Type   : LOGIN      2 Time   : 11-JUL-1991 09:23:25.86
 3 User   : ACMS_USER  4 Term   : NL:
 5 Sub    : CARAT::00020033-00000000-1323F040-008E2DEB
 6 Text   : Successful submitter authentication for application PAYROLL
           of submitter CARAT::JONES
*****
```

The following is a description of the numbered items in Example 12–12.

- 1 Type
Is the type of information in the record.
- 2 Time
Specifies the time the record was created.
- 3 User

Auditing Applications with the Audit Trail Logger

12.7 Auditing the System

Displays the user name associated with the remote submitter. The user name helps determine the access rights of the submitter (ACMS_USER) for all task selections in the application (tasks run as though they were selected by a local submitter with this user name). The user name is either an OpenVMS proxy or, if an OpenVMS proxy is not found, the default submitter user name (USERNAME_DEFAULT) as specified in ACMSGEN. See Chapter 6 for more information about authorizing remote access to ACMS applications.

4 Term

Includes the login device associated with the submitter. For remote submitters, this device is used for display purposes only and is always NL.

5 Sub

Includes the submitter ID assigned to the submitter upon sign-in. See Section 12.6.1 for more information about submitter and task identification codes.

6 Text

Shows the node and remote user name of the task submitter (CARAT::JONES). It also shows the application that authenticated the submitter (PAYROLL).

An authentication failure record indicates that ACMS was unable to authenticate the submitter and that the submitter was denied access to the application. Example 12–13 contains an example of an authentication failure record.

Example 12–13 Audited Authentication Failure Record

```
*****
Type : LOGIN      Time   : 11-JUL-1991 09:23:25.86
User  :           Term   :
Sub   : CARAT::00020033-00000000-1323F040-008E2DEB
Text  : Unsuccessful submitter authentication for application PAYROLL
       : -SYSTEM-F-NOLINKS, maximum network logical links exceeded
*****
```

Authentication can fail for these reasons:

- There is no proxy for the remote submitter and no default submitter user name.
- The application cannot send the authentication request message to the submitter node because of a resource failure, as when maximum links for DECnet are exceeded.

12.7.3 Auditing on Remote Nodes

When a known ACMS system on a remote node fails or is terminated, the failure or termination event is audited. A known remote ACMS system is one that is either a submitter node (submitters on the remote system are accessing applications on the local node) or an application node (submitters on the local system are accessing applications on the remote node).

Auditing Applications with the Audit Trail Logger

12.7 Auditing the System

The following is an example of a termination event:

```
*****
Type   : COMMAND   Time   : 16-FEB-1991 16:54:57.15
Text   : Remote system stopped on node MARAT
*****
```

The following is an example of a failure event:

```
*****
Type   : ERROR     Time   : 16-FEB-1991 16:57:19.37
Text   : Remote system no longer accessible on node CORDAY
        -SYSTEM-F-THIRDPARTY, network logical link disconnected by a third party
*****
```

12.8 System Messages from Other Products

ATR cannot translate message codes from any product other than TDMS or ACMS. Messages from products other than these are reported by message number. For example:

```
message number 000288664f
```

You can, however, cause ATR to translate messages from other products by using the DCL SET MESSAGE command and specifying the name of the product's system message file. For example:

```
$ SET MESSAGE SYS$MESSAGE:DBMSG.EXE
```

To find out the name of another product's system message file, see the documentation for that product.

Note

It is possible to see the following error when issuing an ATR command:

```
%RMS-E-FNF, file not found
```

This error message may be caused by insufficient privileges on the audit trail log file, even though the log file specified in the command is in the SYS\$ERRORLOG directory.

12.9 Summary of the ATR Commands and Qualifiers

ATR commands help you create reports that include information in the audit trail log file. Table 12–2 lists the ATR commands and qualifiers and provides a brief description of each of the ATR commands. For a detailed description of the ATR commands and qualifiers, see Chapter 23.

Table 12–2 Summary of ATR Commands

Commands and Qualifiers	Description
EXIT	Ends the ATR session and returns you to the DCL prompt.

(continued on next page)

Auditing Applications with the Audit Trail Logger

12.9 Summary of the ATR Commands and Qualifiers

Table 12–2 (Cont.) Summary of ATR Commands

Commands and Qualifiers	Description
HELP /[NO]PROMPT	Provides online information about ATR commands.
LIST /APPLICATION=appl-name /BEFORE[=time] /BRIEF /IDENTIFICATION=task-id /OUTPUT=file-spec /SINCE[=time] /SUBMITTER=submitter-id /TASK=task-name /TERMINAL=device-name /TYPE=type /USERNAME=user-name	Displays or lists information from a source file. The output of this command is an ACMS log report consisting of audit trail records. With qualifiers, you can select the records to be included in the report.

Logging Software Events

This chapter describes the ACMS Software Event Logger (SWL) and tells you how to use Software Event Log Utility Program (SWLUP) commands to generate reports containing SWL error information. See Section 13.3 for a summary of SWLUP commands and qualifiers. For reference information on the commands described in this chapter, refer to Chapter 24.

13.1 How SWLUP Works

The SWL records internal software errors that occur during the execution of ACMS application programs. The SWL is part of the ACMS software installed on your system and is typically started automatically when you start ACMS. If you find that the SWL is not logging events, start the SWL by executing the ACMS startup procedure `SYS$MANAGER:ACMSTART.COM`. For example:

```
$ @SYS$MANAGER:ACMSTART.COM
```

SWL writes all event messages and software errors to the SWL log file. Each time an error occurs, ACMS writes a message to the SWL log file with the following information:

- System absolute time
- Process ID (PID)
- Process image name
- User name
- Process name
- Process UIC
- Program processor status longword at the time of the call
- Program counter of the event log routine call
- Standard VAX condition code
- Extended error information

The default SWL log file is `SYS$ERRORLOG:SWL.LOG`. To redirect the location of the SWL log file, use the logical name `ACMS$SWL_LOG`. You must define this logical as an executive mode system logical in order for the SWL process to create the file in an alternative location.

When you use this logical name, any pieces of the file specification contained in the equivalence name are used. Parts of the file specification not used take the `SYS$ERRORLOG:SWL.LOG` default.

Logging Software Events

13.1 How SWLUP Works

If the use of the logical name results in a file that cannot be opened (for example, because of an incorrect directory or device), then SWL opens the SYS\$ERRORLOG:SWL.LOG. If this happens, SWL also writes a message to the SWL log describing the problem with the logical name.

To read information in the SWL log file, you use SWLUP commands. SWLUP command qualifiers allow you to select information that appears in the report. For example, you can specify the following SWLUP command to list all software errors occurring before April 25, 1994.

```
SWLUP> LIST/SINCE=25-APR-1994
```

When you list your reports, specify an output file with the /OUTPUT qualifier, or let the output default to SYS\$OUTPUT.

Use the /INPUT qualifier to cause SWLUP to read a file specification other than the default SWL log file or one specified by the logical name ACMS\$SWL_LOG. If you do not use the /INPUT qualifier, SWLUP uses either the default SWL log file specification, or one specified by the logical name.

13.2 How to Run SWLUP

Use either of the following commands to run SWLUP:

```
$ RUN SYS$SYSTEM:SWLUP
SWLUP>
```

or

```
$ MCR SWLUP
SWLUP>
```

When you see the SWLUP> prompt, begin entering SWLUP commands. For example:

```
SWLUP> LIST/PROCESS_NAME=AT_HOME/SEVERITY=W,E/OUTPUT=AT_HOME.LIS
```

Use the HELP command to access online help information about SWLUP commands and qualifiers. Press **[PF1]** then **[PF2]** for access to a keypad of SWLUP commands. Press **[Ctrl/B]** to recall each SWLUP command you enter. To exit from SWLUP, use the EXIT command or press **[Ctrl/Z]**.

Enter SWLUP commands from DCL level by using the following command to define SWLUP as a foreign command. When you enter this command interactively, you define SWLUP as a foreign command only for your current process. To define SWLUP as a foreign command permanently, place this command in your login command file:

```
$ SWLUP:==$SYS$SYSTEM:SWLUP
```

Once you define SWL as a foreign command, use SWLUP commands from DCL by preceding each command with the characters "SWLUP". For example:

```
$ SWLUP LIST
```

Note

It is possible to see the following error when issuing a SWLUP command:

```
%RMS-E-FNF, file not found
```

This error message may be caused by insufficient privileges on the SWL log file, even though the log file specified in the command is in the SYS\$ERRORLOG directory.

13.3 Summary of SWLUP Commands and Qualifiers

Table 13–1 provides a brief description of each of the SWLUP commands and lists the qualifiers for each command. For a complete description of the SWLUP commands and qualifiers, see Chapter 24.

Table 13–1 Summary of SWLUP Commands

Commands and Qualifiers	Description
@ (At sign)	Runs an indirect command file that contains SWLUP commands.
EDIT	Lets you edit the last SWLUP command you typed and lets you create an edit buffer into which you can enter SWLUP commands.
EXIT	Causes SWLUP to exit or ends the execution of a command file.
HELP /[NO]PROMPT	Provides online information about SWLUP commands.
LIST [EVENTS] /BEFORE[=time] /EVENT_CODE=event-code /FACILITY=facility-name /IMAGE=image-name /INPUT=file-spec /OUTPUT=file-spec /PRINT /PROCESS_NAME=process-name /SEVERITY=severity-code /SINCE[=time] /USER=user-name	Lists information selected by command qualifiers.
RENEW	Starts a new systemwide SWL log file.
SAVE	Writes the last command you typed to a file.
SET [NO]LOG	Enables or disables logging of any commands you type during a SWLUP session.
SET [NO]VERIFY	Enables or disables the printing of commands stored in an indirect command file. SWLUP sends output to your terminal.

(continued on next page)

Logging Software Events

13.3 Summary of SWLUP Commands and Qualifiers

Table 13–1 (Cont.) Summary of SWLUP Commands

Commands and Qualifiers	Description
SHOW CURRENT	Displays the name of the current log file opened by the SWL detached process.
SHOW LOG	Displays whether or not you are currently logging SWLUP commands and names the log file.
SHOW VERSION	Displays the current version of SWLUP on your terminal.
STOP	Stops the Software Event Logger detached process so that it can exit properly.

Tuning Your Application

This chapter discusses the major issues in ACMS application performance, ACMS processes that affect system performance, and tools for monitoring your system. This chapter also provides a tuning checklist.

14.1 Major Issues in ACMS Application Performance

Sometimes performance issues are a matter of tuning the application and the system as a whole. For example, modifying SYSGEN and ACMSGEN parameters to ensure that ACMS processes have the resources they need can have a significant effect on the performance of both the application and the entire ACMS system. Take the following steps when tuning an ACMS system:

1. Ensure that ACMS processes have the resources they need, by doing such things as setting the working set size of the Application Execution Controller (EXC) to an appropriate value to decrease paging.
2. Ensure that limits to system resources, such as lookaside lists (preallocated pieces of dynamic memory for terminal I/O or network I/O) or global pages, do not cause sudden delays in processing. An inadequate lookaside list could:
 - Cause the ACMS system or task to hang
 - Prevent new users from signing in
 - Cause non-ACMS processes to stop
 - Exhaust dynamic memory
 - Exhaust workspace pools

Although there is no way to predetermine the correct size for lookaside lists, you can determine adequate limits by routinely observing the ACMS system with the DCL SHOW MEMORY command, the OpenVMS Monitor Utility, or the Software Performance Monitor (SPM) software.

3. Ensure there is enough memory so that ACMS control processes are not subject to swapping.
4. Determine the optimal number of server processes for each server, minimizing the time that servers wait for tasks and that tasks wait for servers. Then, change the application definition to set the minimum and maximum values for server process count to their optional numbers. This eliminates excessive server process creation and deletion.
5. Determine whether or not you can trade off resources to benefit the work of most importance at the expense, if necessary, of other activities. For example, you can:
 - Use servers of lower priority for less important work

Tuning Your Application

14.1 Major Issues in ACMS Application Performance

- Require certain processing work, such as computations, to be run in batch mode
- Set limits on the number of ACMS users and applications to ensure that resources are available on the system for other non-ACMS work

Most of the quotas and SYSGEN parameters established during post-installation are sufficient for your ACMS system. You might have to change them, however, if you modify your hardware, add or delete an application, or change the number of users on your system. If you change SYSGEN parameters or for some reason the system resources are insufficient, the ACMS system might notify you with an error message, or it might not have sufficient resources to send an error message.

The best way to determine the optimal settings for parameters is to monitor your system regularly and establish some base numbers to work with. Only through regular monitoring can you recognize normal and abnormal activity, the effect of different workloads on the system, and changes in throughput rates. Also, by monitoring your system before and after making changes to it, you can measure the effects of the change against a predefined goal.

14.2 Monitoring Tools

Tuning involves collecting and reporting on system processes to improve performance. A number of tools are available that can help you collect information about an active ACMS system and applications:

- ACMS SHOW commands

The displays returned by these commands, especially by ACMS/SHOW APPLICATION and ACMS/SHOW APPLICATION/CONTINUOUS, provide information you can use to determine the optimal number of server processes required for your ACMS system. By examining the number of tasks waiting for servers and servers waiting for tasks, you can determine whether some servers are not being used, or too many servers are being created to meet increased demand. See Chapter 9 for a detailed discussion about these ACMS SHOW commands.

In setting the minimum server processes, set the value as high as necessary to prevent the too frequent creation of additional server processes during the time of peak application use. Also set the value as low as you can to conserve memory. Once you have determined the optimal setting for the minimum value, you can set the maximum to that same value, to ensure that no additional servers are created, even at times of peak application load. Users queue for the available servers instead. See *HP ACMS for OpenVMS ADU Reference Manual* for more information about using ADU to set the optimal number of server processes.

- ACMS Audit Trail Logger

The task selections logged in the Audit Trail Logger can help you determine which tasks are most heavily used and the times of heaviest use. This can be useful in determining how to modify an application. See Chapter 12 for a detailed discussion on the ACMS Audit Trail Logger and audit trail log files.

- OpenVMS Monitor Utility and DCL SHOW commands

The OpenVMS Monitor Utility and the DCL SHOW commands are two important performance management tools provided with the OpenVMS operating system.

The OpenVMS Monitor Utility returns information that can help identify and isolate resources causing either ACMS or system-level problems: inadequate values for small request packets (SRP), I/O request packets (IRP), and large request packets (LRP), for example, or inadequate values for paged and nonpaged pool. The paging information is useful in determining appropriate working set sizes for ACMS processes. See *OpenVMS System Management Utilities Reference Manual* for information about the OpenVMS Monitor Utility.

The SHOW commands display the current status of a process, the system, and the devices on the system. Use the SHOW MEMORY command, for example, to ensure there is adequate memory available to prevent swapping of the ACMS control processes. See *OpenVMS DCL Dictionary* for information on the DCL SHOW commands.

- Software Performance Monitor (SPM)

The SPM is an OpenVMS layered product that provides information on resource usage. SPM is particularly useful in determining working set sizes. Because the CPU cost of running SPM is low, it is a good tool for gathering routine performance information. Also, SPM provides extensive tools for reporting the data it gathers. The SPM reports can provide significant help in identifying and solving performance problems. SPM's graphic representation of the information gathered makes it easier to identify performance problems than with MONITOR. See the documentation provided with SPM for more information on this product.

- DEC/Test Manager (DTM)

The DTM is an OpenVMS layered product that is most useful for regression and functional testing. DTM can also be useful in setting up a controlled simulation of application activity to allow you to isolate a performance problem. DTM allows you to have multiple processes on the same CPU run the same script, simulating multiple ACMS users. Although the resources DTM requires can affect the overall performance of the system, this controlled simulation can help you determine which resources are being used. See DTM documentation for more information on this product.

These tools can help identify areas in which adjustment of SYSGEN parameters or user name characteristics can improve ACMS or overall system performance.

14.3 ACMS Processes that Affect Performance

These processes control the ACMS system:

- ACMS Central Controller (ACC)
- Terminal Subsystem Controller (TSC)
- Command Process (CP)
- Application Execution Controller (EXC)
- Server Process
- Audit Trail Logger
- Queued Task Initiator (QTI)

Of these processes, the CP, EXC, and server process have the greatest effect on the performance of an application. In addition, the QTI process has a very significant effect on the performance of the ACMS Queued Task Facility.

Tuning Your Application

14.3 ACMS Processes that Affect Performance

The CP handles all ACMS sign-ins and ACMS menu displays, performs exchange steps for distributed applications, and interprets commands issued at the ACMS menu level. The EXC controls all server processes and handles all exchange steps for local applications. The server process handles all of the processing step work for an application, including all database I/O and computational work. The QTI dequeues queued task elements from one or more task queues and initiates queued tasks in ACMS applications.

Minimizing the number of ACMS processes without overloading them while providing them sufficient system resources results in the best performance. Since most of the ACMS processes control many users, they need larger working sets to function than a typical interactive process. For the same reason, set the OpenVMS priority of the ACMS processes at least as high as that of an interactive process.

14.4 Configuration of Hardware

This section discusses how the various processes and procedures of an ACMS system use the different components of a computer system. If you understand how ACMS uses memory, CPU power, and disk I/O, you can make better choices about how much and what kind of hardware you need. The section also includes a sample configuration suitable for distributed applications.

A properly configured computer system consists of three elements:

- Main memory sufficient to contain the working sets of active processes, thus minimizing paging and swapping
- CPU power sufficient to support operating system requirements and to carry out computation required by the application fast enough to sustain desired throughput
- Disks sufficient in size to store data, application sources, and images, and sufficient in number and speed to support I/O throughput of the application

Before proceeding with plans for hardware configuration, have a clear understanding of requirements in terms of application size, database requirements, and expected performance. Estimates of hardware requirements are much more meaningful if based on observation of an existing application, such as a prototype. All estimates should be based on peak load, not average load.

Note

Estimates based on the discussion in this section are entirely dependent on the nature of the application, and should not be regarded as recommendations. Use your estimates in consultation with your HP account manager and support personnel.

14.4.1 Estimating Memory Requirements

When you estimate how much memory your configuration should include, estimate the memory required for the operating system plus the working set sizes of all the processes in your application. The working set size for a process must be sufficient to avoid excessive page faulting.

Tuning Your Application

14.4 Configuration of Hardware

To estimate how much memory OpenVMS uses, start with a base figure for OpenVMS itself and operating system processes such as ERRFMT, OPCOM, and JOB_CONTROL. Include additional memory for application processes. Remember to include the memory needs of layered products installed on your system, such as DATATRIEVE, TDMS, and COBOL.

When determining the amount of memory each application process needs, consider two factors: the number of global pages and the number of process-private pages. **Global** pages are pages that can be shared among several similar processes, and should only be counted once. **Process-private** pages are specific to a single process and should be counted for each process. The OpenVMS MONITOR PROCESS command can assist you in determining global and process-private pages for the processes you need to consider. Monitor a prototype application to estimate memory needs.

For an ACMS application, the following processes need to be considered when estimating required memory:

- ACC

There is one ACC on your computer. The ACC is the central control point for the ACMS system.

- CPs

How many Command Processes is your system going to run? Broadly speaking, you can count on 1 CP for every 20 users.

- EXC

Consider both global pages used by the EXC and process-private pages needed by each user of the application. The amount of memory is determined by the number of active tasks, but at this level of estimation, the number of users is more likely to be known than the number of active tasks. If this process is short of memory, the performance of the application is adversely affected.

- Servers

Include sufficient working sets for each server and for the processing work being done in the server. Memory requirements are determined by the code you write for the processing work, as well as the database management system you use.

- Non-ACMS processes

Include global and process-private pages for any non-ACMS processes that may be running on your system.

Add up all of your estimates for an estimate of the total memory required for your application.

You can refine your requirements after the hardware configuration is in place and the system is up and running. Chapter 10 discusses means of monitoring and tuning memory usage for your system. It also contains information helpful in calculating quotas and parameters for the processes discussed in this section.

Tuning Your Application

14.4 Configuration of Hardware

14.4.2 Estimating CPU Requirements

How big a CPU does your application require? Performance is almost always spoken of in terms of throughput, the rate of processing computer computations. For example, the number of transactions per second is a measure of the speed at which the system works. The performance of an ACMS system is determined by the size and power of the CPU and the specifics of your application design.

ACMS applications conserve CPU energy more than traditional applications because of the way in which ACMS applications share resources. For example, the server initialization procedure binds the database once for a server process that serves many users. This puts less load on the CPU than a traditional timesharing application, in which each user binds the database in individual processes.

An ACMS application can take an existing image, remove the database binds, and put them into an initialization procedure. The resulting image runs in a single-step task. The performance gains are impressive, even before the image is converted to a multiple-step task.

An ACMS application needs to create fewer server processes and to activate fewer images for a group of users than a traditional application, because the task group shares resources among many users. Also, the ACMS use of specialized processes to share memory among many users reduces memory management overhead, another factor in CPU usage.

The design of a task also has an effect on CPU usage. Avoiding scrolled regions and the processing required to map a large array to a TDMS form were discussed in the section on the user interface for the multiple-step task. Database access methods also affect CPU usage. Use DATATRIEVE, RDO, or DBQ to prototype your database access methods, and observe the effect of various methods on CPU usage. Because of the cost of communicating group and user workspaces from server process for computation to Command Process for I/O, the use of such workspaces often requires more CPU resources than the benefits of such use warrants. Take the costs of communication and server use into account as you estimate the size of CPU required for your application.

You may have different CPU requirements, depending on whether throughput or best response time is your primary goal. To get maximum throughput and best response time, you may need more CPU power than for just maximum throughput. Response time increases as the limit of CPU capacity (maximum throughput) is reached.

Again, it is useful to monitor a prototype and to determine from that the additional CPU power required for the fully implemented system.

14.4.3 Estimating Disk Requirements

Applications that are suitable for development with ACMS tend to be I/O-intensive, requiring a significant amount of disk resources. Update and inquiry tasks against a database, for example, use more disk I/O than an application doing scientific computation, which is a heavy user of CPU power.

When determining how many and what kind of disks you need for your hardware, take these factors into account:

- How much data, application, and operating system space is required
- What disks support the I/O throughput required by your system

Tuning Your Application

14.4 Configuration of Hardware

Determining the number and type of disks needed to support your I/O throughput requirements depends on a number of factors. You need to understand the throughput rate of the disks you are considering. How many I/O requests per second can the disk process before applications have to begin queuing for disk access? The rate varies widely depending on the type of disk and the kind of I/O your application does—for example, whether it is synchronous or asynchronous. The database management system in use also affects the rate of I/O throughput.

Factors in disk configuration specific to ACMS include the location of the audit trail log file. Determine the location of this file by defining the logical name `ACMS$AUDIT_LOG` before you start up the ACMS system. See Chapter 12 for a discussion of the audit trail log file. Be careful not to locate this file on the same disk as your DBMS root file, or Rdb database file, or the file where the index of an RMS indexed file is located. The Audit Trail Logger should not have to contend with database processing for access to the same disk.

You can create a prototype of the database access involved in your application and monitor the I/O requirements. Use `DATATRIEVE`, `RDO`, or `DBQ` to model the transactions you plan to include in your application, and use the DCL command `MONITOR/DISK` to observe the actual I/O rate. Proceeding from observed rates of I/O throughput in the prototype can help you figure out what the disk requirements are when the system is fully implemented.

Once you have an idea of I/O requests per transaction and the desired processing throughput rate in terms of transactions per second, multiply the two figures together to get the total I/O rate. Divide the total I/O rate by the I/O throughput rate of the disk you are considering, and you should have an idea of how many disks you need to support the I/O throughput you require for your application.

$((\text{requests/transaction} * \text{transactions/second}) / \text{throughput rate}) = \text{disks}$

Keep in mind that:

- For good response time, the I/O throughput rate must be less than the disk's maximum capacity.
- There may be limits imposed on the I/O throughput by your database management system.

14.4.4 Sample Configuration

Figure 14–1 shows a sample configuration: distributed ACMS running on two MicroVAX II front-ends for terminal processing and an OpenVMS Cluster for disk processing on the back-end.

In Figure 14–1, terminal processing for a distributed ACMS system is handled by two MicroVAXs. For disk processing, two VAX 8200s and a VAX 8600 are clustered with two HSC50 disk controllers.

The dual HSC50s allow quick disk access. The use of RA81 disk drives provides large amounts of disk storage in a minimal amount of floor space. The MicroVAX processors allow the application manager to distribute the terminals to front-ends and reserve the capacity of the OpenVMS Cluster for database access and computation.

Tuning Your Application

14.4 Configuration of Hardware

Figure 14–1 Sample Distributed ACMS Configuration

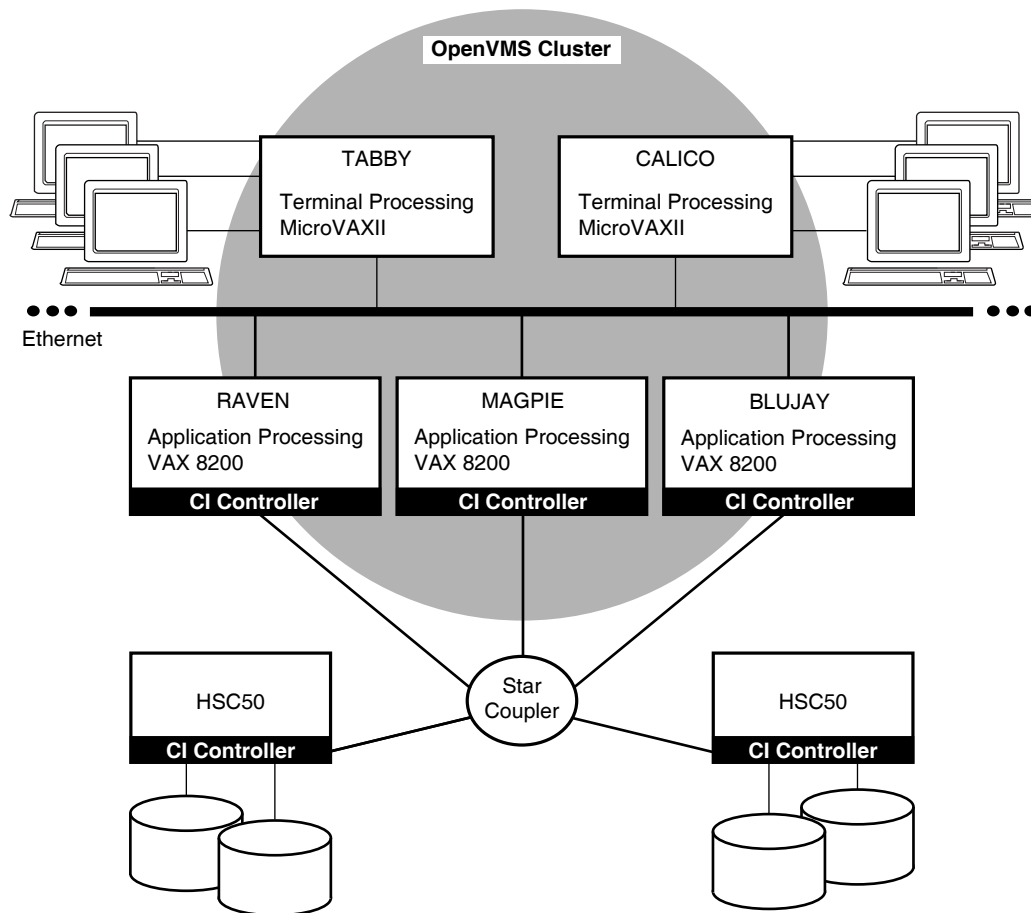

VM-0455A-AI

14.5 Configuring the Command Process

The CP handles many users at one time. The performance of the CP depends on the number of users it must control and the rate at which those users are selecting menus or tasks. The number of users that the CP controls is determined by the ACMSGEN parameter `MAX_TTS_CP`.

To determine whether or not the CP is configured properly, monitor one of the command processes during peak hour conditions using the DCL command `SHOW PROCESS/CONTINUOUS`. If the CP remains idle for long periods of time, it may be able to handle more users. Allowing it to control more users reduces the number of Command Processes ACMS needs and also the amount of system resources ACMS uses.

If the CP remains in a computable state for a period of time, it may be overloaded. An overloaded CP can make menu displays and response time seem slow to the users. When this is the case, reduce the number of terminals the CP controls by changing the `TERMINALS_PER_CP` parameter in the `ACMVARINI.DAT` file and running the `ACMSPARAM.COM` procedure. See Chapter 10 for information about running `ACMSPARAM.COM`.

Tuning Your Application

14.5 Configuring the Command Process

If the CP seems to be paging heavily, its working set might be set too low. When this is the case, increase the working set size for the CP using the OpenVMS Authorize Utility. Restricting the CP by limiting its working set can result in poor performance for all the users it controls.

Another source of poor CP performance might be the priority at which the CP is running. The ACMSGEN parameter CP_PRIORITY controls the priority at which the CP runs. Set this value at least as high as an interactive user's priority.

As much as possible, perform such adjustments using the ACMSPARAM.COM procedure rather than the ACMSGEN Utility because ACMSPARAM adjusts other related parameters automatically. In some instances, such as adjusting dynamic system parameters, it might be necessary to use ACMSGEN (see Chapter 11).

14.6 Configuring the Application Execution Controller

The performance of the EXC process depends on the rate at which exchange steps are being executed and the complexity of the TDMS requests. Although there is a single EXC process for each application, the EXC process is normally able to handle all users of an application.

Insufficient working sets or an OpenVMS process priority that is too low for the EXC user name can significantly reduce the performance of the application. The EXC might require considerably more system resources than a typical interactive process because it controls many users at one time.

SPM can be used to monitor page faults in the EXC at the time of peak load periods. You can also use the DCL SHOW PROCESS/CONTINUOUS command, but restrict its usage to short periods of time because the command affects overall system performance.

Set the resource quotas for the EXC process on an individual basis using the ACMEXCPAR.COM command procedure (see Chapter 10). Each EXC process performs a specific function and requires specific resources to perform properly.

The application definitions created with ADU set up the user names under which the EXC controllers run. Use the OpenVMS Authorize Utility to change the working set size and priority for the user name of each EXC, if necessary. By using the OpenVMS Authorize Utility to change the priority and quotas associated with these user names, you can change the performance of the applications and the ACMS system. See the OpenVMS Authorize Utility documentation for more information. *HP ACMS for OpenVMS ADU Reference Manual* contains information on using ADU application definition clauses.

14.7 Configuring the Server Process

The performance of the server processes for an application depends mainly on how you define them in the application definition. The number of server processes available to an application can affect its performance. If too many servers are active, system resources are wasted. If too few servers are active, users might have to wait long periods of time before ACMS can allocate a server process to their application.

To determine whether or not there are enough server processes on the system for a particular application, use the ACMS /SHOW APPLICATION command. This command shows how many servers are active, how many users are waiting for server processes, and how many servers are busy. This information indicates whether or not there are enough servers on the system.

Tuning Your Application

14.7 Configuring the Server Process

To change the operational characteristics of server processes, use the ADU and the OpenVMS Authorize Utility. The application definitions created with ADU include clauses that determine how many resources the application uses. For example, the MAXIMUM SERVER PROCESSES clause sets an upper limit for all server processes in an application.

An application definition also sets up the user names under which server processes and Application Execution Controllers run. By using the OpenVMS Authorize Utility to change the priority or quotas associated with these user names, you can change the performance of the applications and of the ACMS system. See the OpenVMS documentation on the Authorize Utility for more information. *HP ACMS for OpenVMS ADU Reference Manual* contains information on using ADU application definition clauses.

14.8 Tuning and Maintaining the Queued Task Facility

The performance of the QTI is affected by:

- The configuration of the process
- The number of concurrent task execution threads

In addition, the performance of the QTI as well as the performance of processes which call the Queued Task Services, is affected by:

- The RMS tuning variables associated with the task queue files
- Proper maintenance of the task queue files

14.8.1 Configuring the QTI Process

The performance of the QTI is affected by how the process is configured. In particular, the performance is mainly affected by:

- The OpenVMS process priority
- The working set size

Specify the OpenVMS process priority with the ACMSGEN QTI_PRIORITY parameter. Depending on your application, you may want the QTI to run at the same priority as processes serving interactive users (for example, the CP), or you may want the QTI to run at a lower priority than interactive users (similar to a batch process).

Specify the user name of the QTI with the ACMSGEN parameter QTI_USERNAME. This user name, and the quotas for this user name, are defined in the system user authorization file (SYSUAF.DAT) using the OpenVMS Authorize Utility. Ensure that the working set size of the QTI is sufficient so that it does not page excessively.

Use the ACMSPARAM.COM procedure (see Chapter 10) to define the user name of the QTI. This command procedure determines the quotas needed by the QTI depending on application-specific data which you provide. In addition, ACMSPARAM.COM will set the working set size to a reasonable first guess. Monitor the QTI during peak times to determine if the working set size requires adjusting.

14.8.2 QTI Task Execution Threads

When you start a task queue with the ACMS/START QUEUE operator command, you can specify the number of task execution threads using the /TASK_THREADS qualifier. By default, if you do not specify this qualifier, one task execution thread per queue is allocated to each started queue.

The number of task execution threads controls how many task invocations can be outstanding at any one time. With multiple task execution threads, the dequeuing of queued task elements and the invocation of queued tasks occur concurrently. Therefore, when you increase the number of threads, you increase the throughput. As you increase the number of threads, the QTI uses more system resources such as CPU and disk IOs. Therefore, balance the usage of these resources as needed among other components of your application.

If you have multiple queues being processed by the QTI, then you can favor one queue over other queues by assigning it more task execution threads.

The rate at which the QTI processes elements of one queue relative to another queue is a function of the number of task threads per queue and the time it takes to execute the queued tasks. Each QTI task thread does its processing loops (dequeue element, invoke queued task) independently of any other thread. Therefore, you have to consider the time delay of the tasks which are being invoked when trying to calculate the rate at which elements are processed in one queue relative to another queue.

For example, assume you have started the task queues MY_QUEUE and YOUR_QUEUE, and MY_QUEUE is assigned one task execution thread and YOUR_QUEUE is assigned two task threads. If the execution time of the tasks in the two queues is the same, there will be twice as many queued task elements processed in YOUR_QUEUE than in MY_QUEUE. If, however, the execution time of the tasks in MY_QUEUE is twice as long as those in YOUR_QUEUE, then there will be four times as many queued task elements processed in YOUR_QUEUE than in MY_QUEUE.

Although it is possible to specify up to 255 task execution threads per queue, normally you specify a relatively small number. After a certain point, increasing the number of task execution threads does not increase throughput. Each task execution thread consumes memory and requires higher process quotas. Therefore, increasing the number of task execution threads beyond a certain point only wastes these resources. In practice, specifying 1 to 10 task execution threads is sufficient to meet your needs.

14.8.3 Tuning Task Queue Files

The ACMS Queued Task Facility is layered on RMS. Specifically, each task queue repository is an RMS indexed file. Therefore, tune task files just as you would any RMS indexed file.

The steps you use to modify RMS tuning variables associated with the task queue file are:

1. Generate a File Definition Language (.FDL) file for an existing task queue repository by using the DCL ANALYZE/RMS_FILE/FDL command.

For example, assume you have created a task queue using the ACMS Queue Manager and the file specification associated with the task queue is SYS\$SYSTEM:PAYROLL_QUEUE.DAT. Generate an .FDL file by issuing the following command:

```
$ ANALYZE/RMS_FILE/FDL SYS$SYSTEM:PAYROLL_QUEUE.DAT
```

Tuning Your Application

14.8 Tuning and Maintaining the Queued Task Facility

2. Modify the RMS tuning variables in the .FDL file as needed by using the EDIT/FDL Utility.

For example, using the .FDL file generated from the example in the previous step, invoke the EDIT/FDL Utility with:

```
$ EDIT/FDL PAYROLL_QUEUE.FDL
```

From within the EDIT/FDL Utility, modify the RMS tuning variables as needed. ACMS uses the RMS defaults for all the tuning variables. Specific tuning variables which you might want to modify depending on your application include:

- Initial file allocation
- Contiguity
- Default file extension quantity
- Multibuffer
- Bucket size
- Global buffers

For more information on tuning RMS indexed files, see the OpenVMS documentation on RMS.

3. Convert the queued task repository file by using the Convert Utility on the .FDL file from the previous step:

```
$ CONVERT/FDL=PAYROLL_QUEUE SYS$SYSTEM:PAYROLL_QUEUE.DAT -  
_$_$ SYS$SYSTEM:PAYROLL_QUEUE.DAT
```

The Convert Utility generates a new queued task repository file having a higher version number than the original queued task repository file. The Queued Task Facility depends on the original file version. Therefore, you must delete the original file and rename the new converted file to have the old version number. For example:

```
$ PURGE SYS$SYSTEM:PAYROLL_QUEUE.DAT  
$ RENAME SYS$SYSTEM:PAYROLL_QUEUE.DAT; ;1
```

For more information on the ANALYZE/RMS_FILE Utility, the EDIT/FDL Utility, and the Convert Utility, see *Guide to OpenVMS File Applications*.

14.8.4 Maintaining Task Queue Files

The ACMS Queued Task Facility is layered on RMS indexed files. In a running application, elements are enqueued to a task queue, and at some later point in time they are dequeued. These operations translate to write and delete operations on the RMS indexed file. RMS retains buckets in indexed files even if all the records in the bucket have been deleted.

Over time, these empty buckets can accumulate and needlessly waste disk space. In addition, these empty buckets can cause a performance degradation of the QTI process if your application uses multiple priority levels of queued task elements and the highest priority in the task queue changes frequently.

Use the Convert or Convert/Reclaim Utilities on the task queue repository files to reclaim these unused buckets. If you use the Convert Utility, you also need to rename the new task queue repository file to have the original version number. For more information on the Convert and Convert/Reclaim Utilities, see *Guide to OpenVMS File Applications*.

Tuning Your Application

14.8 Tuning and Maintaining the Queued Task Facility

Perform this file maintenance on a regular basis. Because the Convert Utilities require exclusive access to the file, you need to perform this maintenance during a time when your application needs little access to the queue file.

14.9 Tuning Checklist

Use the following checklist to establish a sound management routine that helps you maintain good performance on your ACMS system.

1. As system manager, routinely:
 - Use ACMSPARAM.COM and ACMEXCPAR.COM after installations or upgrades to set system parameters, privileges, and quotas. Also run ACMSPARAM and ACMEXCPAR after modifying the ACMS environment, for example, if you add or delete an application or change the number of terminal devices.
 - Establish realistic standards for system performance by monitoring your system on a regular basis.
 - Understand the workload and capacity of your system so you can recognize normal and abnormal performance.
 - Observe how peak load times and complex applications affect ACMS performance.
 - Avoid performance complaints by notifying users of anticipated workload changes that might slow down the system.
2. Use tuning as a last resort to solve a performance problem:
 - If a performance problem arises, investigate the possible causes using the various OpenVMS and ACMS monitoring tools.
 - If a performance problem persists, compare the current throughput rates with those rates established during "normal" operations.
 - Before adjusting system parameters, look for other, simpler solutions, for example, balancing workload peaks by running some jobs as batch jobs at nonpeak times.
3. If you find that you must tune your system by adjusting system parameters:
 - Use the ACMSPARAM.COM and ACMEXCPAR.COM command procedures instead of ACMSGEN. These procedures automatically adjust all other configuration-related parameters to suit your ACMS configuration.
 - Limit the values you adjust to a few at a time and measure their effect against a predefined goal.
4. After you make adjustments:
 - Plan on monitoring your system to ensure that the adjustments have improved ACMS performance.
 - If tuning has not improved performance, stop tuning and reevaluate the situation. The cause of the problem may lie in other areas, including the application design or database design.

Using HP DECtrace with ACMS Applications

HP DECtrace is a product that collects and reports on event-based data gathered from any combination of OpenVMS layered products and application programs. If HP DECtrace is installed on your system, you can use it to collect detailed information about applications that use the ACMS software.

15.1 Overview of DECtrace

HP DECtrace refers to layered products and applications as **facilities**. HP DECtrace allows layered products, such as ACMS and Rdb, to define **events**. ACMS has many predefined events that occur at run time. An event can have a start and an end (**duration event**), or it can simply occur (**point event**).

Because HP DECtrace is event-based, it provides you with several advantages:

- An easy way to collect and report on the resources utilized by predefined events in an application.
- A way to determine the frequency of execution of events, rather than an average or estimated frequency.
- Response time measurement on both submitter and application nodes
- Logging of processing steps that execute called tasks
- Message compression measurement

HP DECtrace records several different pieces of information, called **items**, for each event. Items can be:

- Resource utilization items such as CPU time
- ACMS data items such as the task name, associated with ACMS events
- Cross facility items used to relate event data from one facility to another

Section 15.3.1 contains descriptions of ACMS events and items.

To use the HP DECtrace commands, preface them with the keyword COLLECT. For example:

```
$ COLLECT SHOW VERSION
HP DECtrace Version V1.2-0
$
```

For better user interface performance, you can enter the HP DECtrace command environment by entering the COLLECT command with no arguments at the DCL prompt. HP DECtrace prompts you for commands until you return to DCL command level by entering the EXIT command. This eliminates binding to the history and administration databases for each command. For example:

Using HP DECtrace with ACMS Applications

15.1 Overview of DECtrace

```
$ COLLECT
DECtrace> SHOW VERSION
DECtrace Version V1.2-0
DECtrace> EXIT
$
```

15.2 Improving Application Management with HP DECtrace

HP DECtrace records information about specific events or items within the events in an ACMS application. To record this information, you simply activate the collection of the desired event data with a HP DECtrace command. See DECtrace documentation for more information.

You can use HP DECtrace for a variety of application or system management functions:

- **Resource use**
For example, use HP DECtrace to compare the speed of an arithmetic computation done in a HP DECforms escape sequence with the same computation done in a procedure. Or, turn on HP DECtrace at the beginning of an exchange step and at the end of the step to see how much of the response time is network overhead.
- **User information**
You can use HP DECtrace to trace a task or an exchange to see how fast the user gets through it, test the design of a single form or part of a form to identify areas of concern, or compare the results of two forms that gather the same information with different formats. Or, use HP DECtrace to count the number of tasks or forms completed by a user.
- **Audit information**
Because granularity is smaller in HP DECtrace than in ACMS, you can get more detailed auditing information. ACMS auditing operates on the system level, while HP DECtrace can look at parts. For example, ACMS can indicate only that a task is started or stopped, while HP DECtrace can give details of parts of the task.

15.3 Collecting Event Data for ACMS

To collect event data with HP DECtrace, you must first create a facility selection and then schedule data collection using that selection. This section describes how to create a facility selection and schedule data collection for ACMS applications.

15.3.1 Describing ACMS Events and Items

Each time a predefined event occurs in an ACMS application, and if a collection is scheduled, DECtrace records the event items in a data file. In your facility selection, you can decide to collect either all of the events and items available or a predefined subset of these events and items (called a **collection class**—see Section 15.4.2). You can use this collected data to identify information for a variety of uses such as how frequently an event occurs, what order events occur in, or how long an event takes to complete.

Note

DECtrace collects all occurrences of each event in your chosen collection class. You cannot choose individual events to record. However, you can

Using HP DECtrace with ACMS Applications

15.3 Collecting Event Data for ACMS

create reports based on specified events by using the REPORT command. See Section 15.5 for information on DECtrace reporting.

Note that if you use an agent other than the one provided by ACMS, the agent must be instrumented with HP DECtrace service routine calls in order to collect the ACMS event data associated with that agent. The following events must be instrumented in the customer-written agent process if you want them to be collected: REMOTE_REQUEST, FORMS_ENABLE, and FORMS_REQUEST.

Each event has various items associated with it. These items include a set of standard HP DECtrace resource utilization items, a set of facility-specific items and a set of cross facility items. Table 15–1 lists the standard resource utilization items. Table 15–2 lists the ACMS-specific data items. Table 15–3 lists the cross facility items.

15.3.1.1 ACMS Events

This section describes the events that can occur in your ACMS application.

TASK

A task within the application. This event is written to the data collection file by the EXC. The start event is recorded when the start call is received from the CP. The end event call is recorded immediately preceding the return call to the CP.

ACMS can log chained tasks as separate TASK events. You can use the PARENT_TASK and STEP_NAME items to identify tasks called by other tasks. (If a task is not called by another task, ACMS leaves these two items blank.)

EXCHANGE_STEP

An exchange step within a task. This event is written to the data collection file by the EXC. The start event is recorded at the beginning of step processing. The end event is recorded at the end of step processing.

PROCESSING_STEP

Processing step within a task. This event is written to the data collection file by the EXC when a processing step:

- Executes a procedure call
- Executes a DCL server command
- Calls another task

The start event is recorded at the beginning of step processing. The end event is recorded at the end of step processing.

REMOTE_REQUEST

Remote request terminal I/O executed by the agent process. This event is written to the data collection file by the ACMS Remote Request Server (RR). The start event is recorded whenever a TDMS request is received. The end event is recorded when the request completes.

PROCEDURE_CALL

User's server procedure in a processing step. This event is written to the data collection file by the SP. The event reflects the time and resources used by the customer-written procedure.

Using HP DECtrace with ACMS Applications

15.3 Collecting Event Data for ACMS

TASK_WAIT

Task waiting for server processes. This event is written to the data collection file by the EXC. The start event is recorded when no server is available to process the request. The end event is recorded when a server becomes available. This event is part of the PROCESSING_STEP event.

TRANSACTION

An ACMS transaction. This event is written to the data collection file by the SP or EXC. This event is started when ACMS starts a transaction and is ended upon completion of the transaction.

FORMS_ENABLE

A HP DECforms enable performed by the agent process. This event is written to the data collection file by the ACMS DECforms Server (VFS). The first time a user references a form, it must be enabled.

FORMS_REQUEST

A HP DECforms request executed by the agent process. This event is written to the data collection file by the ACMS DECforms Server (VFS). This event is recorded whenever ACMS executes a HP DECforms request (SEND, RECEIVE, TRANSCEIVE).

SUB_RESPONSE

The SUB_RESPONSE event is a duration event that records the time that ACMS takes to respond to a HP DECforms, TDMS, or stream I/O request from the submitter node, excluding the overhead associated with the forms product. This event is written to the data collection file by one of the following:

- ACMS HP DECforms Server (VFS)
- ACMS Remote Request Server (RR)
- Stream Services (STRM)
- Submitter Services (SUB)

ACMS logs the start of the event whenever a HP DECforms, TDMS, or stream I/O forms request is completed, and at the start of each task. ACMS logs the end of the event at the start of the next forms request within the same task or, if no forms request follows, when the task is completed. Figure 15–1 shows the point at which ACMS measures the SUB_RESPONSE event: the task start, during the task, and the task end.

Figure 15–1 Measuring the SUB_RESPONSE Event

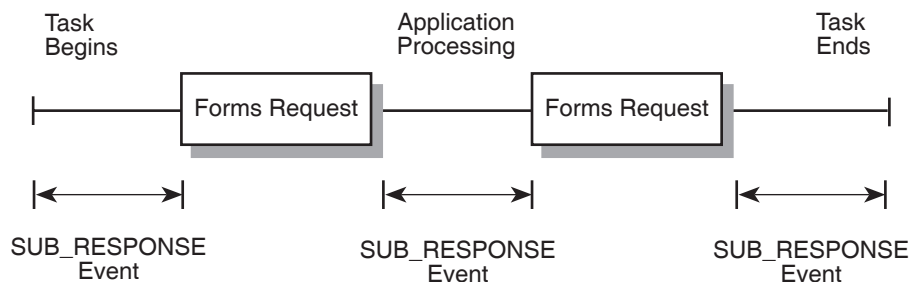

TAY-0015-AF

Using HP DECtrace with ACMS Applications

15.3 Collecting Event Data for ACMS

The following rules apply to the SUB_RESPONSE event for tasks with no I/O operations, tasks calling other tasks, or chained tasks:

- If a task performs no I/O operations, ACMS measures the SUB_RESPONSE event from the beginning of the task to its end. In this case, the SUB_RESPONSE event represents the time ACMS takes to respond to a menu selection.
- A SUB_RESPONSE event can continue from one task into a called task. For example, if during application processing, the current (parent) task calls another task that executes a forms request, the SUB_RESPONSE event begins during the parent task and ends during the called task. Similarly, a SUB_RESPONSE event can begin in a called task and end in the parent task.
- Task boundaries between chained tasks (those tasks started by either the REPEAT TASK or GO TO TASK clause) do not begin or end a SUB_RESPONSE event. An event started in one task continues into succeeding chained tasks until it reaches another forms request or the last task in the chain, and the task returns control to the ACMS submitter services.

The response time measured by the SUB_RESPONSE event includes the time required for network communications with the application node, and the time required for the node to perform application processing. These values are collected in the NETWORK_TIME and PROCESSING_TIME items, respectively. HP DECtrace records the total elapsed time for this event, and all events, by default.

However, if a SUB_RESPONSE event occurs between the final form request and the end of a task, the application node cannot send the processing time back to the submitter node. In fact, neither the NETWORK_TIME nor the PROCESSING_TIME items are available, so HP DECtrace collects a value of zero for both items.

Note

When the node name is not specified in ACMSGEN, the SUB_RESPONSE event does not log the APPL_NODE item in most cases. However, if you use TDMS or stream I/O, the SUB_RESPONSE event logs the APPL_NODE item for those operations.

APL_RESPONSE

The APL_RESPONSE event is a duration event that records the time the application node takes to respond to an exchange step, excluding the network and forms product overhead associated with the exchange step. This event is written to the data collection file by the EXC. Having a separate response time event on the back-end node allows you to make adjustments on this node and observe the effects isolated on one node.

ACMS logs the start of the event when an exchange step is completed, or, if no exchange step has executed yet within this task, ACMS logs the start of the event when the Application Execution Controller (EXC) starts the task. ACMS logs the end of the event when the next exchange step within the same task starts, or, if no exchange steps follow, when the task is completed. Figure 15–2 shows when ACMS logs the APL_RESPONSE event.

Using HP DECtrace with ACMS Applications

15.3 Collecting Event Data for ACMS

Figure 15–2 Measuring the APL_RESPONSE Event

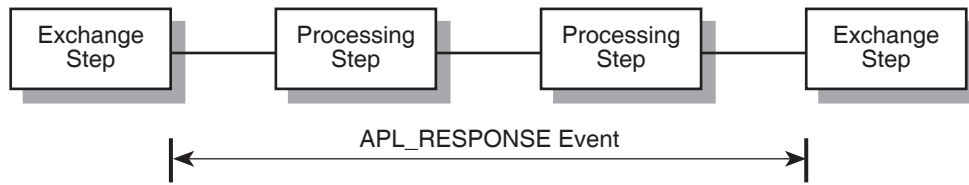

TAY-0002-AF

The rules that apply to the SUB_RESPONSE event regarding tasks with no I/O operations, tasks that call other tasks, or chained tasks also apply to the APL_RESPONSE event.

COMPRESSED_MSG

The COMPRESSED_MSG event shows the effect of data compression on network messages sent between the application and submitter nodes. This event is written to the data collection file by the Stream Services (STRM) and Server Services (SER). The COMPRESSED_MSG event is a point event. The purpose of a point event is to mark the occurrence of an operation, rather than to measure the duration of the event.

The network messages contain exchange step and task argument workspace data that is communicated between the EXC process and the agent process. ACMS logs one COMPRESSED_MSG event whenever a message is transmitted or received over a network connection, and logs a second COMPRESSED_MSG event when it receives a compressed message over the network. The size of the original message and the size of the compressed message are logged, together with the compression ratio that indicates the factor by which ACMS compressed the data.

15.3.1.2 HP DECtrace and ACMS Items

Each event has various items associated with it. These items include a set of standard HP DECtrace resource utilization items and a set of facility-specific items.

Table 15–1 lists the standard resource utilization items.

Table 15–1 Resource Utilization Items

Item	Description	Data type	Usage
BIO	Number of buffered I/O operations	Longword	Counter
DIO	Number of direct I/O operations	Longword	Counter
PAGEFAULTS	Total number of hard and soft page faults	Longword	Counter
PAGEFAULT_IO	Number of hard page faults (that is, page faults to or from the disk)	Longword	Counter
CPU	Total amount of CPU time in tens of milliseconds	Longword	Counter
CURRENT_PRIO	Current priority of the process	Word	Counter
VIRTUAL_SIZE	Number of virtual pages currently mapped for the process	Longword	Counter

(continued on next page)

Using HP DECtrace with ACMS Applications

15.3 Collecting Event Data for ACMS

Table 15–1 (Cont.) Resource Utilization Items

Item	Description	Data type	Usage
WS_SIZE	Current working set size of the process	Longword	Counter
WS_PRIVATE	Number of pages in the working set that are private to the process	Longword	Counter
WS_GLOBAL	Number of pages in the working set that are globally shared among processes on the system	Longword	Counter

The set of standard resource utilization items is often taken as a whole. To facilitate this, the items can be referred to by the group name: RESOURCE_ITEMS.

Table 15–2 describes the items that are specific to ACMS.

Table 15–2 ACMS Data Items

Item	Description	Data type	Usage	When Reported
APPL_SPEC	Application specification	Fixed ASCIC(39)	Text	Start
APPL_NODE	Node name	Fixed ASCIC(15)	Text	Start
TASK_NAME	Task name	Fixed ASCIC(31)	Text	Start
STEP_NAME	Name of exchange or processing step	Fixed ASCIC(31)	Text	Start
REQ_FORM_NAME	Name of the HP DECforms request	Fixed ASCIC(31)	Text	Start
DEVICE_NAME	Name of user's login device	Fixed ASCIC(8)	Text	Start
PROCEDURE_INDEX	Numeric index uniquely identifying the procedure within the server	Longword	Level	Start
SERVER_NAME	Name of the server executing the procedure	Fixed ASCIC(31)	Text	Start
SEND_ID	DECforms send record ID	Fixed ASCIC(31)	Text	Start
RECEIVE_ID	DECforms receive record ID	Fixed ASCIC(31)	Text	Start
TXN_ID	Transaction ID	Fixed ASCIC(36)	Text	Start
NETWORK_TIME	The NETWORK_TIME item is the part of the response time that is spent in communications over the network between the submitter and application nodes. The NETWORK_TIME item is measured in milliseconds.	Longword	Level	End

(continued on next page)

Using HP DECtrace with ACMS Applications

15.3 Collecting Event Data for ACMS

Table 15–2 (Cont.) ACMS Data Items

Item	Description	Data type	Usage	When Reported
PROCESSING_TIME	The PROCESSING_TIME item represents the part of the SUB_RESPONSE response time that is spent in processing on the application node. Together, the NETWORK_TIME and PROCESSING_TIME items make up the entire response time measured by the SUB_RESPONSE event. The PROCESSING_TIME item is measured in milliseconds.	Longword	Level	End
APL_USERNAME	The submitter's OpenVMS user name on the application node. APL_USERNAME is actually the proxy translation of the front-end OpenVMS user name. In previous versions of ACMS, this item was called the SUBMITTER_NAME item.	Fixed ASCIC(12)	Text	Start
SUB_USERNAME	The OpenVMS user name of the submitter, taken from the remote node. Note that the SUB_USERNAME item is not the same as the SUBMITTER_NAME item available in previous versions of ACMS.	Fixed ASCIC(12)	Text	Start
EXCH_STEP_NAME	The label of the most recently executed exchange step. For those events reported at the beginning of a task, before any exchange step has executed, this item holds the string ACMS\$TASK_BEGIN.	Fixed ASCIC(31)	Text	Start
PARENT_TASK	An item used when a task is called by another task. The PARENT_TASK item holds the name of the calling task. ACMS leaves this item blank, if the TASK event is not a called task.	Fixed ASCIC(31)	Text	Start
PROC_STEP_TYPE	An item that identifies the function of a processing step. The PROC_STEP_TYPE item holds one of the following strings: <ul style="list-style-type: none"> – ACMS\$PROCEDURE_CALL – ACMS\$DCL_SERVER – ACMS\$TASK_CALL <p>In previous versions of ACMS, PROCESSING_STEP events were logged only on steps that made procedure calls or DCL server commands.</p>	Fixed ASCIC(20)	Text	Start

(continued on next page)

Using HP DECtrace with ACMS Applications

15.3 Collecting Event Data for ACMS

Table 15–2 (Cont.) ACMS Data Items

Item	Description	Data type	Usage	When Reported
PROCEDURE_NAME	The name of the step procedure in the procedure server. The PROCEDURE_NAME item makes the final performance report easier to interpret, in comparison to the PROCEDURE_INDEX item. TDB files built with versions of ACMS previous to Version 3.3 do not contain procedure names. In this case, ACMS logs the following string to HP DECtrace for the PROCEDURE_NAME item: ACMS\$PROCEDURE_ <procedure_index>	Fixed ASCIC(31)	Text	Start
SERVER_INDEX	The numeric index of the server in the application.	Longword	Level	Start
TXN_STATUS	An identifier field that describes the final status of a DECdtm transaction. The field format is ACMS\$<vms-identifier>, where <vms-identifier> is the identifier field of a standard OpenVMS message, for example ACMS\$NORMAL.	Fixed ASCIC(31)	Text	End
ORIGINAL_SIZE	A longword value that represents the size, in bytes, of a network message prior to data compression.	Longword	Level	Point
COMPRESSED_SIZE	A longword value that represents the size, in bytes, of a network message that has been compressed.	Longword	Level	Point
COMPRESSN_RATIO	A longword value that represents the percentage of data compression achieved. The compression ratio is expressed as a percentage in the range 0 to 99. A value of 0 indicates that ACMS was not able to compress the message. A value in the range 1 to 99 indicates the amount by which ACMS was able to reduce the size of the message. ACMS uses the following formula to calculate the compression ratio: $\text{RATIO} = ((\text{ORIG_SIZE} - \text{COMP_SIZE}) / \text{ORIG_SIZE}) * 100$ <p>In the formula, ORIG_SIZE is the size of the original message and COMP_SIZE is the size of the compressed message.</p>	Longword	Level	Point
MESSAGE_SRC	The name of the node that sends the network message.	Fixed ASCIC(15)	Text	Point

(continued on next page)

Using HP DECtrace with ACMS Applications

15.3 Collecting Event Data for ACMS

Table 15–2 (Cont.) ACMS Data Items

Item	Description	Data type	Usage	When Reported
MESSAGE_DEST	The name of the node that receives the network message.	Fixed ASCIC(15)	Text	Point

15.3.1.3 DECtrace Cross Facility Items

The DECtrace **cross facility items** allow users who interpret DECtrace data to better understand the context in which certain events are executed and reported in DECtrace. The cross facility items are DECtrace items whose values can be set by one facility and then collected by any number of facilities. Use of cross facility items enables facilities that operate together to relate events in the final DECtrace report. To relate events across facilities, the events in both facilities must collect the value of the cross facility item in common.

Table 15–3 lists the HP DECtrace cross facility items.

Table 15–3 Cross Facility Items

Item	Description	Data type	Usage
CROSS_FAC_2	Represents the ACMS SERVER_INDEX data item	Longword	Level
CROSS_FAC_7	Represents the ACMS PROCEDURE_INDEX data item	Longword	Level
CROSS_FAC_14	For general, unrestricted use.	Longword	Level

In ACMS, the PROCEDURE_CALL event collects the SERVER_INDEX (CROSS_FAC_2) and PROCEDURE_INDEX (CROSS_FAC_7) items. The PROCEDURE_CALL event is defined in the ALL, PERFORMANCE, and RESPONSE classes.

Rdb collects the CROSS_FAC_2 and CROSS_FAC_7 items during the TRANSACTION event, which is included in the Rdb PERFORMANCE, ALL and RDBEXPERT classes.

Note

Make sure that you update your Rdb facility definition with the facility definition shipped with HP DECtrace Version 1.2. This definition includes the CROSS_FAC_2 and CROSS_FAC_7 items for Rdb.

The HP DECtrace cross facility items are supported in HP DECtrace V1.2 or higher.

Additionally, HP DECtrace provides a cross facility item, CROSS_FAC_14, for general, unrestricted use. You can define this cross facility item for your application needs. ACMS includes collection of the CROSS_FAC_14 item in all events.

15.3.2 How to Use Cross Facility Items

The following description and example shows how DECtrace uses cross facility items to relate the ACMS PROCEDURE_CALL event to Rdb TRANSACTION events.

Just prior to ACMS executing the start of the PROCEDURE_CALL event within the application, ACMS reports a unique identifier to DECtrace. The unique identifier is implemented using two longwords: the ACMS server and procedure indexes. HP DECtrace stores the longword value for the server index in the CROSS_FAC_2 item, and the value for the procedure index in the CROSS_FAC_7 item.

ACMS logs the start of the PROCEDURE_CALL event, and begins to collect the cross facility item values reported to HP DECtrace just prior to the start event. The same cross facility items are included in the start event collections for subsequent ACMS PROCEDURE_CALL and Rdb TRANSACTION events, until ACMS reports new values to DECtrace.

Figure 15-3 illustrates two PROCEDURE_CALL events, each of which includes Rdb TRANSACTION events. The server index for both procedure calls is 5; the procedure indexes are 27 and 14, respectively.

Figure 15-3 Relating the ACMS PROCEDURE_CALL and Rdb TRANSACTION Events

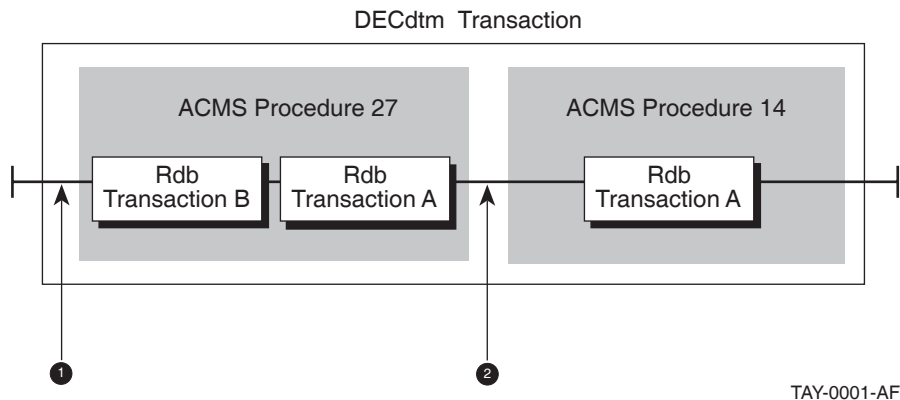

In Figure 15-3, the following actions occur:

- 1 Just before ACMS executes the first procedure, the two index values, 5 and 27, are sent to HP DECtrace to be stored in two cross facility items. After this, start events for the first PROCEDURE_CALL and two TRANSACTION events collect these item values from HP DECtrace.
- 2 Before the second procedure begins, the indexes 5 and 14 are written to the same cross facility items, replacing their previous values. The PROCEDURE_CALL and TRANSACTION start events that follow include the cross facility item values in their data collection. This continues for all such event occurrences and, in the end, all related PROCEDURE_CALL and TRANSACTION events have these cross facility items in common.

In the final report, HP DECtrace relates events based on common cross facility item values. As a result, the Rdb TRANSACTION events are grouped with the appropriate ACMS PROCEDURE_CALL events in the report listing. In this way, you can distinguish which transactions are performed within Procedure 27, and which procedures initiated occurrences of Transaction A.

Using HP DECtrace with ACMS Applications

15.4 ACMS Collection Classes

15.4 ACMS Collection Classes

Collection classes are made up of a predefined set of events and associated items. You can collect a set of related events, based on the class in which they are defined.

Table 15–4 summarizes the events and items collected in the ACMS collection classes.

Table 15–4 ACMS Collection Classes

Class Name	Events Collected	Items Collected ¹
ALL	All events	*
ALL_NO_CF	All events	Cross facility items are not collected
PERFORMANCE	All events, except: SUB_RESPONSE APL_RESPONSE	*
PERFORMANCE_NO_CF	All events, except: SUB_RESPONSE APL_RESPONSE	Cross facility items are not collected
RESPONSE	SUB_RESPONSE APL_RESPONSE TRANSACTION PROCESSING_STEP TASK_WAIT PROCEDURE_CALL	*
RESPONSE_NO_CF	SUB_RESPONSE APL_RESPONSE TRANSACTION PROCESSING_STEP TASK_WAIT PROCEDURE_CALL	Cross facility items are not collected

¹Asterisk (*) indicates all items associated with these events are collected.

Table 15–5 lists the events and items that make up the ALL collection class. The ALL class is composed of the full set of events and items available for collection from a product. Note that the ALL_NO_CF class is the default class for ACMS.

Table 15–5 Events and Items Available in the ALL Collection Class for ACMS

Event	Event Type	Items
TASK	Duration	APPL_SPEC, TASK_NAME, PARENT_TASK, STEP_NAME, SUB_USERNAME, APL_USERNAME, CROSS_FAC_14
EXCHANGE_STEP	Duration	APPL_SPEC, DEVICE_NAME, REQ_FORM_NAME, STEP_NAME, TASK_NAME, SEND_ID, RECEIVE_ID, SUB_USERNAME, APL_USERNAME, CROSS_FAC_14
PROCESSING_STEP	Duration	APPL_SPEC, STEP_NAME, TASK_NAME, TXN_ID, SUB_USERNAME, APL_USERNAME, PROC_STEP_TYPE, EXCH_STEP_NAME, CROSS_FAC_14

(continued on next page)

Using HP DECtrace with ACMS Applications

15.4 ACMS Collection Classes

Table 15–5 (Cont.) Events and Items Available in the ALL Collection Class for ACMS

Event	Event Type	Items
PROCEDURE_CALL	Duration	APPL_SPEC, PROCEDURE_INDEX, SERVER_NAME, STEP_NAME, TASK_NAME, RESOURCE_ITEMS, TXN_ID, SUB_USERNAME, APL_USERNAME, PROCEDURE_NAME, SERVER_INDEX, EXCH_STEP_NAME, CROSS_FAC_2, CROSS_FAC_7, CROSS_FAC_14
REMOTE_REQUEST	Duration	APPL_NODE, APPL_SPEC, DEVICE_NAME, REQ_FORM_NAME, TASK_NAME, SUB_USERNAME, EXCH_STEP_NAME, CROSS_FAC_14
FORMS_ENABLE	Duration	APPL_NODE, APPL_SPEC, DEVICE_NAME, REQ_FORM_NAME, SUB_USERNAME, CROSS_FAC_14
FORMS_REQUEST	Duration	APPL_NODE, APPL_SPEC, DEVICE_NAME, SEND_ID, RECEIVE_ID, SUB_USERNAME, TASK_NAME, REQ_FORM_NAME, EXCH_STEP_NAME, CROSS_FAC_14
TASK_WAIT	Duration	APPL_SPEC, TASK_NAME, SERVER_NAME, TXN_ID, STEP_NAME, PROCEDURE_NAME, SUB_USERNAME, APL_USERNAME, EXCH_STEP_NAME, CROSS_FAC_14
TRANSACTION	Duration	APPL_SPEC, TASK_NAME, STEP_NAME, TXN_ID, SUB_USERNAME, APL_USERNAME, TXN_STATUS, EXCH_STEP_NAME, CROSS_FAC_14
SUB_RESPONSE	Duration	APPL_NODE, APPL_SPEC, DEVICE_NAME, TASK_NAME, EXCH_STEP_NAME, NETWORK_TIME, PROCESSING_TIME, SUB_USERNAME, CROSS_FAC_14
APL_RESPONSE	Duration	APPL_SPEC, TASK_NAME, APL_USERNAME, EXCH_STEP_NAME, SUB_USERNAME, CROSS_FAC_14
COMPRESSED_MSG	Point	ORIGINAL_SIZE, COMPRESSED_SIZE, COMPRESSN_RATIO, MESSAGE_SRC, MESSAGE_DEST, CROSS_FAC_14

Table 15–6 lists the events and items that make up the PERFORMANCE collection class. The PERFORMANCE collection class includes events and items that are useful for applications and database tuning. HP DECtrace collects all items associated with events in this class.

Table 15–6 Events and Items Available in the PERFORMANCE Class for ACMS

Event	Event Type	Items ¹
TASK	Duration	*
EXCHANGE_STEP	Duration	*
PROCESSING_STEP	Duration	*
PROCEDURE_CALL	Duration	*
REMOTE_REQUEST	Duration	*
FORMS_ENABLE	Duration	*
FORMS_REQUEST	Duration	*
TASK_WAIT	Duration	*
TRANSACTION	Duration	*

¹* Indicates that all associated items are collected for this event.

(continued on next page)

Using HP DECtrace with ACMS Applications

15.4 ACMS Collection Classes

Table 15–6 (Cont.) Events and Items Available in the PERFORMANCE Class for ACMS

Event	Event Type	Items ¹
COMPRESSED_MSG	Point	*

¹*: Indicates that all associated items are collected for this event.

Table 15–7 lists the events and items that make up the RESPONSE collection class. The RESPONSE class groups together events and items that are commonly used in ACMS response time measurements. For each event, DECtrace collects all items associated with the event.

Table 15–7 Events and Items Available in the RESPONSE Collection Class for ACMS

Event	Event Type	Items ¹
SUB_RESPONSE	Duration	*
APL_RESPONSE	Duration	*
TRANSACTION	Duration	*
PROCESSING_STEP	Duration	*
TASK_WAIT	Duration	*
PROCEDURE_CALL	Duration	*

¹*: Indicates that all associated items are collected for this event.

15.4.1 Registering the Facility Definition

HP DECtrace can collect event data from a number of layered products and applications. These other products are referred to as **facilities**, and each has a facility definition registered in the HP DECtrace administration database.

At the installation of ACMS, the location of the ACMS facility definition depends on whether or not HP DECtrace is already installed on the system:

- If HP DECtrace installation preceded ACMS installation, the ACMS facility definition is registered in the HP DECtrace administration database. When ACMS is subsequently installed, the ACMS facility definition is registered and you can create a selection and schedule a collection.
- If HP DECtrace is not already installed on the system at the time of ACMS installation, the ACMS facility definition is inserted in the library file SYS\$LIBRARY:EPC\$FACILITY.TLB. If you later install HP DECtrace, the HP DECtrace EPC\$INSERT post-installation procedure inserts the ACMS facility definitions in the HP DECtrace administration database.

You can use the SHOW DEFINITION command to list the facilities installed on your system. The following example shows the facility definitions on the node TSTVAX:

```

$ COLLECT SHOW DEFINITION /FORMAT=Names_Only
25-APR-1991 15:58      Facility Definition Information      Page 1
Names Only Report                                DECtrace V1.0-0

```

Using HP DECtrace with ACMS Applications

15.4 ACMS Collection Classes

Facility:	Version:	Creation Date:	Class:
ACMS	V3.2-0	7-APR-91 17:23	ALL PERFORMANCE (D)
ATM_SAMPLE	V1.0	25-APR-91 14:17	ALL (D)
MY_FACILITY	V2.0	12-APR-91 10:27	ALL WORKLOAD (D)
RDBVMS	V3.2-0	20-APR-91 15:21	ALL PERFORMANCE (D) WORKLOAD

15.4.2 Creating a Selection

HP DECtrace can collect data from either all the facilities registered with it, or just the ones you are interested in. To specify a subset of the available facilities, use the CREATE SELECTION command to create a **facility selection** which consists of:

- Selection name
- List of facilities for which to collect data
- Class of data to collect for each facility

The basic format for the CREATE SELECTION command is:

```
CREATE SELECTION selection_name /FACILITY=(facility_name[, ... ])
```

The following example defines the selection MY_SELECTION to collect the default data for ACMS:

```
$ COLLECT CREATE SELECTION MY_SELECTION /FACILITY=ACMS
```

However, to define a more detailed selection, use the /OPTIONS qualifier. This qualifier takes a file name as an argument. The options file lists each facility and the collection class you want to use. Each facility is described on a separate line. If you specify /OPTIONS but do not include a file name, HP DECtrace prompts you for the options. The format of the facility description in the options file is:

```
FACILITY facility-name [/VERSION="version-code"] [/CLASS=class-name]
```

facility-name

The name of the facility for which to collect data.

version-code

A text string identifying the version of the facility. The string must be enclosed with quotation marks (" ").

class-name

The class of data that you want collected for the facility.

The following example creates the facility selection SELECT_ALL to collect all of the possible data for ACMS and only the performance-related data from MY_FACILITY:

```
$ COLLECT CREATE SELECTION SELECT_ALL /OPTIONS
Option> FACILITY ACMS /CLASS=ALL
Option> FACILITY MY_FACILITY /CLASS=PERFORMANCE
Option> CTRL/Z
$
```

Using HP DECtrace with ACMS Applications

15.4 ACMS Collection Classes

15.4.3 Collecting Cross Facility Items

To collect cross facility items, use the CREATE SELECTION command to:

1. Specify the facilities for which to collect data.
2. Specify the collection class that includes the cross facility items to be collected for each facility involved.

The following classes include the PROCEDURE_CALL event, which collects the CROSS_FAC_2 and CROSS_FAC_7 values:

- PERFORMANCE
- RESPONSE
- ALL

To collect the CROSS_FAC_2 or CROSS_FAC_7 values, specify any one of these classes in the DECtrace CREATE SELECTION command.

If you are using the CROSS_FAC_14 value in your application, this value is logged to HP DECtrace during any ACMS event and collected by HP DECtrace if any of the above classes are selected.

To collect ACMS and Rdb data, use commands similar to the following:

```
DECtrace> create selection <sel-name> /options
Option> facility acms /class=performance
Option> facility rdbvms /class=performance
Option> Ctrl/Z

DECtrace> schedule collection <coll-name> <coll-file> -
  _DECtrace> /selection=<sel-name> /begin=<start-time> -
  _DECtrace> /end=<end-time>
```

15.4.4 Scheduling Data Collection

You must schedule data collection on your system before DECtrace can begin collecting information about ACMS. The scheduling criteria include:

- Output file for the collected data
- Start and end times (or alternately, the duration)
- Facility selection to use
- Scope of the collection (the entire cluster or just the local node)

Note that although you can schedule many data collections on a node, only one collection can be active on a node at any time. DECtrace does not allow you to schedule data collections that overlap or run simultaneously.

The following example schedules the collection MY_COLLECTION to begin at 11:00 and end at 12:00 on the current day. The collection uses the facility selection SELECT_ALL and runs on the local node. DECtrace stores the collected data in the file MY_DATA.DAT in your default device and directory:

```
$ COLLECT SCHEDULE COLLECTION MY_COLLECTION MY_DATA.DAT -
_ $ /SELECTION=SELECT_ALL -
_ $ /BEGINNING=11:00 /ENDING=12:00 -
_ $ /NOCLUSTER /PROTECTION=(W:W)
%EPC-S-SCHED, Data collection MY_COLLECTION is scheduled
```

Using HP DECtrace with ACMS Applications

15.4 ACMS Collection Classes

Alternatively, you can use the /DURATION qualifier in place of the /ENDING qualifier. You must specify the duration as a relative OpenVMS time. For example:

```
$ COLLECT SCHEDULE COLLECTION MY_COLLECTION MY_DATA.DAT -
_.$ /SELECTION=MY_SELECTION -
_.$ /BEGINNING=11:00 /DURATION="1:" -
_.$ /NOCLUSTER /PROTECTION=(W:W)
%EPC-S-SCHED, Data collection MY_COLLECTION is scheduled
```

You can schedule data collection either locally or clusterwide by using the /[NO]CLUSTER qualifier. By default, the SCHEDULE COLLECTION command schedules data collection to occur on every node in the cluster. To schedule data collection on a subset of the cluster, you must log in to each node that you want data collection to occur on and schedule local data collection on that node by specifying /NOCLUSTER. Note that on a standalone system the /CLUSTER qualifier is ignored.

15.4.5 Using Registration IDs

In addition to scheduling when to collect data, you can specify which OpenVMS processes you wish to collect data from during the collection interval.

You select the processes from which to collect data by specifying one or more **registration IDs** with the SCHEDULE COLLECTION command. The registration ID is a facility- or process-specific character string that is known to the process only at run time.

On the application node, the registration ID is the name of an ACMS application. It identifies the Application Execution Controller and server processes that make up the application. This allows you to collect data for a specific ACMS application.

HP DECtrace also registers process-specific information when an image containing HP DECtrace service routine calls activates. The process-specific registration IDs include the EPID (extended process ID), the image name, the user name, and the process name. This allows you to collect data on a per-process, per-user, or per-image basis.

The following example schedules a collection to gather ACMS event data from user JONES running the PAYROLL application:

```
$ COLLECT SCHEDULE COLLECTION MY_COLLECTION MY_DATA.DAT -
_.$ /SELECTION=ACMS_SEL -
_.$ /BEGINNING=11:00 /DURATION="1:" -
_.$ /NOCLUSTER /PROTECTION=(W:W) -
_.$ /REGISTRATION_ID=(JONES,WORK1:[FINANCE]PAYROLL.EXE)
%EPC-S-SCHED, Data collection MY_COLLECTION is scheduled
```

On the submitter node, the registration ID is "ACMS_AGENT." The registration ID "ACMS_AGENT" can be used to record TDMS, Request Interface, or DECforms I/O performed by an agent process.

Use the DECtrace SHOW REGISTER command to display the processes and images available for data collection on your system.

Using HP DECtrace with ACMS Applications

15.5 Creating a Report Based on Collected Data

15.5 Creating a Report Based on Collected Data

You can use HP DECtrace to produce reports based on the data collected from one or more HP DECtrace collections. The two steps in producing HP DECtrace reports are:

1. Format and merge the data files.
2. Generate the report.

15.5.1 Formatting and Merging Data Files

Before HP DECtrace can generate a report on the data collected for your collections, you must use the `FORMAT` command to format the data in the data files into an Rdb database. (An RMS formatted file is also available for users who plan to create their own reports based on the data. See the HP DECtrace documentation for information.) The following example formats the data in the file `MY_DATA.DAT` and stores the formatted data in an Rdb database named `FORMATTED_DATA.RDB`:

```
$ COLLECT FORMAT MY_DATA.DAT FORMATTED_DATA
```

You can also use the `FORMAT` command to combine the data files from two or more collections into one formatted database. However, these collections must have been scheduled using the same facility selection.

The two ways you can combine data files are: format several data files at once into the same Rdb database, or add a data file to an existing formatted database. The following example combines the data collected from several collections into a new formatted database named `WEEK.RDB`:

```
$ COLLECT FORMAT MONDAY.DAT, TUESDAY.DAT, WEDNESDAY.DAT WEEK
```

The following example adds the contents of the data file `THURSDAY.DAT` to the existing formatted database `WEEK.RDB`:

```
$ COLLECT FORMAT /MERGE THURSDAY.DAT WEEK
```

See the description of the `FORMAT` command in the DECtrace documentation for a list of optimization parameters that you can use to speed up formatting operations.

15.5.2 Generating a Report

DECtrace can generate tabular reports based on the data in an Rdb formatted database. Table 15–8 lists the three different types of reports that you can produce.

Table 15–8 DECtrace Reports

Type	Description
DETAIL	Actual values of the items collected for each event
FREQUENCY	Event occurrence summary based on a selected time interval
SUMMARY (default)	Summary statistics about the collected data

In the simplest case, the `REPORT` command creates a Summary Report on all of the data in the formatted database and displays the report on your current `SYS$OUTPUT` device (usually, your terminal). For example:

Using HP DECtrace with ACMS Applications

15.5 Creating a Report Based on Collected Data

```
$ COLLECT REPORT FORMATTED_DATA.RDB
```

You can further refine the report with the /FACILITY qualifier. The following example generates a Summary Report only on ACMS data and writes the report to the file MY_REPORT.TXT:

```
$ COLLECT REPORT FORMATTED_DATA.RDB /FACILITY=ACMS -
_ $ /OUTPUT=MY_REPORT.TXT
```

Example 15-1 shows a typical report, MY_REPORT.TXT, based on ACMS event data.

Example 15-1 Summary Report for ACMS Event Data

```
19-APR-1991 16:57          Summary Report          Page 1
Selection: ACMS_ONLY          DECtrace V1.0-0
```

```
Event: EXCHANGE_STEP  In Facility: ACMS          Version: V3.2-0
```

```
          Elapsed
Minimum      2.17
Maximum     1489.29
Mean         17.90
Std Dev      109.82
95 Prct      233.16
Total        5334.71
Count         298
```

%EPC-I-RPQU_BAD_95, 95 Prct for events with counts under 1000 are less precise

```
19-APR-1991 16:57          Summary Report          Page 2
Selection: ACMS_ONLY          DECtrace V1.0-0
```

```
Event: PROCEDURE_CALL  In Facility: ACMS          Version: V3.2-0
```

	Elapsed	BUFFERED IO	CPU TIME	CURREN T PRIO	DIRECT IO	PAGEFAULTS
Minimum	0.16	0	5	4	4	0
Maximum	15.64	27	229	5	238	1124
Mean	0.32	0.11	7.89	4.79	6.44	4.03
Std Dev	0.89	1.58	12.95	0.40	13.57	65.31
95 Prct	2.08	3.21	33.29	5.58	33.04	132.04
Total	97.06	35	2346	1424	1914	1199
Count	297					

	PAGEFAULT IOs	Proc Idx	VIRTUAL SIZE	GLOBAL WS	PRIVATE WS
Minimum	0	1	8148	773	1271
Maximum	25	1	8148	797	1347
Mean	0.08	1.00	8148.00	796.71	1344.20
Std Dev	1.45	0.00	0.00	1.63	12.61
95 Prct	2.92	1.00	8148.00	799.92	1368.93
Total	25	297	2419956	236624	399228
Count	297				

```
WORKING
SET SIZ
```

(continued on next page)

Using HP DECtrace with ACMS Applications

15.5 Creating a Report Based on Collected Data

Example 15-1 (Cont.) Summary Report for ACMS Event Data

```

Minimum      2824
Maximum      3124
Mean         3113.89
Std Dev      54.20
95 Prct      3220.14
Total        924828
Count        297
  
```

%EPC-I-RPQU_BAD_95, 95 Prct for events with counts under 1000 are less precise

```

19-APR-1991 16:57          Summary Report          Page 3
Selection: ACMS_ONLY          DECtrace V1.0-0
  
```

```

Event: PROCESSING          In Facility: ACMS          Version: V3.2-0
      _STEP
  
```

Elapsed

```

Minimum      0.17
Maximum      15.74
Mean         0.33
Std Dev      0.90
95 Prct      2.11
Total        100.64
Count        297
  
```

%EPC-I-RPQU_BAD_95, 95 Prct for events with counts under 1000 are less precise

%EPC-I-NOEND, 1 Start Event Records had no matching End

```

19-APR-1991 16:57          Summary Report          Page 4
Selection: ACMS_ONLY          DECtrace V1.0-0
  
```

```

Event: TASK          In Facility: ACMS          Version: V3.2-0
  
```

Elapsed

```

Minimum      5436.31
Maximum      5436.31
Mean         5436.31
Std Dev      0.00
95 Prct      5436.31
Total        5436.31
Count        1
  
```

%EPC-I-RPQU_BAD_95, 95 Prct for events with counts under 1000 are less precise

```

19-APR-1990 16:57          Index          Page 5
Selection: ACMS_ONLY          DECtrace V1.0-0
  
```

Report Index

Facility Name	Event Name	Page
ACMS	EXCHANGE_STEP	1
ACMS	PROCEDURE_CALL	2
ACMS	PROCESSING_STEP	3
ACMS	TASK	4

Using HP DECtrace with ACMS Applications

15.5 Creating a Report Based on Collected Data

Use the /STATISTICS qualifier to specify the statistics HP DECtrace uses in the Summary Report. This feature allows you to create customized reports that present information in the manner most suitable to your needs. The valid statistics are:

- ALL
- COUNT (default)
- MAXIMUM
- MEAN
- MINIMUM
- STANDARD_DEVIATION
- TOTAL
- 95_PERCENTILE

The following example generates a Summary Report based on the data collected for ACMS using the statistics MAXIMUM, MINIMUM, and MEAN:

```
$ COLLECT REPORT FORMATTED_DATA.RDB /FACILITY=ACMS -
_ $ /TYPE=SUMMARY /STATISTICS=(MAXIMUM,MINIMUM,MEAN) -
_ $ /OUTPUT=MY_SUMMARY.TXT
```

By default, HP DECtrace reports on the data collected for all the events contained in the formatted database. You can use the /EVENTS qualifier to restrict the report to specific events. The following example generates a report based on the data collected for a subset of the events in ACMS:

```
$ COLLECT REPORT FORMATTED_DATA /OUTPUT=MY_REPORT.TXT -
_ $ /FACILITY=ACMS -
_ $ /EVENTS=(TASK,TASK_WAIT,FORMS_REQUEST)
```

15.5.3 Generating a Report with Cross Facility Items

To generate a formatted report for cross facility items whose values are equal for related events, follow these steps:

1. Use the HP DECtrace REPORT command options to select the relevant report data.
2. Use the HP DECtrace join operation to associate the events with each other.

For example, if you join the CROSS_FAC_2 and CROSS_FAC_7 items of the ACMS PROCEDURE_CALL event with those of an Rdb database TRANSACTION event, DECtrace relates each transaction occurrence with the procedure call in which it occurred.

To display ACMS and Rdb summary information for a specific server and procedure, use a HP DECtrace command similar to the following:

```
DECtrace> REPORT /OPTIONS /STATISTICS=ALL /TYPE=SUMMARY
Option> event PROCEDURE_CALL /facility=acms
Option> event TRANSACTION /facility=rdbvms
Option> restrict item server_name=<server>
Option> restrict item procedure_name=<procedure>
Option> join PROCEDURE_CALL.cross_fac_2=TRANSACTION.cross_fac_2
Option> join PROCEDURE_CALL.cross_fac_7=TRANSACTION.cross_fac_7
Option> Ctrl/Z
```

Example 15–2 contains a summary report, which illustrates the related ACMS PROCEDURE_CALL and Rdb TRANSACTION events.

Using HP DECtrace with ACMS Applications

15.5 Creating a Report Based on Collected Data

Example 15-2 DECtrace Summary Report

```
> COLLECT REPORT /OPTIONS /STATISTICS=ALL /TYPE=SUMMARY
Option> join PROCEDURE_CALL.CROSS_FAC_2=TRANSACTION.CROSS_FAC_2
Option> event PROCEDURE_CALL /FACILITY=ACMS
Option> event TRANSACTION /FACILITY=RDBVMS
```

```
11-May-1993 10:00          Summary Report          Page 1
Selection: xxx_xxx          DECtrace V1.2-0

Event:  PROCEDURE_CALL  In Facility:  ACMS          Version:  V3.3-0B
```

```
CROSS_FAC_2 : 1
      Elapsed  BUFFERED IO  CPU TIME  CURRENT  DIRECT IO  PAGEFAULTS
                        Prio
Minimum  0.30          0           6         7         6         1
Maximum  0.47          0           7         7         8         2
Mean     0.38          0.00        6.50      7.00      7.00      1.50
Std Dev  0.12          0.00        0.70      0.00      1.41      0.70
95 Prct  0.62          0.00        7.88      7.00      9.77      2.88
Total    0.77          0           13        14        14        3
Count    2
```

```
      PAGEFAULT  Proc Idx  VIRTUAL  GLOBAL WS  PRIVATE WS
      IOs          SIZE
Minimum  0           1         9676     755       1407
Maximum  2           1         9676     776       1407
Mean     1.00          1.00     9679.00  775.5     1407.00
Std Dev  1.41          0.00      0.00     0.70      0.00
95 Prct  3.77          1.00     9679.00  776.88   1407.00
Total    2           2         19358    1551     2814
Count2
```

```
      WORKING  CROSS_FAC_2
      SET SIZE
Minimum  4096          1
Maximum  4096          1
Mean     4096.00      1.00
Std Dev  0.00          0.00
95 Prct  4096.00      1.00
Total    8192          2
Count    2
```

```
11-May-1993 10:00          Summary Report          Page 1
Selection: xxx_xxx          DECtrace V1.2-0

Event:  TRANSACTION  In Facility:  RDBVMS          Version:  T3.1-2
```

```
      Elapsed  AIJ File  BUFFERED  Buffer  Client PC
                        Writes  IO        Pool Rds
Minimum  0.10          0         0         0         3EC8
Maximum  0.16          0         0         2         3EC8
Mean     0.12          0.00      0.00      1.00      3EC8.00
Std Dev  0.04          0.00      0.00      1.41      0.00
95 Prct  0.21          0.00      0.00      3.77      3EC8.00
Total    0.25          0         0         2         7D90
Count    2
```

```
      WORKING  Trans Seq  CROSS_FAC_2
      SET SIZ  Num
```

(continued on next page)

Using HP DECtrace with ACMS Applications

15.5 Creating a Report Based on Collected Data

Example 15–2 (Cont.) DECtrace Summary Report

Minimum	4096	45	1
Maximum	4096	45	1
Mean	4096.00	45.00	1.00
Std Dev	0.00	0.00	0.00
95 Prct	4096.00	45.00	1.00
Total	8192	90	2
Count	2		

15.5.4 Creating a Customized Report

You can create customized reports that provide information on specific events and items. The /OPTIONS qualifier to the REPORT command allows you to specify characteristics for individual events and items. Example 15–3 shows the command to generate a report which uses a different report format for each event.

Example 15–3 Using Reporting Options to Generate a Customized Report

```
$ COLLECT REPORT MY_DATABASE -  
    /SINCE = "01-JAN-1991" -  
    /WIDTH = 80 -  
    /TYPE = SUMMARY -  
    /LENGTH = 66 -  
    /OUTPUT = ACMS.REPORT -  
    /STATISTICS = ALL -  
    /TITLE = "ACMS Reports" -  
    /OPTIONS  
  
EVENT EXCHANGE_STEP -  
    /FACILITY = ACMS -  
    /TYPE = FREQUENCY -  
    /INTERVAL = SECONDS -  
    /SUBTITLE = "ACMS Exchange Step Frequency Report"  
  
EVENT PROCEDURE_CALL -  
    /FACILITY = ACMS -  
    /GROUP_BY = (PROCEDURE_INDEX) -  
    /STATISTICS = (MINIMUM, MAXIMUM, MEAN, STANDARD_DEVIATION) -  
    /SUBTITLE = "ACMS Procedure Call Summary Report"  
  
EVENT PROCEDURE_CALL -  
    /FACILITY = ACMS -  
    /GROUP_BY = (PROCEDURE_INDEX) -  
    /TYPE = DETAIL -  
    /SUBTITLE = "ACMS Procedure Call Detail Report"  
ITEM PROCEDURE_INDEX /WIDTH = 9  
ITEM PROCEDURE_INDEX /REPORT_HEADER = "Procedure Index"  
RESTRICTION COLLECTION ACMS_COLL  
RESTRICTION EPID 2A8002DF,2A8002C1  
RESTRICTION IMAGE PAYROLL, INVENTORY  
RESTRICTION NODE ACMS1, ACMS2
```

Data from the MY_DATABASE formatted database is used for this report. The initial report command modifies several of the default qualifier values, such as the length of each report page and the date before which all data should be ignored. The /OPTIONS qualifier allows you to specify event and item qualifiers to either override the main qualifiers or provide additional restrictions to the report.

Using HP DECtrace with ACMS Applications

15.5 Creating a Report Based on Collected Data

Based on the first part of the REPORT command, all subreports, unless otherwise specified, contain data from the data collection file with a timestamp date greater than or equal to January 1, 1991. The report is 80 columns wide and 66 lines long. The subreports are Summary Reports with all possible statistics displayed. The report is written to a file called ACMS.REPORT in your current directory.

The first subreport is based on the EXCHANGE_STEP event. The facility, a required qualifier, is ACMS. The type qualifier is overridden to generate a Frequency Report with a count displayed for each second during which at least one event occurrence was recorded. A subtitle, "ACMS Exchange Step Frequency Report," is displayed on the first page of the subreport. The following example shows the REPORT options required for the first subreport:

```
EVENT EXCHANGE_STEP -
    /FACILITY = ACMS -
    /TYPE = FREQUENCY -
    /INTERVAL = SECONDS -
    /SUBTITLE = "ACMS Exchange Step Frequency Report"
```

The second subreport is a Summary Report based on the PROCEDURE_CALL event. Again, the facility name, ACMS, is a required qualifier. The statistics are divided into groups based on equivalent values of the PROCEDURE_INDEX item. The statistics type has been overridden from a default of ALL to include only MINIMUM, MAXIMUM, MEAN, and STANDARD DEVIATION. A subtitle is given to help distinguish the subreport from other sections of the main report. The following example shows the REPORT options required for the second subreport:

```
EVENT PROCEDURE_CALL -
    /FACILITY = ACMS -
    /GROUP_BY = (PROCEDURE_INDEX) -
    /STATISTICS = (MINIMUM, MAXIMUM, MEAN, STANDARD_DEVIATION) -
    /SUBTITLE = "ACMS Procedure Call Summary Report"
```

The third subreport is a Detail Report based on the PROCEDURE_CALL event. The report is ordered by the PROCEDURE_INDEX item in ascending order. The item width is modified to use 9 columns. The report header is changed to "Procedure Index." In the report, "Start" is added to the beginning of the item header by HP DECtrace to signify that the value is based on the start event. HP DECtrace uses end event values for duration events if the item was collected on the end event. In this case, the PROCEDURE_INDEX item is only collected on the start event. If this had been a point event, the item header would not have been changed.

The RESTRICTION option allows you to create a very specific report. In this case, only data from nodes ACMS1 and ACMS2, for collection ACMS_COLL, from processes 2A8002DF and 2A8002C1, and from images PAYROLL and INVENTORY is displayed. The following example shows the REPORT options required to generate the third subreport:

```
EVENT PROCEDURE_CALL -
    /FACILITY = ACMS -
    /GROUP_BY = (PROCEDURE_INDEX) -
    /TYPE = DETAIL -
    /SUBTITLE = "ACMS Exchange Step Detail Report"
ITEM PROCEDURE_INDEX /WIDTH = 9
ITEM PROCEDURE_INDEX /REPORT_HEADER = "Procedure Index"
RESTRICTION EPID 2A8002DF,2A8002C1
RESTRICTION IMAGE PAYROLL, INVENTORY
RESTRICTION NODE ACMS1, ACMS2
```

Using HP DECtrace with ACMS Applications

15.5 Creating a Report Based on Collected Data

If many samples of data were generated, and you have interactive SQL or interactive RDO on your system, you can speed up report generation by adding an index to the PROCEDURE_CALL relation. The SQL syntax to do this is:

```
SQL> CREATE INDEX MY_CLIENT_PC_INDEX ON
SQL> EPC$1_253_PROCEDURE_CALL (IMAGE_RECORD_ID,
SQL> COLLECTION_RECORD_ID, PROCEDURE_INDEX_START);
```

If you have interactive RDO, the syntax is:

```
RDO> DEFINE INDEX MY_INDEX FOR EPC$1_253_PROCEDURE_CALL
RDO> TYPE IS SORTED.
RDO> IMAGE_RECORD_ID ASCENDING.
RDO> COLLECTION_RECORD_ID ASCENDING.
RDO> PROCEDURE_INDEX ASCENDING.
RDO> END MY_INDEX INDEX.
RDO> COMMIT;
```

Note that adding an index causes a delay in merging another data collection file into this formatted database, and the index does not help if you want to use GROUP_BY with a different set of items. You can drop the index before merging the databases by entering either of the following sets of commands:

```
SQL> DROP INDEX MY_INDEX;
SQL> COMMIT;
```

or

```
RDO> DELETE INDEX MY_INDEX;
RDO> COMMIT;
```

See the DECtrace documentation for a layout of the formatted database.

Example 15–4 shows the report generated by the commands described in Example 15–3. The final page of the report contains an index for the report.

Example 15–4 Sample HP DECtrace Customized Report Based on ACMS Data

```
12-APR-1991 08:13          ACMS Reports          Page 1
Selection: DEBIT_CREDIT_SEL          DECtrace V1.0-0
Event:  EXCHANGE_STEP  In Facility:  ACMS          Version:  V3.2-0
```

ACMS Exchange Step Frequency Report

Time Period	Occurrences
17-SEP-1990 15:30:33	1
17-SEP-1990 15:30:45	1
17-SEP-1990 15:30:48	1

```
12-APR-1991 08:13          ACMS Reports          Page 2
Selection: DEBIT_CREDIT_SEL          DECtrace V1.0-0
Event:  PROCEDURE_CALL  In Facility:  ACMS          Version:  V3.-0
```

ACMS Procedure Call Summary Report

Proc Idx : 1

Elapsed	BUFFERED IO	CPU TIME	CURREN T PRIO	DIRECT IO	PAGEFAULTS
---------	-------------	----------	------------------	-----------	------------

(continued on next page)

Using HP DECtrace with ACMS Applications

15.5 Creating a Report Based on Collected Data

Example 15-4 (Cont.) Sample HP DECtrace Customized Report Based on ACMS Data

Minimum	0.30	0	6	7	6	1
Maximum	0.47	0	7	7	8	2
Mean	0.25	0.00	4.33	4.66	4.66	1.00
Std Dev	0.23	0.00	3.78	4.04	4.16	1.00

	PAGEFAULT IOs	Proc Idx	VIRTUAL SIZE	GLOBAL WS	PRIVATE WS
Minimum	0	1	9679	775	1407
Maximum	2	1	9679	776	1407
Mean	0.66	0.66	6452.66	517.00	938.00
Std Dev	1.15	0.57	5588.17	447.73	812.33

WORKING
SET SIZ

Minimum	4096
Maximum	4096
Mean	2730.66
Std Dev	2364.82

=====
Grand Total
=====

	Elapsed	BUFFERED IO	CPU TIME	CURREN T Prio	DIRECT IO	PAGEFAULTS
Minimum	0.30	0	6	7	6	1
Maximum	0.47	0	7	7	8	2
Mean	0.25	0.00	4.33	4.66	4.66	1.00
Std Dev	0.23	0.00	3.78	4.04	4.16	1.00

	PAGEFAULT IOs	Proc Idx	VIRTUAL SIZE	GLOBAL WS	PRIVATE WS
Minimum	0	1	9679	775	1407
Maximum	2	1	9679	776	1407
Mean	0.66	0.66	6452.66	517.00	938.00
Std Dev	1.15	0.57	5588.17	447.73	812.33

12-APR-1990 08:13
Selection: DEBIT_CREDIT_SEL

ACMS Reports

Page 3
DECtrace V1.0-0

WORKING
SET SIZ

Minimum	4096
Maximum	4096
Mean	2730.66
Std Dev	2364.82

12-APR-1991 08:13
Selection: DEBIT_CREDIT_SEL

ACMS Reports

Page 4
DECtrace V1.0-0

Event: PROCEDURE_CALL In Facility: ACMS
For Collections: ACMS_COLL
For Nodes: ACMS1, ACMS2
For Images: PAYROLL, INVENTORY
For EPIDs: 2A8002DF, 2A8002C1

Version: V3.2-0

(continued on next page)

Using HP DECtrace with ACMS Applications

15.5 Creating a Report Based on Collected Data

Example 15-4 (Cont.) Sample HP DECtrace Customized Report Based on ACMS Data

ACMS Procedure Call Detail Report

```
Timestamp                Elapsed
17-SEP-1990 15:30:33.24    0.47
17-SEP-1990 15:30:33.71
```

```
Start Appl Spec
DBCR_ALL_APP
```

BUFFERED IO	CPU TIME	CURRENT Prio	DIRECT IO	PAGEFAULTS	PAGEFAULT IOs
59	340	8	231	1778	84
59	347	7	239	1780	86

```
Start
Procedure
Index
1
```

```
Start Server Name
DBCR_ALL_SERVER_01
```

```
Start Step Name
DBCR_PROCESSING
```

```
Start Sub Name
SYSTEM
```

```
Start Task Name
DBCR_ALL_TSK_DBCR
```

VIRTUAL SIZE	GLOBAL WS	PRIVATE WS	WORKING SET SIZ
9679	769	1405	4096
9679	775	1407	4096

```
12-APR-1990 08:13          ACMS Reports
Selection: DEBIT_CREDIT_SEL
```

Page 5
DECtrace V1.0-0

```
Timestamp                Elapsed
17-SEP-1990 15:30:45.71    0.30
17-SEP-1990 15:30:46.01
```

```
Start Appl Spec
DBCR_ALL_APP
```

(continued on next page)

Using HP DECtrace with ACMS Applications

15.5 Creating a Report Based on Collected Data

Example 15-4 (Cont.) Sample HP DECtrace Customized Report Based on ACMS Data

BUFFERED IO	CPU TIME	CURRENT PRIORITY	DIRECT IO	PAGEFAULTS	PAGEFAULT IOs
59	347	8	239	1780	86
59	353	7	245	1781	86

Start
Procedure
Index
1

Start Server Name
DBCR_ALL_SERVER_01

Start Step Name
DBCR_PROCESSING

Start Sub Name
SYSTEM

Start Task Name
DBCR_ALL_TSK_DBCR

VIRTUAL SIZE	GLOBAL WS	PRIVATE WS	WORKING SET SIZ
9679	775	1407	4096
9679	776	1407	4096

12-APR-1990 08:13
Selection: DEBIT_CREDIT_SEL

Index

Page 6
DECtrace V1.0-0

Report Index

Facility Name	Event Name	Page
ACMS	EXCHANGE_STEP	1
ACMS	PROCEDURE_CALL	2
ACMS	PROCEDURE_CALL	4

15.6 ACMS Database Relations

This section describes the event-data relations in the formatted database for the ACMS ALL collection class. This information is provided so that you can write customized reports based on data in the formatted database.

Table 15-9 shows the APL_RESPONSE relation.

Using HP DECtrace with ACMS Applications 15.6 ACMS Database Relations

Table 15–9 Columns for Table EPC\$1_253_APL_RESPONSE

Column Name	Data Type	Domain
COLLECTION_RECORD_ID	SMALLINT	COLLECTION_RECORD_ID_DOMAIN
IMAGE_RECORD_ID	INTEGER	IMAGE_RECORD_ID_DOMAIN
CONTEXT_NUMBER	INTEGER	CONTEXT_NUMBER_DOMAIN
TIMESTAMP_START	DATE VMS	
TIMESTAMP_END	DATE VMS	
APPL_SPEC_START	VARCHAR(39)	
APPL_SPEC_START_STR_ID	INTEGER	STR_ID_DOMAIN
TASK_NAME_START	VARCHAR(31)	
TASK_NAME_START_STR_ID	INTEGER	STR_ID_DOMAIN
APL_USERNAME_START	VARCHAR(12)	
APL_USERNAME_START_STR_ID	INTEGER	STR_ID_DOMAIN
SUB_USERNAME_START	VARCHAR(12)	
SUB_USERNAME_START_STR_ID	INTEGER	STR_ID_DOMAIN
EXCH_STEP_NAME_START	VARCHAR(31)	
EXCH_STEP_NAME_START_STR_ID	INTEGER	STR_ID_DOMAIN
CROSS_FAC_14_START	INTEGER	
CROSS_FAC_14_END	INTEGER	

Table 15–10 shows the APL_RESPONSE_ST relation. An index is provided for this relation. It is defined with column STR_ID, duplicates are allowed, and the type is sorted.

Table 15–10 Columns for Table EPC\$1_253_APL_RESPONSE_ST

Column Name	Data Type	Domain
STR_ID	INTEGER	STR_ID_DOMAIN
SEGMENT_NUMBER	SMALLINT	SEGMENT_NUMBER_DOMAIN
STR_SEGMENT	VARCHAR(0)	

Table 15–11 shows the COMPRESSED_MSG relation.

Using HP DECtrace with ACMS Applications

15.6 ACMS Database Relations

Table 15–11 Columns for Table EPC\$1_253_COMPRESSED_MSG

Column Name	Data Type	Domain
COLLECTION_RECORD_ID	SMALLINT	COLLECTION_RECORD_ID_DOMAIN
IMAGE_RECORD_ID	INTEGER	IMAGE_RECORD_ID_DOMAIN
CONTEXT_NUMBER	INTEGER	CONTEXT_NUMBER_DOMAIN
TIMESTAMP_POINT	DATE VMS	
ORIGINAL_SIZE	INTEGER	
COMPRESSED_SIZE	INTEGER	
COMPRESSN_RATIO	INTEGER	
MESSAGE_SRC	VARCHAR(15)	
MESSAGE_SRC_STR_ID	INTEGER	STR_ID_DOMAIN
MESSAGE_DEST	VARCHAR(15)	
MESSAGE_DEST_STR_ID	INTEGER	STR_ID_DOMAIN

Table 15–12 shows the COMPRESSED_MSG_ST relation. An index is provided for this relation. It is defined with column STR_ID, duplicates are allowed, and the type is sorted.

Table 15–12 Columns for Table EPC\$1_253_COMPRESSED_MSG_ST

Column Name	Data Type	Domain
STR_ID	INTEGER	STR_ID_DOMAIN
SEGMENT_NUMBER	SMALLINT	SEGMENT_NUMBER_DOMAIN
STR_SEGMENT	VARCHAR(0)	

Table 15–13 shows the EXCHANGE_STEP relation.

Table 15–13 Columns for Table EPC\$1_253_EXCHANGE_STEP

Column Name	Data Type	Domain
COLLECTION_RECORD_ID	SMALLINT	COLLECTION_RECORD_ID_DOMAIN
IMAGE_RECORD_ID	INTEGER	IMAGE_RECORD_ID_DOMAIN
CONTEXT_NUMBER	INTEGER	CONTEXT_NUMBER_DOMAIN
TIMESTAMP_START	DATE VMS	
TIMESTAMP_END	DATE VMS	
APPL_SPEC_START	VARCHAR(39)	
APPL_SPEC_START_STR_ID	INTEGER	STR_ID_DOMAIN
TASK_NAME_START	VARCHAR(31)	
TASK_NAME_START_STR_ID	INTEGER	STR_ID_DOMAIN
APL_USERNAME_START	VARCHAR(12)	
APL_USERNAME_START_STR_ID	INTEGER	STR_ID_DOMAIN

(continued on next page)

Using HP DECtrace with ACMS Applications 15.6 ACMS Database Relations

Table 15–13 (Cont.) Columns for Table EPC\$1_253_EXCHANGE_STEP

Column Name	Data Type	Domain
SUB_USERNAME_START	VARCHAR(12)	
SUB_USERNAME_START_STR_ID	INTEGER	STR_ID_DOMAIN
STEP_NAME_START	VARCHAR(31)	
STEP_NAME_START_STR_ID	INTEGER	STR_ID_DOMAIN
REQ_FORM_NAME_START	VARCHAR(31)	
REQ_FORM_NAME_START_STR_ID	INTEGER	STR_ID_DOMAIN
DEVICE_NAME_START	VARCHAR(8)	
DEVICE_NAME_START_STR_ID	INTEGER	STR_ID_DOMAIN
SEND_ID_START	VARCHAR(31)	
SEND_ID_START_STR_ID	INTEGER	STR_ID_DOMAIN
RECEIVE_ID_START	VARCHAR(31)	
RECEIVE_ID_START_STR_ID	INTEGER	STR_ID_DOMAIN
CROSS_FAC_14_START	INTEGER	
CROSS_FAC_14_END	INTEGER	

Table 15–14 shows the EXCHANGE_STEP_ST relation. An index is provided for this relation. It is defined with column STR_ID, duplicates are allowed, and the type is sorted.

Table 15–14 Columns for Table EPC\$1_253_EXCHANGE_STEP_ST

Column Name	Data Type	Domain
STR_ID	INTEGER	STR_ID_DOMAIN
SEGMENT_NUMBER	SMALLINT	SEGMENT_NUMBER_DOMAIN
STR_SEGMENT	VARCHAR(0)	

Table 15–15 shows the FORMS_ENABLE relation.

Table 15–15 Columns for Table EPC\$1_253_FORMS_ENABLE

Column Name	Data Type	Domain
COLLECTION_RECORD_ID	SMALLINT	COLLECTION_RECORD_ID_DOMAIN
IMAGE_RECORD_ID	INTEGER	IMAGE_RECORD_ID_DOMAIN
CONTEXT_NUMBER	INTEGER	CONTEXT_NUMBER_DOMAIN
TIMESTAMP_START	DATE VMS	
TIMESTAMP_END	DATE VMS	
APPL_SPEC_START	VARCHAR(39)	
APPL_SPEC_START_STR_ID	INTEGER	STR_ID_DOMAIN

(continued on next page)

Using HP DECtrace with ACMS Applications

15.6 ACMS Database Relations

Table 15–15 (Cont.) Columns for Table EPC\$1_253_FORMS_ENABLE

Column Name	Data Type	Domain
APPL_NODE_START	VARCHAR(15)	
APPL_NODE_START_STR_ID	INTEGER	STR_ID_DOMAIN
SUB_USERNAME_START	VARCHAR(12)	
SUB_USERNAME_START_STR_ID	INTEGER	STR_ID_DOMAIN
DEVICE_NAME_START	VARCHAR(8)	
DEVICE_NAME_START_STR_ID	INTEGER	STR_ID_DOMAIN
REQ_FORM_NAME_START	VARCHAR(31)	
REQ_FORM_NAME_START_STR_ID	INTEGER	STR_ID_DOMAIN
CROSS_FAC_14_START	INTEGER	
CROSS_FAC_14_END	INTEGER	

Table 15–16 shows the FORMS_ENABLE_ST relation. An index is provided for this relation. It is defined with column STR_ID, duplicates are allowed, and the type is sorted.

Table 15–16 Columns for Table EPC\$1_253_FORMS_ENABLE_ST

Column Name	Data Type	Domain
STR_ID	INTEGER	STR_ID_DOMAIN
SEGMENT_NUMBER	SMALLINT	SEGMENT_NUMBER_DOMAIN
STR_SEGMENT	VARCHAR(0)	

Table 15–17 shows the FORMS_REQUEST relation.

Table 15–17 Columns for Table EPC\$1_253_FORMS_REQUEST

Column Name	Data Type	Domain
COLLECTION_RECORD_ID	SMALLINT	COLLECTION_RECORD_ID_DOMAIN
IMAGE_RECORD_ID	INTEGER	IMAGE_RECORD_ID_DOMAIN
CONTEXT_NUMBER	INTEGER	CONTEXT_NUMBER_DOMAIN
TIMESTAMP_START	DATE VMS	
TIMESTAMP_END	DATE VMS	
APPL_SPEC_START	VARCHAR(39)	
APPL_SPEC_START_STR_ID	INTEGER	STR_ID_DOMAIN
APPL_NODE_START	VARCHAR(15)	
APPL_NODE_START_STR_ID	INTEGER	STR_ID_DOMAIN
SUB_USERNAME_START	VARCHAR(12)	

(continued on next page)

Using HP DECtrace with ACMS Applications 15.6 ACMS Database Relations

Table 15–17 (Cont.) Columns for Table EPC\$1_253_FORMS_REQUEST

Column Name	Data Type	Domain
SUB_USERNAME_START_STR_ID	INTEGER	STR_ID_DOMAIN
DEVICE_NAME_START	VARCHAR(8)	
DEVICE_NAME_START_STR_ID	INTEGER	STR_ID_DOMAIN
TASK_NAME_START	VARCHAR(31)	
TASK_NAME_START_STR_ID	INTEGER	STR_ID_DOMAIN
EXCH_STEP_NAME_START	VARCHAR(31)	
EXCH_STEP_NAME_START_STR_ID	INTEGER	STR_ID_DOMAIN
REQ_FORM_NAME_START	VARCHAR(31)	
REQ_FORM_NAME_START_STR_ID	INTEGER	STR_ID_DOMAIN
SEND_ID_START	VARCHAR(31)	
SEND_ID_START_STR_ID	INTEGER	STR_ID_DOMAIN
RECEIVE_ID_START	VARCHAR(31)	
RECEIVE_ID_START_STR_ID	INTEGER	STR_ID_DOMAIN
CROSS_FAC_14_START	INTEGER	
CROSS_FAC_14_END	INTEGER	

Table 15–18 shows the FORMS_REQUEST_ST relation. An index is provided for this relation. It is defined with column STR_ID, duplicates are allowed, and the type is sorted.

Table 15–18 Columns for Table EPC\$1_253_FORMS_REQUEST_ST

Column Name	Data Type	Domain
STR_ID	INTEGER	STR_ID_DOMAIN
SEGMENT_NUMBER	SMALLINT	SEGMENT_NUMBER_DOMAIN
STR_SEGMENT	VARCHAR(0)	

Table 15–19 shows the PROCEDURE_CALL relation.

Table 15–19 Columns for Table EPC\$1_253_PROCEDURE_CALL

Column Name	Data Type	Domain
COLLECTION_RECORD_ID	SMALLINT	COLLECTION_RECORD_ID_DOMAIN
IMAGE_RECORD_ID	INTEGER	IMAGE_RECORD_ID_DOMAIN
CONTEXT_NUMBER	INTEGER	CONTEXT_NUMBER_DOMAIN
TIMESTAMP_START	DATE VMS	
TIMESTAMP_END	DATE VMS	

(continued on next page)

Using HP DECtrace with ACMS Applications

15.6 ACMS Database Relations

Table 15–19 (Cont.) Columns for Table EPC\$1_253_PROCEDURE_CALL

Column Name	Data Type	Domain
APPL_SPEC_START	VARCHAR(39)	
APPL_SPEC_START_STR_ID	INTEGER	STR_ID_DOMAIN
TASK_NAME_START	VARCHAR(31)	
TASK_NAME_START_STR_ID	INTEGER	STR_ID_DOMAIN
APL_USERNAME_START	VARCHAR(12)	
APL_USERNAME_START_STR_ID	INTEGER	STR_ID_DOMAIN
SUB_USERNAME_START	VARCHAR(12)	
SUB_USERNAME_START_STR_ID	INTEGER	STR_ID_DOMAIN
STEP_NAME_START	VARCHAR(31)	
STEP_NAME_START_STR_ID	INTEGER	STR_ID_DOMAIN
EXCH_STEP_NAME_START	VARCHAR(31)	
EXCH_STEP_NAME_START_STR_ID	INTEGER	STR_ID_DOMAIN
TXN_ID_START	VARCHAR(36)	
TXN_ID_START_STR_ID	INTEGER	STR_ID_DOMAIN
SERVER_NAME_START	VARCHAR(31)	
SERVER_NAME_START_STR_ID	INTEGER	STR_ID_DOMAIN
PROCEDURE_NAME_START	VARCHAR(31)	
PROCEDURE_NAME_START_STR_ID	INTEGER	STR_ID_DOMAIN
SERVER_INDEX_START	INTEGER	
PROCEDURE_INDEX_START	INTEGER	
BIO_START	INTEGER	
DIO_START	INTEGER	
PAGEFAULTS_START	INTEGER	
PAGEFAULT_IO_START	INTEGER	
CPU_START	INTEGER	
CURRENT_PRIO_START	SMALLINT	
VIRTUAL_SIZE_START	INTEGER	
WS_SIZE_START	INTEGER	
WS_PRIVATE_START	INTEGER	
WS_GLOBAL_START	INTEGER	
CROSS_FAC_2_START	INTEGER	
CROSS_FAC_7_START	INTEGER	
CROSS_FAC_14_START	INTEGER	
BIO_END	INTEGER	
DIO_END	INTEGER	

(continued on next page)

Using HP DECtrace with ACMS Applications 15.6 ACMS Database Relations

Table 15–19 (Cont.) Columns for Table EPC\$1_253_PROCEDURE_CALL

Column Name	Data Type	Domain
PAGEFAULTS_END	INTEGER	
PAGEFAULT_IO_END	INTEGER	
CPU_END	INTEGER	
CURRENT_PRIO_END	SMALLINT	
VIRTUAL_SIZE_END	INTEGER	
WS_SIZE_END	INTEGER	
WS_PRIVATE_END	INTEGER	
WS_GLOBAL_END	INTEGER	
CROSS_FAC_2_END	INTEGER	
CROSS_FAC_7_END	INTEGER	
CROSS_FAC_14_END	INTEGER	

Table 15–20 shows the PROCEDURE_CALL_ST relation. An index is provided for this relation. It is defined with column STR_ID, duplicates are allowed, and the type is sorted.

Table 15–20 Columns for Table EPC\$1_253_PROCEDURE_CALL_ST

Column Name	Data Type	Domain
STR_ID	INTEGER	STR_ID_DOMAIN
SEGMENT_NUMBER	SMALLINT	SEGMENT_NUMBER_DOMAIN
STR_SEGMENT	VARCHAR(0)	

Table 15–21 shows the PROCESSING_STEP relation.

Table 15–21 Columns for Table EPC\$1_253_PROCESSING_STEP

Column Name	Data Type	Domain
COLLECTION_RECORD_ID	SMALLINT	COLLECTION_RECORD_ID_DOMAIN
IMAGE_RECORD_ID	INTEGER	IMAGE_RECORD_ID_DOMAIN
CONTEXT_NUMBER	INTEGER	CONTEXT_NUMBER_DOMAIN
TIMESTAMP_START	DATE VMS	
TIMESTAMP_END	DATE VMS	
APPL_SPEC_START	VARCHAR(39)	
APPL_SPEC_START_STR_ID	INTEGER	STR_ID_DOMAIN
TASK_NAME_START	VARCHAR(31)	
TASK_NAME_START_STR_ID	INTEGER	STR_ID_DOMAIN
APL_USERNAME_START	VARCHAR(12)	
APL_USERNAME_START_STR_ID	INTEGER	STR_ID_DOMAIN

(continued on next page)

Using HP DECtrace with ACMS Applications

15.6 ACMS Database Relations

Table 15–21 (Cont.) Columns for Table EPC\$1_253_PROCESSING_STEP

Column Name	Data Type	Domain
SUB_USERNAME_START	VARCHAR(12)	
SUB_USERNAME_START_STR_ID	INTEGER	STR_ID_DOMAIN
STEP_NAME_START	VARCHAR(31)	
STEP_NAME_START_STR_ID	INTEGER	STR_ID_DOMAIN
EXCH_STEP_NAME_START	VARCHAR(31)	
EXCH_STEP_NAME_START_STR_ID	INTEGER	STR_ID_DOMAIN
TXN_ID_START	VARCHAR(36)	
TXN_ID_START_STR_ID	INTEGER	STR_ID_DOMAIN
PROC_STEP_TYPE_START	VARCHAR(20)	
PROC_STEP_TYPE_START_STR_ID	INTEGER	STR_ID_DOMAIN
CROSS_FAC_14_START	INTEGER	
CROSS_FAC_14_END	INTEGER	

Table 15–22 shows the PROCESSING_STEP_ST relation. An index is provided for this relation. It is defined with column STR_ID, duplicates are allowed, and the type is sorted.

Table 15–22 Columns for Table EPC\$1_253_PROCESSING_STEP_ST

Column Name	Data Type	Domain
STR_ID	INTEGER	STR_ID_DOMAIN
SEGMENT_NUMBER	SMALLINT	SEGMENT_NUMBER_DOMAIN
STR_SEGMENT	VARCHAR(0)	

Table 15–23 shows the REMOTE_REQUEST relation.

Table 15–23 Columns for Table EPC\$1_253_REMOTE_REQUEST

Column Name	Data Type	Domain
COLLECTION_RECORD_ID	SMALLINT	COLLECTION_RECORD_ID_DOMAIN
IMAGE_RECORD_ID	INTEGER	IMAGE_RECORD_ID_DOMAIN
CONTEXT_NUMBER	INTEGER	CONTEXT_NUMBER_DOMAIN
TIMESTAMP_START	DATE VMS	
TIMESTAMP_END	DATE VMS	
APPL_SPEC_START	VARCHAR(39)	
APPL_SPEC_START_STR_ID	INTEGER	STR_ID_DOMAIN
APPL_NODE_START	VARCHAR(15)	
APPL_NODE_START_STR_ID	INTEGER	STR_ID_DOMAIN

(continued on next page)

Using HP DECtrace with ACMS Applications 15.6 ACMS Database Relations

Table 15–23 (Cont.) Columns for Table EPC\$1_253_REMOTE_REQUEST

Column Name	Data Type	Domain
SUB_USERNAME_START	VARCHAR(12)	
SUB_USERNAME_START_STR_ID	INTEGER	STR_ID_DOMAIN
DEVICE_NAME_START	VARCHAR(8)	
DEVICE_NAME_START_STR_ID	INTEGER	STR_ID_DOMAIN
TASK_NAME_START	VARCHAR(31)	
TASK_NAME_START_STR_ID	INTEGER	STR_ID_DOMAIN
EXCH_STEP_NAME_START	VARCHAR(31)	
EXCH_STEP_NAME_START_STR_ID	INTEGER	STR_ID_DOMAIN
REQ_FORM_NAME_START	VARCHAR(31)	
REQ_FORM_NAME_START_STR_ID	INTEGER	STR_ID_DOMAIN
CROSS_FAC_14_START	INTEGER	
CROSS_FAC_14_END	INTEGER	

Table 15–24 shows the REMOTE_REQUEST_ST relation. An index is provided for this relation. It is defined with column STR_ID, duplicates are allowed, and the type is sorted.

Table 15–24 Columns for Table EPC\$1_253_REMOTE_REQUEST_ST

Column Name	Data Type	Domain
STR_ID	INTEGER	STR_ID_DOMAIN
SEGMENT_NUMBER	SMALLINT	SEGMENT_NUMBER_DOMAIN
STR_SEGMENT	VARCHAR(0)	

Table 15–25 shows the SUB_RESPONSE relation.

Using HP DECtrace with ACMS Applications

15.6 ACMS Database Relations

Table 15–25 Columns for Table EPC\$1_253_SUB_RESPONSE

Column Name	Data Type	Domain
COLLECTION_RECORD_ID	SMALLINT	COLLECTION_RECORD_ID_DOMAIN
IMAGE_RECORD_ID	INTEGER	IMAGE_RECORD_ID_DOMAIN
CONTEXT_NUMBER	INTEGER	CONTEXT_NUMBER_DOMAIN
TIMESTAMP_START	DATE VMS	
TIMESTAMP_END	DATE VMS	
APPL_SPEC_START	VARCHAR(39)	
APPL_SPEC_START_STR_ID	INTEGER	STR_ID_DOMAIN
APPL_NODE_START	VARCHAR(15)	
APPL_NODE_START_STR_ID	INTEGER	STR_ID_DOMAIN
SUB_USERNAME_START	VARCHAR(12)	
SUB_USERNAME_START_STR_ID	INTEGER	STR_ID_DOMAIN
DEVICE_NAME_START	VARCHAR(8)	
DEVICE_NAME_START_STR_ID	INTEGER	STR_ID_DOMAIN
TASK_NAME_START	VARCHAR(31)	
TASK_NAME_START_STR_ID	INTEGER	STR_ID_DOMAIN
EXCH_STEP_NAME_START	VARCHAR(31)	
EXCH_STEP_NAME_START_STR_ID	INTEGER	STR_ID_DOMAIN
CROSS_FAC_14_START	INTEGER	
NETWORK_TIME_END	INTEGER	
PROCESSING_TIME_END	INTEGER	
CROSS_FAC_14_END	INTEGER	

Table 15–26 shows the SUB_RESPONSE_ST relation. An index is provided for this relation. It is defined with column STR_ID, duplicates are allowed, and the type is sorted.

Table 15–26 Columns for Table EPC\$1_253_SUB_RESPONSE_ST

Column Name	Data Type	Domain
STR_ID	INTEGER	STR_ID_DOMAIN
SEGMENT_NUMBER	SMALLINT	SEGMENT_NUMBER_DOMAIN
STR_SEGMENT	VARCHAR(0)	

Table 15–27 shows the TASK relation.

Using HP DECtrace with ACMS Applications 15.6 ACMS Database Relations

Table 15–27 Columns for Table EPC\$1_253_TASK

Column Name	Data Type	Domain
COLLECTION_RECORD_ID	SMALLINT	COLLECTION_RECORD_ID_DOMAIN
IMAGE_RECORD_ID	INTEGER	IMAGE_RECORD_ID_DOMAIN
CONTEXT_NUMBER	INTEGER	CONTEXT_NUMBER_DOMAIN
TIMESTAMP_START	DATE VMS	
TIMESTAMP_END	DATE VMS	
APPL_SPEC_START	VARCHAR(39)	
APPL_SPEC_START_STR_ID	INTEGER	STR_ID_DOMAIN
TASK_NAME_START	VARCHAR(31)	
TASK_NAME_START_STR_ID	INTEGER	STR_ID_DOMAIN
APL_USERNAME_START	VARCHAR(12)	
APL_USERNAME_START_STR_ID	INTEGER	STR_ID_DOMAIN
SUB_USERNAME_START	VARCHAR(12)	
SUB_USERNAME_START_STR_ID	INTEGER	STR_ID_DOMAIN
STEP_NAME_START	VARCHAR(31)	
STEP_NAME_START_STR_ID	INTEGER	STR_ID_DOMAIN
PARENT_TASK_START	VARCHAR(31)	
PARENT_TASK_START_STR_ID	INTEGER	STR_ID_DOMAIN
CROSS_FAC_14_START	INTEGER	
CROSS_FAC_14_END	INTEGER	

Table 15–28 shows the TASK_ST relation. An index is provided for this relation. It is defined with column STR_ID, duplicates are allowed, and the type is sorted.

Table 15–28 Columns for Table EPC\$1_253_TASK_ST

Column Name	Data Type	Domain
STR_ID	INTEGER	STR_ID_DOMAIN
SEGMENT_NUMBER	SMALLINT	SEGMENT_NUMBER_DOMAIN
STR_SEGMENT	VARCHAR(0)	

Table 15–29 shows the TASK_WAIT relation.

Table 15–29 Columns for Table EPC\$1_253_TASK_WAIT

Column Name	Data Type	Domain
COLLECTION_RECORD_ID	SMALLINT	COLLECTION_RECORD_ID_DOMAIN
IMAGE_RECORD_ID	INTEGER	IMAGE_RECORD_ID_DOMAIN
CONTEXT_NUMBER	INTEGER	CONTEXT_NUMBER_DOMAIN
TIMESTAMP_START	DATE VMS	

(continued on next page)

Using HP DECtrace with ACMS Applications

15.6 ACMS Database Relations

Table 15–29 (Cont.) Columns for Table EPC\$1_253_TASK_WAIT

Column Name	Data Type	Domain
TIMESTAMP_END	DATE VMS	
APPL_SPEC_START	VARCHAR(39)	
APPL_SPEC_START_STR_ID	INTEGER	STR_ID_DOMAIN
TASK_NAME_START	VARCHAR(31)	
TASK_NAME_START_STR_ID	INTEGER	STR_ID_DOMAIN
APL_USERNAME_START	VARCHAR(12)	
APL_USERNAME_START_STR_ID	INTEGER	STR_ID_DOMAIN
SUB_USERNAME_START	VARCHAR(12)	
SUB_USERNAME_START_STR_ID	INTEGER	STR_ID_DOMAIN
STEP_NAME_START	VARCHAR(31)	
STEP_NAME_START_STR_ID	INTEGER	STR_ID_DOMAIN
EXCH_STEP_NAME_START	VARCHAR(31)	
EXCH_STEP_NAME_START_STR_ID	INTEGER	STR_ID_DOMAIN
TXN_ID_START	VARCHAR(36)	
TXN_ID_START_STR_ID	INTEGER	STR_ID_DOMAIN
SERVER_NAME_START	VARCHAR(31)	
SERVER_NAME_START_STR_ID	INTEGER	STR_ID_DOMAIN
PROCEDURE_NAME_START	VARCHAR(31)	
PROCEDURE_NAME_START_STR_ID	INTEGER	STR_ID_DOMAIN
CROSS_FAC_14_START	INTEGER	
CROSS_FAC_14_END	INTEGER	

Table 15–30 shows the TASK_WAIT_ST relation. An index is provided for this relation. It is defined with column STR_ID, duplicates are allowed, and the type is sorted.

Table 15–30 Columns for Table EPC\$1_253_TASK_WAIT_ST

Column Name	Data Type	Domain
STR_ID	INTEGER	STR_ID_DOMAIN
SEGMENT_NUMBER	SMALLINT	SEGMENT_NUMBER_DOMAIN
STR_SEGMENT	VARCHAR(0)	

Table 15–31 shows the TRANSACTION relation.

Using HP DECtrace with ACMS Applications 15.6 ACMS Database Relations

Table 15–31 Columns for Table EPC\$1_253_TRANSACTION

Column Name	Data Type	Domain
COLLECTION_RECORD_ID	SMALLINT	COLLECTION_RECORD_ID_DOMAIN
IMAGE_RECORD_ID	INTEGER	IMAGE_RECORD_ID_DOMAIN
CONTEXT_NUMBER	INTEGER	CONTEXT_NUMBER_DOMAIN
TIMESTAMP_START	DATE VMS	
TIMESTAMP_END	DATE VMS	
APPL_SPEC_START	VARCHAR(39)	
APPL_SPEC_START_STR_ID	INTEGER	STR_ID_DOMAIN
TASK_NAME_START	VARCHAR(31)	
TASK_NAME_START_STR_ID	INTEGER	STR_ID_DOMAIN
APL_USERNAME_START	VARCHAR(12)	
APL_USERNAME_START_STR_ID	INTEGER	STR_ID_DOMAIN
SUB_USERNAME_START	VARCHAR(12)	
SUB_USERNAME_START_STR_ID	INTEGER	STR_ID_DOMAIN
STEP_NAME_START	VARCHAR(31)	
STEP_NAME_START_STR_ID	INTEGER	STR_ID_DOMAIN
EXCH_STEP_NAME_START	VARCHAR(31)	
EXCH_STEP_NAME_START_STR_ID	INTEGER	STR_ID_DOMAIN
TXN_ID_START	VARCHAR(36)	
TXN_ID_START_STR_ID	INTEGER	STR_ID_DOMAIN
CROSS_FAC_14_START	INTEGER	
TXN_STATUS_END	VARCHAR(31)	
TXN_STATUS_END_STR_ID	INTEGER	STR_ID_DOMAIN
CROSS_FAC_14_END	INTEGER	

Table 15–32 shows the TRANSACTION_ST relation. An index is provided for this relation. It is defined with column STR_ID, duplicates are allowed, and the type is sorted.

Table 15–32 Columns for Table EPC\$1_253_TRANSACTION_ST

Column Name	Data Type	Domain
STR_ID	INTEGER	STR_ID_DOMAIN
SEGMENT_NUMBER	SMALLINT	SEGMENT_NUMBER_DOMAIN
STR_SEGMENT	VARCHAR(0)	

Managing ACMS Licensing

Concurrent-use licensing increases the number of licensing options available for ACMS run-time and remote-access systems. You can choose the more cost-effective licensing method for your ACMS system: concurrent-use or unlimited-use.

Concurrent-use licensing allows you to control access to ACMS run-time and remote-access systems, based on a predetermined number of users that can access ACMS at any one time. Concurrent-use licenses apply to both single node systems and to clusters.

For more information about licenses and kit options, see *HP ACMS Version 5.0 for OpenVMS Installation Guide*.

16.1 Overview of ACMS Kits and Licensing Options

This section provides an overview of the ACMS kits and the functions provided by each kit, describes concurrent-use and unlimited-use licenses, and lists the license types that are available for each kit.

16.1.1 ACMS Kits

ACMS kits determine what functions ACMS users are able to perform. The three types of ACMS kits are:

- ACMS Development Kit

This kit provides all the features of ACMS. You can define, build, and debug multiple-step tasks, task groups, menus, and applications, as well as use the ACMS task queuing facilities. You can use HP DECforms or TDMS as standard presentation services, or use the Request Interface (RI) and Systems Interface (SI) to access other presentation services. You are provided with samples of ACMS applications using standard presentation services and the Request Interface.

The development kit also includes the features provided by the Run-Time and Remote-Access kits.

Managing ACMS Licensing

16.1 Overview of ACMS Kits and Licensing Options

- **ACMS Run-Time Kit**

This kit allows you to use existing applications or programs under the control of ACMS. It also allows you to define menus, applications, task groups, and single-step tasks that use DCL servers, if CDD is present when this kit is installed. It allows ACMS users to sign in and select tasks that are implemented on the local node as well as remote nodes. The run-time kit allows you to use the ACMS Queued Task Initiator (QTI) to submit tasks to run on the local node as well as remote nodes.

The run-time kit also includes the features provided by the remote-access kit.
- **ACMS Remote-Access Kit**

This kit is suitable for installation on a network node that does not have any ACMS applications running on it, but requires access to ACMS applications running on another network node. The remote-access kit allows users to sign in to ACMS and select tasks on remote nodes, and handles the terminal I/O associated with those tasks. The remote-access kit allows you to use the ACMS Queued Task Initiator (QTI) to submit tasks to run on remote nodes.

16.1.2 ACMS License Types

ACMS offers two types of licenses:

- **Unlimited-use license**

This type of license is also referred to as a **capacity license**. Unlimited-use licenses set no limit on the number of users who can access ACMS at any one time.
- **Concurrent-use license**

Concurrent-use licenses limit the number of users who can access ACMS at any one time. For example, a concurrent-use license for four users gives a maximum of four users access to ACMS simultaneously.

Unlimited-use licenses are available for all ACMS kits. Concurrent-use licenses are available only for the ACMS run-time and remote-access kits; there is no concurrent-use license available for the ACMS development kit.

Table 16–1 summarizes all of the ACMS kits and available licenses.

Table 16–1 ACMS Licenses

ACMS Kit	Unlimited-Use	Concurrent-Use
Development	ACMS	Not available
Run-time	ACMS-RT	ACMS-RT-USER
Remote-access	ACMS-REM	ACMS-REM-USER

Concurrent-use licenses are expressed in terms of **units**. 100 license units are required for each concurrent user; for example, a concurrent-use license of 500 units allows five users to access ACMS concurrently. Each group of 100 units is referred to as a **set** of license units. For more information on license units, see *HP ACMS Version 5.0 for OpenVMS Software Product Description (25.50.xx)*.

Concurrent-use licenses of the same kit type, for instance, either the run-time kit or remote-access kit, are cumulative. If you have more than one concurrent-use license, add together the number of units on each license to determine the total number of users that can access ACMS.

Managing ACMS Licensing

16.1 Overview of ACMS Kits and Licensing Options

Only one license type is in effect on an ACMS system at any one time. If you have more than one ACMS license loaded, ACMS chooses, at startup, the license with the least restrictive functionality.

The following list shows all license types, from least to most restrictive functionality:

- ACMS (least restrictive)
- ACMS-RT
- ACMS-RT-USER
- ACMS-REM
- ACMS-REM-USER (most restrictive)

For more information on license management, refer to *HP ACMS Version 5.0 for OpenVMS Installation Guide* and the License Management Facility (LMF) documentation in the OpenVMS documentation set.

16.2 License Unit Allocation

License units are allocated to a user. The term **user** refers to an ACMS task submitter, which includes:

- Interactive users signed in to the ACMS Command Process (CP)
- Interactive users accessing ACMS using the ACMS Request Interface (RI) agent
- Interactive users accessing ACMS from ALL-IN-1
- PC users accessing ACMS using HP TP Desktop Connector (formerly ACMS Desktop)
- Task submitters signed in to ACMS by the ACMS Queued Task Initiator (QTI)
- Task submitters signed in to ACMS by a user-written agent
- Task submitters signed in to ACMS by a detached task

The following rules apply to the allocation of license units at run time.

- ACMS allocates a set of license units to a user on each node on which the user is active.

For example, when a user signs in to ACMS on Node A, a set of license units is allocated to the user on Node A. If a user signs in to Node A and selects a task on Node B, a set of license units is allocated on both Node A (for the sign-in) and Node B (for the task selection).

If a user signs in to ACMS on Node A and Node B, a set of license units is allocated on each node.

- A set of license units is allocated each time the user signs in.

For example, if a user signs in twice on Node A, two sets of license units are allocated on Node A.

- Once a user is signed in to a node, the user can select ACMS tasks on that node without using additional license units.

Managing ACMS Licensing

16.2 License Unit Allocation

For example, if a user on Node A selects a task in an application running on Node A, only one set of license units is allocated; no additional license units are required if the user selects an additional task in that application or a different application on Node A.

Likewise, if the user on Node A selects tasks on Node B, license units are allocated only for the first task selected on Node B; no additional license units are allocated if the user selects additional tasks on Node B.

- License units allocated to a user remain allocated to that user until the user signs out of ACMS. At that time, all license units held by the user are released, including the license units allocated on the local node and any license units allocated to that user on remote nodes.

For example, if a user on Node A signs in and selects tasks in applications on Nodes B and C, license units on Nodes A, B, and C are released when the user signs out from Node A.

- License units on a remote node allocated to a user who has selected a task in an application on that remote node are released, if the application is shut down, and the user has not selected tasks in another application on the remote node.

As a corollary to this rule, once a user on Node A selects a task in an application on Node B, that user continues to hold license units on Node B, even if the user selects no more tasks on Node B. In this situation, license units remain allocated to the user on Node B until the user signs out from Node A, the application on Node B runs down, or until the connection between Nodes A and B is broken.

- During initialization, ACMS temporarily allocates a license unit and then releases it.

ACMS requires a valid loaded license to start the ACMS run-time system and the Application Definition Utility (ADU). With concurrent-use licenses, ACMS checks for the presence of a valid license by temporarily allocating a license unit. Once the set of license units is successfully allocated, the license units are immediately released and use of the system is granted.

The following sections describe rules for license unit allocation in special cases:

- In an OpenVMS Cluster network
- With the QTI
- With detached tasks

16.2.1 License Unit Allocation in OpenVMS Clusters

License units of a concurrent-use license for an OpenVMS Cluster are shared among all nodes in the cluster that have the license loaded. The rules for license unit allocation are the same whether a node is in a cluster or not. The only difference is that nodes of a cluster share the same pool of license units.

When a user is signed in on Node A of a cluster, a set of license units is allocated, even if the user is already signed in on Node B or C of the cluster. Therefore, it is possible for a user to hold a set of license units from the common license unit pool on every node of the cluster, if that user is signed in on every node.

For example, a cluster with a 50-user concurrent-use license has three nodes. A user on Node A is allocated one set of license units on Node A. If that user also selects tasks in applications on Node B and Node C, the user is allocated a set of license units on each of those nodes. The user's total license unit allocation corresponds to three user sign-ins. All license units are allocated out of the shared pool of license units corresponding to 50 users, leaving a total number of license units corresponding to 47 users.

16.2.2 Concurrent-Use Licenses with the QTI

The QTI is an ACMS System Interface (SI) agent program. As with all agent programs, the QTI uses the ACMS\$SIGN_IN service to sign a submitter in before invoking a task on behalf of that submitter, thus allocating a set of license units.

When the QTI dequeues a queued task element, it checks the user name associated with the element. The first time the QTI dequeues an element with that user name, it signs the submitter in to ACMS but does not sign the submitter out of ACMS when that task ends. Instead, the QTI leaves the submitter signed in for at least the time specified in QTI_SUB_TIMEOUT. If another queued element with the same user name is dequeued prior to the time-out period, a submitter is already signed in for the user. This avoids the overhead of signing in and signing out the submitter.

If you have concurrent-use licenses for your ACMS system, a set of license units is allocated by the QTI for each submitter that the QTI signs in. The license units remain allocated until the QTI signs a submitter out.

Use the ACMSGEN parameter QTI_SUB_TIMEOUT to indicate how long a signed-in submitter can remain idle before the QTI signs the submitter out of ACMS.

16.2.3 Concurrent-Use Licenses with Detached Tasks

For every detached task started, the ACMS\$SIGN_IN service signs in a task submitter. If you have concurrent-use licenses, a set of license units is allocated for each detached task that is started. These license units remain allocated until the task submitter signs out and the detached task stops.

See *HP ACMS for OpenVMS Writing Applications* for more information about concurrent-use licenses with detached tasks.

16.3 Managing Systems with Concurrent-Use Licenses

ACMS provides three operator commands that allow you to determine the identities and number of users accessing a system:

- ACMS/SHOW APPLICATION/CONNECTIONS

The ACMS/SHOW APPLICATION/CONNECTIONS command displays all the local and remote users who are connected to local applications.

A user is **connected to** an application when that user selects a task in the application for the first time. The connection remains until the user signs out of ACMS or the application is shut down.

- ACMS/SHOW SYSTEM

The ACMS/SHOW SYSTEM command displays information about both local and remote users.

Managing ACMS Licensing

16.3 Managing Systems with Concurrent-Use Licenses

- ACMS/SHOW USER

This command displays the local and remote users accessing the ACMS system, and lists the local applications that users are connected to. It also displays the total number of users on the system. The total number of local and remote users corresponds to the total number of license units allocated.

Note

The scope of ACMS operator commands is limited to one node. Therefore, in HP OpenVMS Cluster environments, you must execute the operator commands on each node of the cluster to obtain a total view of how license units are allocated in the cluster.

16.3.1 Releasing License Units

When a user is unable to sign in to an ACMS system, or unable to select a task on a remote node because the license units for the node have been exhausted, you may want to release license units to allow other higher-priority users access to the ACMS system.

There are two operator commands that allow you to release license units:

- ACMS/CANCEL USER
- ACMS/STOP APPLICATION

Before executing either of these commands, use the ACMS/SHOW USER command to identify local and remote users accessing the system.

To release license units, issue the ACMS/CANCEL USER command on the local node to cancel a local user. This forces the local user to sign out of the ACMS system. To cancel a remote user, use the ACMS/CANCEL USER command on the remote node on which the user was originally signed in. This releases all the allocated license units. This command requires OPER privileges.

In an extreme case, you can release license units allocated to a remote user on an ACMS system by shutting down all applications used by the remote user. The ACMS/STOP APPLICATION command shuts down an application. Stopping an application affects all users connected to that application.

Part II

Reference Section

This part of the manual contains reference information for each ACMS command. The following types of commands are described in this section:

- Device Definition Utility (DDU)
- User Definition Utility (UDU)
- Application Authorization Utility (AAU)
- Queue Manager (ACMSQUEMGR) Utility
- Operator
- ACMSGEN Utility
- Audit Trail Report (ATR) Utility
- Software Event Logger Utility Program (SWLUP)

The chapters in Part I provide tutorial discussions of these commands and utilities.

DDU Commands

This chapter provides reference information and examples for each ACMS Device Definition Utility (DDU) command. See Chapter 2 for a general description of DDU.

ADD

ADD Command (DDU>)

Authorizes and assigns sign-in characteristics to an ACMS terminal by creating a DDU definition and adding it to the device authorization file (ACMSDDF.DAT).

Format

ADD device-name

Command Qualifiers

/[NO]AUTOLOGIN=username
/[NO]CONTROLLED

/PRINTFILE $\left[\begin{array}{l} \text{print-file-spec} \\ \text{spooled-device-name} \end{array} \right]$

Default

From DEFAULT definition
From DEFAULT definition

From DEFAULT definition

Privileges Required

None

Parameters

device-name

The name of the device. The device name can be a logical name, a physical device name, or a group device name. Do not include a colon (:) when you specify a device name. See Table 2–1 for a list of the DDU group device names.

Qualifiers

/[NO]AUTOLOGIN=username

The /AUTOLOGIN qualifier enables automatic sign-ins for ACMS-controlled terminals. With automatic sign-in enabled, the user does not need to enter a user name to sign in to ACMS. If a password is required, the user receives the password prompt after pressing Return. If a password is not required, the user is signed in to ACMS as soon as Return is pressed on the terminal's keyboard.

ACMS places the user name you specify with the /AUTOLOGIN qualifier in the device authorization file and uses that user name each time a user presses Return. The user name can contain 1 through 12 characters.

The /AUTOLOGIN qualifier has no effect unless the terminal has the Controlled sign-in characteristic. You can assign a Controlled sign-in characteristic by specifying the /CONTROLLED qualifier.

Disable automatic sign-ins with the /NOAUTOLOGIN qualifier. The default for this qualifier is whatever is defined in the DEFAULT definition. See the description of the DDU DEFAULT command for information on the DEFAULT definition.

/[NO]CONTROLLED

The /CONTROLLED qualifier assigns the Controlled sign-in characteristic to a device. Users at application port terminals with the Controlled sign-in characteristic sign in directly to ACMS. Users at dedicated service port terminals sign in either directly to ACMS or not, depending on the node they connect to at the "Local>" prompt. See Section 2.11 for a description of application ports and dedicated service ports.

The `/NOCONTROLLED` qualifier assigns the Not Controlled sign-in characteristic to a device. Users at terminals with the Not Controlled characteristic sign in directly to OpenVMS. For access to ACMS, you must enter the `ACMS/ENTER` command.

When you specify the `/CONTROLLED` qualifier, you can specify only a physical device name or the group device names `TT` and `LT`. See Table 2–1 for a description of the DDU group device names. The default for this qualifier is whatever is defined in the `DEFAULT` definition. See the description of the `DDU DEFAULT` command for information on the `DEFAULT` definition.

Note

The ACMS Terminal Subsystem Controller (TSC) does not support dialup lines as ACMS-controlled terminals. Because the TSC keeps a channel to ACMS-controlled terminals even when the user signs out, the modem does not receive any hangup notification. If you operate a terminal using ACMS over dialup lines, you must first log in to OpenVMS, and then issue the `ACMS/ENTER/NORETURN` command. The `/NORETURN` qualifier deletes the OpenVMS process after you enter ACMS.

`/PRINTFILE=print-file-spec`

`/PRINTFILE=spooled-device-name`

The `/PRINTFILE` qualifier assigns the Printfile characteristic to a device. The print response must appear in the form source IFDL file, and a print key must also be defined there. When the user presses the print key, the DECforms panel screens are automatically sent to the print file or spooled device specified after the `/PRINTFILE` qualifier.

When you specify the `/PRINTFILE` qualifier, you can specify only a spooled device name or a file name. The default for this qualifier is whatever is defined in the `DEFAULT` definition.

Notes

DDU writes the definition you are creating to the device authorization file in your current default directory, or to the file pointed to by the `EXECUTIVE` mode system logical name, `ACMSDDF`.

New definitions go into effect after you use the `ACMS/RESET TERMINALS` command, the `ACMS/START SYSTEM` command, or the `ACMS/START TERMINALS` command.

For more information about the DDU database authorization file (`ACMSDDF.DAT`) and the DDU in general, see Chapter 2.

Examples

1. `DDU> ADD TTE6`

This command creates a device definition for the terminal `TTE6`, using the sign-in characteristics defined in the `DDU DEFAULT` definition.

ADD

2. DDU> ADD TTE6 /CONTROLLED/AUTOLOGIN=JUDGE

This command creates a device definition with the Controlled and Autologin sign-in characteristics for terminal TTE6. Users at terminal TTE6 sign in directly to ACMS without typing a user name. ACMS places the user name JUDGE in the device definition file and uses that user name whenever a user presses at terminal TTE6.

3. DDU> ADD \$ALL/NOCONTROLLED

This command adds a definition for the group device name \$ALL, which authorizes all unauthorized terminals and assigns the terminals the Not Controlled sign-in characteristic.

4. DDU> ADD LT /NOCONTROLLED

This command adds a definition for the group device name LT. The LT device name authorizes all unauthorized LAT terminals and assigns the terminals the Not Controlled sign-in characteristic.

COPY Command (DDU>)

Authorizes a terminal, using the sign-in characteristics from the DDU definition you specify.

Format

COPY source-device-name new-device-name

Command Qualifiers

/[NO]AUTOLOGIN=user-name
/[NO]CONTROLLED

/PRINTFILE $\left[\begin{array}{l} \text{print-file-spec} \\ \text{spooled-device-name} \end{array} \right]$

Default

From source definition
From source definition

From source definition

Privileges Required

None

Parameters

source-device-name

The device name in the source definition. The source device name can be a logical name, a physical device name, or a group device name. Do not include a colon (:) when you specify a device name. See Table 2–1 for a list of the DDU group device names.

new-device-name

The device name in the definition you are creating. The new device name cannot already exist in the device authorization file. See source-device-name for syntax rules.

Qualifiers

/[NO]AUTOLOGIN=user-name

The /AUTOLOGIN qualifier enables automatic sign-ins for ACMS-controlled terminals. With automatic sign-in enabled, the user does not need to enter a user name to sign in to ACMS. If a password is required, the user receives the password prompt after pressing Return. If a password is not required, the user is signed in to ACMS as soon as Return is pressed on the terminal's keyboard.

ACMS places the user name you specify with the /AUTOLOGIN qualifier in the device authorization file and uses that user name each time a user presses Return at that terminal. A user name can contain 1 through 12 characters.

The /AUTOLOGIN qualifier has no effect unless the terminal has the Controlled sign-in characteristic. Assign a Controlled sign-in characteristic by specifying the /CONTROLLED qualifier. Disable automatic sign-ins with the /NOAUTOLOGIN qualifier. The default for this qualifier is whatever is defined in the definition you are copying.

/[NO]CONTROLLED

The `/CONTROLLED` qualifier assigns the Controlled sign-in characteristic to a device. Users at application port terminals with the Controlled sign-in characteristic sign in directly to ACMS. Users at dedicated service port terminals sign in either directly to ACMS or not, depending on the node they connect to at the “Local>” prompt. See Section 2.11 for a description of application ports and dedicated service ports.

The `/NOCONTROLLED` qualifier assigns the Not Controlled sign-in characteristic to a device. Users at terminals with the Not Controlled characteristic log in directly to OpenVMS. For access to ACMS, you must enter the `ACMS/ENTER` command.

When you use the `/CONTROLLED` qualifier, you can specify only a physical device name or the group device names `TT` and `LT`. See Table 2–1 for a description of the DDU group device names. The default for this qualifier is whatever is defined in the definition you are copying.

Note

The ACMS Terminal Subsystem Controller (TSC) does not support dialup lines as ACMS-controlled terminals. Because the TSC keeps a channel to ACMS-controlled terminals even when the user signs out, the modem does not receive any hangup notification. If you operate a terminal using ACMS over dialup lines, you must first log in to OpenVMS, and then issue the `ACMS/ENTER/NORETURN` command. The `/NORETURN` qualifier deletes the OpenVMS process after you enter ACMS.

/PRINTFILE=print-file-spec**/PRINTFILE=spoiled-device-name**

The `/PRINTFILE` qualifier assigns the Printfile characteristic to a device. The `PRINT` response must appear in the form source IFDL file, and a print key must also be defined there. When the user presses the print key, the HP DECforms panel screens automatically are sent to the print file or spoiled device specified after the `/PRINTFILE` qualifier.

When you specify the `/PRINTFILE` qualifier, you can specify only a spoiled device name or a file name. The default for this qualifier is The default for this qualifier is whatever is defined in the definition you are copying.

Notes

DDU writes the definition you are creating to the device authorization file in your current default directory, or to the file pointed to by the `EXECUTIVE` mode system logical name, `ACMSDDF`.

Changes to definitions go into effect after you use one of the following commands:

- `ACMS/RESET TERMINALS`
- `ACMS/START TERMINALS`
- `ACMS/START SYSTEM`

Example

```
DDU> COPY TTE1 TTE2
```

This command authorizes terminal TTE2 using the sign-in characteristics defined for terminal TTE1.

DEFAULT

DEFAULT Command (DDU>)

Changes information in the DDU DEFAULT definition.

Format

DEFAULT

Command Qualifiers

/[NO]AUTOLOGIN=user-name
/[NO]CONTROLLED

Default

From current DEFAULT definition
From current DEFAULT definition

(hardcopy)

/PRINTFILE $\left[\begin{array}{l} \text{print-file-spec} \\ \text{spooled-device-name} \end{array} \right]$ From DEFAULT definition

Privileges Required

None

Qualifiers

/[NO]AUTOLOGIN=user-name

The /AUTOLOGIN qualifier enables automatic sign-ins for ACMS-controlled terminals. With automatic login enabled, the user does not need to enter a user name to sign in to ACMS. If a password is required, the user receives the password prompt after pressing **Return**. If a password is not required, the user is signed in to ACMS as soon as **Return** is pressed on the terminal's keyboard.

ACMS places the user name you specify with the /AUTOLOGIN qualifier in the device authorization file and uses that user name each time a user presses **Return** at that terminal. The user name can contain 1 through 12 characters.

The /AUTOLOGIN qualifier has no effect unless the terminal has the Controlled sign-in characteristic. Assign a Controlled sign-in characteristic by specifying the /CONTROLLED qualifier. Disable automatic sign-ins with the /NOAUTOLOGIN qualifier. The default is whatever sign-in characteristics are currently defined in the DDU DEFAULT definition.

/[NO]CONTROLLED

The /CONTROLLED qualifier assigns the Controlled sign-in characteristic to a device. Users at application port terminals with the Controlled sign-in characteristic sign in directly to ACMS. Users at dedicated service port terminals sign in either directly to ACMS or not, depending on the node they connect to at the "Local>" prompt. See Section 2.11 for a description of application ports and dedicated service ports.

The /NOCONTROLLED qualifier assigns the Not Controlled sign-in characteristic to a device. Users at terminals with the Not Controlled characteristic log in directly to OpenVMS. For access to ACMS, you must enter the ACMS/ENTER command.

When you specify the /CONTROLLED qualifier, you can specify only a physical device name or the group device names TT and LT. See Table 2–1 for a description of the DDU group device names. The default is whatever sign-in characteristics are currently defined in the DDU DEFAULT definition.

Note

The ACMS Terminal Subsystem Controller (TSC) does not support dialup lines as ACMS-controlled terminals. Because the TSC keeps a channel to ACMS-controlled terminals even when the user signs out, the modem does not receive any hangup notification. If you operate a terminal using ACMS over dialup lines, you must first log in to OpenVMS, and then issue the ACMS/ENTER/NORETURN command. The /NORETURN qualifier deletes the OpenVMS process after you enter ACMS.

/PRINTFILE=print-file-spec

/PRINTFILE=spooled-device-name

The /PRINTFILE qualifier assigns the Printfile characteristic to a device. The PRINT response must appear in the form source IFDL file, and a print key must also be defined there. When the user presses the print key, the DECforms panel screens automatically are sent to the print file or spooled device specified after the /PRINTFILE qualifier.

When you specify the /PRINTFILE qualifier, you can specify only a spooled device name or a file name. The default for this qualifier is whatever is defined in the default definition.

Notes

The ADD command is the only command affected by the characteristics defined in the DDU DEFAULT definition. If you do not specify any qualifiers when you use the ADD command to create a new DDU definition, the definition takes the sign-in characteristics assigned in the DEFAULT definition. You can use qualifiers with the ADD command to override the characteristics defined with the DEFAULT command.

ACMS creates a DEFAULT definition the first time you run DDU, or whenever you create a new device authorization file. By default, the DDU DEFAULT definition created by ACMS has the Not Controlled and No Autologin sign-in characteristics.

Changes to definitions go into effect after you use one of the following commands:

- ACMS/RESET TERMINALS
- ACMS/START TERMINALS
- ACMS/START SYSTEM

Example

```
DDU> DEFAULT /NOCONTROLLED
```

This command specifies that the DEFAULT definition has the Not Controlled sign-in characteristic.

EXIT

EXIT Command (DDU>)

Ends the DDU session and returns you to the DCL prompt.

Format

EXIT

Privileges Required

None

Notes

You can also end a session by pressing `Ctrl/Z`. Pressing `Ctrl/Z` signals the end of the file for data entered from the terminal. EXIT is displayed when you press `Ctrl/Z`.

Example

```
DDU> EXIT
$
```

This command causes you to exit from DDU and returns you to DCL.

HELP Command (DDU>)

Displays information about DDU commands and qualifiers.

Format

HELP [topic [...]]

Command Qualifier	Default
/[NO]PROMPT	/PROMPT

Privileges Required

None

Parameters

topic

The DDU command or topic you want to know about. If you do not specify a topic, HELP provides a list of topics to choose from.

Qualifiers

/[NO]PROMPT

The /PROMPT qualifier causes DDU help to display prompts with help information. If you use the /NOPROMPT qualifier, DDU help does not display prompts. /PROMPT is the default.

Notes

None

Example

```
DDU> HELP DEFAULT
DEFAULT
    Changes the contents of the DEFAULT definition in the database
    Format:
        DEFAULT
    For example:
        DDU> DEFAULT /CONTROLLED
    The DEFAULT definition contains default characteristics for terminals
    defined with the ADD command
    Additional information available:
    Qualifiers
    /AUTOLOGIN /CONTROLLED
DEFAULT Subtopic?
```

This command displays help information about the DEFAULT command.

LIST

LIST Command (DDU>)

Writes DDU definitions to ACMSDDU.LIS in your default directory, or to an output file you specify.

Format

LIST device-name

Command Qualifiers

/BRIEF
/OUTPUT[=file-spec]

Defaults

Full DDU definitions
/OUTPUT=ACMSDDU.LIS

Privileges Required

None

Parameters

device-name

The name of the device. Do not include a colon (:) when you specify a device name. The device name can be a logical name, a physical device name, a group device name, or the wildcard character (*). See Table 2–1 for a list of the DDU group device names. To write all definitions to an output file, use the wildcard character instead of a device name. You can use the wildcard character as a prefix, a suffix, or both to list device names with common characters (for example: TT*, *TT, or *TT*).

Qualifiers

/BRIEF

Lists only the device names in DDU definitions. The default is to list complete definitions.

/OUTPUT[=file-spec]

Changes the file specification for the listing file. The default file specification is ACMSDDU.LIS, in your current default directory.

Notes

None

Examples

1. DDU> LIST *

This command writes the full definitions for all device names in the device authorization to the default output file ACMSDDU.LIS.

2. DDU> LIST VT

This command writes a definition for the group device name VT to the listing file ACMSDDU.LIS.

3. DDU> LIST /BRIEF *

This command writes all the device names in the device authorization file to the file ACMSDDU.LIS.

4. DDU> LIST /OUTPUT=LOCAL.LIS *T*

This command writes all device definitions containing the letter T to the output file LOCAL.LIS.

MODIFY

MODIFY Command (DDU>)

Changes the sign-in characteristics in a DDU definition.

Format

MODIFY device-name

Command Qualifiers

/[NO]AUTOLOGIN=user-name
/[NO]CONTROLLED

Default

From current definition
From current definition

/PRINTFILE $\left[\begin{array}{l} \text{print-file-spec} \\ \text{spooled-device-name} \end{array} \right]$ From current definition

Privileges Required

None

Parameter

device-name

The name of the device. Do not include a colon (:) when you specify a device name. The device name can be a logical name, a physical device name, or a group device name. See Table 2–1 for a list of the DDU group device names.

Qualifiers

/[NO]AUTOLOGIN=user-name

The /AUTOLOGIN qualifier enables automatic sign-ins for ACMS-controlled terminals. With automatic sign-in enabled, the user does not need to enter a user name to sign in to ACMS. If a password is required, the user receives the password prompt after pressing **Return**. If a password is not required, the user is signed in to ACMS as soon as **Return** is pressed on the terminal's keyboard.

ACMS places the user name you specify with the /AUTOLOGIN qualifier in the device authorization file and uses that user name each time a user presses **Return** at that terminal. The user name can contain 1 through 12 characters.

The /AUTOLOGIN qualifier has no effect unless the terminal has the Controlled sign-in characteristic. You can assign a Controlled sign-in characteristic by specifying the /CONTROLLED qualifier. You can disable automatic sign-ins with the /NOAUTOLOGIN qualifier. The default for this qualifier is whatever sign-in characteristics are currently defined in the definition you are modifying.

/[NO]CONTROLLED

The /CONTROLLED qualifier assigns the Controlled sign-in characteristic to a device. Users at application port terminals with the Controlled sign-in characteristic sign in directly to ACMS. Users at dedicated service port terminals sign in either directly to ACMS or not, depending on the node they connect to at the "Local>" prompt. See Section 2.11 for a description of application ports and dedicated service ports.

The /NOCONTROLLED qualifier assigns the Not Controlled sign-in characteristic to a device. Users at terminals with the Not Controlled characteristic log in directly to OpenVMS. For access to ACMS, a user must enter the ACMS/ENTER command.

When you specify the `/CONTROLLED` qualifier, you can specify only a physical device name or the group device names `TT` and `LT`. See Table 2–1 for a description of the DDU group device names. The default for this qualifier is whatever is currently defined in the definition you are modifying.

Note

The ACMS Terminal Subsystem Controller (TSC) does not support dialup lines as ACMS-controlled terminals. Because the TSC keeps a channel to ACMS-controlled terminals even when the user signs out, the modem does not receive any hangup notification. If you operate a terminal using ACMS over dialup lines, you must first log in to OpenVMS, and then issue the `ACMS/ENTER/NORETURN` command. The `/NORETURN` qualifier deletes the OpenVMS process after you enter ACMS.

`/PRINTFILE=print-file-spec`

`/PRINTFILE=spooled-device-name`

The `/PRINTFILE` qualifier assigns the Printfile characteristic to a device. The `PRINT` response must appear in the form source IFDL file, and a print key must also be defined there. When the user presses the print key, the HP DECforms panel screens automatically are sent to the print file or spooled device specified after the `/PRINTFILE` qualifier.

When you specify the `/PRINTFILE` qualifier, you can specify only a spooled device name or a file name. The default for this qualifier is whatever sign-in characteristics are currently defined in the definition you are modifying.

The DDU `MODIFY` command does not invoke an editor.

Notes

Changes to definitions go into effect after you use one of the following commands:

- `ACMS/RESET TERMINALS`
- `ACMS/START TERMINALS`
- `ACMS/START SYSTEM`

The DDU `MODIFY` command does not invoke an editor.

Examples

1. `DDU> MODIFY TTE3 /NOCONTROLLED`

This command removes the `Controlled` characteristic from terminal `TTE3`. Users log in directly to OpenVMS at terminal `TTE3`.

2. `DDU> MODIFY TTE4 /AUTOLOGIN=EVARD /CONTROLLED`

This command assigns the `Autologin` and `Controlled` characteristics to terminal `TTE4`. User `EVARD` signs in directly to ACMS at terminal `TTE4` by pressing the `Return` and typing a password.

MODIFY

3. DDU> MODIFY TTE5 /PRINTFILE=SPOOLDEV::TXA0:

This command assigns the Printfile characteristic to terminal TTE5 and specifies spooled device SPOOLDEV::TXA0: as the device for any HP DECforms panel screens to be printed when the user presses the Print key.

REMOVE Command (DDU>)

Removes a DDU definition from the device authorization file.

Format

REMOVE device-name

Parameters

device-name

The name of the device. Do not include a colon (:) when you specify a device name. The device name can be a logical name, a physical device name, or a group device name. See Table 2–1 for a list of the DDU group device names.

Privileges Required

None

Notes

To restrict a terminal to OpenVMS use only, delete the definition for the \$ALL group device name (if the device authorization file contains one), and then delete the definition for the terminal.

You cannot remove the DEFAULT definition from the DDU device authorization file.

Changes to definitions go into effect after you use one of the following commands:

- ACMS/RESET TERMINALS
- ACMS/START TERMINALS
- ACMS/START SYSTEM

Examples

1. DDU> REMOVE TTE5
Device TTE5 has been removed from the database

This command deletes the device definition for TTE5. If the device authorization file does not contain a \$ALL definition, this command removes terminal TTE5 for use with ACMS.

2. DDU> REMOVE \$ALL
Device \$ALL has been removed from the database

This command deletes the \$ALL definition. The command deauthorizes all terminals that do not have individual device definitions.

RENAME

RENAME Command (DDU>)

Changes the device name in a DDU definition.

Format

RENAME old-device-name new-device-name

Command Qualifiers

/[NO]AUTOLOGIN=user-name

/[NO]CONTROLLED

/PRINTFILE $\left[\begin{array}{l} \text{print-file-spec} \\ \text{spooled-device-name} \end{array} \right]$

Default

From old definition

From old definition

From old definition

Privileges Required

None

Parameters

old-device-name

The device name in the definition you are changing. The device name can be a logical name, a physical device name, or a group device name. Do not include a colon (:) when you specify a device name. See Table 2–1 for a list of the DDU group device names.

new-device-name

The new name for the device. The new device name cannot already exist in the device authorization file. See the description of old-device-name for syntax rules.

Qualifiers

/[NO]AUTOLOGIN=user-name

The /AUTOLOGIN qualifier enables automatic sign-ins for ACMS-controlled terminals. With automatic sign-in enabled, the user does not need to enter a user name to sign in to ACMS. If a password is required, the user receives the password prompt after pressing . If a password is not required, the user is signed in to ACMS as soon as is pressed on the terminal's keyboard.

ACMS places the user name you specify with the /AUTOLOGIN qualifier in the device authorization file and uses that user name each time a user presses at that terminal. The user name can contain 1 through 12 characters.

The /AUTOLOGIN qualifier has no effect unless the terminal has the Controlled sign-in characteristic. Assign a Controlled sign-in characteristic by specifying the /CONTROLLED qualifier. Disable automatic sign-ins with the /NOAUTOLOGIN qualifier. The default for this qualifier is whatever sign-in characteristics are defined in the original definition.

/[NO]CONTROLLED

The /CONTROLLED qualifier assigns the Controlled sign-in characteristic to a device. Users at application port terminals with the Controlled sign-in characteristic sign in directly to ACMS. Users at dedicated service port terminals sign in either directly to ACMS or not, depending on the node they connect to at

the “Local>” prompt. See Section 2.11 for a description of application ports and dedicated service ports.

The /NOCONTROLLED qualifier assigns the Not Controlled sign-in characteristic to a device. Users at terminals with the Not Controlled characteristic log in directly to OpenVMS. For access to ACMS, a user must enter the ACMS/ENTER command.

When you specify the /CONTROLLED qualifier, you can specify only a physical device name or the group device names TT and LT. See Table 2–1 for a description of the DDU group device names. The default for this qualifier is whatever sign-in characteristics are defined in the original definition.

Note

The ACMS Terminal Subsystem Controller (TSC) does not support dialup lines as ACMS-controlled terminals. Because the TSC keeps a channel to ACMS-controlled terminals even when the user signs out, the modem does not receive any hangup notification. If you operate a terminal using ACMS over dialup lines, you must first log in to OpenVMS, and then issue the ACMS/ENTER/NORETURN command. The /NORETURN qualifier deletes the OpenVMS process after you enter ACMS.

/PRINTFILE=print-file-spec

/PRINTFILE=spooled-device-name

The /PRINTFILE qualifier assigns the Printfile characteristic to a device. The PRINT response must appear in the form source IFDL file, and a print key must also be defined there. When the user presses the print key, the HP DECforms panel screens automatically are sent to the print file or spooled device specified after the /PRINTFILE qualifier.

When you specify the /PRINTFILE qualifier, you can specify only a spooled device name or a file name. The default for this qualifier is whatever sign-in characteristics are currently defined in the original definition.

Notes

You cannot rename the DEFAULT definition.

Changes to definitions go into effect after you use one of the following commands:

- ACMS/RESET TERMINALS
- ACMS/START TERMINALS
- ACMS/START SYSTEM

Examples

1. DDU> RENAME TTE7 TTE6 /CONTROLLED

This command changes the device name of terminal TTE7 to TTE6 and assigns the Controlled sign-in characteristic. Terminal TTE7 is no longer authorized.

RENAME

2. DDU> RENAME TTE6 TTE7 /NOCONTROLLED

This command changes the device name of terminal TTE6 to TTE7 and removes the Controlled characteristic from the definition. Users log in to OpenVMS from terminal TTE7 and enter ACMS using the ACMS/ENTER command. Terminal TTE6 is no longer authorized.

SHOW Command (DDU>)

Displays DDU definitions.

Format

SHOW device-name

Command Qualifier	Default
/BRIEF	Full definition

Privileges Required

None

Parameters

device-name

The name of the device. Do not include a colon (:) when you specify a device name. The device name can be a logical name, a physical device name, a group device name, or the wildcard character (*). See Table 2–1 for a list of the DDU group device names. You can use the wildcard character as a prefix, a suffix, or both to specify a partial device name, for example, TT*, *TT, or *TT*.

Qualifiers

/BRIEF

Displays only device names. DDU displays complete definitions by default.

Notes

To display all definitions, use the wildcard character (*) as the parameter.

Examples

```

1. DDU> SHOW *
   Device Name:          DEFAULT          NOT CONTROLLED
   No Autologin
   Printfile:

   Device Name:          LT              NOT CONTROLLED
   No Autologin
   Printfile:

   Device Name:          LTA902          CONTROLLED
   Autologin Username:  TURKLES
   Printfile:

   Device Name:          TT              NOT CONTROLLED
   No Autologin
   Printfile:

   Device Name:          TTB5           NOT CONTROLLED
   No Autologin
   Printfile:

```

SHOW

```
Device Name:          VTA65          NOT CONTROLLED
No Autologin
Printfile:
```

This command displays the full device definitions for all devices authorized in the device authorization file.

```
2. DDU> SHOW * /BRIEF
Device Name:  DEFAULT
Device Name:  LT
Device Name:  LTA901
Device Name:  LTA902
Device Name:  LTA903
Device Name:  LTA904
Device Name:  PT
Device Name:  RT
Device Name:  TT
Device Name:  TTA9
Device Name:  TTB5
Device Name:  TTE5
Device Name:  VT
Device Name:  VTA65
```

This command displays just the device names for all devices authorized in the device authorization file.

```
3. DDU> SHOW TTE4
Device Name:          TTE4          CONTROLLED
Autologin Username:  MILLER
```

This command displays the full device definition for terminal TTE4.

```
4. DDU> SHOW VT
Device Name:          VT          NOT CONTROLLED
No Autologin
```

This command displays the device definition that authorizes virtual terminals to have access to your ACMS system.

```
5. DDU> SHOW *E*
Device Name:          DEFAULT          NOT CONTROLLED
No Autologin
Printfile:

Device Name:          TTE5          NOT CONTROLLED
No Autologin
Printfile:  SPOOLDEV::TXA0:

Device Name:          TTE6          NOT CONTROLLED
No Autologin
```

This command displays all device definitions for terminals containing the letter E.

UDU Commands

This chapter contains reference information and examples for the ACMS User Definition Utility (UDU) commands. See Chapter 3 for more information on the UDU commands and their functions.

ADD

ADD Command (UDU>)

Authorizes and assigns sign-in characteristics to ACMS users by adding UDU definitions to the user authorization file (ACMSUDF.DAT). You can use qualifiers to assign sign-in characteristics or let new definitions receive information from the UDU DEFAULT definition.

Format

ADD user-name

Command Qualifiers	Default
/[NO]AGENT	From DEFAULT definition
/[NO]DISPLAY_MENU	From DEFAULT definition
/[NO]FINAL=(keyword[,...])	From DEFAULT definition
/[NO]INITIAL=(keyword[,...])	From DEFAULT definition
/LANGUAGE=language-name	From DEFAULT definition
/MDB=menu-database-file	From DEFAULT definition
/MENU[=menu-path-name]	From DEFAULT definition
/PRINTFILE $\left[\begin{array}{l} = \text{print-file-spec} \\ \text{spooled-device-name} \end{array} \right]$	From DEFAULT definition
/[NO]SKIPMENULANGUAGE	From DEFAULT definition

Privileges Required

None

Parameters

user-name

The OpenVMS user name in the definition you are creating. The user name can be \$ALL.

Qualifiers

/[NO]AGENT

Enables an agent to submit a task that has a user name different from the user name of the agent process. You must use the /AGENT qualifier to authorize the Command Process (CP) and the Queued Task Initiator (QTI) as agents. If your system has other agent programs that submit tasks of this type, you must also authorize them with the /AGENT qualifier. You must use the /AGENT qualifier for any user name that a detached task runs under. Use the /NOAGENT qualifier when an agent program no longer submits tasks for processing that run under user names other than the submitting agent program. The default is taken from the DEFAULT definition.

/[NO]DISPLAY_MENU

Enables the menu display identified in the user's definition and the Selection: prompt once the user signs in. A menu is identified by a menu path name and a menu database file. If a user's definition has the NODISPLAY_MENU characteristic, ACMS displays only the Selection: prompt after the user signs in, without a full default menu. The /NODISPLAY_MENU qualifier disables the menu display. The default is taken from the DEFAULT definition.

/[NO]FINAL=(keyword[,...])

Specifies a task that is run when the user exits from ACMS. The default is taken from the DEFAULT definition.

Specify one or more of the following keywords. If you specify more than one keyword, you must enclose the keywords in parentheses.

ADD

- **APPLICATION=application-name**
Specifies the application in which the final task is run. When you specify the **APPLICATION** keyword, you must also specify a task name with the **TASK** keyword.
- **[NO]IGNORE_ERROR**
Specifies that errors in the final task are ignored. If an error occurs in the final task, ACMS does not display an error message or record information about the error in the audit trail log file.
- **[NO]SELECTION_STRING="string"**
Specifies a parameter required by the final task. For example, if the final task is an editor, "string" is the file specification of the file to be edited. Enclose the string in quotation marks.
- **TASK=task-name**
Specifies the name of the final task. When you specify the **TASK** keyword, you must also specify an application name with the **APPLICATION** keyword.

/[NO]INITIAL=(keyword[,...])

Specifies the task that is run when the user enters the ACMS environment. The default is taken from the **DEFAULT** definition.

Specify one or more of the following keywords. If you specify more than one keyword, you must enclose the keywords in parentheses.

- **APPLICATION=application-name**
Specifies the application in which the initial task is run. When you specify the **APPLICATION** keyword, you must also specify a task name with the **TASK** keyword.
- **[NO]IGNORE_ERROR**
Specifies that errors in the initial task are ignored. By default, if an error occurs in an initial task, an error message is displayed on the user's terminal, the reason for the error is recorded in the audit trail log, and the user is signed out of ACMS.
- **[NO]SELECTION_STRING="string"**
Specifies a parameter required by the initial task. For example, if the initial task is an editor, "string" is the file specification of the file to be edited. Enclose the string in quotation marks.
- **TASK=task-name**
Specifies the name of the initial task. When you specify the **TASK** keyword, you must also specify an application name with the **APPLICATION** keyword.

/LANGUAGE=language-name

Assigns a language to a user in a UDU definition. ACMS matches the language assigned to a user with the language assigned to a DECforms form layout and displays panels in the selected language. The default is taken from the **DEFAULT** definition.

/MDB=menu-database-file

Assigns a menu database file to a UDU definition. A menu database file is a file of run-time menu definitions created by the Application Definition Utility (ADU) **BUILD** command. The ACMS run-time system assumes **ACMS\$DIRECTORY** as

the default directory and .MDB as the default file type for menu database files in UDU definitions. If you do not specify the /MDB qualifier, the name of the menu database file is taken from the DEFAULT definition.

/MENU[=menu-path-name]

Assigns a menu to a UDU definition. The menu path name is the location of a run-time menu definition in a menu database file. Users cannot see menus whose path names are higher in the menu tree than their default menu path names. Path names for all menus except the highest menu consist of strings of menu keywords. If you do not know the path name to include with the /MENU qualifier, you can derive the menu path name from menu keywords, as explained in *HP ACMS for OpenVMS ADU Reference Manual*.

You can define menu entries that contain slashes in the menu definition; however, you cannot specify menu paths containing these slashes in the UDU.

For example, the following format is *not* allowed:

```
UDU> MODIFY SMITH /MENU="TOP/V32.SUBMENU"
```

If you do not specify a menu path name, the user receives the path name defined in the DEFAULT definition. If there is no path name defined in the DEFAULT definition, a blank path name is assigned. When signing in with a blank path name assigned, the user receives the top menu in the menu database file.

/PRINTFILE=print-file-spec

/PRINTFILE=spooled-device-name

Use this qualifier to specify a file name or spooled device name for a user. When a form is enabled, ACMS uses the Printfile specification for a device assigned in DDU, if it is available. If it is not, ACMS uses the Printfile specification for the user.

To use the Printfile feature, you must also include a PRINT response step in the DECforms source IDFL file that contains the specifications of the panel that you want to print.

/[NO]SKIPMENULANGUAGE

Use this qualifier with the /LANGUAGE qualifier to specify that a language is to be assigned to a user for all DECforms forms except menu forms. For example, with the /SKIPMENULANGUAGE qualifier you can specify that DECforms display all panels in French except menu panels.

Notes

Create a user definition for the CP using the /AGENT qualifier. This action authorizes the CP as an agent.

Specifying the \$ALL user name authorizes and assigns sign-in characteristics to users who do not have separate definitions. If the user authorization file, ACMSUDF.DAT, does not contain a \$ALL definition, each ACMS user needs a separate definition.

The menu database file, menu path names, and OpenVMS account must be created before a user can sign in. However, you can add a menu database file specification or default menu path name to a UDU definition before the menu database file or menu path name exists. You can create a definition for a user before the user has an OpenVMS account.

ADD

Examples

1. UDU> ADD CONNOR

This command creates a new definition for the user name CONNOR. Because the command has no qualifiers, the new definition receives information from the DEFAULT definition.

2. UDU> ADD CMDPRCSS /AGENT

This command authorizes the CP as an agent. ACMS requires you to create a user definition for the CP and also for any other task submitting agent that processes tasks running under user names different from that of the Command Process. The user name of the Command Process (CMDPRCSS) is defined with the ACMSGEN Utility.

3. UDU> ADD \$ALL /MENU=PERSONNEL

This command creates a \$ALL definition authorizing all OpenVMS users to sign in to ACMS. The /MENU qualifier assigns the default menu path name PERSONNEL to the \$ALL definition. The \$ALL definition receives the remaining information from the DEFAULT definition. ACMS uses the \$ALL definition for users who do not have separate user definitions.

4. UDU> ADD CONNOR /MDB=WORKDISK\$:[CONNOR]ACMS.MDB /MENU=PERSONNEL

This command creates a new definition for CONNOR. The /MDB and /MENU qualifiers assign to CONNOR the menu path name PERSONNEL and the menu database file WORKDISK\$:[CONNOR]ACMS.MDB.

5. UDU> ADD BELLOW /INITIAL=(APPLICATION=ACCOUNTING, -
_UDU> TASK=LOGGING_PROG, SELECTION_STRING="LOG.DAT")

This command creates a new definition for BELLOW. The /INITIAL qualifier specifies that the task LOGGING_PROG in application ACCOUNTING is run when BELLOW signs in. Task LOGGING_PROG displays the file LOG.DAT, which verifies BELLOW's booking information.

ADD /PROXY Command (UDU>)

Adds a user proxy to the ACMS proxy file (ACMSPROXY.DAT). Before you can use the ADD /PROXY command, you must have already created a proxy file using the CREATE /PROXY command.

Format

```
ADD /PROXY remote-node::remote-user local-user
```

Parameters

remote-node

Specifies a remote node name (1 to 6 alphanumeric characters). If you substitute an asterisk, the specified <remote-user> on all nodes is authorized to submit tasks under the user name specified by the <local-user> parameter.

remote-user

Specifies the user name of a user at a remote node. A valid user name is a string of 1 to 12 alphanumeric characters and can contain underscores and dollar signs. If you use an asterisk, all users on the specified <remote-node> are authorized to submit tasks under the user name specified by the <local-user> parameter.

local-user

Specifies the user name of the user on the local application node. If you specify an asterisk, the local user name is the same as the remote user name. You can specify only one <local-user> for each <remote-node>::<remote-user> combination.

Notes

UDU does not check that the <local-user> name you enter is unique. Use the SHOW /PROXY *:* command to obtain a list of <local-user> names.

When you add a proxy, UDU interprets the <remote-node>::<remote-user> and <local-user> parameters as text strings, and each parameter is stored as specified, including any asterisks. However, at run time, ACMS interprets the asterisk as a wildcard.

You cannot partially wildcard any parameters with the ADD /PROXY command. For example, if a user specifies <remote-node>::<remote-user> as COMET::PERS*, UDU returns the error message, "Invalid remote user proxy specification."

Before you create a proxy file, set default to the appropriate directory, such as SYS\$SYSTEM, or define a logical for the proper directory location for the proxy file.

ADD /PROXY

Examples

Note

The following examples assume that the proxy file is empty.

1. UDU> CREATE /PROXY
UDU> ADD /PROXY COMET::PERSONNEL PERS_USER
UDU> SHOW /PROXY *
Remote User: COMET::PERSONNEL Local User: PERS_USER

In this example, the ADD command adds a single proxy that allows the user on node COMET with user name PERSONNEL to select a task on the application node using the user name of PERS_USER.

2. UDU> ADD /PROXY COMET::* RENTAL_AGENT
UDU> SHOW /PROXY *

Remote User: COMET::* Local User: RENTAL_AGENT
Remote User: COMET::PERSONNEL Local User: PERS_USER

In this example, the ADD command specifies that any remote user except PERSONNEL on node COMET can select a task on the application node using the user name RENTAL_AGENT. When user PERSONNEL on node COMET selects a task on the application node, the local user name is PERS_USER, because there is a specific proxy for COMET::PERSONNEL. The asterisk is interpreted as a literal in the ADD /PROXY command.

3. UDU> ADD /PROXY *::BICKFORD *
UDU> SHOW /PROXY *

Remote User: *::BICKFORD Local User: *
Remote User: COMET::* Local User: RENTAL_AGENT
Remote User: COMET::PERSONNEL Local User: PERS_USER

In this example, the ADD command specifies that remote task submitters with the user name BICKFORD on any remote node can select a task on the application node using the same user name.

COPY Command (UDU>)

Authorizes and assigns sign-in characteristics to ACMS users by creating new UDU definitions from existing UDU definitions. With qualifiers, you can assign different sign-in characteristics to the new definitions.

Format

COPY source-user-name new-user-name

Command Qualifiers	Default
/[NO]AGENT	From source definition
/[NO]DISPLAY_MENU	From source definition
/[NO]FINAL=(keyword[,...])	From source definition
/[NO]INITIAL=(keyword[,...])	From source definition
/LANGUAGE=[language-name]	From source definition
/MDB=menu-database-file	From source definition
/PRINTFILE $\left[\begin{array}{l} = \text{print-file-spec} \\ \text{spooled-device-name} \end{array} \right]$	From source definition
/[NO]SKIPMENULANGUAGE	From source definition

Privileges Required

None

Parameters

source-user-name

The OpenVMS user name in the source definition. The source user name can be \$ALL.

new-user-name

The OpenVMS user name for the new definition. The new user name can be \$ALL.

Qualifiers

/[NO]AGENT

The /AGENT qualifier enables an agent to submit a task that has a user name different from the user name of the agent process. You must use the /AGENT qualifier to authorize the CP and the QTI as agents. If your system has other agent programs that submit tasks of this type, you must also authorize them with the /AGENT qualifier. You must use the /AGENT qualifier for any user name that a detached task runs under. Use the /NOAGENT qualifier when an agent program no longer submits tasks for processing that run under user names other than the submitting agent program. The default is whatever is defined in the source definition.

/[NO]DISPLAY_MENU

The /DISPLAY_MENU qualifier enables the menu display identified in the user's definition and the Selection: prompt once the user signs in. A menu is identified by a menu path name and a menu database file. If a user's definition has the NODISPLAY_MENU characteristic, ACMS displays only the Selection: prompt after the user signs in, without a full default menu. The /NODISPLAY_MENU

qualifier disables the menu display. The default is whatever is defined in the source definition.

/[NO]FINAL=(keyword[,...])

Specifies a task that is run when the user exits from ACMS. If you do not specify the `/[NO]FINAL` qualifier, the default is taken from the source definition.

Specify one or more of the following keywords. If you specify more than one keyword, you must enclose the keywords in parentheses.

- **APPLICATION=application-name**
Specifies the application in which the final task is run. When you specify the `APPLICATION` keyword, you must also specify a task name with the `TASK` keyword.
- **[NO]IGNORE_ERROR**
Specifies that errors in the final task are ignored. If an error occurs in the final task, ACMS does not display an error message or record information about the error in the audit trail log file.
- **[NO]SELECTION_STRING="string"**
Specifies a parameter required by the final task. For example, if the final task is an editor, "string" is the file specification of the file to be edited. Enclose the string in quotation marks.
- **TASK=task-name**
Specifies the name of the final task.

/[NO]INITIAL=(keyword[,...])

Specifies the task that is run when the user enters the ACMS environment. The default is taken from the source definition.

Specify one or more of the following keywords. If you specify more than one keyword, you must enclose the keywords in parentheses.

- **APPLICATION=application-name**
Specifies the application in which the initial task is run. When you specify the `APPLICATION` keyword, you must also specify a task name with the `TASK` keyword.
- **[NO]IGNORE_ERROR**
Specifies that errors in the initial task are ignored. By default, if an error occurs in an initial task, an error message is displayed on the user's terminal, the reason for the error is recorded in the audit trail log, and the user is signed out of ACMS.
- **[NO]SELECTION_STRING="string"**
Specifies a parameter required by the initial task. For example, if the initial task is an editor, "string" is the file specification of the file to be edited. Enclose the string in quotation marks.
- **TASK=task-name**
Specifies the name of the initial task.

/LANGUAGE[=language-name]

Assigns a language to a user in a UDU definition. ACMS matches the language assigned to a user with the language assigned to a DECforms form layout and displays panels in the selected language. The default is taken from the source definition.

/MDB=menu-database-file

Assigns a menu database file to a UDU definition. A menu database file is a file of run-time menu definitions created by the Application Definition Utility (ADU) BUILD command. The ACMS run-time system assumes ACMS\$DIRECTORY as the default directory and .MDB as the default file type for menu database files in UDU definitions. The default is whatever is defined in the source definition.

/MENU[=menu-path-name]

Assigns a menu to a UDU definition. The menu path name is the location of a run-time menu definition in a menu database file. Users cannot see menus whose path names are higher in the menu tree than their default menu path names. Path names for all menus except the highest menu consist of strings of menu keywords. If you do not know the path name to include with the /MENU qualifier, you can derive the menu path name from menu keywords, as explained in *HP ACMS for OpenVMS ADU Reference Manual*.

You can define menu entries that contain slashes in the menu definition; however, you cannot specify menu paths containing these slashes in the UDU.

For example, the following format is *not* allowed:

```
UDU> MODIFY SMITH /MENU="TOP/V32.SUBMENU"
```

If you do not specify a path name and there is no path name defined in the source definition, the user receives a blank path name. When a blank path name is defined, the user receives the top menu in the menu database file when signing in.

/PRINTFILE=print-file-spec**/PRINTFILE=spoiled-device-name**

Use this qualifier to specify a file name or spooled device name for a user. When a form is enabled, ACMS uses the Printfile specification for a device assigned in DDU, if it is available. If it is not, ACMS uses the Printfile specification for the user.

To use the Printfile feature, you must also include a PRINT response step in the DECforms source IDFL file that contains the specifications of the panel that you want to print.

/[NO]SKIPMENULANGUAGE

Use this qualifier with the /LANGUAGE qualifier to specify that a language is to be assigned to a user for all DECforms forms except menu forms. For example, with the /SKIPMENULANGUAGE qualifier you can specify that DECforms display all panels in French except menu panels.

Notes

None

COPY

Examples

1. UDU> COPY COURTS WILSON

This command creates a user definition for WILSON, copying all the information from the definition for COURTS.

2. UDU> COPY TRACY MORRIS /MENU=EMPLOYEE

This command creates a user definition for MORRIS, copying information from the definition for TRACY. The /MENU qualifier assigns MORRIS a different default menu path name, EMPLOYEE.

3. UDU> COPY STEVENS SMITH /MENU

This command creates a user definition for SMITH, copying information from the definition for STEVENS. The /MENU qualifier overrides the path name from the STEVENS definition, so the definition for SMITH receives a blank path name. After signing in, SMITH receives the top menu in the menu database file.

CREATE /PROXY Command (UDU>)

Creates an empty ACMS proxy file (ACMSPROXY.DAT).

Format

```
CREATE /PROXY
```

Note

Creates an empty ACMS proxy file, ACMSPROXY.DAT. If you define the ACMSPROXY logical name and then enter the UDU CREATE /PROXY command, the empty proxy file is created at the location defined by the ACMSPROXY logical name. If you do not define the ACMSPROXY logical name, UDU creates ACMSPROXY.DAT in your current directory. If the proxy file already exists, UDU returns an error message.

Example

```
UDU> CREATE /PROXY
```

This command creates an ACMS proxy file.

DEFAULT

DEFAULT Command (UDU>)

Changes information in the UDU DEFAULT definition. If you omit one or more qualifiers from an ADD command, the resulting new definition receives information from the existing DEFAULT definition.

Format

DEFAULT

Command Qualifiers

`/[NO]AGENT`
`/[NO]DISPLAY_MENU`
`/[NO]FINAL=(keyword[,...])`
`/[NO]INITIAL=(keyword[,...])`
`/LANGUAGE=[language-name]`
`/MDB=menu-database-file`
`/MENU=[menu-path-name]`

`/PRINTFILE` $\left[\begin{array}{l} = \text{print-file-spec} \\ \text{spooled-device-name} \end{array} \right]$

`/[NO]SKIPMENULANGUAGE`

Default

From existing DEFAULT definition
From existing DEFAULT definition
From existing DEFAULT definition
From existing DEFAULT definition
From existing DEFAULT definition
From existing DEFAULT definition
From existing DEFAULT definition

From existing DEFAULT definition

From existing DEFAULT definition

Privileges Required

None

Qualifiers

/[NO]AGENT

The `/AGENT` qualifier enables an agent to submit a task that has a user name different from the user name of the agent process. You must use the `/AGENT` qualifier to authorize the CP and the QTI as agents. If your system has other agent programs that submit tasks of this type, you must also authorize them with the `/AGENT` qualifier. You must use the `/AGENT` qualifier for any user name that a detached task runs under. Use the `/NOAGENT` qualifier when an agent program no longer submits tasks for processing that run under user names other than the submitting agent program.

/[NO]DISPLAY_MENU

The `/DISPLAY_MENU` qualifier enables the menu display identified in the user's definition and the Selection: prompt once the user signs in. A menu is identified by a menu path name and a menu database file. If a user's definition has the `NODISPLAY_MENU` characteristic, ACMS displays only the Selection: prompt after the user signs in, without a full default menu. The `/NODISPLAY_MENU` qualifier disables the menu display.

/[NO]FINAL=(keyword[,...])

Specifies a task that is run when the user exits from ACMS. If you do not specify the `/[NO]FINAL` qualifier, the default is taken from the current DEFAULT definition.

Specify one or more of the following keywords. If you specify more than one keyword, you must enclose the keywords in parentheses.

- `APPLICATION=application-name`

Specifies the application in which the final task is run. When you specify the **APPLICATION** keyword, you must also specify a task name with the **TASK** keyword.

- **[NO]IGNORE_ERROR**
Specifies that errors in the final task are ignored. If an error occurs in the final task, ACMS does not display an error message or record information about the error in the audit trail log file.
- **[NO]SELECTION_STRING="string"**
Specifies a parameter required by the final task. For example, if the final task is an editor, "string" is the file specification of the file to be edited. Enclose the string in quotation marks.
- **TASK=task-name**
Specifies the name of the final task.

/[NO]INITIAL=(keyword[,...])

Specifies the task that is run when the user enters the ACMS environment. The default is taken from the current **DEFAULT** definition.

Specify one or more of the following keywords. If you specify more than one keyword, you must enclose the keywords in parentheses.

- **APPLICATION=application-name**
Specifies the application in which the initial task is run. When you specify the **APPLICATION** keyword, you must also specify a task name with the **TASK** keyword.
- **[NO]IGNORE_ERROR**
Specifies that errors in the initial task are ignored. By default, if an error occurs in an initial task, an error message is displayed on the user's terminal, the reason for the error is recorded in the audit trail log, and the user is signed out of ACMS.
- **[NO]SELECTION_STRING="string"**
Specifies a parameter required by the initial task. For example, if the initial task is an editor, "string" is the file specification of the file to be edited. Enclose the string in quotation marks.
- **TASK=task-name**
Specifies the name of the initial task.

/LANGUAGE[=language-name]

Assigns a language to a user in a UDU definition. ACMS matches the language assigned to a user with the language assigned to a HP DECforms form layout and displays panels in the selected language. The default is taken from the existing **DEFAULT** definition.

/MDB=menu-database-file

Assigns a menu database file to a UDU definition. A menu database file is a file of run-time menu definitions created by the Application Definition Utility (ADU) **BUILD** command. The ACMS run-time system assumes **ACMS\$DIRECTORY** as the default directory and **.MDB** as the default file type for menu database files in UDU definitions.

DEFAULT

/MENU[=menu-path-name]

Assigns a menu to a UDU definition. The menu path name is the location of a run-time menu definition in a menu database file. Users cannot see menus whose path names are higher in the menu tree than their default menu path names. Path names for all menus except the highest menu consist of strings of menu keywords. If you do not know the path name to include with the /MENU qualifier, you can derive the menu path name from menu keywords, as explained in the *HP ACMS for OpenVMS ADU Reference Manual*.

You can define menu entries that contain slashes in the menu definition; however, you cannot specify menu paths containing these slashes in the UDU.

For example, the following format is *not* allowed:

```
UDU> MODIFY SMITH /MENU="TOP/V32.SUBMENU"
```

If you do not specify a path name and there is no default path name defined in the existing DEFAULT definition, the user receives a blank path name. If a blank path name is defined, the user receives the top menu in the menu database file.

/PRINTFILE=print-file-spec

/PRINTFILE=spooled-device-name

Use this qualifier to specify a file name or spooled device name for a user. When a form is enabled, ACMS uses the Printfile specification for a device assigned in DDU, if it is available. If it is not, ACMS uses the Printfile specification for the user.

To use the Printfile feature, you must also include a PRINT response step in the HP DECforms source IDFL file that contains the specifications of the panel that you want to print.

/[NO]SKIPMENULANGUAGE

Use this qualifier with the /LANGUAGE qualifier to specify that a language is to be assigned to a user for all HP DECforms forms except menu forms. For example, with the /SKIPMENULANGUAGE qualifier you can specify that HP DECforms display all panels in French except menu panels.

Notes

ACMS creates a DEFAULT definition the first time you run UDU, or when you create a new user authorization file. ACMS assigns to the DEFAULT definition an initial display of the top-level menu and selection prompt, the menu database file specification ACMS\$DIRECTORY:ACMS.MDB, and a blank menu path name.

The ADD command is the only command affected by the DEFAULT definition. When you use the ADD command to create a new UDU definition, the new definition takes the default information assigned in the DEFAULT definition. You can use qualifiers with the ADD command to override information from the DEFAULT definition.

Examples

1. UDU> DEFAULT /MENU=EMPLOYEE

This command assigns the default menu EMPLOYEE to the DEFAULT definition.

2. UDU> DEFAULT /MENU

This command assigns a blank menu path name to the DEFAULT definition. The user receives the top menu in the menu database file.

EXIT

EXIT Command (UDU>)

Ends the UDU session and returns you to DCL level.

Format

EXIT

Privileges Required

None

Note

You can also type `Ctrl/Z` to end a UDU session. `Ctrl/Z` signals the end of the file for data entered from the terminal. `Ctrl/Z` is displayed as EXIT.

Example

```
UDU> EXIT
$
```

This command ends a UDU session and returns you to the DCL prompt.

HELP Command (UDU>)

Displays information about UDU commands and qualifiers.

Format

```
HELP [ topic [...] ]
```

Command Qualifier	Default
/[NO]PROMPT	/PROMPT

Privileges Required

None

Parameters

topic

The UDU topic you want information about. If you do not supply a topic, HELP provides you with a list of topics to choose from.

Qualifiers

/[NO]PROMPT

Controls whether or not you receive prompts for topic and subtopic. The /PROMPT qualifier displays help prompts. The default is /PROMPT. With the /NOPROMPT qualifier, the HELP command does not display prompts.

Notes

None

Example

```
UDU> HELP LIST
```

```
LIST
```

```
Writes User Definition Utility definitions to an output file.
```

```
Format:
```

```
LIST user-name
```

```
For example:
```

```
UDU> LIST *
```

```
Additional information available:
```

```
Parameter Qualifiers  
/OUTPUT /BRIEF
```

```
LIST Subtopic?
```

```
Topic?
```

This command displays information about the UDU LIST command.

LIST

LIST Command (UDU>)

Writes UDU definitions to ACMSUDU.LIS in your default directory, or to an output file you specify.

Format

LIST user-name

Command Qualifiers

/BRIEF
/OUTPUT[=file-spec]

Defaults

Full definition
/OUTPUT=ACMSUDU.LIS

Privileges Required

None

Parameters

user-name

The OpenVMS user name of the definition you are listing. You can use the wildcard character (*), \$ALL, or DEFAULT as the user name. You can use the wildcard character to represent a partial user name.

Qualifiers

/BRIEF

Lists only the OpenVMS user names in definitions. The default is to list complete definitions.

/OUTPUT[=file-spec]

Copies one or more user definitions to a file you name. If you do not include a file specification, UDU uses the ACMSUDU.LIS file by default and puts the list file in your current default directory.

Notes

To write all definitions to an output file, use the wildcard character (*) as the user name.

To print the listing file, use the DCL PRINT command after you have finished your UDU session. To display the contents of an output file, use the DCL TYPE command.

Examples

1. UDU> LIST CONNOR

This command writes the definition for CONNOR to the ACMSUDU.LIS output file.

2. UDU> LIST * /BRIEF

This command writes the user names in all UDU definitions to the output file ACMSUDU.LIS.

3. UDU> LIST *

The **LIST** command with the wildcard character (*) writes all definitions in the user authorization file (ACMSUDF.DAT) to the output file ACMSUDU.LIS.

4. UDU> LIST B*

This command uses the wildcard character (*) to write the definitions for user names beginning with the letter B to an output file.

LIST /PROXY

LIST /PROXY Command (UDU>)

Writes all the proxies in the ACMS proxy file to the output file ACMSPROXY.LIS. You can use the /OUTPUT qualifier to specify a different output file name.

Format

LIST /PROXY

Command Qualifier	Default
/OUTPUT=file-spec	ACMSPROXY.LIS

Qualifiers

/OUTPUT=file-spec

Use this qualifier to specify a file name for the output listing file. Replace the parameter <file-spec> with the new output file name, which can be any valid OpenVMS file specification.

By default, the listing file is created in the current directory with the name ACMSPROXY.LIS.

Note

Creates a listing file of all the proxies in the ACMS proxy file. You can use the optional /OUTPUT qualifier to override the default listing file specification.

Examples

1. UDU> LIST /PROXY

This command creates a listing file of all the proxies in the ACMS proxy file. The listing file is created in the current directory and is named ACMSPROXY.LIS.

2. UDU> LIST /PROXY /OUTPUT=DISK1\$: [DATA]ALL_REMOTE_USERS.LIS

This command creates the listing file ALL_REMOTE_USERS.LIS in the DISK1\$: [DATA] directory. The listing file contains all proxies in the ACMS proxy file.

MODIFY Command (UDU>)

Changes the user information by allowing you to change information in UDU definitions.

Format

MODIFY user-name

Command Qualifiers

/[NO]AGENT
 /[NO]DISPLAY_MENU
 /[NO]FINAL=(keyword[,...])
 /[NO]INITIAL=(keyword[,...])
 /LANGUAGE=[language-name]
 /MDB=menu-database-file
 /MENU=[menu-path-name]

/PRINTFILE $\left[\begin{array}{l} = \text{print-file-spec} \\ \text{spooled-device-name} \end{array} \right]$

/[NO]SKIPMENULANGUAGE

Default

From existing definition
 From existing definition
 From existing definition
 From existing definition
 From existing definition
 From existing definition

From existing definition

From existing definition

Privileges Required

None

Parameters

user-name

The OpenVMS user name in the definition you are changing. The user name can be \$ALL.

Qualifiers

/[NO]AGENT

The /AGENT qualifier enables an agent to submit a task that has a user name different from the user name of the agent process. You must use the /AGENT qualifier to authorize the CP and the QTI as agents. If your system has other agent programs that submit tasks of this type, you must also authorize them with the /AGENT qualifier. You must use the /AGENT qualifier for any user name that a detached task runs under. Use the /NOAGENT qualifier when an agent program no longer submits tasks for processing that run under user names other than the submitting agent program. The default is taken from the existing definition.

/[NO]DISPLAY_MENU

The /DISPLAY_MENU qualifier enables the menu display identified in the user's definition and the Selection: prompt once the user signs in. A menu is identified by a menu path name and a menu database file. If a user's definition has the NODISPLAY_MENU characteristic, ACMS displays only the Selection: prompt after the user signs in, without a full default menu. The /NODISPLAY_MENU qualifier disables the menu display. The default is taken from the existing definition.

MODIFY

/[NO]FINAL=(keyword[,...])

Specifies a task that is run when the user exits from ACMS. The default is taken from the existing definition.

You can specify one or more of the following keywords. If you specify more than one keyword, you must enclose the keywords in parentheses.

- **APPLICATION=application-name**
Specifies the application in which the final task is run. When you specify the **APPLICATION** keyword, you must also specify a task name with the **TASK** keyword.
- **[NO]IGNORE_ERROR**
Specifies that errors in the final task are ignored. If an error occurs in the final task, ACMS does not display an error message or record information about the error in the audit trail log file.
- **[NO]SELECTION_STRING="string"**
Specifies a parameter required by the final task. For example, if the final task is an editor, "string" is the file specification of the file to be edited. Enclose the string in quotation marks.
- **TASK=task-name**
Specifies the name of the final task.

/[NO]INITIAL=(keyword[,...])

Specifies the task that is run when the user enters the ACMS environment. The default is taken from the existing definition.

You can specify one or more of the following keywords. If you specify more than one keyword, you must enclose the keywords in parentheses.

- **APPLICATION=application-name**
Specifies the application in which the initial task is run. When you specify the **APPLICATION** keyword, you must also specify a task name with the **TASK** keyword.
- **[NO]IGNORE_ERROR**
Specifies that errors in the initial task are ignored. By default, if an error occurs in an initial task, an error message is displayed on the user's terminal, the reason for the error is recorded in the audit trail log, and the user is signed out of ACMS.
- **[NO]SELECTION_STRING="string"**
Specifies a parameter required by the initial task. For example, if the initial task is an editor, "string" is the file specification of the file to be edited. Enclose the string in quotation marks.
- **TASK=task-name**
Specifies the name of the initial task.

/LANGUAGE[=language-name]

Assigns a language to a user in a UDU definition. ACMS matches the language assigned to a user with the language assigned to a HP DECforms form layout and displays panels in the selected language. The default is taken from the existing definition.

/MDB=menu-database-file

Assigns a menu database file to a UDU definition. A menu database file is a file of run-time menu definitions created by the Application Definition Utility (ADU) BUILD command. The ACMS run-time system assumes ACMS\$DIRECTORY as the default directory and .MDB as the default file type for menu database files in UDU definitions. The default is taken from the existing definition.

/MENU[=menu-path-name]

Assigns a menu to a UDU definition. The menu path name is the location of a run-time menu definition in a menu database file. Users cannot see menus whose path names are higher in the menu tree than their default menu path names. Path names for all menus except the highest menu consist of strings of menu keywords. If you do not know the path name to include with the /MENU qualifier, you can derive the menu path name from menu keywords, as explained in *HP ACMS for OpenVMS ADU Reference Manual*.

You can define menu entries that contain slashes in the menu definition; however, you cannot specify menu paths containing these slashes in the UDU.

For example, the following format is *not* allowed:

```
UDU> MODIFY SMITH /MENU="TOP/V32.SUBMENU"
```

If you do not specify a menu path name, the user receives the path name defined in the existing definition. If there is no path name defined in the existing definition, a blank path name is assigned. When signing in with a blank path name assigned, the user receives the top menu in the menu database file.

/PRINTFILE=print-file-spec**/PRINTFILE=spooled-device-name**

Use this qualifier to specify a file name or spooled device name for a user. When a form is enabled, ACMS uses the Printfile specification for a device assigned in DDU, if it is available. If it is not, ACMS uses the Printfile specification for the user.

To use the Printfile feature, you must also include a PRINT response step in the HP DECforms source IDFL file that contains the specifications of the panel that you want to print.

/[NO]SKIPMENULANGUAGE

Use this qualifier with the /LANGUAGE qualifier to specify that a language is to be assigned to a user for all HP DECforms forms except menu forms. For example, with the /SKIPMENULANGUAGE qualifier you can specify that HP DECforms display all panels in French except menu panels.

Notes

To change the \$ALL definition, use \$ALL as the user name.

The UDU MODIFY command does not invoke an editor, unlike the MODIFY command of the ACMS Application Definition Utility (ADU).

Examples

```
1. UDU> MODIFY CONNOR /MENU=PERSONNEL
```

This command assigns CONNOR the menu path name PERSONNEL, a menu below the highest menu in the menu database file.

MODIFY

2. UDU> MODIFY CONNOR /MDB=WORKDISK\$:[CONNOR]ACMS.MDB

This command assigns CONNOR the menu database file ACMS.MDB on WORKDISK\$:[CONNOR].

3. UDU> MODIFY ZEKE /INITIAL=(TASK=NEW_DATA_INFO)

This command modifies the definition for ZEKE specifying NEW_DATA_INFO as the new initial task. The name of the application is taken from the existing definition.

4. UDU> MODIFY WINSTON /PRINTFILE=SPOOLDEV::TXA0:

This command modifies the definition for WINSTON specifying SPOOLDEV::TXA0: as the spooled device on which any HP DECforms print files are to be printed.

REMOVE Command (UDU>)

Removes UDU definitions from the user authorization file.

Format

REMOVE user-name

Privileges Required

None

Parameters

user-name

The OpenVMS user name in the definition you are deleting. The user name can be \$ALL.

Notes

To prevent a user from signing in to ACMS, remove the \$ALL definition if the database contains one, or remove the definition for the user.

You cannot delete the DEFAULT definition.

Examples

1. UDU> REMOVE CONNOR

This command deletes the user definition for CONNOR.

2. UDU> REMOVE \$ALL

This command deletes the \$ALL definition.

REMOVE /PROXY

REMOVE /PROXY Command (UDU>)

Removes the specified proxy from the ACMS proxy file (ACMSPROXY.DAT).

Format

```
REMOVE /PROXY remote-node::remote-user
```

Parameters

remote-node

Specifies a remote node name (1 to 6 alphanumeric characters). Specify an asterisk to remove a proxy that contains an asterisk for the remote node.

remote-user

Specifies the user name of a user at a remote node. A valid remote user name is a string of 1 to 12 alphanumeric characters and can contain underscores and dollar signs. Specify an asterisk to remove a proxy containing an asterisk for the remote user.

Notes

When you remove a proxy, UDU interprets the <remote-node>::<remote-user> and <local-user> parameters as text strings and removes the proxy as specified, including any asterisks. Specifying an asterisk for a parameter removes only a proxy that has an asterisk for that same parameter.

You cannot partially wildcard any parameters with the REMOVE /PROXY command. For example, if a user specifies <remote-node>::<remote-user> as COMET::PERS*, UDU returns the error message, "Invalid remote user proxy specification."

If the specified user is not in the file, UDU displays an error message stating that the user does not exist.

Examples

```
1. UDU> SHOW /PROXY *:*
Remote User: *::BICKFORD           Local User: BICKFORD
Remote User: COMET:*              Local User: RENTAL_AGENT
Remote User: COMET::BICKFORD      Local User: SUPERVISOR
Remote User: COMET::PERSONNEL     Local User: PERSONNEL
UDU> REMOVE /PROXY COMET::PERSONNEL
UDU> SHOW /PROXY *:*
Remote User: *::BICKFORD           Local User: BICKFORD
Remote User: COMET:*              Local User: RENTAL_AGENT
Remote User: COMET::BICKFORD      Local User: SUPERVISOR
```

In this example, the REMOVE command removes the proxy for COMET::PERSONNEL from the ACMS proxy file. This deletion removes the specific ACMS proxy access for user PERSONNEL on node COMET.

REMOVE /PROXY

2. UDU> SHOW /PROXY *

```
Remote User: *::BICKFORD           Local User: BICKFORD
Remote User: COMET::*             Local User: RENTAL_AGENT
Remote User: COMET::BICKFORD      Local User: SUPERVISOR
UDU> REMOVE /PROXY COMET::*
UDU> SHOW /PROXY *
```

```
Remote User: *::BICKFORD           Local User: BICKFORD
Remote User: COMET::BICKFORD      Local User: SUPERVISOR
```

In this example, the REMOVE command removes the proxy for COMET::*. This deletion removes ACMS proxy access for all users on node COMET except for the user name BICKFORD, who has a separate proxy. The proxy for *::BICKFORD is not removed, because the proxy is interpreted as a separate entity.

3. UDU> SHOW /PROXY *

```
Remote User: *::BICKFORD           Local User: BICKFORD
Remote User: COMET::BICKFORD      Local User: SUPERVISOR
UDU> REMOVE /PROXY *::BICKFORD
UDU> SHOW /PROXY *
```

```
Remote User: COMET::BICKFORD      Local User: SUPERVISOR
```

In this example, the REMOVE command removes the proxy for *::BICKFORD. This deletion removes ACMS proxy access for user BICKFORD on every node except COMET::BICKFORD, which is interpreted as a separate entity.

RENAME

RENAME Command (UDU>)

Changes the user names and, with qualifiers, other information in UDU definitions.

Format

RENAME old-user-name new-user-name

Command Qualifiers	Default
/[NO]AGENT	From old definition
/[NO]DISPLAY_MENU	From old definition
/[NO]FINAL=(keyword[,...])	From old definition
/[NO]INITIAL=(keyword[,...])	From old definition
/LANGUAGE=[language-name]	From old definition
/MDB=menu-database-file	From old definition
/MENU=[menu-path-name]	From old definition
/PRINTFILE $\left[\begin{array}{l} = \text{print-file-spec} \\ \text{spooled-device-name} \end{array} \right]$	From old definition
/[NO]SKIPMENULANGUAGE	From old definition

Privileges Required

None

Parameters

old-user-name

The OpenVMS user name in the definition you are changing. The old user name can be \$ALL.

new-user-name

The OpenVMS user name for the new definition. The new user name can be \$ALL.

Qualifiers

/[NO]AGENT

The /AGENT qualifier enables an agent to submit a task that has a user name different from the user name of the agent process. You must use the /AGENT qualifier to authorize the CP and the QTI as agents. If your system has other agent programs that submit tasks of this type, you must also authorize them with the /AGENT qualifier. You must use the /AGENT qualifier for any user name that a detached task runs under. Use the /NOAGENT qualifier when an agent program no longer submits tasks for processing that run under user names other than the submitting agent program. The default is whatever is defined in the definition you are renaming.

/[NO]DISPLAY_MENU

The /DISPLAY_MENU qualifier enables the menu display identified in the user's definition and the Selection: prompt once the user signs in. A menu is identified by a menu path name and a menu database file. If a user's definition has the NODISPLAY_MENU characteristic, ACMS displays only the Selection: prompt after the user signs in, without a full default menu. The /NODISPLAY_MENU

qualifier disables the menu display. The default is whatever is defined in the definition you are renaming.

/[NO]FINAL=(keyword[,...])

Specifies a task that is run when the user exits from ACMS. If you do not specify the /[NO]FINAL qualifier, the default is taken from the definition you are renaming.

You can specify one or more of the following keywords. If you specify more than one keyword, you must enclose the keywords in parentheses.

- **APPLICATION=application-name**
Specifies the application in which the final task is run. When you specify the APPLICATION keyword, you must also specify a task name with the TASK keyword.
- **[NO]IGNORE_ERROR**
Specifies that errors in the final task are ignored. If an error occurs in the final task, ACMS does not display an error message or record information about the error in the audit trail log file.
- **[NO]SELECTION_STRING="string"**
Specifies a parameter required by the final task. For example, if the final task is an editor, "string" is the file specification of the file to be edited. Enclose the string in quotation marks.
- **TASK=task-name**
Specifies the name of the final task.

/[NO]INITIAL=(keyword[,...])

Specifies a task that is run when the user enters the ACMS environment. The default is taken from the definition you are renaming.

You can specify one or more of the following keywords. If you specify more than one keyword, you must enclose the keywords in parentheses.

- **APPLICATION=application-name**
Specifies the application in which the initial task is run. When you specify the APPLICATION keyword, you must also specify a task name with the TASK keyword.
- **[NO]IGNORE_ERROR**
Specifies that errors in the initial task are ignored. By default, if an error occurs in an initial task, an error message is displayed on the user's terminal, the reason for the error is recorded in the audit trail log, and the user is signed out of ACMS.
- **[NO]SELECTION_STRING="string"**
Specifies a parameter required by the initial task. For example, if the initial task is an editor, "string" is the file specification of the file to be edited. Enclose the string in quotation marks.
- **TASK=task-name**
Specifies the name of the initial task.

RENAME

/LANGUAGE[=*language-name*]

Assigns a language to a user in a UDU definition. ACMS matches the language assigned to a user with the language assigned to a HP DECforms form layout and displays panels in the selected language. The default is taken from the definition you are renaming.

/MDB=*menu-database-file*

Assigns a menu database file to a UDU definition. A menu database file is a file of run-time menu definitions created by the ADU BUILD command. The ACMS run-time system assumes ACMS\$DIRECTORY as the default directory and .MDB as the default file type for menu database files in UDU definitions. The default is whatever is defined in the definition you are renaming.

/MENU[=*menu-path-name*]

Assigns a menu to a UDU definition. The menu path name is the location of a run-time menu definition in a menu database file. Users cannot see menus whose path names are higher in the menu tree than their default menu path names. Path names for all menus except the highest menu consist of strings of menu keywords. If you do not know the path name to include with the /MENU qualifier, you can derive the menu path name from menu keywords, as explained in the *HP ACMS for OpenVMS ADU Reference Manual*.

You can define menu entries that contain slashes in the menu definition, however, you cannot specify menu paths containing these slashes in the UDU.

For example, the following format is *not* allowed:

```
UDU> MODIFY SMITH /MENU="TOP/V32.SUBMENU"
```

If you do not specify a menu path name, UDU uses the path name defined in the definition you are renaming. If there is no path name already defined, the user receives a blank path name. When a blank path name is defined, the user receives the top menu in the menu database file when signing in.

/PRINTFILE=*print-file-spec*

/PRINTFILE=*spooled-device-name*

Use this qualifier to specify a file name or spooled device name for a user. When a form is enabled, ACMS uses the Printfile specification for a device assigned in DDU, if it is available. If it is not, ACMS uses the Printfile specification for the user.

To use the Printfile feature, you must also include a PRINT response step in the HP DECforms source IDFL file that contains the specifications of the panel that you want to print.

/[NO]SKIPMENULANGUAGE

Use this qualifier with the /LANGUAGE qualifier to specify that a language is to be assigned to a user for all HP DECforms forms except menu forms. For example, with the /SKIPMENULANGUAGE qualifier you can specify that HP DECforms display all panels in French except menu panels.

Notes

The new user name must be unique in the user authorization file. You cannot rename the DEFAULT definition.

Examples

1. UDU> RENAME SMITH JAMISON

This command changes the user name from SMITH to JAMISON.

2. UDU> RENAME SMITH JAMES /MENU=PERSONNEL

This command changes the user name from SMITH to JAMES and changes the default menu path name in the definition to PERSONNEL.

SHOW

SHOW Command (UDU>)

Displays UDU definitions.

Format

SHOW user-name

Command Qualifier	Default
/BRIEF	Full definition

Privileges Required

None

Parameters

user-name

The OpenVMS user name of the definition you are displaying. Use the wildcard character (*), \$ALL, or DEFAULT as the user name. Use the wildcard character to represent a partial user name.

Qualifiers

/BRIEF

Displays only the user names in definitions. The default is to display full definitions.

Notes

To display all definitions, use the wildcard character (*) as the parameter.

Examples

```
1. UDU> SHOW *
User Spec:      *
User Name:      DEFAULT          DISPLAY MENU
Default Menu:
Default MDB:    ACMS$DIRECTORY:ACMS.MDB
Initial Task:
  Application:
  Task:
  Selection:
Final Task:
  Application:
  Task:
  Selection:
Language:
Printfile:
```

```

User Name:      $ALL              DISPLAY MENU
Default Menu:
Default MDB:    ACMS$DIRECTORY:ACMS.MDB
Initial Task:
  Application:
  Task:
  Selection:
Final Task:
  Application:
  Task:
  Selection:

Language:
Printfile:

```

The **SHOW** command with the wildcard character (*) displays all definitions in the user authorization file (ACMSUDEF.DAT).

```

2. UDU> SHOW * /BRIEF
User Spec:      *
User Name:      $ALL
User Name:      DEFAULT
User Name:      CONNOR

User Name:      WINSTON

```

The **SHOW/BRIEF** command with the wildcard character (*) displays all user names in UDU definitions.

```

3. UDU> SHOW CONNOR
User Name:      CONNOR              DISPLAY MENU
Default Menu:   EMPLOYEE
Default MDB:    ACMS$DIRECTORY:ACMS.MDB
Initial Task:   IGNORE ERROR
  Application:  EMP_ACCT
  Task:         REGISTRY
  Selection:    LOG_IN.DAT
Final Task:     IGNORE ERROR
  Application:  EMP_ACCT
  Task:         DAILY_LOG
  Selection:    DAYS_WORK.DAT

Language:       ENGLISH
Printfile:      SPOOLDEV::TXA0:

```

The **SHOW** command displays the definition for CONNOR.

SHOW /PROXY

SHOW /PROXY Command (UDU>)

Displays one or more proxies in the ACMS proxy file (ACMSPROXY.DAT).

Format

```
SHOW /PROXY remote-node::remote-user
```

Parameters

remote-node

Specifies a remote node name (1 to 6 alphanumeric characters).

remote-user

Specifies the user name of a user at a remote node. A valid user name is a string of 1 to 12 alphanumeric characters and can contain underscores and dollar signs.

Notes

The SHOW /PROXY command interprets the asterisk as a wildcard character. To display the proxy access for all users in the proxy file, specify either a single asterisk (*) or *::* for <remote-node>::<remote-user>. If you use an asterisk for <remote-node>, all user proxies that match the <remote-user> specification are displayed. If you use an asterisk for <remote-user>, all proxies for users on the specified <remote-node> are displayed.

You can also use the wildcard character with the SHOW /PROXY command to represent a partial user proxy. You can use the asterisk as a prefix (for example, *FORD), as a suffix (for example, BICK*), or as both (for example, *CKFOR*).

Examples

1. UDU> SHOW /PROXY *::*

```
Remote User: *::BICKFORD           Local User: BICKFORD
Remote User: COMET::BICKFORD       Local User: SUPERVISOR
Remote User: COMET::BROWN          Local User: BROWN
Remote User: COMET::PERSONNEL      Local User: PERS_USER
Remote User: BRICK::*              Local User: RENTAL_AGENT
```

This command displays all proxies in the ACMS proxy file. Note that the command SHOW /PROXY * displays the same output.

2. UDU> SHOW /PROXY COMET::PERSONNEL

```
Remote User: COMET::PERSONNEL      Local User: PERS_USER
```

This command displays a single proxy.

3. UDU> SHOW /PROXY *::BICKFORD

```
Remote User: *::BICKFORD           Local User: BICKFORD
Remote User: COMET::BICKFORD       Local User: BICKFORD
```

This command displays proxies using a wildcard for the remote node.

4. UDU> SHOW /PROXY COMET::*

Remote User: COMET::BICKFORD	Local User: SUPERVISOR
Remote User: COMET::BROWN	Local User: BROWN
Remote User: COMET::PERSONNEL	Local User: PERS_USER

This command displays proxies using a wildcard for the remote user.

5. UDU> SHOW /PROXY COMET::B*

Remote User: COMET::BICKFORD	Local User: SUPERVISOR
Remote User: COMET::BROWN	Local User: BROWN

This command displays proxies using partial wildcarding for the remote user.

AAU Commands

This chapter contains reference information and examples for the ACMS Application Authorization Utility (AAU) commands. See Chapter 4 for general information on AAU.

ADD

ADD Command (AAU>)

Authorizes one or more application names for installation in ACMS\$DIRECTORY.

Format

ADD application-name

Command Qualifiers

/ACL=(access-control-list[,...])
/APPL_USERNAME=user-name
/[NO]DYNAMIC_USERNAMES
/SRV_USERNAMES[(server-user-name[,...])]
/[NO]WILD_SUFFIX

Default

From DEFAULT definition
From DEFAULT definition
From DEFAULT definition
From DEFAULT definition
From DEFAULT definition

Privileges Required

None

Parameters

application-name

The name of the application you want to authorize. The name can be \$ALL or a valid RMS file name of up to 39 characters.

Qualifiers

/ACL=(access-control-list[,...])

The /ACL qualifier authorizes a user to install an application database file in ACMS\$DIRECTORY. When a user enters the ACMS/INSTALL command, ACMS checks the AAU authorization to confirm that the Access Control List (ACL) entries used with the /ACL qualifier include that user name. If the user is not authorized, the ACMS/INSTALL command does not install the application.

The Access Control List identifies who can and who cannot install an application. The access control entries for the AAU follow the same format used for OpenVMS except for these restrictions:

- Only the keyword IDENTIFIER is valid.
- ACE options are not supported.
- Access-allowed-mask uses the ACCESS keyword followed by either the access action CONTROL or NONE.
- Protection masks are not supported.

With these restrictions in mind, the general format for specifying an Access Control List is as follows:

```
/ACL=((IDENTIFIER=identifier[...],[ACCESS=access-action])[,...])
```

For example:

```
AAU> ADD PERSONNEL EMPLOYEE /ACL=(IDENTIFIER=[PAYUP,JONES], -  
_AAU> ACCESS=CONTROL)
```

Each time you specify an identifier and optionally an access action code, you describe one access control entry. You can, however, specify a string of access control entries, separated by commas, as indicated by the ellipsis [...]. Together, access control entries constitute the Access Control List for a particular application.

Refer to *OpenVMS DCL Dictionary* for more information about Access Control Lists and entries.

/APPL_USERNAME=user-name

Identifies the user name of an application. The ACMS/INSTALL command does not install the application database file in ACMS\$DIRECTORY unless the application user name in the application matches the one you specify with the /APPL_USERNAME qualifier. If you specify the wildcard character (*) instead of a user name, the wildcard user name automatically matches any user name specified in the application the user tries to install.

By default, AAU uses the setting assigned in the DEFAULT authorization. AAU assigns the default setting /APPL_USERNAME=* when the ACMSAAF.DAT file is first created.

/[NO]DYNAMIC_USERNAMES

Allows a user to install an application database file if the setting you assign with the /[NO]DYNAMIC_USERNAMES qualifier matches that in the application. For example, if you do not want an application installed that allows servers to use dynamic user names or "USERNAME OF SUBMITTER", use the /NODYNAMIC_USERNAMES qualifier. If you want an application installed that allows servers to use dynamic user names, use the /DYNAMIC_USERNAMES qualifier.

By default, AAU uses the setting assigned in the DEFAULT authorization. AAU assigns /NODYNAMIC_USERNAMES as the default setting when the ACMSAAF.DAT file is first created.

/SRV_USERNAMES[=(server-user-name[,...])]

Specifies one or more server user names that are associated with the application you are authorizing. The ACMS/INSTALL command installs an application if the server user names that you specify with the /SRV_USERNAMES qualifier match those in the application database file. If you specify the wildcard character (*) for a server user name, the wildcard user name automatically matches all server user names specified in the application.

If you do not want to authorize any server user names, include the /SRV_USERNAMES qualifier without any specifiers. For example:

```
AAU> ADD INVESTMENT /SRV_USERNAMES
```

By default, AAU uses the setting assigned in the DEFAULT authorization. AAU assigns the default setting /SRV_USERNAMES=* when the ACMSAAF.DAT file is first created.

/[NO]WILD_SUFFIX

Allows a user to install or prevents a user from installing any application whose name begins with the letters of the application name you are authorizing. For example, the following command allows the user with UIC [PERSONNEL,RICHARD] to install any application name that starts with the letters INVAPPL:

ADD

```
AAU> ADD INVAPPL /ACL=(IDENTIFIER=[PERSONNEL,RICHARD], -  
_AAU> ACCESS=CONTROL) /WILD_SUFFIX
```

Once this command is in effect, user [PERSONNEL,RICHARD] can install applications with names such as INVAPPL, INVAPPL1, and INVAPPL2.

By default, AAU uses the setting assigned in the DEFAULT authorization. AAU assigns the default setting /NOWILD_SUFFIX when the ACMSAAF.DAT file is first created.

Notes

To create an authorization for a single application, use the RMS name of that application as the application name. To create an authorization for all applications, use the keyword \$ALL as the application name.

AAU then stores the authorizations you create in the ACMSAAF.DAT file in your default directory. When a user enters the ACMS/INSTALL operator command to install an application database file, however, ACMS looks for the ACMSAAF.DAT file in SYS\$SYSTEM. If you choose to locate ACMSAAF.DAT in a directory other than SYS\$SYSTEM, you must define an EXEC mode logical, ACMSAAF, to point to that directory.

Examples

1. AAU> ADD PERSONNEL

This command authorizes the application named PERSONNEL to be installed in ACMS\$DIRECTORY. Because the command has no qualifiers, the new authorization receives information from the DEFAULT authorization.

2. AAU> ADD \$ALL

This command creates a \$ALL authorization that lets any authorized user install any application. The \$ALL authorization receives from the DEFAULT authorization any information you do not include with qualifiers.

3. AAU> ADD EMPLOYEE /APPL_USERNAME=GORDON

This command authorizes the application named EMPLOYEE and includes the application user name GORDON. The application database file for EMPLOYEE cannot be installed unless it has the application user name of GORDON. The rest of the information for the authorization comes from the DEFAULT authorization.

COPY Command (AAU>)

Makes a copy of an existing authorization.

Format

COPY source-application-name new-application-name

Command Qualifiers

/ACL=(access-control-list[,...])
/APPL_USERNAME=user-name
/[NO]DYNAMIC_USERNAMES
/SRV_USERNAMES[(server-user-name[,...])]
/[NO]WILD_SUFFIX

Default

From source authorization
From source authorization
From source authorization
From source authorization
From source authorization

Privileges Required

None

Parameters

source-application-name

The name of the application whose authorization you want to copy. It can be a valid file name of up to 39 characters, \$ALL, or DEFAULT.

new-application-name

The application name you give to the new version of the source authorization. It can be a valid RMS file name or \$ALL.

Qualifiers

/ACL=(access-control-list[,...])

The /ACL qualifier authorizes a user to install an application database file in ACMS\$DIRECTORY. The Access Control List identifies who can and who cannot install an application. See the description of the /ACL qualifier under the ADD command for more information about the /ACL qualifier and rules for specifying Access Control Lists.

/APPL_USERNAME=user-name

Identifies the user name of an application. The ACMS/INSTALL command does not install the application database file in ACMS\$DIRECTORY unless the application user name in the application database file matches the one you specify with the /APPL_USERNAME qualifier. If you specify the wildcard character (*) instead of a user name, the wildcard user name automatically matches any user name specified in the application that a user tries to install.

By default, AAU uses the setting assigned in the DEFAULT authorization. AAU assigns the default setting /APPL_USERNAME=* when the ACMSAAF.DAT file is first created.

/[NO]DYNAMIC_USERNAMES

Allows a user to install an application database file if the setting you assign with the /[NO]DYNAMIC_USERNAMES qualifier matches that in the application. For example, if you do not want an application installed that allows servers to use dynamic user names or "USERNAME OF SUBMITTER", use the /NODYNAMIC_

COPY

USERNAMES qualifier. If you want an application installed that allows servers to use dynamic user names, use the /DYNAMIC_USERNAMES qualifier.

By default, AAU uses the setting assigned in the DEFAULT authorization. AAU assigns /NODYNAMIC_USERNAMES as the default setting when the ACMSAAF.DAT file is first created.

/SRV_USERNAMES[=(server-user-name[,...])]

Specifies one or more server user names that are associated with the application you are authorizing. The ACMS/INSTALL command installs an application if the server user names that you specify with the /SRV_USERNAMES qualifier match those in the application database file. If you specify the wildcard character (*) for a server user name, the wildcard user name automatically matches all server user names specified in the application.

If you do not want to authorize any server user names, include the /SRV_USERNAMES qualifier without any specifiers. For example:

```
AAU> COPY INVESTMENT /SRV_USERNAMES
```

By default, AAU uses the setting assigned in the DEFAULT authorization. AAU assigns the default setting /SRV_USERNAMES=* when the ACMSAAF.DAT file is first created.

/[NO]WILD_SUFFIX

Allows a user to install or prevents a user from installing any application whose name begins with the letters of the application name you are authorizing. For example, the following command allows the user with UIC [PERSONNEL,RICHARD] to copy any application name that starts with the letters INVAPPL:

```
AAU> COPY INVAPPL /ACL=(IDENTIFIER=[PERSONNEL,RICHARD], -  
_AAU> ACCESS=CONTROL)/WILD_SUFFIX
```

Once this command is in effect, user [PERSONNEL,RICHARD] can install applications with names such as INVAPPL, INVAPPL1, and INVAPPL2.

By default, AAU uses the setting assigned in the DEFAULT authorization. AAU assigns the default setting /NOWILD_SUFFIX when the ACMSAAF.DAT file is first created.

Notes

None

Examples

1. AAU> COPY PERSONNEL EMPLOYEE

This command creates the EMPLOYEE authorization, copying all information from the PERSONNEL authorization.

2. AAU> COPY PERSONNEL EMPLOYEE /SRV_USERNAMES=EMPLOYEE_SRV

This command creates the EMPLOYEE authorization, copying information from the PERSONNEL authorization. The /SRV_USERNAMES qualifier assigns the EMPLOYEE_SRV server user name to the EMPLOYEE application authorization.

3. AAU> COPY PERSONNEL EMPLOYEE /APPL_USERNAME=ACCOUNT

This command creates a new authorization with the name **EMPLOYEE**, copying information from the authorization for **PERSONNEL**. The **/APPL_USERNAME** qualifier overrides the application user name from the source authorization, so the authorization for **EMPLOYEE** receives an application user name of **ACCOUNT**.

4. AAU> COPY PERSONNEL EMPLOYEE-
AAU>_ /ACL=(IDENTIFIER=[PAYUP,JONES], ACCESS=CONTROL)

This command makes a copy of the **PERSONNEL** authorization and names it **EMPLOYEE**. The **/ACL** qualifier gives the new **EMPLOYEE** authorization a new access control entry.

DEFAULT

DEFAULT Command (AAU>)

Changes information in the DEFAULT authorization.

Format

DEFAULT

Command Qualifiers

/ACL=(access-control-list[,...])
/APPL_USERNAME=user-name
/[NO]DYNAMIC_USERNAMES
/SRV_USERNAMES[(server-user-name[,...])]
/[NO]WILD_SUFFIX

Default

From existing authorization
From existing authorization
From existing authorization
From existing authorization
From existing authorization

Privileges Required

None

Qualifiers

/ACL=(access-control-list[,...])

The **/ACL** qualifier authorizes a user to install an application database file in **ACMS\$DIRECTORY**. The Access Control List identifies who can and who cannot install an application. See the description of the **/ACL** qualifier under the **ADD** command for more information about the **/ACL** qualifier and rules for specifying Access Control Lists.

/APPL_USERNAME=user-name

Identifies the default user name of an application in the application authorization file. The **ACMS/INSTALL** command does not install the application database file in **ACMS\$DIRECTORY** unless the application user name in the application database file matches the one you specify with the **/APPL_USERNAME** qualifier, either in the default definition, or through the **AAU ADD** or other commands. If you specify the wildcard character (*) instead of a user name, the wildcard user name automatically matches any user name specified in the application that a user tries to install.

By default, **AAU** uses the setting assigned in the **DEFAULT** authorization. **AAU** assigns the default setting **/APPL_USERNAME=*** when the **ACMSAAF.DAT** file is first created.

/[NO]DYNAMIC_USERNAMES

Allows a user to install an application database file if the setting you assign with the **/[NO]DYNAMIC_USERNAMES** qualifier matches the setting in the application. For example, if you do not want an application installed that allows servers to use dynamic user names or "USERNAME OF SUBMITTER", use the **/NODYNAMIC_USERNAMES** qualifier. If you want an application installed that allows servers to use dynamic user names, use the **/DYNAMIC_USERNAMES** qualifier.

By default, **AAU** uses the setting assigned in the **DEFAULT** authorization. **AAU** assigns **/NODYNAMIC_USERNAMES** as the default setting when the **ACMSAAF.DAT** file is first created.

/SRV_USERNAMES[=(server-user-name[,...])]

Specifies one or more server user names that are associated with the default application authorization. The ACMS/INSTALL command installs an application using the default server user names unless otherwise specified in the specific application authorization with the /SRV_USERNAMES. The server names specified, whether by default or not, must match those in the application database file. If you specify the wildcard character (*) for a server user name, the wildcard user name automatically matches all server user names specified in the application.

If you do not want to authorize any default server user names, include the /SRV_USERNAMES qualifier without any specifiers. For example:

```
AAU> DEFAULT/SRV_USERNAMES
```

By default, AAU uses the setting assigned in the DEFAULT authorization. AAU assigns the default setting /SRV_USERNAMES=* when the ACMSAAF.DAT file is first created.

/[NO]WILD_SUFFIX

Sets the wildcard attribute for the default authorization record. The /[NO]WILD_SUFFIX allows a user to install or prevents a user from installing any application whose name begins with the letters of the application name you are authorizing. For example, the following command allows the user with UIC [PERSONNEL,RICHARD] to install by default any application with wildcards, unless otherwise specified by particular application authorizations.

```
AAU> DEFAULT/ACL=(IDENTIFIER=[PERSONNEL,RICHARD], -
_AAU> ACCESS=CONTROL)WILD_SUFFIX
```

Once this command is in effect, user [PERSONNEL,RICHARD] can install applications with names such as INVAPPL, INVAPPL1, and INVAPPL2.

By default, AAU uses the setting assigned in the DEFAULT authorization. AAU assigns the default setting /NOWILD_SUFFIX when the ACMSAAF.DAT file is first created.

Notes

The ADD command is the only command affected by the DEFAULT authorization. When you use the ADD command to create a new authorization, the new authorization takes the default information assigned in the DEFAULT authorization. Use qualifiers with the ADD command to override information from the DEFAULT authorization.

When you use the DEFAULT command, you do not need to include DEFAULT as the application name.

AAU creates the ACMSAAF.DAT file and a DEFAULT authorization when you first run AAU.

If you omit one or more qualifiers from the DEFAULT command, the new DEFAULT authorization retains the information that already exists.

Both the DEFAULT and the MODIFY commands let you modify the DEFAULT authorization. The DEFAULT command, however, lets you change the DEFAULT authorization only. The MODIFY command serves a more general use and lets you modify any authorization in the ACMSAAF.DAT database file.

DEFAULT

The changes made with the DEFAULT command remain in effect until you modify the DEFAULT authorization again. The original settings assigned to the DEFAULT authorization are not restored at the end of the AAU session.

Examples

1. AAU> DEFAULT /APPL_USERNAME=EMPLOYEE /WILD_SUFFIX

This DEFAULT command assigns the application user name EMPLOYEE and the wildcard characteristic to the DEFAULT authorization. Any time you add an authorization and do not specify either of these characteristics, the ADD command includes the application user name and the wildcard characteristics you have assigned in this DEFAULT authorization to the new authorization.

2. AAU> DEFAULT/ACL=(IDENTIFIER=[PAYUP,*], ACCESS=CONTROL)

This command replaces the previously assigned access control entries with UIC [PAYUP,*], ACCESS=CONTROL.

EXIT Command (AAU>)

Ends an AAU session and returns you to the DCL prompt.

Format

EXIT

Privileges Required

None

Note

You can also end an AAU session by pressing `Ctrl/Z`. `Ctrl/Z` signals the end of the file for data entered from the terminal. `Ctrl/Z` is displayed as EXIT.

Example

```
AAU> EXIT
$
```

The EXIT command stops AAU and returns you to the DCL prompt.

HELP

HELP Command (AAU>)

Displays information about AAU commands and qualifiers.

Format

HELP [topic [...]]

Command Qualifier	Default
/[NO]PROMPT	/PROMPT

Privileges Required

None

Parameters

topic

The AAU command or qualifier you want information about. If you do not specify a topic, AAU help provides you with a list of topics to choose from.

Qualifiers

/[NO]PROMPT

Controls whether or not you receive prompts for topics and subtopics. The /PROMPT qualifier displays help prompts and is the default. With the /NOPROMPT qualifier, the HELP command does not display prompts.

Notes

None

Example

```
AAU> HELP ADD
```

```
ADD
```

Adds an authorization record to the application authorization database file ACMSAAF.DAT. This authorizes one for more users to install an application database file in ACMS\$DIRECTORY.

Format:

```
ADD application-name [/qualifiers]
```

For example:

```
AAU> ADD PERSONNEL /APPL_USERNAME=FIDDLE
```

You can use qualifiers to assign authorization characteristics or let new authorizations automatically receive information from the DEFAULT authorization.

To create an authorization for a single application, use the name of that application as the application name. To create an authorization for all applications, use the keyword \$ALL as the application name.

Additional information available:

Parameter Qualifiers

ADD Subtopic?

This command displays help information about the ADD command.

LIST

LIST Command (AAU>)

Writes the contents of an authorization to ACMSAAU.LIS in your default directory or to an output file you specify.

Format

LIST application-name

Command Qualifiers

/BRIEF

/OUTPUT=[file-spec]

Defaults

Full authorizations

/OUTPUT=ACMSAAU.LIS

Privileges Required

None

Parameters

application-name

The name of the application you want to list. The name can be \$ALL, DEFAULT, the wildcard character (*), or a valid RMS file name of up to 39 characters. Use the wildcard character (*) as a prefix, as a suffix, or as a combination of prefix and suffix.

Qualifiers

/BRIEF

Lists only the application authorization names. The default is to list the complete authorizations.

/OUTPUT=[file-spec]

Copies one or more application authorizations to a file you name. If you do not include a file specification, AAU uses the ACMSAAU.LIS file by default and puts the list file in your current default directory.

Notes

To write all definitions to an output file, use the wildcard character (*) as the user name. To print a listing file, use the DCL PRINT command after you have finished your AAU session. To display the contents of an output file on the terminal, use the DCL TYPE command.

Examples

1. AAU> LIST PERSONNEL *

This command writes to an output file all information contained in the PERSONNEL authorization.

2. AAU> LIST * /BRIEF

This command writes to an output file a list of all authorized application names only.

3. AAU> LIST *

This command writes all authorizations in the ACMSAAF.DAT authorization database file to the ACMSAAU.LIS file in your default directory.

4. AAU> LIST B*

This command writes the authorizations for all application names beginning with the letter B to an output file.

MODIFY

MODIFY Command (AAU>)

Changes information in an application authorization.

Format

MODIFY application-name

Command Qualifiers

/ACL=(access-control-list[,...])
/APPL_USERNAME=user-name
/[NO]DYNAMIC_USERNAMES
/SRV_USERNAMES[(server-user-name[,...])]
/[NO]WILD_SUFFIX

Default

From existing authorization
From existing authorization
From existing authorization
From existing authorization
From existing authorization

Privileges Required

None

Parameters

application-name

The application name for the authorization you are changing. The name can be a valid RMS file name of up to 39 characters, \$ALL, or DEFAULT. Use the wildcard character (*) as a prefix, as a suffix, or as both.

Qualifiers

/ACL=(access-control-list[,...])

The /ACL qualifier authorizes a user to install an application database file in ACMS\$DIRECTORY. The Access Control List identifies who can and who cannot install an application. See the description of the /ACL qualifier under the ADD command for more information about the /ACL qualifier and rules for specifying Access Control Lists.

/APPL_USERNAME=user-name

Identifies the user name of an application. The ACMS/INSTALL command does not install the application database file in ACMS\$DIRECTORY unless the application user name in the application database file matches the one you specify with the /APPL_USERNAME qualifier. If you specify the wildcard character (*) instead of a user name, the wildcard user name automatically matches any user name specified in the application that a user tries to install.

By default, AAU uses the setting assigned in the DEFAULT authorization. AAU assigns the default setting /APPL_USERNAME=* when the ACMSAAF.DAT file is first created.

/[NO]DYNAMIC_USERNAMES

Allows a user to install an application database file if the setting you assign with the /[NO]DYNAMIC_USERNAMES qualifier matches that in the application. For example, if you do not want an application installed that allows servers to use dynamic user names or "USERNAME OF SUBMITTER", use the /NODYNAMIC_USERNAMES qualifier. If you want an application installed that allows servers to use dynamic user names, use the /DYNAMIC_USERNAMES qualifier.

By default, AAU uses the setting assigned in the DEFAULT authorization. AAU assigns /NODYNAMIC_USERNAMES as the default setting when the ACMSAAF.DAT file is first created.

/SRV_USERNAMES[=(server-user-name[,...])]

Specifies one or more server user names that are associated with the application you are authorizing. The ACMS/INSTALL command installs an application if the server user names that you specify with the /SRV_USERNAMES qualifier match those in the application database file. If you specify the wildcard character (*) for a server user name, the wildcard user name automatically matches all server user names specified in the application.

If you do not want to authorize any server user names, include the /SRV_USERNAMES qualifier without any specifiers. For example:

```
AAU> MODIFY INVESTMENT /SRV_USERNAMES
```

By default, AAU uses the setting assigned in the DEFAULT authorization. AAU assigns the default setting /SRV_USERNAMES=* when the ACMSAAF.DAT file is first created.

/[NO]WILD_SUFFIX

Allows a user to install or prevents a user from installing any application whose name begins with the letters of the application name you are authorizing. For example, the following command allows the user with UIC [PERSONNEL,RICHARD] to install any application name that starts with the letters INVAPPL:

```
AAU> MODIFY INVAPPL /ACL=(IDENTIFIER=[PERSONNEL,RICHARD], -
_AAU> ACCESS=CONTROL)/WILD_SUFFIX
```

Once this command is in effect, user [PERSONNEL,RICHARD] can install applications with names such as INVAPPL, INVAPPL1, and INVAPPL2.

By default, AAU uses the setting assigned in the DEFAULT authorization. AAU assigns the default setting /NOWILD_SUFFIX when the ACMSAAF.DAT file is first created.

Notes

The AAU MODIFY command does not invoke an editor.

Both the DEFAULT and the MODIFY commands let you modify the DEFAULT authorization. The DEFAULT command, however, lets you change the DEFAULT authorization only. The MODIFY command serves a more general use and lets you modify any authorization in the ACMSAAF.DAT database file.

Examples

1. AAU> MODIFY PERSONNEL /APPL_USERNAME=ACCOUNT*

This command assigns the application user name ACCOUNT to the PERSONNEL authorization. The new application user name replaces the old one.

2. AAU> MODIFY EMPLOYEE /SRV_USERNAMES=(TRAINING_SRV)

This command replaces the old server user name with TRAINING_SRV.

MODIFY

3. AAU> MODIFY EMPLOYEE /WILD_SUFFIX

This command adds the wildcard characteristic to the EMPLOYEE authorization. Users authorized to install EMPLOYEE can also install any application that begins with the letters EMPLOYEE, such as EMPLOYEE1 or EMPLOYEE2.

REMOVE Command (AAU>)

Deletes an authorization from the ACMSAAF.DAT application authorization database file.

Format

REMOVE application-name

Privileges Required

None

Parameters

application-name

The name of the application authorization you are deleting. It can be a valid RMS file name of up to 39 characters or \$ALL. It cannot be DEFAULT because AAU does not allow you to delete the DEFAULT authorization.

Notes

None

Examples

1. AAU> REMOVE PERSONNEL

This command deletes the authorization that has the application name PERSONNEL.

2. AAU> REMOVE \$ALL

This command deletes the \$ALL authorization. As a result, you may need to create individual authorizations for applications that you want authorized users to install.

RENAME

RENAME Command (AAU>)

Gives an application authorization a new name.

Format

```
RENAME old-application-name new-application-name
```

Command Qualifiers

/ACL=(access-control-list[,...])

/APPL_USERNAME=user-name

/[NO]DYNAMIC_USERNAMES

/SRV_USERNAMES[=(server-user-name[,...])]

/[NO]WILD_SUFFIX

Default

From old authorization

From old authorization

From old authorization

From old authorization

From old authorization

Privileges Required

None

Parameters

old-application-name

The application name for the old authorization you are renaming. It can be a valid RMS file name of up to 39 characters or \$ALL. It cannot be DEFAULT; AAU does not let you rename the DEFAULT authorization.

new-application-name

The application name you give to the new authorization. The new application name can be a valid RMS file name of up to 39 characters or \$ALL.

Qualifiers

/ACL=(access-control-list[,...])

The /ACL qualifier authorizes a user to install an application database file in ACMS\$DIRECTORY. The Access Control List identifies who can and who cannot install an application. See the description of the /ACL qualifier under the ADD command for more information about the /ACL qualifier and rules for specifying Access Control Lists.

/APPL_USERNAME=user-name

Identifies the user name of an application. The ACMS/INSTALL command does not install the application database file in ACMS\$DIRECTORY unless the application user name in the application database file matches the one you specify with the /APPL_USERNAME qualifier. If you specify the wildcard character (*) instead of a user name, the wildcard user name automatically matches any user name specified in the application that a user tries to install.

By default, AAU uses the setting assigned in the DEFAULT authorization. AAU assigns the default setting /APPL_USERNAME=* when the ACMSAAF.DAT file is first created.

/[NO]DYNAMIC_USERNAMES

Allows a user to install an application database file if the setting you assign with the /[NO]DYNAMIC_USERNAMES qualifier matches that in the application. For example, if you do not want an application installed that allows servers to use dynamic user names or "USERNAME OF SUBMITTER", use the /NODYNAMIC_

USERNAMES qualifier. If you want an application installed that allows servers to use dynamic user names, use the /DYNAMIC_USERNAMES qualifier.

By default, AAU uses the setting assigned in the DEFAULT authorization. AAU assigns /NODYNAMIC_USERNAMES as the default setting when the ACMSAAF.DAT file is first created.

/SRV_USERNAMES[=(server-user-name[,...])]

Specifies one or more server user names that are associated with the application you are authorizing. The ACMS/INSTALL command installs an application if the server user names that you specify with the /SRV_USERNAMES qualifier match those in the application database file. If you specify the wildcard character (*) for a server user name, the wildcard user name automatically matches all server user names specified in the application.

If you do not want to authorize any server user names, include the /SRV_USERNAMES qualifier without any specifiers. For example:

```
$ AAU> RENAME INVESTMENT /SRV_USERNAMES
```

By default, AAU uses the setting assigned in the DEFAULT authorization. AAU assigns the default setting /SRV_USERNAMES=* when the ACMSAAF.DAT file is first created.

/[NO]WILD_SUFFIX

Allows a user to install or prevents a user from installing any application whose name begins with the letters of the application name you are authorizing. For example, the following command allows the user with UIC [PERSONNEL,RICHARD] to rename any application name that starts with the letters INVAPPL:

```
AAU> RENAME INVAPPL /ACL=(IDENTIFIER=[PERSONNEL,RICHARD], -
_AAU> ACCESS=CONTROL)/WILD_SUFFIX
```

Once this command is in effect, user [PERSONNEL,RICHARD] can rename applications with names such as INVAPPL, INVAPPL1, and INVAPPL2.

By default, AAU uses the setting assigned in the DEFAULT authorization. AAU assigns the default setting /NOWILD_SUFFIX when the ACMSAAF.DAT file is first created.

Note

The new application name must be unique in the ACMSAAF.DAT file.

Examples

1. AAU> RENAME PERSONNEL EMPLOYEE /ACL=(ID=[PERSONNEL,RICHARD], -
_AAU> ACCESS=CONTROL)/APPL_USERNAME=MERCHANT /SRV_USERNAMES -
_AAU> =MERCHANT_SRV

This command changes the application name from PERSONNEL to EMPLOYEE. The /ACL qualifier replaces the old access control entry with UIC [PERSONNEL,RICHARD]. The /APPL_USERNAME qualifier changes the application user name to MERCHANT. Finally, the SRV_USERNAMES qualifier replaces any previously assigned server user names with the user name MERCHANT_SRV. The hyphen (-) at the end of a command allows you to continue the command on a new line, and the AAU> prompt shows you when to enter the rest of your command.

RENAME

2. AAU> RENAME MEDICAL SURGICAL /WILD_SUFFIX

This command changes the application name in the authorization from MEDICAL to SURGICAL. It also gives the wildcard characteristic to the new authorization. Application names with this characteristic allow users to specify with the ACMS/INSTALL operator command any application name that begins with the letters of the word SURGICAL. For example, the ACMS/INSTALL operator command lets a user install application names, such as SURGICAL1, SURGICALTEAM, or SURGICAL2.

SHOW Command (AAU>)

Displays information about application authorizations on your terminal screen.

Format

SHOW application-name

Command Qualifier	Default
/BRIEF	Displays full authorizations

Privileges Required

None

Parameters

application-name

The name of an application authorization that you want to display on your terminal screen. The name can be a valid RMS file name of up to 39 characters, \$ALL, DEFAULT, or the wildcard character (*). You can also use the wildcard character as a prefix, as a suffix, or as both.

Qualifiers

/BRIEF

Displays only the application names of all authorizations in the ACMSAAF.DAT file. By default, the SHOW command displays the contents of all authorizations in ACMSAAF.DAT.

Note

To display the contents of all authorizations in the ACMSAAF.DAT file, use the wildcard character (*) as the application name.

Examples

1. AAU> SHOW *

With the wildcard character (*) as the application name, you can display the contents of all authorizations in the ACMSAAF.DAT file.

2. AAU> SHOW PERSONNEL*

You list the contents of the authorization that has the application name PERSONNEL.

3. AAU> SHOW * /BRIEF

The /BRIEF qualifier on the SHOW command lets you see all the application names in the ACMSAAF.DAT file, without having to list all information associated with each application name.

4. AAU> SHOW B*

The SHOW command displays authorizations for all application names beginning with the letter B.

ACMSQUEMGR Commands

This chapter contains reference information and examples for the ACMS Queue Manager (ACMSQUEMGR) Utility commands. ACMSQUEMGR commands allow you to create and manage ACMS task queues and the queued task elements in the queues. See Chapter 5 for general information about the ACMSQUEMGR Utility.

CREATE QUEUE

CREATE QUEUE Command (ACMSQUEMGR>)

Creates a queue for queued task elements.

Format

```
CREATE QUEUE queue-name
```

Command Qualifiers	Defaults
/DEQUEUE=keyword	/DEQUEUE=RESUMED
/ENQUEUE=keyword	/ENQUEUE=RESUMED
/FILE_SPECIFICATION=file-spec	SYS\$SYSTEM:queue-name.DAT
/MAX_WORKSPACES_SIZE=n	/MAX_WORKSPACES_SIZE=256

Privileges Required

OpenVMS SYSPRV privilege or write access to SYS\$SYSTEM

Parameters

queue-name

The name of the queue you want to create. A queue name can be any valid RMS file name containing 1 through 39 alphanumeric characters.

Qualifiers

/DEQUEUE=keyword

Allows or disallows the dequeuing of all queued task elements in the created queue. Specify one of the following keywords with the /DEQUEUE qualifier:

- **SUSPENDED**

The /DEQUEUE=SUSPENDED qualifier prohibits the Queued Task Initiator (QTI) and ACMS\$DEQUEUE_TASK service from processing queued task elements in the queue. This qualifier allows tasks to be queued to the created queue, but suspends them from being dequeued until you specify the /DEQUEUE=RESUMED qualifier. The default is /DEQUEUE=RESUMED.

- **RESUMED**

The /DEQUEUE=RESUMED qualifier allows the QTI and ACMS\$DEQUEUE_TASK service to dequeue queued task elements in the queue. Use this qualifier after you specify /DEQUEUE=SUSPENDED to resume dequeuing. The default is /DEQUEUE=RESUMED.

/ENQUEUE=keyword

Enables or disables the queuing of queued task elements to the queue you create. You can specify one of the following keywords with the /ENQUEUE qualifier:

- **SUSPENDED**

The /ENQUEUE=SUSPENDED qualifier prohibits the ACMS\$QUEUE_TASK service from queuing queued task elements to the queue you create until the queue state is resumed. The default is /ENQUEUE=RESUMED.

- RESUMED

The /ENQUEUE=RESUMED qualifier allows ACMS\$QUEUE_TASK service to queue queued task elements to the queue you create. The default is /ENQUEUE=RESUMED.

/FILE_SPECIFICATION=file-spec

Specifies the file specification of the queue repository that stores the queued task elements. The file specification can be any valid RMS file specification or logical name. If you do not specify the /FILE_SPECIFICATION qualifier, the queue repository is SYS\$SYSTEM: **queue-name**.DAT, where **queue-name** is the name of the created queue. If you do not specify a full file specification, the missing components are taken from the default file specification.

/MAX_WORKSPACES_SIZE=n

Specifies the maximum total size (in bytes) of workspaces allowed in a single queued task element for the queue you create. If you do not use the /MAX_WORKSPACES_SIZE qualifier, the default is /MAX_WORKSPACES_SIZE=256. You can specify a value of 0 through 31,720. If a queued task element's workspace size on a call to the ACMS\$QUEUE_TASK service exceeds the value specified with the /MAX_WORKSPACES_SIZE qualifier, you receive an error when you queue the task.

Specify the largest workspace size needed for a single queued task element that is queued to the queue. Use the following formula to determine the workspace size for a single queued task element:

$$2 * (n+1) \\ + \text{size (in bytes) of workspace 1} \\ + \text{size (in bytes) of workspace 2} \\ \cdot \\ \cdot \\ + \text{size (in bytes) of workspace n (where n is the total number of workspaces)}$$

The number of workspaces and size of the workspaces that can be passed to a task are displayed when you use the Application Definition Utility (ADU) command DUMP GROUP.

For the most efficient performance of the queue services and the QTI, specify the smallest possible value with the /MAX_WORKSPACES_SIZE qualifier.

Notes

You must create a queue before the queue can be accessed by the ACMS queued task services or by the QTI run-time component.

The queue repository file is created with the owner UIC [1,4] and the protection (S:RWED,O:RWED,G,W).

ACMS stores queue information in the file SYS\$SYSTEM:ACMSQDF.DAT.

CREATE QUEUE

Examples

1. ACMSQUEMGR> CREATE QUEUE BIG_NUMBERS_QUE

This command creates the queue BIG_NUMBERS_QUEUE. The defaults are used for all qualifiers.

2. ACMSQUEMGR> CREATE QUEUE EMPLOYEE_QUEUE /MAX_WORKSPACES_SIZE=500

This command creates queue EMPLOYEE_QUEUE, setting the maximum workspace size allowed for queued task elements at 500.

3. ACMSQUEMGR> CREATE QUEUE INVENTORY_QUE -
_ACMSQUEMGR> /FILE_SPECIFICATION=MYDISK\$:QUEUE.DAT -
_ACMSQUEMGR> /ENQUEUE=SUSPENDED

This command creates the queue INVENTORY_QUE. It names the queue repository file MYDISK\$:QUEUE.DAT, and disallows queuing of queued task elements by the ACMS\$QUEUE_TASK service.

DELETE ELEMENT Command (ACMSQUEMGR>)

Removes one or more queued task elements from the specified queue.

Format

DELETE ELEMENT element-id queue-name

Command Qualifiers	Defaults
/[NO]CONFIRM	/NOCONFIRM
/EXCLUDE=(keyword[,...])	None
/SELECT=(keyword[,...])	None

Privileges Required

Write access to the queue repository file. If the queue repository file has the default protection from the CREATE QUEUE command, you need the OpenVMS SYSPRV privilege or the UIC [1,4] to delete the queued task element.

Parameters

element-id

The element identification of the queued task element you want to remove. Either specify the element ID of the task element or use the wildcard character (*). The element ID is returned by the ACMS\$QUEUE_TASK service. Specify all or part of the element ID. If you specify only part of an element ID, all queued task elements whose IDs contain the specified characters are removed. For example, if MY_NODE is specified as the element ID, all elements queued from MY_NODE are removed from the queue. Display the element ID of a queued task element by using the SHOW ELEMENT command with the /FULL qualifier. The SHOW ELEMENT command is described in SHOW ELEMENT Command (ACMSQUEMGR>).

If you use the wildcard character (*) in place of an element ID, all queued task elements are removed from the specified queue. When using the wildcard character, you can also use the /SELECT qualifier or /EXCLUDE qualifier to choose a group of queued task elements to remove.

queue-name

The name of the queue containing the queued task element. A queue name can be any valid RMS file name containing 1 through 39 alphanumeric characters.

Qualifiers

/[NO]CONFIRM

/CONFIRM displays each queued task element selected for removal and prompts you to confirm that you want the queued task element removed. Answer the prompt by entering one of the following:

- Y or y—For yes
- N or n—For no
- Q or q—For quit (exits the command without removing the queued task element).

DELETE ELEMENT

- A or a—For always (removes all remaining queued task elements without displaying the confirmation prompt).
- RETURN—For the default

The default is /NOCONFIRM.

/EXCLUDE=(keyword[,...])

Allows you to exclude a queued task element or group of queued task elements from being removed. Specify exclusion criteria with keywords to the /EXCLUDE qualifier. You can specify more than one keyword by separating the keywords with a comma and enclosing them in parentheses. You must use at least one keyword with the /EXCLUDE qualifier. You can use the /EXCLUDE qualifier to limit the scope of the DELETE ELEMENT command when you use a wildcard character (*) instead of an element ID.

The /EXCLUDE qualifier takes precedence over the /SELECT qualifier. Therefore, if a queued task element matches the selection criteria but is excluded by the exclusion criteria, that queued task element is not removed from the queue.

Specify one or more of the following keywords:

- APPLICATION=(application-spec[,...])
Excludes queued task elements containing the specified application. Specify more than one application specification by separating the specifications with a comma and enclosing them in parentheses.
- BEFORE=time
Excludes queued task elements queued before the specified time. You can specify absolute time, combination time, or the keyword argument TODAY or YESTERDAY. See *OpenVMS User's Manual* for more information about absolute and combination time.
- PRIORITY=(n[,...])
Excludes queued task elements having the specified priority. Valid priority values are 0 through 255. Specify more than one priority value by separating the values with a comma and enclosing them in parentheses.
- SINCE=time
Excludes queued task elements queued since the specified time. You can specify absolute time, combination time, or the keyword argument TODAY or YESTERDAY. See *OpenVMS User's Manual* for more information about absolute and combination time.
- STATE=[NO]HOLD
If you specify /EXCLUDE=STATE=HOLD, the ACMSQUEMGR excludes all queued task elements currently on hold. Queued task elements on hold cannot be removed from the queue. If you specify /EXCLUDE=STATE=NOHOLD, the ACMSQUEMGR excludes all queued task elements not on hold. Queued task elements that are not on hold can be dequeued.
- TASK=(task-name[,...])
Excludes all queued task elements having the specified task name. Specify more than one task name by separating the task names with a comma and enclosing them in parentheses.

- **USERNAME=(enqueueer-user-name[,...])**
Excludes all queued task elements that have the specified enqueueer user name. The enqueueer user name is the user name explicitly or implicitly specified with the ACMS\$QUEUE_TASK service. See *HP ACMS for OpenVMS Writing Applications* for information about the ACMS\$QUEUE_TASK service.

/SELECT=(keyword[,...])

Limits the DELETE ELEMENT command to queued task elements that match the selection criteria. Specify the selection criteria with keywords to the /SELECT qualifier. Specify more than one keyword by separating the keywords with a comma and enclosing them in parentheses. You must use at least one keyword with the /SELECT qualifier. You can use the /SELECT qualifier to limit the scope of the DELETE ELEMENT command when you use a wildcard character (*) instead of an element ID.

Specify one or more of the following keywords:

- **APPLICATION=(application-spec[,...])**
Removes only queued task elements containing the specified application. You can specify more than one application specification by separating the specifications with a comma and enclosing them in parentheses.
- **BEFORE=time**
Removes all queued task elements queued before the specified time. You can specify absolute time, combination time, or the keyword argument TODAY or YESTERDAY. See *OpenVMS User's Manual* for more information about absolute and combination time.
- **PRIORITY=(n[,...])**
Removes all queued task elements having the specified priority. Valid priority values are 0 through 255. Specify more than one priority value by separating the values with a comma and enclosing them in parentheses.
- **SINCE=time**
Removes all queued task elements queued since the specified time. You can specify absolute time, combination time, or the keyword argument TODAY or YESTERDAY. See *OpenVMS User's Manual* for more information about absolute and combination time.
- **STATE=[NO]HOLD**
If you specify /SELECT=STATE=HOLD, the ACMSQUEMGR removes all queued task elements currently on hold. If you specify /SELECT=STATE=NOHOLD, the ACMSQUEMGR removes all queued task elements not on hold.
- **TASK=(task-name[,...])**
Removes all queued task elements having the specified task name. Specify more than one task name by separating the task names with a comma and enclosing them in parentheses.

DELETE ELEMENT

- **USERNAME=(enqueueer-user-name[,...])**
Removes all queued task elements that have the specified enqueueer user name. The enqueueer user name is the user name explicitly or implicitly specified with the ACMS\$QUEUE_TASK service. See *HP ACMS for OpenVMS Writing Applications* for information about the ACMS\$QUEUE_TASK service.

Notes

None

Examples

1. ACMSQUEMGR> DELETE ELEMENT MY_NODE::28C0082-0000000A MY_QUE
This command deletes the queued task element identified by the element ID MY_NODE::28C0082-0000000A in queue MY_QUE.
2. ACMSQUEMGR> DELETE ELEMENT * YOUR_QUE
This command deletes all queued task elements in queue YOUR_QUE.
3. ACMSQUEMGR> DELETE ELEMENT * RACE_QUEUE /CONFIRM
This command causes ACMSQUEMGR to prompt you for confirmation before deleting each queued task element in queue RACE_QUEUE.
4. ACMSQUEMGR> DELETE ELEMENT * RESERVE_QUE -
_ACMSQUEMGR> /EXCLUDE=TASK=(BIGTSK,BIGGERTSK)
This command deletes all queued task elements in queue RESERVE_QUE except for the queued task elements having the names BIGTSK and BIGGERTSK.
5. ACMSQUEMGR> DELETE ELEMENT MY_NODE:: BOOK_QUE /SELECT=STATE=HOLD
This command deletes all queued task elements queued from node MY_NODE to queue BOOK_QUE that are currently on hold.
6. ACMSQUEMGR> DELETE ELEMENT * BOSCO_QUEUE -
_ACMSQUEMGR> /SELECT=(APPLICATION=STATS,SINCE=TODAY)
This command deletes all queued task elements on queue BOSCO_QUEUE that were queued today and contain the application STATS.

DELETE QUEUE Command (ACMSQUEMGR>)

Deletes the queue you specify.

Format

```
DELETE QUEUE queue-name
```

Command Qualifier	Default
/[NO]PURGE	/NOPURGE

Privileges Required

Delete access to the queue repository file. If the queue repository file has default protection from the CREATE QUEUE command, you need OpenVMS SYSPRV privilege or the UIC [1,4] to delete the queue.

Parameters

queue-name

The name of the queue you want to delete. A queue name can be any valid RMS file name containing 1 through 39 alphanumeric characters.

Qualifiers

/[NO]PURGE

If you use the /PURGE qualifier, all queued task elements currently in the queue are deleted along with the queue. If you use the /NOPURGE qualifier, and queued task elements are in the queue, ACMSQUEMGR cannot delete the queue. ACMS displays an error message indicating that the queue is not empty. The default is /NOPURGE.

Notes

The DELETE QUEUE command requires exclusive access to the queue repository file. If the queue is currently being processed by the QTI, the queue must be stopped with the ACMS/STOP QUEUE command. If the queue has been accessed by an image using the ACMS queue task services, the image must be exited.

Examples

1. ACMSQUEMGR> DELETE QUEUE GROUP_QUE

This command deletes queue GROUP_QUE.

2. ACMSQUEMGR> DELETE QUEUE BOSS_QUE /PURGE

This command deletes queue BOSS_QUE and removes any queued task elements in the queue.

EXIT

EXIT Command (ACMSQUEMGR>)

Ends the ACMSQUEMGR session and returns you to DCL level.

Format

EXIT

Privileges Required

None

Notes

You can also end a session by pressing `Ctrl/Z`. `Ctrl/Z` signals the end of the file for data entered from the terminal. `Ctrl/Z` is displayed as EXIT.

Example

```
ACMSQUEMGR> EXIT
$
```

This command causes you to exit from ACMSQUEMGR and returns you to DCL level.

HELP Command (ACMSQUEMGR>)

Displays information about ACMSQUEMGR commands and qualifiers.

Format

HELP [topic [...]]

Command Qualifier	Default
/[NO]PROMPT	/PROMPT

Privileges Required

None

Parameters

topic

The ACMSQUEMGR command or topic you want to know about. If you do not specify a topic, HELP provides a list of topics to choose from. Use the wildcard character (*) as a prefix or suffix to display information on a sequence of topics with common characters.

Qualifiers

/[NO]PROMPT

Controls whether or not you receive prompts for the topic and subtopic. If you use the /NOPROMPT qualifier, no prompts are displayed. If you use the /PROMPT qualifier, prompts are displayed along with the help information. The default is /PROMPT.

Notes

None

Example

```
ACMSQUEMGR> HELP SET ELEMENT
```

```
SET
```

```
  ELEMENT
```

```
  Sets the state or priority of one or more queued task elements.
  You must specify at least one qualifier or this command has
  no effect.
```

```
  Format:
```

```
    SET ELEMENT element-id queue-name /qualifier
```

```
  You can specify all or part of an element ID. Use the
  wildcard character (*) to set characteristics of all the
  queued task elements in a queue. Use SHOW ELEMENT to display
  element IDs.
```

```
  For example:
```

```
    ACMSQUEMGR> SET ELEMENT * EILEEN_QUE /PRIORITY=200 -
    _ACMSQUEMGR> /SELECT=(TASK=URGENT)
```

```
  Additional information available:
```

HELP

/CONFIRM /EXCLUDE /PRIORITY /SELECT /STATE
SET ELEMENT Subtopic?

This command displays help information about the SET ELEMENT command.

MODIFY QUEUE Command (ACMSQUEMGR>)

With a qualifier, modifies the static characteristics of a task queue.

Format

MODIFY QUEUE queue-name

Command Qualifiers	Defaults
/FILE_SPECIFICATION=file-spec	Existing queue repository file
/MAX_WORKSPACES_SIZE=n	Specified in the existing definition

Privileges Required

Write access to the queue repository file. If the queue repository file has the default protection from the CREATE QUEUE command, you need OpenVMS SYSPRV privilege or the UIC [1,4] to modify the queue.

Parameters

queue-name

The name of the queue whose characteristics you want to modify. A queue name can be any valid RMS file name containing 1 through 39 alphanumeric characters.

Qualifiers

/FILE_SPECIFICATION=file-spec

Specifies the file specification of a new queue repository file. The file specification can be any valid RMS file specification or logical name. If you do not use the /FILE_SPECIFICATION qualifier, the existing queue repository file is used. If you do not specify a full file specification, the missing components are taken from the default file specification, SYS\$SYSTEM:queue-name.DAT, where queue-name is the name of the queue.

/MAX_WORKSPACES_SIZE=n

Specifies the maximum total size (in bytes) of workspaces allowed in a single queued task element for the queue you modify. If you do not use the /MAX_WORKSPACES_SIZE qualifier, the default is /MAX_WORKSPACES_SIZE=256. You can specify a value of 0 through 31,720. If a queued task element's workspace size on a call to the ACMS\$QUEUE_TASK service exceeds the value specified with the /MAX_WORKSPACES_SIZE qualifier, you receive an error when you queue the task.

Specify the largest workspace size needed for a single queued task element that will be queued to the queue. Use the following formula to determine the workspace size for a single queued task element:

```

2 * (n+1)
+ size (in bytes) of workspace 1
+ size (in bytes) of workspace 2
.
.
.
+ size (in bytes) of workspace n (where n is the total number of workspaces)

```

MODIFY QUEUE

The number of workspaces and size of the workspaces that can be passed to a task are displayed when you use the Application Definition Utility (ADU) command `DUMP GROUP`.

For the most efficient performance of the queue services and the QTI, specify the smallest possible value with the `/MAX_WORKSPACES_SIZE` qualifier.

Notes

You must use either the `/FILE_SPECIFICATION` or `/MAX_WORKSPACES_SIZE` qualifier with the `MODIFY QUEUE` command.

The `MODIFY QUEUE` command requires exclusive access to the queue repository file. If the queue is currently being processed by the QTI, the queue must be stopped with the `ACMS/STOP QUEUE` command before you issue this command. If the queue has been accessed by an image using the ACMS queue task services, the image must be exited.

A queue is not available for any queue operations while it is being modified.

Examples

1. `ACMSQUEMGR> MODIFY QUEUE DEVO_QUE /FILE_SPECIFICATION=DEVO.DAT`

This command modifies queue `DEVO_QUE`, naming `DEVO.DAT` as the queue repository file.

2. `ACMSQUEMGR> MODIFY QUEUE DOCO_QUE /MAX_WORKSPACES_SIZE=500`

This command modifies queue `DOCO_QUE`, setting the maximum workspace size of tasks to 500.

SET ELEMENT Command (ACMSQUEMGR>)

With the /PRIORITY qualifier, sets the priority of one or more queued task elements. With the /STATE qualifier, sets the state of one or more queued task elements.

Format

SET ELEMENT element-id queue-name

Command Qualifiers	Defaults
/[NO]CONFIRM	/NOCONFIRM
/EXCLUDE=(keyword[,...])	None
/PRIORITY=n	None
/SELECT=(keyword[,...])	None
/STATE=[NO]HOLD	None

Privileges Required

Write access to the queue repository file. If the queue repository file has the default protection from the CREATE QUEUE command, you need the OpenVMS SYSPRV privilege or the UIC [1,4] to set characteristics.

Parameters

element-id

The element identification of the queued task element whose characteristics you want to set. Either specify an element ID or use the wildcard character (*). The element ID for a task is returned by the ACMS\$QUEUE_TASK service.

You can specify all or part of the element ID. If you specify only part of an element ID, the characteristics of all queued task elements whose IDs contain the specified characters are set. For example, if MY_NODE is specified as the element ID, all elements queued from node MY_NODE are set with the characteristics you specify. Display the element ID of a queued task element by using the SHOW ELEMENT command with the /FULL qualifier. The SHOW ELEMENT command is described in SHOW ELEMENT Command (ACMSQUEMGR>).

If you use the wildcard character (*) in place of an element ID, the characteristics of all queued task elements are set. When using the wildcard character, you can also use the /SELECT qualifier or the /EXCLUDE qualifier to choose a group of queued task elements for which to set characteristics. See *HP ACMS for OpenVMS Writing Applications* for information about the ACMS\$QUEUE_TASK service.

queue-name

The name of the queue that contains the queue task elements. A queue name can be any valid RMS file name containing 1 through 39 alphanumeric characters.

Qualifiers

/[NO]CONFIRM

/CONFIRM displays each queued task element selected for modification and prompts you to confirm that you want the characteristics of the queued task element modified. Answer the prompt by entering one of the following:

SET ELEMENT

- Y or y—for yes
- N or n—for no
- Q or q—for quit (exits the command without modifying the queued task element)
- A or a—for always (modifies all remaining queued task elements without displaying the confirmation prompt)
- RETURN—for the default

The default is /NOCONFIRM.

/EXCLUDE=(keyword[,...])

Allows you to exclude a queued task element or group of queued task elements from being modified by the SET ELEMENT command. Specify the exclusion criteria with keywords to the /EXCLUDE qualifier. You must use at least one keyword with the /EXCLUDE qualifier. Specify more than one keyword by separating the keywords with a comma and enclosing them in parentheses. You can use the /EXCLUDE qualifier to limit the scope of the SET ELEMENT command when you specify a wildcard character (*) instead of an element ID.

The /EXCLUDE qualifier takes precedence over the /SELECT qualifier. Therefore, if a queued task element matches the selection criteria but is excluded by the exclusion criteria, the characteristics of the queued task elements are not modified.

Specify one or more of the following keywords:

- APPLICATION=(application-spec[,...])
Excludes queued task elements containing the specified application. Specify more than one application specification by separating the specifications with a comma and enclosing them in parentheses.
- BEFORE=time
Excludes queued task elements queued before the specified time. You can specify absolute time, combination time, or the keyword argument TODAY or YESTERDAY. See *OpenVMS User's Manual* for more information about absolute and combination time.
- PRIORITY=(n[,...])
Excludes queued task elements having the specified priority. Valid priority values are 0 through 255. Specify more than one priority value by separating the values with a comma and enclosing them in parentheses.
- SINCE=time
Excludes queued task elements queued since the specified time. You can specify absolute time, combination time, or the keyword argument TODAY or YESTERDAY. See *OpenVMS User's Manual* for more information about absolute and combination time.
- STATE=[NO]HOLD
If you specify /EXCLUDE=STATE=HOLD, the ACMSQUEMGR excludes queued task elements that are currently on hold. If you specify /EXCLUDE=STATE=NOHOLD, the ACMSQUEMGR excludes queued task elements that are not on hold.

- **TASK=(task-name[,...])**
Excludes all queued task elements having the specified task name. Specify more than one task name by separating the task names with a comma and enclosing them in parentheses.
- **USERNAME=(enqueueer-user-name[,...])**
Excludes all queued task elements that have the specified enqueueer user name. The enqueueer user name is the user name explicitly or implicitly specified with the ACMS\$QUEUE_TASK service. See *HP ACMS for OpenVMS Writing Applications* for information about the ACMS\$QUEUE_TASK service.

/PRIORITY=n

Specifies the priority of the queued task element. You can specify a priority of 0 through 255. Tasks with the highest numerical priority are processed by the QTI first.

/SELECT=(keyword[,...])

Limits the SET ELEMENT command to queued task elements that match the selection criteria. Specify the selection criteria with keywords to the /SELECT qualifier. Specify more than one keyword by separating the keywords with a comma and enclosing them in parentheses. You must specify at least one keyword with the /SELECT qualifier. Use the /SELECT qualifier to limit the scope of the SET ELEMENT command when you specify a wildcard character (*) instead of an element ID.

You can specify one or more of the following keywords:

- **APPLICATION=(application-spec[,...])**
Sets the characteristics of queued task elements containing the specified application. Specify more than one application specification by separating the specifications with a comma and enclosing them in parentheses.
- **BEFORE=time**
Sets the characteristics of queued task elements queued before the specified time. You can specify absolute time, combination time, or the keyword argument TODAY or YESTERDAY. See *OpenVMS User's Manual* for more information about absolute and combination time.
- **PRIORITY=(n[,...])**
Sets the characteristics of queued task elements having the specified priority. Valid priority values are 0 through 255. Specify more than one priority value by separating the values with a comma and enclosing them in parentheses.
- **SINCE=time**
Sets the characteristics of queued task elements queued since the specified time. You can specify absolute time, combination time, or the keyword argument TODAY or YESTERDAY. See *OpenVMS User's Manual* for more information about absolute and combination time.
- **STATE=[NO]HOLD**
If you use /SELECT=STATE=HOLD, the ACMSQUEMGR sets only the characteristics of queued task elements currently on hold. If you use /SELECT=STATE=NOHOLD, the ACMSQUEMGR sets only the characteristics of queued task elements that are not on hold.

SET ELEMENT

- **TASK=(task-name[,...])**
Sets the characteristics of queued task elements that have the specified task name. Specify more than one task name by separating the task names with a comma and enclosing them in parentheses.
- **USERNAME=(enqueueer-user-name[,...])**
Sets the characteristics of queued task elements that have the specified enqueueer user name. The enqueueer user name is the user name explicitly or implicitly specified with the ACMS\$QUEUE_TASK service. See *HP ACMS for OpenVMS Writing Applications* for information about the ACMS\$QUEUE_TASK service.

/STATE=[NO]HOLD

The /STATE=HOLD qualifier places the specified queued task element on hold. Queued task elements on hold cannot be dequeued. The /STATE=NOHOLD qualifier releases the specified queued task element from the hold state. If you do not include the qualifier, the hold state of the queued task element is unchanged.

Notes

You must use either the /PRIORITY qualifier or the /STATE qualifier with the SET ELEMENT command.

Examples

1. ACMSQUEMGR> SET ELEMENT MY_NODE:28C00082-0000000E -
_ACMSQUEMGR> ACCT_QUEUE /PRIORITY=255

This command sets the priority of the queued task element having the element ID MY_NODE:28C00082-0000000E to 255. Priority 255 is the highest priority you can assign a task.

2. ACMSQUEMGR> SET ELEMENT MY_NODE:: FAST_QUEUE -
_ACMSQUEMGR> /STATE=HOLD/SELECT=APPLICATION=IN_STOCK

This command places all queued task elements containing the application IN_STOCK on hold, provided they were queued from node MY_NODE and are stored in queue FAST_QUEUE.

3. ACMSQUEMGR> SET ELEMENT MY_NODE: PAY_QUE -
_ACMSQUEMGR> /EXCLUDE=APPLICATION=PAYROLL /STATE=HOLD

This command places all queued task elements queued from node MY_NODE in queue PAY_QUE on hold, excluding those queued task elements containing the application PAYROLL.

SET QUEUE Command (ACMSQUEMGR>)

With a qualifier, dynamically sets the queue state. The changes to the queue state take effect immediately.

Format

SET QUEUE queue-name

Command Qualifiers	Defaults
/DEQUEUE=keyword	Current queue state
/ENQUEUE=keyword	Current queue state

Privileges Required

Write access to the queue repository file. If the queue repository file has the default protection from the CREATE QUEUE command, you need the OpenVMS SYSOPR privilege or the UIC [1,4] to modify the queue.

Parameters

queue-name

The name of the queue whose state you want to set. A queue name can be any valid RMS file name containing 1 through 39 alphanumeric characters.

Qualifiers

/DEQUEUE=keyword

Allows or disallows the dequeuing of all queued task elements in the queue. Specify one of the following keywords with the /DEQUEUE qualifier:

- **SUSPENDED**
The /DEQUEUE=SUSPENDED qualifier prohibits the QTI and ACMS\$DEQUEUE_TASK service from dequeuing queued task elements in the queue until the queue state is resumed. The default is whatever is defined in the queue definition file (ACMSQDF.DAT) when the queue was created.
- **RESUMED**
The /DEQUEUE=RESUMED qualifier allows the QTI and ACMS\$DEQUEUE_TASK service to resume dequeuing queued task elements in the queue. The default is whatever is defined in the queue definition file (ACMSQDF.DAT) when the queue was created.

/ENQUEUE=keyword

Enables or disables the queuing of queued task elements to a queue. Specify one of the following keywords with the /ENQUEUE qualifier:

- **SUSPENDED**
The /ENQUEUE=SUSPENDED qualifier prohibits the ACMS\$QUEUE_TASK service from queuing queued task elements to the queue until the queue is resumed. The default is whatever is currently defined in the queue definition file.

SET QUEUE

- RESUMED

The `/ENQUEUE=RESUMED` qualifier allows the `ACMS$QUEUE_TASK` service to resume queuing queued task elements to the queue. The default is whatever is currently defined in the queue definition file.

Notes

You must use either the `/DEQUEUE` qualifier or the `/ENQUEUE` qualifier with the `SET QUEUE` command. Otherwise, the `SET QUEUE` command has no effect and you receive an error message.

Examples

1. `ACMSQUEMGR> SET QUEUE MILL_QUE /ENQUEUE=SUSPENDED`

This command prevents the `ACMS$QUEUE_TASK` service from queuing tasks to queue `MILL_QUE`.

2. `ACMSQUEMGR> SET QUEUE INVENTORY_QUE /DEQUEUE=SUSPENDED`

This command prevents the `ACMS$DEQUEUE_TASK` service and the `QTI` from dequeuing queued task elements in queue `INVENTORY_QUE`.

SHOW ELEMENT Command (ACMSQUEMGR>)

Displays information about one or more queued task elements in a queue.

Format

SHOW ELEMENT element-id queue-name

Command Qualifiers	Defaults
/BRIEF	/BRIEF
/EXCLUDE=(keyword[,...])	None
/FULL	/BRIEF
/OUTPUT[=file-spec]	SYS\$OUTPUT
/SELECT=(keyword[,...])	None
/TOTAL_ONLY	/BRIEF

Privileges Required

Read access to the queue repository file. If the queue repository file has the default protection from the CREATE QUEUE command, you need the OpenVMS SYSPRV privilege or the UIC [1,4] to display information about the queued task element.

Parameters

element-id

The element ID of the queued task element you want to display information about, or the wildcard character (*). If you use the wildcard character, ACMSQUEMGR displays all queued task elements for a queue.

You can specify all or part of the element ID. If you specify only part of an element ID, the ACMSQUEMGR displays all queued task elements whose IDs contain the specified characters. The element ID for a task is returned by the ACMS\$QUEUE_TASK service. Determine the element ID of a queued task element by specifying the SHOW ELEMENT command with the /FULL qualifier.

When using the wildcard character, you can also use the /SELECT qualifier or /EXCLUDE qualifier to select a group of queued task elements to display.

queue-name

The name of the queue containing the queued task elements. A queue name can be any valid RMS file name containing 1 through 39 alphanumeric characters.

Qualifiers

/BRIEF

Provides a brief display of queued task information. /BRIEF is the default.

/EXCLUDE=(keyword[,...])

Allows you to exclude a queued task element or group of queued task elements from being displayed. Specify the exclusion criteria with keywords to the /EXCLUDE qualifier. You must use at least one keyword with the /EXCLUDE qualifier. Specify more than one keyword by separating the keywords with a comma and enclosing them in parentheses. Use the /EXCLUDE qualifier to limit the scope of the SHOW ELEMENT command when you use the wildcard character (*) instead of an element ID.

SHOW ELEMENT

The `/EXCLUDE` qualifier takes precedence over the `/SELECT` qualifier. Therefore, if a queued task element matches the selection criteria but is excluded by the exclusion criteria, that queued task element is not displayed.

Specify one or more of the following keywords:

- **APPLICATION=(application-spec[,...])**
Excludes queued task elements in the specified application from being displayed. Specify more than one application specification by separating the specifications with a comma and enclosing them in parentheses.
- **BEFORE=time**
Excludes queued task elements queued before the specified time. You can specify absolute time, combination time, or the keyword argument `TODAY` or `YESTERDAY`. See *OpenVMS User's Manual* for more information about absolute and combination time.
- **PRIORITY=(n[,...])**
Excludes queued task elements having the specified priority. Valid priority values are 0 through 255. Specify more than one priority value by separating the values with a comma and enclosing them in parentheses.
- **SINCE=time**
Excludes queued task elements queued since the specified time. You can specify absolute time, combination time, or the keyword argument `TODAY` or `YESTERDAY`. See *OpenVMS User's Manual* for more information about absolute and combination time.
- **STATE=[NO]HOLD**
If you use `/EXCLUDE=STATE=HOLD`, the `ACMSQUEMGR` excludes queued task elements that are currently on hold. If you use `/EXCLUDE=STATE=NOHOLD`, the `ACMSQUEMGR` excludes queued task elements that are not on hold.
- **TASK=(task-name[,...])**
Excludes all queued task elements that have the specified task name. Specify more than one task name by separating the task names with a comma and enclosing them in parentheses.
- **USERNAME=(enqueueer-user-name[,...])**
Excludes all queued task elements that have the specified enqueueer user name. The enqueueer user name is the user name explicitly or implicitly specified with the `ACMS$QUEUE_TASK` service. See *HP ACMS for OpenVMS Writing Applications* for information about the `ACMS$QUEUE_TASK` service.

/FULL

Provides a full display of queued task element information. If you do not use the `/FULL` qualifier, the `ACMSQUEMGR` displays only brief information. The default is `/BRIEF`.

/OUTPUT[=file-spec]

Specifies a file specification where you want to send the `SHOW` output. Specify a full file specification, including device, directory, file name, and file type. If you specify an incomplete file specification, `ACMSQUEMGR` uses the file

ACMSQUEMGR.LIS as the default output file. If you do not use the /OUTPUT qualifier, ACMSQUEMGR sends the output to the default device, SYS\$OUTPUT.

/SELECT=(keyword[,...])

Limits the SHOW ELEMENT command to queued task elements that match the selection criteria. Specify the selection criteria with keywords to the /SELECT qualifier. Specify more than one keyword by separating the keywords with a comma and enclosing them in parentheses. You must specify at least one keyword with the /SELECT qualifier. Use the /SELECT qualifier to limit the scope of the SHOW ELEMENT command when you use the wildcard character (*) instead of an element ID.

You can specify one or more of the following keywords:

- **APPLICATION=(application-spec[,...])**
Displays only queued task elements containing the specified application. Specify more than one application specification by separating the specifications with a comma and enclosing them in parentheses.
- **BEFORE=time**
Displays only queued task elements queued before the specified time. You can specify absolute time, combination time, or the keyword argument TODAY or YESTERDAY. See *OpenVMS User's Manual* for more information about absolute and combination time.
- **PRIORITY=(n[,...])**
Displays only queued task elements having the specified priority. Valid priority values are 0 through 255. Specify more than one priority value by separating the values with a comma and enclosing them in parentheses.
- **SINCE=time**
Displays queued task elements queued since the specified time. You can specify absolute time, combination time, or the keyword argument TODAY or YESTERDAY. See *OpenVMS User's Manual* for more information about absolute and combination time.
- **STATE=[NO]HOLD**
If you use /SELECT=STATE=HOLD, the ACMSQUEMGR displays only queued task elements currently on hold. If you use /SELECT=STATE=NOHOLD, the ACMSQUEMGR displays only queue task elements not on hold.
- **TASK=(task-name[,...])**
Displays all queued task elements having the specified task name. Specify more than one task name by separating the task names with a comma and enclosing them in parentheses.
- **USERNAME=(enqueueer-user-name[,...])**
Displays all queued task elements having the specified enqueueer user name. The enqueueer user name is the user name explicitly or implicitly specified with the ACMS\$QUEUE_TASK service. See *HP ACMS for OpenVMS Writing Applications* for information about the ACMS\$QUEUE_TASK service.

/TOTAL_ONLY

Displays only the total number of queued task elements that meet the selection criteria specified with the /SELECT qualifier.

SHOW QUEUE Command (ACMSQUEMGR>)

Displays the characteristics of the task queue you specify.

Format

SHOW QUEUE queue-name

Command Qualifier	Default
/OUTPUT[=file-spec]	SYS\$OUTPUT

Privileges Required

None

Parameters

queue-name

The name of the queue you want to display information about. A queue name can be any valid RMS file name containing 1 through 39 alphanumeric characters. To display all queues, use the wildcard character (*) in place of a queue name.

Qualifiers

/OUTPUT[=file-spec]

Specifies the file specification where you want to send the SHOW command output. Specify a full file specification, including device, directory, file name, and file type. If you specify an incomplete file specification, ACMSQUEMGR uses the file ACMSQUEMGR.LIS. If you do not use the /OUTPUT qualifier, ACMSQUEMGR sends the output to the default device, SYS\$OUTPUT.

Notes

None

Examples

1. ACMSQUEMGR> SHOW QUEUE FASTQUEUE

```
Queue Name: FASTQUEUE
Enqueues State: RESUMED Dequeues State: SUSPENDED Max Wsp Size: 200
File Specification: DISK1:[FOSTER]SHOW_OUTPUT.LIS;1
```

This command displays queue information for queue FASTQUEUE in your current default directory.

2. ACMSQUEMGR> SHOW QUEUE SLOWQUEUE /OUTPUT=SLOW_SHOW.LIS

This command writes information about queue SLOWQUEUE to the file SLOW_SHOW.LIS.

Operator Commands

This chapter contains reference information and examples for the ACMS operator commands. See Chapter 8 and Chapter 9 for a discussion on the ACMS operator commands and their functions.

ACMS/CANCEL TASK

ACMS/CANCEL TASK Command

Stops one or more task instances. With qualifiers, stops only the task instance you identify.

Format

ACMS/CANCEL TASK [task-name]

Command Qualifiers	Defaults
/APPLICATION=application-name	All applications
/[NO]CONFIRM	/CONFIRM
/DEVICE=device-name	All devices
/IDENTIFIER=task-id	All tasks
/[NO]LOG	/NOLOG
/SUBMITTER=submitter-id	All submitters
/USER=user-name	All user names

Privileges Required

OpenVMS OPER privilege

Parameters

task-name

The name of the task you want to cancel. It is the name given to the task in the application definition. The task name you specify can exist in more than one application.

Qualifiers

/APPLICATION=application-name

Cancels tasks in the specified application only. The application name is the file name of an application database for a started application. Do not include device, directory, or file type with the application name. When you specify the /APPLICATION qualifier, ACMS searches for the task name only in the application you specify. If you do not specify the /APPLICATION qualifier, ACMS searches for the task name in all active applications on the system.

If you specify an application name with the /APPLICATION qualifier, but do not specify a task name, ACMS cancels all currently active tasks for the specified application. Naming an application with the /APPLICATION qualifier and naming a task causes ACMS to search for the task in that application only.

/[NO]CONFIRM

The /CONFIRM qualifier causes ACMS to display the name of each task to be canceled and prompts you to indicate whether you still want to cancel the task. The /NOCONFIRM qualifier tells ACMS not to prompt you to confirm that you want to cancel a task. The default is /CONFIRM.

/DEVICE=device-name

Cancels tasks with the specified device name only. Device-name is the name of the terminal at which the task is running. You must end the device name with a colon (:). If you do not specify the /DEVICE qualifier, ACMS cancels the identified task on all available devices.

/IDENTIFIER=task-id

Cancels tasks with the specified task ID only. ACMS assigns a unique task ID to each task and to each task called by another task. If you do not specify the /IDENTIFIER qualifier, ACMS does not select tasks by ID to cancel. Refer to Chapter 12 for information about specifying a task ID.

/[NO]LOG

The /LOG qualifier causes ACMS to display a message indicating that a task has been canceled. The default is /NOLOG.

/SUBMITTER=submitter-id

Cancels tasks with the specified submitter ID only. ACMS assigns a unique submitter ID to each user who signs in to ACMS. Refer to Chapter 12 for information about specifying a submitter ID.

If you do not specify the /SUBMITTER qualifier, ACMS does not select tasks by submitter ID to cancel.

/USER=user-name

Cancels tasks having the specified user name only. There can be more than one user with the user name you specify. If you do not specify the /USER qualifier, ACMS does not select tasks by user name.

Notes

Without any qualifiers, the ACMS/CANCEL TASK command cancels all active tasks and prompts you to confirm each cancellation. If you use the /NOCONFIRM qualifier, ACMS cancels all task instances without prompting you.

In some situations, you can cancel more than one task instance with a single qualifier. For example, you can use the /APPLICATION, /IDENTIFIER, /SUBMITTER, or /USER qualifier to cancel all active instances of a task that have a particular application name, task ID, submitter ID, or user name.

Specifying more than one qualifier limits the scope of the command. For example, specifying the /APPLICATION=AVERTZ and /DEVICE=NL qualifiers on the same command line causes ACMS to cancel only tasks in the application AVERTZ that have the null device type (NL).

Examples

```
1. $ ACMS/CANCEL TASK/NOCONFIRM
Task Name: MON_TASK
Task ID: ODE::0001000D-0000001
Application: LAS_APPL User Name: TUTTLE
Submitter ID: ODE::0001000D Device: RTA8:
Called Task: MON_TASK_A
Task ID: ODE::0001000D-0000001-00000002
```

This command cancels each active task on the current node.

ACMS/CANCEL TASK

2. \$ ACMS/CANCEL TASK/DEVICE=TTH0:

```
Task Name: DELETE_ALL
Task ID:      ALLDAY::0001000D-00000001
Application:  ACCOUNT                      User Name:    COUNT
Submitter ID: ALLDAY::0001000D             Device:      TTH0:
Task ID:      ALLDAY::0001000D-00000001 (Y/[N]):Y
```

This command displays information about the task active at device TTH0 and prompts you to confirm whether or not to cancel the task. Here, the user canceled the task by typing the letter Y (for YES) in response to the (Y/[N]). If you do not want ACMS to prompt for confirmation, specify the /NOCONFIRM qualifier on the command line.

3. \$ ACMS/CANCEL TASK/NOCONFIRM/USER=ADAMS

This command cancels all tasks on a node submitted by a user with the user name ADAMS. Because the /NOCONFIRM qualifier was specified, ACMS does not prompt for confirmation before canceling the task.

4. \$ ACMS/CANCEL TASK/NOCONFIRM/SUBMITTER=10016

This command cancels all tasks submitted by a user whose ID is 10016.

5. \$ ACMS/CANCEL TASK/APPLICATION=MARKET

This command displays all active tasks that are a part of the application MARKET and prompts you to indicate whether or not you want to cancel each task.

6. \$ ACMS/CANCEL TASK/IDENTIFIER=WOW::00050012-00000003

This command cancels the task with the task ID WOW::00050012-00000003. ACMS also cancels all tasks called by the identified task.

7. \$ ACMS/CANCEL TASK/IDENTIFIER=WOW::00050012-00000003-00000001

This command cancels the task with the task ID WOW::00050012-00000003-00000001. Three fields in the task ID indicate that this task is a called task.

ACMS/CANCEL USER Command

Cancels a user by stopping all of the user's outstanding tasks and by signing the user out of ACMS.

Format

ACMS/CANCEL USER [user-name]

Command Qualifiers	Defaults
/[NO]CONFIRM	/CONFIRM
/DEVICE=device-name	All devices
/[NO]LOG	/NOLOG
/SUBMITTER=submitter-id	All submitters

Privileges Required

OpenVMS OPER privilege

Parameters

user-name

The user name of one or more users that you want to cancel. If you include a user name, ACMS cancels the users who are signed in to ACMS under the user name you provide. If you do not include a user name or any qualifiers, ACMS cancels all active users.

Qualifiers

/[NO]CONFIRM

The /CONFIRM qualifier causes ACMS to display information about each user selected to be canceled and prompts you to indicate whether or not you still want to cancel the user. The /NOCONFIRM qualifier tells ACMS not to prompt you for confirmation. The default is /CONFIRM.

/DEVICE=device-name

Cancels one or more users identified by device name. Device-name is the name of the terminal at which the user is logged in. You must end the device name with a colon (:). If you do not specify the /DEVICE qualifier, ACMS does not cancel users by device name.

/[NO]LOG

Controls whether or not ACMS displays a message after canceling a user. The /NOLOG qualifier is the default.

/SUBMITTER=submitter-id

Cancels the user identified by the specified submitter ID. ACMS assigns a unique submitter ID to each user who signs in to ACMS. Refer to Chapter 12 for information about specifying a submitter ID.

If you do not specify the /SUBMITTER qualifier, ACMS does not select users by submitter ID to cancel.

ACMS/CANCEL USER

Notes

The ACMS/CANCEL USER command also cancels tasks called by other tasks.

The ACMS/CANCEL USER command does not affect remote users. You can use only the ACMS/CANCEL USER command to cancel users on your current node. Use the ACMS/CANCEL TASK command to cancel tasks owned by remote users.

To determine a user name, submitter ID, or device name, specify the ACMS/SHOW USER command.

Examples

1. \$ ACMS/CANCEL USER

```
User Name:      ZEKE          Submitter ID:  BILBO::0001000D
Agent PID:     22000122      Device:        TTB1:
Submitter ID:  BILBO::0001000D (Y/[N]):N

User Name:      SIMONSAYS     Submitter ID:  BILBO::000200013
Agent PID:     22000122      Device:        TTH0:_
Submitter ID:  BILBO::000200013 (Y/[N]):N
```

This command displays information about all active users on the current node. Because the user responded by typing the letter N (for NO) at the confirmation prompt, the users ZEKE and SIMONSAYS are not canceled.

2. \$ ACMS/CANCEL USER ADAMS

```
User Name:      ADAMS         Submitter ID:  ALLDAY::0001000D
Agent PID:     00000055      Device ID:     TTH0:
Submitter ID:  ALLDAY::0001000D (Y/[N]):
```

This command displays information about a user ADAMS and prompts for confirmation before canceling. Type Y in response to the confirmation prompt to cancel the user. After you type Y, ACMS can display information about another user ADAMS, if there is one.

3. \$ ACMS/CANCEL USER/DEVICE=TTH0:

```
User Name:      ADAMS         Submitter ID:  ALLDAY::0001000D
Agent PID:     00000055      Device ID:     TTH0:
Submitter ID:  ALLDAY::0001000D (Y/[N]):
```

Because the /CONFIRM qualifier is the default, this command displays information about the user who is working at the TTH0 device and prompts you to confirm the cancellation. Type Y in response to the confirmation prompt to cancel user ADAMS.

4. \$ ACMS/CANCEL USER/SUBMITTER=1000D /LOG

```
User Name:      ADAMS         Submitter ID:  CARAT::0001000D
Agent PID:     22000122      Device ID:     TTC7:
Submitter ID:  CARAT::0001000D (Y/[N]):Y
%ACMSOPR-I-USERCANED, User ADAMS canceled
```

This command displays information about the task instance active for a user whose submitter ID is 0001000D, and cancels the user after you type Y at the confirmation prompt. The /LOG qualifier prints a message showing you that the cancellation attempt was successful. By default, you do not receive

a cancellation message. Refer to Chapter 12 for a complete description of submitter IDs.

ACMS/DEBUG Command

Starts the ACMS Task Debugger. This command allows you to test tasks and server procedures without building an entire ACMS application.

Format

ACMS/DEBUG [task-group name]

Command Qualifiers	Defaults
/AGENT_HANDLE	None
/PID	None
/SERVER	None
/TWS_POOLSIZ[=n]	1600 pagelets (Alpha and I64)
/TWSC_POOLSIZ[=n]	50 pagelets (Alpha and I64)
/WORKSPACE	None

Qualifiers

/AGENT_HANDLE

Allows you to submit calls to ACMS tasks from an agent program. The handle name for the agent program must be unique to the system on which you are debugging the task. To ensure that the agent handle is unique to the system, include the PID of the task debugger or the user name of the person doing the debugging in the /AGENT_HANDLE name.

/PID

Identifies the process ID (PID) for the server process to be debugged.

/SERVER

Allows you to debug procedure servers as they execute in the ACMS run-time environment. Using this command, you can observe the server process execution through the OpenVMS Debugger, and locate run-time programming or logic errors and other bugs.

/TWS_POOLSIZ

Allows you to specify the sizes of the temporary pools that task workspaces use when a task is started. When you start a task, the group and user workspaces the task uses, as well as system and task workspaces, are copied into temporary workspaces for use by the task. At any given time, the sum of all group, user, system, and task workspaces for all active tasks cannot exceed this number. Valid sizes are from 129 to 65,535 pagelets (Alpha). The default value is 1600 pagelets (Alpha and I64).

/TWSC_POOLSIZ

Controls the overall size of the pool used to store information needed to allocate the task instance workspaces stored in the TWS_POOLSIZ pool. Valid sizes are from 9 to 63 pagelets (Alpha and I64). The default value is 50 pagelets (Alpha and I64).

/WORKSPACE

Allows the examination of workspaces during exchange steps, the action part of processing steps, or at the beginning or end of a task. If it is not specified, workspaces can be examined only when a task is running a server.

Privileges Required

None

Notes

If you specify a value between 0 and 129 for `/TWS_POOLSIZ`, or a value for `TWSC_POOLSIZ` that is between 0 and 9, ACMS overrides the value and sets them to the minimum required values (129 or 9, respectively). Then before starting the task debugger, ACMS notifies the user that the change has been made. If you specify a value less than 0 for either pool size, ACMS returns an error message.

If you invoke `ACMS/DEBUG/SERVER` using the process name for a server process that has a UIC group number different from the invoking user's process UIC group number, you receive the following error:

```
%ACMSOPR-E-DBGSERERR, Error during DEBUG/SERVER
-ACMSOPS-W-NOSUCHSER, Specified server does not exist
%ACMSOPR-E-ERROR, Some operations may not have been performed
```

To correct this problem, use the process PID to access the server process.

Examples

1. `$ ACMS/DEBUG VR_TASK_GROUP/WORKSPACE`

This command instructs the ACMS Task Debugger to debug tasks in the task group database file `VR_TASK_GROUP`. The command also allows you to examine and deposit data in workspaces.

2. `$ ACMS/DEBUG/SERVER ACMS000SP001000`

This command starts the debugger for the server process name `ACMS000SP001000`.

3. `$ ACMS/DEBUG/TWSC_POOLSIZ=30/TWS_POOLSIZ=500 VR_TASK_GROUP`

This command instructs the ACMS Task Debugger to debug tasks in the task group database file `VR_TASK_GROUP`. In addition, the command overrides the default values of `TWSC_POOLSIZ` and `TWS_POOLSIZ` for this session.

ACMS/ENTER Command

Allows a terminal that has logged in to OpenVMS to use the ACMS menu system.

Format

ACMS/ENTER

Command Qualifier	Default
/[NO]RETURN	/RETURN

Privileges Required

None

Qualifiers

/[NO]RETURN

If you specify the `/RETURN` qualifier, your DCL process waits until you exit from ACMS. When you exit from ACMS, you are returned to your DCL process.

If you specify the `/NORETURN` qualifier, your DCL process is deleted once you enter the ACMS menu system. Once you exit from ACMS, you are logged out. The default is `/RETURN`.

Notes

Both the ACMS system and the Terminal Subsystem Controller (TSC) must be started before a user can enter the ACMS menu system.

Your terminal must be authorized in the ACMS device definition file for you to enter the ACMS menu system. See Chapter 2 for information on authorizing devices with the Device Definition Utility (DDU).

You cannot issue an ACMS/ENTER command from a DCL server unless the task was selected from a user-written agent. Doing so can cause parts of the Terminal Subsystem Controller (TSC) to fail and can sign other users out of ACMS. Components within the ACMS terminal subsystem maintain databases based on terminal names. When you issue a second ACMS/ENTER command, various errors can occur in the ACMS Command Process (CP) and TSC, including process termination.

Examples

1. `$ ACMS/ENTER`

This command places you in the ACMS menu system. When you exit from ACMS, you are returned to DCL command level.

2. `$ ACMS/ENTER/NORETURN`

This command places you in the ACMS menu system. When you exit from ACMS, you are logged out.

ACMS/INSTALL Command

Installs an application in ACMS\$DIRECTORY or removes an application database file from ACMS\$DIRECTORY.

Format

ACMS/INSTALL file-spec

Command Qualifier	Default
/[NO]REMOVE	/NOREMOVE

Privileges Required

Application Authorization Utility (AAU) authorization.

Parameters

file-spec

The file specification of an application database file to be moved to or removed from ACMS\$DIRECTORY. The application database file must have a file type of .ADB.

If the file is to be moved into ACMS\$DIRECTORY, the file specification can be any valid RMS file specification or logical name. If it is a logical name that is a search list, only the first translation in the search list is used. When you omit the device and directory, ACMS looks for the application database file in your default directory. The default file type is .ADB.

If the file is to be removed from ACMS\$DIRECTORY, specify the /REMOVE qualifier and the file name of the application. Do not specify a node, device, directory, or file type, or you receive an error.

Qualifiers

/[NO]REMOVE

The /REMOVE qualifier indicates that you want to delete the specified application from ACMS\$DIRECTORY. The default is /NOREMOVE.

Notes

You can install or delete only one application database file at a time. ACMS displays a message telling you when an application database file is successfully installed.

You do not need to install applications every time you start your ACMS system. This differs from the way you use OpenVMS INSTALL and some other ACMS operator commands.

The ACMS/INSTALL command does not support search lists.

ACMS/INSTALL

Examples

1.

```
$ ACMS/INSTALL APPL$:EMPLAPP.ADB
Application Database File APPL$:EMPLAPP.ADB Installed -
in ACMS$DIRECTORY
```

This command searches for the file EMPLAPP.ADB on the disk and directory identified by the logical name APPL\$, checks the application database file against the application authorization in the ACMSAAF.DAT file, and installs the application database file in ACMS\$DIRECTORY. ACMS displays a message when it has successfully installed the application database file.

2.

```
$ ACMS/INSTALL EMPLAPP /REMOVE
Application Database File EMPLAPP Removed from ACMS$DIRECTORY
```

Because it includes the /REMOVE qualifier, this command deletes the application database file EMPLAPP from ACMS\$DIRECTORY. Only the application file name is specified. ACMS displays a message when it has successfully deleted the application database file.

3.

```
$ ACMS/INSTALL EMPLAPP.ADB
Application Database File APPL$:EMPLAPP.ADB Installed -
in ACMS$DIRECTORY
```

Because this command does not include a device or directory with the file specification, the ACMS/INSTALL command searches your default directory. ACMS displays a message when it has successfully located and installed the application database file.

ACMS/MODIFY APPLICATION Command

Modifies the attributes of an active application.

Format

ACMS/MODIFY APPLICATION [application-name[,...]]

Command Qualifiers	Defaults
/APPLICATION_ATTRIBUTES=(attribute[,...])	None
/[NO]CONFIRM	/CONFIRM
/[NO]LOG	/NOLOG
/SERVER_ATTRIBUTES=(attribute[,...])	None
/TASK_ATTRIBUTES=(attribute[,...])	None

Privileges Required

OpenVMS OPER privilege

Parameters

application-name

The name of the active application that you want to modify. If you do not supply an application name, all applications are modified with the attributes you specify. You can specify more than one application name by separating each name with a comma (,).

Qualifiers

/APPLICATION_ATTRIBUTES=(attribute[,...])

Modifies an attribute of the active application. The attribute argument specifies the attribute you want to modify. Specify more than one attribute by separating the attributes with a comma (,) and enclosing them in parentheses.

You can specify one or more of the following attributes:

- [NO]AUDIT
Enables or disables application level auditing within the specified application.
- MAX_INSTANCE=n
Specifies the maximum number of tasks that can execute simultaneously within the specified application. You can specify an integer from 0 through 65535.
- MAX_PROCESS=n
Specifies the maximum number of server processes that can be active simultaneously within the specified application. You can specify an integer from 0 through 65535.
- MONITOR_INTERVAL=n
Specifies the server process monitoring interval. The server process monitoring interval is the interval at which ACMS checks servers to see if new processes are needed, or extra processes need to be deleted. You can specify 0 through 65535 seconds.

ACMS/MODIFY APPLICATION

/[NO]CONFIRM

This qualifier determines whether or not ACMS displays each application selected for modification and prompts you for confirmation before making the modifications. The default is /CONFIRM.

/[NO]LOG

This qualifier determines whether or not ACMS displays information level status messages generated by the modify request. The default is /NOLOG.

/SERVER_ATTRIBUTES=(attribute[,...])

Modifies an attribute of a server in the specified application. The attribute argument specifies the attribute you want to modify. Specify more than one attribute by separating the attributes with a comma (,) and enclosing them in parentheses.

The /SERVER_ATTRIBUTES qualifier is a repeating qualifier. This means that you can specify the /SERVER_ATTRIBUTES qualifier more than once on the same command.

You can specify one or more of the following attributes:

- **NAME=(server-name[,...])**
Identifies the server to be modified in the specified application. If you specify the /SERVER_ATTRIBUTES qualifier but do not specify the NAME attribute, ACMS modifies all servers in the selected application. Specify more than one server name by separating the server names with a comma (,) and enclosing them in parentheses.
- **[NO]AUDIT**
Enables or disables server-level auditing within the specified application.
- **CREATION=DELAY=n**
 =INTERVAL=n
 =(DELAY=n,INTERVAL=n)
Adjusts the creation delay time, the creation interval time, or both. Creation delay time is the amount of time ACMS waits for busy servers to become free before creating a new server to handle a demand. Once ACMS creates a new server, creation interval is the amount of time ACMS waits before creating another new server. You can specify 0 through 65535 seconds.
- **DELETION=DELAY=n**
 =INTERVAL=n
 =(DELAY=n,INTERVAL=n)
Adjusts the deletion delay time, the deletion interval time, or both. Deletion delay time is the amount of time ACMS allows a server to be free before deleting a server. Deletion interval is the amount of time ACMS waits after deleting one free server before deleting another. You can specify 0 through 65535 seconds.
- **[NO]PROCESS_DUMPS**
PROCESS_DUMPS dynamically enables server process dumping for servers within the specified application. NOPROCESS_DUMPS disables server process dumping.
- **MAX_PROCESS=n**
Specifies the maximum number of server processes allowed for the specified server. You can specify an integer from 0 through 65535.

- **MIN_PROCESS=n**
Specifies the minimum number of server processes required for the specified server. You can specify an integer from 0 through 65535.

/TASK_ATTRIBUTES=(attribute[,...])

Modifies the attributes of the specified task. The attribute argument specifies the attribute you want to modify. Specify more than one attribute by separating the attributes with a comma (,) and enclosing them in parentheses.

The **/TASK_ATTRIBUTES** qualifier is a repeating qualifier. This means you can specify the **/TASK_ATTRIBUTES** qualifier more than once on the same command.

You can specify one or more of the following attributes:

- **NAME=(task-name[,...])**
Specifies the name of a task within the specified application whose attributes you want to modify. If you do not specify the **NAME** attribute, all tasks are modified within the selected application with whatever attributes you specify.
- **[NO]AUDIT**
Enables or disables task-level auditing within the specified application.
- **ENABLE**
Enables specific tasks within the specified application.
- **DISABLE**
Disables specific tasks within the specified application.
- **TRANSACTION_TIMEOUT=(seconds)**
Specifies a transaction timeout value for a task or tasks in the specified application.
- **NOTRANSACTION_TIMEOUT**
Specifies that there be no transaction timeout value for a task or tasks in the specified application.

Notes

When you specify the **ACMS/MODIFY APPLICATION** command, parameters are only modified within the current active application. If the application is stopped and restarted, the parameters are reset to the values specified in the application definition. If you want a modification to be permanent, you must modify the application definition.

Examples

1.

```
$ ACMS/MODIFY APPLICATION TEST /APPLICATION_ATTRIBUTES=(NOAUDIT, -  
_ $ MAX_INSTANCE=3)  
Apply Modifications to Application TEST (Y/[N]):
```

This command disables audit trail logging for the application and allows a maximum of three tasks to execute within the **TEST** application at any given time. **ACMS** displays the confirmation prompt before executing this command.

ACMS/MODIFY APPLICATION

- ```
$ ACMS/MODIFY APPLICATION DATADAT -
_ $ /SERVER_ATTRIBUTES=(NAME=(SERVER_1880,SERVER_1776), -
_ $ MAX_PROCESS=5,MIN_PROCESS=1) -
_ $ /SERVER_ATTRIBUTES=(NAME=SERVER_ODCE, -
_ $ MAX_PROCESS=10,MIN_PROCESS=3)
Apply Modifications to Application DATADAT (Y/[N]):
```

This command modifies the application DATADAT, setting the maximum processes allowed for servers SERVER\_1880 and SERVER\_1776 to 5 and the minimum processes required to 1. This command also modifies the attributes of server SERVER\_ODCE, setting the maximum processes allowed to 10 and the minimum processes required to 3. Because /CONFIRM is the default, ACMS prompts you before executing this command.

- ```
$ ACMS/MODIFY APPLICATION POST_REQ -
_ $ /SERVER_ATTRIBUTES=(NAME=SERVER_10,CREATION= -
_ $ (DELAY=10,INTERVAL=30)) -
_ $ /NOCONFIRM
```

This command modifies application POST_REQ, causing ACMS to wait 10 seconds for an instance of SERVER_10 to become free before creating a new server process. Once a new server is created, ACMS must wait 30 seconds before creating another new server.

- ```
$ ACMS/MODIFY APPLICATION NEWAPPL -
_ $ /TASK_ATTRIBUTES=(NAME=(DTSK,FTSK),DISABLE) -
_ $ /TASK_ATTRIBUTES=(NAME=NEWTSK,ENABLE) /NOCONFIRM
```

This command modifies the application NEWAPPL, disabling the tasks DTSK and FTSK and enabling the task NEWTSK.

---

## ACMS/REPLACE SERVER Command

Replaces a server image with a new version of that image. All subsequent tasks use the new image.

### Format

ACMS/REPLACE SERVER [ server-name[,...]]

| Command Qualifiers            | Defaults |
|-------------------------------|----------|
| /APPLICATION=application-name | See text |
| /[NO]CONFIRM                  | /CONFIRM |
| /[NO]LOG                      | /NOLOG   |

### Privileges Required

OpenVMS OPER privilege

### Parameters

#### server-name

The name of the server you want to replace. The server name is defined in the application definition. If you do not specify a server name, ACMS replaces all servers.

### Qualifiers

#### /APPLICATION=application-name

Causes ACMS to replace server images only in the application you specify. Specify the application file name only; do not include node, device, or directory.

When you specify an application name with the /APPLICATION qualifier, ACMS searches for the server name in the application you specify. If you specify the /APPLICATION qualifier but do not specify a server name, ACMS searches for all servers in the application. If you do not specify the /APPLICATION qualifier, ACMS searches for the server name in all applications on the node.

#### /[NO]CONFIRM

The /CONFIRM qualifier causes ACMS to display each server selected for replacement and prompt you to indicate whether or not you want to replace the server. The /NOCONFIRM qualifier causes ACMS not to prompt you for confirmation. The default is /CONFIRM.

#### /[NO]LOG

Controls whether or not ACMS displays a message after replacing a server. The /NOLOG qualifier is the default.

### Notes

When the application controller receives the ACMS/REPLACE SERVER command, it runs down all free server processes for the specified server and requests all active servers to run down when they are free. A server retaining context does not run down until the context has been released. New server processes are created to meet the minimum and maximum server process requirements of the application. If a server image is active or still executing, ACMS replaces it with the new version once it stops executing or is aborted.

## ACMS/REPLACE SERVER

If a server image does not stop because of an infinite loop, use the command `ACMS/SHOW SERVER` to determine the server process ID. To stop the server process, use one of the following:

- Use the DCL command `STOP/ID` to cancel the server process. However, `STOP/ID` may have adverse effects on the application. For example, if ACMS is using Rdb, `STOP/ID` cancels the server process without the database recovery associated with normal rundown.
- Use the OpenVMS `FORCEX` system service. This allows normal recovery of data. However, you must write a small program to use `FORCEX`.
- Use the `ACMS/CANCEL TASK` command to cancel the task that the server is running.
- Use the `ACMS/STOP APPLICATION/CANCEL` command. However, this command stops all occurrences of all servers in the application.

You cannot replace a DCL server because the image executed is supplied by HP. It is not customer modifiable.

See Chapter 9 for more information about this command.

If you use the `ACMS/REPLACE SERVER` command to replace a server when an application is not fully started, then EXC logs the following error message in SWL:

```
%ACMSI-E-BADSTATE, Internal Error: invalid state 00000006
```

### Examples

1. `$ ACMS/REPLACE SERVER MYSERV/NOCONFIRM`

This command replaces the server image for the server `MYSERV` with a new version of that image in all applications.

2. `$ ACMS/REPLACE SERVER MYSERV/APPLICATION=TESTALL/NOCONFIRM`

This command replaces the server image for the server `MYSERV` in the application `TESTALL` with a new version of that image.

---

## ACMS/REPROCESS APPLICATION\_SPEC Command

Causes ACMS to retranslate the application specification for an application and redirect all subsequent task selections to the application pointed to by the application specification.

### Format

ACMS/REPROCESS APPLICATION\_SPEC application-spec

| Command Qualifiers | Defaults |
|--------------------|----------|
| /[NO]CONFIRM       | /CONFIRM |
| /[NO]LOG           | /NOLOG   |

### Privileges Required

OpenVMS OPER privilege

### Parameters

#### application-spec

The application specification for an application. It can be a logical name or a search list of application database files. If the application specification is a search list, the first available application in the search list is used.

The search list can contain an application that resides on a remote node. If the file resides on a remote node, you must specify the remote node name in the search list. The following is an example of a search list defined as the logical name PAYROLL:

```
$ DEFINE/SYSTEM PAYROLL BIGAPPL::PAYROLL, FASTAPPL::PAYROLL, -
_ $ BACKUP::PAYROLL
```

You cannot specify access control strings in an application specification. See Chapter 6 for more information on application specifications.

### Qualifiers

#### /[NO]CONFIRM

The /CONFIRM qualifier causes ACMS to prompt you for confirmation before reprocessing the application specification. The /NOCONFIRM qualifier causes ACMS not to prompt you for confirmation before performing the reprocess. The default is /CONFIRM.

#### /[NO]LOG

Controls whether or not ACMS displays a message after translating the application specification. The /NOLOG qualifier is the default.

### Notes

The ACMS/REPROCESS APPLICATION\_SPEC command can be used to failover to applications. If a search list is used for an application specification, automatic failover occurs in the event of a system failure. Use the ACMS/REPROCESS APPLICATION\_SPEC command to failover to the original application when it becomes available.

## ACMS/REPROCESS APPLICATION\_SPEC

The ACMS/REPROCESS APPLICATION\_SPEC command is not supported if, on a single submitter node, you have two application specification logical names that point to two differently ordered search lists containing the same application names.

### Example

```
$ ACMS/REPROCESS APPLICATION_SPEC PAYROLL
```

This example causes ACMS to retranslate the search list for the logical name PAYROLL. ACMS uses the first available application in the search list.



---

## ACMS/RESET AUDIT Command

Resets the ACMS Audit Trail Logger, causing the ACMS audit trail log file to be closed and a new log file to be opened.

### Format

ACMS/RESET AUDIT

### Privileges Required

OpenVMS OPER privilege

### Notes

If the Audit Trail Logger process has stopped, the ACMS/RESET AUDIT command restarts the process.

Starting ACMS creates a new version of the audit trail log file.

The logical name ACMS\$AUDIT\_LOG points to the ACMS audit trail log file. ACMS\$AUDIT\_LOG is defined during system startup with auditing enabled and when audit trail logging is enabled with the ACMS/SET SYSTEM /AUDIT command.

If the logical name ACMS\$AUDIT\_LOG is already defined when you execute the ACMS/RESET AUDIT command, ACMS creates a new version of the file using its equivalence name string. If the logical ACMS\$AUDIT\_LOG is not defined, ACMS creates the file SYS\$ERRORLOG:ACMSAUDIT.LOG. For more information about the Audit Trail Logger and the audit trail log file, see Chapter 12.

### Example

```
$ ACMS/RESET AUDIT
```

This command creates a new version of the Audit Trail Logger.

## ACMS/RESET TERMINALS

---

### ACMS/RESET TERMINALS Command

Causes ACMS to read the DDU database file and authorize any new controlled terminals as well as release any terminals that are no longer authorized.

#### Format

ACMS/RESET TERMINALS

#### Privileges Required

OpenVMS OPER privilege

#### Notes

The TSC must be started before you can use the ACMS/RESET TERMINALS command. The ACMS/RESET TERMINALS command only affects terminals controlled by the TSC. No current terminal user is affected.

If you assign the AUTOLOGIN or CONTROLLED sign-in characteristics to a terminal, ACMS reads the new characteristic only when you:

- Issue the ACMS/RESET TERMINALS command
- Issue an ACMS/START TERMINALS command or an ACMS/START SYSTEM command that starts the TSC

If a terminal that was previously assigned the NOT CONTROLLED characteristic is assigned the CONTROLLED characteristic, ACMS checks to see if that terminal is currently using the ACMS menu interface. If it is, ACMS designates the terminal as controlled so it is not released when the user signs out. If the terminal is not using the ACMS menu interface, the TSC allocates that terminal.

Conversely, if a terminal that was previously assigned the CONTROLLED characteristic is now assigned the NOT CONTROLLED characteristic, ACMS checks to see if that terminal is currently using the ACMS menu interface. If it is, ACMS designates the terminal as not controlled and releases the terminal when the user signs out. If the terminal is not using the ACMS menu interface, the TSC deallocates that terminal. Once deallocated, the terminal can be used to sign in normally.

For more information about sign-in characteristics for terminals, see Chapter 2.

#### Example

```
$ ACMS/RESET TERMINALS
```

This command makes available to ACMS any terminals recently assigned the CONTROLLED characteristic. Terminals defined with the CONTROLLED characteristic sign directly in to ACMS when users type an OpenVMS login sequence.

---

## ACMS/SET QUEUE Command

Sets the processing characteristics of a started task queue. The processing characteristics are used by the Queued Task Initiator (QTI).

### Format

ACMS/SET QUEUE queue-name[,...]

| Command Qualifier | Default         |
|-------------------|-----------------|
| /TASK_THREADS=n   | /TASK_THREADS=1 |

### Privileges Required

OpenVMS OPER privilege

### Parameters

#### queue-name

The name of the queue for which you want to set processing characteristics.

### Qualifiers

#### /TASK\_THREADS=n

Specifies the number of concurrent outstanding tasks that the QTI processes for the specified queue. Here, n indicates a value from 1 through 255. Normally, a relatively low number (1 through 5) is sufficient to achieve maximum throughput of the queue.

The /TASK\_THREADS qualifier is a positional qualifier. If you position the /TASK\_THREADS qualifier between the ACMS/SET QUEUE command and the queue names, all queue names are affected. To have the /TASK\_THREADS qualifier apply to an individual queue name in a list of queue names, place the qualifier directly after the queue name. See the examples section for examples of using this qualifier. The default is /TASK\_THREADS=1.

### Notes

None

### Examples

1. \$ ACMS/SET QUEUE NEWQ

This command sets to one the maximum number of concurrent outstanding tasks for queue NEWQ.

2. \$ ACMS/SET/TASK\_THREADS=5 QUEUE QUE1,QUE2

This command limits the number of concurrent outstanding tasks to five for queues QUE1 and QUE2.

3. \$ ACMS/SET QUEUE/TASK\_THREADS=5 QUE1,QUE3,QUE4, QUE2 /TASK\_THREADS=3

This command limits the number of concurrent outstanding tasks to five for queues QUE1, QUE3, and QUE4 and to three for queue QUE2.

---

### ACMS/SET SYSTEM Command

Depending on the qualifiers used, enables or disables audit trail logging, or enables or disables ACMS operator terminals.

#### Format

ACMS/SET SYSTEM

| Command Qualifiers    | Defaults        |
|-----------------------|-----------------|
| /[NO]AUDIT            | Current setting |
| /[NO]OPERATOR         | Current setting |
| /PROCESS              | Current setting |
| /TERMINAL=device-name | Current setting |

#### Privileges Required

OpenVMS OPER privilege

#### Qualifiers

##### **/[NO]AUDIT**

The /AUDIT qualifier starts the Audit Trail Logger and enables systemwide auditing. The /NOAUDIT qualifier stops systemwide auditing. If you do not specify this qualifier, systemwide auditing is not affected.

##### **/[NO]OPERATOR**

Enables or disables the terminals identified by the /PROCESS qualifier or /TERMINAL qualifier as ACMS operator terminals. When you specify the /OPERATOR or /NOOPERATOR qualifier, you must also specify either the /PROCESS or the /TERMINAL qualifier. If you do not specify this qualifier, ACMS terminals are not affected.

##### **/PROCESS**

If you specify the /OPERATOR qualifier, the /PROCESS qualifier enables your terminal as an ACMS operator terminal for as long as your current process is active. If you specify the /NOOPERATOR qualifier, the /PROCESS qualifier disables your terminal as an ACMS operator terminal.

You must specify either the /OPERATOR or /NOOPERATOR qualifier when you use the /PROCESS qualifier. If you do not specify this qualifier, ACMS terminals are not affected.

##### **/TERMINAL=(device-name[,...])**

If you specify the /OPERATOR qualifier, the /TERMINAL qualifier identifies one or more terminals as an ACMS operator terminal (for as long as ACMS is active). If you specify the /NOOPERATOR qualifier, the /TERMINAL qualifier disables one or more terminals as an ACMS terminal. If you specify more than one device name, separate the device names with commas and enclose them in parentheses. A colon (:) in the device name is not required.

You must specify either the /OPERATOR or /NOOPERATOR qualifier with the /TERMINAL qualifier. If you do not specify this qualifier, ACMS terminals are not affected.

## Notes

If an application fails, or if the Audit Trail Logger or TSC stops abnormally, ACMS sends a message to ACMS operator terminals to inform you.

You cannot use the /[NO]PROCESS qualifier for a batch job.

## Examples

1. `$ ACMS/SET SYSTEM/PROCESS/OPERATOR`

This command enables your terminal as an ACMS operator terminal for the duration of your process or until ACMS stops.

2. `$ ACMS/SET SYSTEM/TERMINAL=(TTE2,TTE3)/OPERATOR`

This command enables terminals TTE2 and TTE3 as ACMS operator terminals for as long as ACMS is active.

3. `$ ACMS/SET SYSTEM/TERMINAL=TTE2/NOOPERATOR`

This command disables terminal TTE2 as an ACMS operator terminal.

4. `$ ACMS/SET SYSTEM/AUDIT`

This command enables the Audit Trail Logger. Use this command to reenables the Audit Trail Logger after you have disabled it.

## ACMS/SHOW APPLICATION

---

### ACMS/SHOW APPLICATION Command

Displays information about one or more active ACMS applications in static mode. See the ACMS/SHOW APPLICATION/CONTINUOUS command if you want to display an application in continuous mode.

#### Format

```
ACMS/SHOW APPLICATION [application-name[,...]]
```

#### Command Qualifiers

```
/CONNECTIONS
/DETACHED_TASKS
/POOL
/SERVER_ATTRIBUTES[=(server-name[,...])]
/TASK_ATTRIBUTES[=(task-name[,...])]
```

#### Defaults

```
No connection information displayed
No detached task information displayed
No pool information displayed
No server attributes displayed
No task attributes displayed
```

#### Privileges Required

None

#### Parameters

##### **application-name**

The file name of the application you want to display information about. Specify only the file name of the application; do not include device, directory, or file type. If you do not include an application name, ACMS displays information about all active applications. Specify more than one application name by separating the application names with a comma (,).

#### Qualifiers

##### **/CONNECTIONS**

Displays the local and remote users who are connected to the application.

##### **/DETACHED\_TASKS**

Displays information about all detached tasks that are started and have not completed.

##### **/POOL**

Displays information on pool size and available pool space for an application. If you do not specify the /POOL qualifier, no pool information is displayed. If you specify the /POOL qualifier but do not supply an application name, pool information is displayed for all active applications.

##### **/SERVER\_ATTRIBUTES[=(server-name[,...])]**

Displays the current settings of modifiable server attributes for the specified application. If you specify a server name, ACMS displays the current values of server attributes for the specified server only. Specify more than one server name by separating the server names with a comma (,) and enclosing them in parentheses. If you do not specify a server name, ACMS displays the server attributes for all servers in the specified application.

You can display the settings of the following server attributes:

- Whether server audit logging is enabled or disabled

## ACMS/SHOW APPLICATION

- The delay time for server creation and deletion
- The interval time for server creation and deletion
- The maximum number of server processes allowed
- The minimum number of server processes allowed
- Whether server process dumps are enabled or disabled

Modify server attributes with the ACMS/MODIFY APPLICATION/SERVER\_ATTRIBUTES command.

### **/TASK\_ATTRIBUTES[=(task-name[,...])]**

Displays the current settings of modifiable task attributes for the specified application. If you specify a task name, ACMS displays the task attributes for the specified task only. Specify more than one task name by separating the task names with a comma (,) and enclosing them in parentheses. If you do not specify a task name, ACMS displays task attributes for all tasks in the specified application.

You can display the settings of the following task attributes:

- Whether task-level audit logging is enabled or disabled
- Whether a task is designated as enabled or disabled
- Whether or not DECdtm transaction timeout is set for a task, and at what interval if set

Modify task attributes with the ACMS/MODIFY APPLICATION/TASK\_ATTRIBUTES command.

## Notes

If you specify an application that is not active, ACMS returns an error.

The ACMS/SHOW APPLICATION command with no qualifiers displays information that is useful in determining the optimal values for maximum server processes and minimal server processes.

You can use the pool information displayed when you use the /POOL qualifier to set the ACMSGEN workspace and control pool sizes. See Chapter 11 for more information on adjusting the pool size for your system.

## Examples

```
1. $ ACMS/SHOW APPLICATION
ACMS V4.0 CURRENT APPLICATIONS Time: 5-MAY-1994 13:34:56.41

Application Name: TIME_TEST State: STARTED

 Object Name: ACMS01EXC001000
 User Name: NOMIS PID: 22000123
 Max Task Count: 120 Max SP Count: 150
 Cur Task Count: 2 Cur SP Count: 1
 Auditing: OFF SP Mon. Interval: 5

Server Name max SPs min SPs active free waiting
 SPS SPS SPS SPS tasks
LAS_SRVR 1 0 1 0 1

Application Name: SANDAPPL State: STARTED
```

## ACMS/SHOW APPLICATION

```
Object Name: ACMS01EXC003000
User Name: EDLOD PID: 2200047C
Max Task Count: 65535 Max SP Count: 150
Cur Task Count: 0 Cur SP Count: 0
Auditing: OFF SP Mon Interval: 20

Server Name max SPs min SPs active free waiting
 SPs SPs SPs SPs tasks
SANDSRV 5 0 0 0 0
```

This example displays server and task information for all applications started on the local node.

```
2. $ ACMS/SHOW APPLICATION QUALITY/SERVER_ATTRIBUTES=(NAME=LAS_SRVR) -
 _$ /TASK_ATTRIBUTES

ACMS V4.0 CURRENT APPLICATIONS Time: 5-MAY-1994 13:34:56.41

Application Name: QUALITY State: STARTED

Object Name: ACMS01EXC001000
User Name: NOMIS PID: 22000123
Max Task Count: 123 Max SP Count: 150
Cur Task Count: 1 Cur SP Count: 1
Auditing: OFF SP Mon. Interval: 10
----- SERVER ATTRIBUTES -----
Server Name: LAS_SRVR
Max. SPs: 1 Min SPs: 0
Creation Delay: 5 Creation Interval: 2
Deletion Delay: 15 Deletion Interval: 5
Auditing: ON Process Dumps: OFF
----- TASK ATTRIBUTES -----
Task Name: LAS_TASK1
Status: ENABLED Auditing: ON
Transaction Timeout: NO TIME LIMIT
Task Name: LAS_TASK2
Status: DISABLED Auditing: OFF
Transaction Timeout: 30
```

This example displays the modifiable server attributes for server LAS\_SRVR in the application QUALITY. See Chapter 9 for a description of the fields in this display.

```
3. $ ACMS/SHOW APPLICATION/POOL TEST
ACMS V4.0 CURRENT APPLICATIONS Time: 20-MAY-1994 11:21:04.50

Application Name: TEST State: STARTED

Object Name: ACMS01EXC008000
User Name: WAYNE PID: 25C01337
Max Task Count: 65535 Max SP Count: 5
Cur Task Count: 0 Cur SP Count: 2
Auditing: ON SP Mon. Interval: 5

Application Workspace and Control Pools
```



## ACMS/SHOW APPLICATION

| Pool type                  | Pool size | Free bytes | (pct.) | Largest block | Allocation failures | Garbage collections |
|----------------------------|-----------|------------|--------|---------------|---------------------|---------------------|
| Group/User workspace pools |           |            |        |               |                     |                     |
| Control pool               | 65536     | 64848      | (98%)  | 32768         | 0                   | 0                   |
| Workspace pool             | 131072    | 130560     | (99%)  | 65536         | 0                   | 0                   |
| TEST_GRP01                 |           |            |        |               |                     |                     |
| Control pool               | 25600     | 25088      | (98%)  | 16384         | 0                   | 0                   |
| Workspace pool             | 179200    | 178688     | (99%)  | 65536         | 0                   | 0                   |
| TEST_GRP02                 |           |            |        |               |                     |                     |
| Control pool               | 25600     | 25088      | (98%)  | 16384         | 0                   | 0                   |
| Workspace pool             | 179200    | 178688     | (99%)  | 65536         | 0                   | 0                   |
| DBMS_GRP                   |           |            |        |               |                     |                     |
| Control pool               | 25600     | 25088      | (98%)  | 16384         | 0                   | 0                   |
| Workspace pool             | 179200    | 178688     | (99%)  | 65536         | 0                   | 0                   |
| TEST_GRP10                 |           |            |        |               |                     |                     |
| Control pool               | 25600     | 25088      | (98%)  | 16384         | 0                   | 0                   |
| Workspace pool             | 179200    | 178688     | (99%)  | 65536         | 0                   | 0                   |
| TEST_GRP_LANG              |           |            |        |               |                     |                     |
| Control pool               | 25600     | 25088      | (98%)  | 16384         | 0                   | 0                   |
| Workspace pool             | 179200    | 178688     | (99%)  | 65536         | 0                   | 0                   |

This example displays poolsize information for the application TEST. See Chapter 9 for a description of the fields in this display.

#### 4. \$ ACMS/SHOW APPLICATION/CONNECTIONS

ACMS V4.0      CURRENT APPLICATIONS      Time: 23-APR-1994 10:50:42.95

Application Name: PACCARE\_APPL      State: STARTED

| User Name | Submitter ID     | Agent PID  | Device   |
|-----------|------------------|------------|----------|
| SMITH     | MYNODE::00030035 | 22400104   | TWA3:    |
| ACMS_TEST | YRNODE::023B0004 | (YRNODE::) | LTA5006: |
| ACMS_TEST | YRNODE::00B60013 | (YRNODE::) | LTA5014: |

Application Name: EMPLOYEE\_INFO\_APPLICATION      State: STARTED

| User Name | Submitter ID     | Agent PID  | Device   |
|-----------|------------------|------------|----------|
| ACMS_TEST | YRNODE::00B60013 | (YRNODE::) | LTA5014: |
| ACMS_TEST | YRNODE::023B0004 | (YRNODE::) | LTA5006: |
| SMITH     | MYNODE::00030035 | 22400104   | TWA3:    |

Application Name: EMPLOYEE\_INFO\_APPL\_RTS      State: STARTED

There are no users connected to this application

This command displays information about all users connected to applications PACCARE\_APPL and EMPLOYEE\_INFO\_APPLICATION. There are no users connected to the application EMPLOYEE\_INFO\_APPL\_RTS.

#### 5. \$ ACMS/SHOW APPLICATION/DETACHED\_TASKS DIST\_APPL

ACMS V4.0      CURRENT APPLICATIONS      Time: 23-APR-1994 09:58:20.65

Application Name: DIST\_APPL      State: STARTED

|                   |                  |              |       |
|-------------------|------------------|--------------|-------|
| Task Name:        | DEQUEUE_TASK     |              |       |
| Task State:       | Active           |              |       |
| Submitter ID:     | YRNODE::00020016 | Username:    | JONES |
| Retry Limit:      | 10               | Retry Count: | 2     |
| Retry Wait Timer: | 60               |              |       |

## ACMS/SHOW APPLICATION

```
Task Name: UPDATE_CENTRAL_TASK
Task State: Waiting to Retry
Submitter ID: YRNODE::00020017 Username: SMITH
Retry Limit: 10 Retry Count: 0
Retry Wait Timer: 60
```

This example shows that the detached tasks DEQUEUE\_TASK and UPDATE\_CENTRAL\_TASK in the application DIST\_APPL are started. The task DEQUEUE\_TASK is currently active and has retried two times. The task UPDATE\_CENTRAL\_TASK is waiting to retry. Both tasks wait 60 seconds before retrying, and both tasks have a retry limit of 10.

---

## ACMS/SHOW APPLICATION/CONTINUOUS Command

Displays information about an active ACMS application in continuous refresh mode.

### Format

ACMS/SHOW APPLICATION/CONTINUOUS application-name

| Command Qualifiers       | Defaults          |
|--------------------------|-------------------|
| /[NO]BEGINNING_TIME=time | /NOBEGINNING_TIME |
| /[NO]ENDING_TIME=time    | /NOENDING_TIME    |
| /[NO]INTERVAL[=seconds]  | /NOINTERVAL       |
| /[NO]OUTPUT[=file-spec]  | /NOOUTPUT         |

### Required Privileges

None

### Parameters

#### **application-name**

The file name of an application that you want to display information about. Specify only the file name of an application database file; do not include a device, directory, or file type. You can specify only one application name with each command.

### Qualifiers

#### **/[NO]BEGINNING\_TIME=time**

Controls when the command starts displaying information on your terminal screen or when it begins to copy screen information to an output file (if you use /OUTPUT). The /BEGINNING\_TIME qualifier is most useful in a command file. You can specify absolute time or a combination of absolute and delta times. See the *OpenVMS DCL Dictionary* for information about specifying time. The /NOBEGINNING\_TIME qualifier is the default.

#### **/[NO]ENDING\_TIME=time**

Controls when the command stops displaying information on your terminal screen or when it stops copying screen information to an output file (if you use /OUTPUT). The /ENDING\_TIME qualifier is most useful when used in a command file. You can specify absolute time or a combination of absolute and delta times. See the *OpenVMS DCL Dictionary* for information about specifying absolute and delta time. The /NOENDING\_TIME qualifier is the default.

#### **/[NO]INTERVAL=seconds**

Controls how often a terminal screen is refreshed or how often new information is copied to an output file (if you use /OUTPUT). The default is /INTERVAL=30.

#### **/[NO]OUTPUT [=file-spec]**

Controls whether or not display output is sent to a file. If you enter /OUTPUT with a partial file specification, ACMSSHOW is the default file name, .LIS is the default file type, and your current default directory is the directory. The /NOOUTPUT qualifier is the default; output is sent to your terminal.

# ACMS/SHOW APPLICATION/CONTINUOUS

## Notes

The ACMS/SHOW APPLICATION /CONTINUOUS command provides information you can use to evaluate values in the application definition clause MAXIMUM SERVER PROCESSES, and in the MAXIMUM SERVER PROCESSES and MINIMUM SERVER PROCESSES subclauses.

Control the video display by using the control and arrow keys. Press `Ctrl/C`, `Ctrl/Y`, or `Ctrl/Z` to terminate the display. Press `Ctrl/W` to refresh the screen. Use the up arrow and down arrow keys to scroll the screen forward and backward.

There are cases when the values for average number of active servers, average number of free servers and average number of waiting tasks for a given server are displayed as 0. This can occur even when the displayed maximum values of these quantities are quite large.

The averages that are displayed with the ACMS/SHOW APPLICATION /CONTINUOUS command are calculated as follows. Every time that the screen display needs to be refreshed, EXC is polled for data about the servers and a refresh counter is incremented by 1. The average is determined by dividing the running total of the particular data point (i.e. Waiting Tasks) by the number of times that the display has been refreshed. In the case of a data point that has had a noticeable maximum peak over a short amount of time, the average can be very close to zero as the number of refreshes gets very large. The decimal value of the average is rounded down in all cases. So an average of 0.499(9) or less, is rounded down to zero.

## Example

```
$ ACMS/SHOW APPLICATION/CONTINUOUS SANDAPPL
```

```
 ACMS CONTINUOUS APPLICATION MONITOR
 28-MAY-1994 13:48:36.10
Name: SANDAPPL State: STARTED
Process: ACMS01EXC003000
User: EDLOD PID: 2200047C
Max Tasks: 65535 Max SPs: 5
Cur Tasks: 0 Cur SPs: 0

SERVER NAME Min SP/Max SP Current Average Minimum Maximum
SANDSRV 0/5
 Active Servers 0 0 0 0
 Free Servers 0 1 1 1
 Waiting Tasks 0 0 0 0
```

This command shows the SANDAPPL application in continuous refresh mode. Because you did not name an interval, ACMS changes the screen every 30 seconds. See Chapter 9 for a description of each field in this display.

---

## ACMS/SHOW QTI Command

Displays the run-time characteristics of the QTI.

### Format

ACMS/SHOW QTI

### Required Privileges

None

### Notes

None

### Example

```
$ ACMS/SHOW QTI
ACMS V4.0 QTI - Queued Task Initiator Time: 14-MAY-1994 16:16:05.52
State: STARTED User Name: SYSTEM
PID: 11000211 Process Name: ACMS01QTI001000
Queues: 2 Submitter Count: 5
```

This example displays the run-time characteristics of the QTI. See Chapter 8 for a description of the fields in this display.

## ACMS/SHOW QUEUE

---

### ACMS/SHOW QUEUE Command

Displays queue information.

#### Format

```
ACMS/SHOW QUEUE [queue-name[,...]]
```

#### Privileges Required

None

#### Parameters

##### **queue-name**

The name of the queue that you want to display information about. Specify more than one queue name by separating the queue names with a comma (.). If you do not supply a queue name, ACMS displays information about all queues that are started on your node.

#### Notes

The queues displayed by the ACMS/SHOW QUEUE command are those currently being processed by the Queued Task Initiator (QTI).

#### Example

```
$ ACMS/SHOW QUEUE MECCAQUEUE
ACMS V4.0 QUEUED TASK QUEUES Time: 14-MAY-1994 16:16:05.52
Task Queue: MECCAQUEUE State: STARTED
Threads: 4 Successful tasks invocations: 783
Active Tasks: 2 Failed tasks invocations: 4
Error Queue: MECCAERROR_QUEUE
Tasks queued to error queue: 0
```

This example displays queue information about the queue MECCAQUEUE. See Chapter 8 for a description of the fields shown in this display.

---

## ACMS/SHOW SERVER Command

Displays information about one or more servers running under a specified application.

### Format

ACMS/SHOW SERVER [ server-name [...]]

| Command Qualifier             | Default  |
|-------------------------------|----------|
| /APPLICATION=application-name | See text |

### Required Privileges

None

### Parameters

#### server-name

The name of the server you want to display. Specify more than one server name by separating the server names with a comma (.). If you do not supply a server name, ACMS displays information on all servers.

### Qualifiers

#### /APPLICATION=application-name

Specifies an application that contains the server or servers you want to display. Specify only the file name of the application database file; do not specify a device, directory, or file type. If you do not specify the /APPLICATION qualifier, all servers in all active applications are displayed.

### Notes

None

### Examples

```
1. $ ACMS/SHOW SERVER ACMS_TEST_SERVER/APPLICATION=ACMS_TEST_APPL
ACMS V4.0 CURRENT SERVERS Time: 8-MAY-1994 13:42:28.91
Application Name: ACMS_TEST_APPL State: STARTED
Server Name: ACMS_TEST_SERVER
 Process Name: ACMS007SP001001 State: ACTIVE
 User Name: TEST_USER PID: 212004A6
 Image: TESTS::ACMS_TEST_SERVER.EXE;23
 Active Task: DEMO_TASK
 Task ID: NODE1::00010029-0000000F
 Process Name: ACMS007SP001002 State: FREE
 User Name: TEST_USER PID: 212004A9
 Image: ACMS_TEST_SERVER.EXE;23
 Active Task: NONE
 Task ID: NONE
```

This example displays information about the server ACMS\_TEST\_SERVER running under the application ACMS\_TEST\_APPL.

## ACMS/SHOW SERVER

```
2. $ ACMS/SHOW SERVER ACMS_DCL_SERVER/APPLICATION_NAME=ACMS_TEST_APPL
ACMS V4.0 CURRENT SERVERS Time: 8-MAY-1994 13:42:28.91
Application Name: ACMS_TEST_APPL State: STARTED
 Server Name: ACMS_DCL_SERVER
 Process Name: ACMS008SP001000 State: ACTIVE
 User Name: DEMO_USER (DYNAMIC) PID: 2120073C
 Image: DCL_SERVER PROCESS
 Active Task: DCL_TASK
 Task ID: NODE1::0001002F-00000017
```

This example displays information about the server ACMS\_DCL\_SERVER running under the application ACMS\_TEST\_APPL.



---

## ACMS/SHOW SYSTEM Command

Displays information about the ACMS run-time system, all local and remote users, and all local applications.

### Format

ACMS/SHOW SYSTEM

#### Command Qualifiers

/POOL  
/ALL

#### Defaults

No pool information displayed  
All processes using message-switch displayed

### Privileges Required

None

### Qualifiers

#### /POOL

Displays information on pool size and available pool space for the system message switch pools for ACMS processes. No information on current users or applications is displayed when you specify the /POOL qualifier. If you do not specify the /POOL qualifier, no pool information is displayed.

#### /ALL

Use the /ALL qualifier with the /POOL qualifier to display information on pool size and available pool space for the system message switch pools for user-written agent processes, agents using the ACMSDEBUG Utility, and processes executing operator commands, in addition to information for ACMS processes.

### Notes

You can use the pool information displayed when you use the /POOL qualifier to set the ACMSGEN parameters MSS\_POOLSIZE and MSS\_PROCESS\_POOL. See Chapter 11 for more information on adjusting the pool size for your system.

### Examples

1. \$ ACMS/SHOW SYSTEM

```
ACMS V4.0 Current System State: STARTED Time: 23-APR-1994 10:53:37.70
```

```
Terminal Subsystem State: STARTED
Queued Task Initiator State: STOPPED
System Auditing State: ENABLED
```

#### Active ACMS Users

| User Name | Submitter ID     | Agent PID  | Device   |
|-----------|------------------|------------|----------|
| SMITH     | MYNODE::00030035 | 22400104   | TWA3:    |
| SMITH     | MYNODE::00030040 | 22400104   | TWA4:    |
| ACMS_TEST | YRNODE::00B60013 | (YRNODE::) | LTA5014: |
| ACMS_TEST | YRNODE::023B0004 | (YRNODE::) | LTA5006: |

#### Active Execution Controllers

## ACMS/SHOW SYSTEM

| Application Name          | Process Name    | User Name    | Exc PID  |
|---------------------------|-----------------|--------------|----------|
| PACCARE_APPL              | ACMS01EXC002000 | ACMS_TEST    | 224000CE |
| EMPLOYEE_INFO_APPLICATION | ACMS01EXC003000 | SMITH        | 224000D7 |
| EMPLOYEE_INFO_APPL_RTS    | ACMS01EXC004000 | EMPLOYEE_EXC | 224000D9 |

This command displays information about ACMS. The display describes the current system state as **STARTED** and lists all ACMS users, active applications, and their Application Execution Controllers (EXC). See Chapter 8 for an itemized description of each field in this display.

### 2. \$ ACMS/SHOW SYSTEM/POOL

ACMS V4.0 Current System State: STARTED Time: 23-APR-1994 10:53:37.70

Terminal Subsystem State: STARTED  
Queued Task Initiator State: STOPPED  
System Auditing State: ENABLED

#### ACMS System Message Switch Pools

| Process name    | Pool size | Free bytes | (pct) | Largest block | Allocation failures | Garbage collections |
|-----------------|-----------|------------|-------|---------------|---------------------|---------------------|
| < Shared Pool > | 262144    | 228056     | (86%) | 65536         | 0                   | 0                   |
| ACMS01ACC001000 | 131072    | 121168     | (92%) | 65536         | 0                   | 0                   |
| ACMS01ATL001000 | 131072    | 127024     | (96%) | 65536         | 0                   | 0                   |
| ACMS01TSC001000 | 131072    | 126544     | (96%) | 65536         | 0                   | 0                   |
| ACMS01CP001000  | 131072    | 123824     | (94%) | 65536         | 0                   | 0                   |
| ACMS01EXC008000 | 131072    | 123312     | (94%) | 65536         | 0                   | 0                   |
| ACMS008SP001000 | 131072    | 125552     | (95%) | 65536         | 0                   | 0                   |
| ACMS008SP002013 | 131072    | 126704     | (96%) | 65536         | 0                   | 0                   |

This example displays pool size information about the current ACMS system. The display shows the current active system processes, the amount of pool space they use, the number of free bytes of pool space available, the largest block of pool space currently used, the number of allocation failures (if any), and the number of attempts to use fragmented pool space. See Chapter 8 for an itemized description of each field in this display.

---

## ACMS/SHOW TASK Command

Displays information about one or more active ACMS tasks executing on the local node.

### Format

ACMS/SHOW TASK [ task-name[,...]]

| Command Qualifiers            | Defaults         |
|-------------------------------|------------------|
| /APPLICATION=application-name | All applications |
| /DEVICE=device-name           | All devices      |
| /IDENTIFIER=task-id           | All tasks        |
| /SUBMITTER=submitter-id       | All submitters   |
| /USER=user-name               | All users        |

### Required Privileges

None

### Parameters

#### **task-name**

The name of the task assigned in the application definition. If you do not specify a task name, ACMS displays information about all active tasks. Specify more than one task name by separating the task names with a comma (,).

### Qualifiers

#### **/APPLICATION=application-name**

Names the application in which the task or tasks you want to display are defined. The application name is the file name of the application database file. Do not include device, directory, or file type (.ADB). If you omit this qualifier, ACMS searches all applications on the node for the tasks you specify. If you include an application name with the /APPLICATION qualifier, ACMS searches for the task name in that application only.

#### **/DEVICE=device-name**

Displays only those tasks that have the specified device name. Device name is the name of the terminal at which the task is running. You must end the device name with a colon (:). When you do not specify the /DEVICE qualifier, ACMS does not select tasks by device name to display.

#### **/IDENTIFIER=task-id**

Displays only those tasks that have the specified ID. ACMS assigns a unique task ID to each task a user selects. You need not specify leading and trailing zeros when specifying a task ID. You can display information on tasks called by other tasks. Refer to Chapter 12 for information about specifying a task ID.

#### **/SUBMITTER=submitter-id**

Displays only those tasks that have the specified user ID. ACMS assigns a unique user ID to each user who signs in. You need not specify leading and trailing zeros when specifying a submitter ID. Refer to Chapter 12 for information about specifying a submitter ID.

## ACMS/SHOW TASK

If you do not specify the /SUBMITTER qualifier, ACMS does not select tasks by submitter ID to display.

### **/USER=user-name**

Displays only those tasks that were submitted by the user with the specified user name.

## Notes

If you do not specify a qualifier, the ACMS/SHOW TASK command displays information about all active tasks as well as all tasks called by other tasks.

The ACMS/SHOW TASK command does not display the transaction ID (TID) for a task that is executing a transaction step if that transaction step is a single processing step. The ACMS/SHOW TASK command displays the TID only for all composed tasks and for tasks where the transaction step is a block step.

## Example

```
$ ACMS/SHOW TASK
ACMS V4.0 CURRENT TASKS Time: 28-MAY-1994 13:35:23.19
Task Name: MON_TASK
 Task ID: WOW::0001000D-00000001
 Application: LAS_APPL
 Submitter ID: WOW::0001000D User Name: CAMEO
 Device: TTB1:
Task Name: OPR_TASK
 Task ID: WOW::00020013-00000003
 Application: LAS_APPL User Name: NOMIS
 Submitter ID: WOW::00020013 Device: TTH0:
 Called Task: OPR_TASK_A
 Task ID: WOW::00020013-00000003-00000001
 Called Task: OPR_TASK_B
 Task ID: WOW::00020013-00000003-00000002
```

This command displays information about all tasks active on the local node. See Chapter 9 for a description of each field shown in this display.

---

## ACMS/SHOW USER Command

Displays information about ACMS users. With qualifiers, displays information about only those users you identify.

### Format

ACMS/SHOW USER [user-name[,...]]

| Command Qualifiers      | Defaults         |
|-------------------------|------------------|
| /ALL                    | /ALL             |
| /APPLICATION            | All applications |
| /DEVICE=device-name     | All devices      |
| /[NO]FULL               | /NOFULL          |
| /LOCAL                  | All submitters   |
| /REMOTE                 | All submitters   |
| /SUBMITTER=submitter-id | All submitters   |

### Privileges Required

None

### Parameters

#### **user-name**

Specifies the name of the user that you want to display information about. If you do not specify a user name, the ACMS/SHOW USER command displays information about all ACMS users. Specify more than one user name by separating each user name with a comma ( , ).

### Qualifiers

#### **/ALL**

Displays information for both local and remote users. Local users are those who sign in to ACMS on the local node. Remote users are those who select tasks from a remote node. In addition, the /ALL qualifier displays the total number of users accessing the ACMS system. ACMS/SHOW USER/ALL is the default.

You cannot specify the /ALL qualifier with the /LOCAL or /REMOTE qualifier.

#### **/APPLICATION**

Displays each local application that a user is connected to.

#### **/DEVICE=device-name**

Displays information about ACMS users at the specified terminal. The device name is a terminal ID. You must end the device-name with a colon (:). If you do not specify the /DEVICE qualifier, ACMS does not select users by device name to display information about.

#### **/[NO]FULL**

Displays task information for each user. The default is /NOFULL.

#### **/LOCAL**

Displays information for local users only. Local users are those who sign in to ACMS on the local node. You cannot specify the /LOCAL qualifier with the /REMOTE or /ALL qualifier.

## ACMS/SHOW USER

### **/REMOTE**

Displays information only about remote users currently accessing applications on the local node. Remote users are those who selected tasks from a remote node. You cannot specify the /REMOTE qualifier with the /LOCAL or /ALL qualifier.

### **/SUBMITTER=submitter-id**

Displays information only about users that have the specified submitter ID. ACMS assigns a unique submitter ID to each user who signs in. Refer to Chapter 12 for information about specifying a submitter ID.

If you do not specify the /SUBMITTER qualifier, ACMS does not select users by submitter ID to display information about.

## Notes

If you do not specify a user name or use any of the qualifiers, the ACMS/SHOW USER command displays information about all users.

If a user is signed in at more than one terminal, you can use the /DEVICE qualifier to get information about the user's activity at one of the terminals. This qualifier is valid only for local users.

If you have the OPER privilege, you can cancel one or more local users by using the ACMS/CANCEL USER command.

The ACMS/SHOW USER/FULL command does not display information about called tasks. Use the ACMS/SHOW TASK command to display information about called tasks.

Use the /LOCAL qualifier to display information about local users.

Use the /REMOTE qualifier to display information about remote users.

Use the /ALL qualifier (the default) to display information about both local and remote users.

Use the /APPLICATION qualifier to see a list of local applications that the user is connected to.

## Examples

1. `$ ACMS/SHOW USER/ALL`

```
ACMS V4.0 CURRENT USERS Time: 16-MAR-1994 16:32:14.93
User name: SMITH Submitter ID: VAXA::0001001E
Agent PID: 22E000C0 Device: TWA2:
User name: JONES Submitter ID: VAXA::0002001E
Agent PID: 22E000C0 Device: RTA2:
User name: TOWERS Submitter ID: VAXA::0004001E
Agent PID: 22E000C0 Device: LTA2:
User name: NEWMAN Submitter ID: VAXB::0006001E
Agent PID: (VAXB::) Device: TWA2:
User name: JACKSON Submitter ID: VAXB::0007001E
Agent PID: (VAXB::) Device: LTA12:
User name: SMITH_S Submitter ID: VAXC::0008001E
Agent PID: (VAXB::) Device: LTA22:
Total known active users: 6
```

This command displays information about all local and remote users signed

in to ACMS on the node. For nodes with concurrent-use licenses, the total number of active users represents the number of license units in use. ACMS/SHOW USER/ALL is the default.

2. \$ ACMS/SHOW USER/LOCAL

```
ACMS V4.0 CURRENT USERS Time: 16-MAR-1994 16:32:14.93
User Name: SMITH Submitter ID: VAXA::0001001E
Agent PID: 22E000C0 Device: TWA2:
User name: JONES Submitter ID: VAXA::0002001E
Agent PID: 22E000C0 Device: RTA2:
User name: TOWERS Submitter ID: VAXA::0004001E
Agent PID: 22E000C0 Device: LTA2:
```

This command displays information about all local users signed in to ACMS.

3. \$ ACMS/SHOW USER/APPLICATION

```
ACMS V4.0 CURRENT USERS Time: 23-APR-1994 10:45:19.14
User Name: SMITH Submitter ID: MYNODE::00030035
Agent PID: 22400104 Device: TWA3:
Application: PACCARE_APPL
Application: EMPLOYEE_INFO_APPLICATION
User Name: SMITH Submitter ID: MYNODE::00030040
Agent PID: 22400104 Device: TWA4:
This user is not connected to any applications
User Name: ACMS_TEST Submitter ID: YRNODE::00B60013
Agent PID: (YRNODE::) Device: LTA5014:
Application: EMPLOYEE_INFO_APPLICATION
Application: PACCARE_APPL
User Name: ACMS_TEST Submitter ID: YRNODE::023B0004
Agent PID: (YRNODE::) Device: LTA5006:
Application: EMPLOYEE_INFO_APPLICATION
Application: PACCARE_APPL
Total known active users: 4
```

This command displays information about all local and remote users signed in to ACMS on the node and lists the local applications that each user is connected to. For nodes with concurrent-use licenses, the total number of known active users represents the number of license units in use.

4. \$ ACMS/SHOW USER/APPLICATION/LOCAL

```
ACMS V4.0 CURRENT USERS Time: 16-MAR-1994 16:32:14.93
User Name: SMITH Submitter ID: VAXA::0001001E
Agent PID: 22E000C0 Device: TWA2:
Application: EMPLOYEE_INFO_APPLICATION
Application: PAYROLL_APPLICATION
Application: ACCOUNTING_APPLICATION
User Name: JONES Submitter ID: VAXA::0002001E
Agent PID: 22E000C0 Device: RTA2:
Application: PAYROLL_APPLICATION
User name: JONES_J Submitter ID: VAXA::0003001E
Agent PID: 22E000C0 Device: RTA3:
```

## ACMS/SHOW USER

This user is not connected to any application

```
User name: TOWERS Submitter ID: VAXA::0004001E
Agent PID: 22E000C0 Device: LTA2:

Application: INVENTORY_APPLICATION
Application: ORDER_ENTRY_APPLICATION
Application: CREDIT_INQUIRY_APPLICATION
```

**This command displays information about all local users and lists the local applications that each user is connected to.**

5. \$ ACMS/SHOW USER/DEVICE=RTA2:

```
ACMS V4.0 CURRENT USERS Time: 16-MAR-1994 16:32:14.93
User Name: JONES Submitter ID: VAXA::0002001E
Agent PID: 22E000C0 Device: RTA2:
```

**This command displays information about the user signed in to ACMS at terminal RTA2:.**

6. \$ ACMS/SHOW USER/FULL

```
ACMS V4.0 CURRENT USERS Time: 16-MAR-1994 16:32:14.93
User Name: SMITH Submitter ID: VAXA::0001001E
Agent PID: 22E000C0 Device: TWA2:

Task Name: EMPLOYEE_INFO_UPDATE_TASK
Task ID: VAXA::0001001E-00000001
Appl Name: EMPLOYEE_INFO_APPLICATION
Appl Node: VAXA::

User Name: JONES Submitter ID: VAXA::0002001E
Agent PID: 22E000C0 Device: RTA2:

User JONES has no active tasks.

User name: TOWERS Submitter ID: VAXA::0004001E
Agent PID: 22E000C0 Device: LTA2:

Task Name: ORDER_ADD
Task ID: VAXA::0004001E-00000001
Appl Name: ORDER_ENTRY_APPLICATION
Appl Node: VAXA::
```

**This command displays information about all local users and lists the tasks submitted by those users.**

7. \$ ACMS/SHOW USER/REMOTE

```
ACMS V4.0 CURRENT USERS Time: 16-MAR-1994 16:32:14.93
User name: NEWMAN Submitter ID: VAXB::0006001E
Agent PID: (VAXB::) Device: TWA2:

User name: JACKSON Submitter ID: VAXB::0007001E
Agent PID: (VAXB::) Device: LTA12:

User name: SMITH_S Submitter ID: VAXC::0008001E
Agent PID: (VAXC::) Device: LTA22:
```

**This command displays information about all remote users.**



## ACMS/SHOW USER

8. \$ ACMS/SHOW USER/REMOTE/APPLICATION

ACMS V4.0      CURRENT USERS              Time: 16-MAR-1994 16:32:14.93

User name:        NEWMAN                      Submitter ID: VAXB::0006001E  
Agent PID:        (VAXB::)                    Device:        TWA2:

Application: PAYROLL\_APPLICATION  
Application: ACCOUNTING\_APPLICATION

User name:        JACKSON                      Submitter ID: VAXB::0007001E  
Agent PID:        (VAXB::)                    Device:        LTA12:

Application: EMPLOYEE\_INFO\_APPLICATION  
Application: PAYROLL\_APPLICATION  
Application: ACCOUNTING\_APPLICATION  
Application: INVENTORY\_APPLICATION  
Application: ORDER\_ENTRY\_APPLICATION  
Application: CREDIT\_INQUIRY\_APPLICATION

User name:        SMITH\_S                      Submitter ID: VAXC::0008001E  
Agent PID:        (VAXC::)                    Device:        LTA22:

Application: PAYROLL\_APPLICATION  
Application: CREDIT\_INQUIRY\_APPLICATION

**This command displays information about all remote users signed in to ACMS and lists the local applications that each user is connected to.**

## ACMS/START APPLICATION

---

### ACMS/START APPLICATION Command

Starts one or more ACMS applications.

#### Format

ACMS/START APPLICATION application-name[,...]

#### Privileges Required

OpenVMS OPER privilege

#### Parameters

##### **application-name**

The file name of the application you want to start. Specify only the file name of the application database file; do not include device, directory, or file type. You must specify at least one application name. Specify more than one application name by separating each name with a comma (,).

#### Notes

The ACMS system must be started before you use the ACMS/START APPLICATION command. Specify the ACMS/START SYSTEM command to start ACMS.

Before you use the ACMS/START APPLICATION command, ACMS\$DIRECTORY must be defined in SYS\$MANAGER:SYSTARTUP\_VMS.COM as a system logical name pointing to the directory that contains the application database files. When you start applications, application database files must reside in ACMS\$DIRECTORY.

---

#### Note

---

For sites that have modularized their startup procedures, be sure you add the lines to the correct file. The default startup command file for OpenVMS VAX Version 5.n is SYS\$MANAGER:SYSTARTUP\_V5.COM; for OpenVMS VAX Version 6.n and OpenVMS Alpha and OpenVMS I64, it is SYSTARTUP\_VMS.COM.

---

The ACMS/START APPLICATION command can stall when you start an application if both of the following conditions are present:

- The application is defined with minimum server processes greater than zero.
- A server cannot start. This usually indicates a problem in the initialization procedure, such as an infinite loop in the program.

If these conditions are present, ACMS displays the following messages:

```
%ACMSOPR-E-STRTAPLERR, Error while attempting to START APPLICATION application-name
```

```
-ACMSOPS-W-TIMEOUT, Timed out waiting for reply from ACMS component
```

```
%ACMSOPR-E-ERROR, Some operations may not have been performed
```

## ACMS/START APPLICATION

Use the ACMS/SHOW SYSTEM command to find the process ID (PID) for the Application Execution Controller or the PID of the hanging server process. ACMS/SHOW SYSTEM displays the PID that you can use in the following command to recover from the error:

```
$ STOP/ID=<pid>
```

If the ACMS/START APPLICATION command fails and the Software Event Log (SWL) report indicates an “exceeded quota” error for the EXC, the quota for the buffered I/O byte count limit (BYTLM) is probably not set properly. Increase this quota for the user name of the application, and try the command again. Refer to Chapter 10 for information about setting the proper quota limit for BYTLM.

### Example

```
$ ACMS/START APPLICATION PERSONNEL, DEPARTMENT
```

This command starts the PERSONNEL and DEPARTMENT applications.

---

### ACMS/START QTI Command

Starts the QTI.

#### Format

ACMS/START QTI

#### Privileges Required

OpenVMS OPER privilege

#### Notes

You must start ACMS before you can use the ACMS/START QTI command.

The QTI must be started before queues can be started. You can also start the QTI by specifying the ACMS/START SYSTEM command with the /QTI qualifier.

Stop the QTI by using the ACMS/STOP QTI command.

#### Example

```
$ ACMS/START QTI
```

This example starts the QTI.

---

## ACMS/START QUEUE Command

Starts the task queue you specify. Once you start a task queue, the QTI begins processing any queued task elements in the queue.

### Format

ACMS/START QUEUE queue-name[,...]

#### Command Qualifiers

/ERROR\_QUEUE=error-queue-name  
/TASK\_THREADS=n

#### Defaults

No error queue  
/TASK\_THREADS=1

### Required Privileges

OpenVMS OPER privilege

### Parameters

#### queue-name

The name of a task queue created by the ACMS Queue Manager (ACMSQUEMGR). You must supply at least one queue name. Specify more than one queue name by separating each name with a comma (,).

### Qualifiers

#### /ERROR\_QUEUE=error-queue-name

Specifies the error queue for a task queue. If you specify this qualifier, queued tasks that do not complete successfully are placed on the specified error queue. Any errors are recorded in the Audit Trail Logger.

The /ERROR\_QUEUE qualifier is a positional qualifier. If you specify the /ERROR\_QUEUE qualifier between the ACMS/START QUEUE command and the queue names, all queue names are affected. If you specify the ACMS/START QUEUE command after a queue name, only that queue name is affected.

If you do not specify the /ERROR\_QUEUE qualifier, no error queue is associated with the task queue. When an error occurs, the task is deleted from the queue.

#### /TASK\_THREADS=n

Specifies the number of concurrent outstanding tasks that the QTI processes for a queue. Here, *n* indicates a value from 1 through 256.

The /TASK\_THREADS qualifier is a positional qualifier. If you position the /TASK\_THREADS qualifier between the ACMS/START QUEUE command and the queue names, all queue names are affected. To have the /TASK\_THREADS qualifier apply to an individual queue name in a list of queue names, place the qualifier directly after the queue name. See the examples section.

The default is /TASK\_THREADS=1.

## ACMS/START QUEUE

### Notes

The error queue you specify with the `/ERROR_QUEUE` qualifier must exist. You create an error queue with the ACMSQUEMGR Utility. See Chapter 5 for information on the ACMSQUEMGR.

You can queue tasks to a queue and remove tasks from a queue using ACMS Queued Task Services even though a queue is not started.

### Examples

1. `$ ACMS/START QUEUE ACCTS_QUE`

This example starts the ACMS task queue ACCTS\_QUE.

2. `$ ACMS/START QUEUE MAHWAH_QUE/ERROR_QUEUE=W_ERROR, MY_QUE -  
_ $ /ERROR_QUEUE=M_ERROR`

This example starts the task queues MAHWAH\_QUE and MY\_QUE and any tasks in these queues. If any tasks in MAHWAH\_QUE do not complete normally, they are placed on the error queue W\_ERROR. If any tasks in MY\_QUE do not complete normally, they are placed on the error queue M\_ERROR.

3. `$ ACMS/START QUEUE PARTS_QUE, FAST_QUE /TASK_THREADS=5`

This example starts the task queues PARTS\_QUE and FAST\_QUE. The maximum number of concurrent outstanding tasks for PARTS\_QUE is set to the default value. For FAST\_QUE, the maximum number of concurrent outstanding tasks is set to 5.

---

## ACMS/START SYSTEM Command

Starts the ACMS system.

### Format

ACMS/START SYSTEM

| Command Qualifiers | Defaults   |
|--------------------|------------|
| /[NO]AUDIT         | /AUDIT     |
| /[NO]QTI           | /NOQTI     |
| /[NO]TERMINALS     | /TERMINALS |

### Privileges Required

OpenVMS OPER privilege

### Qualifiers

#### **/[NO]AUDIT**

The /AUDIT qualifier starts ACMS with audit trail logging enabled. The /AUDIT qualifier is the default. After you start ACMS, you can control the Audit Trail Logger with the ACMS/SET SYSTEM and ACMS/RESET TERMINALS commands.

#### **/[NO]QTI**

The /QTI qualifier starts the QTI when ACMS is started. Once the QTI is started, you can start one or more queues with the ACMS/START QUEUE command. If you specify the /NOQTI qualifier, the QTI is not started with ACMS. The /NOQTI qualifier is the default.

#### **/[NO]TERMINALS**

The /TERMINALS qualifier starts the TSC when ACMS is started. The /TERMINALS qualifier is the default. If you specify the /NOTERMINALS qualifier, the TSC is not started with ACMS. If you specify /NOTERMINALS, you can start the TSC at a later time with the ACMS/START TERMINALS command.

### Notes

Include the ACMS/START SYSTEM and ACMS/START APPLICATION commands in your OpenVMS site-specific startup file (SYS\$MANAGER:SYSTARTUP\_VMS.COM) to start ACMS and ACMS applications automatically when OpenVMS starts.

---

#### Note

For sites that have modularized their startup procedures, be sure you add the lines to the correct file. The default startup command file for OpenVMS VAX Version 5.n is SYS\$MANAGER:SYSTARTUP\_V5.COM; for OpenVMS VAX Version 6.n and OpenVMS Alpha and OpenVMS I64, it is SYSTARTUP\_VMS.COM.

---

When you start the TSC with the ACMS/START SYSTEM command, recently assigned terminal sign-in characteristics defined by the DDU take effect.

## ACMS/START SYSTEM

If you do not start the QTI when you start ACMS, you can specify the ACMS/START QTI command to start the QTI at a later time.

### Examples

1. 

```
$ ACMS/START SYSTEM/NOTERMINALS
$ ACMS/START APPLICATION PERSONNEL,DEPARTMENT
$ ACMS/START TERMINALS
```

The first command starts ACMS without starting the TSC. At this point, users cannot sign in to ACMS. The second command starts the PERSONNEL and DEPARTMENT applications. The third command starts the TSC so users can sign in to ACMS and select tasks in the PERSONNEL or DEPARTMENT applications.

2. 

```
$ ACMS/START SYSTEM/QTI
$ ACMS/START APPLICATION PERSONNEL,DEPARTMENT
```

These commands are part of a command file for starting ACMS and ACMS applications. When you run the command file, the first command starts ACMS, the QTI, and the TSC. The second command starts the PERSONNEL and DEPARTMENT applications, so users can select tasks in those applications.



---

## ACMS/START TASK Command

Starts a detached task in the specified application.

### Format

ACMS/START TASK task-name application-name

| Command Qualifiers                 | Defaults                 |
|------------------------------------|--------------------------|
| /[NO]LOG                           | /NOLOG                   |
| /[NO]RETRY_LIMIT[=n]               | /RETRY_LIMIT=0           |
| /SELECTION_STRING=selection-string | Null string              |
| /USERNAME=user-name                | User name of application |
| /WAIT_TIMER=n                      | /WAIT_TIMER=5 seconds    |

### Privileges Required

OpenVMS OPER and SYSPRV privileges

### Parameters

#### **task-name**

The name of the task that you want to start as a detached task. The task must contain no exchange steps and you must define the task with the NO I/O phrase. The task name must exist in the application specified by the application-name parameter.

#### **application-name**

Specifies the file name of the application in which the detached task executes. Specify only the file name of an application database file; do not include a device, directory, or file type.

### Qualifiers

#### **/[NO]LOG**

Controls whether or not ACMS displays a message after the detached task has been successfully started. The /NOLOG qualifier is the default.

#### **/[NO]RETRY\_LIMIT[=n]**

Specifies the maximum number of times ACMS retries the task after a failure. Specifying /NORETRY\_LIMIT indicates that ACMS always retries after a failure. The /RETRY\_LIMIT=0 qualifier is the default, which directs ACMS to never retry the task after a failure.

#### **/SELECTION\_STRING=selection-string**

Specifies the data to be passed to the ACMS\$SELECTION\_STRING system workspace in a task. The default is to pass a null string to the ACMS\$SELECTION\_STRING system workspace.

#### **/USERNAME=user-name**

Specifies the submitter user name under which the detached task is signed in. The default is the OpenVMS user name under which the Application Execution Controller (EXC) executes. If you specify an OpenVMS user name that is different than the EXC user name, the user name must be identified as an agent in the ACMS user definition file.

## ACMS/START TASK

### **/WAIT\_TIMER=n**

Specifies the number of seconds ACMS waits before retrying the task after a task failure. The `/WAIT_TIMER=5` is the default; the minimum value is 1 and the maximum value is 65,535 seconds.

## Notes

The ACMS/START TASK operator command completes when the detached task has started successfully, or if it fails to start. If the detached task fails immediately after the task starts executing, the failure is not reported by the ACMS/START TASK operator command, because the ACMS Operator Utility does not wait for the task to complete.

Before starting a detached task, you must start the application associated with the task. A user is signed in when starting a detached task. As a result, a set of license units is consumed, if the ACMS system has a loaded concurrent-user license.

The submitter user name under which a detached task is signed in must have an entry in the ACMSUDF.DAT file with the /AGENT qualifier. The user name is either the user name specified with the /USERNAME qualifier of the ACMS/START TASK operator command or the default EXC user name of the application.

## Example

```
$ ACMS/START TASK dequeue_task dist_appl -
$ /RETRY_LIMIT=10/WAIT_TIMER=30/USERNAME=SMITH
```

This command starts the detached task, called `dequeue_task`, in the application `dist_appl`. The task can be retried a maximum of 10 times after task failures, and ACMS waits 30 seconds before it retries the task. The task is submitted with the user name SMITH.

---

## ACMS/START TERMINALS Command

Starts the TSC when ACMS is running. The ACMS/START TERMINALS command enables terminal users to access ACMS menus.

### Format

```
ACMS/START TERMINALS
```

### Privileges Required

OpenVMS OPER privilege

### Notes

You cannot start the TSC unless ACMS is active. Users cannot sign in to ACMS unless the TSC is started.

Use this command to start the TSC after specifying the /NOTERMINALS qualifier when you started ACMS, or to restart the TSC after stopping it with the ACMS/STOP TERMINALS command.

When you start the TSC, recently assigned terminal sign-in characteristics defined by the DDU take effect. Starting the TSC also authorizes any new terminals added since the last time the TSC was started and releases any that are no longer authorized.

The ACMS/START TERMINALS only allows terminal users on the local system to access the ACMS menus. It does not affect whether or not remote users can access applications on the local system or whether or not users using other task submitting agents, such as ALL-IN-1, can select ACMS tasks.

### Examples

1. 

```
$ ACMS/START TERMINALS
```

This command starts or restarts the TSC. Users can then sign in to ACMS.

2. 

```
$ ACMS/START SYSTEM/QTI/NOTERMINALS
$ ACMS/START APPLICATION DEPARTMENT,PERSONNEL
$ ACMS/START TERMINALS
```

This series of commands starts ACMS and the QTI, starts ACMS applications, and starts the TSC, respectively. The ACMS/START TERMINALS command starts the TSC separately from ACMS so users cannot sign in until applications are active.

## ACMS/STOP APPLICATION

---

### ACMS/STOP APPLICATION Command

Stops one or more ACMS applications.

#### Format

ACMS/STOP APPLICATION application-name[,...]

| Command Qualifier | Default   |
|-------------------|-----------|
| /[NO]CANCEL       | /NOCANCEL |

#### Privileges Required

OpenVMS OPER privilege

#### Parameters

##### **application-name**

The name of the application that you want to stop. Specify only an application name; do not include device, directory, or file type. You must specify at least one application name. Specify more than one application name by separating each name with a comma (,).

#### Qualifiers

##### **/[NO]CANCEL**

The /CANCEL qualifier cancels an active task in the application you are stopping. If you use the /NOCANCEL qualifier, ACMS waits until all active tasks stop before stopping the application. The /NOCANCEL qualifier is the default.

#### Notes

Once you specify the ACMS/STOP APPLICATION command, no new tasks can be started.

The ACMS/STOP APPLICATION command executes only when there are no tasks active in the application you specify. If there are active tasks in the application you want to stop, use the DCL REPLY command to ask users to halt or complete the tasks and then sign out. You can then use the /CANCEL qualifier to stop any tasks that remain active. Restart applications by specifying the ACMS/START APPLICATION command.

See the *OpenVMS DCL Dictionary* for information about the DCL REPLY command.

#### Examples

1. \$ ACMS/STOP APPLICATION DEPARTMENT/CANCEL

This command cancels any active tasks in the application DEPARTMENT and stops the application. Terminal users cannot select and run tasks in the application DEPARTMENT.

## ACMS/STOP APPLICATION

2. \$ ACMS/STOP APPLICATION PERSONNEL,DEPARTMENT/CANCEL

This command cancels any active tasks in the PERSONNEL and DEPARTMENT applications and stops the applications. Terminal users cannot select and run tasks in these applications.

## ACMS/STOP QTI

---

### ACMS/STOP QTI Command

Stops the QTI and all active task queues.

#### Format

ACMS/STOP QTI

| Command Qualifier | Default   |
|-------------------|-----------|
| /[NO]CANCEL       | /NOCANCEL |

#### Required Privileges

OpenVMS OPER privilege

#### Qualifiers

##### **/[NO]CANCEL**

The /CANCEL qualifier cancels all active tasks in all active queues. If you use the /NOCANCEL qualifier, ACMS waits until all active tasks stop before stopping the QTI and task queues. The /NOCANCEL qualifier is the default.

#### Notes

Restart a queue by using the ACMS/START QTI and ACMS/START QUEUE commands.

#### Example

```
$ ACMS/STOP QTI
```

This command stops the QTI and all active queues.

---

## ACMS/STOP QUEUE Command

Stops the specified task queue.

### Format

ACMS/STOP QUEUE queue-name[,...]

| Command Qualifier | Default   |
|-------------------|-----------|
| /[NO]CANCEL       | /NOCANCEL |

### Required Privileges

OpenVMS OPER privilege

### Parameters

#### queue-name

The name of the task queue you want to stop. You must specify at least one queue name. Stop more than one queue by separating the queue names with a comma (,).

### Qualifiers

#### /[NO]CANCEL

The /CANCEL qualifier cancels all active tasks in the queue you are stopping. If you use the /NOCANCEL qualifier, ACMS waits until all active tasks complete before stopping the queue. The /NOCANCEL qualifier is the default.

### Notes

When you specify the ACMS/STOP QUEUE command, the specified task queue is stopped by the QTI.

Even though a task queue is stopped, queued task elements can still be initiated to the queue.

### Example

```
$ ACMS/STOP QUEUE ALAS_QUE, ALACK_QUE
```

This command stops the task queues ALAS\_QUE and ALACK\_QUE.

## ACMS/STOP SYSTEM

---

### ACMS/STOP SYSTEM Command

Stops the ACMS system, the TSC, the QTI, and all applications.

#### Format

ACMS/STOP SYSTEM

| Command Qualifier | Default   |
|-------------------|-----------|
| /[NO]CANCEL       | /NOCANCEL |

#### Privileges Required

OpenVMS OPER privilege

#### Qualifiers

##### **/[NO]CANCEL**

If you specify the /CANCEL qualifier, all active tasks are canceled immediately. If you specify /NOCANCEL, ACMS waits until all active tasks are either completed or halted before stopping the ACMS system. The default is /NOCANCEL.

#### Notes

Once you specify the ACMS/STOP SYSTEM command, no new tasks can be started.

Include the ACMS/STOP SYSTEM/CANCEL command in your OpenVMS site-specific shutdown file, SYS\$MANAGER:SYSHUTDWN.COM.

If the ACMS system stalls, you might not be able to use the ACMS/STOP SYSTEM command to stop it. Use the STOP command from DCL to stop the ACMS Central Controller (ACC) process. Stop the remaining ACMS process using the ACMS/STOP SYSTEM command.

The ACMS/STOP SYSTEM command executes only when there are no tasks active. If there are active tasks, ACMS waits for the tasks to complete before executing the ACMS/STOP SYSTEM command, and also disables any new tasks from starting. Use the DCL REPLY command to ask users to halt or complete their tasks, and then sign out before issuing the ACMS/STOP SYSTEM command. You can then use the /CANCEL qualifier to stop any tasks that remain active.

See the *OpenVMS DCL Dictionary* for information about the DCL REPLY command.

To restart ACMS, use the ACMS/START SYSTEM command. To restart applications, use the ACMS/START APPLICATION command after the ACMS/START SYSTEM command. To restart a queue, specify the ACMS/START SYSTEM command with the /QTI qualifier or ACMS/START QUEUE command.

#### Example

```
$ ACMS/STOP SYSTEM/CANCEL
```

This command cancels any active tasks and stops all applications, the TSC, the QTI, and the ACMS software.



---

## ACMS/STOP TERMINALS Command

Stops the TSC, thereby canceling the tasks of all ACMS menu users and signing out all current menu users.

### Format

```
ACMS/STOP TERMINALS
```

### Privileges Required

OpenVMS OPER privilege

### Notes

Use the ACMS/STOP TERMINALS command to prevent users from signing in or to stop all ACMS task activity.

Because the ACMS/STOP TERMINALS command cancels active tasks and signs users out of ACMS, use the DCL REPLY command to ask users to finish tasks before entering this command. See the *OpenVMS DCL Dictionary* for information about the DCL REPLY command.

To restart the TSC, specify the ACMS/START TERMINALS command.

### Example

```
$ ACMS/STOP TERMINALS
```

This command cancels active tasks and stops the TSC. Users cannot sign in to ACMS.



---

## ACMSGEN Commands

This chapter contains reference information and examples for the ACMSGEN Utility commands. See Chapter 11 for general information on the ACMSGEN Utility. It is recommended that you change ACMSGEN-generated parameters with the ACMSPARAM.COM command procedure. See Chapter 10 for information about the ACMSPARAM.COM command procedure.

## EXIT

---

### EXIT Command (ACMSGEN>)

Ends the ACMSGEN session and returns you to the DCL prompt.

#### Format

EXIT

#### Privileges Required

None

#### Notes

You can also end an ACMSGEN session by pressing `Ctrl/Z`. `Ctrl/Z` signals the end of the file for data entered from the terminal. `Ctrl/Z` is displayed as EXIT.

ACMSGEN does not automatically write your changes to the ACMSGEN work area when you exit.

#### Example

```
ACMSGEN> EXIT
$
```

This command ends the ACMSGEN session and returns you to the DCL prompt.

---

## HELP Command (ACMSGEN>)

Displays information about ACMSGEN commands and qualifiers.

### Format

HELP [ topic [...]]

### Privileges Required

None

### Parameters

**topic**

The command or topic you want to know about. If you do not supply a topic, HELP provides a list of topics to choose from.

### Notes

None

### Example

```
ACMSGEN> HELP USE_CURRENT
```

```
USE_CURRENT
```

```
 Initializes the work area with current values from the ACMSPAR.ACM
 file.
```

```
 Format:
```

```
 USE CURRENT
```

```
Topic?
```

This command displays help information about the USE CURRENT command.

## SET

---

### SET Command (ACMSGEN>)

Changes parameter values in the ACMSGEN work area. The parameter changes are not made to any real parameter set until you use the WRITE command.

#### Format

SET parameter-name value

#### Privileges Required

None

#### Parameters

##### **parameter-name**

The name of the ACMS parameter whose value you are changing. Display the names of parameters by using the SHOW command.

##### **value**

The new value for the parameter. Enter integer values in decimal numbers. String values can be enclosed in quotation marks.

#### Notes

None

#### Examples

1. ACMSGEN> SET CP\_SLOTS 5  
ACMSGEN> SET MAX\_LOGINS 25  
ACMSGEN> WRITE CURRENT

These commands increase the number of users who can sign in by increasing the values of the CP\_SLOTS and MAX\_LOGINS parameters. The first SET command places 5 in the work area as the value for CP\_SLOTS. The second SET command places 25 in the work area as the value for MAX\_LOGINS. The WRITE CURRENT command writes values from the work area to the SYS\$SYSTEM:ACMSPAR.ACM file.

2. ACMSGEN> USE WORK  
ACMSGEN> SET CP\_USERNAME ACMS\$CP  
ACMSGEN> WRITE CURRENT

These commands change the current user name of the Command Process (CP) to ACMS\$CP and update the current values for other parameters with values from the work file, WORK.ACM. The USE command initializes the work area with values from the work file. The SET command changes the value of CP\_USERNAME to ACMS\$CP. The WRITE ACTIVE command copies the values for current parameters from the work area to the global section for current values.

---

## SHOW Command (ACMSGEN>)

Displays the value in the work area, the default value, the minimum value, the maximum value, the unit of measure, and the dynamic/fixed status for ACMS system parameters.

### Format

```
SHOW { parameter-name }
 { /qualifier [...] }
```

| Command Qualifiers | Defaults |
|--------------------|----------|
| /ACC               | None     |
| /ALL               | None     |
| /CP                | None     |
| /EXC               | None     |
| /MSS               | None     |
| /QTI               | None     |
| /TSC               | None     |

### Privileges Required

None

### Parameters

#### **parameter-name**

The name of a parameter that you want to display information about. You must supply a parameter name or you receive an error.

### Qualifiers

#### **/ACC**

Displays information only for the parameters that affect the ACMS Central Controller (ACC).

#### **/ALL**

Displays information for all parameters values.

#### **/CP**

Displays information only for the parameters that affect the ACMS Command Process.

#### **/EXC**

Displays information only for the parameters that affect the ACMS Application Execution Controller.

#### **/MSS**

Displays information only for the parameters that affect the ACMS message switch subsystem.

#### **/QTI**

Displays information only for the parameter values that affect the ACMS Queued Task Initiator (QTI).

## SHOW

### /TSC

Displays information only for the parameters that affect the Terminal Subsystem Controller (TSC).

### Notes

If you specify a qualifier, it overrides the parameter name.

The dynamic/fixed status indicates whether or not you can change the active value for a parameter. You can change the active or current values of dynamic parameters. You can change only the current values of fixed parameters.

### Examples

1. ACMSGEN> SHOW MAX\_TTS\_CP  
MAX\_TTS\_CP 20 20 0 -1 te

For the MAX\_TTS\_CP parameter, this command displays:

- Value in the work area
- Default value
- Minimum value
- Maximum value (-1 indicates infinity)
- Unit of measure
- Dynamic/fixed status

2. ACMSGEN> SHOW/TSC  
Parameters in use: CURRENT  

| Parameter Name | Current    | Default | Minimum | Maximum | Unit         | Dynamic |
|----------------|------------|---------|---------|---------|--------------|---------|
| MAX_LOGINS     | 60         | 60      | 0       | -1      | submitters   | D       |
| MAX_TTS_CP     | 20         | 20      | 0       | -1      | terminals    | D       |
| PERM_CPS       | 1          | 1       | 0       | -1      | command prcs | D       |
| CP_SLOTS       | 3          | 3       | 0       | -1      | command prcs | D       |
| MIN_CPIS       | 2          | 2       | 0       | -1      | CP threads   | D       |
| TSC_USERNAME   | ACMSSYSTEM | SYSTEM  |         |         | VMS username |         |
| TSC_PRIORITY   | 6          | 4       | 0       | 31      | VMS priority |         |

This command displays information for parameters that affect the TSC, including the values now in the work area.

3. ACMSGEN> USE ACTIVE  
ACMSGEN> SHOW/ALL

The USE ACTIVE command places active values for all parameters into the work area. The SHOW command displays information for all parameters, including the active values in the work area.

4. ACMSGEN> USE WORK  
ACMSGEN> SHOW/TSC

The USE command initializes the work area with values from the file SYS\$SYSTEM:WORK.ACM. The SHOW command displays information about parameters affecting the TSC, including their work file values from the work area.



---

## USE Command (ACMSGEN>)

Initializes the ACMSGEN work area with values from a work file.

### Format

USE file-spec

### Privileges Required

None

### Parameters

#### **file-spec**

The file specification of the parameter file you created with the WRITE command. SYS\$SYSTEM is the default device and directory for the file. The default file type is .ACM.

### Notes

If the work area does not contain work file values, initialize the work area with the USE command before performing any operation (such as display or update) with values from a work file.

### Examples

1. ACMSGEN> USE WORK  
ACMSGEN> WRITE ACTIVE

These commands update the active values for dynamic parameters with values from a work file, WORK.ACM. The USE command initializes the work area with values from the work file. The WRITE ACTIVE command copies values for dynamic parameters from the work area to the global section for active values.

2. ACMSGEN> USE WORK  
ACMSGEN> WRITE CURRENT

These commands update current values with values from the work file WORK.ACM. The WORK.ACM file contains values from an earlier ACMSGEN session. The USE command initializes the work area with values from the WORK.ACM file. The WRITE CURRENT command copies values from the ACMSGEN work area to the SYS\$SYSTEM:ACMSPAR.ACM file.

## USE ACTIVE

---

### USE ACTIVE Command (ACMSGEN>)

Initializes the ACMSGEN work area with active values for all parameters from an ACMS system global section.

#### Format

USE ACTIVE

#### Privileges Required

None

#### Notes

Active values are used by an active ACMS system. ACMS keeps active values in a system global section. The global section can receive active values in two ways:

- When you use a `WRITE ACTIVE` command, ACMS writes values from the work area to the global section.
- When you use an `ACMS START /SYSTEM` command from the DCL prompt, ACMS copies values from the `SYS$SYSTEM:ACMSPAR.ACM` file to the global section.

If the work area does not contain active values, initialize the work area with the `USE ACTIVE` command before performing any operation, such as display or update, with active values.

If the ACMS system is inactive when you use the `USE ACTIVE` command, you receive an error message. Values in the work area do not change.

## Examples

1. ACMSGEN> USE ACTIVE  
ACMSGEN> WRITE WORK

These commands place a copy of the active values for all parameters in the work file, SYS\$SYSTEM:WORK.ACM. The USE ACTIVE command initializes the work area with active values for all parameters. The WRITE command copies all values in the work area to the work file.

2. ACMSGEN> USE ACTIVE  
ACMSGEN> SET MIN\_CPIS 2  
ACMSGEN> WRITE ACTIVE

These commands change the active value for MIN\_CPIS to 2. The USE ACTIVE command initializes the work area with active values for all parameters. The SET command places 2 in the work area as the value for MIN\_CPIS. The WRITE ACTIVE command copies the values for dynamic parameters from the work area to the global section for active values.

3. ACMSGEN> USE ACTIVE  
ACMSGEN> WRITE CURRENT

These commands use active values to update current values for dynamic parameters. The USE ACTIVE command initializes the work area with active values for all parameters. The WRITE CURRENT command copies the values from the work area to the SYS\$SYSTEM:ACMSPAR.ACM file as new current values.

## USE CURRENT

---

### USE CURRENT Command (ACMSGEN>)

Initializes the ACMSGEN work area with current values for all parameters from the SYS\$SYSTEM:ACMSPAR.ACM parameter file.

#### Format

USE CURRENT

#### Privileges Required

None

#### Notes

Current values are the values used to initialize ACMS. By default, ACMSGEN initializes the ACMSGEN work area with current values. Often you can display or update current values without initializing the work area explicitly.

#### Examples

1. ACMSGEN> USE CURRENT  
ACMSGEN> SET PERM\_CPS 2  
ACMSGEN> WRITE CURRENT

These commands change the current value for PERM\_CPS to 2. The USE CURRENT command initializes the work area with current values. The SET command places 2 in the work area as the value for PERM\_CPS. The WRITE CURRENT command updates the values in the SYS\$SYSTEM:ACMSPAR.ACM file with values from the work area.

2. ACMSGEN> USE CURRENT  
ACMSGEN> WRITE WORK

The USE CURRENT command initializes the work area with current values. The WRITE command copies values from the work area to the work file, SYS\$SYSTEM:WORK.ACM.

3. ACMSGEN> USE CURRENT  
ACMSGEN> WRITE ACTIVE

These commands use current values to update the active values of dynamic parameters. Recent changes to current values can take effect immediately for some parameters. The USE CURRENT command initializes the work area with current values for all parameters. The WRITE ACTIVE command copies values for dynamic parameters from the work area to the global section for active values.

---

## USE DEFAULT Command (ACMSGEN>)

Initializes the ACMSGEN work area with ACMS default values for all ACMS parameters.

### Format

USE DEFAULT

### Privileges Required

None

### Notes

If the work area does not contain default values, initialize the work area with the USE DEFAULT command before performing any operation, except display, with ACMS default values. You cannot change values in the default list.

For a list of the default values for ACMSGEN parameters, see Table 11–3.

### Examples

1. ACMSGEN> USE DEFAULT  
ACMSGEN> WRITE ACTIVE

These commands reset the active values for dynamic parameters to ACMS default values. The USE DEFAULT command initializes the work area with ACMS default values. The WRITE ACTIVE command writes values for dynamic parameters from the work area to the global section for active values.

2. ACMSGEN> USE DEFAULT  
ACMSGEN> WRITE CURRENT

These commands reset current values to ACMS default values. The USE DEFAULT command initializes the work area with ACMS default values. The WRITE CURRENT command writes values from the work area to the SYS\$SYSTEM:ACMSPAR.ACM file as current values for all ACMS parameters.

# WRITE

---

## WRITE Command (ACMSGEN>)

Writes values from the ACMSGEN work area to a work file, creating a new version of the file.

### Format

WRITE file-spec

### Privileges Required

None

### Parameters

#### file-spec

The file specification of the work file where you want ACMSGEN to write the parameter work area. The file specification cannot be an existing version of a file. SYS\$SYSTEM is the default device and directory. The default file type is .ACM. There is no default file name.

### Notes

Use the SHOW command to check that the work area contains the appropriate values before using the WRITE command.

### Examples

1. ACMSGEN> WRITE WORK

This command writes values from the ACMSGEN work area to the work file SYS\$SYSTEM:WORK.ACM, creating a new version of the file.

2. ACMSGEN> USE ACTIVE  
ACMSGEN> WRITE WORK

These commands copy active values for dynamic parameters to a work file. The USE ACTIVE command initializes the work area with active values for all parameters. The WRITE command writes values from the work area to the WORK.ACM work file, creating a new version of the file.

---

## WRITE ACTIVE Command (ACMSGEN>)

Changes active values for dynamic parameters by writing values from the ACMSGEN work area to an ACMS system global section.

### Format

WRITE ACTIVE

### Privileges Required

OpenVMS OPER privilege

### Notes

The WRITE ACTIVE command updates active values for any of the following parameters:

- MAX\_LOGINS
- MAX\_TTS\_CP
- MIN\_CPIS
- MSS\_NET\_RETRY\_TIMER
- PERM\_CPS
- QTI\_POLLING\_TIMER
- QTI\_SUB\_TIMEOUT
- QTI\_RETRY\_TIMER
- USERNAME\_DEFAULT

For other parameters, you can change current values only.

Use the SHOW command to check that the work area contains the appropriate values before using the WRITE ACTIVE command. New active values last until the system stops or until you change them again. If the system is inactive when you use the WRITE ACTIVE command, you receive an error message, and no changes are made.

### Examples

1. ACMSGEN> USE ACTIVE  
ACMSGEN> SET PERM\_CPS 2  
ACMSGEN> WRITE ACTIVE

These commands change the active values for PERM\_CPS to 2. The USE ACTIVE command initializes the work area with active values for all parameters. The SET command places 2 in the work area as the value for PERM\_CPS. The WRITE ACTIVE command writes the values for dynamic parameters from the work area to the system global section containing values for the active system.

## WRITE ACTIVE

2. ACMSGEN> USE DEFAULT  
ACMSGEN> WRITE ACTIVE

These commands reset the active values for dynamic parameters to ACMS default values. The USE DEFAULT command initializes the work area with default values for all parameters. The WRITE ACTIVE command updates active values for dynamic parameters with values from the ACMSGEN work area.



---

## WRITE CURRENT Command (ACMSGEN>)

Changes current values by writing values from the ACMSGEN work area to the SYS\$SYSTEM:ACMSPAR.ACM file.

### Format

```
WRITE CURRENT
```

### Privileges Required

Write access to the SYS\$SYSTEM directory. The OpenVMS privilege SYSPRV or a system UIC gives you write access to SYS\$SYSTEM.

### Notes

Use the SHOW command to check that the work area contains the appropriate values before using the WRITE CURRENT command.

When you use an ACMS START /SYSTEM command, ACMS initializes the global section for active values with values from the ACMSPAR.ACM file.

### Examples

1. ACMSGEN> SET PERM\_CPS 3  
ACMSGEN> WRITE CURRENT

These commands change the current value of PERM\_CPS to 3. By default, the work area contains current values. The SET command changes the value for PERM\_CPS in the work area to 3. The WRITE CURRENT command writes values from the work area to the SYS\$SYSTEM:ACMSPAR.ACM file as new current values for ACMS.

2. ACMSGEN> USE DEFAULT  
ACMSGEN> WRITE CURRENT

These commands reset the current values of ACMS to defaults. The USE DEFAULT command initializes the work area with default values. The WRITE CURRENT command copies values from the work area to the SYS\$SYSTEM:ACMSPAR.ACM file as new current values for ACMS.



---

## ATR Commands

This chapter contains reference information and examples for the ACMS Audit Trail Report (ATR) Utility commands. See Chapter 12 for general information about the ATR Utility.

# EXIT

---

## EXIT Command (ATR>)

Ends the ATR Utility session and returns you to the DCL prompt.

### Format

EXIT

### Privileges Required

None

### Notes

You can also end an ATR session with a controlled exit by pressing `Ctrl/Z`. `Ctrl/Z` signals the end of the file for data entered from the terminal. `Ctrl/Z` is displayed as EXIT.

### Example

```
ATR> EXIT
```

This command ends an ATR Utility session and returns you to the DCL prompt.

---

## HELP Command (ATR>)

Displays information about ATR Utility commands and their qualifiers.

### Format

```
HELP [topic [...]]
```

### Privileges Required

None

### Parameters

**topic**

The ATR topic you want to know about. If you do not specify a topic, ACMS displays a list of topics for you to choose from.

### Notes

None

### Example

```
ATR> HELP ERRORS
 Audit/Trace Message Formats

 Additional information available:
 BYNAME ENDTOOSOON IDLOGGONE INVID NOTYPE REC_CORRUPT
ERRORS Subtopic?
```

This command displays help information about the audit trail error messages.

## LIST

---

### LIST Command (ATR>)

Produces a report about information in the audit trail log file. You can limit the amount of information in the report by using qualifiers.

#### Format

LIST [ file-spec ]

| Command Qualifiers            | Defaults              |
|-------------------------------|-----------------------|
| /APPLICATION=application-name | All application names |
| /BEFORE[=time]                | Full report           |
| /BRIEF                        | Full report           |
| /IDENTIFICATION=task-id       | All task IDs          |
| /OUTPUT=file-spec             | SYS\$OUTPUT           |
| /SINCE[=time]                 | Full report           |
| /SUBMITTER=submitter-id       | All submitter IDs     |
| /TASK=task-name               | All task names        |
| /TERMINAL=device-name         | All device names      |
| /TYPE=type                    | All types             |
| /USERNAME=user-name           | All user names        |

#### Privileges Required

OpenVMS SYSPRV

#### Parameters

##### file-spec

The file specification of the audit trail log file that is used to generate the report. The file specification can be any version of the audit trail log or a concatenated file containing several audit trail log files. If you do not supply a file specification, the file defined as ACMS\$AUDIT\_LOG is used. If the ACMS\$AUDIT\_LOG logical is undefined and you omit the file specification, the default file specification SYS\$ERRORLOG:ACMSAUDIT.LOG is used. If you supply only a partial file specification, missing parts are taken from SYS\$ERRORLOG:ACMSAUDIT.LOG.

#### Qualifiers

##### /APPLICATION=application-name

Limits the report to records involving the application you name. Application-name is the file name of an application database.

##### /BEFORE[=time]

Limits the report to records logged before the time you specify. Specify time as an OpenVMS absolute time. If you specify the /BEFORE qualifier without a time argument, the default is /BEFORE=TODAY. If you do not specify the /BEFORE qualifier, a full report is displayed. You can use the /SINCE qualifier with the /BEFORE qualifier.

##### /BRIEF

Limits the length of records in the report. Each record in a brief report contains the time of the entry in the audit trail log and the type of information in the entry. For a description of record types, see the description of the /TYPE qualifier. If you do not use the /BRIEF qualifier, you get a full report.

**/IDENTIFICATION=task-id**

Limits the report to records generated by the specified task ID. The task ID is the unique identification code ACMS assigns to an active task. See Section 12.6.1 for a description of the task ID format and how to specify a task ID.

**/OUTPUT=file-spec**

Writes an ACMS Log Report to the output file you name. Output goes to SYS\$OUTPUT by default.

**/SINCE[=time]**

Limits the report to records logged after the time you specify. Specify the time as an OpenVMS absolute time. If you specify the /SINCE qualifier without the time argument, the default is /SINCE=TODAY. If you do not specify the /SINCE qualifier, the default is a full report. You can use the /SINCE qualifier with the /BEFORE qualifier.

**/SUBMITTER=submitter-id**

Limits the report to records generated by the specified submitter ID. The submitter ID is the unique task submitter code ACMS assigns to an ACMS user at sign-in. The submitter ID begins with the name of the node on which the user signed in. You can omit leading zeros in the submitter ID. See Section 12.6.1 in Chapter 12 for a description of the submitter ID format and of how to specify a submitter ID.

**/TASK=task-name**

Limits the report to records that match the task name you specify. The task name is the name defined in the application definition.

**/TERMINAL=device-name**

Limits the report to records of sign-ins and sign-outs from the specified terminal. Device-name is the name of a terminal that runs ACMS tasks. You must end the device name with a colon (:).

**/TYPE=type**

Limits the report to records of one type. The possible types of reports are:

- ALL—generates a report on all records. ALL is the default.
- COMMAND—generates a report on ACMS operator commands.
- ERROR—generates a report on errors.
- LOGIN—generates a report on all sign-ins and sign-outs.
- OTHER—generates a report that tells you when the Audit Trail Logger is enabled or disabled, opened or closed, and logs each use of the ACMS/RESET AUDIT command.
- TASK—generates a report on task information, excluding errors.

**/USERNAME=user-name**

Limits the report to records generated by the specified user name.

# LIST

## Notes

If you use the LIST command without qualifiers, the ATR report includes all records in the input file.

Press the PF1 and PF2 keypad keys for access to a keypad of ATR commands. Press **[Ctrl/B]** to recall each ATR command you enter.

When you use ATR to read information from the latest version of the audit trail log while the Audit Trail Logger is active, audit trail information may be a few seconds behind ACMS activity. Records are forced out to the audit trail log file based on both the number of records that have been written since the last forced write, and the time elapsed since the last request was responded to.

## Examples

1. ATR> LIST/SINCE=09-MAR-1994 9:00/BEFORE=09-MAR-1994 10:00

This command displays all records written between 9 and 10 a.m. on March 9, 1994.

2. ATR> LIST/APPLICATION=TEST/OUTPUT=AUDITRPT.LIS

This command writes records for the application TEST to the output file AUDITRPT.LIS.

3. ATR> LIST/BRIEF

This command displays partial records, including the time of each entry and the type of information recorded.

4. ATR> LIST/IDENTIFIER=-1

This command lets you see the first task selection for each submitter. You specify only the sequence number on the /IDENTIFIER qualifier. Because you omit the local ID field, you indicate that you are omitting that field by using a dash.

5. ATR> LIST/TASK=UPDATE/OUTPUT=AUDITRPT.LIS

This command writes records for the Update task to the listing file AUDITRPT.LIS.

6. ATR> LIST/TERMINAL=TTA5:

This command displays all sign-ins and sign-outs from terminal TTA5.

7. ATR> LIST/TYPE=COMMAND

This command displays all instances of operator command usage.

8. ATR> LIST/TYPE=ERROR

This command displays records of errors.

9. ATR> LIST/TYPE=LOGIN

This command displays sign-ins and sign-outs for all users on an ACMS system.



10. ATR> LIST/TYPE=TASK

This command displays all records involving tasks.

11. ATR> LIST/TYPE=OTHER

This command displays records of when the audit trail log is opened and closed, when the Audit Trail Logger is enabled and disabled, and when the audit trail log is renewed with the ACMS/RESET AUDIT command.

12. ATR> LIST/USERNAME=CONNOR

This command displays records for a user or users signed in under the user name CONNOR.



---

## SWLUP Commands

This chapter contains reference information and examples for the ACMS Software Event Log Utility Program (SWLUP) commands. See Chapter 13 for general information about SWLUP.

## @ (At sign)

---

### @ (At sign) Command (SWLUP>)

Runs an indirect command file that contains SWLUP commands.

#### Format

@file-spec

#### Privileges Required

None

#### Parameters

##### **file-spec**

The name of a command file for SWLUP to run. Use a standard OpenVMS file specification. If you do not include the directory in the file specification, SWLUP searches your current directory by default. SWLUP uses SYS\$DISK:[].COM as the default file type.

#### Notes

SWLUP runs all commands stored in the command file you specify. SWLUP sends your reports to the default output device SYS\$OUTPUT.

You must use the SET VERIFY command before SWLUP can display commands in the indirect command file. Errors are reported on SYS\$OUTPUT and on SYS\$ERROR if SYS\$ERROR is different from SYS\$OUTPUT.

#### Example

```
SWLUP> @REPORT
```

SWLUP runs the file REPORT.COM, which contains the commands to list all today's events.

---

## EDIT Command (SWLUP>)

Lets you edit the last SWLUP command you entered and lets you create an edit buffer into which you can enter SWLUP commands.

### Format

EDIT

### Privileges Required

None

### Notes

You can use the EDIT command in two ways:

- Within SWLUP, you can type the EDIT command after you type a SWLUP command (such as SET LOG, SET NOVERIFY). SWLUP places the command in the edit buffer. You can correct or change the SWLUP command using a text editor.
- You can type the EDIT command at the SWLUP> prompt. SWLUP then provides an edit file into which you can enter SWLUP commands with a text editor.

When you exit the editor, SWLUP runs the commands in the file and returns to the SWLUP> prompt. If you exit the editor without creating an output file, SWLUP prints the error message %SWLUP-E-ERRREDIT, does not try to run the last command, and returns to the SWLUP> prompt.

The ACMS system startup file, ACMSTART.COM defines the system logical SWLUP\$EDIT to be ACMS\$EDIT. As system manager, you can define ACMS\$EDIT to be TDMSEEDIT.COM (which runs the TDMS text editor), ACMSEEDIT.COM (which runs the EDT text editor), or a personal command procedure that invokes another text editor or a particular set of editor startup commands. When you issue the EDIT command, ACMS executes the command file pointed to by ACMS\$EDIT.

### Examples

1. SWLUP> EDIT  
LIST /PROCESS\_NAME=JACK\_SMITH  
[Ctrl/Z]  
DBA0:[SMITH]SWLUP\_C20205018.COM;1 1 LINE  
SWLUP>

The EDIT command typed at the SWLUP> prompt displays an edit buffer into which you can enter the SWLUP commands.

## EDIT

```
2. SWLUP> SET NOLOG
 SWLUP> SET VERIFY
 SWLUP> EDIT
 SET VERIFY
 Ctrl/Z
 DBA0:[SMITH]SWLUP_C_C20203098.COM;2 1 LINE
 SWLUP>
```

If you enter SWLUP commands and type the EDIT command at the SWLUP prompt, the last command you entered is placed in the edit buffer.

---

## EXIT Command (SWLUP>)

Causes SWLUP to exit or ends the execution of a command file.

### Format

EXIT

### Privileges Required

None

### Notes

SWLUP exits from either the utility or a command file. You can also end a SWLUP session by pressing `Ctrl/Z`. `Ctrl/Z` signals the end of the file for data entered from the terminal. `Ctrl/Z` is displayed as EXIT.

### Examples

1. SWLUP> EXIT  
\$

The EXIT command ends the SWLUP session and returns control to the DCL prompt.

2. SWLUP> @LISTIT  
SET LOG !These lines are in the file LISTIT.COM  
SET VERIFY  
EXIT

This command ends the processing of commands from an indirect command file and returns to the SWLUP> prompt.

# HELP

---

## HELP Command (SWLUP>)

Displays information about SWLUP commands and qualifiers.

### Format

HELP [ topic [...]]

| Command Qualifier | Default |
|-------------------|---------|
| /[NO]PROMPT       | /PROMPT |

### Privileges Required

None

### Parameters

#### topic

The SWLUP command or topic that you want to display information about. If you use the HELP command without a topic, help provides a list of topics to choose from.

### Qualifiers

#### /[NO]PROMPT

Determines whether or not SWLUP displays help information and then displays a prompt for a topic or subtopic. The /PROMPT qualifier is the default.

### Notes

None

### Example

```
SWLUP> HELP SET
```

```
SET
```

```
Determines if commands are logged to a file or whether commands from an indirect command file are printed to the default output device.
```

```
Format:
```

```
SET [NO]LOG
SET [NO]VERIFY
```

```
Additional information available:
```

```
[NO]LOG [NO]VERIFY
```

```
SET Subtopic?
```

Type Help followed by the SET command to get information about SET [NO]LOG and SET [NO]VERIFY. If you type either [NO]LOG or [NO]VERIFY at the SET Subtopic? prompt, SWLUP displays information about the qualifier you requested.



---

## LIST Command (SWLUP>)

Lists information selected by command qualifiers.

### Format

LIST [ EVENTS ]

#### Command Qualifiers

/BEFORE[=time]  
 /EVENT\_CODE=event-code[,...]  
 /FACILITY=facility-name[,...]  
 /IMAGE=image-name[,...]  
 /INPUT=file-spec  
 /OUTPUT=file-spec  
 /PRINT  
 /PROCESS\_NAME=process-name[,...]  
 /SEVERITY=severity-code[,...]  
 /SINCE[=time]  
 /USER=user-name[,...]

#### Default

/BEFORE=TODAY  
 All event codes  
 All facilities  
 All images  
 SYS\$ERRORLOG:SWL.LOG  
 SYS\$OUTPUT  
 Does not print  
 All processes  
 All severity codes  
 /SINCE=TODAY  
 All user names

### Privileges Required

None

### Qualifiers

#### **/BEFORE[=time]**

Lists only those events dated before the time you name. This qualifier and the /SINCE qualifier let you select a range of time. You need not use the qualifiers together. The format for date and time is dd-mmm-yyyy:hh:mm, which allows you to omit any of the trailing fields. You can also use the keywords TODAY or YESTERDAY to specify a time. The default is /BEFORE=TODAY. If you specify a date without a time, the time defaults to 00:00.00 for the date you specify.

#### **/EVENT\_CODE=event-code[,...]**

Selects events by return status code. For example, you can list all ACMSI-F-BUGLOG errors by typing /EVENT=BUGLOG or /EVENT=(BUGLOG). Logging all events to the current log file is the default.

#### **/FACILITY=facility-name[,...]**

Selects a list of events logged by one or more facility names you specify. The only facilities that log events in the Software Event Log are ACMS and SWL. ACMS software errors are logged under the name ACMSI. Logging all events to the current log file is the default.

#### **/IMAGE=image-name[,...]**

Selects the events associated with one or more image names you specify. Logging all events to the current log file is the default. If you specify only part of an image name, SWLUP lists all images whose names contain the specified characters.

#### **/INPUT=file-spec**

Names the input log file you want to read. If you do not use the /INPUT qualifier, SWLUP uses SYS\$ERRORLOG:SWL.LOG by default.

## LIST

### **/OUTPUT=file-spec**

Stores SWLUP output in a file you specify. If you do not use the /OUTPUT qualifier, SWLUP sends output to the default output device SYS\$OUTPUT.

### **/PRINT**

Prints a listing file on the system printer. If you do not use the /OUTPUT qualifier with the /PRINT qualifier, SWLUP creates a temporary listing file (SWLUPLIS.LIS) and deletes it after the file is printed. If you do not specify the /PRINT qualifier, the file is not printed.

### **/PROCESS\_NAME=process-name[,...]**

Selects all events logged with one or more process names you specify. Logging all events to the current log file is the default.

### **/SEVERITY=severity-code[,...]**

Selects the events for a SWLUP report by the OpenVMS severity code. You can use complete severity code names or abbreviate them to the first character:

- Success
- Informational
- Warning
- Error
- Fatal

Logging all events to the current log file is the default.

### **/SINCE[=time]**

Identifies only those events dated after the date and time you specify. This qualifier and the /BEFORE qualifier let you define a range of time for the events logged. The format for time is dd-mmm-yyyy:hh:mm. You can also specify the keywords TODAY or YESTERDAY. If you specify any part of the date, you must specify the full date. You can omit the time field. The default is /SINCE=TODAY.

### **/USER=user-name[,...]**

Selects all events logged with one or more user names. Logging all events in the current log file is the default.

## Notes

ACMS logs ACMS internal software errors and some SWL events of varying severity. For example, you might want to look at just the ACMS errors; by using this command you can create a file of just those errors.

## Examples

1. SWLUP> LIST/USER=RICH

This command lists all events in the log file associated with the user name RICH.

2. SWLUP> LIST EVENTS/FACILITY=TSS/SEVERITY=F/BEFORE=09-APR-1994

This command lists all events in the log file that are ACMS events, with an F severity code, logged before April 9, 1994.

3. SWLUP> LIST/PROCESS\_NAME=CPPROC/OUTPUT=SEPT21.LOG

This command lists all events in the log file associated with the process name CPPROC and places them in the output file SEPT21.LOG.

## RENEW

---

### RENEW Command (SWLUP>)

Starts a new systemwide SWL log file.

#### Format

RENEW

#### Privileges Required

Write access to the new log file and the OpenVMS privileges TMPMBX and SYSPRV.

#### Notes

The RENEW command closes the current log file and creates a new version. The log file is called SYS\$ERRORLOG:SWL.LOG.

If an SWL log file is not already opened and you use the RENEW command, you receive an error. You can determine whether SWL is currently logging information to a log file by using the SHOW LOG command.

#### Example

```
SWLUP> RENEW
```

Creates a new version of SYS\$ERRORLOG:SWL.LOG to log subsequent events.

---

## SAVE Command (SWLUP>)

Writes to a file the last command you typed.

### Format

SAVE file-spec

### Privileges Required

None

### Parameters

#### file-spec

The name of the file in which you want to save the last command. If you supply an incomplete file specification, the default disk is SYS\$DISK; the default directory is your current directory; and the default file type is .SAV.

### Notes

If the command you save is @file-spec, the contents of the file specification are also available in the target file.

### Example

```
SWLUP> LIST/SEVERITY=S
SWLUP> SAVE
SAVE TO FILE:KEEPIT
previous command SAVED to file DBA0:[SMITH]KEEPIT.SAV
SWLUP>
```

Type or print the file KEEPIT.SAV to see the command you entered with the SAVE command.

## SET [NO]LOG

---

### SET [NO]LOG Command (SWLUP>)

Enables or disables creation of a log file that records your SWLUP session.

#### Format

```
SET [NO]LOG [file_spec]
```

#### Privileges Required

None

#### Parameters

##### **file-spec**

The file specification of the log file. If you do not specify a file specification, SWLUP creates a new version of the current log file. If a current log file does not exist, SWLUP stores the information in the file SYS\$DISK:[ ]SWLUPLOG.LOG.

#### Notes

If you do not specify a file specification and a file was previously activated by the SET LOG command, SWLUP issues a warning message. If you specify a file that contains a version number and that file already exists, SWLUP stores all new information in that file.

The SET LOG and SET NOLOG commands are valid only within the current session. Once you exit from SWLUP, all SET [NO]LOG commands are deleted.

If you use SET NOLOG, SWLUP does not create a file.

#### Examples

1. SWLUP> SET LOG

SWLUP automatically enables logging of all commands you enter in the session to the SWLUPLOG.LOG file or to the logical translation of SWLUPLOG.

2. SWLUP> SET LOG SEPT21.LOG

This command enables logging to the SEPT21.LOG file.

---

## SET [NO]VERIFY Command (SWLUP>)

Enables or disables the printing of commands stored in an indirect command file. SWLUP sends output to the default output device SYS\$OUTPUT.

### Format

```
SET [NO]VERIFY
```

### Privileges Required

None

### Note

The default is SET NOVERIFY. To display the commands from an indirect command file to the default output device, SYS\$OUTPUT, use the SET VERIFY command.

### Examples

1. SWLUP> SET VERIFY  
SWLUP> @FIRSTLOG

This command places SWLUP in verify mode. When you pass the command file FIRSTLOG.COM to SWLUP, it displays the commands it runs from that file.

2. SWLUP> SET NOVERIFY  
SWLUP> @FIRSTLOG

This command places SWLUP in noverify mode. When you pass the command file FIRSTLOG.COM to SWLUP, it does not display the commands it runs from that file.

## SHOW CURRENT

---

### SHOW CURRENT Command (SWLUP>)

Displays the name of the current log file opened by the SWL detached process.

#### Format

SHOW CURRENT

#### Privileges Required

OpenVMS TMPMBX privilege

#### Notes

SWLUP displays the name of the current log file on SYS\$OUTPUT.

#### Example

```
SWLUP> SHOW CURRENT
%ACMSSWL-S-CURLOGFIL, Current log file: SYS$ERRORLOG:SWL.LOG;1
```

This command displays the name of the current log file.



---

## SHOW LOG Command (SWLUP>)

Displays whether or not you are currently logging SWLUP commands and the name of the log file.

### Format

```
SHOW LOG
```

### Privileges Required

None

### Notes

SWLUP displays the following information:

- The current SWLUP mode: logging or not logging
- The name of the file to which SWLUP is logging or not logging information. The default is NOLOG.

### Example

```
SWLUP> SHOW LOG
not logging to file SWLUPLOG.LOG
```

The SHOW LOG command shows you that SWLUP is not logging to the default file.

## SHOW VERSION

---

### SHOW VERSION Command (SWLUP>)

Displays the current version of SWLUP on the default output device SYS\$OUTPUT.

#### Format

SHOW VERSION

#### Privileges Required

None

#### Notes

None

#### Example

```
SWLUP> SHOW VERSION
ACMS SWLUP V4.0
```

This command displays the SWLUP version number.

---

## STOP Command (SWLUP>)

Stops the SWL detached process so that it can exit properly.

### Format

STOP

### Privileges Required

OpenVMS TMPMBX and SYSPRV privileges

### Notes

None

### Example

```
SWLUP> STOP
```

This command stops the SWL detached process.



---

## Parameter and Quota Calculations

Parameter and quota values needed to run the ACMS software are set by default or by the use of the ACMSPARAM.COM and ACMEXCPAR.COM command procedures. In some instances, you may want to further tune your system by altering those calculations.

The formulas in this appendix show how these recommended minimum settings are derived, and how to alter these calculations to reflect your specific system. The values shown in this appendix are guidelines.

If you change the calculations for any parameter, edit the ACMVARINI.DAT file to change the appropriate variable value corresponding to that parameter. The command procedure uses the changed variable value to calculate not only the parameter that you wish to recalculate, but any related parameters or quotas. Note, however, that ACMSPARAM.COM raises but does not lower a process quota or SYSGEN parameter based on your recalculations. The command procedure will raise or lower any other parameters as indicated by your recalculations.

---

### Note

---

ACMSPARAM.COM and ACMEXCPAR.COM do not support logical name search lists for the TDB file specifications.

---

The parameter and quota calculations described in this appendix are:

- OpenVMS SYSGEN parameters affected by ACMS
- Quotas for OpenVMS user names of ACMS processes, specifically:
  - OpenVMS user name under which the ACMS Central Controller (ACC) runs
  - OpenVMS user name under which the Terminal Subsystem Controller (TSC) runs
  - OpenVMS user name under which the Command Process (CP) runs
  - OpenVMS user name under which the Application Execution Controller (EXC) runs
  - OpenVMS user name under which the Queued Task Initiator (QTI) runs
  - Quotas and privileges required for ACMS server processes
- Quotas required for users of ADU
- Quotas required for users of the task debugger
- The following ACMSGEN parameters:
  - MAX\_LOGINS

## Parameter and Quota Calculations

- MSS\_MAXOBJ
- MSS\_MAXBUF
- MSS\_POOLSIZE
- MSS\_PROCESS\_POOL
- PERM\_CPS
- TWS\_POOLSIZE
- TWSC\_POOLSIZE
- WS\_POOLSIZE
- WSC\_POOLSIZE

The following sections contain the formula calculations used by ACMSPARAM.COM.

The formulas for SYSGEN parameters and for quotas needed for OpenVMS user names, ADU, and the task debugger use the variables discussed in Chapter 10. Refer to Table 10-3 and Table 10-5 for descriptions of the variables. See Chapter 11 for descriptions of the ACMSGEN parameters whose formula calculations are listed here.

### A.1 Calculating OpenVMS SYSGEN Parameters Affected by ACMS

ACMSPARAM.COM calculates values for OpenVMS system parameters that are affected by ACMS. The following subsections show how ACMSPARAM.COM determines the values for those OpenVMS SYSGEN parameters. Any time you install additional images you must adjust the SYSGEN parameters. Refer to Table 10-3 for descriptions of the variables shown in these calculations.

#### A.1.1 Calculating the Value of CHANNELCNT

```
CHANNELCNT = (MAX
 20 + ((2 * CONTROLLED_TERMINAL_CNT) +
 ENTERED_TERMINAL_CNT),
 20 + (2 * REMOTE_SUB_CNT) +
 TDB_CNT + RLB_CNT,
 23 + (5 * TERMINALS_PER_CP) +
 FORM_TRACE_FILE_CNT +
 + FORM_CNT + ESC_RTN_IMAGE_CNT +
 REMOTE_RLB_CNT +
 (2 * REMOTE_APPL_CNT)
)
```

Include 20% for expansion, and then round to next 10:

```
CHANNELCNT = (((CHANNELCNT + CHANNELCNT / 5) / 10) + 1) * 10
```

#### A.1.2 Calculating the Value of GBLPAGES

```
GBLPAGES = BASE + ! GBLPAGES value without ACMS
 1506
 MSS_POOLSIZE +
 (DEBUGGER_CNT * (TWS_POOLSIZE+TWSC_POOLSIZE)) +
 DEBUG_TDB_BLKES +
 (TDB_CNT * (TWS_POOLSIZE+TWSC_POOLSIZE)) +
 TDB_BLKES +
 ADB_BLKES +
 MDB_BLKES
```

## Parameter and Quota Calculations

### A.1 Calculating OpenVMS SYSGEN Parameters Affected by ACMS

Include 20% for expansion, and then round to next  
 100 pagelets (Alpha and I64):

$$\text{GBLPAGES} = (((\text{GBLPAGES} + \text{GBLPAGES}/5) / 100) + 1) * 100$$

#### A.1.3 Calculating the Value of GBLPAGFIL

$$\begin{aligned} \text{GBLPAGFIL} = & \text{BASE} + && ! \text{GBLPAGFIL value without ACMS} \\ & 4 + \\ & \text{MSS\_POOLSIZE} + \\ & (\text{DEBUGGER\_CNT} * (\text{TWS\_POOLSIZE} + \text{TWSC\_POOLSIZE})) + \\ & (\text{TDB\_CNT} * (\text{TWS\_POOLSIZE} + \text{TWSC\_POOLSIZE})) \\ & \text{Include 20\% for expansion, and then round to next} \\ & \text{100 pagelets (Alpha and I64):} \\ \text{GBLPAGFIL} = & (((\text{GBLPAGFIL} + \text{GBLPAGFIL}/5) / 100) + 1) * 100 \end{aligned}$$

On Alpha, the GBLPAGFILE must be converted from pagelets to physical pages as follows:

$$\text{GBLPAGFIL} = (\text{GBLPAGFIL} + (\text{PAGESIZE}/512) - 1) / (\text{PAGESIZE}/512)$$

#### A.1.4 Calculating the Value of GBLSECTIONS

$$\begin{aligned} \text{GBLSECTIONS} = & \text{BASE} + && ! \text{GBLSECTIONS value without ACMS} \\ & 44 + \\ & (\text{DEBUGGER\_CNT} * 3) + \\ & (\text{TDB\_CNT} * 3) + \\ & \text{APPL\_CNT} + \text{REMOTE\_APPL\_CNT} + \\ & \text{MDB\_CNT} \\ & \text{Include 20\% for expansion, and then round to next 10 sections:} \\ \text{GBLSECTIONS} = & (((\text{GBLSECTIONS} + \text{GBLSECTIONS}/5) / 10) + 1) * 10 \end{aligned}$$

#### A.1.5 Calculating the Value of LOCKIDTBL

$$\begin{aligned} \text{LOCKIDTBL} = & \text{BASE} + && ! \text{LOCKIDTBL value without ACMS} \\ & 100 + \\ & (\text{CP\_PROC\_CNT} * 4) + \\ & (\text{RLB\_CNT} * 4) + \\ & (\text{DYN\_SP\_CNT} * 4) + \\ & (\text{QTI\_QUEUES} * 3) + \\ & (\text{QTI\_TASK\_THDS} * 15) \\ & \text{Include 20\% for expansion, and then round to next 10 table entries:} \\ \text{LOCKIDTBL} = & (((\text{LOCKIDTBL} + \text{LOCKIDTBL}/5) / 10) + 1) * 10 \\ \text{VIRTUALPAGECNT} = & (((\text{PGFLQUOTA} + && ! \text{Use the highest PGFLQUOTA} \\ & \text{PGFLQUOTA}/5) / 10) + 1) * 10 && ! \text{from among CP, ACC, TSC,} \\ & && ! \text{QTI, or EXC PGFLQUOTAs} \end{aligned}$$

#### A.1.6 Task Debugger Parameters and Values

The following SYSGEN parameters should be set when you use the task debugger:

| Parameter     | Value                                                            |
|---------------|------------------------------------------------------------------|
| PQL_DASTLM    | 20                                                               |
| PQL_DDIOLM    | 20                                                               |
| PQL_DBIOLM    | 12                                                               |
| PQL_DWSQUOTA  | Greater than or equal to the block size of the largest .TDB file |
| PQL_DWSEXTENT | Greater than or equal to the block size of the largest .TDB file |
| PQL_MDIOLM    | 20                                                               |

## Parameter and Quota Calculations

### A.2 Calculating Quotas for OpenVMS User Names of ACMS Processes

#### A.2 Calculating Quotas for OpenVMS User Names of ACMS Processes

The following sections show how quotas are set for the various user names under which ACMS components run. HP recommends you use the ACMSPARAM.COM procedure to set the quota values for the ACC, TSC, CP, and QTI. Use the formulas shown here for informational or fine-tuning purposes only.

The user name quotas for the ACC, TSC, CP, and QTI are defined from the values set by the ACMSPARAM.COM procedure. (The user names can also be derived from the values set by the ACMSGEN Utility.) The user names for the EXC and the server processes, discussed later in this chapter, are derived from the application definition using the ACMEXCPAR.COM procedure.

When updating the accounts for ACC, TSC, CP, EXC, and QTI, a quota is updated only if the calculated quota is larger than the current quota for the account. This is to prevent the possible introduction of quota problems should the account be used for purposes other than running ACMS. ACMSPARAM.COM and ACMEXCPAR.COM do not allow calculated quotas to be lower than HP suggested default values. The default values used are from OpenVMS VAX Version 6.0 and OpenVMS Alpha Version 1.5. For several quotas ACMSPARAM.COM and ACMEXCPAR.COM do not create values. Instead, ACMS takes the quota values from the DEFAULT account in AUTHORIZE. If you lower any DEFAULT account quotas, be aware that problems can occur while starting or running ACMS.

By assigning different user names to the ACC, TSC, CP, and QTI, you can individually set quotas to ensure the best allocation of resources. You can, however, run the ACC, TSC, CP, and QTI under one user name. If you do this, it is best to maximize the values for all ACC, TSC, CP, and QTI quotas. You normally run the EXC under a user name different from that of the ACC, TSC, CP, and QTI. Run the server processes under additional user names as required.

---

#### Note

---

ACMSPARAM.COM and ACMEXCPAR.COM calculate quotas for the platform they are executing on. If you are using a common SYSUAF.DAT file for a mixed OpenVMS Cluster, then the quotas generated for Alpha will probably not be appropriate for VAX and the quotas generated on VAX will probably not be appropriate for Alpha. See *A Comparison of System Management on OpenVMS AXP and OpenVMS VAX* for more information.

---

#### A.2.1 User Name Setup for the ACC

The OpenVMS user name under which the ACC runs requires the privilege SETPRV.

The values shown in Table A-1 determine the minimum quotas necessary for the OpenVMS user name under which the ACC runs. To set this user name, use the ACC\_USERNAME parameter with the ACMSPARAM.COM procedure or the ACMSGEN Utility.

If large number of users are signed in by user-written agents or by the QTI, you may need to fine-tune the working set. See Section A.5.1 for details.



## Parameter and Quota Calculations

### A.2 Calculating Quotas for OpenVMS User Names of ACMS Processes

**Table A-1 Minimum Quotas for the ACC User Name Process**

| Parameter | Minimum Value |       |
|-----------|---------------|-------|
|           | Alpha         | I64   |
| ASTLM     | 250           | 250   |
| BIOLM     | 150           | 150   |
| BYTLM     | 64000         | 64000 |
| DIOLM     | 150           | 150   |
| ENQLM     | 2000          | 2000  |
| FILLM     | 100           | 100   |
| PGFLQUOTA | 50000         | 50000 |
| TQELM     | 10            | 10    |
| WSDEFAULT | 2000          | 2000  |
| WSEXTENT  | 16384         | 16384 |
| WSQUOTA   | 4000          | 4000  |

WSEXTENT is usually higher than WSQUOTA to make the most of the OpenVMS dynamic working set size adjustment algorithms. To set reasonable figures, monitor the live system to determine the page fault rate of the ACC process.

Also, because the Audit Trail Logger process runs under the user name of the ACC, that user name must have write access to the audit trail log file.

If you have a large number of users signing in by user-written agents or the QTI, you may need to increase the working set quotas. See Section A.5.1.

#### A.2.1.1 How ACMSPARAM.COM Calculates Values for the ACC

This section shows the formulas for how ACMSPARAM.COM calculates parameter values for the ACC. If the calculated values are below the minimum values shown in Table A-1, then ACMSPARAM.COM assigns the minimum values.

Refer to Table 10-3 for descriptions of the variables shown in these calculations.

##### ASTLM

```

ASTLM = 28 +
 (4 * remote_node_cnt) +
 remote_sub_cnt +
 terminal_cnt +
 remote_appl_cnt +
 operator_cnt +
 agent_sub_cnt +
 qti_submitters

```

! base  
! DECnet channel i/o  
! for remote authentication  
! for local authentication  
!  
!  
!  
! for ACMS operator commands

##### BIOLM

```

BIOLM = 20 +
 (4 * REMOTE_NODE_CNT)

```

! base  
! MSS DECnet send/receive QIOs

##### BYTLM

```

BYTLM = 20000 +
 (4 * REMOTE_NODE_CNT)
 * MSS_MAXBUF

```

! base  
! MSS DECnet i/o

## Parameter and Quota Calculations

### A.2 Calculating Quotas for OpenVMS User Names of ACMS Processes

#### ENQLM

```
ENQLM = 100 + ! base
 agent_sub_cnt + !
 remote_sub_cnt + ! for remote authentication
 terminal_cnt + ! for local authentication
 qti_submitters !
```

#### FILLM

```
FILLM = 20 + ! base
 MDB_CNT + ! MDBs
 APPL_CNT + ! local ADBs
 REMOTE_APPL_CNT + ! remote ADBs
 (2 * REMOTE_NODE_CNT) ! DECnet channels
```

#### PGFLQUOTA

```
PGFLQUOTA = 4096 + ! base
 MSS_PROCESS_POOL + ! MSS pool
 (MSS_MAXBUF + (154 *
 (APPL_CNT + REMOTE_APPL_CNT))) +
 (((2 * REMOTE_NODE_CNT / 8) + 1) * 8 * MSS_MAXBUF) +
 512) / 512
```

#### A.2.2 User Name Setup for the TSC

The OpenVMS user name under which the TSC runs, defined by the ACMSGEN parameter TSC\_USERNAME, must have the privilege SETPRV.

The minimum quotas shown in Table A-2 are necessary for the OpenVMS user name under which the TSC runs.

**Table A-2 Minimum Quotas for the TSC User Name Process**

| Parameter | Minimum Value |       |
|-----------|---------------|-------|
|           | Alpha         | I64   |
| ASTLM     | 250           | 250   |
| BIOLM     | 150           | 150   |
| BYTLM     | 64000         | 64000 |
| DIOLM     | 150           | 150   |
| ENQLM     | 2000          | 2000  |
| FILLM     | 100           | 100   |
| PGFLQUOTA | 50000         | 50000 |
| TQELM     | —             | —     |
| WSDEFAULT | 2000          | 2000  |
| WSEXTENT  | 16384         | 16384 |
| WSQUOTA   | 4000          | 4000  |

WSEXTENT is usually higher than WSQUOTA to make the most of the OpenVMS dynamic working set size adjustment algorithms. To set reasonable figures, monitor the live system to determine the page fault rate of the TSC process.

## Parameter and Quota Calculations

### A.2 Calculating Quotas for OpenVMS User Names of ACMS Processes

#### A.2.2.1 How ACMSPARAM.COM Calculates Values for the TSC

This section shows the formulas for how ACMSPARAM.COM calculates parameter values for the TSC. If the calculated values are below the minimum values shown in Table A-2, then ACMSPARAM.COM assigns the minimum values.

Refer to Table 10-3 for descriptions of the variables shown in these calculations.

##### ASTLM

$$\text{ASTLM} = 24 + (\text{terminal\_cnt} * 2) \quad ! \text{ base}$$

##### BIOLM

$$\text{BIOLM} = 20 + \text{TERMINAL\_CNT} \quad ! \text{ base}$$

##### BYTLM

$$\text{BYTLM} = 4096 + (1000 * \text{TERMINAL\_CNT}) \quad ! \text{ base}$$

##### FILLM

$$\text{FILLM} = 20 + \text{TERMINAL\_CNT} \quad ! \text{ base}$$

! 1 channel for each terminal

##### PGFLQUOTA

$$\text{PGFLQUOTA} = 2048 + (100 * \text{TERMINAL\_CNT}) + \text{MSS\_PROCESS\_POOL}$$

! base  
! for each TT overhead  
! MSS pool

##### TQELM

$$\text{TQELM} = \text{CP\_PROC\_CNT} + \text{ENTERED\_TERMINAL\_CNT}$$

#### A.2.3 User Name Setup for the CP

The OpenVMS user name under which the CP runs must have the SETPRV privilege.

The OpenVMS user name under which the CP runs requires the minimum quotas shown in Table A-3. The CP user name is controlled by the ACMSGEN parameter CP\_USERNAME. The number of terminals per CP is controlled by the ACMSGEN parameter TERMINALS\_PER\_CP.

**Table A-3 Minimum Quotas for the CP User Name Process**

| Parameter | Minimum Value |       |
|-----------|---------------|-------|
|           | Alpha         | I64   |
| ASTLM     | 250           | 250   |
| BIOLM     | 150           | 150   |
| BYTLM     | 64000         | 64000 |
| DIOLM     | 150           | 150   |
| ENQLM     | 2000          | 2000  |
| FILLM     | 100           | 100   |

(continued on next page)

## Parameter and Quota Calculations

### A.2 Calculating Quotas for OpenVMS User Names of ACMS Processes

**Table A-3 (Cont.) Minimum Quotas for the CP User Name Process**

| Parameter | Minimum Value |       |
|-----------|---------------|-------|
|           | Alpha         | I64   |
| PGFLQUOTA | 50000         | 50000 |
| TQELM     | —             | —     |
| WSDEFAULT | —             | —     |
| WSEXTENT  | —             | —     |
| WSQUOTA   | —             | —     |

WSEXTENT is usually higher than WSQUOTA to make the most of the OpenVMS dynamic working set size adjustment algorithms. To set reasonable figures, monitor the live system to determine the page fault rate of the CP process.

Remember, you must authorize the user name of the CP as an agent in the User Definition Utility (UDU) authorization file ACMSUDF.DAT. (See Chapter 3 and Chapter 18 for information about agent authorizations using UDU.)

#### A.2.3.1 How ACMSPARAM.COM Calculates Values for the CP

This section shows the formulas for how ACMSPARAM.COM calculates parameter values for the CP. If the calculated values are below the minimum values shown in Table A-3, then ACMSPARAM.COM assigns the minimum values.

Refer to Table 10-3 for descriptions of the variables shown in these calculations.

##### Working Set on Alpha

```
WSDEFAULT = 2000 + (10*TERMINALS_PER_CP) ! Working set
WSEXTENT = 16384 + (50*TERMINALS_PER_CP) ! sizes for
WSQUOTA = 4000 + (50*TERMINALS_PER_CP) ! CP user name
```

##### Working Set on I64

```
WSDEFAULT = 2000 + (10*TERMINALS_PER_CP) ! Working set
WSEXTENT = 16384 + (50*TERMINALS_PER_CP) ! sizes for
WSQUOTA = 4000 + (50*TERMINALS_PER_CP) ! CP user name
```

##### ASTLM

```
ASTLM = 17 + ! base
 (9 * TERMINALS_PER_CP) + ! DECnet sends
 (2 * REMOTE_APPL_CNT) ! for DECnet receives
```

##### BIOLM

```
BIOLM = 28 + ! base
 (TERMINALS_PER_CP * 2) + ! TDMS i/o or MSS DECnet link i/o
 (2 * REMOTE_APPL_CNT) ! for MSS DECnet link receives
```

##### BYTLM

```
BYTLM = 18000 + ! base
 (2000 * TERMINALS_PER_CP) + ! TDMS i/o
 ((2 * REMOTE_APPL_CNT) + ! MSS sends
 TERMINALS_PER_CP) * MSS_MAXBUF
```

##### DIOLM

```
DIOLM = 20 + (2 * TERMINALS_PER_CP)
```

## A.2 Calculating Quotas for OpenVMS User Names of ACMS Processes

### ENQLM

ENQLM = 52 + (4 \* TERMINALS\_PER\_CP)

### FILLM

FILLM = 32 + ! base + 3 shareable DECforms images  
 (3 \* TERMINALS\_PER\_CP) + ! cp opens 3 channels to each  
 (2 \* REMOTE\_APPL\_CNT) + ! terminal. DECnet link channels  
 REMOTE\_RLB\_CNT + ! for remote rlbs  
 FORM\_CNT + ESC\_RTN\_IMAGE\_CNT ! for DECforms form files

### PGFLQUOTA

PGFLQUOTA =  
 16384 + ! Base  
 MSS\_PROCESS\_POOL + ! MSS process pool  
 ( 2 \* MDB\_BLK ) + ! Menu information  
 FORM\_BLKs + ! Form files  
 REMOTE\_RLB\_BLKs + ! Remote TDMS .RLBs  
 ( TERMINALS\_PER\_CP \* 500 ) + ! Per-user overhead  
 TERMINALS\_PER\_CP \* ! For each user:  
 ( ( ( LARGEST\_MESSAGE + 512 ) \* 2 ) + ! Msg marshaling  
 ( LARGEST\_MESSAGE \* FORM\_CNT ) + ! DECform's data  
 LARGEST\_MESSAGE ) / 512 ! TDMS data

---

#### Note

The current formula for calculating the PGFLQUOTA value of the CP account is liberal. The formula assumes that each exchange step involves the sending or receiving of the largest message (see the description of the LARGEST\_MESSAGE variable in Table 10-3).

After executing ACMSPARAM.COM, review the value of CP\_PGFLQUOTA. If this value appears to be excessively large, then replace the LARGEST\_MESSAGE variable with the average size of workspaces used in exchange steps, or with the size of the workspace most often used in exchange steps.

The formula for calculating the CP\_PGFLQUOTA provides only a rough approximation of this quota. To fine-tune your system, calculate the quota for your particular system.

---

### TQELM

TQELM = 8 + TERMINALS\_PER\_CP

#### A.2.4 User Name Setup for the QTI

The OpenVMS user name under which the QTI runs must have OpenVMS SYSPRV and SYSLCK privileges. Define this user name with the ACMSEGEN parameter QTI\_USERNAME. The user name must be authorized in the UDU authorization file as an agent.

The OpenVMS user name under which the QTI runs requires the minimum quotas shown in Table A-4.

## Parameter and Quota Calculations

### A.2 Calculating Quotas for OpenVMS User Names of ACMS Processes

**Table A-4 Minimum Quotas for the QTI User Name Process**

| Parameter | Minimum Value |       |
|-----------|---------------|-------|
|           | Alpha         | I64   |
| ASTLM     | 250           | 250   |
| BIOLM     | 150           | 150   |
| BYTLM     | 64000         | 64000 |
| DIOLM     | 150           | 150   |
| ENQLM     | 2000          | 2000  |
| FILLM     | 100           | 100   |
| PGFLQUOTA | 50000         | 50000 |
| TQELM     | —             | —     |
| WSDEFAULT | —             | —     |
| WSEXTENT  | —             | —     |
| WSQUOTA   | —             | —     |

WSEXTENT is usually higher than WSQUOTA to make the most of the OpenVMS dynamic working set size adjustment algorithms. To set reasonable figures, monitor the live system to determine the page fault rate of the QTI process.

#### A.2.4.1 How ACMSPARAM.COM Calculates Values for the QTI

This section shows the formulas for how ACMSPARAM.COM calculates parameter values for the QTI. If the calculated values are below the minimum values shown in Table A-4, then ACMSPARAM.COM assigns the minimum values.

Use these formulas for information or fine-tuning purposes only. HP recommends that you use the ACMSPARAM.COM procedure, which is discussed in detail in Chapter 10, to perform these calculations to determine the QTI quota values.

Refer to Table 10-3 for descriptions of the variables shown in these calculations.

##### Working Set on Alpha

```
WSDEFAULT = 2000 + (20*QTI_TASK_THDS) ! Working set
WSEXTENT = 16384 + (50*QTI_TASK_THDS) ! sizes for
WSQUOTA = 4000 + (50*QTI_TASK_THDS) ! QTI user name
```

##### Working Set on I64

```
WSDEFAULT = 2000 + (20*QTI_TASK_THDS) ! Working set
WSEXTENT = 16384 + (50*QTI_TASK_THDS) ! sizes for
WSQUOTA = 4000 + (50*QTI_TASK_THDS) ! QTI user name
```

##### ASTLM

```
ASTLM = 24 + ! base
 (QTI_TASK_THDS * 2) + ! one AST for each thread
 (2 * QTI_SUBMITTERS) + ! session receives and messages
 (3 * QTI_QUEUEES) ! RMS overhead
```

##### BIOLM

```
BIOLM = 18 + ! base
 QTI_TASK_THDS ! MSS DECnet i/o
```

## A.2 Calculating Quotas for OpenVMS User Names of ACMS Processes

### BYTLM

```

BYTLM = 8192 + ! base
 (2 * REMOTE_APPL_CNT * ! 2 MSS buffers for each link
 MSS_MAXBUF) +
 (2048 * QTI_QUEUES) + ! RMS overhead
 (1024 * QTI_TASK_THDS)

```

### DIOLM

```

DIOLM = 18 + ! base
 QTI_TASK_THDS ! disk i/o

```

### ENQLM

```

ENQLM = 69 + ! base
 (15 * QTI_TASK_THDS) + ! RMS
 (QTI_QUEUES * 4) ! ASTs and locking

```

### FILLM

```

FILLM = 20 + ! base
 REMOTE_APPL_CNT + ! DECnet links
 QTI_QUEUES ! 1 for each queue file

```

### PGFLQUOTA

```

PGFLQUOTA =
 8192 + ! base
 MSS_PROCESS_POOL + ! MSS pool
 (5831 + ! buffer for each operator request
 (QTI_TASK_THDS *
 (16272 + QTI_MAX_WSP_SIZE))) + ! buffer for each task thread
 (QTI_QUEUES * 792) + ! buffer for each task queue
 (QTI_SUBMITTERS *
 (MSS_MAXBUF + 2064)) + ! buffer for each submitter
 512) / 512
Include 10% for expansion
PGFLQUOTA = PGFLQUOTA + (PGFLQUOTA/10)

```

### TQELM

```

TQELM = 20 + ! base
 (QTI_TASK_THDS * 2) ! one timer for each thread

```

### A.2.5 User Name Setup for the EXC

The OpenVMS user name under which the EXC runs must have OpenVMS SETPRV and SYSPRV privileges. Define this user name with the ADU application definition clause APPLICATION USERNAME.

The OpenVMS user name under which the EXC runs requires the minimum quotas shown in Table A-5.

**Table A-5 Minimum Quotas for the EXC User Name Process**

| Parameter | Minimum Value |     |
|-----------|---------------|-----|
|           | Alpha         | I64 |
| ASTLM     | 250           | 250 |
| BIOLM     | 150           | 150 |

(continued on next page)

## Parameter and Quota Calculations

### A.2 Calculating Quotas for OpenVMS User Names of ACMS Processes

**Table A-5 (Cont.) Minimum Quotas for the EXC User Name Process**

| Parameter | Minimum Value |       |
|-----------|---------------|-------|
|           | Alpha         | I64   |
| BYTLM     | 64000         | 64000 |
| DIOLM     | 150           | 150   |
| ENQLM     | 2000          | 2000  |
| FILLM     | 100           | 100   |
| PGFLQUOTA | 50000         | 50000 |
| TQELM     | —             | —     |
| WSDEFAULT | —             | —     |
| WSEXTENT  | —             | —     |
| WSQUOTA   | —             | —     |

WSEXTENT is usually higher than WSQUOTA to make the most of the OpenVMS dynamic working set size adjustment algorithms. To set reasonable figures, monitor the live system to determine the page fault rate of the EXC process.

The EXC user name requires access to application databases (.ADB files), task group databases (.TDB files), message files, and request libraries.

#### A.2.5.1 How ACMEXCPAR.COM Calculates Values for the EXC

This section shows the formulas for how ACMEXCPAR.COM calculates parameter values for the CP. If the calculated values are below the minimum values shown in Table A-5, then ACMEXCPAR.COM assigns the minimum values.

Use these formulas for information or fine-tuning purposes only. HP recommends that you use the ACMEXCPAR.COM procedure, which is described in Chapter 10, to perform these calculations to determine the EXC quota values.

Refer to Table 10-3 for descriptions of the variables shown in these calculations.

##### Working Set on Alpha

```
WSDEFAULT 2000 + (20 * EXC_TK_INSTANCE_CNT) ! Working set quotas
WSEXTENT 16384 + (50 * EXC_TK_INSTANCE_CNT) ! for the
WSQUOTA 4000 + (20 * EXC_TK_INSTANCE_CNT) ! EXC user name
```

##### Working Set on I64

```
WSDEFAULT 2000 + (20 * EXC_TK_INSTANCE_CNT) ! Working set quotas
WSEXTENT 16384 + (50 * EXC_TK_INSTANCE_CNT) ! for the
WSQUOTA 4000 + (20 * EXC_TK_INSTANCE_CNT) ! EXC user name
```

##### ASTLM

```
ASTLM = 24 + ! base
 (5 * EXC_TK_INSTANCE_CNT) + ! terminal i/o + DECnet sends
 EXC_SP_CNT + ! max SP's for this appl
 EXC_SERVER_CNT + ! num of servers defined for appl
 (2 * AGENT_CNT) ! MSS receives from agents
```

##### BIOLM

```
BIOLM = 10 + ! base
 EXC_TK_INSTANCE_CNT + ! TDMS i/o and MSS network sends
 (2 * REMOTE_AGENT_CNT) ! DECnet receives
```



## A.2 Calculating Quotas for OpenVMS User Names of ACMS Processes

### BYTLM

```

BYTLM = 8192 + ! base
 (1000 * LOCAL_TDMS_TASK_CNT) + ! TDMS i/o
 ((2 * REMOTE_AGENT_CNT) + ! MSS DECnet link receives
 REMOTE_TK_INSTANCE_CNT)
 * MSS_MAXBUF) + ! MSS DECnet link sends
 (MAXPROCESSCNT * 84) ! SP termination notification

```

### DIOLM

```

DIOLM = 20 + ! base
 EXC_TK_INSTANCE_CNT ! rlb i/o

```

### ENQLM

```

ENQLM = 20 + ! base
 ((EXC_RLB_CNT + EXC_MSG_CNT +
 FORM_CNT +
 EXC_TDB_CNT) * 4) ! rlb, tdb and msg file opens & I/O

```

### FILLM

```

FILLM = 20 + ! base
 EXC_RLB_CNT + ! rlbs
 FORM_CNT + ! HP DECforms forms
 EXC_MSG_CNT + ! message files
 EXC_TDB_CNT + ! tdb's
 (2 * REMOTE_AGENT_CNT) ! DECnet channels

```

### PGFLQUOTA

```

PGFLQUOTA = 7500 + ! base
 (20 * EXC_TK_INSTANCE_CNT) + ! EXC's task context
 ((TWS_POOLSIZ + TWSC_POOLSIZ)
 * EXC_TDB_CNT) + ! WKSP pools
 (WS_POOLSIZ + WSC_POOLSIZ) + ! group/user wksp pools
 MSS_PROCESS_POOL + ! MSS process pool
 EXC_RLB_BLK + ! rlb caching
 (LOCAL_TDMS_TASK_CNT * 100) + ! Local TDMS tasks
 EXC_ADB_BLK + ! Size of ADB
 EXC_TDB_BLK + ! Size of TDBs

```

### TQELM

```

TQELM = 1 + ! base
 (2 * EXC_SERVER_CNT) + ! server management
 EXC_TK_INSTANCE_CNT + ! ast for each task instance for i/o
 EXC_SP_CNT ! server process communications

```

### A.2.6 Calculating Quotas for ACMS Server Processes

This section shows how to derive the minimum quotas required for the server processes. By increasing the base default value assigned to the AUTHORIZE quota by the amounts shown in Figure A-1, you can determine the minimum server process quota.

In Figure A-1, the number represented by BASE is the default value assigned to the AUTHORIZE quota. This number represents the base quota requirement for the processing being done in the server (not for the server process itself). The BASE amount varies for each ACMS system. Generally, the default BASE quota assigned for the process is sufficient. The number after BASE + indicates the minimum amount that should be added to bring the quota value up to the minimum required by the ACMS server process.

## Parameter and Quota Calculations

### A.2 Calculating Quotas for OpenVMS User Names of ACMS Processes

The only privilege ACMS requires server processes to have is TMPMBX. The quotas required by an ACMS server process are dependent on the type of processing the server performs.

**Figure A–1 Minimum Quotas for Server Processes**

|           |                               |                         |
|-----------|-------------------------------|-------------------------|
| ASTLM     | BASE + 2                      | ! for procedure servers |
|           | BASE + 4                      | ! for DCL servers       |
| BIOLM     | BASE + 2                      | !for procedure servers  |
|           | BASE + 4                      | !for DCL servers        |
| BYTLM     | BASE + 2000                   |                         |
| DIOLM     | BASE + 2                      |                         |
| FILLM     | BASE + 10                     |                         |
| PGFLQUOTA | BASE + MSS_PROCESS_POOL + 200 |                         |

Check the DBMS and Rdb installation guides if your server code accesses these products. Additional resources required for using these products, such as ENQLM, are explained in the appropriate installation guides.

### A.3 Calculating Quotas for Using the ADU Utility

Users who plan to use the ADU must set quotas equal to or greater than the minimum values shown in Figure A–2. Be sure to refer to documentation for related products, such as the CDD dictionary, for further quota limits that may be required.

**Figure A–2 Minimum Quotas for Using ADU**

|       |                                                                                                                                                                                                            |                                                                                     |
|-------|------------------------------------------------------------------------------------------------------------------------------------------------------------------------------------------------------------|-------------------------------------------------------------------------------------|
| ENQLM | 100                                                                                                                                                                                                        |                                                                                     |
| FILLM | 25 + (the number of files specified with the /OBJECT<br>qualifier to the BUILD GROUP command)<br>+ (the number of files specified with the<br>/USERLIBRARY qualifier to the BUILD GROUP<br>command)<br>+ 2 | ! if STARTLET.OLB and IMAGELIB are<br>! searched when resolving<br>! global symbols |
| PRCLM | 1                                                                                                                                                                                                          |                                                                                     |

Determining the values for the working set (WSDEFAULT, WSEXTENT, WSQUOTA) and the PGFLQUOTA involves experimentation and modification over time. Some factors to consider when setting these values include:

- Amount of available memory
- CPU processing power
- Complexity of ACMS task groups

ADU typically requires higher quotas than those set by default for the working set and the PGFLQUOTA.

## Parameter and Quota Calculations

### A.4 Calculating Quotas for Using the ACMS Task Debugger

#### A.4 Calculating Quotas for Using the ACMS Task Debugger

Users who plan to run tasks under the task debugger must set quotas equal to or greater than those listed in Figure A-3. The only privilege ACMS requires server processes to have is TMPMBX.

**Figure A-3 Minimum Quotas for Using the Task Debugger**

|       |                                                                           |
|-------|---------------------------------------------------------------------------|
| ASTLM | 10                                                                        |
| BYTLM | 50000                                                                     |
| ENQLM | 100                                                                       |
| FILLM | 96                                                                        |
| PRCLM | 1 + maximum number of servers that can<br>be started by the task debugger |
| TQELM | 10                                                                        |

Users might need a BYTLM value greater than 50,000 if they start the task debugger with the /WORKSPACE\_DEBUG qualifier and start more than one server during a task debugging session. Also, the subprocess quota should be greater than 1 to allow the task debugger to start subprocesses.

See *HP ACMS for OpenVMS Writing Server Procedures* for complete information on the ACMSDEBUG Utility and the associated ACMS/DEBUG commands.

#### A.5 Calculating Values for Certain ACMSGEN Parameters

ACMS provides values for ACMSGEN parameters as defaults or through ACMSPARAM.COM. These values normally suffice; however, for several ACMSGEN parameters you may want to calculate values independently to more accurately reflect your ACMS system. In such cases, include the new value as a variable in ACMVARINI.DAT that corresponds to the ACMSGEN parameter. Then run ACMSPARAM.COM. The command procedure uses the new variable value to generate a new ACMSGEN parameter.

The following sections describe the calculations for the ACMSGEN parameters whose values you may want to change from the values supplied by default or by ACMSPARAM.COM.

##### A.5.1 Calculating the Value of MAX\_LOGINS

MAX\_LOGINS limits the number of users who can sign in to ACMS.

To increase the effective value for the ACMSGEN parameter MAX\_LOGINS, you may also have to change the value of the parameters MAX\_TTS\_CP or CP\_SLOTS. A user can sign in only if ACMS can assign the user's terminal to a Command Process (CP). The total number of terminals all your Command Processes can handle is the product of:

- The number of terminals one Command Process can service, the MAX\_TTS\_CP value
- The maximum number of Command Processes that can run when ACMS is active, the CP\_SLOTS value

## Parameter and Quota Calculations

### A.5 Calculating Values for Certain ACMSGEN Parameters

The number of users who can sign in can never be greater than the product of the MAX\_TTS\_CP value and the CP\_SLOTS value. Once the value you set for the MAX\_LOGINS parameter reaches the product of the MAX\_TTS\_CP and CP\_SLOTS parameters, merely increasing the value of the MAX\_LOGINS parameter has no effect. To increase the number of users who can sign in, you must also increase the value of the MAX\_TTS\_CP or the CP\_SLOTS parameter.

The ACMSGEN parameter MAX\_LOGINS is only checked for task submitters signing in through the TSC. Any other sign-ins (from user-written agents, detached tasks, and the QTI) are not counted against the MAX\_LOGINS value.

If you have a large number of users who sign in through user-written agents, detached tasks, and the QTI, you may want to fine-tune the working set size of the ACC. ACMSPARAM.COM uses the following minimum values for ACC's working set quotas:

| Parameter | Minimum Value |       |
|-----------|---------------|-------|
|           | Alpha         | I64   |
| WSDEFAULT | 2000          | 2000  |
| WSEXTENT  | 16384         | 16384 |
| WSQUOTA   | 4000          | 4000  |

The WSDEFAULT and WSEXTENT quotas may be low for the ACC user name if there are many sign-ins/sign-outs. WSEXTENT is usually higher than WSQUOTA to make the most of the OpenVMS dynamic working set size adjustment algorithms. To set reasonable figures, monitor the live system to determine the page fault rate of the ACC process and set the working set quotas appropriately.

#### A.5.2 Calculating the Value of MSS\_MAXOBJ

The ACMSGEN message switch parameter MSS\_MAXOBJ is the number of message switch objects that can be created on a system at one time. The ACMSPARAM.COM calculation of MSS\_MAXOBJ follows:

```
MSS_MAXOBJ = 15 + (CP_PROC_CNT * (4 + TERMINALS_PER_CP))
 + (2 * OPR_ENTER_RETURN_CNT)
 + (6 * APPL_CNT)
 + (3 * TOTAL_SP_CNT)
 + QTI_SUBMITTERS
 + ((AGENT_CNT * 3) + AGENT_SUB_CNT)
 + (2 * OPERATOR_CNT)
 + (5 * DEBUGGER_CNT)
```

```
MSS_MAXOBJ = MSS_MAXOBJ + (.10 * MSS_MAXOBJ)
```

#### A.5.3 Calculating the Value of MSS\_MAXBUF

The ACMSGEN message switch parameter MSS\_MAXBUF is the size of a buffer that the ACMS message switch uses to handle message traffic. If this buffer is not large enough to hold a message, the message is sent in blocks.

ACMSPARAM.COM calculates MSS\_MAXBUF based on the largest message passed in an exchange step in your application so that you never incur the cost of message blocking. The ACMSPARAM.COM calculation of MSS\_MAXBUF follows:

## Parameter and Quota Calculations

### A.5 Calculating Values for Certain ACMSGEN Parameters

```
MSS_MAXBUF = 280
 + LARGEST_MESSAGE
 + (17 * LARGEST_MESSAGE_NUM_WKSP)

MSS_MAXBUF = MSS_MAXBUF + MSS_MAXBUF/10
```

This formula is based on a HP DECforms request and is also the one used in the ACMSPARAM.COM file. If you wish to determine more accurately the value of the MSS\_MAXBUF parameter, use the following formula:

```
MAX_MAXBUF = 216
 + RECORD_REQUEST_NAMES
 + (NUM_WSPS * 17)
 + SUM_WSPS_LEN

MSS_MAXBUF = MSS_MAXBUF + MSS_MAXBUF/10
```

In this formula 216 is the message overhead for HP DECforms request ( use 144 as the message overhead for TDMS request). RECORD\_REQUEST\_NAMES is the length in bytes of the record ID or request name round to next higher longword. NUM\_WSPS is the number of workspaces. Round the product to next higher longword. SUM\_WSPS\_LEN is the sum of lengths of workspaces, each rounded to next higher longword.

For example, you have an exchange step like this:

```
EXCHANGE
 SEND EMPLOYEE_RECORD
 SENDING EMPLOYEE_MAIN_DATA, EMPLOYEE_SUB_DATA;
```

In this example, EMPLOYEE\_MAIN\_DATA is 400 bytes long and EMPLOYEE\_SUB\_DATA is 35 bytes long. The values to use are:

```
216 !Message overhead for HP DECforms request = 216
+ 16 ! Length of "employee_record" = 15 = 16 rounded
+ 36 ! 2 workspaces * 17 = 34 = 36 rounded
+400 ! Length of employee_main_data workspace = 400
+ 36 ! Length of employee_sub_data workspace = 35 = 36 rounded

704 ! message length, in bytes
+ 70 ! 10% expansion

774 ! total message length, in bytes
```

The minimum size of MSS\_MAXBUF is 512.

There may be circumstances for which you are willing to incur message blocking. In such cases, you may not want to have ACMSPARAM.COM calculate the MSS\_MAXBUF parameter. Instead, calculate MSS\_MAXBUF as described in the following example, add the values as a variable in ACMVARINI.DAT, and then run ACMSPARAM.COM.

For example, the exchange step with the maximum total message size may be much larger than any other exchange step and may be in a task that is selected infrequently. In this case you still want to choose a MSS\_MAXBUF size that is not wasteful. Choose a value that satisfies the following constraints:

- The value should be large enough to accommodate any frequently accessed exchange step.
- Allow for enough space so that the message can be divided into approximately equal blocks, so that space is not wasted.

## Parameter and Quota Calculations

### A.5 Calculating Values for Certain ACMSGEN Parameters

When a message requires multiple blocks to send, an additional 28 bytes of message overhead is incurred to send blocks other than the first block. If the data cannot be sent in one message, ACMS uses the following formula to calculate how many data segments are needed:

$$\text{TOTAL\_DATA\_SEGMENTS} = 1 + \frac{(\text{Message\_length} - \text{MSS\_MAXBUF})}{(\text{MSS\_MAXBUF} - 28)}$$

This formula may not result in message blocks of approximately equal size. To divide a message into approximately equal blocks, you must decide on how many data segments you want to use, and then calculate MSS\_MAXBUF so that ACMS correctly calculates the desired value of TOTAL\_DATA\_SEGMENTS. To do this, apply the message length and segment numbers to the following formula to determine the value of MSS\_MAXBUF:

$$\text{MSS\_MAXBUF} = \frac{(\text{Message\_length} - 28)}{\text{TOTAL\_DATA\_SEGMENTS}} + 28$$

For example, if the total number of bytes for the entire message is 20000 and you want to use 4 data segments to send it, the calculation is:

$$\text{MSS\_MAXBUF} = \frac{20000 - 28}{4} + 28$$

$$\text{MSS\_MAXBUF} = 5021$$

#### A.5.4 Calculating the Value of MSS\_POOLSIZE

MSS\_POOLSIZE is the maximum amount of memory that can be used to send messages. ACMSPARAM.COM calculates this parameter as follows:

$$\begin{aligned} \text{MSS\_POOLSIZE} = & ( ( 56 * \text{MSS\_MAXOBJ} ) \\ & + ( 144 * \text{MAXPROCESSCNT} ) \\ & + (\text{MSS\_MAXBUF} * \text{TOTAL\_TK\_INSTANCE\_CNT} ) \\ & + (\text{TERMINAL\_CNT} * 128) \\ & + (\text{TOTAL\_SP\_CNT} * 64) \\ & + (\text{OPERATOR\_CNT} * 5120) \\ & + 567) \\ & / 512) + 32 \end{aligned}$$

$$\text{MSS\_POOLSIZE} = \text{MSS\_POOLSIZE} + (\text{MSS\_POOLSIZE}/10)$$

#### A.5.5 Calculating the Value of MSS\_PROCESS\_POOL

MSS\_PROCESS\_POOL defines the size of the ACMS internal message switch process local pool. ACMSPARAM.COM calculates this parameter as follows:

For an application node:

$$\text{MSS\_PROCESS\_POOL} = ((\text{MSS\_MAXBUF} * 2 * \text{REMOTE\_SUB\_CNT}) / 512) + 32$$

For a submitter node:

$$\text{MSS\_PROCESS\_POOL} = (((\text{MSS\_MAXBUF} * 2 * \text{REMOTE\_APPL\_CNT}) / 512) * 4) + 32$$

The value of MSS\_PROCESS\_POOL must be at least 256.

If the node is both an application node and a submitter node, the command procedure uses the higher of the two values calculated in the previous example.

## Parameter and Quota Calculations

### A.5 Calculating Values for Certain ACMSGEN Parameters

#### A.5.6 Calculating the Value of PERM\_CPS

PERM\_CPS sets the number of permanently active Command Processes. The default value is 1.

To increase the effective value of PERM\_CPS, you may also need to change the value of the parameter MAX\_LOGINS or MAX\_TTS\_CP.

The effective number of permanently active Command Processes is the lesser of:

- The value for the PERM\_CPS parameter
- The result of the MAX\_LOGINS value divided by the MAX\_TTS\_CP value

At startup, when ACMS computes the maximum number of Command Processes the system might need, ACMS divides the value of MAX\_LOGINS by the value of MAX\_TTS\_CP. For example, if you defined MAX\_LOGINS as 60 and MAX\_TTS\_CP as 20, ACMS would never set up more than three Command Processes. In this case, if the PERM\_CPS value is greater than 3, ACMS ignores the PERM\_CPS value. ACMS does not start more command processes than all of your terminal users can use.

Once the value you set for the PERM\_CPS parameter reaches the result of MAX\_LOGINS divided by MAX\_TTS\_CP, merely increasing the value of the PERM\_CPS parameter has no effect. To increase the effective value of PERM\_CPS further, you must also increase the value of the MAX\_LOGINS parameter or decrease the value of the MAX\_TTS\_CP parameter. This situation is unusual, however. There is no reason to increase the number of permanent Command Processes to more than you need to service all terminal users. In most cases, set the number of permanent Command Processes to a value adequate for handling your common number of users.

#### A.5.7 Calculating ACMS Workspace Pools

When you start an application, ACMS allocates a number of shared and private memory pools to hold the data and control structures associated with the workspaces used by the tasks in your application. Calculate the amount of space your application requires in these pools so that ACMS can allocate sufficient memory to hold the data and control information.

##### A.5.7.1 Types of Workspace Pools

The four types of ACMS workspace pools are listed in Table A–6 with their default values.

**Table A–6 Types of ACMS Workspace Pools**

| Type                                 | Default Value |               |
|--------------------------------------|---------------|---------------|
|                                      | Alpha         | I64           |
| Task instance workspace control pool | 50 pagelets   | 50 pagelets   |
| Task instance workspace pool         | 1600 pagelets | 1600 pagelets |
| Workspace pool                       | 256 pagelets  | 256 pagelets  |
| Control pool                         | 128 pagelets  | 128 pagelets  |

ACMS allocates a task instance workspace pool and a task instance workspace control pool for each task group in your application. These pools are used to hold data and control information for active task instances in their respective groups and are shared by the EXC process and the server processes.



## Parameter and Quota Calculations

### A.5 Calculating Values for Certain ACMSGEN Parameters

ACMS also allocates a workspace pool and a workspace control pool to hold workspace data and control information associated with the master copies of group and user workspaces. These two pools are used by all the task groups in the application and are allocated in the private memory of the EXC process.

#### A.5.7.2 Workspace Pool Allocation Failures

There are four conditions under which ACMS fails to allocate blocks of memory from workspace pools:

- There is insufficient free space within the pool to satisfy the request.
- There is insufficient free contiguous space within the pool to satisfy the request. In this case, there may be sufficient total free space; however, there is no single free block that is large enough to accommodate the request.
- A request is made to allocate a single block whose size exceeds 65,536 bytes. Since ACMS only allocates blocks of memory in powers of 2 up to and including 65,536 bytes long, redesign your task to use fewer or smaller workspaces.
- A request is made to allocate a block that would cause the total amount of pool allocated to exceed the total size of the pool.

The EXC cancels a task during the task-initialization phase if it is unable to allocate sufficient space within one of the workspace pools. The error reported is "Error starting task: Unable to allocate workspace resources, please try later" on the user's terminal. Information about the task cancellation is written to the Audit Trail Log. The entry includes the following information:

```
"Error allocating {number} bytes in TWSC pool {workspace-pool-name} for workspaces"
```

See Chapter 12 for information about the audit trail record generated by this error.

Use the ACMS/SHOW APPLICATION/POOL command to determine the amount of free space within the workspace pools that are being used by your applications. This display also shows the size of the largest block that may be allocated from the pool. If you find that there is sufficient free space to satisfy a request, but that the free space is not contiguous, then this is an indication that the free space inside the workspace pools has become fragmented. Increasing the amount of memory allocated to the pool solves this problem and allows ACMS to better manage the free space within the pool.

#### A.5.7.3 ACMS Workspace Pool Requirements

The following sections describe how to calculate the amount of space required in each of the four types of workspace pools.

ACMS reserves the first pagelet (Alpha) in each pool for pool control structures. Before allocating a block of memory from a pool, ACMS rounds the size of the requested block up to the next highest power of two. ACMS uses this allocation algorithm to reduce the possibility of pool fragmentation and to provide a fast pool-space allocation time. When calculating the amount of space required by a task, take this information into account.

For example, you calculate that a task requires a block of 956 bytes from the task instance pool for six task workspaces and three system workspaces. You then calculate that these nine workspaces require a block of 196 bytes ( $52 + (16 * 9)$ ) from the task instance control pool. Both these figures must then be rounded up to the next highest power of two. In this example, the task



## Parameter and Quota Calculations

### A.5 Calculating Values for Certain ACMSEGEN Parameters

requires 1024 bytes from the task instance workspace pool and 256 bytes from the task instance workspace control pool.

**A.5.7.3.1 Task Instance Workspace Pool Requirements** Each task instance requires a block of this pool equal to the sum of the sizes of the system workspaces (519 bytes) and the sum of the sizes of the task, user, and group workspaces used by the task.

**A.5.7.3.2 Task Instance Control Pool Requirements** Each task requires a block of this pool large enough to hold:

- 52 bytes of task workspace header information. This structure contains information needed by ACMS to identify the owner of the workspaces and to map the task instance workspace block in the task instance workspace pool.
- 16 bytes of control information for each task, user, group, and system workspace. ACMS uses these structures to locate each individual workspace owned by a task instance and to point to the master copies of any group and user workspaces referenced by a task instance.

ACMS allocates blocks from these two pools at the beginning of a task instance and frees the blocks at the end of the task instance.

Group and user workspaces require additional overhead information. Memory for this information is allocated from the workspace pool and the control pool. The amount of additional pool required depends on the type of workspace involved.

**A.5.7.3.3 Group Workspace Pool Requirements** Because group workspaces can be shared among instances of different tasks within a task group, they require more control information to be kept.

The first time a group workspace is accessed within a task group, a 24-byte workspace descriptor is allocated from the control pool. Space must also be allocated from the workspace pool to contain the master copy of the workspace.

When a task that uses a particular group workspace is initiated, the master copy is moved into a local copy for the exclusive use of the task instance. When the task instance ends, the master copy of each group workspace that allows updating is updated from these local copies.

Therefore, the overhead for group workspaces is 32 bytes (24 bytes rounded up to the next power of two) from the control pool, plus an amount of workspace pool equal to the size of the group workspace. This value is rounded up to the next power of two.

Once allocated, the overhead pool for group workspaces is released only when the application is stopped. ACMS reserves an 8-byte block to hold a header for the queue of all the group workspaces in an application.

**A.5.7.3.4 User Workspace Pool Requirements** User workspaces are maintained on a per-submitter basis, so master copies of user workspaces must be maintained for each submitter.

The first time a submitter accesses a user workspace, a 48-byte workspace submitter block must be allocated from the control pool. This block contains the header for the queue of master copies of user workspaces for this submitter. It also contains some submitter identification.

## Parameter and Quota Calculations

### A.5 Calculating Values for Certain ACMSEGEN Parameters

The first time a user workspace is used by a submitter, a 24-byte workspace descriptor is allocated from the control pool. Enough workspace pool must be allocated to contain the master copy of this user workspace. The workspace descriptor points to the master copy and is queued to the submitter block.

When the user workspace is referenced, the master copy is used to initialize a local copy that is provided to the task instance. When the task ends, the master copy of each user workspace is updated, if necessary, from the local copy.

The overhead for user workspaces is:

- One 64-byte block (48 bytes rounded) of control pool for each submitter
- One 32-byte block (24 bytes rounded up to the next power of two) of control pool for each user workspace used for each submitter
- Enough workspace pool to contain the master copy of each user workspace used, rounded up to the next power of two

This "overhead" pool is released when the submitter signs out.

ACMS reserves an 8-byte block to hold a header for the queue of all the group workspaces in an application.

#### A.5.7.4 Calculating Workspace Pool Sizes

This section describes how to calculate values for the following workspace pool parameters:

- TWS\_POOLSIZ
- TWSC\_POOLSIZ
- WS\_POOLSIZ
- WSC\_POOLSIZ

This section also provides information about defining logical names to size the workspace pools to set values for these parameters on a per-application basis.

##### A.5.7.4.1 Calculating the Value of TWS\_POOLSIZ and TWSC\_POOLSIZ

ACMSPARAM.COM calculates the ACMSEGEN parameters TWS\_POOLSIZ and TWSC\_POOLSIZ as follows:

Calculate for each TDB and use the highest value:

$$\text{TWS\_POOLSIZ} = (\text{Pagesize} + (\text{wksp\_size\_sum} * \text{TOTAL\_TK\_INSTANCE\_CNT})) / 512$$

where:

$$\text{wksp\_size\_sum} = ((\text{sum of group workspace sizes} + \text{sum of user workspace sizes} + \text{sum of task workspace sizes}) \text{ rounded to next power of 2})$$

Pagesize is the CPU-specific page size (in bytes) of the VAX or Alpha system.

Calculate for each TDB and use the highest value:

$$\text{TWSC\_POOLSIZ} = (512 + (\text{wksp\_factor} * \text{TOTAL\_TK\_INSTANCE\_CNT})) / 512$$

where  $\text{wksp\_factor} = (52 + (16 * \text{wksp\_cnt\_sum}))$  rounded up to the next highest power of 2.

$$\text{wksp\_cnt\_sum} = (\text{number of group workspaces in TDB}) + (\text{number of user workspaces in TDB}) + (\text{number of task workspaces in TDB})$$

## Parameter and Quota Calculations

### A.5 Calculating Values for Certain ACMSGEN Parameters

The ACMSPARAM.COM calculations are estimations. If you wish to determine more accurately the value of the TWS\_POOLSIZE and TWSC\_POOLSIZE parameters, calculate the amount of pool required by each task group in each application on your system, and select the highest value from each calculation.

To calculate the size of each pool required by each task group, you need to consider how many users will be simultaneously executing each task in the task group. After calculating the workspace pool requirements of each task, multiply these values by the number of users who will be running those tasks simultaneously.

Use the following formula to determine the value for the TWS\_POOLSIZE parameter for each task group in each application:

```
(Pagesize ! pool control and management overhead
+ (t-1 * s-1)
+ (t-2 * s-2)
+ [...]
+ (t-n * s-n))/512
```

where:

Pagesize is the CPU-specific page size (in bytes) of the VAX or Alpha system.

t-n = (the greater of the following:

- a) sum of sizes of workspaces used by task 'n' rounded up to the next power of 2
- b) the CPU-specific page size))

s-n = <number of submitters simultaneously executing task 'n'>

Use the following formula to determine the value for the TWSC\_POOLSIZE parameter for each task group in each application:

```
(512 ! pool control and management overhead
+ (c-1 * s-1)
+ (c-2 * s-2)
+ [...]
+ (c-n * s-n))/512
```

where:

c-n = ( 52 + ( 16 \* <number of workspaces used by task 'n'> ) )  
rounded up to the next power of 2

s-n = <number of submitters concurrently executing task 'n'>

#### A.5.7.4.2 Calculating the Value of WS\_POOLSIZE and WSC\_POOLSIZE

ACMSPARAM.COM calculates the ACMSGEN parameters WS\_POOLSIZE and WSC\_POOLSIZE as follows:

Calculate for each application and use the highest value:

```
WS_POOLSIZE = (512 +
 grp_wksp_size_sum +
 (user_wksp_size_sum + TOTAL_TK_INSTANCE_CNT)) / 512
```

where grp\_wksp\_size\_sum = sum of: each group workspace size  
rounded up to the next highest power of 2

user\_wksp\_size\_sum = sum of: each user workspace size  
rounded up to the next highest power of 2

Calculate for each application and use the highest value:

```
WSC_POOLSIZE = (512 +
 (16 * (number of TDBs in application)) +
 (32 * (number of group workspaces in all TDBs in application))+
 (64 * TOTAL_TK_INSTANCE_CNT) +
 (32 * TOTAL_TK_INSTANCE_CNT)) / 512
```

## Parameter and Quota Calculations

### A.5 Calculating Values for Certain ACMSGEN Parameters

The ACMSPARAM.COM calculations are estimations. If you wish to determine more accurately the value of the WS\_POOLSIZ and WSC\_POOLSIZ parameters, calculate the amount of pool required by each application on your system and select the highest value from each calculation.

To calculate the size of each pool required by each application, consider how many group and user workspaces are used concurrently in each application.

Use the following formula to determine the value for the WS\_POOLSIZ parameter for each application:

```
(512 ! pool control and management overhead
+ (g-1 + g-2 + [...] + g-n)
+ (u-1 * s-1)
+ (u-2 * s-2)
+ [...]
+ (u-n * s-n))/512
```

where:

```
g-n = <size of group workspace 'n'> rounded up to the next power of 2
u-n = <size of user workspace 'n'> rounded up to the next power of 2
s-n = <number of submitters accessing user workspace 'n'>
```

Use the following formula to determine the value for the WSC\_POOLSIZ parameter for each task group in each application:

```
(512 ! pool control and management overhead
+ (16 * < number of groups ! group workspace and submitter list control
 in the application>) ! structures

+ (32 * < sum of number of ! group workspace control blocks
 group workspaces used in
 each task group in the
 application>)

+ (64 * < number of submitters ! submitter control blocks
 accessing user workspaces
 in the application>)

+ (32 * s-1) ! user workspace control blocks
+ (32 * s-2) ! user workspace control blocks
+ [...]
+ (32 * s-n))/512 ! user workspace control blocks
```

where:

```
s-n = number of submitters accessing user workspace 'n'
```

**A.5.7.4.3 Defining Logical Names for Workspace Pool Sizes** You can define the following logical names to size the workspace pools on a per-application basis:

- ACMS\$EXC\_WS\_POOLSIZ
- ACMS\$EXC\_WSC\_POOLSIZ
- ACMS\$EXC\_TWS\_POOLSIZ
- ACMS\$EXC\_TWSC\_POOLSIZ

You can define the logical names at any DCL level where the executable can translate them. To make them application-specific, reference logical names in the application definition or in a name table associated with an application. The following example shows referencing two of the logical names in the application definition:

## Parameter and Quota Calculations

### A.5 Calculating Values for Certain ACMSGEN Parameters

```
APPLICATION LOGICAL NAMES ARE
 ACMS$EXC_TWS_POOLSIZE = "1750",
 ACMS$EXC_TWSC_POOLSIZE = "75";
```

The EXC allows one additional translation of the logical name so that an application definition does not have to be rebuilt to change a value. For example:

In the Application Definition Utility (ADU):

```
APPLICATION LOGICAL NAMES ARE
 ACMS$EXC_TWS_POOLSIZE = "ACMS$EXC_<appl_name>_TWS_POOLSIZE";
```

At DCL level:

```
$ DEFINE/SYSTEM ACMS$EXC_<appl_name>_TWS_POOLSIZE "1750"
```

In the preceding examples of the additional logical name definitions, <appl\_name> is the name of the application.

Remember the following about using these logical names:

- The logical name (or the translation of it) must contain a valid decimal number (pagelets for Alpha).
- ACMS uses the ACMSGEN parameters if the logical cannot be translated or the logical contains an invalid value or character.
- As with any value specified by ACMSGEN, if the value contained in one or more of the logicals is too high, the application will not start.
- The ACMSPARAM and ACMEXCPAR procedures will not have any knowledge of the changes made to the workspace pools by using these logicals. Any calculations done by these procedures will reflect the values in ACMSGEN.



---

## Error Messages

This appendix contains file specifications for the ACMS error message files and information about how ACMS reports error messages generated by other products.

### B.1 ACMS Error Messages

For explanations and user actions on the messages the ACMS commands and application management utilities return, use the help available for each utility, or type or print the following files at DCL command level:

```
SYS$SYSROOT: [SYSHLP]ACMSAAU.MEM
SYS$SYSROOT: [SYSHLP]ACMSATR.MEM
SYS$SYSROOT: [SYSHLP]ACMSDDU.MEM
SYS$SYSROOT: [SYSHLP]ACMSGEN.MEM
SYS$SYSROOT: [SYSHLP]ACMSQUEMGR.MEM
SYS$SYSROOT: [SYSHLP]ACMSRUN.MEM
SYS$SYSROOT: [SYSHLP]ACMSSWL.MEM
SYS$SYSROOT: [SYSHLP]ACMSUDU.MEM
```

Online help is not available for terminal user messages. For an explanation of terminal user messages, display or print the following file:

```
SYS$SYSROOT: [SYSHLP]ACMSTU.MEM
```

Online help is not available for Audit Trail Logger errors. For an explanation of messages written to the Audit Trail Logger, display or print the following file:

```
SYS$SYSROOT: [SYSHLP]ACMSATL.MEM
```

### B.2 Error Messages from Other Products

The ACMS Audit Trail Report (ATR) Utility cannot translate message codes from any facility other than ACMS and TDMS. When an error generated by another product occurs, ACMS reports the error message number of the message, not the message itself, for example:

```
message number 000288664
```

Enable the ATR Utility to translate message codes from other products by using the SET MESSAGE command and specifying the name of the product's error message file, for example:

```
$ SET MESSAGE SYS$MESSAGE:DBMSG.EXE
```

See documentation on the product you are interested in for the name of its error message file.





---

## Requirements for Successful ACMS Sign-Ins

As system manager, you must understand the problems users can have when they try to sign in to ACMS. You have control over the tools that can prevent or allow successful sign-ins. This appendix lists a set of requirements to help ensure that users can access ACMS.

### C.1 ACMS Sign-In Requirements

The ACMS software requires that certain files be present and certain entries be available in various databases before users can sign in to ACMS on ACMS-controlled or OpenVMS-controlled terminals. The requirements listed here can help you identify problems users encounter.

First, check the Software Event Log (SWL) and the Audit Trail Report (ATR) for additional details on the failure. If the SWL and audit information is not detailed enough to resolve the problem, then continue with the following checklist.

When these errors occur for only *some* of the users typing an ACMS/ENTER, check the following items:

- The user must have a valid entry in the OpenVMS SYSUAF.DAT file. In cases in which the OpenVMS SYSUAF.DAT file has been modified (such as where cluster creation has required several SYSUAF.DAT files to be merged together), ACMS must be stopped and restarted to map the newly modified SYSUAF.DAT into memory.
- The user doing the ACMS/ENTER is listed specifically in the User Definition Utility (ACMSUUF.DAT) file, or \$ALL is used.
- The terminal from where the ACMS/ENTER was keyed is listed specifically in the Device Definition Utility (ACMSDDF.DAT) file, or \$ALL is used.
- The terminal type is supported by both ACMS and any forms product in use by ACMS (such as HP DECforms or TDMS).
- The menu database file (.MDB) specified in the ACMSUUF.DAT database for the terminal user must be valid and exist in the correct disk directory. Beware of process logical names, because separate processes are involved. (SYSTEM logicals are recommended.)
- The menu specified in the ACMSUUF.DAT database for the terminal user must be a menu that exists in the specified .MDB file.
- The terminal user's user name matches that of the agent handling the user, or the agent's user name is authorized with the /AGENT qualifier in the ACMSUUF.DAT database.
- The terminal user's user name must be less than or equal to 12 characters in length.

## Requirements for Successful ACMS Sign-Ins

### C.1 ACMS Sign-In Requirements

When these errors occur for *all* users typing an ACMS/ENTER, check these items:

- The file SYS\$COMMON:[SYSEXEC]RIGHTSLIST.DAT must exist on the system. If it does not, add the file with AUTHORIZE by entering:  
UAF> CREATE/RIGHTS
- The command menu .MDB file, ACMSCMD.MDB, must be valid and exist in the ACMS\$DIRECTORY disk directory.
- The ACMS menu request library file, ACMSREQ.RLB, must be valid and exist in the SYS\$LIBRARY disk directory.
- The user name used by the Command Process (CP) and the Queued Task Initiator (QTI) must have been added as an agent in the ACMSUFD.DAT database. By default, this user name is SYSTEM.
- The application must be properly authorized for use in ACMS with the Application Authorization Utility (AAU).
- Check to be sure the .ADB file is valid by entering the following:

```
$ RUN SYS$SYSTEM:ACMSADU
ADU> DUMP APPLICATION <ADB-filename>
```

If this command generates an error, then rebuild the application to create a new .ADB file.

- Check to see that the user name specified for the Terminal Subsystem Controller (TSC) has sufficient ASTLM quota.

## A

---

### AAU

*See* Application Authorization Utility

### ACC

*See* ACMS Central Controller

### Access

restricting

for terminals, 2–5

with /CONTROLLED qualifier, 2–15

with menu suppression, 3–5

restricting with /CONTROLLED qualifier, 2–7

Access Control List, 19–2

### Accounts

adding to SYSUAF.DAT with

ACMSPARAM.COM, 10–2

### ACC\_PRIORITY

ACMSGEN parameters not calculated by

ACMSPARAM.COM, 10–13

### ACC\_USERNAME

ACMS system parameter, 11–11

variable required for ACMSPARAM.COM,  
10–15t

variable value not set by INITIAL or

FEEDBACK mode, 10–14

### ACMEXCPAR.COM

default quota values, 10–2

exceptions to use of, 10–2

initialization file, 10–29

modifying quotas, 10–32

phases of, 10–26, 10–27t

required variables, 10–30t

running, 10–26

setting EXC quotas with, 10–1, 10–25 to 10–33

variables required for, 10–30t

when used, 10–1

### ACMS

*See* ACMS system

sign in, 16–3, 16–6

sign out, 16–6

ACMS\$ATL\_ALQ\_BLOCKS, 12–2

ACMS\$ATL\_DEQ\_BLOCKS, 12–2

ACMS\$AUDIT\_LOG, 12–2, 12–6

ACMS\$AUDIT\_NETWORK\_CONNECTIONS

logical, 7–3, 7–7

ACMS\$CANCEL.LOG

cancellation information file, 8–12

ACMS\$CANCEL\_DIR, 8–13

ACMS\$CANCEL\_USER\_WAIT, 8–13

logical name for cancellation interval, 8–13

ACMS\$DEQUEUE\_TASK

service, 5–7

ACMS\$DIRECTORY

installing applications in, 21–11

logical name for application database directory,  
4–1, 9–1, 9–2

menu database, 3–3

removing application from, 9–2

ACMS\$ENABLE\_DATA\_COMPRESSION logical,

7–3, 7–4, 7–5

ACMS\$EXC\_TWSC\_POOLSIZE, A–24

ACMS\$EXC\_TWS\_POOLSIZE, A–24

ACMS\$EXC\_WSC\_POOLSIZE, A–24

ACMS\$EXC\_WS\_POOLSIZE, A–24

ACMS\$EXIT

for no user menu, 3–5

ACMS\$FEEDBACK.DAT

input file for ACMSPARAM.COM, 10–5, 10–11

ACMS\$MONITOR.COM

running, 10–9 to 10–13

use with ACMSPARAM.COM, 10–5, 10–9

ACMS\$MONITOR\_INIT.DAT

ACMS\$MONITOR.COM initialization file,  
10–9

ACMS\$MONITOR\_STATS.TXT

ACMS processes report file, 10–11

ACMS\$MONITOR\_WARNING.TXT

ACMS\$MONITOR.COM output file, 10–12

ACMS\$NOTICE

defining as a logical name, 11–11

ACMS\$QUEUE\_TASK

service for creating queued task elements, 5–2,  
5–4, 5–6

ACMS\$SELECTION\_STRING system workspace,  
21–53

ACMS\$SIGN\_IN service, 7–3, 16–5

ACMS\$START\_MONITOR.COM

for starting ACMS\$MONITOR.COM, 10–9

ACMS\$SWL\_LOG  
 logical for SWL log file, 13-2

ACMS/CANCEL TASK  
 command  
 operator, 9-13, 21-2

ACMS/CANCEL USER  
 command  
 operator, 8-12, 21-5  
 to release license units, 16-6

ACMS/DEBUG  
 command  
 ACMSDEBUG Utility, A-15  
 operator, 21-8

ACMS/ENTER  
 command  
 operator, 21-10

ACMS/INSTALL  
 command  
 operator, 4-2, 9-1, 9-2, 21-11

ACMS/MODIFY APPLICATION  
 command  
 operator, 9-9, 9-10, 21-13

ACMS/REPLACE SERVER  
 command  
 operator, 9-11, 12-17, 21-17

ACMS/REPROCESS APPLICATION\_SPEC  
 command  
 operator, 9-12, 21-19

ACMS/RESET  
 command  
 and device authorization, 2-1

ACMS/RESET AUDIT  
 command  
 operator, 21-21

ACMS/RESET TERMINALS  
 command  
 operator, 21-22

ACMS/SET QUEUE  
 command  
 operator, 21-23

ACMS/SET SYSTEM  
 command  
 operator, 8-8, 21-24

ACMS/SHOW APPLICATION  
 command  
 operator, 9-4, 9-6, 21-26  
 for displaying static information, 9-4

ACMS/SHOW APPLICATION/CONNECTIONS  
 command, 16-5

ACMS/SHOW APPLICATION/CONTINUOUS  
 command  
 operator, 9-7, 9-9, 21-31

ACMS/SHOW QTI  
 command  
 operator, 8-9, 21-33

ACMS/SHOW QUEUE  
 command  
 operator, 8-11, 21-34

ACMS/SHOW SERVER  
 command  
 operator, 9-11, 21-35

ACMS/SHOW SYSTEM  
 command, 16-5, 21-37  
 operator, 8-4, 8-6

ACMS/SHOW TASK  
 command  
 operator, 8-7, 9-13, 9-17, 9-18, 21-39

ACMS/SHOW USER  
 command, 16-5, 16-6, 21-41  
 operator, 8-13

ACMS/START APPLICATION  
 command  
 operator, 9-3, 21-46

ACMS/START QTI  
 command  
 operator, 8-9, 21-48

ACMS/START QUEUE  
 command  
 operator, 8-10, 21-49

ACMS/START SYSTEM  
 command  
 operator, 8-1, 8-3, 21-51

ACMS/START TERMINALS  
 command  
 operator, 8-7, 21-55

ACMS/STOP APPLICATION  
 command, 16-6  
 operator, 9-3, 9-4, 9-12, 21-56

ACMS/STOP QTI  
 command  
 operator, 8-9, 21-58

ACMS/STOP QUEUE  
 command  
 operator, 8-11, 21-59

ACMS/STOP SYSTEM  
 command  
 operator, 8-3, 8-5, 9-12, 21-60

ACMS/STOP TERMINALS  
 command  
 operator, 8-7, 21-61

ACMSAAF.DAT  
 application authorization file, 4-1, 4-2, 9-2  
 creating, 4-2  
 location of, 19-4  
 logical name for, 4-2

ACMSAUDIT.LOG  
 audit trail log file, 12-1  
 logical name for, 12-2

ACMSCANCEL.COM, 8-12  
 cancelling  
 users with, 8-12

ACMS Central Controller, 6-4  
 affected by ACMSGEN parameters, 11-2t  
 assigning  
 user name to, 11-11  
 memory requirements for, 14-5

## ACMS Central Controller (cont'd)

- parameters
  - displaying, 22-5
  - for, 11-9
- quotas and privileges, A-4
- starting interactively, 8-3
- stopping, 8-4
- user name, A-4
  - quotas, A-4
- ACMSCMD.MDB
  - and login errors, C-2
- ACMS database files
  - source for ACMSPARAM.COM variables, 10-8
- ACMSDDF.DAT
  - device authorization file, 2-1, 2-2
  - logical name for, 2-2
- ACMSDDU.LIS, 17-12
- ACMSDEBUG Utility, 21-37
  - commands, A-15
- ACMS Desktop
  - See* TP Desktop Connector
- ACMSDQF
  - logical name for queue definition file, 5-3
- ACMSGEN Utility, 15-5, 16-5
  - ACMSPAR.ACM, 22-15
  - ACMSPAR.ACM parameter file, 11-1
  - active values, 22-8
  - changing parameter values, 11-3
  - commands, 22-2 to 22-15
    - EXIT, 11-3, 22-2
    - HELP, 11-2, 11-3, 22-3
    - SET, 11-4, 11-5, 11-6, 22-4
    - SHOW, 11-2, 11-6, 11-7e, 11-8e, 22-5
    - summary, 11-16t
    - USE, 11-4, 22-7
    - USE ACTIVE, 11-5, 22-8
    - USE CURRENT, 11-5, 22-10
    - USE DEFAULT, 11-4, 11-5, 11-6, 22-11
    - WRITE, 22-7, 22-12
    - WRITE ACTIVE, 11-5, 22-13
    - WRITE CURRENT, 11-4, 22-15
  - creating work file, 22-12
  - current values, 22-10
    - changing, 22-15
  - default values, 22-11
  - displaying parameter values, 11-6
  - distributed forms processing, 6-3, 6-7
  - dynamic parameters
    - changing, 22-13
  - dynamic values, 22-13
  - exiting from, 11-3, 22-2
  - function of, 11-1
  - global section, 22-8
  - MSS\_POOLSIZE parameter, 21-37
  - MSS\_PROCESS\_POOL parameter, 21-37
  - parameters
    - changing, 22-4, 22-6
    - for, not set by ACMSPARAM.COM, 10-13

## ACMSGEN Utility

- parameters (cont'd)
  - resetting, 11-4
  - setting, 11-4
  - updating, 11-4
  - values, 11-15t
  - value types, 11-3
- preferred use of ACMSPARAM.COM, 10-1, 11-1
- prompt, 11-2
- running, 11-2
- saving values, 11-5
- WORK.ACM, 11-6
- work area, 11-1
- work file, 11-6, 22-7
- WRITE CURRENT, 6-3
- ACMS kit options, 16-1
- ACMS monitor
  - See* ACMS\$MONITOR.COM
- ACMSPAR.ACM
  - parameter file, 11-1, 22-10, 22-15
  - WRITEPAR phase output file, 10-7t
- ACMSPAR.ACM parameter file, 6-4
- ACMSPARAM.COM
  - assigning accounts and privileges in SYSUAF.DAT with, 10-2
  - calculating SYSGEN parameters, 10-6
  - default parameter and quota values, 10-2
  - distributed forms processing, 6-2, 6-7
  - exceptions to use of, 10-2
  - parameters
    - OpenVMS, calculation of, A-2f
  - phases, 10-7t
  - running, 10-2
  - setting parameters and quotas with, 10-1, 10-2 to 10-25
  - user name
    - quotas, A-4
  - when used, 10-1
- ACMSPARAM.DAT
  - GENPAR phase output file, 10-7t
  - WRITEPAR phase input file, 10-7t
- ACMS proxy
  - ACMSPROXY.DAT file, 6-4
  - choices, 6-5
  - creating, 6-6
  - file locations, 6-5
  - security, 6-6
  - setting up file, 6-5
- ACMSPROXY.DAT file, 6-4, 6-5
- ACMSPROXY.LIS file, 18-22
- ACMSQDF.DAT
  - changing logical for, 5-3
  - task queue definition file, 5-1
- ACMSQUEMGR
  - See* Queue Manager Utility

- ACMSREQ.RLB
  - and login errors, C-2
- ACMS system
  - accessing, 21-10
  - ACMS Central Controller, 8-3
  - active Application Execution Controllers
    - displaying, 8-5
  - active values, 22-8
  - auditing, 12-18 to 12-21
    - disabling, 21-24, 21-51
  - authorization tools, 1-1
  - authorizing
    - Command Process, 3-9
    - QTI, 3-9
    - users, 3-1, C-1
  - backup node, 21-19
  - caching HP DECforms escape routines, 6-20
  - canceling
    - tasks, 21-2
    - users, 8-12, 21-5
  - changing
    - parameters, 22-4
  - characteristics
    - setting, 21-24
  - controlled terminal and startup, 8-3
  - control process swapping, 14-2
  - current values, 22-10
  - default values, 22-11
  - delays, 14-1
  - displaying information about, 8-4
  - displaying user information, 21-41
  - distributed, 6-1
  - distributing resources, 14-1
  - dynamic memory, 14-1
  - effect of using `Ctrl/Y`, 8-4
  - enabling auditing, 21-24, 21-51
  - error messages, B-1
  - global section, 22-13
  - improper shutdown, 8-4
  - installing applications, 21-11
  - logging internal errors, 13-1
  - managing, 1-2, 8-1 to 8-16
  - maximum Sign-ins, A-15
  - menu, 21-10
  - message
    - from another product, 12-21
  - modifying parameters with ACMSGEN, 11-1
  - monitoring, 1-2
  - monitoring I/O, 14-2
  - monitoring with ACMS\$MONITOR.COM, 10-11
  - operator terminals
    - disabling, 8-8, 21-24
    - enabling, 8-8, 21-24
  - overhead, 11-11
  - parameters, 11-1 to 11-17, 14-2
    - displaying, 11-7, 22-5
    - set by ACMSPARAM.COM, 10-2
  - ACMS system
    - parameters (cont'd)
      - value types, 11-3
    - performance, 11-1
    - processes, 14-3
    - process user names, 10-2
    - resetting terminals, 21-22
    - resources, 14-1
    - run-time processes, 10-1
    - setting parameters and process quotas for, 10-1
    - sign-in
      - requirements, C-1
    - sign-ins
      - delay, 11-11
      - disabling, 8-7
    - starting, 8-1, 21-51
      - applications, 21-46
      - QTI, 21-51
      - TSC, 21-51
    - state of, 8-5
    - stopping, 8-3, 21-60
      - tasks, 8-4
    - SYSGEN parameters, 10-6, A-2
    - task debugger parameters, 10-6
    - terminals
      - limiting number of, 11-11
    - tools for monitoring, 14-2 to 14-3
    - tuning, 1-3, 14-1 to 14-13
    - usage monitored with ACMS\$MONITOR.COM, 10-11
    - user information
      - displaying, 8-13
    - users
      - displaying current, 8-5
      - limiting number of, 11-11
      - workspace pool, 8-6
- ACMSTART.COM, 8-2
  - and Queued Task Initiator, 8-3
  - invoking from OpenVMS startup file, 8-2
- ACMS Task Debugger, 21-8
- ACMSUDEF.DAT
  - See* User definition file
  - See* User Definition Utility
- ACMSUDU.DAT
  - specifying language in, 3-7
- ACMSVAR.DAT, 10-13
  - GENPAR phase input file, 10-7t
  - GENVAR phase output file, 10-7t
- ACMSYSPAR.DAT
  - WRITEPAR output file, 10-6
  - WRITEPAR phase output file, 10-7t
- ACMS\_POST\_INSTALL.COM, 8-2
- ACMS\_SETUP.COM
  - executing startup with, 8-3
- ACMVARINI.DAT
  - editing to set ACMSPARAM.COM variables, 10-13



- ACMVARINI.DAT (cont'd)
  - GENVAR phase input file, 10-7t
  - modifying, 10-13
  - precedence of variable values in, for
    - ACMSPARAM.COM, 10-8
  - precedence over INITIAL and FEEDBACK, 10-5, 10-13
- Active
  - ACMS system parameters, 11-8
  - type of ACMSGEN parameter value, 11-3
- .ADB file
  - See Application database
- ADB\_BLKs
  - variable required for ACMSPARAM.COM, 10-15t
  - variable set in FEEDBACK mode, 10-5
- ADD
  - command
    - AAU, 4-4, 19-2
    - DDU, 2-2, 17-2, 17-3
    - UDU, 3-2, 3-4, 18-2
- ADD/PROXY
  - command, 18-7
- ADU
  - See Application Definition Utility
- Agent, 7-1, 7-7, 7-10, 15-6, 16-3
  - ID, 8-13
  - QTI, A-9
- Agent program
  - authorizing an, 3-9, 18-2
  - Command Process, 3-9
  - nonprivileged, 6-19
  - privileged, 6-19
- AGENT\_CNT
  - variable required for ACMEXCPAR.COM, 10-30t
  - variable required for ACMSPARAM.COM, 10-15t
  - variable value not set by INITIAL or FEEDBACK mode, 10-14
- AGENT\_SUB\_CNT
  - variable required for ACMSPARAM.COM, 10-15t
- ALL
  - ACMEXCPAR.COM phase parameter, 10-26
  - ACMSPARAM.COM phase parameter, 10-3
  - HP DECtrace report statistic, 15-21
- \$ALL
  - and login errors, C-1
  - application
    - authorization, 4-4
  - group device name, 2-3t
  - user authorization, 3-1, 3-3, 18-5
- ALL-IN-1, 16-3
- APL\_RESPONSE event, 15-5
- APL\_USERNAME
  - ACMS item with HP DECtrace, 15-7t
- Application
  - ACMS\$DIRECTORY, 4-1, 9-2
  - active tasks, 9-5
  - after installing, 9-2
  - APPLICATION LOGICAL NAME clause, 7-3
  - attributes, 21-13
  - auditing, 12-16, 21-13
  - audit log, 12-11
  - audit trail record, 9-9
  - authorization, 9-1, 9-2
  - authorization file
    - application data, 4-3
    - default server process name, 4-3
    - default user name, 4-3
  - authorization information, 4-1
  - authorization list, 4-6
  - authorizing, 4-1, 4-4, 19-2
  - availability, 21-19
  - before authorizing, 4-3
  - before installing, 4-4
  - canceling tasks in, 9-12, 21-2
  - conditions for installing, 4-3F
  - controlling dynamic display, 9-9
  - database
    - See Application database
  - default
    - authorization, 4-3, 19-8
  - deleting or restarting, 9-2
  - disabling auditing, 9-9
  - displaying
    - authorization for, 4-6e
    - authorized, 19-23
    - dynamic information about, 9-7, 21-31
    - information about, 9-4
    - pool information, 9-6
    - server information, 21-26
    - static information, 9-4
    - task information, 9-14
    - tasks, 21-39
  - displaying information about, 21-26, 21-41
  - displaying user information, 21-26, 21-37
  - distributed, 6-1
  - distributed processing, 9-12
  - error messages, 21-25, B-1
  - EXC quotas, 10-29
  - Execution Controller, 14-1
  - failover, 6-1
  - freeing resources, 9-3
  - global authorization, 4-4
  - individual authorization, 4-5
  - installing, 9-1, 21-11
  - limiting server processes, 9-9
  - logical name and search list, 9-2
  - management, 1-1, 9-1 to 9-18
  - management tools, 1-3t
  - maximum
    - active servers in, 21-13
    - executing tasks in, 21-13

- Application
  - maximum (cont'd)
    - task instances, 9-5
  - modifying
    - active, 9-9, 21-13
    - server attributes, 9-10
    - task attributes, 9-10
  - node, 6-2
  - performance, 14-1
    - affected by EXC, 14-9
    - affected by servers, 14-9
  - preventing installation of, 4-5
  - process of installing, 9-1f
  - reinstalling, 9-2, 9-3
  - removing, 9-2
  - removing authorization for, 4-6
  - renaming authorization, 4-7
  - replacing server image, 21-17
  - reprocessing specification, 9-12
  - resources, 14-1
  - retranslating specification for, 21-19
  - running, 9-2
  - search list, 9-12, 21-19
  - security, 4-2
  - server monitoring, 9-9, 21-13
  - server name, 9-5
  - server processes, 9-5
  - server process name, 4-3
  - specifications, 6-9
  - starting, 9-3, 21-46
  - stopping, 9-3, 21-56
  - tools for monitoring, 14-2 to 14-3
  - tuning, 14-1 to 14-13
  - UIC, 9-2
  - updating, 9-3, 21-19
  - user authorization, 19-2
  - user name, 4-3
  - workspace pages, 11-15
  - workspace pool, 21-26
- Application authorization file
  - See* Application, authorization file
- Application Authorization Utility, 4-1 to 4-8
  - access control list, 4-3, 19-2
  - ACMS\$DIRECTORY, 4-1
  - ACMSAAF.DAT, 4-2
  - adding new authorization, 19-2
  - \$ALL
    - authorization, 4-4
  - application
    - statistics, 4-1
  - authorization file, 4-2, 9-2
  - authorizing users, 19-2
  - changing default values, 4-3
  - commands, 19-2 to 19-23
    - ADD, 4-4, 4-5, 19-2, 19-4
    - COPY, 4-5, 19-5, 19-6
    - DEFAULT, 4-3, 19-8, 19-10
    - EXIT, 19-11
- Application Authorization Utility
  - commands (cont'd)
    - HELP, 19-12
    - LIST, 4-6, 19-14
    - MODIFY, 4-3, 19-16
    - REMOVE, 4-6, 19-19
    - RENAME, 4-7, 19-20, 19-21
    - SHOW, 4-6, 19-23
      - summary of, 4-7t
  - controlling users, 4-5
  - creating authorizations, 4-1f
  - default
    - authorization, 4-3t
    - server process name, 4-3
    - user name, 4-3
  - deleting authorization, 4-6
  - displaying authorization, 4-6e, 19-23
  - function of, 4-1
  - global authorization, 4-4
  - individual authorization, 4-5
  - initial values, 4-3
  - listing authorization, 4-6
  - logical name, 4-2
  - removing applications, 9-2
  - running, 4-2
  - sample authorization, 4-4
  - security, 4-1
- Application database
  - See also* Databases
  - .ADB file, 4-2, 6-10, 8-14t, 9-1, 9-2, 10-5, 21-11, A-12, C-2
- Application database file
  - See* Application database
- Application Definition Utility
  - license requirements, 16-4
  - quotas, A-14t
- Application Execution Controller, 7-3, 15-5
  - configuring for performance, 14-9
  - decreasing paging, 14-1
  - function of, 14-3
  - memory usage, 14-5
  - monitoring with SPM, 14-9
  - parameters
    - displaying, 22-5
    - quotas and privileges, A-11
    - setting process quotas for, 10-25 to 10-33
    - stopping, 9-3
    - user name, A-11
    - working set size, 14-9
- APPLICATION LOGICAL NAME clause, 7-3
- <application-name>\_GENVAR.DAT
  - initialization file for ACMEXCPAR.COM, 10-26
- Application port
  - compared to dedicated service port, 2-7
  - LAT setup for, 2-9
  - LAT terminal port, 2-8



**APPL\_CNT**  
 variable required for ACMSPARAM.COM, 10–16t  
 variable set in FEEDBACK mode, 10–5

**APPL\_NAME**  
 user-prompted variable in INITIAL mode, 10–4  
 variable required for ACMSPARAM.COM, 10–16t

**APPL\_NODE**  
 ACMS item with HP DECtrace, 15–7t

**APPL\_SPEC**  
 ACMS item with HP DECtrace, 15–7t

**ATL**  
*See* Audit Trail Logger

**ATR**  
*See* Audit Trail Report Utility

**At sign**  
*See* @ (At sign)

**@ (At sign)**  
 command  
 SWLUP, 24–2

**Auditing**  
 enabling  
   at server level, 9–10  
   at task-level, 9–11

**Audit log**, 7–8  
 for data compression, 7–8

**Audit Trail Log**  
 file name, 12–1

**Audit Trail Logger**, 12–8e  
 creating new versions, 21–21  
 creating reports, 12–6  
 displaying records, 12–6  
 enabling and disabling, 12–1  
 events logged by, 12–3t  
 explanation of messages, B–1  
 information logged by, 12–1  
 location of log file, 14–7  
 modifying active applications, 21–13  
 opening new log file, 21–21  
 remote authentication, 12–18 to 12–21  
 restarting, 12–2, 21–21  
 selecting  
   information in, 12–9  
   records in, 12–9  
 server auditing, 21–14  
 starting, 21–24  
 storing on tape, 12–2  
 task auditing, 21–15

**Audit trail record**  
 application modification, 12–16  
 modified  
   application, 9–9  
   task, 9–11  
 server  
   image, 9–11  
   server process dump, 12–16

**Audit trail record (cont'd)**  
   server replacement, 12–17

**Audit Trail Report Utility**, 12–1 to 12–22  
 application modification record, 12–16  
 audit trail log file, 12–2  
 commands, 23–2 to 23–7  
   EXIT, 12–6, 23–2  
   HELP, 12–5, 23–3  
   LIST, 12–5, 12–6e, 23–4  
   summary, 12–21t  
 creating reports with, 12–6  
 information logged by, 12–11  
 QTI auditing, 12–15  
 report, 12–6e  
 resetting log file, 21–21  
 running, 12–5  
 selecting  
   information, 12–9  
   server process auditing, 12–16  
   translating error messages, B–1  
   writing records to a file, 12–6

**Authorization**  
 ACMS process user names, 8–1  
 adding  
   for applications, 19–2  
   for users, 18–2  
 application, before installing, 9–1  
 Command Process, as agent, 18–5  
 copying, for applications, 19–5  
 copying in UDU, 18–7  
 default, for applications, 19–8  
 displaying  
   for applications, 19–23  
   for users, 18–34  
 file  
   creating, for users, 3–2  
   creating for application, 4–2  
   for devices, 2–2  
   for users, 3–1  
 for groups of devices, 2–3  
 for users, OpenVMS and ACMS, 3–1, 3–3  
 initial values, for user, 4–3t, 18–16  
 listing  
   for applications, 19–14  
   for users, 18–20  
   terminals, 17–12  
 modifying  
   for applications, 19–16  
   for users, 18–23  
 of new terminals with DDU, 17–2  
 removing, for applications, 19–19  
 renaming  
   for applications, 19–20  
   for users, 18–30  
 terminal, 2–2  
 tools for, 1–1  
 user, 3–1  
   as agent, 18–2

- Authorization
  - user (cont'd)
    - with \$ALL, 3-3
- Autologin
  - enabling with Device Definition Utility, 2-4
  - use with DDU RENAME command, 2-5

## B

---

- Backup node
  - redistributing workload, 21-19
- BASE quota, A-14
- BIO
  - resource utilization item with HP DECtrace, 15-6t

## C

---

- Caching
  - distributed forms processing, 6-17
  - distributed processing, 6-14
  - in clusters, 6-13
  - logical name assignments, 6-13
  - sharing, 6-19
- Cancel procedures
  - ACMSCANCEL.COM, 8-12
- Capacity license
  - See* Unlimited-use license
- CDD, 16-2
- Central Controller
  - See* ACMS Central Controller
- CHANNELCNT
  - OpenVMS SYSGEN parameter set by ACMSPARAM.COM, 10-6
- Characteristics
  - listing
    - for terminals, 17-12
  - modifying
    - for terminals, 17-14
  - setting
    - for queued task elements, 5-7
    - for task queues, 5-4
- Cluster
  - caching in, 6-13
  - distributed forms processing, 6-2
- COLLECT
  - command
    - DECtrace, 15-1
- Collection class, 15-12
  - default for ACMS, 15-12
  - of HP DECtrace events and items, 15-2
- Command Process
  - affected by ACMSGEN parameters, 11-2t
  - and development kit, 16-1
  - assigning
    - user name of, 11-11
  - authorizing, 3-9
    - as agent, 18-5

- Command Process
  - authorizing (cont'd)
    - user as, 18-5
  - changing user name of, 3-9
  - configuring for performance, 14-8
  - enabling data compression for, 7-1
  - function of, 14-3
  - memory requirements, 14-5
  - monitoring, 14-8
  - parameters
    - displaying, 22-5
    - for, 11-10
  - performance, 14-8
  - permanent, 11-12
  - quotas and privileges, A-7
  - setting priority of, 14-9
  - starting, 11-11
  - user name, A-7
    - quotas, A-4
  - working set size, A-8
- Commands (AAU)
  - ADD, 4-4, 19-2
  - COPY, 4-5
  - DEFAULT, 4-3, 19-8
  - EXIT, 19-11
  - HELP, 4-2, 19-12
  - LIST, 4-6, 19-14
  - MODIFY, 4-3, 19-16
  - REMOVE, 4-6, 19-19
  - RENAME, 4-7, 19-20
  - SHOW, 4-6, 19-23
- Commands (ACMSGEN)
  - EXIT, 11-3, 22-2
  - HELP, 11-2, 22-3
  - SET, 11-4, 22-4
  - SHOW, 11-2, 11-6, 11-7e, 11-8e, 22-5
  - USE, 11-4, 22-7
  - USE ACTIVE, 22-8
  - USE CURRENT, 11-5, 22-10
  - USE DEFAULT, 11-4, 11-6, 22-11
  - WRITE, 22-12
  - WRITE ACTIVE, 22-13
  - WRITE CURRENT, 11-4, 22-15
- Commands (ACMSQUEMGR)
  - CREATE QUEUE, 5-4, 20-2
  - DELETE ELEMENT, 5-7, 20-5
  - DELETE QUEUE, 5-5, 20-9
  - EXIT, 5-2, 20-10
  - HELP, 5-2, 20-11
  - MODIFY QUEUE, 5-4, 20-13
  - SET ELEMENT, 5-7, 20-15
  - SET QUEUE, 5-4, 20-19
  - SHOW ELEMENT, 5-8, 20-21
  - SHOW QUEUE, 5-5, 20-25
- Commands (ATR)
  - EXIT, 12-6, 23-2
  - HELP, 12-5, 23-3
  - LIST, 12-5, 12-6, 23-4

### Commands (DDU)

ADD, 2-2, 17-2  
COPY, 2-3, 17-5  
DEFAULT, 2-5, 17-8  
EXIT, 17-10  
HELP, 17-11  
LIST, 17-12  
MODIFY, 2-3, 17-14  
REMOVE, 2-5, 17-17  
RENAME, 2-5, 17-18  
SHOW, 2-6, 17-21

### Commands (Operator)

ACMS/CANCEL TASK, 9-13, 21-2  
ACMS/CANCEL USER, 8-12, 21-5  
ACMS/ENTER, 21-10  
ACMS/INSTALL, 9-1, 9-2, 21-11  
ACMS/MODIFY APPLICATION, 9-9, 9-10, 21-13  
ACMS/REPLACE SERVER, 9-11, 21-17  
ACMS/REPROCESS APPLICATION\_SPEC, 9-12, 21-19  
ACMS/RESET AUDIT, 21-21  
ACMS/RESET TERMINALS, 21-22  
ACMS/SET QUEUE, 21-23  
ACMS/SET SYSTEM, 8-8, 21-24  
ACMS/SHOW APPLICATION, 9-4, 9-6, 21-26  
ACMS/SHOW APPLICATION/CONTINUOUS, 9-7, 9-9, 21-31  
ACMS/SHOW QTI, 8-9, 21-33  
ACMS/SHOW QUEUE, 8-11, 21-34  
ACMS/SHOW SERVER, 21-35  
ACMS/SHOW SYSTEM, 8-4  
ACMS/SHOW SYSTEM/POOL, 8-6  
ACMS/SHOW TASK, 8-7, 9-13, 9-17, 9-18, 21-39  
ACMS/SHOW USER, 8-13  
ACMS/START APPLICATION, 9-3, 21-46  
ACMS/START QTI, 8-9, 21-48  
ACMS/START QUEUE, 8-10, 21-49  
ACMS/START SYSTEM, 8-1, 8-3, 21-51  
ACMS/START TERMINALS, 8-7, 21-55  
ACMS/STOP APPLICATION, 9-3, 9-4, 9-12, 21-56  
ACMS/STOP QTI, 8-9, 21-58  
ACMS/STOP QUEUE, 8-11, 21-59  
ACMS/STOP SYSTEM, 8-3, 8-5, 9-12, 21-60  
ACMS/STOP TERMINALS, 8-7, 21-61

### Commands (SWLUP)

@ (At sign), 24-2  
EDIT, 24-3  
EXIT, 24-5  
HELP, 24-6  
LIST, 24-7  
RENEW, 24-10  
SAVE, 24-11  
SET [NO]LOG, 24-12, 24-13  
SHOW CURRENT, 24-14  
SHOW LOG, 24-15

### Commands (SWLUP) (cont'd)

SHOW VERSION, 24-16  
STOP, 24-17

### Commands (UDU)

ADD, 3-2, 3-4, 18-2  
COPY, 3-3, 18-9  
DEFAULT, 3-2, 18-14  
EXIT, 18-18  
HELP, 3-2, 18-19  
LIST, 3-10, 18-20  
MODIFY, 3-7, 3-8, 18-23  
REMOVE, 3-11, 18-27  
RENAME, 3-11, 18-30  
SHOW, 3-10, 18-34

COMPRESSED\_MSG event, 7-11, 15-6

### COMPRESSED\_SIZE

ACMS item with HP DECtrace, 15-7t

### Compression ratio

measured by DECtrace, 15-6  
of data compression, 7-2

### COMPRESSN\_RATIO

ACMS item with HP DECtrace, 15-7t

### Concurrent-use license, 16-1, 16-2

available in kits, 16-2  
in OpenVMS Clusters, 16-4  
showing total number of users, 21-43  
with detached tasks, 16-5, 21-54  
with QTI, 16-5

### Contention

location of Audit Trail Logger, 14-7

### Controlled

use with DDU RENAME command, 2-5

### Controlled terminal

enabling Autologin for, 2-4  
with /AUTOLOGIN qualifier, 2-15  
with /CONTROLLED qualifier, 2-7

### CONTROLLED\_TERMINAL\_CNT

variable required for ACMSPARAM.COM, 10-16t

### COPY

command  
AAU, 4-5, 19-5  
DDU, 2-3, 17-5  
UDU, 3-3, 18-9

### COUNT

HP DECtrace report statistic, 15-21

### CP

See Command Process

### CPU

resource utilization item with HP DECtrace, 15-6t

### CPU usage, 14-4

estimating requirements, 14-6

### CP\_PRIORITY

ACMSGEN parameter not calculated by  
ACMSPARAM.COM, 10-13  
ACMS system parameter, 11-11

CP\_PROC\_CNT  
 variable required for ACMSPARAM.COM,  
 10-16t  
 variable value not set by INITIAL or  
 FEEDBACK mode, 10-14

CP\_SLOTS  
 ACMS system parameter, 11-11

CP\_USERNAME  
 ACMS system parameter, 11-11  
 variable required for ACMSPARAM.COM,  
 10-16t  
 variable value not set by INITIAL or  
 FEEDBACK mode, 10-14

CREATE/PROXY command, 6-7, 18-13

CREATE QUEUE  
 command  
 ACMSQUEMGR, 5-4, 20-2

CREATE SELECTION  
 command  
 HP DECtrace, 15-14

Creation interval  
 specifying for server, 9-10

Cross facility items, 15-10  
 collecting in ACMS and Rdb, 15-11  
 generating a report, 15-21

CROSS\_FAC\_14  
 cross facility item with HP DECtrace, 15-10t

CROSS\_FAC\_2  
 cross facility item with HP DECtrace, 15-10t

CROSS\_FAC\_7  
 cross facility item with HP DECtrace, 15-10t

**Ctrl/Y**  
 during system start up, 8-4

Current  
 ACMS system parameters, 11-8  
 type of ACMMSGEN parameter value, 11-3

CURRENT  
 ACMEXCPAR.COM phase parameter, 10-26

CURRENT\_PRIO  
 resource utilization item with HP DECtrace,  
 15-6t

## D

---

Database files  
*See* Databases, files

Databases  
 files  
 source for ACMSPARAM.COM variables,  
 10-8

Data collection  
*See* Event data

Data compression, 7-1  
 algorithm, 7-1  
 DECtrace support, 7-11  
 defining logical names, 7-3  
 disabling, 7-7  
 installation requirements, 7-3

Data compression (cont'd)  
 receiving audit messages, 7-8  
 restricted mode, 7-3, 7-5  
 unrestricted mode, 7-3  
 user-written agent, 7-7, 7-10  
 using workspaces, 7-2

Data compression ratio, 7-2, 15-6

DBMS\_SERVER\_CNT  
 variable value not set by INITIAL or  
 FEEDBACK mode, 10-14

DDU  
*See* Device Definition Utility

DEBUGGER\_CNT  
 variable required for ACMSPARAM.COM,  
 10-17t  
 variable value not set by INITIAL or  
 FEEDBACK mode, 10-15

Debugging procedures  
 BYTLM value required, A-15

DEBUG\_TDB\_BLKs  
 variable required for ACMSPARAM.COM,  
 10-17t

DEC/Test Manager  
 running ACMS from, 2-3t

DECforms, 16-1  
 specifying  
 printfile for, with UDU, 3-8

DECnet  
 distributed processing, 11-12  
 input buffer, 11-12  
 node name, 11-12

DECtrace  
 collection classes  
 RESPONSE, 15-14  
 events  
 APL\_RESPONSE, 15-5  
 COMPRESSED\_MSG, 15-6  
 SUB\_RESPONSE, 15-4, 15-7  
 facilities, 15-10  
 summary report, 15-22  
 with data compression, 7-11

Dedicated service port  
 associating with a LAT service, 2-11  
 compared to application port, 2-7  
 creating, 2-12  
 LAT setup for, 2-10  
 LAT terminal port, 2-8  
 preferred service for, 2-11

Default  
 ACMSPARAM.COM execution mode, 10-3  
 ACMS system parameters, 11-8  
 authorization for applications, 19-8  
 device definition, 2-5  
 events in Audit Trail Logger, 12-3  
 for variables set only by  
 ACMVARINI.DAT, 10-14  
 initial menu, 3-5  
 parameter and quota values, 10-2

## Default (cont'd)

- queue definition file, changing with logical, 5–3
- settings for authorization file, 4–3t
- sign-in characteristics, 17–8
- type of ACMSGEN parameter value, 11–3
- user authorization, 18–14
- values for parameter and quota calculations, 10–2
- variable values for ACMEXCPAR.COM, 10–29

## DEFAULT

- command
  - AAU, 4–3, 19–8
  - DDU, 2–5, 17–8
  - UDU, 3–2, 18–14

## Definitions

- for devices
  - copying, 2–3
  - creating, 2–2
  - default, 2–5
  - modifying, 2–3
- renaming for devices, 2–5

## DELETE ELEMENT

- command
  - ACMSQUEMGR, 5–7, 20–5

## DELETE QUEUE

- command
  - ACMSQUEMGR, 5–5, 20–9

## Deletion interval

- specifying for server, 9–10

## Dequeue

- definition of, 5–4

## Detached tasks

- using concurrent-use licenses, 16–5

## Development kit

- description, 16–1

## Device

- See also* Device definition
- See also* Terminal
- authorization file for, 2–2
- changing login characteristics for, 2–5
- default sign-in characteristics, 2–5
- definition for, 2–1
- displaying information about, 2–6
- enabling Autologin, 2–4
- removing authorization for, 2–5

## Device

- specifying spooled name for, 3–8

## Device definition

- See also* Device Definition Utility
- creating with DDU, 2–2

## Device Definition Utility, 2–1 to 2–16

- ACMS-controlled terminal, 2–7
- ACMSDDF.DAT, 2–3
- \$ALL definition, 2–3t
- authorizing
  - automatic sign-in, 2–15
  - new device, 2–2
  - new terminals, 17–2

## Device Definition Utility (cont'd)

- changing DEFAULT definition, 17–8
  - commands, 17–2 to 17–22
    - ADD, 2–2, 2–7, 2–15, 17–2
    - COPY, 2–3, 17–5
    - DEFAULT, 2–5, 17–8
    - EXIT, 17–10
    - HELP, 17–11
    - LIST, 17–12
    - MODIFY, 2–3, 17–14
    - REMOVE, 2–5
    - RENAME, 2–5, 17–18
    - SHOW, 2–6, 17–21
    - summary of, 2–15t
  - copying
    - definitions, 17–5
    - device definition, 2–3
  - creating device definition, 2–2
  - DEFAULT definition, 2–5
  - device authorization file, 2–1
  - device authorization file location, 2–2
  - displaying device definitions, 2–6
  - enabling automatic sign-ins, 17–2
  - exiting from, 17–10
  - function of, 2–1
  - group
    - authorization, 2–3
    - device names, 2–3t
  - initial sign-in characteristics, 2–2
  - LAT\$SYSTARTUP.COM, 2–10
  - LAT\$SYSTARTUP.TEMPLATE, 2–10
  - LAT terminal, 2–7, 2–9
  - listing authorized devices, 17–12
  - logical device names, 17–2
  - logical to directory for file, 2–2
  - modifying
    - device definition, 2–3, 17–14
  - Printfile characteristic, 2–4
  - prompt, 2–2
  - REMOVE command, 17–17
  - removing device definitions with, 2–5
  - renaming device definition, 2–5
  - requirements for running, 2–2
  - resetting
    - terminal characteristics, 2–1
    - terminals, 21–55
  - running, 2–2
  - sign-in characteristics, 2–1
  - specifying device names, 17–2
- ## DEVICE\_NAME
- ACMS item with HP DECtrace, 15–7t
- ## DIO
- resource utilization item with HP DECtrace, 15–6t
- ## Distributed application
- See also* Distributed forms processing
  - auditing, 12–18 to 12–21
  - connections, 11–12

- Distributed application (cont'd)
  - requirement for ACMS startup, 8–2
  - retranslating application specification, 21–19
  - sample hardware configuration, 14–7f
- Distributed forms processing, 6–1 to 6–22
  - assigning
    - default submitter, 6–7
    - proxy accounts, 6–4
  - authorizing remote access, 6–3
  - automatic operations, 6–13
  - caching
    - on large disk nodes, 6–14
    - with limited disk space, 6–17
  - cluster, 6–2
  - cluster caching, 6–13
  - copying
    - database files, 6–17
    - files, 6–13
  - enabling, 6–1, 6–3, 11–12
  - failover, 6–11
  - logical name translation, 6–11
  - managing HP DECforms escape routines, 6–20
  - search lists, 6–11
  - site-specific, 6–17
  - specification, 6–9
  - subdirectories for, 6–19
  - submitter and application node, 6–2
- Distributed processing
  - See* Distributed forms processing
- Down time
  - avoiding, 21–19
- Dynamic
  - ACMS system parameters, 11–8
  - mode
    - for displaying application information, 9–4, 9–7
  - parameters, changing values with ACMSGEN, 11–4
- DYN\_SP\_CNT
  - variable required for ACMSPARAM.COM, 10–17t

## E

---

- EDIT
  - command
    - SWLUP, 24–3
- Element
  - See* Queued task element
- Element ID
  - for queued task element, 5–6
- END\_TIME
  - ACMS\$START\_MONITOR.COM parameter, 10–10t
- ENTERED\_TERMINAL\_CNT
  - variable required for ACMSPARAM.COM, 10–17t

- Error
  - See* Errors
- Errors
  - application, 12–1 to 12–22
  - logging
    - operator terminal, 21–25
    - with SWL, 13–1
  - messages
    - ACMS, B–1
    - Audit Trail Logger, B–1
    - files, B–1
    - from another product, 12–21, B–1
    - operator terminal, 21–25
  - queues
    - creating with ACMSQUEMGR, 8–10
- ESC\_RTN\_IMAGE\_CNT
  - variable required for ACMSPARAM.COM, 10–17t
- Estimating hardware requirements, 14–4
  - See also* Hardware configuration
  - See also* Performance
- Event
  - See also* Event data
  - for data collection in DECtrace, 15–1
- Event data
  - collecting with DECtrace, 15–1
  - collecting with HP DECtrace, 15–2
  - in a collection class, 15–2
  - scheduling collection of, 15–16
- EXC
  - See* Application Execution Controller
- Exchange steps
  - measured in APL\_RESPONSE event, 15–5
- EXCH\_STEP\_NAME
  - ACMS item with HP DECtrace, 15–7t
- EXC\_ADB\_BLKS
  - variable required for ACMEXCPAR.COM, 10–30t
- EXC\_MSG\_CNT
  - variable required for ACMEXCPAR.COM, 10–30t
- EXC\_RLB\_BLKS
  - variable required for ACMEXCPAR.COM, 10–30t
- EXC\_RLB\_CNT
  - variable required for ACMEXCPAR.COM, 10–31t
- EXC\_SERVER\_CNT
  - variable required for ACMEXCPAR.COM, 10–31t
- EXC\_SP\_CNT
  - variable required for ACMEXCPAR.COM, 10–31t
- EXC\_TDB\_BLKS
  - variable required for ACMEXCPAR.COM, 10–31t



**EXC\_TDB\_CNT**  
 variable required for ACMEXCPAR.COM,  
 10-31t

**EXC\_TK\_INSTANCE\_CT**  
 variable required for ACMEXCPAR.COM,  
 10-31t

**EXC\_USERNAME**  
 variable required for ACMEXCPAR.COM,  
 10-32t

**Execution Controller**  
*See* Application Execution Controller

**Execution modes**  
 INITIAL and FEEDBACK, for  
 ACMSPARAM.COM, 10-3, 10-9  
 static and dynamic, for displaying application  
 information, 9-4

**EXIT**  
 command
 

- AAU, 19-11
- ACMSGEN, 11-3, 22-2
- ACMSQUEMGR, 5-2, 20-10
- ATR Utility, 12-6, 23-2
- DDU, 17-10
- SWLUP Utility, 24-5
- UDU, 18-18

## F

---

**Facilities**, 15-10

**Facility**  
 defined for HP DECtrace, 15-14

**Failover**  
 automatic, 9-12  
 in ACMS distributed forms processing, 6-11  
 with ACMS/REPROCESS command, 9-12

**FEEDBACK**  
 ACMSPARAM.COM execution mode, 10-3,  
 10-5, 10-9

**FINDVAL**  
 phase of ACMEXCPAR.COM, 10-26, 10-28t

**Flagged**  
 events in Audit Trail Logger, 12-3

**Foreign command**  
 ACMSQUEMGR, 5-2  
 ATR, 12-5  
 SWLUP, 13-2

**Forms**  
 specifying language for, 3-6

**FORM\_BLKs**  
 variable required for ACMSPARAM.COM,  
 10-17t

**FORM\_CNT**  
 variable required for ACMEXCPAR.COM,  
 10-32t  
 variable required for ACMSPARAM.COM,  
 10-18t

**FORM\_TRACE\_FILE\_CNT**  
 variable required for ACMSPARAM.COM,  
 10-18t

## G

---

**GBLPAGES**  
 OpenVMS SYSGEN parameter set by  
 ACMSPARAM.COM, 10-6

**GBLPAGFIL**  
 OpenVMS SYSGEN parameter set by  
 ACMSPARAM.COM, 10-6

**GBLSECTIONS**  
 OpenVMS SYSGEN parameter set by  
 ACMSPARAM.COM, 10-6

**GENPAR**  
 ACMEXCPAR.COM phase, 10-28t  
 ACMSPARAM.COM phase, 10-7t  
 phase of ACMEXCPAR.COM, 10-26  
 phase of ACMSPARAM.COM, 10-3, 10-6

**GENVAR**  
 ACMEXCPAR.COM phase, 10-28t  
 ACMSPARAM.COM phase, 10-7t  
 phase of ACMEXCPAR.COM, 10-26  
 phase of ACMSPARAM.COM, 10-3, 10-4

**Global**  
 section
 

- ACMSGEN work area, 22-8
- for ACMS parameters, 11-1
- writing to, 22-13

## H

---

**Hardware configuration**  
 disk usage, 14-4  
 estimating requirements for, 14-4  
 CPU, 14-6  
 disk drives, 14-6  
 memory, 14-4  
 memory usage, 14-4  
 prototyping, 14-4, 14-5, 14-6, 14-7  
 sample configuration, 14-7f

**Help**  
 for AAU, 19-12  
 for ACMEXCPAR.COM, 10-26  
 for ACMSGEN, 11-2, 11-3, 22-3  
 for ACMSPARAM.COM, 10-3  
 for ACMSQUEMGR, 20-11  
 for ATR Utility, 12-5  
 for ATR Utility, 23-3  
 for DDU, 2-2, 17-11  
 for SWLUP, 13-2, 24-6  
 for UDU, 3-2, 18-19

**Help**  
 for ACMSQUEMGR, 5-2

**HELP**  
 ACMEXCPAR.COM phase parameter, 10-26  
 ACMSPARAM.COM phase parameter, 10-3

## HELP (cont'd)

### command

- AAU, 4-2, 19-12
- ACMSGEN, 11-2, 22-3
- ACMSQUEMGR, 5-2, 20-11
- ATR Utility, 12-5, 23-3
- DDU, 17-11
- SWLUP Utility, 24-6
- UDU, 3-2, 18-19

Software Event Log Utility Program command, 13-2

## HOLD

queued task element state, 5-7, 5-9

## HP DEC/Test Manager

monitoring ACMS, 14-3

## HP DECforms, 7-2

caching escape routines, 6-20

### specifying

- language for with UDU, 3-6
- printfile for, with DDU, 2-4

## HP DECtrace

*See also* Oracle Trace

generating a report with cross facility items, 15-21

predecessor to Oracle Trace, xxiii

## I

---

## ID

- submitter, 12-9
- task, 12-9

## IGNORE ERROR

with UDU initial or final task, 3-4

## INITIAL

ACMSPARAM.COM execution mode, 10-3, 10-4, 10-9

## Input

to ACMSPARAM.COM, 10-8 to 10-25

### variables

- required for ACMEXCPAR.COM, 10-30t
- required for ACMSPARAM.COM, 10-15t

## /INPUT

SWLUP qualifier

use of with ACMS\$SWL\_LOG logical, 13-2

## Installation

- of applications, 9-1
- authorizing, 4-1

## INTERVAL

ACMS\$START\_MONITOR.COM parameter, 10-10t

## Item

- cross facility with HP DECtrace, 15-10
- for ACMS, with HP DECtrace, 15-7t
- for data collection in DECtrace, 15-1
- resource utilization, with HP DECtrace, 15-6

## K

---

## Kits, 16-1

- development, 16-1
- remote-access, 16-2
- run-time, 16-2

## L

---

## Languages

specifying for HP DECforms with UDU, 3-6

## LARGEST\_MESSAGE

variable required for ACMSPARAM.COM, 10-18t

## LARGEST\_MESSAGE\_NUM\_WKSP

variable required for ACMSPARAM.COM, 10-18t

## LAT Control Program

and Device Definition Utility, 2-10

## LATTCP

*See* LAT Control Program

## LAT service

associating with a dedicated service port, 2-11

## LAT terminal

- authorizing, 2-3t
- setup for application port, 2-9
- setup for dedicated service port, 2-10

## LAT terminal ports

controlling, 2-8, 2-9

## Layout

specifying language for, with UDU, 3-6

## License Management Facility (LMF), 16-2

## Licenses, 16-1

- capacity, 16-2
- concurrent-use, 16-2
- units, 16-2
- unlimited-use, 16-2

## License units

- in clusters, 16-4
- releasing, 16-6
- rules for allocation, 16-3
- types of task submitters, 16-3

## LIST

### command

- AAU, 4-6, 19-14
- ATR Utility, 12-5, 12-6, 23-4
- DDU, 17-12
- SWLUP, 13-2
- SWLUP Utility, 24-7
- UDU, 3-10, 18-20

## LIST/PROXY

command, 18-22

## LMF

*See* License Management Facility

## LOCAL\_TDMS\_TASK\_CNT

variable required for ACMEXCPAR.COM, 10-32t



LOCKIDTBL  
 OpenVMS SYSGEN parameter set by  
 ACMSPARAM.COM, 10-6

Logical names  
 cache, 6-13  
 for application, 9-2  
 for audit trail log file allocation, 12-2  
 for device, 17-2  
 for directing TDMS hardcopy, 9-18  
 for SWL log file, 13-2  
 for workspace pool sizes, A-24  
 translating, 6-9, 6-11

Login  
 characteristics  
 Autologin, 2-4  
 changing, for a device, 2-3, 2-5

Lookaside list  
 size of, 14-1

## M

---

Magnetic tape  
 Audit Trail Logger storage on, 12-2

MAXIMUM  
 HP DECtrace report statistic, 15-21

MAX\_APPL  
 ACMS system parameter, 11-11

MAX\_LOGINS  
 ACMS system parameter, 11-11

MAX\_TTS\_CP  
 ACMS system parameter, 11-11

MDB\_BLKs  
 variable required for ACMSPARAM.COM,  
 10-18t

MDB\_CNT  
 variable required for ACMSPARAM.COM,  
 10-19t

MEAN  
 HP DECtrace report statistic, 15-21

Memory  
 insufficient, A-19  
 message switch, 11-12  
 monitoring, 14-2  
 swapping, 14-1  
 usage, 14-4  
 estimating requirements, 14-4  
 global pages, 14-5  
 process-private pages, 14-5  
 working set sizes, 14-4  
 workspace, 11-16

Menu  
 ACMS\$EXIT, 3-5  
 assigning, 18-2, 18-4  
 defining  
 initial, 3-5  
 disabling, 3-5, 18-2  
 enabling, 18-2  
 file name, 18-4

Menu (cont'd)  
 NOMENU, 3-6  
 partial, 18-2  
 path names, 18-5  
 redefining, 3-5  
 restricting users, 3-5  
 specifying default, 3-3

Message  
*See* Messages

Messages  
 switch  
 affected by ACMSGEN parameters, 11-2t  
 allocated memory, 11-12  
 internal pool space, 11-12  
 message size, 11-12  
 node name, 11-12  
 parameters  
 displaying, 22-5

MESSAGE\_DEST  
 ACMS item with HP DECtrace, 15-7t

MESSAGE\_SRC  
 ACMS item with HP DECtrace, 15-7t

MINIMUM  
 HP DECtrace report statistic, 15-21

MIN\_CPIS  
 ACMSGEN parameter not calculated by  
 ACMSPARAM.COM, 10-13  
 ACMS system parameter, 11-12

Mode  
*See* Execution mode

MODIFY  
 command  
 AAU, 4-3, 19-16  
 DDU, 2-3, 17-14  
 UDU, 3-7, 3-8, 18-23

MODIFY QUEUE  
 command  
 ACMSQUEMGR, 5-4, 20-13

MODPARAMS.DAT  
 updating with ACMSPARAM.COM, 10-6  
 WRITEPAR phase output file, 10-7t

Monitoring  
*See also* ACMS\$MONITOR.COM  
 ACMS system  
 with ACMS\$MONITOR.COM, 10-11  
 servers with /SERVER\_ATTRIBUTES, 9-10  
 state of ACMS system, 8-4

MSS\_MAXBUF  
 ACMS system parameter, 11-12  
 variable required for ACMSPARAM.COM,  
 10-19t

MSS\_MAXOBJ  
 ACMS system parameter, 11-12  
 variable required for ACMSPARAM.COM,  
 10-19t

MSS\_NET\_RETRY\_TIMER  
ACMSGEN parameter not calculated by  
ACMSPARAM.COM, 10-14  
ACMS system parameter, 11-12  
MSS\_POOLSIZ  
ACMS system parameter, 11-12  
MSS\_PROCESS\_POOL  
ACMS system parameter, 11-12  
variable required for ACMSPARAM.COM,  
10-19t  
MSS\_PROCESS\_POOLSIZ  
ACMS logical name, 11-12  
MSS\_SHARED\_POOL  
variable required for ACMSPARAM.COM,  
10-20t

## N

---

NETPROXY.DAT file, 6-4  
Network traffic, 7-1, 7-5, 15-6  
NETWORK\_TIME  
ACMS item with HP DETrace, 15-7t  
Node  
submitter and application, 6-2  
NODE\_NAME  
ACMSGEN parameter not calculated by  
ACMSPARAM.COM, 10-14  
ACMS system parameter, 11-13  
NOHOLD  
queued task element state, 5-7, 5-9

## O

---

Object  
name  
for application, 9-4  
Online help  
AAU, 19-12  
ACMSGEN, 22-3  
ACMSQUEMGR, 5-2, 20-11  
ATR, 23-3  
DDU, 2-2, 17-11  
SWLUP, 24-6  
UDU, 3-2, 18-19  
OpenVMS  
AUTHORIZE  
and ACMS/START SYSTEM, 8-1  
and User Definition Utility, 3-1  
parameters  
affected by ACMS, 10-6  
set by ACMSPARAM.COM, 10-2  
OpenVMS LAT Control Program  
See LAT Control Program  
OpenVMS OPER privilege, 21-53  
OpenVMS proxy, 6-4, 6-5  
creating, 6-7  
NETPROXY.DAT file, 6-4

OpenVMS SETPRV  
required for process user names, 8-1  
Operator  
commands, 8-8, 21-1 to 21-61  
ACMS/CANCEL TASK, 9-13, 21-2  
ACMS/CANCEL USER, 8-12, 16-6, 21-5  
ACMS/DEBUG, 21-8  
ACMS/ENTER, 21-10  
ACMS/INSTALL, 9-1, 9-2, 21-11  
ACMS/MODIFY APPLICATION, 9-9,  
9-10, 12-16, 21-13  
ACMS/REPLACE SERVER, 9-11, 12-17,  
21-17  
ACMS/REPROCESS APPLICATION\_SPEC,  
9-12, 21-19  
ACMS/RESET AUDIT, 12-2, 21-21  
ACMS/RESET TERMINALS, 21-22  
ACMS/SET QUEUE, 21-23  
ACMS/SET SYSTEM, 8-8, 21-24  
ACMS/SHOW APPLICATION, 9-4, 9-6,  
21-26  
ACMS/SHOW  
APPLICATION/CONNECTIONS, 16-5  
ACMS/SHOW  
APPLICATION/CONTINUOUS,  
9-7, 9-9, 21-31  
ACMS/SHOW QTI, 8-9, 21-33  
ACMS/SHOW QUEUE, 8-11, 21-34  
ACMS/SHOW SERVER, 21-35  
ACMS/SHOW SYSTEM, 8-4, 8-6, 16-5,  
21-37  
ACMS/SHOW TASK, 8-7, 9-13, 9-17,  
9-18, 21-39  
ACMS/SHOW USER, 8-13, 16-5, 16-6,  
21-41  
ACMS/START APPLICATION, 9-3, 21-46  
ACMS/START QTI, 8-9, 21-48  
ACMS/START QUEUE, 8-10, 21-49  
ACMS/START SYSTEM, 8-1, 8-3, 21-51  
ACMS/START TERMINALS, 8-7, 21-55  
ACMS/STOP APPLICATION, 9-3, 9-4,  
9-12, 16-6, 21-56  
ACMS/STOP QTI, 8-9, 21-58  
ACMS/STOP QUEUE, 8-11, 21-59  
ACMS/STOP SYSTEM, 8-3, 8-5, 9-12,  
21-60  
ACMS/STOP TERMINALS, 8-7, 21-61  
and ACMS startup, 8-2  
summary of, 8-14t  
terminal, 8-7  
disabling, 8-8, 21-24  
enabling, 8-8, 21-24  
error logging, 21-25  
error message, B-1  
resetting, 21-22  
OPERATOR\_CNT  
variable required for ACMSPARAM.COM,  
10-20t

OPERATOR\_CNT (cont'd)  
 variable value not set by INITIAL or  
 FEEDBACK mode, 10-15  
 OPER privilege, 16-6, 21-42  
 OPR\_ENTER\_RETURN\_CNT  
 variable required for ACMSPARAM.COM,  
 10-20t  
 Oracle Trace  
*See also* HP DECtrace  
 successor to HP DECtrace, xxiii  
 ORIGINAL\_SIZE  
 ACMS item with HP DECtrace, 15-7t

## P

PAGEFAULTS  
 resource utilization item with HP DECtrace,  
 15-6t  
 PAGEFAULT\_IO  
 resource utilization item with HP DECtrace,  
 15-6t  
 Parameters  
 ACMS Central Controller, 22-5  
 ACMSGEN, not set by ACMSPARAM.COM,  
 10-13  
 ACMSPAR.ACM, 22-15  
 active values, 22-8  
 Application Execution Controller, 22-5  
 calculating, 10-33  
 categories of, 11-9t  
 changing, 1-3, 22-4  
   active values, 11-4  
   current values, 11-3  
   value of with ACMSGEN, 11-1 to 11-17  
 characteristics displayed by ACMSGEN Utility  
 SHOW command, 11-8  
 Command Process, 22-5  
 copying default values, 11-6  
 creating work file, 22-12  
 current values, 22-10  
   changing, 22-15  
 default values, 22-11  
 determining  
   optimal setting, 14-2  
 displaying, 11-7, 22-5  
 dynamic, 11-15  
   values, changing, 22-13  
 for ACMEXCPAR.COM phases, 10-26  
 for ACMS, description of, 11-11  
 for ACMSPARAM.COM phases, 10-3  
 for Terminal Subsystem Controller, 11-8  
 global section, 22-13  
 message switch, 22-5  
 OpenVMS affecting ACMS, A-2  
 OpenVMS and ACMS, determining, 10-1  
 process user names, A-4  
 Queued Task Initiator, 22-5

Parameters (cont'd)  
 required for ACMS\$START\_MONITOR.COM,  
 10-10  
 resetting, 11-4  
 restrictions for changing, 22-6  
 saving active values, 11-6  
 setting with ACMSPARAM.COM, 10-2 to  
 10-25  
 SYSGEN, A-2  
 system file, 11-1  
 task debugger, 10-6  
 Terminal Subsystem Controller, 22-6  
 type of values for in ACMSGEN, 11-3  
 types of, 11-9  
 updating, 11-4  
 value range, 11-15  
 values, 11-15t  
 work file, 11-5, 22-7  
 PARENT\_TASK  
 ACMS item with HP DECtrace, 15-7t  
 95\_PERCENTIL  
 HP DECtrace report statistic, 15-21  
 Performance  
*See also* Event data  
 ACMS processes affecting, 14-3  
 adjusting parameters with ACMSGEN, 11-1  
 benefits of ACMS, 14-6  
 Command Process, 14-8  
 EXC processes, 14-9  
 hardware requirements, 14-4  
 message service, 11-12  
 minimizing the number of ACMS processes,  
 14-4  
 monitoring tools, 14-2 to 14-3  
 parameters and quotas affecting, 10-1  
 server processes, 14-9  
 system resources  
   establishing goals for usage, 14-4  
   hardware requirements, 14-4  
 TSC process, 11-13  
 tuning, 14-1 to 14-13  
   checklist, 14-13  
 PERFORMANCE  
 collection class for ACMS using DECtrace,  
 15-13  
 PERM\_CPS  
 ACMSGEN parameter not calculated by  
 ACMSPARAM.COM, 10-13  
 ACMS system parameter, 11-13  
 Phases  
 of ACMEXCPAR.COM, 10-26, 10-27t  
 of ACMSPARAM.COM, 10-3  
 parameters for, ACMEXCPAR.COM, 10-26  
 parameters for, ACMSPARAM.COM, 10-3  
 Point event, 15-6  
 POOL\_THRESHOLD  
 ACMS\$START\_MONITOR.COM parameter,  
 10-11t

PQL\_DASTLM  
 OpenVMS SYSGEN parameter set by  
 ACMSPARAM.COM, 10-6

PQL\_DBIOLM  
 OpenVMS SYSGEN parameter set by  
 ACMSPARAM.COM, 10-6

PQL\_DDIOLM  
 OpenVMS SYSGEN parameter set by  
 ACMSPARAM.COM, 10-6

PQL\_DWSEXTENT  
 OpenVMS SYSGEN parameter set by  
 ACMSPARAM.COM, 10-6

PQL\_DWSQUOTA  
 OpenVMS SYSGEN parameter set by  
 ACMSPARAM.COM, 10-6

Preferred service  
 for dedicated service port, 2-11

Presentation services, 16-1

Printfile  
*See* Device Definition Utility  
*See* User Definition Utility

Priority  
 queued task element, 5-7, 20-17

Privileges  
 assigning to SYSUAF.DAT with  
 ACMSPARAM.COM, 10-2  
 required  
 for ACMS\$START\_MONITOR.COM, 10-9  
 for Audit Trail Logger, 12-1  
 for changing current ACMSGEN  
 parameters, 11-3  
 for running ACMEXCPAR.COM, 10-26  
 for running ACMSPARAM.COM, 10-2  
 for task queue, 5-4  
 to run ACMSGEN, 11-2

PROCEDURE\_INDEX  
 ACMS item with HP DECtrace, 15-7t

PROCEDURE\_NAME  
 ACMS item with HP DECtrace, 15-7t

Process  
 configuring  
 EXC, 14-9  
 servers, 14-9  
 dumps  
 enabling for server, 9-10  
 minimizing the number of, 14-4  
 OpenVMS user name quotas, A-4  
 PID  
 application, 9-5  
 privileges for user names of, 8-1  
 quotas  
 modifying, 10-32  
 setting quotas for, 10-1  
 stopping, 21-47

PROCESSING\_TIME  
 ACMS item with HP DECtrace, 15-7t

PROC\_STEP\_TYPE  
 ACMS item with HP DECtrace, 15-7t

Prototyping  
 CPU usage, 14-6  
 data access, 14-6  
 disk access, 14-7  
 hardware estimates, 14-4  
 memory usage, 14-5

Proxy  
 OpenVMS, 6-4  
 Proxy account, 6-4

## Q

---

QTI  
*See* Queued Task Initiator

QTI\_MAX\_WSP\_SIZE  
 variable required for ACMSPARAM.COM,  
 10-20t

QTI\_POLLING\_TIMER  
 ACMSGEN parameter not calculated by  
 ACMSPARAM.COM, 10-14  
 ACMS system parameter, 11-13

QTI\_PRIORITY  
 ACMSGEN parameter not calculated by  
 ACMSPARAM.COM, 10-13  
 ACMS system parameter, 11-13

QTI\_QUEUES  
 user-prompted variable in INITIAL mode, 10-5  
 variable required for ACMSPARAM.COM,  
 10-20t

QTI\_RETRY\_TIMER  
 ACMSGEN parameter not calculated by  
 ACMSPARAM.COM, 10-14  
 ACMS system parameter, 11-13

QTI\_SUBMITTERS  
 user-prompted variable in INITIAL mode, 10-5  
 variable required for ACMSPARAM.COM,  
 10-21t

QTI\_SUB\_TIMEOUT  
 ACMSGEN parameter not calculated by  
 ACMSPARAM.COM, 10-14  
 ACMS system parameter, 11-14  
 QTI\_SUB\_TIMEOUT parameter, 16-5

QTI\_TASK\_THDS  
 user-prompted variable in INITIAL mode, 10-5  
 variable required for ACMSPARAM.COM,  
 10-21t

QTI\_USERNAME  
 ACMS system parameter, 11-14  
 variable required for ACMSPARAM.COM,  
 10-21t  
 variable value not set by INITIAL or  
 FEEDBACK mode, 10-15

Queue  
*See* Task queue

## QUEUE

- ACMS\$START\_MONITOR.COM parameter, 10–10t
- Queue definition file
  - creating with ACMSQUEMGR, 5–3
- Queued task element
  - calculating workspace size, 20–3
  - definition, 5–2
  - deleting, 5–7
  - displaying, 5–8, 20–21
  - HOLD state, 5–9
  - ID, 5–2, 5–6, 20–5
  - managing, 5–6
  - modifying, 5–5
  - NOHOLD state, 5–9
  - placing on hold, 20–18
  - priority and state, 5–7
  - processing with QTI, 5–4
  - releasing, 20–18
  - removing from queue, 20–5
  - setting
    - characteristics for, 5–7
      - priority of, 20–17
      - processing characteristics, 20–15
    - state of, 20–18
    - task information, 5–2
    - with /ENQUEUE and /DEQUEUE, 5–4
- Queued Task Initiator
  - ACMSTART.COM, 8–3
  - affected by ACMSGEN parameters, 11–2t
  - agent authorization, A–9
  - and run-time kit, 16–2
  - assigning
    - priority of, 11–13
    - user name of, 11–14
  - auditing, 12–15
  - concurrent-use license with, 16–5
  - dequeue, 5–4
  - dequeuing task, 20–2
  - displaying
    - information about, 8–9, 21–33
  - error queue, 8–10, 21–49
  - inactive submitter, 11–13
  - maximum
    - queued tasks, 8–10, 21–49
  - parameters
    - displaying, 22–5
    - for, 11–10
  - process, 14–3
  - quotas and privileges, A–9
  - retrying task, 11–13
  - run-time characteristics, 21–33
  - starting, 8–9, 21–48, 21–51
    - with ACMS, 8–2, 8–3
  - stopping, 8–9, 21–58
  - user name, A–9
    - quotas, A–4

## Queue Manager Utility

- ACMSQDF.DAT, 5–3
  - command recall, 5–2
  - commands, 20–2 to 20–25
    - CREATE QUEUE, 5–4, 20–2
    - DELETE ELEMENT, 5–7, 20–5
    - DELETE QUEUE, 5–5, 20–9
    - EXIT, 5–2, 20–10
    - HELP, 5–2, 20–11
    - MODIFY QUEUE, 5–4, 20–13
    - SET ELEMENT, 5–7, 20–15
    - SET QUEUE, 5–4, 20–19
    - SHOW ELEMENT, 5–8, 20–21
    - SHOW QUEUE, 5–5, 20–25
    - summary of, 5–10t
  - creating and managing task queues with, 5–1 to 5–11
  - creating queues, 5–4, 20–2
  - Ctrl/B**, 5–2
  - defining maximum task workspace, 20–3
  - deleting
    - elements, 5–7
    - queues, 5–5, 20–9
  - disabling
    - queuing of tasks, 20–2, 20–19
  - displaying
    - elements, 5–8, 20–21
    - queues, 5–5, 20–25
  - exiting from, 20–10
  - foreign command, 5–2
  - function of, 5–1
  - modifying
    - queue characteristics, 20–13
  - naming queue repository file, 20–3
  - online help, 20–11
  - placing elements on hold, 20–18
  - queue
    - listing, 20–25
    - name, 5–4
    - repository file, 5–5
  - queue definition file, 5–1
    - logical name for, 5–3
  - running, 5–2
  - setting
    - element characteristics, 20–15
    - queue characteristics, 5–4
    - queue state, 20–19
- ## Queue repository file
- See* Task queue
- ## Quotas
- ACC user name, A–4
  - ACMS process user name, A–4
  - BASE, A–14
  - calculating, 10–33
  - changing, 1–3
  - CP user name, A–7
  - EXC user name, A–11

## Quotas (cont'd)

- for ACMS processes, determining, 10-1
- for using ADU, A-14
- modifying, 10-32
- QTI user name, A-9
- server process, A-13
- setting for EXC, 10-25 to 10-33
- setting with ACMSPARAM.COM, 10-2 to 10-25
- task debugger, A-15
- TSC user name, A-6
- user name, 10-25

## QUOTA\_THRESHOLD

- ACMS\$START\_MONITOR.COM parameter, 10-11t

## R

---

### Range

- for ACMS system parameters, 11-8

### Rdb TRANSACTION event, 15-10

### RECEIVE\_ID

- ACMS item with HP DECtrace, 15-7t

### Registration ID

- in HP DECtrace, 15-17

### Remote

- sign-in, 12-18 to 12-21
- task submitter, 11-14
- terminal
  - authorizing, 2-3t

### Remote-access kit

- description, 16-2

### REMOTE\_AGENT\_CNT

- variable required for ACMEXCPAR.COM, 10-32t
- variable required for ACMSPARAM.COM, 10-21t
- variable value not set by INITIAL or FEEDBACK mode, 10-15

### REMOTE\_APPL\_CNT

- variable required for ACMSPARAM.COM, 10-21t
- variable set in FEEDBACK mode, 10-5

### REMOTE\_APPL\_NAME

- user-prompted variable in INITIAL mode, 10-4
- variable required for ACMSPARAM.COM, 10-22t

### REMOTE\_NODE\_CNT

- user-prompted variable in INITIAL mode, 10-4
- variable required for ACMSPARAM.COM, 10-22t

### REMOTE\_RLB\_BLKs

- variable required for ACMSPARAM.COM, 10-22t

### REMOTE\_RLB\_CNT

- variable required for ACMSPARAM.COM, 10-22t

### REMOTE\_SUB\_CNT

- user-prompted variable in INITIAL mode, 10-4
- variable required for ACMSPARAM.COM, 10-22t

### REMOTE\_TK\_INSTANCE\_CNT

- variable required for ACMEXCPAR.COM, 10-32t

### REMOVE

- command
  - AAU, 4-6, 19-19
  - DDU, 2-5, 17-17
  - UDU, 3-11, 18-27

### REMOVE/PROXY

- command, 18-28

### RENAME

- command
  - AAU, 4-7, 19-20
  - DDU, 2-5, 17-18
  - UDU, 3-11, 18-30

### RENEW

- command
  - SWLUP Utility, 24-10

### Report

- with ATR Utility, 12-6
- with HP DECtrace, 15-18

### REPORT

- command
  - DECtrace, 15-3, 15-18

### REPORT\_FREQUENCY

- ACMS\$START\_MONITOR.COM parameter, 10-10t

### REPORT\_MAIL\_USERNAME

- ACMS\$START\_MONITOR.COM parameter, 10-10t

### REPORT\_SEND\_TIME

- ACMS\$START\_MONITOR.COM parameter, 10-10t

### Repository file

- containing queued task elements, 5-5
- for task queue
  - file specification for, 5-5

### Request Interface

- and development kit, 16-1

### REQ\_FORM\_NAME

- ACMS item with HP DECtrace, 15-7t

### RESPONSE

- collection class for ACMS using HP DECtrace, 15-14

### RESPONSE class, 15-14

### Restricted mode of data compression, 7-3, 7-5

### Retry limit, 21-53

### Retry wait timer, 21-54

### RIGHTSLIST.DAT

- and login errors, C-2

### RLB\_CNT

- variable required for ACMSPARAM.COM, 10-23t



Run-time  
  processes  
    setting quotas for, 10-1  
Run-time kit  
  description, 16-2

## S

SAVE  
  command  
    SWLUP Utility, 24-11  
SCHEDULE COLLECTION  
  command  
    DECtrace, 15-16  
Search list, 6-9, 9-12  
  and application installation, 9-2  
  in ACMS distributed forms processing, 6-11  
  reprocessing, 21-19  
Security, 6-4  
  escape routine considerations, 6-20  
SELECTION STRING  
  with UDU initial or final task, 3-4  
SEND\_ID  
  ACMS item with HP DECtrace, 15-7t  
Server process  
  *See* Servers, processes  
Servers  
  attributes, 9-10, 21-26  
  auditing, 21-14  
  audit trail record, 9-11  
  creation interval, 21-14  
  deletion interval, 21-14  
  displaying  
    information about, 21-26, 21-35  
  enabling process dumps, 21-14  
  error in, 21-17  
  free, 9-5  
  limiting number of, 9-9  
  maximum processes, 21-13, 21-14, 21-27  
  minimum processes, 21-15  
  modifying  
    attributes of, 9-10, 21-14  
  monitoring, 9-9, 21-13  
  name, 9-5, 21-14  
  optimal process count, 14-1  
  optimization, 14-1  
  processes, 9-5  
    configuring for performance, 14-9  
    displaying active, 14-9  
    dump audit, 12-16  
    function, 14-3  
    memory requirements, 14-5  
    monitoring, 14-2  
    setup, 14-10  
  process quotas and privileges, A-13  
  replacement audit, 12-17  
  replacing image, 9-11, 21-17

Servers (cont'd)  
  stopping  
    image, 9-11  
    process, 21-47  
SERVER\_INDEX  
  ACMS item with HP DECtrace, 15-7t  
SERVER\_NAME  
  ACMS item with HP DECtrace, 15-7t  
Services  
  ACMS\$DEQUEUE\_TASK, 5-7  
  ACMS\$QUEUE\_TASK, 5-2, 5-4, 5-6  
SET  
  command  
    ACMSGEN, 11-4, 11-5, 11-6, 22-4  
SET ELEMENT  
  command  
    ACMSQUEMGR, 5-7, 20-15  
SET KNOWN PROXIES ALL command, 6-7  
SET LOG  
  command  
    SWLUP Utility, 24-12  
SETPRV  
  required for process user names, 8-1  
SET QUEUE  
  command  
    ACMSQUEMGR, 5-4, 20-19  
SET VERIFY  
  command  
    SWLUP Utility, 24-13  
SHOW  
  command  
    AAU, 4-6, 19-23  
    ACMSGEN, 11-2, 11-6, 11-7e, 11-8e,  
      22-5  
    DDU, 2-6, 17-21  
    UDU, 3-10, 18-34  
SHOW/PROXY  
  command, 18-36  
SHOW CURRENT  
  command  
    SWLUP Utility, 24-14  
SHOW ELEMENT  
  command  
    ACMSQUEMGR, 5-8, 20-21  
    obtaining task element ID with, 5-6  
SHOW LOG  
  command  
    SWLUP Utility, 24-15  
SHOW QUEUE  
  command  
    ACMSQUEMGR, 5-5, 20-25  
SHOW VERSION  
  command  
    SWLUP Utility, 24-16  
Sign-in  
  automatic, enabling, 2-15, 17-2  
  characteristics  
    /AUTOLOGIN qualifier, 2-15

Sign-in

- characteristics (cont'd)
  - changing, with DDU, 2-2, 17-8
  - default, 2-5
  - default for devices, 2-5
  - defined for user, 3-1
  - displaying, 2-6, 2-7
  - showing, for devices, 2-6
  - types of, 2-1
- controlling with TSC, 8-7
- defining
  - menu, 18-4, 18-5
  - terminal characteristics for, 2-1
- disabling, 8-7, 21-61
- disabling menu, 18-2
- initial task, 18-4
- remote, 12-18 to 12-21
- requirements for, C-1
- specifying maximum, A-15
- tracking, 12-18 to 12-21

Sign-out

- final task, 18-3

SKIPMENULANGUAGE

- User Definition Utility characteristic, 3-7

Software Event Logger

- log file, 13-1
- starting, 13-1
- stopping detached process, 24-17

Software Event Log Utility Program

- commands, 24-2 to 24-17
  - @ (At-Sign), 24-2
  - EDIT, 24-3
  - EXIT, 24-5
  - HELP, 13-2, 24-6
  - LIST, 13-2, 24-7
  - RENEW, 24-10
  - SAVE, 24-11
  - SET [NO]LOG, 24-12
  - SET [NO]VERIFY, 24-13
  - SHOW CURRENT, 24-14
  - SHOW LOG, 24-15
  - SHOW VERSION, 24-16
  - STOP, 24-17
- creating reports with, 13-1
- exiting from, 24-5
- foreign command, 13-2
- listing error information, 13-2
- online help, 24-6
- running, 13-2
- summary of commands, 13-3t

Software Performance Monitor

- monitoring page faults in EXC, 14-9

Software Problem Report

- for ACMS internal error, 13-2

Spooled device name

- specifying for user, 3-8

SPR

- See* Software Problem Report

STANDARD\_DEVIATION

- HP DECtrace report statistic, 15-21

Starting

- ACMS system
  - automatically, 8-2
  - options for, 8-2

STARTNET.COM, 8-2

START\_TIME

- ACMS\$START\_MONITOR.COM parameter, 10-10t

State

- of task, 9-14
- setting
  - for queued task element, 5-7, 5-9

Static mode

- for displaying application information, 9-4

Statistics

- generated by HP DECtrace report, 15-21
- reported by ACMS\$MONITOR.COM, 10-11

STEP\_NAME

- ACMS item with HP DECtrace, 15-7t

STOP

- command
  - SWLUP Utility, 24-17

Subdirectory

- in distributed forms processing, 6-19

Submitter

- default account, 6-7
- displaying information about, 21-42
- ID, 9-14, 12-9, 21-39
- node, 6-2
- sign out period, 16-5
- task, 16-3

SUB\_RESPONSE event, 15-4, 15-7

SUB\_USERNAME

- ACMS item with HP DECtrace, 15-7t

SWL

- See* Software Event Logger

SWL.LOG

- Software Event Logger log file, 13-1

SWLUP

- See* Software Event Log Utility Program

SYSGEN parameters

- See* OpenVMS, parameters

SYSHUTDOWN.COM, 8-3, 21-60

SYSPRV

- privilege
  - required for ACMS/START TASK command, 21-53
  - required to run ACMEXCPAR.COM, 10-26
  - required to run ACMSPARAM.COM, 10-2

SYSTARTUP\_VMS.COM

- editing, 8-2



System  
    *See* ACMS system  
Systems Interface  
    SI\_AGENT, 3–9  
SYSUAF.DAT  
    accounts and privileges in, with  
        ACMSPARAM.COM, 10–2  
    ACMEXCPAR.COM output file, 10–28  
    and login errors, C–1  
    modifying, 10–25  
    verification required, 3–1  
    WRITEPAR phase output file, 10–7t

## T

---

Task Debugger  
    parameters, 10–6, A–3t  
    quotas, A–15  
Task element  
    *See* Queued task element  
Task groups  
    workspace pool, 11–16  
Task queue  
    ACMSQDF.DAT, 5–1  
    characteristics, 20–13  
    creating, 5–4, 20–2  
    defining  
        characteristics, 20–2  
    definition file, 5–1, 5–3  
    deleting, 5–5, 20–9  
        task elements, 5–7  
    disabling  
        tasks, 20–2, 20–19  
    displaying, 20–25  
        information about, 5–5, 8–11, 21–34  
    error queues, 8–10, 21–49  
    file specification, 5–4  
    listing file, 20–25  
    managing, 5–3  
    maximum  
        concurrent tasks, 8–10, 21–23, 21–49  
        task workspace size, 20–3  
    modifying characteristics of, 5–4, 20–13  
    naming repository file for, 20–3  
    privileges required for, 5–4  
    Queued Task Initiator, 21–48  
    queue repository file and cancelled queued task  
        elements, 8–11  
    repository file  
        containing queued task elements, 5–5  
        file specification for, 5–5  
    setting  
        characteristics of, 5–4, 21–23  
        state of, 20–19  
    started, 21–23  
    starting, 8–10, 21–49  
    stopping, 8–11, 21–59  
Task queue (cont'd)  
    suspending, 5–4  
    suspending tasks, 20–2  
Tasks  
    *See also* Queued task element  
    *See also* Task queue  
    attributes, 21–27  
    audit log, 12–11  
    called, 9–14, 12–9  
    canceling, 9–3, 9–12, 21–2  
    chained, 15–3, 15–5, 15–6  
    concurrent queued, 8–10  
    current active, 9–5  
    defining  
        initial menu of, 3–5  
    device name, 21–39  
    displaying  
        called, 21–39  
        information about, 9–14, 21–27, 21–39  
        initial or final, 3–5  
    enabling auditing, 21–15  
    final, 3–4, 18–3  
        automatic running of, 3–1, 3–4  
    ID, 9–14, 12–9, 21–39  
    initial, 3–4, 18–4  
        automatic running of, 3–1, 3–4  
    maximum  
        instances, 9–5, 21–13  
        queued, 21–23  
    modifying  
        active attributes, 9–10  
        attributes of, 21–15  
    name, 21–15  
    operator terminal, 21–25  
    queue definition file for  
        creating, 5–3  
    replacing server image, 21–17  
    server  
        name, 9–5  
        process, 9–5  
        processes, 9–5  
    specifying  
        parameter for initial or final, 3–4  
    stopping, 9–3  
    temporary workspace, 11–14  
TASK\_NAME  
    ACMS item with HP DECtrace, 15–7t  
TDB\_BLKs  
    variable required for ACMSPARAM.COM,  
        10–23t  
TDB\_CNT  
    variable required for ACMSPARAM.COM,  
        10–23t  
TDMS, 7–2, 15–5, 16–1  
    using ACMS\$TSS\_HARDCOPY logical name,  
        9–18

## Terminal

*See also* Device Definition Utility

*See also* Operator terminal

*See also* Terminal Subsystem Controller

accessing ACMS from, 21–10

ACMS-controlled, 2–1, 2–15, 17–2

authorizing, 2–1 to 2–16  
new, 2–2

automatic sign-in, 2–15

changing login characteristics for, 2–5

controlled

and ACMS startup, 8–3

controlling, 2–9 to 2–15, 8–7

default sign-in characteristics, 2–5, 17–8

defining characteristics of, 17–9

displaying information about, 2–6

enabling automatic sign-in, 2–1, 17–2

error message, B–1

group

device names, 2–3t

LAT, 2–3t, 2–10

listing authorized and characteristics, 17–12

local, 2–3t

maximum number allowed, 11–11

modifying

characteristics of, 17–14

operator commands

and ACMS startup, 8–2

port, 2–10

pseudo, 2–3t

remote, 2–3t

removing authorization for, 2–5

resetting, 21–22

sign-in characteristics, 2–1

Subsystem Controller

starting, 21–55

tasks running at, 21–39

virtual, 2–3t

## Terminal Subsystem Controller

affected by ACMSPARAM parameters, 11–2t

and device authorization, 2–1

assigning

priority of, 11–13

user name to, 11–14

operator terminal, 8–7

parameters

displaying, 11–8, 22–6

for, 11–10

quotas and privileges, A–6

starting, 8–7, 21–51

starting interactively, 8–3

stopping, 8–4, 8–7, 21–61

user name, A–6

quotas, A–4

## TERMINALS\_PER\_CP

variable required for ACMSPARAM.COM,

10–24t

## TERMINAL\_CNT

user-prompted variable in INITIAL mode, 10–4

variable required for ACMSPARAM.COM,  
10–23t

## TERMINAL\_PER\_CP

user-prompted variable in INITIAL mode, 10–5

## Throughput

CPU requirements, 14–6

disk I/O, 14–6

estimating disk requirements, 14–7

## TOTAL

HP DECtrace report statistic, 15–21

## TOTAL\_SP\_CNT

variable required for ACMSPARAM.COM,  
10–24t

## TOTAL\_TK\_INSTANCE\_CNT

variable required for ACMSPARAM.COM,  
10–24t

## TP Desktop Connector, 16–3

## TRANSACTION event

in Rdb, 15–10

## TSC

*See* Terminal Subsystem Controller

## TSC\_PRIORITY

ACMSGEN parameter not calculated by  
ACMSPARAM.COM, 10–13

ACMS system parameter, 11–14

## TSC\_USERNAME

ACMS system parameter, 11–14

variable required for ACMSPARAM.COM,  
10–24t

variable value not set by INITIAL or  
FEEDBACK mode, 10–15

## Tuning

application, 9–4

Application Execution Controller, 14–9

checklist, 14–13

Command Process, 14–8

server processes, 14–9

## TWSC\_POOLSIZE

ACMS system parameter, 11–14

variable required for ACMSPARAM.COM,  
10–25t

## TWS\_POOLSIZE

ACMS system parameter, 11–14

variable required for ACMSPARAM.COM,  
10–24t

## TXN\_ID

ACMS item with HP DECtrace, 15–7t

## TXN\_STATUS

ACMS item with HP DECtrace, 15–7t

## U

### UDU

*See* User Definition Utility

Units, license, 16–2

Unlimited-use license, 16–1, 16–2

Unrestricted mode of data compression, 7–3, 7–4

### USE

command

ACMSGEN, 11–4, 22–7

### USE ACTIVE

command

ACMSGEN, 11–4, 11–5, 22–8

### USE CURRENT

command

ACMSGEN, 11–5, 22–10

### USE DEFAULT

command

ACMSGEN, 11–4, 11–5, 11–6, 22–11

### User, 16–3

*See also* User names

assigning menu to, 18–4

authorizing, 3–1 to 3–13, 18–2, C–1

as agent, 3–9, 18–2

canceling, 8–12, 21–5

task owned by, 21–2

connected to application, 16–5

deauthorizing, 3–11, 18–27

defining

final task, 3–4

initial task, 3–4

device name, 21–41

disabling menu, 18–2

displaying

authorization for, 18–20

authorized, 3–10

information about, 8–13

tasks, 8–13

tasks owned by, 21–40

displaying information about, 21–26

final task, 18–3

ID, 8–13, 21–39

initial task, 18–4

limiting number of, 11–11

local and remote, 16–6, 21–37, 21–41

new, authorizing, 3–2

proxy choices, 6–5

restricting menu access, 3–5

sign-in, C–1

delays, 11–11

display, 18–7

submitter ID, 21–42

### User definition file

and login errors, C–1

default characteristics, 18–16

logical name for, 3–1

user authorization file, 3–1

User Definition Utility, 3–1 to 3–13

ACMSDDDF.DAT

and login errors, C–1

ACMSUDEF.DAT, 3–1

default characteristics, 18–16

logical name for, 3–1

user authorization file, 3–1

adding new authorizations, 3–2, 3–3, 18–2

\$ALL authorization, 3–3, 18–5

assigning menu database, 18–2

authorization file, 3–1

authorizing

agents, 3–9, 18–2

Command Process, 3–9, 18–5

commands, 18–2 to 18–37

ADD, 3–2, 18–2

ADD/PROXY, 18–7

COPY, 3–3, 18–7

CREATE/PROXY, 18–13

DEFAULT, 18–14

EXIT, 18–18

HELP, 3–2, 18–19

keypad, 3–2

LIST, 3–10, 18–20

LIST/PROXY, 18–22

MODIFY, 18–23

recall, 3–2

REMOVE, 3–11

REMOVE/PROXY, 18–28

RENAME, 3–11, 18–30

SHOW, 3–10, 18–34

SHOW/PROXY, 18–36

summary of, 3–11t

UDU, 18–18

copying authorizations, 3–3, 18–7

dealing with ACMS proxy file, 6–5

default authorization, 3–2, 18–14

defining initial menu, 3–5

disabling menu, 3–5, 18–2

displaying

authorizations, 3–10, 18–34

final tasks, 3–4

initial tasks, 3–4

enabling menu, 18–2

exiting from, 3–2, 18–18

final task, 18–3

function of, 3–1

initial

authorization, 18–16

task, 18–4

listing

authorizations, 3–10, 18–20

file, 18–20

modifying authorizations, 3–3, 18–23

Printfile characteristic, 3–8

redefining menu, 3–6

removing authorizations, 3–11

renaming authorizations, 3–11, 18–30

## User Definition Utility (cont'd)

- restricting menus, 3–5
- running, 3–1
- specifying
  - final task, 3–4
  - initial task, 3–4
- specifying Printfile for DECforms, 3–8
- updating authorizations, 3–10

## User Identification Codes

- for applications, 9–2

## User names

- authorizing for access to ACMS, 3–1
- privileges required before starting ACMS, 8–1

## USERNAME\_DEFAULT

- ACMSGEN parameter not calculated by ACMSPARAM.COM, 10–14
- ACMS system parameter, 11–15

## V

---

### Variables

- input to ACMSPARAM.COM, 10–8 to 10–25
- values, creation of
  - by FEEDBACK to ACMSPARAM.COM, 10–5
  - by user input to ACMSPARAM.COM, 10–4
- values, for ACMEXCPAR.COM, 10–29
- values for parameter and quota calculations, 10–2
- values not set by INITIAL or FEEDBACK mode, 10–14
- values required for ACMEXCPAR.COM, 10–30t
- values required for ACMSPARAM.COM, 10–15t

## VIRTUALPAGECNT

- OpenVMS SYSGEN parameter set by ACMSPARAM.COM, 10–6

## VIRTUAL\_SIZE

- resource utilization item with HP DECtrace, 15–6t

## W

---

### Wildcard

- for deleting task elements, 5–7
- instead of task element ID, 5–7
- specifying in Application Authorization Utility, 4–6
- specifying in User Definition Utility, 3–10

## WORK.ACM, 11–6

### Work area

- ACMSGEN, 11–1
- ACMSPAR.ACM, 22–15
- active values, 22–8
- changes to, 22–2
- creating work file, 22–12
- current values, 22–10
- default values, 22–11

### Work area (cont'd)

- displaying, 22–5
- global section, 22–13
- initializing, 22–7, 22–8

### Work file

- creating, 22–7, 22–12
- type of ACMSGEN parameter value, 11–3
- using, 22–7
- using with ACMSGEN, 11–4
- WORK.ACM, 11–6
- writing to with ACMSGEN, 11–5

### Working set

- size for Command Process, 14–8, A–8
- size for EXC, 14–9

### Workload

- distribution across nodes, 9–12

### Workspace pool

- See also* Workspaces
- ACMS system, 8–6
- affected by ACMSGEN parameters, 11–2t
- application allocation, 11–15
- displaying information, 9–6
- limitations of, 11–16
- parameters
  - for, 11–10
- queue, 20–3
- size, 11–14
- task, 11–14
- types of, 9–6, 11–16

### Workspaces

- ACMS\$SELECTION\_STRING, 21–53
- effect on CPU usage, 14–6
- in data compression, 7–2
- maximum size, for task queue, 20–3
- pool

*See* Workspace pool

- pool size, 21–8, 21–38

### WRITE

- command
  - ACMSGEN, 22–12

### WRITE ACTIVE

- command
  - ACMSGEN, 11–5, 22–13

### WRITE CURRENT

- command
  - ACMSGEN, 11–4, 22–15

### WRITEPAR

- ACMEXCPAR.COM phase, 10–28t
- ACMSPARAM.COM phase, 10–7t
- phase of ACMEXCPAR.COM, 10–26, 10–28t
- phase of ACMSPARAM.COM, 10–3, 10–6

### WSC\_POOLSIZ

- ACMS system parameter, 11–15
- variable required for ACMSPARAM.COM, 10–25t

WS\_GLOBAL  
resource utilization item with HP DECtrace,  
15-6t

WS\_POOLSIZE  
ACMS system parameter, 11-15  
variable required for ACMSPARAM.COM,  
10-25t

WS\_PRIVATE  
resource utilization item with HP DECtrace,  
15-6t

WS\_SIZE  
resource utilization item with HP DECtrace,  
15-6t

