













Internal Options:

-  **201098- B21**
2nd CPU
-  **201692- B21**
-  **201693- B21**
-  **201694- B21**
-  **201695- B21**
-  **225011- 021**
2dn power
-  **225012- B21**
Fan ki t
-  **142673- B22**
10k
-  **188122- B22**
15k
-  **176496- B22**
10k
-  **232432- B22**
10k
-  **216886- B21**
-  **157866- 021**
Lights out mgr
33MHz
-  **158575- B21**
NC7131 Gigabit
64- bit/66MHz
-  **158939- B21**
Smart Array 5304/128
64- Bit/66MHz
-  **176479- B21**
FibreChannel adapter
64- bit/33MHz

To Fibre Channel Storage

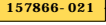
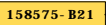
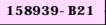
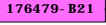
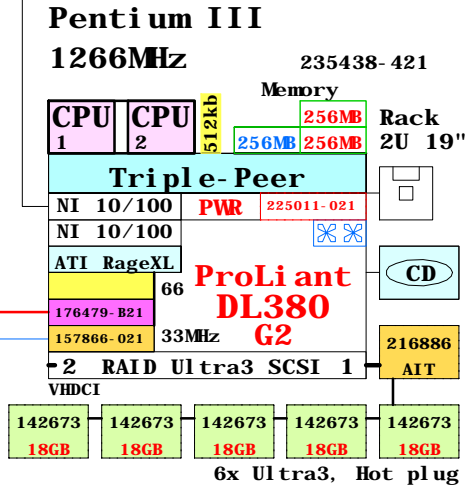

- 2x RJ- 45
- ATI Rage XL 8MB
- 64bit/66MHz Hot Plug
- 64bit/66MHz Hot Plug
- 64bit/33MHz Non HP

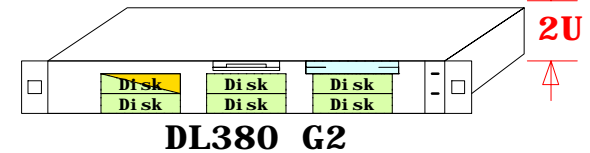
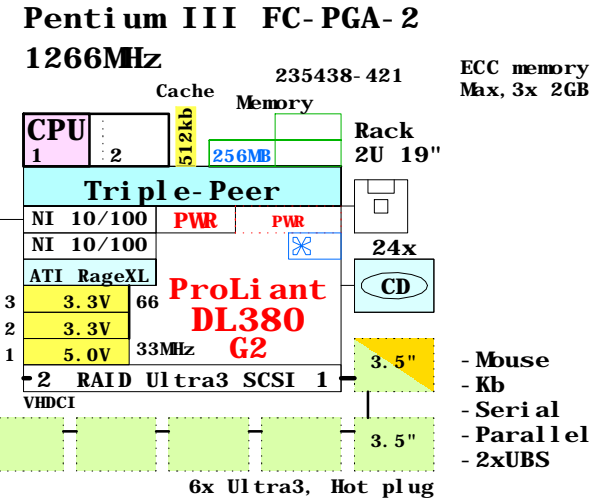

BOM of the system above

	Part Number	Qty	Description
1	235438- 421	1	ProLiant DL380 G2 1266MHz 256MB rack 2U
1. 1	142673- B22	5	18.2GB 10000r Ultra3 SCSI disk 1"
1. 2	157866- 021	1	CPQ Remote Insight manager kit
1. 3	176479- B21	1	Host Buss Cntrl KGPSA- CB, NT only
1. 4	201098- B21	1	Pentium III P1266- 512kb processor kit
1. 5	201692- B21	2	256MB 133MHz ECC SDRAM (2x128MB)
1. 6	216886- B21	1	35/70GB Hot plug AIT tape drive
1. 7	225011- 021	1	DL380R02 second power supply
1. 8	225012- B21	1	Hot plug blower option kit, 3x fans

www.Compaq.com/golden-eggs

Si nce: Oct- 2001

COMPAQ

12- Nov- 2001

GEI DL380a

Matti. Patari@compaq.com

ProLiant DL380 G2 system
GOLDEN EGGS Visuals, Helsinki

DL380 2P

Compaq ProLiant DL380 G2

Pentium III
1266MHz
235438-421

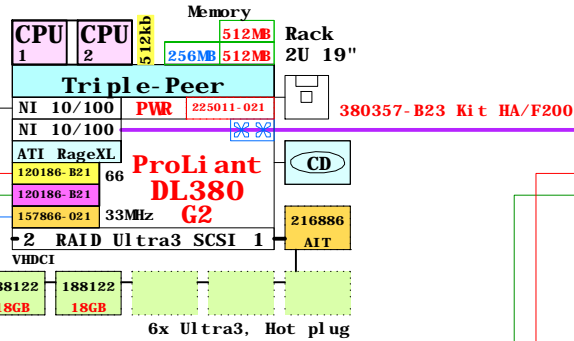

Pentium III
1266MHz
235438-421

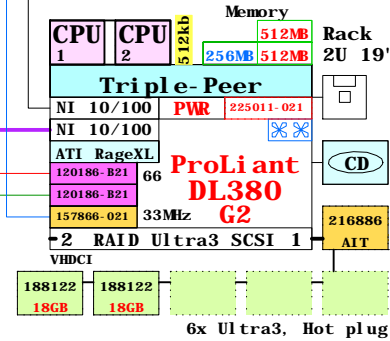

213076-B21 Secure Path W2k
Needed for each node
if NOT clustered.

136127-B21 Rack kit for Hub7

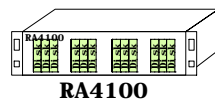
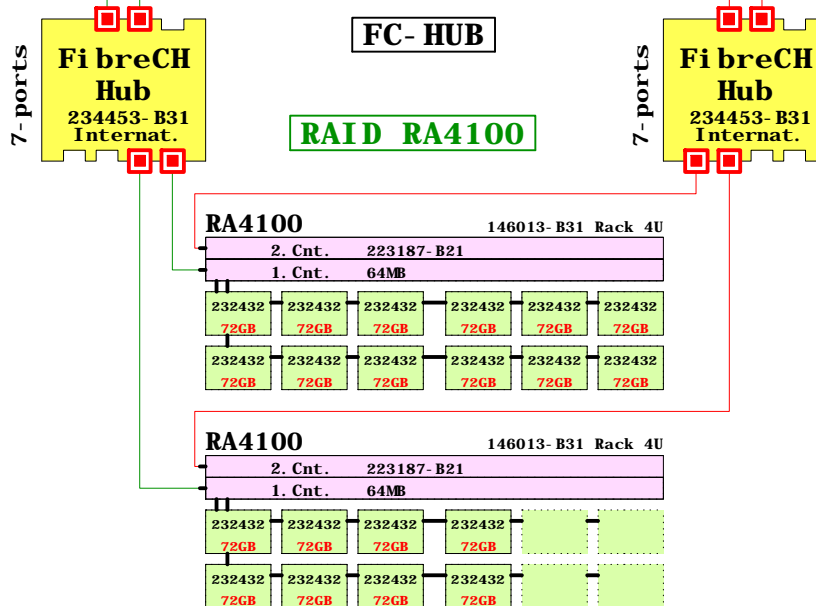

BOM of this Cluster

	Part Number	Qty	Description
	235438-421	1	ProLiant DL380 G2 1266MHz 256MB rack 2U
1	120186-B21	2	FC Host Adapter kit PCI 64bit/66MHz
1.1	157866-021	1	CPQ Remote Insight manager kit
1.2	188122-B22	2	18.2GB 15000r Ultra3 SCSI disk 1"
1.3	201098-B21	1	Pentium III P1266-512kb processor kit
1.4	201098-B21	1	Pentium III P1266-512kb processor kit
1.5	201693-B21	2	512MB 133MHz ECC SDRAM (2x256MB)
1.6	216886-B21	1	35/70GB Hot plug AIT tape drive
1.7	225011-021	1	DL380R02 second power supply
1.8	225012-B21	1	Hot plug blower option kit, 3x fans
2	235438-421	1	ProLiant DL380 G2 1266MHz 256MB rack 2U
2.1	120186-B21	2	FC Host Adapter kit PCI 64bit/66MHz
2.2	157866-021	1	CPQ Remote Insight manager kit
2.3	188122-B22	2	18.2GB 15000r Ultra3 SCSI disk 1"
2.4	201098-B21	1	Pentium III P1266-512kb processor kit
2.5	201693-B21	2	512MB 133MHz ECC SDRAM (2x256MB)
2.6	216886-B21	1	35/70GB Hot plug AIT tape drive
2.7	225011-021	1	DL380R02 second power supply
2.8	225012-B21	1	Hot plug blower option kit, 3x fans
3	146013-B31	1	RAID Array 4100 64MB Rack 4U
3.1	223187-B21	1	RA4000 Redundant Controller
3.2	232432-B22	12	72.8GB 10000r Ultra3 SCSI disk 1"
4	146013-B31	1	RAID Array 4100 64MB Rack 4U
4.1	223187-B21	1	RA4000 Redundant Controller
4.2	232432-B22	8	72.8GB 10000r Ultra3 SCSI disk 1"
5	234453-B31	2	Fibre Channel Hub 7 Ports International
6	136127-B21	1	Rack mount kit for Hub 7, universal
7	380357-B23	1	ProLiant HA/F200 Cluster kit NT/W2k

www.Compaq.com/golden-eggs

Since: Oct-2001

COMPAQ

12-Nov-2001 GTIDL380b1
Matti.Patari@Compaq.com

ProLiant DL380 G2 FC-Hb/RA4100
GOLDEN EGGS Visuals, Helsinki

DL380 2P

Compaq ProLiant DL380 G2

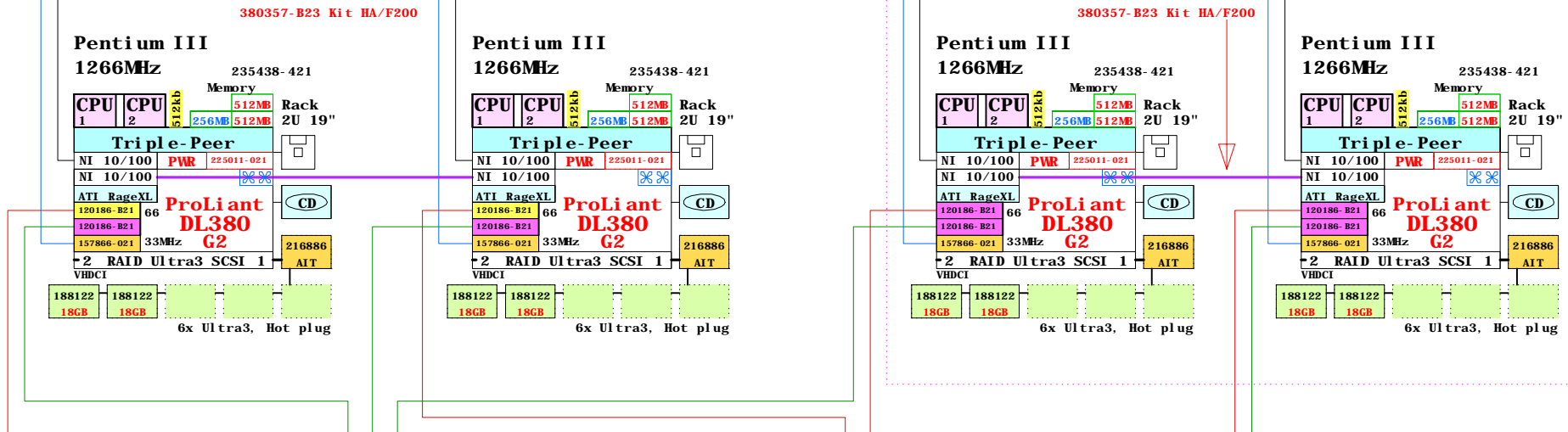
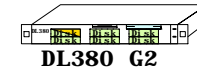

167365-B21 Rack kit for SANsw

167365-B21 Rack kit for SANsw

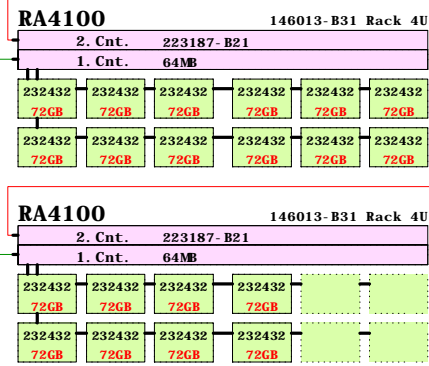
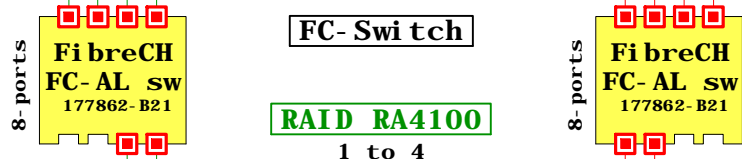

Note:
Each RA4100 is reserved for a Cluster of its own, for two hosts.

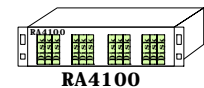

BOM, one pair of DL380s/Cluster

	Part Number	Qty	Description
1	235438-421	1	ProLiant DL380 G2 1266MHz 256MB rack 2U
1.1	120186-B21	2	FC Host Adapter kit PCI 64bit/66MHz
1.2	157866-021	1	CPQ Remote Insight manager kit
1.3	188122-B22	2	18.2GB 15000r Ultra3 SCSI disk 1"
1.4	201098-B21	1	Pentium III P1266-512kb processor kit
1.5	201693-B21	2	512MB 133MHz ECC SDRAM (2x256MB)
1.6	216886-B21	1	35/70GB Hot plug AIT tape drive
1.7	225011-021	1	DL380R02 second power supply
1.8	225012-B21	1	Hot plug blower option kit, 3x fans
2	235438-421	1	ProLiant DL380 G2 1266MHz 256MB rack 2U
2.1	120186-B21	2	FC Host Adapter kit PCI 64bit/66MHz
2.2	157866-021	1	CPQ Remote Insight manager kit
2.3	188122-B22	2	18.2GB 15000r Ultra3 SCSI disk 1"
2.4	201098-B21	1	Pentium III P1266-512kb processor kit
2.5	201693-B21	2	512MB 133MHz ECC SDRAM (2x256MB)
2.6	216886-B21	1	35/70GB Hot plug AIT tape drive
2.7	225011-021	1	DL380R02 second power supply
2.8	225012-B21	1	Hot plug blower option kit, 3x fans
3	380357-B23	1	ProLiant HA/F200 Cluster kit NT/W2k

BOM of external storage

	Part Number	Qty	Description
1	146013-B31	1	RAID Array 4100 64MB Rack 4U
1.1	223187-B21	1	RA4000 Redundant Controller
1.2	232432-B22	12	72.8GB 10000r Ultra3 SCSI disk 1"
2	146013-B31	1	RAID Array 4100 64MB Rack 4U
2.1	223187-B21	1	RA4000 Redundant Controller
2.2	232432-B22	8	72.8GB 10000r Ultra3 SCSI disk 1"
3	177862-B21	2	Fibre Channel SW FC-AL Switch 8
4	167365-B21	2	Rack mount kit for SAN switch

www.Compaq.com/golden-eggs
Since: Oct-2001

COMPAQ	12-Nov-2001	GTIDL380b2
	Matti.Patari@Compaq.com	

DL380 2P

ProLiant DL380 G2 FC-Sw/RA4100
GOLDEN EGGS Visuals, Helsinki

GOLDEN EGGS

World Services

Alpha Examples

<http://www.compaq.com/golden-eggs>

GOLDEN EGGS

World Station

Software kits

<http://www.compaq.com/info/golden-eggs/software>

GOLDEN EGGS in eBusiness since 1988

COMPAQ

21-Jun-2000 GE-Internet

Matti.Patari@compaq.com

GOLDEN EGGS Internet Outlets
GOLDEN EGGS Visuals, Helsinki