

**Internal Options:**

- CPU** — 222627- B21  
3rd, 4th CPU
- 1GB** — 189081- B21
- 2GB** — 189082- B21
- 4GB** — 189083- B21
  
- 142673 18GB** — 142673- B22  
10k
- 188122 18GB** — 188122- B22  
15k
- 176496 36GB** — 176496- B22  
10k
- 232432 72GB** — 232432- B22  
10k

- 157866- 021** — 157866- 021  
Lights out mgr  
33MHz
- 158575- B21** — 158575- B21  
NC7131 Gigabit  
64- bit /66MHz
- 138603- B21** — 138603- B21  
NC3134 Ethernet, Dual  
64- bit /66MHz
- 158939- B21** — 158939- B21  
Smart Array 5304/128  
64- Bit /66MHz
- 176479- B21** — 176479- B21  
FibreChannel adapter  
64- bit /33MHz

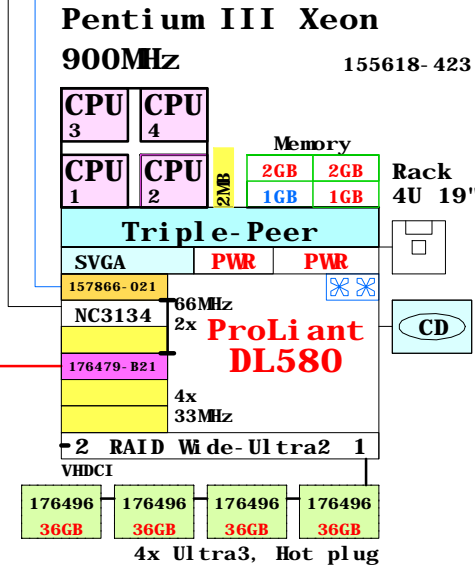

To Fibre Channel Storage

- SVGA
- 32bit/33MHz Non HP
- 64bit/66MHz Hot Plug
- 64bit/66MHz Hot Plug
- 64bit/33MHz Hot Plug
- 64bit/33MHz Hot Plug
- 64bit/33MHz Non HP

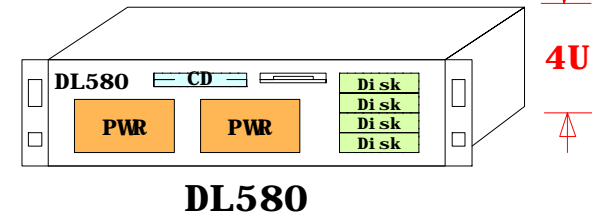
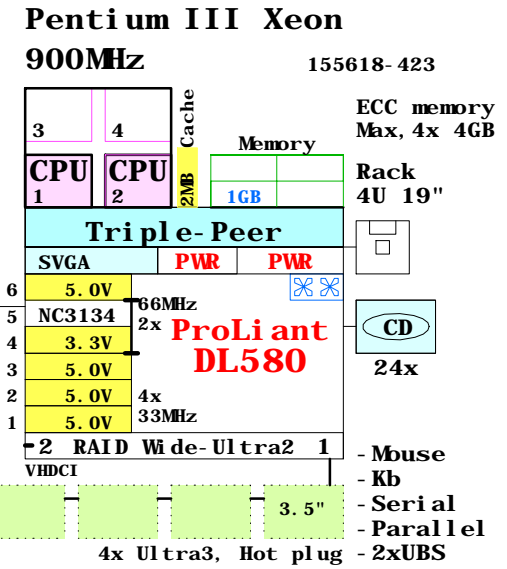

**BOM of the system above**

	Part Number	Qty	Description
1	155618- 423	1	ProLiant DL580 2P 900MHz 1GB rack 4U
1.1	157866- 021	1	CPQ Remote Insight manager kit
1.2	176479- B21	1	Host Buss Cntrl KGPSA- CB,NT only
1.3	176496- B22	4	36GB 10000r Ultra3 SCSI disk 1"
1.4	189081- B21	1	1GB PC100 CL2 ECC SDRAM (4x256MB)
1.5	189082- B21	2	2GB PC100 CL2 ECC SDRAM (4x512MB)
1.6	222627- B21	2	Pentium III Xeon 900-2MB processor kit

[www.Compaq.com/golden-eggs](http://www.Compaq.com/golden-eggs)

Since: Oct- 2001

**COMPAQ**

12- Nov- 2001 GEIDL580a  
Matti.Patari@compaq.com

ProLiant DL580 2PIII X900 2M  
GOLDEN EGGS Visuals, Helsinki

**DL580 4P**

Pentium III Xeon  
900MHz 155618-423

**Compaq ProLiant DL580 2P**

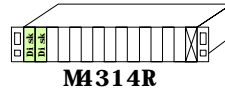
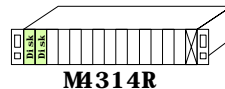
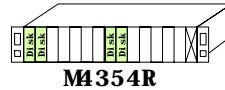
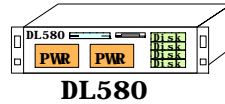
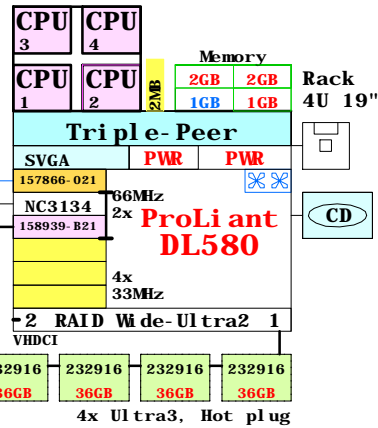

RAID 4ch

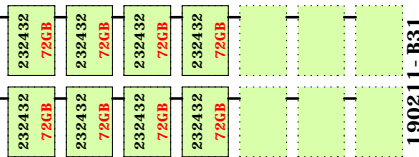

SCSI cables VHDCI - VHDCI  
12ft included in M3xx



**Bill of material**

Part Number	Qty	Description
1	155618-423	1 ProLiant DL580 2P 900MHz 1GB rack 4U
1.1	157866-021	1 CPQ Remote Insight manager kit
1.2	158939-B21	1 Smart Array 5304/128MB, Ultra3 4-chan
1.3	189081-B21	1 1GB PC100 CL2 ECC SDRAM (4x256MB)
1.4	189082-B21	2 2GB PC100 CL2 ECC SDRAM (4x512MB)
1.5	222627-B21	2 Pentium III Xeon 900-2MB processor kit
1.6	232916-B22	4 36GB 15000r Ultra3 SCSI disk 1"
2	190209-B31	1 Modula M314R single buss, 14x 1.0"
2.1	176496-B22	10 36GB 10000r Ultra3 SCSI disk 1"
3	190209-B31	1 Modula M314R single buss, 14x 1.0"
3.1	176496-B22	14 36GB 10000r Ultra3 SCSI disk 1"
4	190211-B31	1 Modula M354R dual buss, 7+7, 1.0"
4.1	232432-B22	8 72.8GB 10000r Ultra3 SCSI disk 1"
5	119826-B21	2 Modula M42/314R 2nd power supply

Pentium III Xeon  
900MHz 155618-423

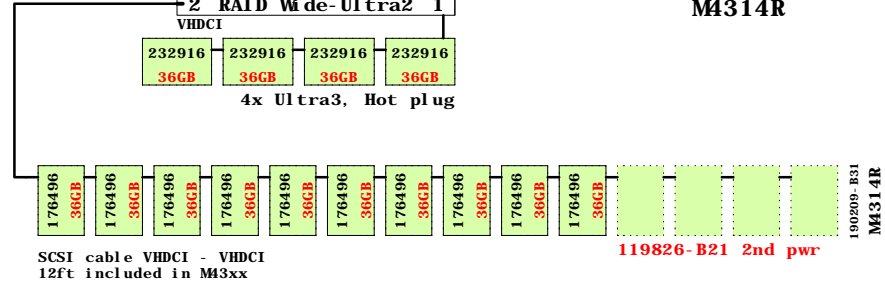
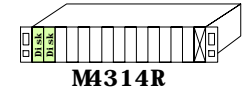
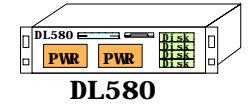
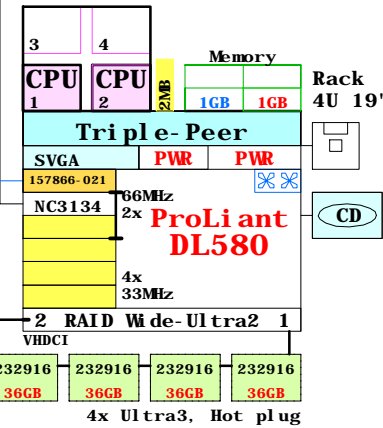

SCSI cable VHDCI - VHDCI  
12ft included in M3xx

**Bill of material**

Part Number	Qty	Description
1	155618-423	1 ProLiant DL580 2P 900MHz 1GB rack 4U
1.1	157866-021	1 CPQ Remote Insight manager kit
1.2	189081-B21	1 1GB PC100 CL2 ECC SDRAM (4x256MB)
1.3	232916-B22	4 36GB 15000r Ultra3 SCSI disk 1"
2	190209-B31	1 Modula M314R single buss, 14x 1.0"
2.1	176496-B22	10 36GB 10000r Ultra3 SCSI disk 1"
3	119826-B21	2 Modula M42/314R 2nd power supply

[www.compaq.com/golden-eggs](http://www.compaq.com/golden-eggs)

Since: Oct-2001

<b>COMPAQ</b>	12-Nov-2001	GTIDL580a
	Matti.Patari@Compaq.com	

**DL580 4P**

ProLiant DL580 2P Entry System  
GOLDEN EGGS Visuals, Helsinki

## Compaq ProLiant DL580 2P

**Pentium III Xeon**  
900MHz 155618-423

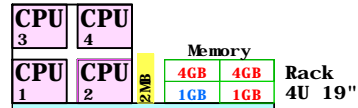

380357-B23 Kit HA/F200

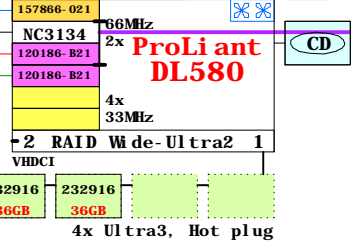

**Pentium III Xeon**  
900MHz 155618-423

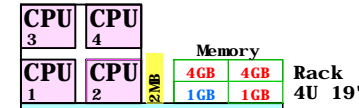

380357-B23 Kit HA/F200

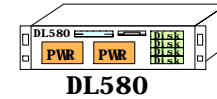
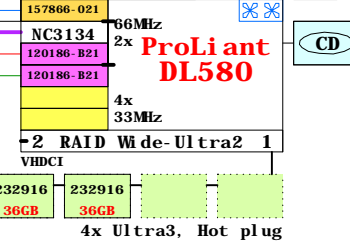

213076-B21 Secure Path W2k  
Needed for each node  
if NOT clustered.

136127-B21 Rack kit for Hub?

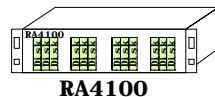
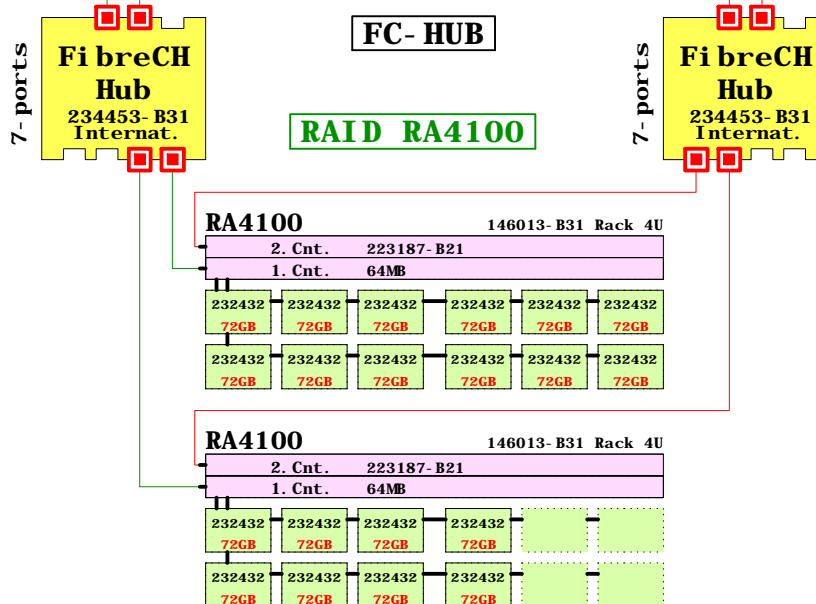

RA4100

### BOM of this Cluster

	Part Number	Qty	Description
1	155618-423	1	ProLiant DL580 2P 900MHz 1GB rack 4U
1.1	120186-B21	2	FC Host Adapter kit PCI 64bit/66MHz
1.2	157866-021	1	CPQ Remote Insight manager kit
1.3	189081-B21	1	1GB PC100 CL2 ECC SDRAM (4x256MB)
1.4	189083-B21	2	4GB PC100 CL2 ECC SDRAM (4x1GB)
1.5	222627-B21	2	Pentium III Xeon 900-2MB processor kit
1.6	232916-B22	2	36GB 15000r Ultra3 SCSI disk 1"
2	155618-423	1	ProLiant DL580 2P 900MHz 1GB rack 4U
2.1	120186-B21	2	FC Host Adapter kit PCI 64bit/66MHz
2.2	157866-021	1	CPQ Remote Insight manager kit
2.3	189081-B21	1	1GB PC100 CL2 ECC SDRAM (4x256MB)
2.4	189083-B21	2	4GB PC100 CL2 ECC SDRAM (4x1GB)
2.5	222627-B21	2	Pentium III Xeon 900-2MB processor kit
2.6	232916-B22	2	36GB 15000r Ultra3 SCSI disk 1"
3	146013-B31	1	RAID Array 4100 64MB Rack 4U
3.1	223187-B21	1	RA4000 Redundant Controller
3.2	232432-B22	12	72.8GB 10000r Ultra3 SCSI disk 1"
4	146013-B31	1	RAID Array 4100 64MB Rack 4U
4.1	223187-B21	1	RA4000 Redundant Controller
4.2	232432-B22	8	72.8GB 10000r Ultra3 SCSI disk 1"
5	234453-B31	2	Fibre Channel Hub 7 Ports International
6	136127-B21	1	Rack mount kit for Hub 7, universal
7	380357-B23	1	ProLiant HA/F200 Cluster kit NT/W2k

[www.compaq.com/golden-eggs](http://www.compaq.com/golden-eggs)

Since: Oct-2001



12-Nov-2001 GTIDL580b1  
Matti.Patari@Compaq.com

ProLiant DL580 2P FC-Hb/RA4100  
GOLDEN EGGS Visuals, Helsinki

# DL580 4P

## Compaq ProLiant DL580 2P

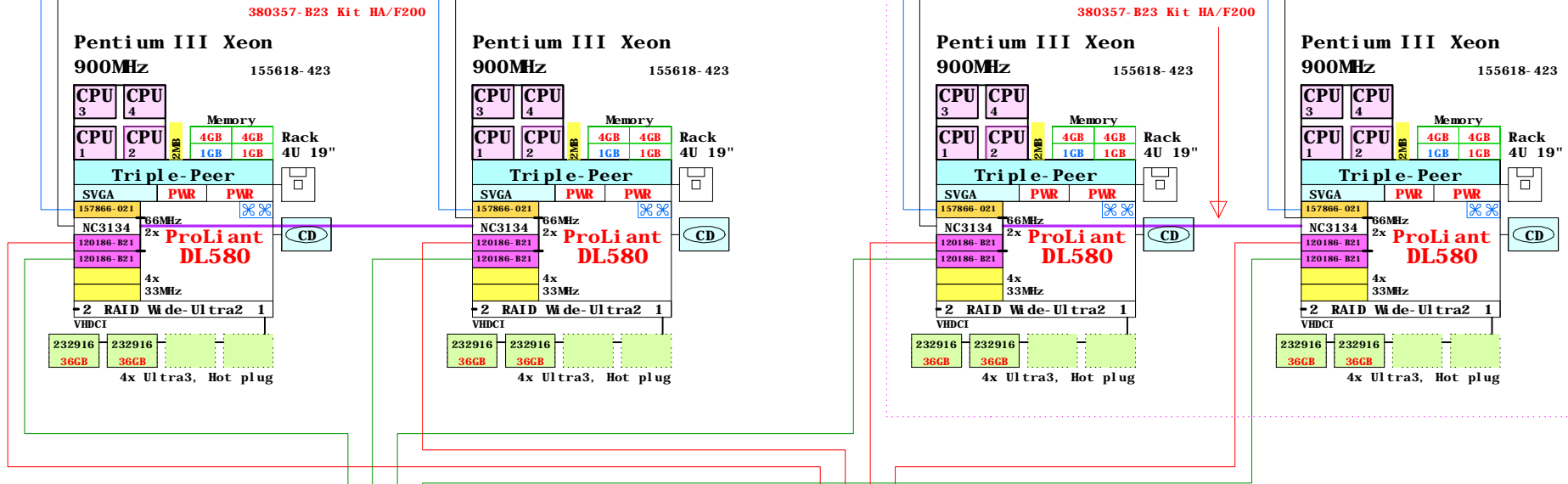

167365-B21 Rack kit for SANsw

167365-B21 Rack kit for SANsw

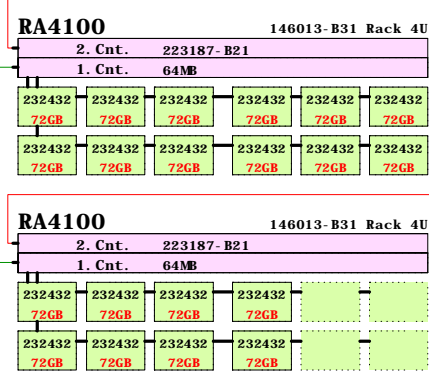
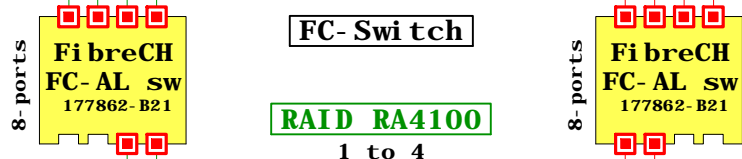

**Note:**  
Each RA4100 is reserved for a Cluster of its own, for two hosts.



### BOM, one pair of DL580s/Cluster

	Part Number	Qty	Description
	155618-423	1	ProLiant DL580 2P 900MHz 1GB rack 4U
1.1	120186-B21	2	FC Host Adapter kit PCI 64bit/66MHz
1.2	157866-021	1	CPQ Remote Insight manager kit
1.3	189081-B21	1	1GB PC100 CL2 ECC SDRAM (4x256MB)
1.4	189083-B21	2	4GB PC100 CL2 ECC SDRAM (4x1GB)
1.5	222627-B21	2	Pentium III Xeon 900-2MB processor kit
1.6	232916-B22	2	36GB 15000r Ultra3 SCSI disk 1"
2	155618-423	1	ProLiant DL580 2P 900MHz 1GB rack 4U
2.1	120186-B21	2	FC Host Adapter kit PCI 64bit/66MHz
2.2	157866-021	1	CPQ Remote Insight manager kit
2.3	189081-B21	1	1GB PC100 CL2 ECC SDRAM (4x256MB)
2.4	189083-B21	2	4GB PC100 CL2 ECC SDRAM (4x1GB)
2.5	222627-B21	2	Pentium III Xeon 900-2MB processor kit
2.6	232916-B22	2	36GB 15000r Ultra3 SCSI disk 1"
3	380357-B23	1	ProLiant HA/F200 Cluster kit NT/W2k

### BOM of external storage

	Part Number	Qty	Description
	146013-B31	1	RAID Array 4100 64MB Rack 4U
1.1	223187-B21	1	RA4000 Redundant Controller
1.2	232432-B22	12	72.8GB 10000r Ultra3 SCSI disk 1"
2	146013-B31	1	RAID Array 4100 64MB Rack 4U
2.1	223187-B21	1	RA4000 Redundant Controller
2.2	232432-B22	8	72.8GB 10000r Ultra3 SCSI disk 1"
3	177862-B21	2	Fibre Channel SW FC-AL Switch 8
4	167365-B21	2	Rack mount kit for SAN switch

[www.Compaq.com/golden-eggs](http://www.Compaq.com/golden-eggs)  
Since: Oct-2001

<b>COMPAQ</b>	12- Nov- 2001	GTIDL580b2
	Matti.Patari@Compaq.com	

# DL580 4P

**ProLiant DL580 2P FC-Sw/RA4100**  
GOLDEN EGGS Visuals, Helsinki

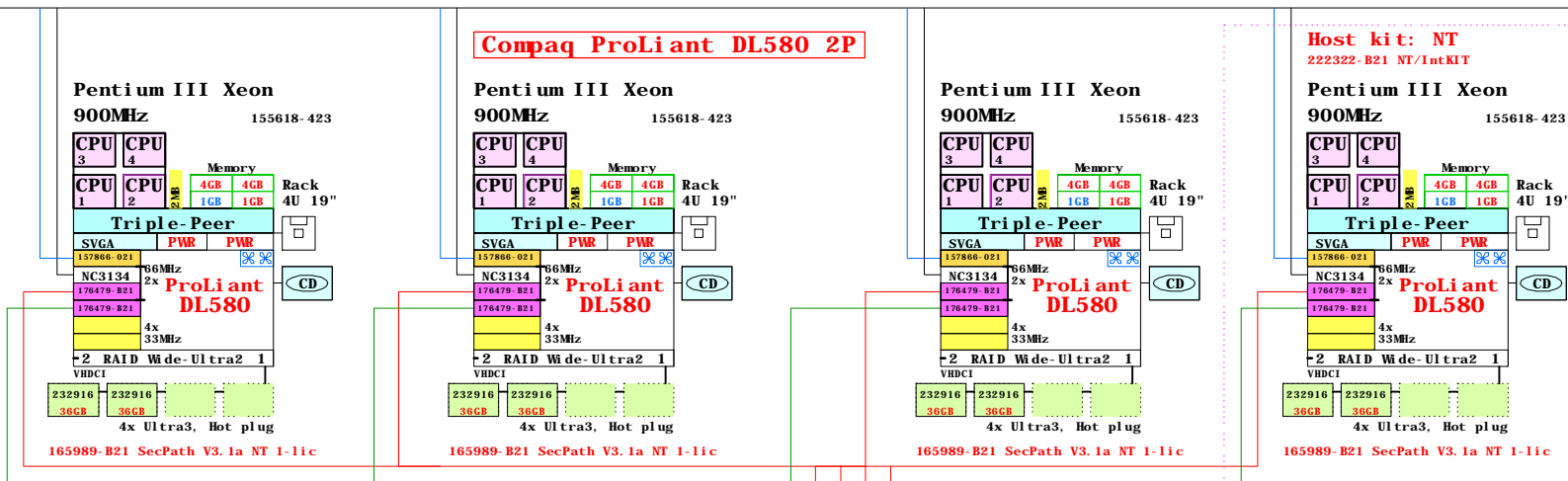

- 234457-B23 0-Cbl 15m
- 234457-B23 0-Cbl 15m
- 234457-B23 0-Cbl 15m
- 234457-B23 0-Cbl 15m
- 234457-B21 0-Cbl 2m
- 234457-B21 0-Cbl 2m

- 160407-B21 2dn power for SANsw
- 167365-B21 Rack kit For SANsw

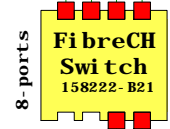

**EMA12000**

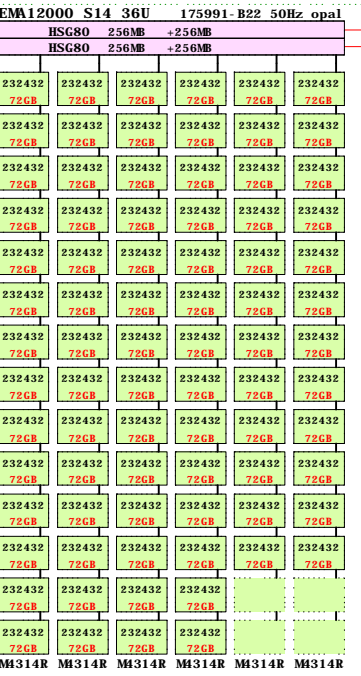

- 135823-B21 Cache BB 222318-B21 ACS 8.6F
- 135823-B21 Cache BB 222318-B21 ACS 8.6F

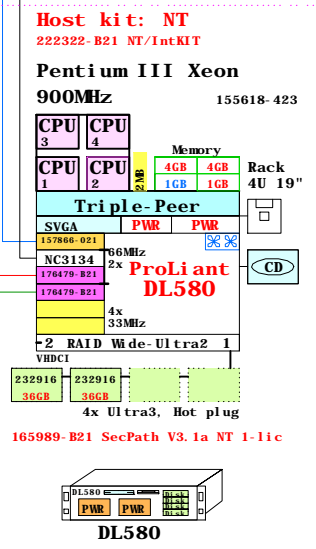

**BOM of the first DL580**

Part Number	Qty	Description
155618-423	1	ProLiant DL580 2P 900MHz 1GB rack 4U
157866-021	1	CPQ Remote Insight manager kit
176479-B21	2	Host Buss Cntrl KGPSA-CB,NT only
189081-B21	1	1GB PC100 CL2 ECC SDRAM (4x256MB)
189083-B21	2	4GB PC100 CL2 ECC SDRAM (4x1GB)
222627-B21	2	Pentium III Xeon 900-2MB processor kit
232916-B22	2	36GB 15000r Ultra3 SCSI disk 1"
165989-B21	1	Secure Path V3.1a for WNT/Wk 1-license
222322-B21	1	OS Platf. Sol. ACS 8.6 FC NT/Intel

**BOM of external storage**

Part Number	Qty	Description
175991-B22	1	EMA12000 S14 36U 50Hz opal
135823-B21	2	HSGxx Single external cache battery
176622-B21	1	HSG80 FC Contr with 256MB cache
380674-B21	1	Cache Upg RA8k ESAI2k 256MB
176622-B21	1	HSG80 FC Contr with 256MB cache
380674-B21	1	Cache Upg RA8k ESAI2k 256MB
222318-B21	2	ACS V8.6F controller FCAL/FCSW
232432-B22	80	72.8GB 10000r Ultra3 SCSI disk 1"
158222-B21	1	SAN Switch 8 Ports
380561-B21	6	FC Optical Short Wave GBIC 500
158222-B21	1	SAN Switch 8 Ports
380561-B21	6	FC Optical Short Wave GBIC 500
160407-B21	2	SAN switch redundant power supply
167365-B21	2	Rack mount kit for SAN switch
234457-B23	8	Fibre Channel 15m Optical Cable
234457-B21	4	Fibre Channel 02m Optical Cable

www.Compaq.com/golden-eggs  
Since: Oct-2001

**COMPAQ** 12-Nov-2001 GTIDL580c  
Matti.Patari@Compaq.com

ProLiant DL580 2P and EMA12000  
GOLDEN EGGS Visuals, Helsinki

**DL580 4P**

# GOLDEN EGGS

World Services

Alpha Examples

<http://www.compaq.com/golden-eggs>

# GOLDEN EGGS

World Station

Software kits

<http://www.compaq.com/info/golden-eggs/software>

GOLDEN EGGS in eBusiness since 1988

**COMPAQ**

21-Jun-2000 GE-Internet

Matti.Patari@compaq.com

GOLDEN EGGS Internet Outlets  
GOLDEN EGGS Visuals, Helsinki