

# AlphaServer ES40 68/833 Systems, 64bits 833MHz

| Model                 | Tru64 UNIX                      | OpenVMS                         | Linux Ready       |
|-----------------------|---------------------------------|---------------------------------|-------------------|
| <b>#1</b><br>M1 6xPCI | -CA 512MB<br>-DA 1GB<br>-EA 2GB | -CA 512MB<br>-DA 1GB<br>-EA 2GB | DJ-62CAA-CA 512MB |
| M2 10xPCI             | -DA 1GB<br>-EA 2GB<br>-FA 4GB   | -DA 1GB<br>-EA 2GB<br>-FA 4GB   |                   |

**#2** Select Enclosure, Disk Cage, Disk Drive, USCSI Controller, Ethernet and Graphics.

| Mini-Tower                  | Pedestal - BA356              | Cabinet - Modula                    |
|-----------------------------|-------------------------------|-------------------------------------|
| BA61M-MT Mini-Tower box     | BA61P-PA/PB Pedestal 120/240V | H9A15-MC/MD Cabinet 120V/240V, 39U  |
| 3X-KZPCA-AA USCSI adapter   | KZPCM-DA 2xUSCSI+ Ethernet    | H9C15-TE Cabinet rear extender      |
| BA610-6D Disk Drive Cage    | BN37A-02 SCSI cable, 2m       | H9C15-TF Cabinet front door         |
| 3R-A0585-AA Disk 18.2GB 10k | BA36R-RC Single-buss shelf    | H9C10-MC Ballast kit, 40lbs         |
| 3R-A0919-AA Disk 36.4GB 10k | BA36R-RD Split-buss shelf     | BA61R-RM Rack mount kit             |
| 3X-DE600-AA Ethernet 10/100 | DS-RZ1DD-VW Disk 9.1GB 10k    | YS-ASCAA-AA Factory integration     |
| BN25G-10 Cable, twisted     | DS-RZ1ED-VW Disk 18.2GB 10k   | 3X-KZPCA-AA Ultra2 SCSI adapte, 1-2 |
| SN-PBXGK-BB ElsaGloria 8MB  | BN25G-10 Cable, twisted       | BN38C-05 SCSI cable, 5m, 1-2        |
|                             | SN-PBXGK-BB ElsaGloria 8MB    | DS-SL13R-AB Shelf M4314, single b.  |
|                             |                               | DS-SL13R-BB Shelf M4354, dual bus   |
|                             |                               | 3R-A1543-AA Disk 18.2GB 15k         |
|                             |                               | 3X-DE600-AA Ethernet 10/100         |
|                             |                               | BN25G-10 Cable, twisted             |
|                             |                               | SN-PBXGK-BB ElsaGloria 8MB          |

**#3** SVGA color monitor **#4** For 240V use, select keyboard and power cord

|                        |                              |                 |
|------------------------|------------------------------|-----------------|
| 15" 3R-VRQV5-24/11     | SN-LKQ47 -AE GB -AG G -AM S  | BN19C-2E Europe |
| 17" 3R-VRQP7-24/23     | UNIX, Lin -AB B -AH NL -AN N | BN19A-2E GB     |
| North/South            | LK461 -AD DK -AI I -AP F     | BN19E-2E CH     |
| BN39C-02 2m ext. cable | OVMS -AF FI -AK CH -AS E     | BN19K-2E DK     |
|                        |                              | BN19Z-2E I      |

## Internal options

### Memory expansion

|          |     |
|----------|-----|
| MS610-DA | 1GB |
| MS610-EA | 2GB |
| MS610-FA | 4GB |

### Additional CPUs, Max 4

|       |          |        |
|-------|----------|--------|
| UNIX  | KN610-CB | 833MHz |
| OVMS  | KN610-CC | 833MHz |
| Linux | KN610-CA | 833MHz |

### Power supplies, CPU 3-4 and/or for the second disk cage

|             |              |
|-------------|--------------|
| H7906-A9    | CPU power    |
| CK-BA35X-HH | 2nd disk pwr |

### Internal storage

#### Tape storage

|             |                        |
|-------------|------------------------|
| TLZ10-LB    | 12/24GB DAT Tape drive |
| 3X-BN46M-01 | Multi head SCSI cable  |

#### Disk storage

|             |                         |
|-------------|-------------------------|
| 3R-A0585-AA | 18GB Universal disk 10k |
| 3R-A0919-AA | 36GB Universal disk 10k |

|          |                           |
|----------|---------------------------|
| KZPBA-CA | UltraSCSI SE adapter      |
| BN38C-02 | 2m SCSI cable, 68HD-VHDCI |
| KZPCM-DA | Dual UltraSCSI+ Ethernet  |
| BN37A-02 | 2m SCSI cable, VHDCI-VHDC |

|          |                           |
|----------|---------------------------|
| KZPAC-CB | RAID 3-port, 8MB cache    |
| KZPSC-UB | Cache battery             |
| KZPAC-SB | Dual cable bulkhead       |
| BN37A-02 | 2m SCSI cable VHDCI-VHDCI |

### Controllers

|             |                       |
|-------------|-----------------------|
| 3X-DE600-AA | Fast Ethernet         |
| DEGPA-SA    | Gigabit Ethernet      |
| 3X-DEFPA-AC | FDDI adapter, SAS MMF |
| CCMAB-AA    | Memory Channel        |
| CIPCA-BA    | CI controller         |
| DS-KGPSA-CA | Fibre Channel adapt   |
| 168794-B21  | --" --                |

### External options

|             |                      |
|-------------|----------------------|
| DS-TZ89N-TA | 35/70GB DLT tape, TT |
| BN21K-02    | SCSI cable, FWD      |
| BN19C-2E    | Power cord, Europe   |
| KZPBA-CA    | UltraSCSI SE adapter |

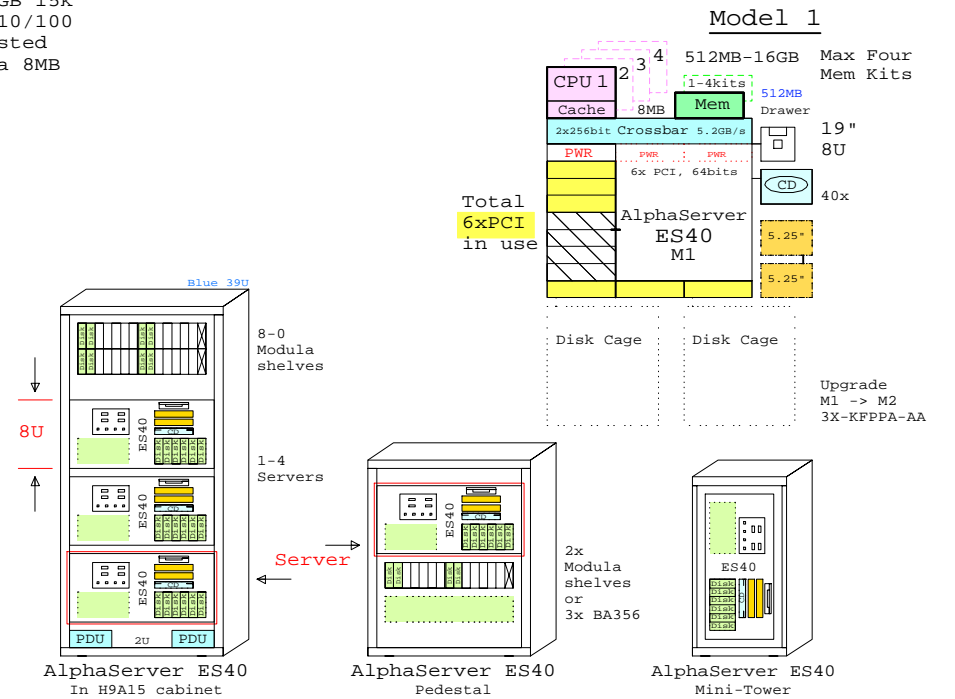
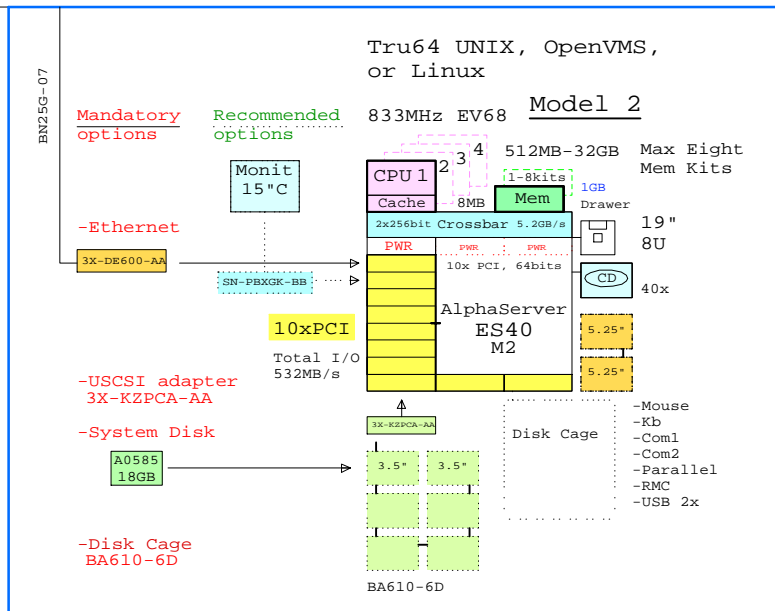

AlphaServer ES40 In H9A15 cabinet | AlphaServer ES40 Pedestal | AlphaServer ES40 Mini-Tower

|           | @833MHz | @667MHz |
|-----------|---------|---------|
| SPECint95 | 40      | 83      |
| SPECfp95  | 68      | 685     |
| SPECweb99 |         |         |

Software Processor Code: **E**

**COMPAQ** 30-Jan-2001 GEAES403  
Matti.Patari@compaq.com

ES40

Tru64 UNIX, OpenVMS,  
or Linux

833MHz EV68 Model 1

BN25G-07

**Mandatory options**

**Recommended options**

Monit  
15" C

-Ethernet  
3X-DE600-AA

SN-PBXGK-BB

-USCSI adapter  
3X-KZPCA-AA

-System Disk  
A0585  
18GB

-Disk Cage  
BA610-6D

512MB-32GB Max Eight  
Mem Kits

2 CPU 1  
Cache 8MB

3 Mem 512MB-32GB  
1GB

4 2x256bit Crossbar 5.2GB/s  
PWR 10x PCI, 64bits

AlphaServer  
ES40  
M2

2x 5.25" 5.25"

CD 40x

- Mouse
- Kb
- Com1
- Com2
- Parallel
- RMC
- USB 2x

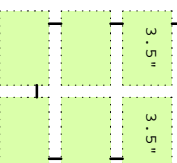

BA610-6D

Model 1

512MB-16GB Max Four  
Mem Kits

2 CPU 1  
Cache 8MB

3 Mem 512MB  
512MB

4 2x256bit Crossbar 5.2GB/s  
PWR 6x PCI, 64bits

AlphaServer  
ES40  
M1

2x 5.25" 5.25"

CD 40x

- Upgrade  
M1 -> M2  
3X-KPPA-AA

Disk Cage

Disk Cage



Total  
6xPCI  
in use

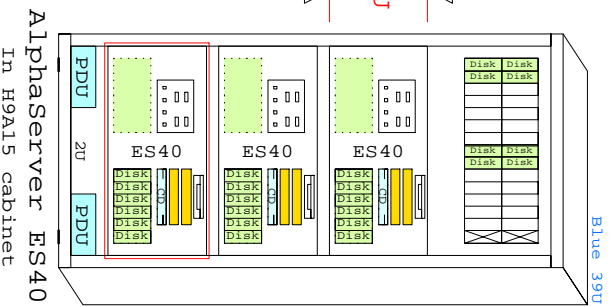

AlphaServer ES40  
In H9A15 cabinet

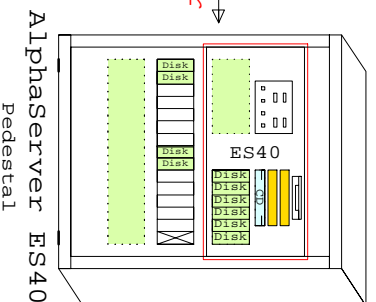

AlphaServer ES40  
Pedestal

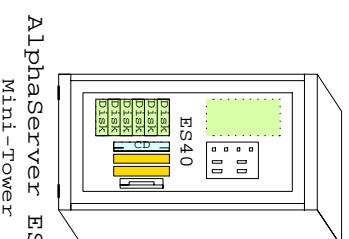

AlphaServer ES40  
Mini-Tower

Software Processor Code: **E**

**COMPAQ**

30-Jan-2001 GEAES403  
Matci.Patarji@compaq.com

AlphaServer ES40 833MHz Syst.  
GOLDEN EGGS Visuals, Helsinki

SPECInt95  
SPECfp95  
SPECweb99

@833MHZ @667MHZ  
40 83 685

www.compaq.com/golden-eggs

Since Jan-2001

ES40

BN25G-07

Tru64 UNIX, OpenVMS,  
or Linux

833MHz EV68 Model 2

Mandatory options

Recommended options

512MB-32GB Max Eight Mem Kits

Monit  
15" C

CPU 1  
Cache

2 3 4  
8MB

1-8kits  
1GB  
Mem  
Drawer

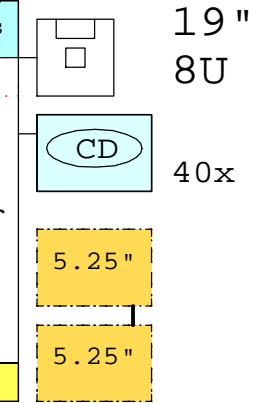
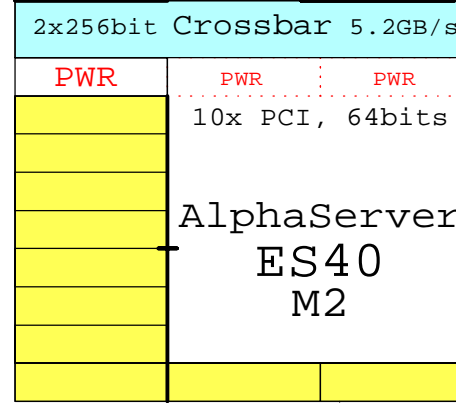

-Ethernet

3X-DE600-AA

SN-PBXGK-BB

10xPCI

Total I/O  
532MB/s

-USCSI adapter  
3X-KZPCA-AA

-System Disk

A0585  
18GB

3X-KZPCA-AA

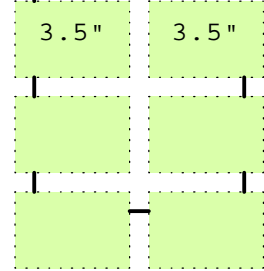

-Disk Cage  
BA610-6D

BA610-6D

- Disk Cage
- Mouse
  - Kb
  - Com1
  - Com2
  - Parallel
  - RMC
  - USB 2x

Ethernet  
FDDI

ES40 Model 2 Mini Tower System

ES40 Model 1 Mini Tower System

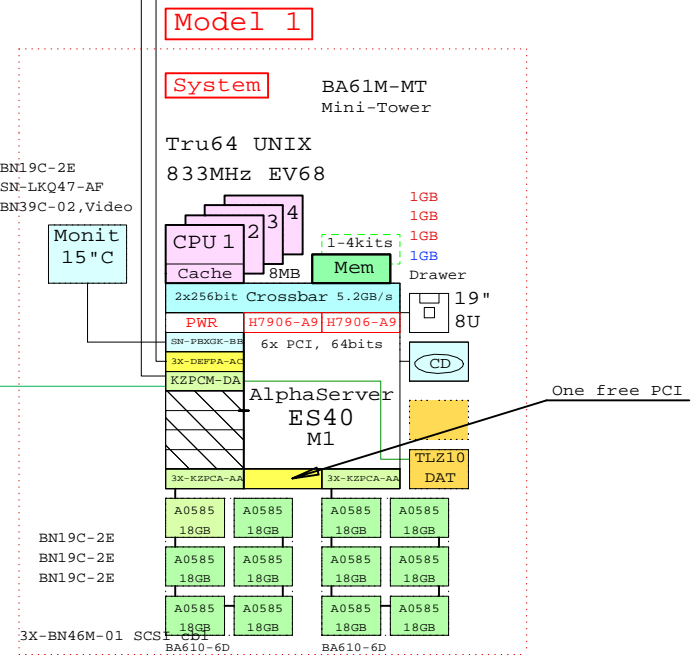
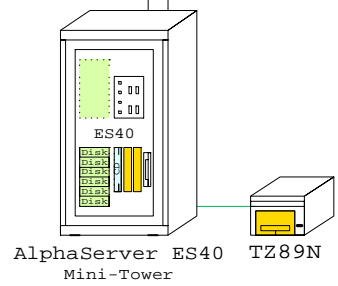
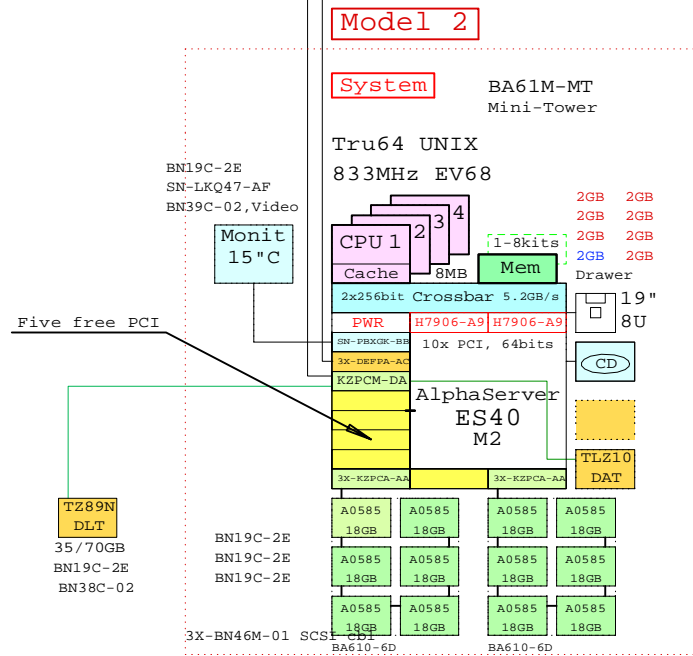

Bill of material, Model 2

| Part Number | Qty | Description  |
|-------------|-----|--|
| 1           | 1   | BA61M-MT ES40 Mini-Tower Enclosure                 |
| 1.1         | 1   | 3X-BN46M-01 SCSI cable for Tape                    |
| 1.2         | 1   | BN19C-2E PowerCable 240V, C-Europe                 |
| 1.3         | 1   | DA-64CAA-EA ES40 68/833 Model 2 2GB UNIX 10PCI DWR |
| 1.3.1       | 1   | 3R-VROV5-24 COMPAQ V55 CLR MON,NH,TCO95            |
| 1.3.2       | 1   | 3X-DEPFA-AC PCI to FDDI SAS MMF with SC,Universal  |
| 1.3.3       | 2   | 3X-KZPCA-AA Single channel LVD adapter             |
| 1.3.4       | 1   | BA610-6D ES40 Disk Drive Cage, 6-Bay               |
| 1.3.4.1     | 6   | 3R-A0585-AA 18.2GB Uscsi3 10k Universal disk 1"    |
| 1.3.5       | 1   | BA610-6D ES40 Disk Drive Cage, 6-Bay               |
| 1.3.5.1     | 6   | 3R-A0585-AA 18.2GB Uscsi3 10k Universal disk 1"    |
| 1.3.6       | 3   | BN19C-2E PowerCable 240V, C-Europe                 |
| 1.3.7       | 1   | BN39C-02 1.8 Video Extension Cable ****            |
| 1.3.8       | 2   | H7906-A9 ES40 Power Syply, 2nd or 3rd              |
| 1.3.9       | 3   | KN610-CB ES40 68/833MHz UNIX SMP 8mb cache         |
| 1.3.10      | 1   | KZPCM-DA Dual Uscsi with FastEther PCI             |
| 1.3.11      | 7   | MS610-EA ES40 2GB Memory Option                    |
| 1.3.12      | 1   | SN-PBXGK-BB Elsa Gloria Synergy 8M Video Graphics  |
| 1.3.13      | 1   | TLZ10-LB 12/24GB 4mm DAT 5.25" HH                  |
| 1.4         | 1   | SN-LKQ47-AF 102 KEY KYBD,NON-WIN, Finnish          |
| 2           | 1   | DS-TZ89N-TA 35/70GB SE DLT-tape TT FWSE            |
| 3           | 1   | BN19C-2E PowerCable 240V, C-Europe                 |
| 4           | 1   | BN38C-02 Ultra Cbl VHDCI - 68HD                    |

Bill of material, Model 1

| Part Number | Qty | Description                                       |
|-------------|-----|---|
| 1           | 1   | BA61M-MT ES40 Mini-Tower Enclosure                |
| 1.1         | 1   | 3X-BN46M-01 SCSI cable for Tape                   |
| 1.2         | 1   | BN19C-2E PowerCable 240V, C-Europe                |
| 1.3         | 1   | DA-62CAA-DA ES40 68/833 Model 1 1GB UNIX 6PCI DWR |
| 1.3.1       | 1   | 3R-VROV5-24 COMPAQ V55 CLR MON,NH,TCO95           |
| 1.3.2       | 1   | 3X-DEPFA-AC PCI to FDDI SAS MMF with SC,Universal |
| 1.3.3       | 2   | 3X-KZPCA-AA Single channel LVD adapter            |
| 1.3.4       | 1   | BA610-6D ES40 Disk Drive Cage, 6-Bay              |
| 1.3.4.1     | 6   | 3R-A0585-AA 18.2GB Uscsi3 10k Universal disk 1"   |
| 1.3.5       | 1   | BA610-6D ES40 Disk Drive Cage, 6-Bay              |
| 1.3.5.1     | 6   | 3R-A0585-AA 18.2GB Uscsi3 10k Universal disk 1"   |
| 1.3.6       | 3   | BN19C-2E PowerCable 240V, C-Europe                |
| 1.3.7       | 1   | BN39C-02 1.8 Video Extension Cable ****           |
| 1.3.8       | 2   | H7906-A9 ES40 Power Syply, 2nd or 3rd             |
| 1.3.9       | 3   | KN610-CB ES40 68/833MHz UNIX SMP 8mb cache        |
| 1.3.10      | 1   | KZPCM-DA Dual Uscsi with FastEther PCI            |
| 1.3.11      | 3   | MS610-DA ES40 1GB Memory Option                   |
| 1.3.12      | 1   | SN-LKQ47-AF 102 KEY KYBD,NON-WIN, Finnish         |
| 1.3.13      | 1   | SN-PBXGK-BB Elsa Gloria Synergy 8M Video Graphics |
| 1.3.14      | 1   | TLZ10-LB 12/24GB 4mm DAT 5.25" HH                 |
| 2           | 1   | DS-TZ89N-TA 35/70GB SE DLT-tape TT FWSE           |
| 3           | 1   | BN19C-2E PowerCable 240V, C-Europe                |
| 4           | 1   | BN38C-02 Ultra Cbl VHDCI - 68HD                   |

[www.Compaq.com/golden-eggs](http://www.Compaq.com/golden-eggs)  
Since:Jan-2001

|                               |                         |           |
|-------------------------------|-------------------------|-----------|
| <b>COMPAQ</b>                 | 30-Jan-2001             | GTAUES40A |
|                               | Matti.Patari@compaq.com |           |
| AlphaServer ES40 Mini Tower   |                         |           |
| GOLDEN EGGS Visuals, Helsinki |                         |           |

Ethernet  
FDDI

ES40 Model 2 Pedestal System

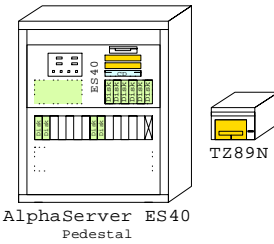
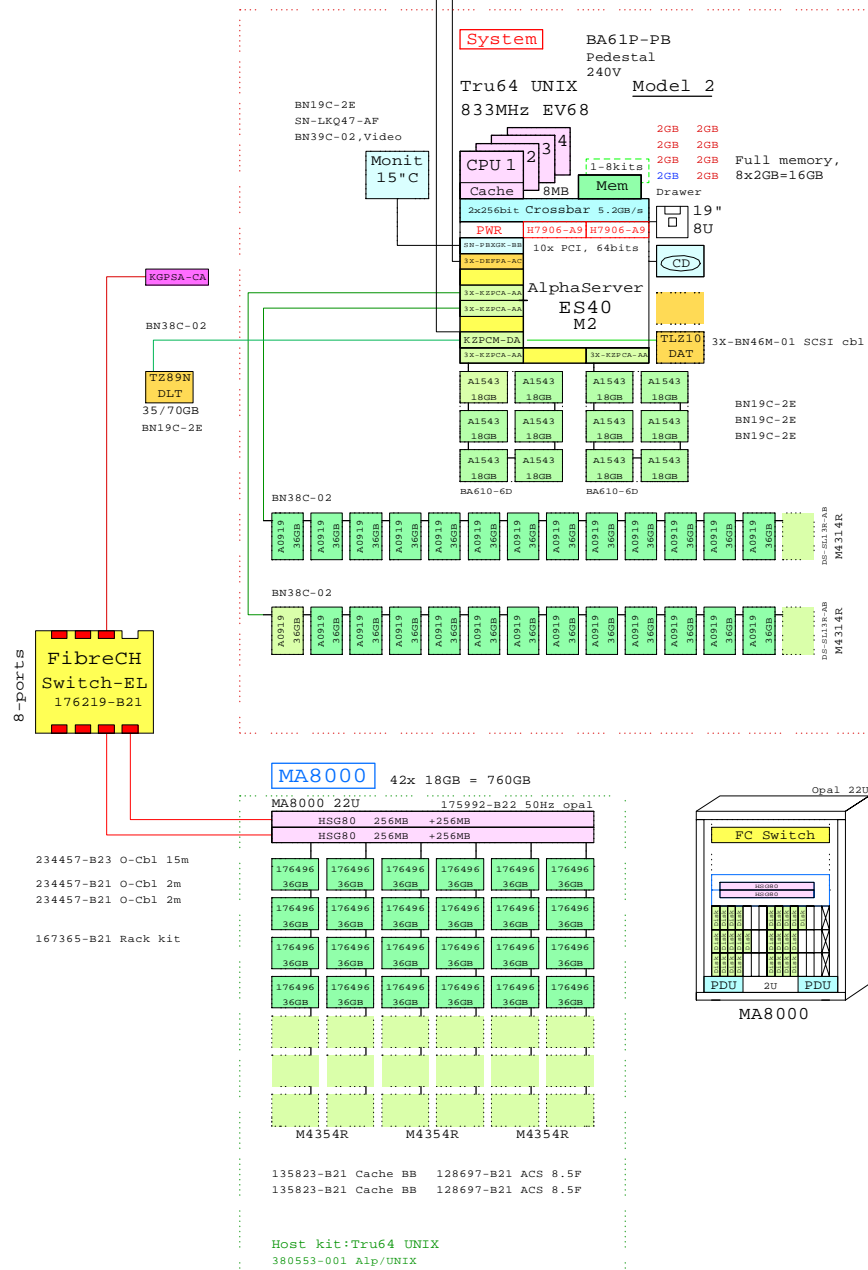

Bill of material for the base Pedestal

|         | Part Number  | Qty | Description                            |
|---------|--------------|-----|--|
|         | BA61P-PB     | 1   | ES40 Pedestal Enclosure 240V Europe    |
| 1.1     | 3X-BN46M-01  | 1   | SCSI cable for Tape                    |
| 1.2     | BN19C-2E     | 4   | PowerCable 240V, C-Europe              |
| 1.3     | BN38C-02     | 2   | Ultra Cbl VHDCI - 68HD                 |
| 1.4     | BN39C-02     | 1   | 1.8 Video Extension Cable ****         |
| 1.5     | DA-64CAA-EA  | 1   | ES40 68/833 Model 2 2GB UNIX 10PCI DWR |
| 1.5.1   | 3R-VRQV5-24  | 1   | COMPAQ V55 CLR MON,NH,TCO95            |
| 1.5.2   | 3X-DEFPAC-AA | 1   | PCI to FDDI SAS MMF with SC,Universal  |
| 1.5.3   | 3X-KZPCA-AA  | 4   | Single channel LVD adapter             |
| 1.5.4   | BA610-6D     | 1   | ES40 Disk Drive Cage, 6-Bay            |
| 1.5.4.1 | 3R-A1543-AA  | 6   | 18.2GB Uscsi3 15k Universal disk 1"    |
| 1.5.5   | BA610-6D     | 1   | ES40 Disk Drive Cage, 6-Bay            |
| 1.5.5.1 | 3R-A1543-AA  | 6   | 18.2GB Uscsi3 15k Universal disk 1"    |
| 1.5.6   | H7906-A9     | 2   | ES40 Power Syply, 2nd or 3rd           |
| 1.5.7   | KN610-CB     | 3   | ES40 68/833MHz UNIX SMP 8mb cache      |
| 1.5.8   | KZPCM-DA     | 1   | Dual Uscsi with FastEther PCI          |
| 1.5.9   | MS610-EA     | 7   | ES40 2GB Memory Option                 |
| 1.5.10  | SN-PBXGK-BB  | 1   | Elsa Gloria Synergy 8M Video Graphics  |
| 1.5.11  | TLZ10-LB     | 1   | 12/24GB 4mm DAT 5.25" HH               |
| 1.6     | DS-SL13R-AB  | 1   | Modula M4314R single buss,14x 1.0" Int |
| 1.6.1   | 3R-A0919-AA  | 13  | 36.4GB Uscsi3 10k Universal disk 1"    |
| 1.7     | DS-SL13R-AB  | 1   | Modula M4314R single buss,14x 1.0" Int |
| 1.7.1   | 3R-A0919-AA  | 13  | 36.4GB Uscsi3 10k Universal disk 1"    |
| 1.8     | SN-LKQ47-AF  | 1   | 102 KEY KYBD,NON-WIN, Finnish          |
| 2       | DS-TZ89N-TA  | 1   | 35/70GB SE DLT-tape "T" FWSE           |
| 3       | BN19C-2E     | 1   | PowerCable 240V, C-Europe              |
| 4       | BN38C-02     | 1   | Ultra Cbl VHDCI - 68HD                 |

BOM for the external RA8000 RAID

|       | Part Number | Qty | Description                          |
|-------|-------------|-----|--------------------------------------|
| 1     | 175992-B22  | 1   | MA8000 6x7 22U 50Hz opal             |
| 1.1   | 128697-B21  | 2   | ACS V8.5F controller FCAL/FCSW       |
| 1.2   | 135823-B21  | 2   | HSGxx Single external cache battery  |
| 1.3   | 176496-B22  | 24  | 36GB 10000r Ultra3 SCSI disk 1"      |
| 1.4   | 176622-B21  | 1   | HSG80 FC Contr with 256MB cache      |
| 1.4.1 | 380674-B21  | 1   | Cache Upg RA8k ESA12k 256MB          |
| 1.5   | 176622-B21  | 1   | HSG80 FC Contr with 256MB cache      |
| 1.5.1 | 380674-B21  | 1   | Cache Upg RA8k ESA12k 256MB          |
| 1.6   | 380553-001  | 1   | OS Platf.Softw.Kit for FC Alpha UNIX |
| 2     | 176219-B21  | 1   | SAN Switch EL 8-Ports                |
| 3     | 234457-B23  | 1   | Fibre Channel 15m Optical Cable      |
| 4     | 167365-B21  | 1   | Rack mount kit for SAN switch        |
| 5     | 234457-B21  | 2   | Fibre Channel 02m Optical Cable      |
| 6     | 168794-B21  | 1   | Host Buss Cntr KGPSA-CA,OVMS,UNIX    |

www.Compaq.com/golden-eggs  
Since:Jan-2001

**COMPAQ** 30-Jan-2001 GTAUES40B  
Matti.Patari@compaq.com

AlphaServer ES40 UNIX Pedestal  
GOLDEN EGGS Visuals, Helsinki

ES40 UNIX

ES40 Model 2 Systems in Cabinet M15

Ethernet  
FDDI

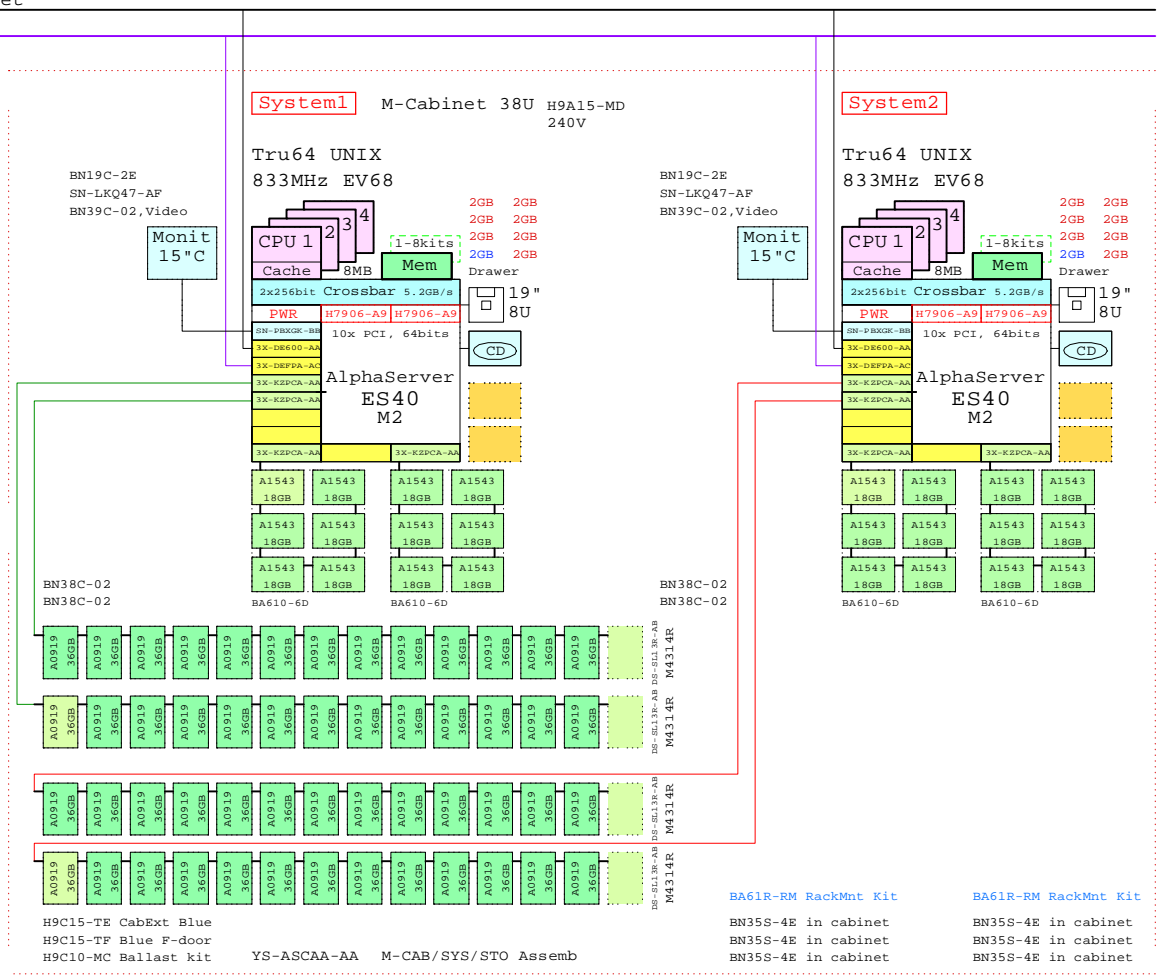

Bill of material for Cabinet and System 1

| Part Number | Qty | Description  |
|-------------|-----|--|
| 1           | 1   | H9A15-MD 1 M-Series Cab,H9A15,Blue,240V 38U          |
| 1.1         | 1   | BA61R-RM 1 ES40 Rackmount Kit                        |
| 1.2         | 1   | BN19C-2E 1 PowerCable 240V, C-Europe                 |
| 1.3         | 3   | BN35S-4E 3 PowerCord Cl3 to Cl4, Non US              |
| 1.4         | 2   | BN38C-02 2 Ultra Cbl VHDCI - 68HD                    |
| 1.5         | 1   | BN39C-02 1 1.8 Video Extension Cable ****            |
| 1.6         | 1   | DA-64CAA-EA 1 ES40 68/833 Model 2 2GB UNIX 10PCI DWR |
| 1.6.1       | 1   | 3R-VRQV5-24 1 COMPAQ V55 CLR MON,NH,TCO95            |
| 1.6.2       | 1   | 3X-DE600-AA 1 10/100 1xChannel Ethernet, Twisted     |
| 1.6.3       | 1   | 3X-DEFFA-AC 1 PCI to FDDI SAS MMF with SC,Universal  |
| 1.6.4       | 4   | 3X-KZPCA-AA 4 Single channel LVD adapter             |
| 1.6.5       | 1   | BA610-6D 1 ES40 Disk Drive Cage, 6-Bay               |
| 1.6.5.1     | 6   | 3R-A1543-AA 6 18.2GB Uscsi3 15k Universal disk 1"    |
| 1.6.6       | 1   | BA610-6D 1 ES40 Disk Drive Cage, 6-Bay               |
| 1.6.6.1     | 6   | 3R-A1543-AA 6 18.2GB Uscsi3 15k Universal disk 1"    |
| 1.6.7       | 2   | H7906-A9 2 ES40 Power Syply, 2nd or 3rd              |
| 1.6.8       | 3   | KN610-CB 3 ES40 68/833MHz UNIX SMP 8mb cache         |
| 1.6.9       | 7   | MS610-EA 7 ES40 2GB Memory Option                    |
| 1.6.10      | 1   | SN-PBXGK-BB 1 Elsa Gloria Synergy 8M Video Graphics  |
| 1.7         | 1   | DS-SL13R-AB 1 Modula M4314R single buss,14x 1.0" Int |
| 1.7.1       | 13  | 3R-A0919-AA 13 36.4GB Uscsi3 10k Universal disk 1"   |
| 1.8         | 1   | DS-SL13R-AB 1 Modula M4314R single buss,14x 1.0" Int |
| 1.8.1       | 13  | 3R-A0919-AA 13 36.4GB Uscsi3 10k Universal disk 1"   |
| 1.9         | 1   | H9C10-MC 1 Ballast Kit for cabinets                  |
| 1.10        | 1   | H9C15-TE 1 Rear cab extender for H9A15 Blue          |
| 1.11        | 1   | H9C15-TF 1 FrontDoorKit Blue for H9A15               |
| 1.12        | 1   | SN-LKQ47-AF 1 102 KEY KYBD,NON-WIN, Finnish          |
| 1.13        | 1   | YS-ASCAA-AA 1 M-CAB/SYS/STO Assembly                 |

Bill of material for System 2

| Part Number | Qty | Description  |
|-------------|-----|--|
| 1           | 1   | DA-64CAA-EA 1 ES40 68/833 Model 2 2GB UNIX 10PCI DWR |
| 1.1         | 1   | 3R-VRQV5-24 1 COMPAQ V55 CLR MON,NH,TCO95            |
| 1.2         | 1   | 3X-DE600-AA 1 10/100 1xChannel Ethernet, Twisted     |
| 1.3         | 1   | 3X-DEFFA-AC 1 PCI to FDDI SAS MMF with SC,Universal  |
| 1.4         | 4   | 3X-KZPCA-AA 4 Single channel LVD adapter             |
| 1.5         | 1   | BA610-6D 1 ES40 Disk Drive Cage, 6-Bay               |
| 1.5.1       | 6   | 3R-A1543-AA 6 18.2GB Uscsi3 15k Universal disk 1"    |
| 1.6         | 1   | BA610-6D 1 ES40 Disk Drive Cage, 6-Bay               |
| 1.6.1       | 6   | 3R-A1543-AA 6 18.2GB Uscsi3 15k Universal disk 1"    |
| 1.7         | 2   | H7906-A9 2 ES40 Power Syply, 2nd or 3rd              |
| 1.8         | 3   | KN610-CB 3 ES40 68/833MHz UNIX SMP 8mb cache         |
| 1.9         | 7   | MS610-EA 7 ES40 2GB Memory Option                    |
| 1.10        | 1   | SN-PBXGK-BB 1 Elsa Gloria Synergy 8M Video Graphics  |
| 2           | 1   | DS-SL13R-AB 1 Modula M4314R single buss,14x 1.0" Int |
| 2.1         | 13  | 3R-A0919-AA 13 36.4GB Uscsi3 10k Universal disk 1"   |
| 3           | 1   | DS-SL13R-AB 1 Modula M4314R single buss,14x 1.0" Int |
| 3.1         | 13  | 3R-A0919-AA 13 36.4GB Uscsi3 10k Universal disk 1"   |
| 4           | 1   | BA61R-RM 1 ES40 Rackmount Kit                        |
| 5           | 3   | BN35S-4E 3 PowerCord Cl3 to Cl4, Non US              |
| 6           | 1   | BN39C-02 1 1.8 Video Extension Cable ****            |
| 7           | 1   | SN-LKQ47-AF 1 102 KEY KYBD,NON-WIN, Finnish          |
| 8           | 1   | BN19C-2E 1 PowerCable 240V, C-Europe                 |
| 9           | 2   | BN38C-02 2 Ultra Cbl VHDCI - 68HD                    |

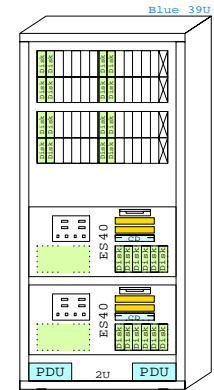

AlphaServer ES40 In H9A15 cabinet

This template is included in the present GOLDEN EGGS Software kit.

ES40 UNIX

www.Compaq.com/golden-eggs  
Since:Jan-2001

**COMPAQ** 30-Jan-2001 GTAUES40C  
Mattti.Patari@compaq.com

AlphaServer ES40 UNIX Cabinet  
GOLDEN EGGS Visuals, Helsinki



Ethernet  
FDDI

ES40 Model 2 Mini Tower System

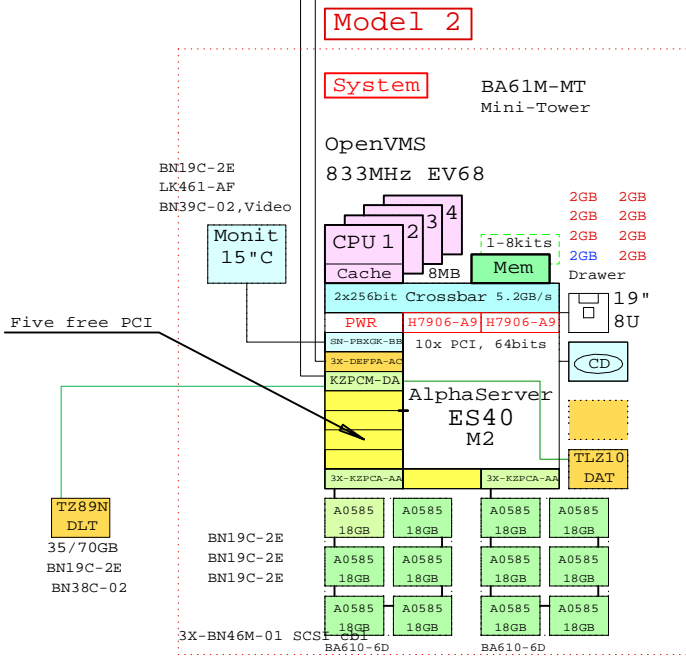

Bill of material, Model 2

| Part Number | Qty | Description  |
|-------------|-----|--|
| 1           | 1   | BA61M-MT 1 ES40 Mini-Tower Enclosure                 |
| 1.1         | 1   | 3X-BN46M-01 1 SCSI cable for Tape                    |
| 1.2         | 1   | BN19C-2E 1 PowerCable 240V, C-Europe                 |
| 1.3         | 1   | DY-64CAA-EA 1 ES40 68/833 Model 2 2GB OVMS 10PCI DWR |
| 1.3.1       | 1   | 3R-VROV5-24 1 COMPAQ V55 CLR MON,NH,TCO95            |
| 1.3.2       | 1   | 3X-DEPFA-AC 1 PCI to FDDI SAS MMF with SC,Universal  |
| 1.3.3       | 2   | 3X-KZPCA-AA 2 Single channel LVD adapter             |
| 1.3.4       | 1   | BA610-6D 1 ES40 Disk Drive Cage, 6-Bay               |
| 1.3.4.1     | 6   | 3R-A0585-AA 6 18.2GB Uscsi3 10k Universal disk 1"    |
| 1.3.5       | 1   | BA610-6D 1 ES40 Disk Drive Cage, 6-Bay               |
| 1.3.5.1     | 6   | 3R-A0585-AA 6 18.2GB Uscsi3 10k Universal disk 1"    |
| 1.3.6       | 3   | BN19C-2E 3 PowerCable 240V, C-Europe                 |
| 1.3.7       | 1   | BN39C-02 1 1.8 Video Extension Cable ****            |
| 1.3.8       | 2   | H7906-A9 2 ES40 Power Sypl, 2nd or 3rd               |
| 1.3.9       | 3   | KN610-CC 3 ES40 68/833MHz OVMS SMP 8mb cache         |
| 1.3.10      | 1   | KZPCM-DA 1 Dual Uscsi with FastEther PCI             |
| 1.3.11      | 7   | MS610-EA 7 ES40 2GB Memory Option                    |
| 1.3.12      | 1   | SN-PBXGK-BB 1 Elsa Gloria Synergy 8M Video Graphics  |
| 1.3.13      | 1   | TLZ10-LB 1 12/24GB 4mm DAT 5.25" HH                  |
| 1.4         | 1   | LK461-AF 1 VMS STYLE KEYBOARD, Fin/Swed              |
| 2           | 1   | DS-TZ89N-TA 1 35/70GB SE DLT-tape TT FWSE            |
| 3           | 1   | BN19C-2E 1 PowerCable 240V, C-Europe                 |
| 4           | 1   | BN38C-02 1 Ultra Cbl VHDCI - 68HD                    |

ES40 Model 1 Mini Tower System

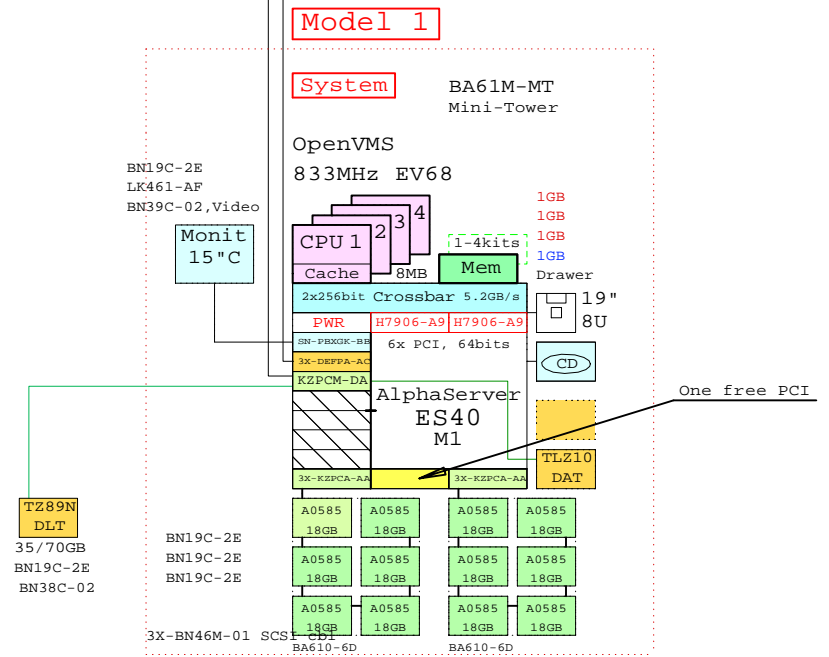

Bill of material, Model 1

| Part Number | Qty | Description   |
|-------------|-----|---|
| 1           | 1   | BA61M-MT 1 ES40 Mini-Tower Enclosure                |
| 1.1         | 1   | 3X-BN46M-01 1 SCSI cable for Tape                   |
| 1.2         | 1   | BN19C-2E 1 PowerCable 240V, C-Europe                |
| 1.3         | 1   | DY-62CAA-DA 1 ES40 68/833 Model 1 1GB OVMS 6PCI DWR |
| 1.3.1       | 1   | 3R-VROV5-24 1 COMPAQ V55 CLR MON,NH,TCO95           |
| 1.3.2       | 1   | 3X-DEPFA-AC 1 PCI to FDDI SAS MMF with SC,Universal |
| 1.3.3       | 2   | 3X-KZPCA-AA 2 Single channel LVD adapter            |
| 1.3.4       | 1   | BA610-6D 1 ES40 Disk Drive Cage, 6-Bay              |
| 1.3.4.1     | 6   | 3R-A0585-AA 6 18.2GB Uscsi3 10k Universal disk 1"   |
| 1.3.5       | 1   | BA610-6D 1 ES40 Disk Drive Cage, 6-Bay              |
| 1.3.5.1     | 6   | 3R-A0585-AA 6 18.2GB Uscsi3 10k Universal disk 1"   |
| 1.3.6       | 3   | BN19C-2E 3 PowerCable 240V, C-Europe                |
| 1.3.7       | 1   | BN39C-02 1 1.8 Video Extension Cable ****           |
| 1.3.8       | 2   | H7906-A9 2 ES40 Power Sypl, 2nd or 3rd              |
| 1.3.9       | 3   | KN610-CC 3 ES40 68/833MHz OVMS SMP 8mb cache        |
| 1.3.10      | 1   | KZPCM-DA 1 Dual Uscsi with FastEther PCI            |
| 1.3.11      | 3   | MS610-EA 3 ES40 1GB Memory Option                   |
| 1.3.12      | 1   | SN-PBXGK-BB 1 Elsa Gloria Synergy 8M Video Graphics |
| 1.3.13      | 1   | TLZ10-LB 1 12/24GB 4mm DAT 5.25" HH                 |
| 1.4         | 1   | LK461-AF 1 VMS STYLE KEYBOARD, Fin/Swed             |
| 2           | 1   | DS-TZ89N-TA 1 35/70GB SE DLT-tape TT FWSE           |
| 3           | 1   | BN19C-2E 1 PowerCable 240V, C-Europe                |
| 4           | 1   | BN38C-02 1 Ultra Cbl VHDCI - 68HD                   |

[www.Compaq.com/golden-eggs](http://www.Compaq.com/golden-eggs)  
Since:Jan-2001

|               |             |                         |
|---------------|-------------|-------------------------|
| <b>COMPAQ</b> | 30-Jan-2001 | GTAVES40A               |
|               |             | Matti.Patari@compaq.com |

AlphaServer ES40 Mini Tower  
GOLDEN EGGS Visuals, Helsinki



Ethernet  
FDDI

ES40 Model 2 Pedestal System

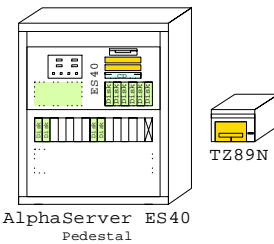
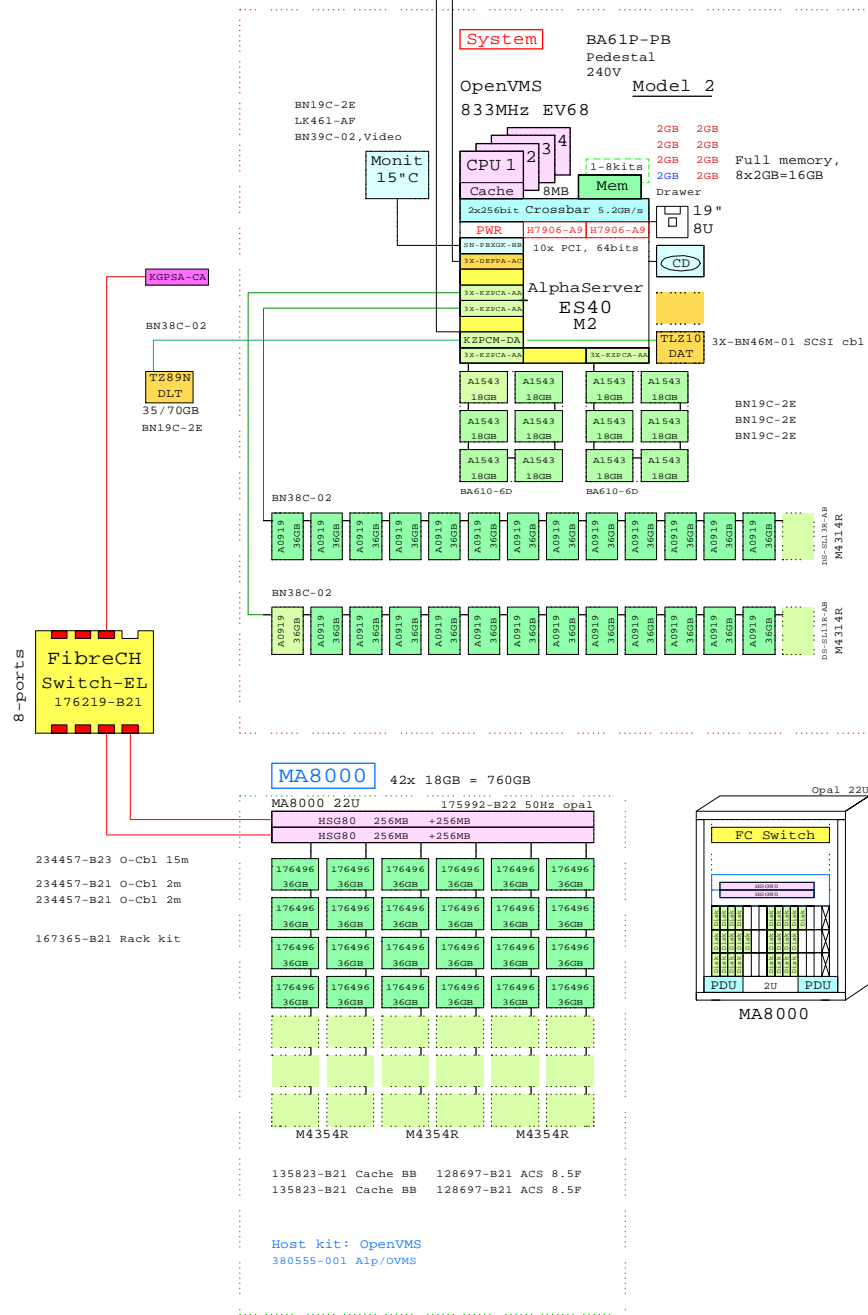

AlphaServer ES40 Pedestal  
Bill of material for the base Pedestal

| Part Number | Qty | Description  |
|-------------|-----|--|
| 1           | 1   | BA61P-PB 1 ES40 Pedestal Enclosure 240V Europe       |
| 1.1         | 1   | 3X-BN46M-01 1 SCSI cable for Tape                    |
| 1.2         | 4   | BN19C-2E 4 PowerCable 240V, C-Europe                 |
| 1.3         | 2   | BN38C-02 2 Ultra Cbl VHDCI - 68HD                    |
| 1.4         | 1   | BN39C-02 1 1.8 Video Extension Cable ****            |
| 1.5         | 1   | DS-SL13R-AB 1 Modula M4314R single buss,14x 1.0\"    |
| 1.5.1       | 13  | 3R-A0919-AA 13 36.4GB Uscsi3 10k Universal disk 1"   |
| 1.6         | 1   | DS-SL13R-AB 1 Modula M4314R single buss,14x 1.0\"    |
| 1.6.1       | 13  | 3R-A0919-AA 13 36.4GB Uscsi3 10k Universal disk 1"   |
| 1.7         | 1   | DY-64CAA-EA 1 ES40 68/833 Model 2 2GB OVMS 10PCI DWR |
| 1.7.1       | 1   | 3R-VRQV5-24 1 COMPAQ V55 CLR MON,NH,TC095            |
| 1.7.2       | 1   | 3X-DEFPAC-AA 1 PCI to FDDI SAS MMF with SC,Universal |
| 1.7.3       | 4   | 3X-KZPCA-AA 4 Single channel LVD adapter             |
| 1.7.4       | 1   | BA610-6D 1 ES40 Disk Drive Cage, 6-Bay               |
| 1.7.4.1     | 6   | 3R-A1543-AA 6 18.2GB Uscsi3 15k Universal disk 1"    |
| 1.7.5       | 1   | BA610-6D 1 ES40 Disk Drive Cage, 6-Bay               |
| 1.7.5.1     | 6   | 3R-A1543-AA 6 18.2GB Uscsi3 15k Universal disk 1"    |
| 1.7.6       | 2   | H7906-A9 2 ES40 Power Syply, 2nd or 3rd              |
| 1.7.7       | 3   | KN610-CC 3 ES40 68/833MHz OVMS SMP 8mb cache         |
| 1.7.8       | 1   | KZPCM-DA 1 Dual Uscsi with FastEther PCI             |
| 1.7.9       | 7   | MS610-EA 7 ES40 2GB Memory Option                    |
| 1.7.10      | 1   | SN-PBXGK-BB 1 Elsa Gloria Synergy 8M Video Graphics  |
| 1.7.11      | 1   | TLZ10-LB 1 12/24GB 4mm DAT 5.25\"                    |
| 1.8         | 1   | LK461-AF 1 VMS STYLE KEYBOARD, Fin/Swed              |
| 2           | 1   | DS-TZ89N-TA 1 35/70GB SE DLT-tape TT FWSE            |
| 3           | 1   | BN19C-2E 1 PowerCable 240V, C-Europe                 |
| 4           | 1   | BN38C-02 1 Ultra Cbl VHDCI - 68HD                    |

BOM for the external RA8000 RAID

| Part Number | Qty | Description                                       |
|-------------|-----|---|
| 1           | 1   | 175992-B22 1 MA8000 6x7 22U 50Hz opal             |
| 1.1         | 2   | 128697-B21 2 ACS V8.5F controller FCAL/FCSW       |
| 1.2         | 2   | 135823-B21 2 HSGxx Single external cache battery  |
| 1.3         | 24  | 176496-B22 24 36GB 10000r Ultra3 SCSI disk 1"     |
| 1.4         | 1   | 176622-B21 1 HSG80 FC Contr with 256MB cache      |
| 1.4.1       | 1   | 380674-B21 1 Cache Upg RA8k ESA12k 256MB          |
| 1.5         | 1   | 176622-B21 1 HSG80 FC Contr with 256MB cache      |
| 1.5.1       | 1   | 380674-B21 1 Cache Upg RA8k ESA12k 256MB          |
| 1.6         | 1   | 380555-001 1 OS Platf.Softw.Kit for FC Alpha OVMS |
| 2           | 1   | 176219-B21 1 SAN Switch EL 8-Ports                |
| 3           | 1   | 234457-B23 1 Fibre Channel 15m Optical Cable      |
| 4           | 1   | 167365-B21 1 Rack mount kit for SAN switch        |
| 5           | 2   | 234457-B21 2 Fibre Channel 02m Optical Cable      |
| 6           | 1   | 168794-B21 1 Host Buss Cntr KGPSA-CA,OVMS,UNIX    |

www.Compaq.com/golden-eggs  
Since:Jan-2001

|               |                         |           |
|---------------|-------------------------|-----------|
| <b>COMPAQ</b> | 30-Jan-2001             | GTAVES40B |
|               | Matti.Patari@compaq.com |           |

AlphaServer ES40 OVMS Pedestal  
GOLDEN EGGS Visuals, Helsinki

ES40 OVMS

This template is included in the present GOLDEN EGGS Software kit.

ES40 Model 2 Systems in Cabinet M15

Ethernet

FDDI

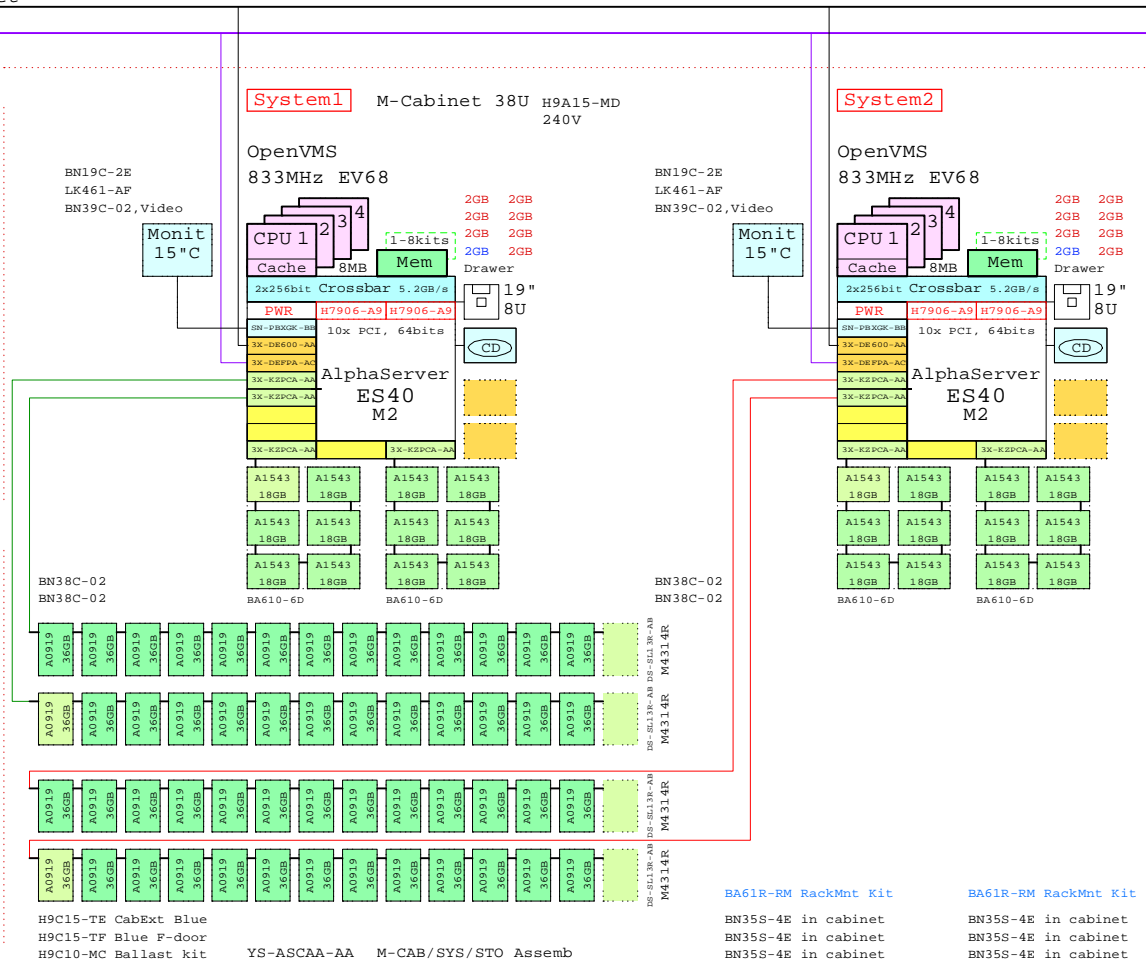

This template is included in the present GOLDEN EGGS Software kit.

Bill of material for Cabinet and System 1

| Part Number | Qty         | Description                              |
|-------------|-------------|--|
| 1           | H9A15-MD    | 1 M-Series Cab,H9A15,Blue,240V 38U       |
| 1.1         | BA61R-RM    | 1 ES40 Rackmount Kit                     |
| 1.2         | BN19C-2E    | 1 PowerCable 240V, C-Europe              |
| 1.3         | BN35S-4E    | 3 PowerCord C13 to C14, Non US           |
| 1.4         | BN38C-02    | 2 Ultra Cbl VHDCI - 68HD                 |
| 1.5         | BN39C-02    | 1 1.8 Video Extension Cable ****         |
| 1.6         | DS-SL13R-AB | 1 Modula M4314R single buss,14x 1.0" Int |
| 1.6.1       | 3R-A0919-AA | 13 36.4GB Uscsi3 10k Universal disk 1"   |
| 1.7         | DS-SL13R-AB | 1 Modula M4314R single buss,14x 1.0" Int |
| 1.7.1       | 3R-A0919-AA | 13 36.4GB Uscsi3 10k Universal disk 1"   |
| 1.8         | DY-64CAA-EA | 1 ES40 68/833 Model 2 2GB OVMS 10PCI DW  |
| 1.8.1       | 3R-VRQV5-24 | 1 COMPAQ V55 CLR MON,NH,TCO95            |
| 1.8.2       | 3X-DE600-AA | 1 10/100 1xChannel Ethernet, Twisted     |
| 1.8.3       | 3X-DEFPA-AC | 1 PCI to FDDI SAS MMF with SC,Universal  |
| 1.8.4       | 3X-KZPCA-AA | 4 Single channel LVD adapter             |
| 1.8.5       | BA610-6D    | 1 ES40 Disk Drive Cage, 6-Bay            |
| 1.8.5.1     | 3R-A1543-AA | 6 18.2GB Uscsi3 15k Universal disk 1"    |
| 1.8.6       | BA610-6D    | 1 ES40 Disk Drive Cage, 6-Bay            |
| 1.8.6.1     | 3R-A1543-AA | 6 18.2GB Uscsi3 15k Universal disk 1"    |
| 1.8.7       | H7906-A9    | 2 ES40 Power Sply, 2nd or 3rd            |
| 1.8.8       | KN610-CC    | 3 ES40 68/833MHz OVMS SMP 8mb cache      |
| 1.8.9       | MS610-EA    | 7 ES40 2GB Memory Option                 |
| 1.8.10      | SN-PBXGK-BB | 1 Elsa Gloria Synergy 8M Video Graphics  |
| 1.9         | H9C10-MC    | 1 Ballast Kit for cabinets               |
| 1.10        | H9C15-TE    | 1 Rear cab extender for H9A15 Blue       |
| 1.11        | H9C15-TF    | 1 FrontDoorKit Blue for H9A15            |
| 1.12        | LK461-AF    | 1 VMS STYLE KEYBOARD, Fin/Swed           |
| 1.13        | YS-ASCAA-AA | 1 M-CAB/SYS/STO Assembly                 |

Bill of material for System 2

| Part Number | Qty         | Description                              |
|-------------|-------------|--|
| 1           | DY-64CAA-EA | 1 ES40 68/833 Model 2 2GB OVMS 10PCI DW  |
| 1.1         | 3R-VRQV5-24 | 1 COMPAQ V55 CLR MON,NH,TCO95            |
| 1.2         | 3X-DE600-AA | 1 10/100 1xChannel Ethernet, Twisted     |
| 1.3         | 3X-DEFPA-AC | 1 PCI to FDDI SAS MMF with SC,Universal  |
| 1.4         | 3X-KZPCA-AA | 4 Single channel LVD adapter             |
| 1.5         | BA610-6D    | 1 ES40 Disk Drive Cage, 6-Bay            |
| 1.5.1       | 3R-A1543-AA | 6 18.2GB Uscsi3 15k Universal disk 1"    |
| 1.6         | BA610-6D    | 1 ES40 Disk Drive Cage, 6-Bay            |
| 1.6.1       | 3R-A1543-AA | 6 18.2GB Uscsi3 15k Universal disk 1"    |
| 1.7         | H7906-A9    | 2 ES40 Power Sply, 2nd or 3rd            |
| 1.8         | KN610-CC    | 3 ES40 68/833MHz OVMS SMP 8mb cache      |
| 1.9         | MS610-EA    | 7 ES40 2GB Memory Option                 |
| 1.10        | SN-PBXGK-BB | 1 Elsa Gloria Synergy 8M Video Graphics  |
| 2           | DS-SL13R-AB | 1 Modula M4314R single buss,14x 1.0" Int |
| 2.1         | 3R-A0919-AA | 13 36.4GB Uscsi3 10k Universal disk 1"   |
| 3           | DS-SL13R-AB | 1 Modula M4314R single buss,14x 1.0" Int |
| 3.1         | 3R-A0919-AA | 13 36.4GB Uscsi3 10k Universal disk 1"   |
| 4           | BA61R-RM    | 1 ES40 Rackmount Kit                     |
| 5           | BN35S-4E    | 3 PowerCord C13 to C14, Non US           |
| 6           | BN39C-02    | 1 1.8 Video Extension Cable ****         |
| 7           | BN19C-2E    | 1 PowerCable 240V, C-Europe              |
| 8           | BN38C-02    | 2 Ultra Cbl VHDCI - 68HD                 |
| 9           | LK461-AF    | 1 VMS STYLE KEYBOARD, Fin/Swed           |

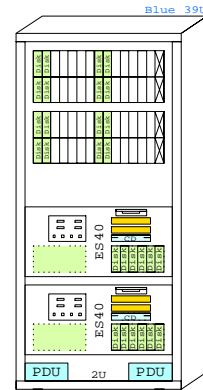

AlphaServer ES40 In H9A15 cabinet

www.Compaq.com/golden-eggs Since:Jan-2001

|               |                         |           |
|---------------|-------------------------|-----------|
| <b>COMPAQ</b> | 30-Jan-2001             | GTAVES40C |
|               | Matti.Patari@compaq.com |           |

ES40 OVMS

AlphaServer ES40 OpenVMS Cab. GOLDEN EGGS Visuals, Helsinki

# ES40 Model 2 OpenVMS Cluster with external storage

Ethernet

FDDI

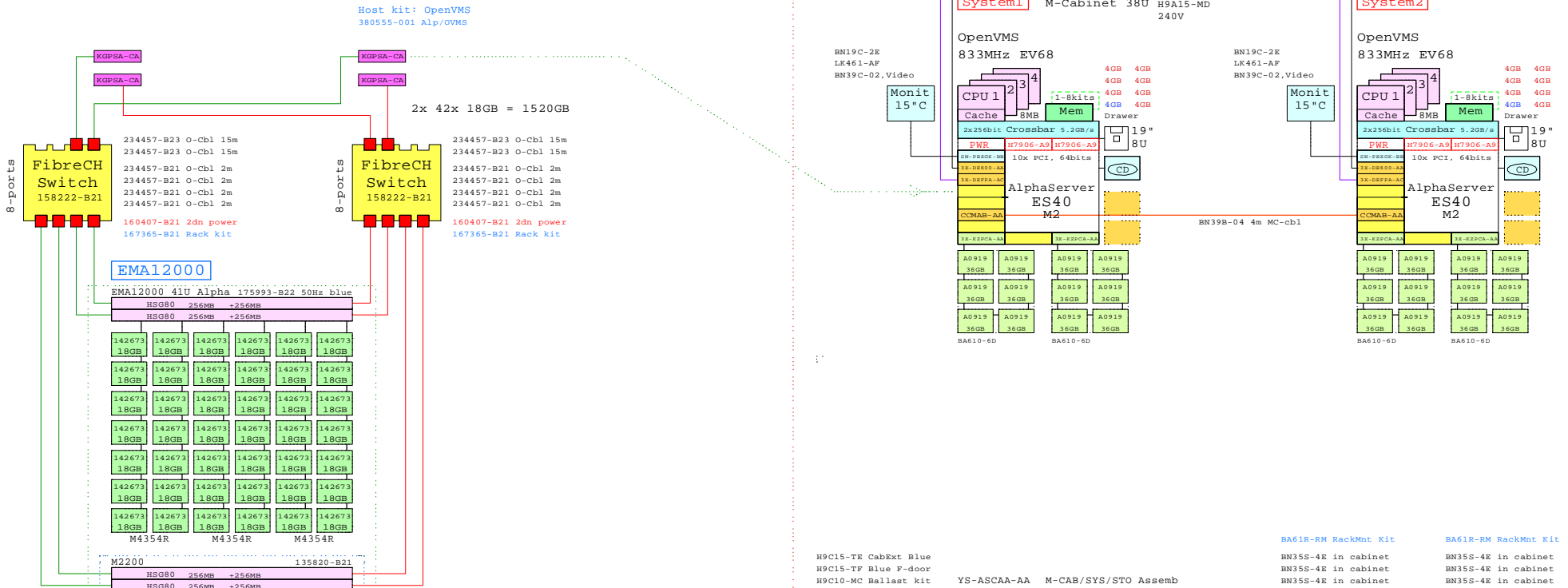

### BOM of External Storage

| Part Number | Qty | Description                                       |
|-------------|-----|---|
| 1           | 1   | 175993-B22 1 EMA12000 6x7 41U 50Hz blue           |
| 1.1         | 2   | 128697-B21 2 ACS V8.5F controller FCAL/PCSW       |
| 1.2         | 1   | 135820-B21 1 Module M2200 shelf, NO controller    |
| 1.2.1       | 2   | 128697-B21 2 ACS V8.5F controller FCAL/PCSW       |
| 1.2.2       | 2   | 135823-B21 2 HSGKX Single external cache battery  |
| 1.2.3       | 6   | 168256-B21 6 SCSI cable VHDCI-VHDCI, 1m           |
| 1.2.4       | 1   | 176622-B21 1 HSG80 FC Contr with 256MB cache      |
| 1.2.4.1     | 1   | 380674-B21 1 Cache Upg RARk ESA12k 256MB          |
| 1.2.5       | 1   | 176622-B21 1 HSG80 FC Contr with 256MB cache      |
| 1.2.5.1     | 1   | 380674-B21 1 Cache Upg RARk ESA12k 256MB          |
| 1.2.6       | 1   | 190211-B31 1 Modula M4354R dual buss, 7+7, 1.0"   |
| 1.2.6.1     | 8   | 18.20B 10000r Ultra3 SCSI disk 1"                 |
| 1.2.7       | 1   | 190211-B31 1 Modula M4354R dual buss, 7+7, 1.0"   |
| 1.2.7.1     | 8   | 18.20B 10000r Ultra3 SCSI disk 1"                 |
| 1.2.8       | 1   | 190211-B31 1 Modula M4354R dual buss, 7+7, 1.0"   |
| 1.2.8.1     | 9   | 18.20B 10000r Ultra3 SCSI disk 1"                 |
| 1.3         | 2   | 135823-B21 2 HSGKX Single external cache battery  |
| 1.4         | 42  | 18.20B 10000r Ultra3 SCSI disk 1"                 |
| 1.5         | 1   | 176622-B21 1 HSG80 FC Contr with 256MB cache      |
| 1.5.1       | 1   | 380674-B21 1 Cache Upg RARk ESA12k 256MB          |
| 1.6         | 1   | 176622-B21 1 HSG80 FC Contr with 256MB cache      |
| 1.6.1       | 1   | 380674-B21 1 Cache Upg RARk ESA12k 256MB          |
| 2           | 1   | 158222-B21 1 SAN Switch 8 Ports                   |
| 2.1         | 6   | 380561-B21 6 FC Optical Short Wave GRIC 500       |
| 158222-B21  | 1   | SAN Switch 8 Ports                                |
| 3.1         | 6   | 380561-B21 6 FC Optical Short Wave GRIC 500       |
| 4           | 2   | 160407-B21 2 SAN switch redundant power supply    |
| 5           | 4   | 234457-B21 4 Fibre Channel 15m Optical Cable      |
| 6           | 1   | 167365-B21 2 Rack mount kit for SAN switch        |
| 7           | 8   | 234457-B21 8 Fibre Channel 15m Optical Cable      |
| 8           | 1   | 380555-001 1 OS Platf Softw Kit for FC Alpha OVMS |
| 9           | 4   | 168794-B21 4 Host Bus Cntr KQPSA-CA,OVMS,UNIX     |

### BOM of Dual ES40 Cabinet

| Part Number | Qty | Description  |
|-------------|-----|--|
| 1           | 1   | H9A15-MD 1 M-Series Cab,H9A15,Blue,240V 38U          |
| 1.1         | 2   | BA61R-RM 2 ES40 Rackmount Kit                        |
| 1.2         | 2   | PowerCable 240V, C-Europe                            |
| 1.3         | 6   | BN35S-4E 6 PowerCord c13 to c14, Rom US              |
| 1.4         | 1   | BN39B-04 1 04m copper cbl for CCMAB Mem,Chan         |
| 1.5         | 2   | BN39C-02 2 1.8 Video Extension Cable ***             |
| 1.6         | 1   | DV-64CAA-FA 1 ES40 68/833 Model 2 4GB OVMS 10PCI DWR |
| 1.6.1       | 1   | 3R-VRQV5-24 1 COMPAQ V55 CLR MEM,NH,TC095            |
| 1.6.2       | 1   | 3X-DEPPA-AA 1 10/100 1xChannel Ethernet, Twisted     |
| 1.6.3       | 1   | 3X-DEPPA-AA 1 PCI to FDDI SAS MMF with SC/Universal  |
| 1.6.4       | 2   | 3X-KZPCA-AA 2 Single channel LVD adapter             |
| 1.6.5       | 1   | BA610-6D 1 ES40 Disk Drive Cage, 6-Bay               |
| 1.6.5.1     | 6   | 36.4GB Uscsi3 10K Universal disk 1"                  |
| 1.6.6       | 1   | BA610-6D 1 ES40 Disk Drive Cage, 6-Bay               |
| 1.6.6.1     | 6   | 36.4GB Uscsi3 10K Universal disk 1"                  |
| 1.6.7       | 1   | CCMAB-AA 1 PCI Mem, Channel-2 Cluster cntrl          |
| 1.6.8       | 3   | H7906-AA 3 ES40 Power Supply, 2nd or 3rd             |
| 1.6.9       | 2   | RN610-CC 2 ES40 4GB Memory Option                    |
| 1.6.10      | 7   | MS610-FA 7 ES40 4GB Memory Option                    |
| 1.6.11      | 1   | SN-PBXKX-BB 1 Elpa Gloria Synergy 8M Video Graphics  |
| 1.7         | 1   | DV-64CAA-FA 1 ES40 68/833 Model 2 4GB OVMS 10PCI DWR |
| 1.7.1       | 1   | 3R-VRQV5-24 1 COMPAQ V55 CLR MEM,NH,TC095            |
| 1.7.2       | 1   | 3X-DEPPA-AA 1 10/100 1xChannel Ethernet, Twisted     |
| 1.7.3       | 1   | 3X-DEPPA-AA 1 PCI to FDDI SAS MMF with SC/Universal  |
| 1.7.4       | 2   | 3X-KZPCA-AA 2 Single channel LVD adapter             |
| 1.7.5       | 1   | BA610-6D 1 ES40 Disk Drive Cage, 6-Bay               |
| 1.7.5.1     | 6   | 36.4GB Uscsi3 10K Universal disk 1"                  |
| 1.7.6       | 1   | BA610-6D 1 ES40 Disk Drive Cage, 6-Bay               |
| 1.7.6.1     | 6   | 36.4GB Uscsi3 10K Universal disk 1"                  |
| 1.7.7       | 1   | CCMAB-AA 1 PCI Mem, Channel-2 Cluster cntrl          |
| 1.7.8       | 2   | H7906-AA 2 ES40 Power Supply, 2nd or 3rd             |
| 1.7.9       | 2   | RN610-CC 2 ES40 4GB Memory Option                    |
| 1.7.10      | 7   | MS610-FA 7 ES40 4GB Memory Option                    |
| 1.7.11      | 1   | SN-PBXKX-BB 1 Elpa Gloria Synergy 8M Video Graphics  |
| 1.8         | 1   | H9C10-MC 1 Ballast Kit for cabinets                  |
| 1.9         | 1   | H9C15-TE 1 Rear cab extender for H9A15 Blue          |
| 1.10        | 1   | H9C15-TF 1 FrontDoorKit Blue for H9A15               |
| 1.11        | 2   | LK461-AF 2 VMS STYLE KEYBOARD, Pin/Swed              |
| 1.12        | 1   | YS-ASCAA-AA 1 M-CAB/SYS/STO Assembly                 |

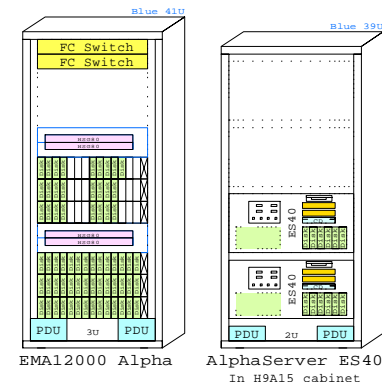

[www.compaq.com/golden-eggs](http://www.compaq.com/golden-eggs)  
Since 12-Jan-2001

**COMPAQ** 30-Jan-2001 GTAVES40D  
Matti.Patari@compaq.com

**ES40** OVMS AlphaServer ES40 OpenVMS Clust  
GOLDEN EGGS Visuals, Helsinki

This template is included in the present GOLDEN EGGS Software kit.

Optional External Fibre Channel Storage

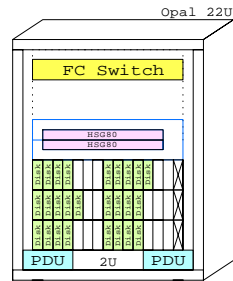

MA8000

MA8000 42x 18GB = 760GB

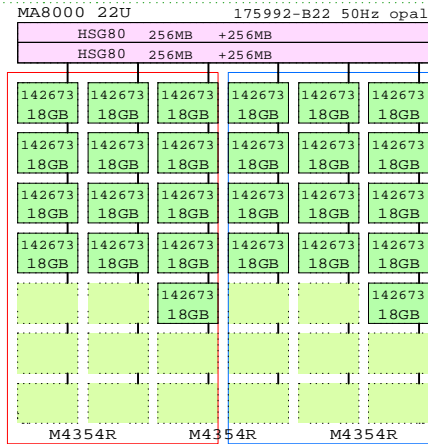

135823-B21 Cache BB 128697-B21 ACS 8.5F  
135823-B21 Cache BB 128697-B21 ACS 8.5F

BOM for External Storage

| Part Number | Qty | Description                                       |
|-------------|-----|---|
| 1           | 1   | 175992-B22 1 MA8000 6x7 22U 50Hz opal             |
| 1.1         | 2   | 128697-B21 2 ACS V8.5F controller FCAL/FCSW       |
| 1.2         | 2   | 135823-B21 2 HSGxx Single external cache battery  |
| 1.3         | 26  | 142673-B22 26 18.2GB 10000r Ultra3 SCSI disk 1"   |
| 1.4         | 1   | 176622-B21 1 HSG80 FC Contr with 256MB cache      |
| 1.4.1       | 1   | 380674-B21 1 Cache Upg RA8k ESA12k 256MB          |
| 1.5         | 1   | 176622-B21 1 HSG80 FC Contr with 256MB cache      |
| 1.5.1       | 1   | 380674-B21 1 Cache Upg RA8k ESA12k 256MB          |
| 2           | 1   | 158222-B21 1 SAN Switch 8 Ports                   |
| 2.1         | 4   | 380561-B21 4 FC Optical Short Wave GBIC           |
| 3           | 1   | 160407-B21 1 SAN switch redundant power supply    |
| 4           | 1   | 167365-B21 1 Rack mount kit for SAN switch        |
| 5           | 4   | 234457-B21 4 Fibre Channel 02m Optical Cable      |
| 6           | 1   | 380555-001 1 OS Platf.Softw.Kit for FC Alpha OVMS |
| 7           | 2   | 168794-B21 2 Host Buss Cntr KGPSA-CA,OVMS,UNIX    |

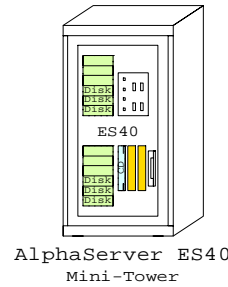

AlphaServer ES40 Mini-Tower

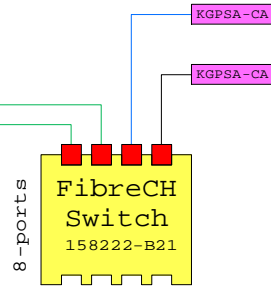

234457-B21 O-Cbl 2m  
234457-B21 O-Cbl 2m  
234457-B21 O-Cbl 2m  
234457-B21 O-Cbl 2m  
160407-B21 2dn power  
167365-B21 Rack kit  
Host kit: OpenVMS  
380555-001 Alp/OVMS

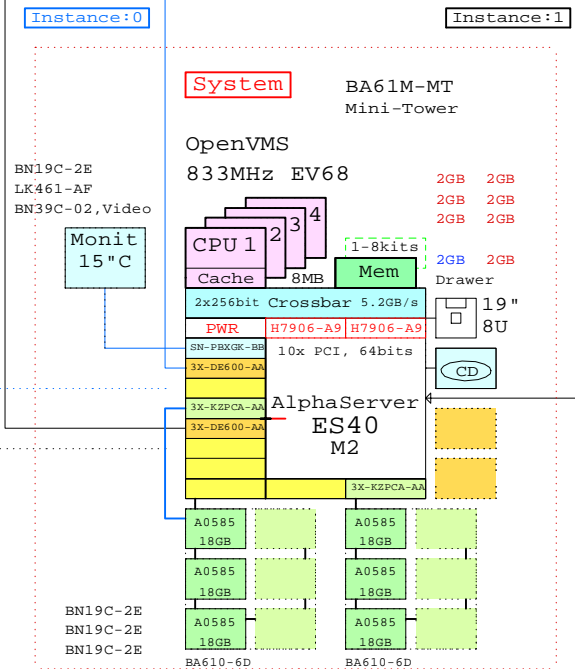

BOM for Instance: 0

| Part Number | Qty | Description  |
|-------------|-----|--|
| 1           | 1   | BA61M-MT ES40 Mini-Tower Enclosure                 |
| 1.1         | 1   | BN19C-2E PowerCable 240V, C-Europe                 |
| 1.2         | 1   | DY-64CAA-EA ES40 68/833 Model 2 2GB OVMS 10PCI DWR |
| 1.2.1       | 1   | 3R-VRQV5-24 COMPAQ V55 CLR MON,NH,TC095            |
| 1.2.2       | 1   | 3X-DE600-AA 10/100 1xChannel Ethernet, Twisted     |
| 1.2.3       | 1   | 3X-KZPCA-AA Single channel LVD adapter             |
| 1.2.4       | 1   | BA610-6D ES40 Disk Drive Cage, 6-Bay               |
| 1.2.4.1     | 3   | 3R-A0585-AA 18.2GB Uscsi3 10k Universal disk 1"    |
| 1.2.5       | 1   | BN19C-2E PowerCable 240V, C-Europe                 |
| 1.2.6       | 1   | BN39C-02 1.8 Video Extension Cable ****            |
| 1.2.7       | 1   | SN-PBXGK-BB Elsa Gloria Synergy 8M Video Graphics  |
| 1.3         | 1   | LK461-AF VMS STYLE KEYBOARD, Fin/Swed              |

BOM for Instance: 1

| Part Number | Qty | Description                                     |
|-------------|-----|---|
| 1           | 1   | BA610-6D ES40 Disk Drive Cage, 6-Bay            |
| 1.1         | 3   | 3R-A0585-AA 18.2GB Uscsi3 10k Universal disk 1" |
| 2           | 3   | KN610-CC ES40 6/833MHz OVMS SMP 8mb cache       |
| 3           | 1   | 3X-DE600-AA 10/100 1xChannel Ethernet, Twisted  |
| 4           | 1   | 3X-KZPCA-AA Single channel LVD adapter          |
| 5           | 2   | H7906-A9 ES40 Power Syplly, 2nd or 3rd          |
| 6           | 2   | BN19C-2E PowerCable 240V, C-Europe              |
| 7           | 7   | MS610-EA ES40 2GB Memory Option                 |

www.Compaq.com/golden-eggs Since:Nov-2000

**COMPAQ** 30-Jan-2001 GTAVES40E  
Matti.Patari@compaq.com

ES40 OVMS

Alpha ES40 with OpenVMS/Galaxy  
GOLDEN EGGS Visuals, Helsinki

Ethernet

AlphaServer ES40 with OpenVMS/Galaxy

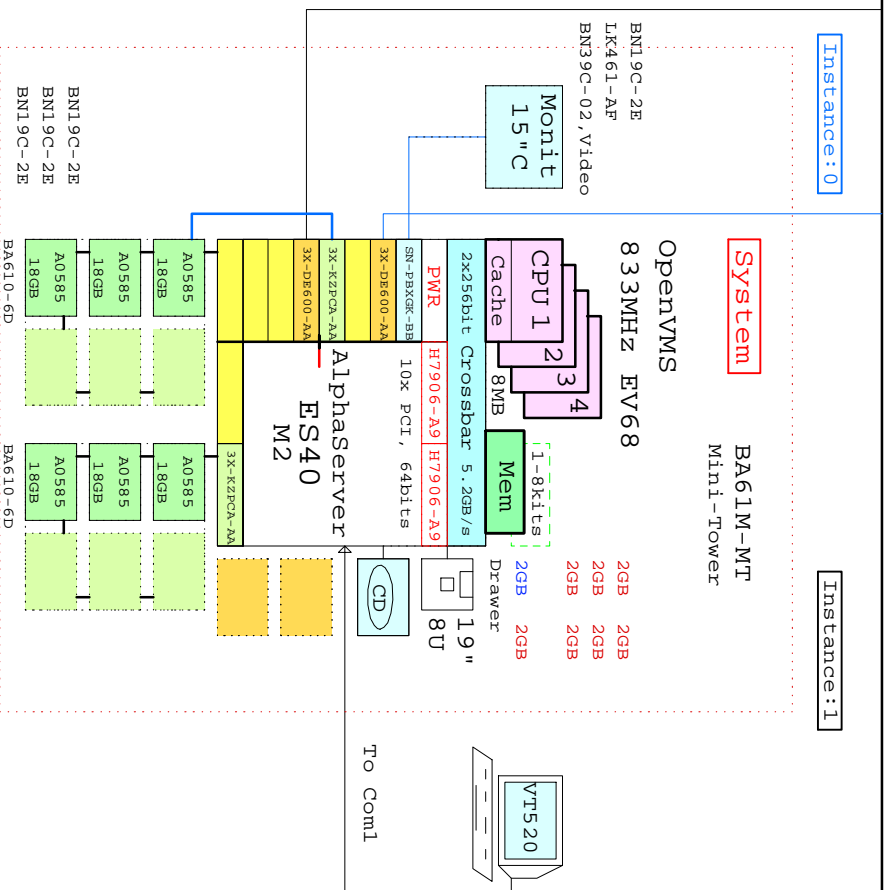

AlphaServer ES40 Mini-Tower

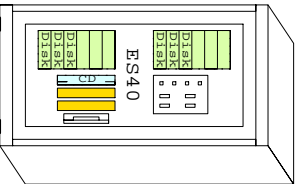

BOM for Instance: 0

| Part Number | Qty | Description                             |
|-------------|-----|---|
| BA61M-MT    | 1   | ES40 Mini-Tower Enclosure               |
| BN19C-2E    | 1   | PowerCable 240V, C-Europe               |
| DY-64CAA-EA | 1   | ES40 68/833 Model1 2 2GB OVMS 10PCI DWR |
| 3R-VRQV5-24 | 1   | COMPAQ V55 CLR MON/NH/TC095             |
| 3X-DE600-AA | 1   | 10/100 1xChannel Ethernet, Twisted      |
| 3X-KZPCA-AA | 1   | Single channel IVD adapter              |
| BA610-6D    | 1   | ES40 Disk Drive Cage, 6-Bay             |
| 3R-A0585-AA | 3   | 18.2GB Uscs13 10K Universal disk 1"     |
| BN19C-2E    | 1   | PowerCable 240V, C-Europe               |
| BN39C-02    | 1   | 1.8 Video Extension Cable *****         |
| SN-PBXGK-BB | 1   | Lisa Gloria Synergy 8M Video Graphics   |
| LK461-AF    | 1   | VMS STYLE KEYBOARD, Fin/Swed            |

BOM for Instance: 1

| Part Number | Qty | Description                         |
|-------------|-----|-------------------------------------|
| BA610-6D    | 1   | ES40 Disk Drive Cage, 6-Bay         |
| 3R-A0585-AA | 3   | 18.2GB Uscs13 10K Universal disk 1" |
| KN610-CC    | 3   | ES40 6/833MHz OVMS SMP 8mb cache    |
| 3X-DE600-AA | 1   | 10/100 1xChannel Ethernet, Twisted  |
| 3X-KZPCA-AA | 1   | Single channel IVD adapter          |
| H7906-A9    | 2   | ES40 Power Syply, 2nd or 3rd        |
| BN19C-2E    | 2   | PowerCable 240V, C-Europe           |
| MS610-EA    | 7   | ES40 2GB Memory Option              |

www.compaq.com/golden-eggs

Since:Nov-2000

**COMPAQ** 30-Jan-2001 GTAVES40E  
Matti.Patari@compaq.com

ES40 OVMS

Alpha ES40 with OpenVMS/Galaxy  
GOLDEN EGGS Visuals, Helsinki

AlphaServer ES40 with OpenVMS/Galaxy

Ethernet

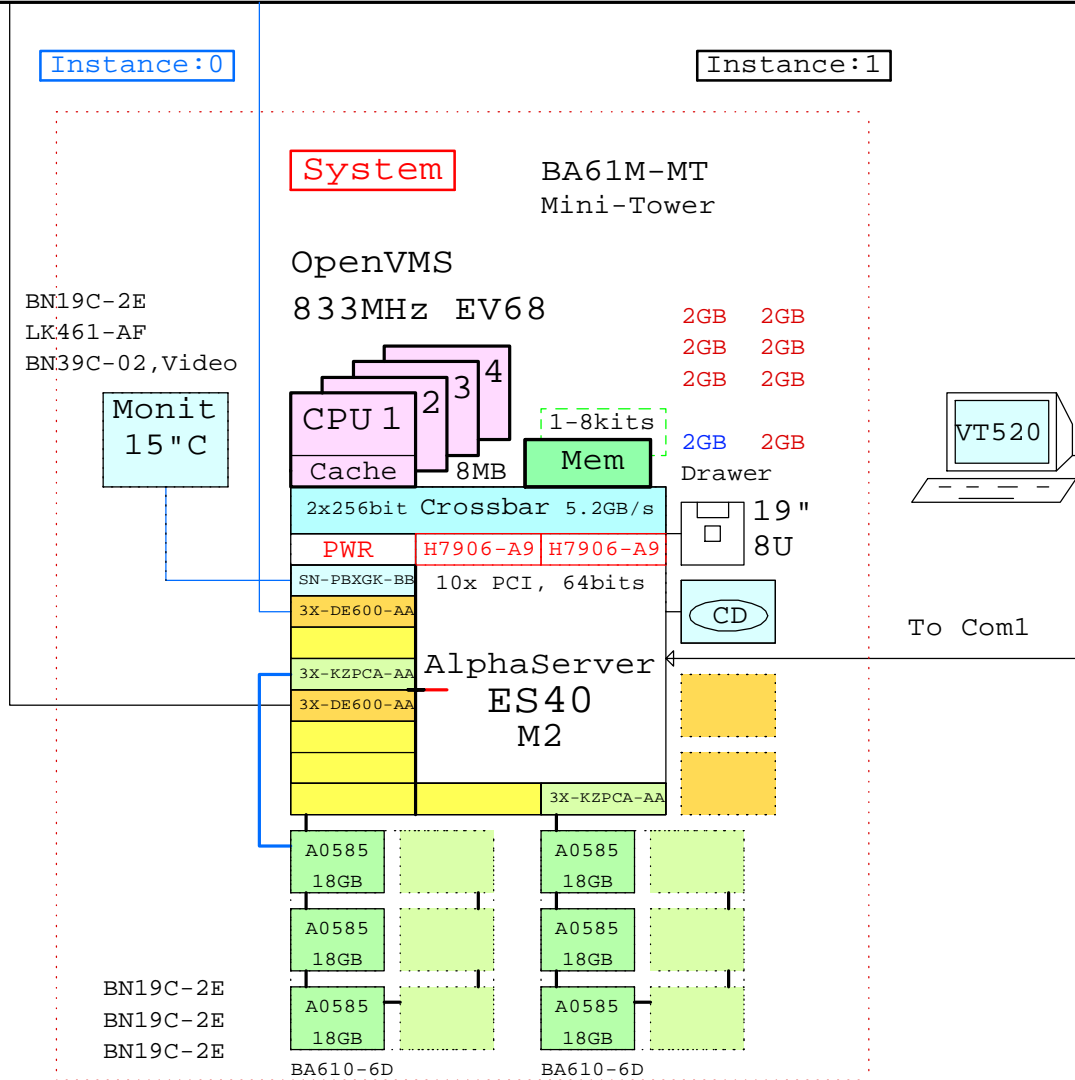

Ethernet

ES40 Model 1 Pedestal System

ES40 Model 1 Mini Tower System

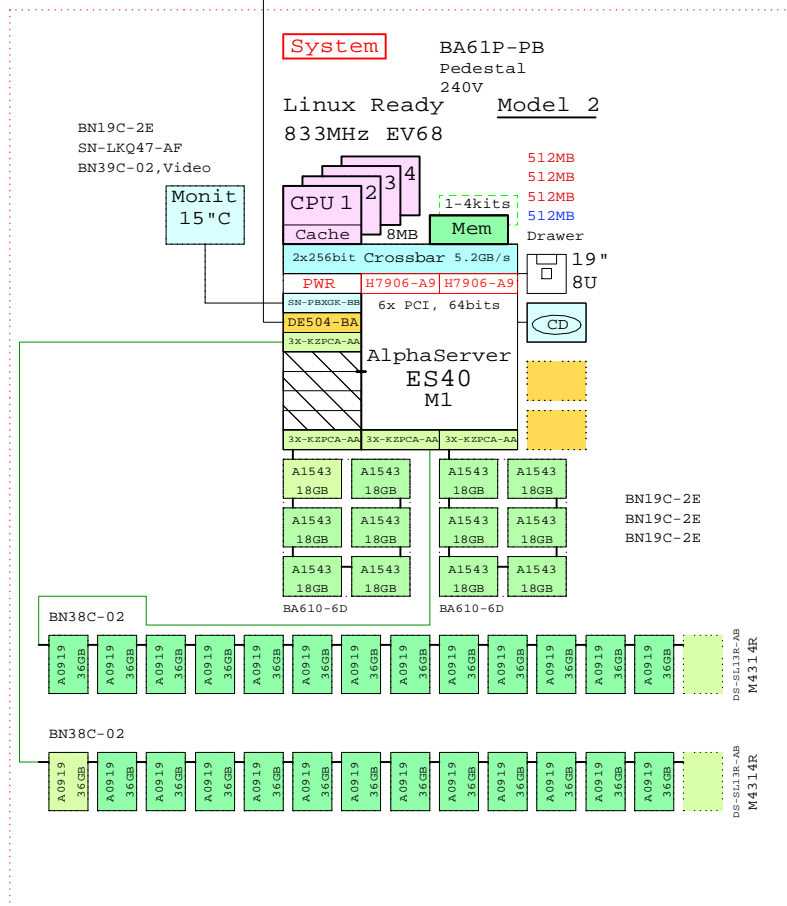

Gigabit Ethernet

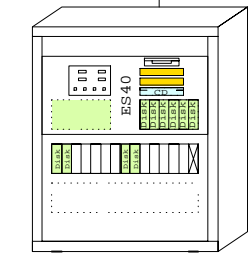

AlphaServer ES40 Pedestal

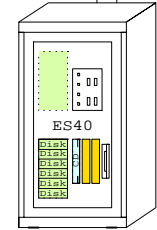

AlphaServer ES40 Mini-Tower

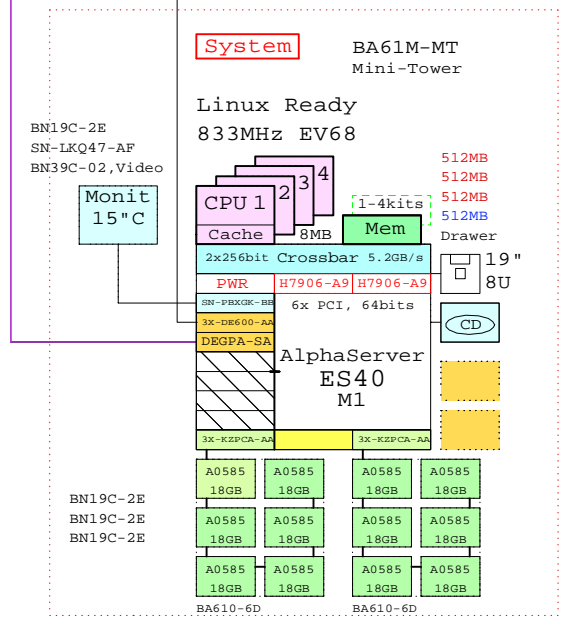

| Part Number | Qty | Description  |
|-------------|-----|--|
| 1           | 1   | BA61P-PB 1 ES40 Pedestal Enclosure 240V Europe         |
| 1.1         | 4   | BN19C-2E PowerCable 240V, C-Europe                     |
| 1.2         | 2   | BN38C-02 Ultra Cbl VHDCI - 68HD                        |
| 1.3         | 1   | BN39C-02 1.8 Video Extension Cable ****                |
| 1.4         | 1   | DJ-62CAA-CA 1 ES40 68/833 Model 1 512MB LinuxReady 6PC |
| 1.4.1       | 1   | 3R-VROV5-24 1 COMPAQ V55 CLR MON,NH,TCO95              |
| 1.4.2       | 4   | 3X-KZPCA-AA Single channel LVD adapter                 |
| 1.4.3       | 1   | BA610-6D 1 ES40 Disk Drive Cage, 6-Bay                 |
| 1.4.3.1     | 6   | 3R-A1543-AA 6 18.2GB Uscsi3 15k Universal disk 1"      |
| 1.4.4       | 1   | BA610-6D 1 ES40 Disk Drive Cage, 6-Bay                 |
| 1.4.4.1     | 6   | 3R-A1543-AA 6 18.2GB Uscsi3 15k Universal disk 1"      |
| 1.4.5       | 1   | DE504-BA 1 PCI 10/100 MbitX4 ETHNT ALPHA               |
| 1.4.6       | 2   | H7906-A9 2 ES40 Power Syplly, 2nd or 3rd               |
| 1.4.7       | 3   | KN610-CA 3 ES40 68/833MHz SMP 8mb cache                |
| 1.4.8       | 3   | MS610-CA 3 ES40 512MB Memory Option                    |
| 1.4.9       | 1   | SN-PBXGK-BB 1 Elsa Gloria Synergy 8M Video Graphics    |
| 1.5         | 1   | DS-SL13R-AB 1 Modula M4314R single buss,14x 1.0" Int   |
| 1.5.1       | 13  | 3R-A0919-AA 13 36.4GB Uscsi3 10k Universal disk 1"     |
| 1.6         | 1   | DS-SL13R-AB 1 Modula M4314R single buss,14x 1.0" Int   |
| 1.6.1       | 13  | 3R-A0919-AA 13 36.4GB Uscsi3 10k Universal disk 1"     |
| 1.7         | 1   | SN-LKQ47-AF 1 102 KEY KYBD,NON-WIN, Finnish            |

| Part Number | Qty | Description  |
|-------------|-----|--|
| 1           | 1   | BA61M-MT 1 ES40 Mini-Tower Enclosure                   |
| 1.1         | 1   | BN19C-2E PowerCable 240V, C-Europe                     |
| 1.2         | 1   | DJ-62CAA-CA 1 ES40 68/833 Model 1 512MB LinuxReady 6PC |
| 1.2.1       | 1   | 3R-VROV5-24 1 COMPAQ V55 CLR MON,NH,TCO95              |
| 1.2.2       | 1   | 3X-DE600-AA 1 10/100 1xChannel Ethernet, Twisted       |
| 1.2.3       | 2   | 3X-KZPCA-AA Single channel LVD adapter                 |
| 1.2.4       | 1   | BA610-6D 1 ES40 Disk Drive Cage, 6-Bay                 |
| 1.2.4.1     | 6   | 3R-A0585-AA 6 18.2GB Uscsi3 10k Universal disk 1"      |
| 1.2.5       | 1   | BA610-6D 1 ES40 Disk Drive Cage, 6-Bay                 |
| 1.2.5.1     | 6   | 3R-A0585-AA 6 18.2GB Uscsi3 10k Universal disk 1"      |
| 1.2.6       | 3   | BN19C-2E PowerCable 240V, C-Europe                     |
| 1.2.7       | 1   | BN39C-02 1.8 Video Extension Cable ****                |
| 1.2.8       | 1   | DEGPA-SA 1 PCI to GigabitEthernet SX Adap              |
| 1.2.9       | 2   | H7906-A9 2 ES40 Power Syplly, 2nd or 3rd               |
| 1.2.10      | 3   | KN610-CA 3 ES40 68/833MHz SMP 8mb cache                |
| 1.2.11      | 3   | MS610-CA 3 ES40 512MB Memory Option                    |
| 1.2.12      | 1   | SN-PBXGK-BB 1 Elsa Gloria Synergy 8M Video Graphics    |
| 1.3         | 1   | SN-LKQ47-AF 1 102 KEY KYBD,NON-WIN, Finnish            |

www.Compaq.com/golden-eggs Since Jan-2001

**COMPAQ** 30-Jan-2001 GTALES40A Matti.Patari@compaq.com

ES40 Linux Golden Eggs Visuals, Helsinki

This template is included in the present GOLDEN EGGS Software kit.