











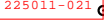

Internal Options:

-  201099-B21
2nd CPU
1400MHz
-  201692-B21
256MB
-  201693-B21
512MB
-  201694-B21
1GB
-  201695-B21
2GB
-  225011-021
2dn power
-  225012-B21
Fan kit
-  142673-B22
18GB 10k
-  188122-B22
18GB 15k
-  176496-B22
36GB 10k
-  232432-B22
72GB 10k
-  215487-B21
AIT 50G
-  157866-021
Lights out mgr
33MHz
-  158575-B21
NC7131 Gigabit
64-bit/66MHz
-  158939-B21
Smart Array 5304/128
64-Bit/66MHz
-  176479-B21
FibreChannel adapter
64-bit/33MHz

To Fibre Channel Storage

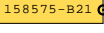
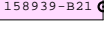
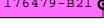
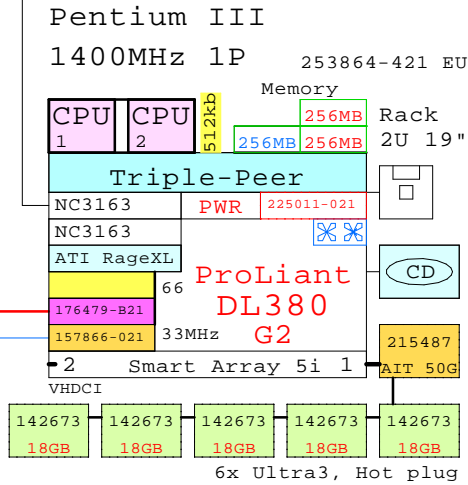

-2x RJ-45

- ATI Rage XL 8MB
- 64bit/66MHz Hot Plug
- 64bit/66MHz Hot Plug
- 64bit/33MHz Non HP

1400Mhz

Pentium III FC-PGA2
1400MHz 1P 253864-421 EU

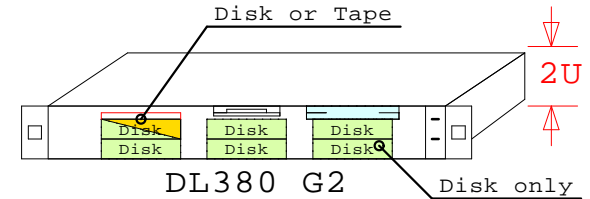
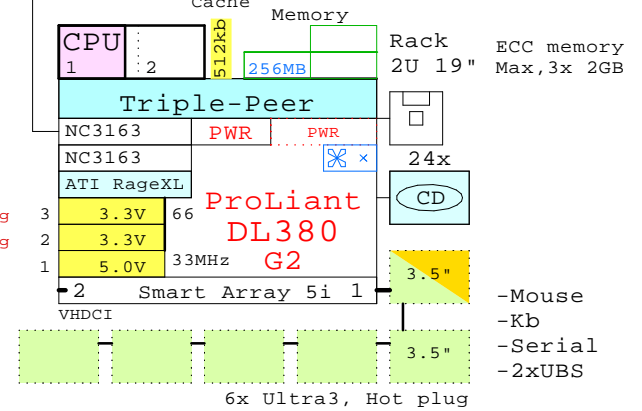

BOM of the system above

	Part Number	Qty	Description
1	253864-421	1	ProLiant DL380 G2 1400MHz 256MB rack 2U
1.1	142673-B22	5	18.2GB 10000r Ultra3 SCSI disk 1"
1.2	157866-021	1	CPQ Remote Insight manager kit
1.3	176479-B21	1	Host Buss Cntrl KGPSA-CB,NT only
1.4	201099-B21	1	Pentium III P1400-512kb processor kit
1.5	201692-B21	2	256MB 133MHz ECC SDRAM (2x128MB)
1.6	215487-B21	1	50/100GB Hot plug AIT tape drive
1.7	225011-021	1	DL380R02 second power supply
1.8	225012-B21	1	Hot plug blower option kit, 3x fans

www.Compaq.com/golden-eggs

Since:Jan-200

COMPAQ

31-Jan-2002 GEIDL380b

Matti.Patari@compaq.com

ProLiant DL380 G2 sys. 1400Mhz
GOLDEN EGGS Visuals, Helsinki