









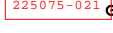

Internal Options:

-  257915-B21
2nd CPU
2800MHz
-  300678-B21
-  300679-B21
-  300680-B21
-  300682-B21
-  225075-021
2dn power supply
-  225073-B21
Fan kit
-  286775-B22
18GB 15k U320
-  286776-B22
36GB 15k U320
-  286778-B22
72GB 15k U320
-  286716-B22
146GB 10k U320
-  157766-B21
AIT 50G
157766
-  244948-B21
NC7770 Gigabit
PCI-X
-  138603-B21
NC3134 FastE.
Dual Channel
-  283552-B21
Smart Array
5302/128
-  283551-B21
Smart Array
5304/256
-  245299-B21
FibreChannel HBA
2Gb/s FCA2101

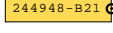
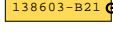
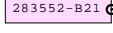
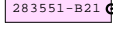
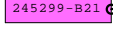
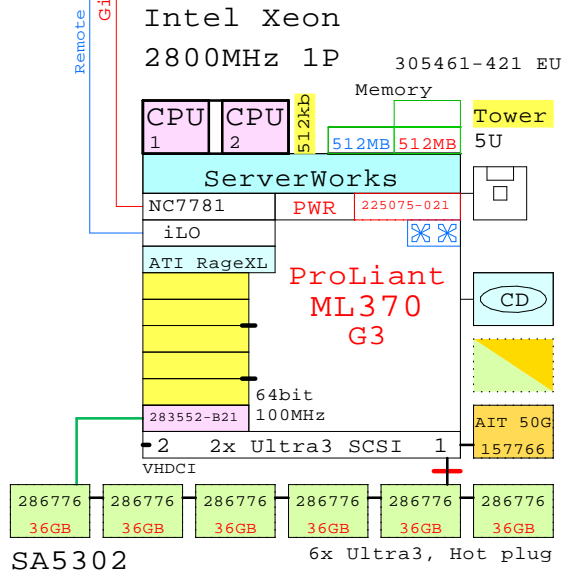

BOM of the 2800MHz-512k 512MB 1P tower system above

Part Number	Qty	Description
1	305461-421	1 ProLiant ML370 G3 2800MHz 512MB Tower 5U
1.1	157766-B21	1 50GB AIT tape drive, Internal
1.2	225073-B21	1 ML370 Hot plug blower kit, 2x fans
1.3	225075-021	1 ML370 G2 second power supply
1.4	257915-B21	1 Intel Xeon 2800-512kb processor kit
1.5	283552-B21	1 Smart Array 5302/128MB,Ultra3 2-chan
1.6	286776-B22	6 36GB 15000r U320 disk 1"
1.7	300678-B21	1 512MB ECC PC2100 DDR DIMM kit (2x256MB)

Part numbers for 2400MHz options

Part Number	Qty	Description
1	257919-421	1 ProLiant ML370 G3 2400MHz 512MB Tower 5U
1.1	257913-B21	1 Intel Xeon 2400-512kb processor kit

For more detailed configuring, please consult the latest HP QuickSpecs.
Generated with fresh GOLDEN EGGS Software, Rev:14-Jan-2003

ML370 2P

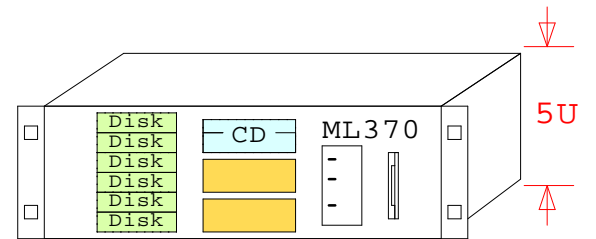
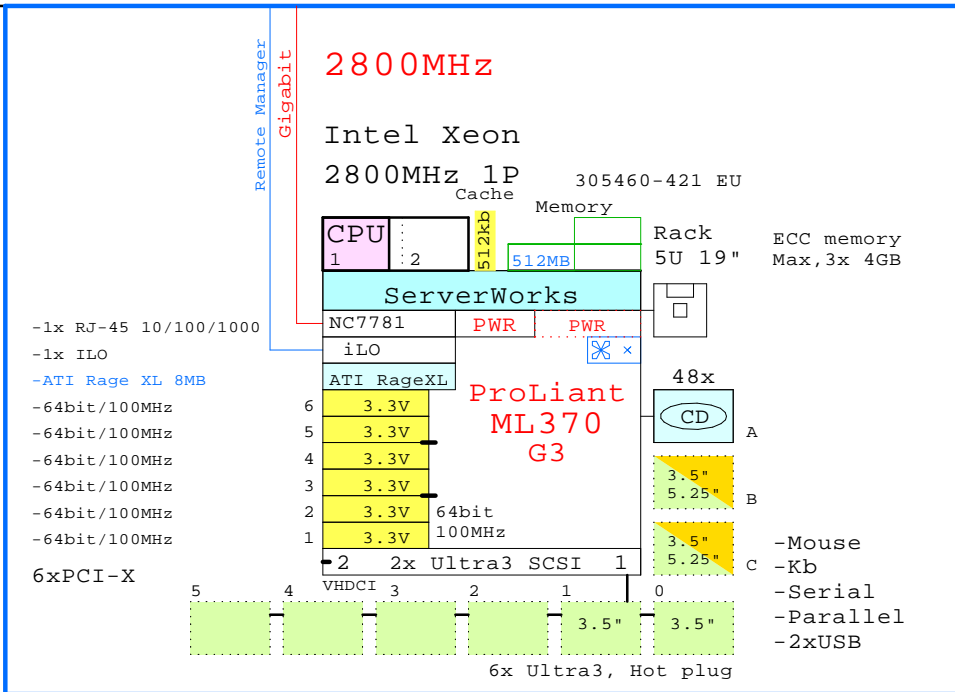

ML370 G3

www.Compaq.com/golden-eggs

Since: Sep-2002

	16-Jan-2003	GEIML370G3a
	Matti.Patari@hp.com	
ProLiant ML370 G3 System 2800MHz GOLDEN EGGS Visuals, Helsinki		