









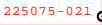

Internal Options:

-  257913-B21
2nd CPU
2400MHz
-  300678-B21
-  300679-B21
-  300680-B21
-  300682-B21
-  225075-021
2dn power
-  225073-B21
Fan kit
-  142673-B22
18GB
10k
-  188122-B22
18GB
15k
-  176496-B22
36GB
10k
-  232432-B22
72GB
10k
-  157766-B21
-  138603-B21
NC3134 FastE.
Dual Channel
-  158939-B21
Smart Array 5304/128
64-Bit/66MHz
-  176479-B21
FibreChannel adapter
64-bit/33MHz

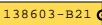
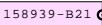
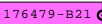
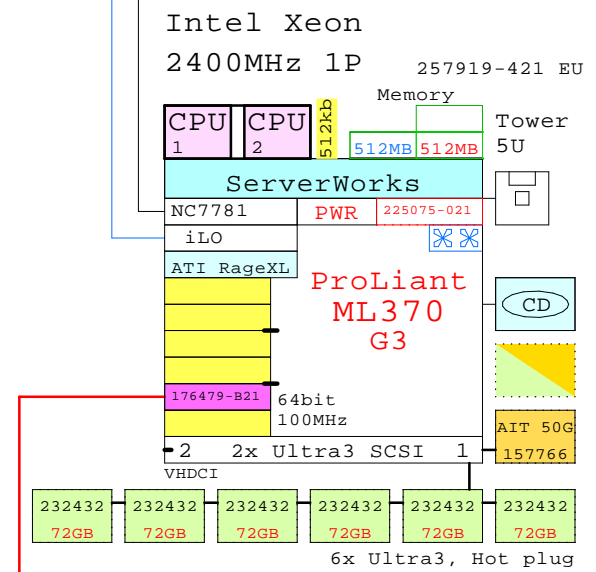

To Fibre Channel Storage

BOM of the system above

Part Number	Qty	Description
1 257919-421	1	ProLiant ML370 G3 2400MHz 512MB Tower 5U
1.1 157766-B21	1	50GB AIT tape drive, Internal
1.2 176479-B21	1	Host Buss Cntrl KGPSA-CB,NT only
1.3 225073-B21	1	ML370 Hot plug blower kit, 2x fans
1.4 225075-021	1	ML370 G2 second power supply
1.5 232432-B22	6	72.8GB 10000r Ultra3 SCSI disk 1"
1.6 257913-B21	1	Intel Xeon 2400-512kb processor kit
1.7 300678-B21	1	512MB ECC PC2100 DDR DIMM kit (2x256MB)

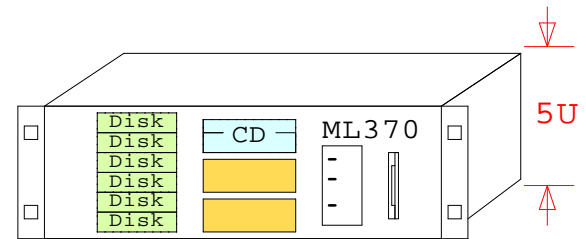
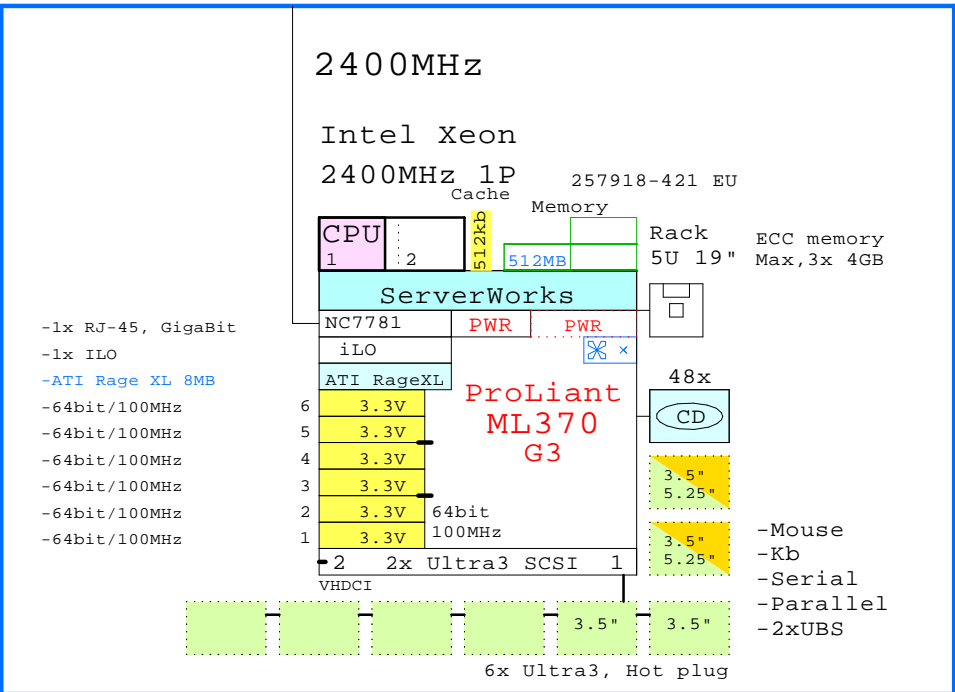

ML370 G3

www.Compaq.com/golden-eggs
Since: Sep-2002

COMPAQ	25-Sep-2002	GEIML370c
	Matti.Patari@HP.com	

ProLiant ML370 G3 sys. 2400MHz
GOLDEN EGGS Visuals, Helsinki

ML370 2P