

HP ProLiant ML-Family

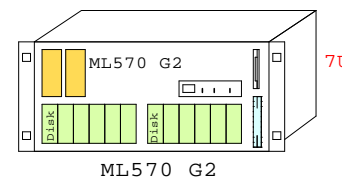
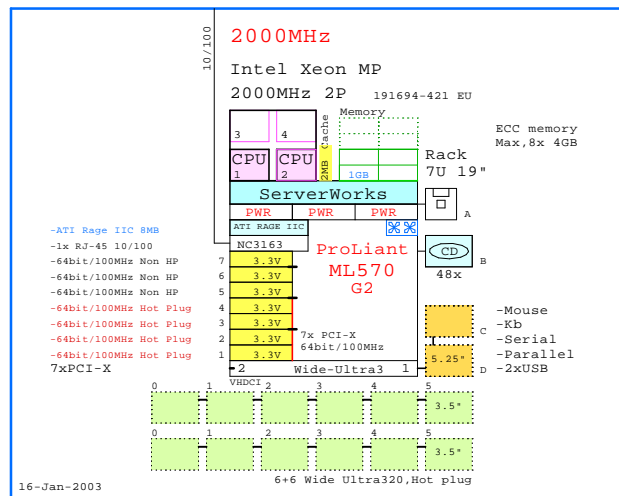
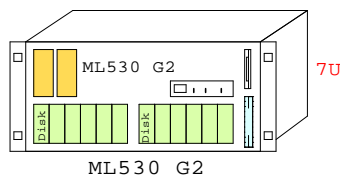
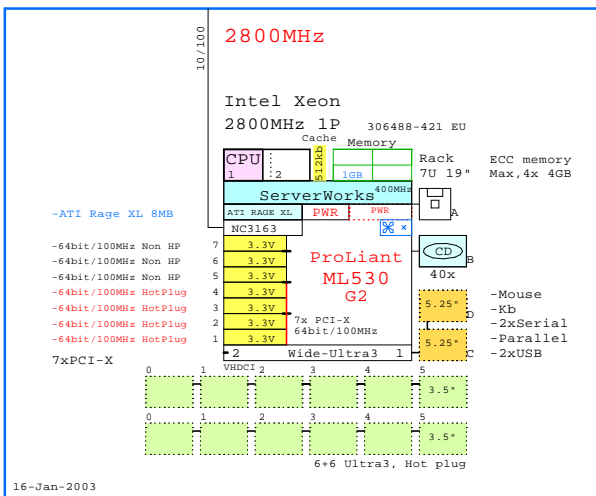
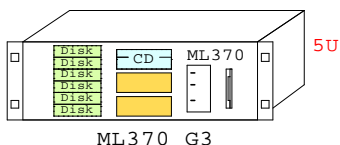
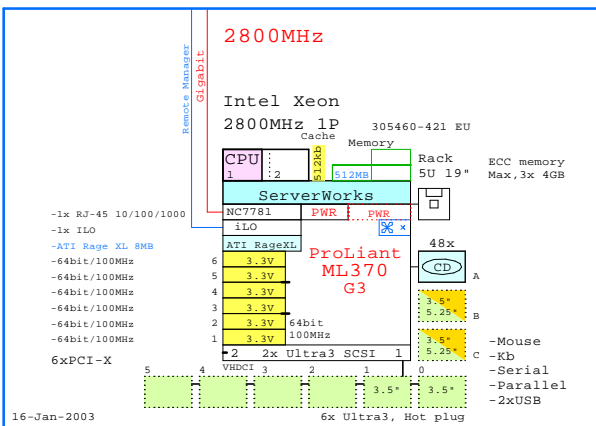
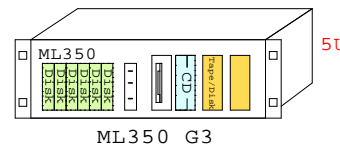
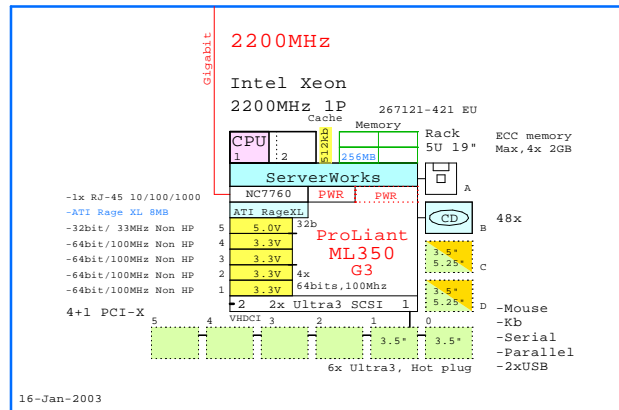
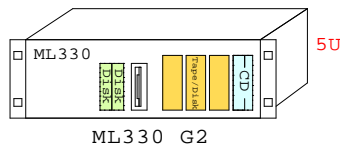
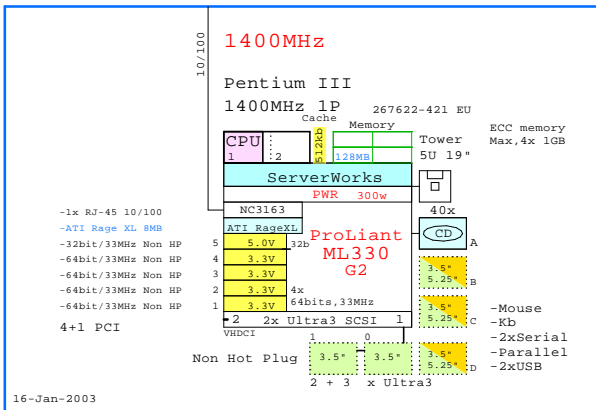
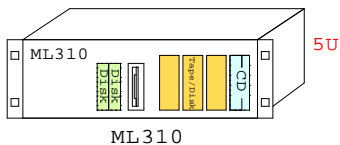
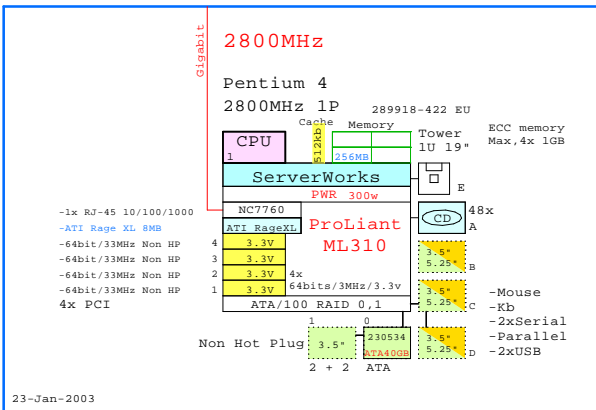

GEI00H

www.Compaq.com/golden-eggs

Since Jan-2002

Internal Options:

- 128MB 287494-B21
- 256MB 287495-B21
- 512MB 287496-B21
- 1GB 287497-B21

ATA disk drives

- 230534 230534-B21
ATA40GB 7.2k
- 278424 278424-B21
ATA80GB 7.2k

Non Hot Plug SCSI

- 142674 142674-B21
18GB 10k
- 176497 176497-B21
36GB 10k

- AIT 50G 157766 157766-B21
SCSI
- AIT100G 249189 249189-B21
SCSI

- 227251-021 227251-021
Lights out mgr RILOE 11

- 244948-B21 244948-B21
NC7770 Gigabit PCI-X

- 129803-B21 129803-B21
2-Ch Ultra3 SCSI 64-Bit/66MHz

- 225338-B21 225338-B21
Smart Array 532

- 283551-B21 283551-B21
Smart Array 5304/256

Remote Manager
Gigabit

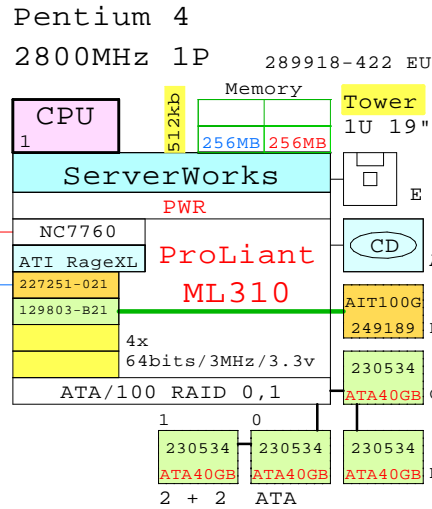

Gigabit

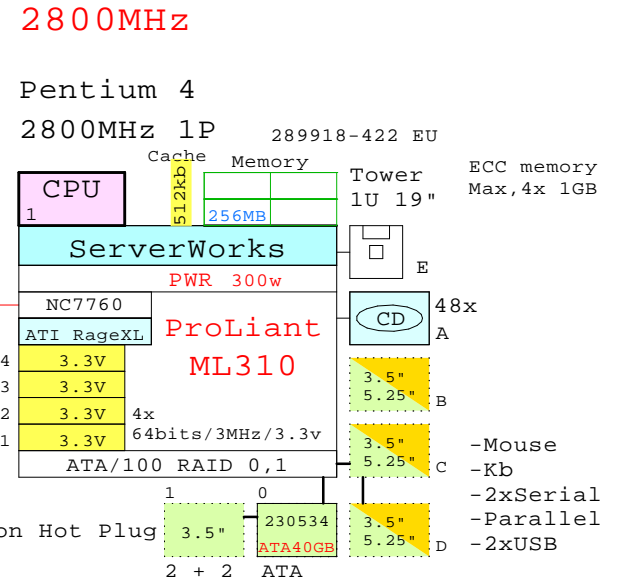

BOM of the 2800MHz-512k 256MB 1P ATA system above

Part Number	Qty	Description
289918-422	1	ML310 2800MHz 256MB ATA 40GB Tower 5U
1.1	1	129803-B21 Dual CH UWD SCSI dapter LVD 2xVHDCI
1.2	1	227251-021 Remote Insight Lights-Out Edition II EU
1.3	3	230534-B21 40-GB ATA/100 7200r disk drive 1"
1.4	1	249189-B21 100GB AIT tape drive, Internal
1.5	1	287495-B21 256MB ECC PC2100 DDR DIMM kit (1x256MB)

Other ML310 ATA and SCSI systems

Part Number	Qty	Description
289917-421	1	ML310 2800MHz 256MB SCSI 36GB Tower 5U
306669-422	1	ML310 2530MHz 256MB ATA 40GB Tower 5U
263659-421	1	ML310 2000MHz 128MB SCSI 18GB Tower 5U
263629-422	1	ML310 2200MHz 128MB ATA 40GB Tower 5U
263658-422	1	ML310 2000MHz 128MB ATA 40GB Tower 5U
306667-421	1	ML310 2530MHz 256MB SCSI 36GB Tower 5U
263660-421	1	ML310 2200MHz 128MB SCSI 18GB Tower 5U

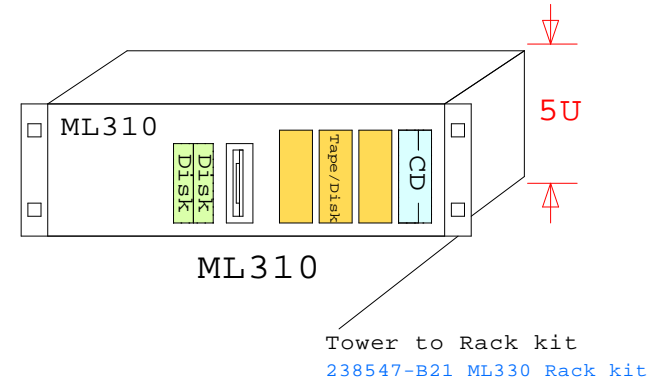

www.Compaq.com/golden-eggs

Since:Jan-2003

	23-Jan-2003	GEIML310a
	Matti.Patari@hp.com	
ProLiant ML310 System 2800MHz GOLDEN EGGS Visuals, Helsinki		

Internal Options:

- CPU** 231118-B21
2nd CPU
1400MHz
- 128MB** 128277-B21
- 256MB** 128278-B21
- 512MB** 128279-B21
- 1GB** 128280-B21

Non Hot Plug SCSI

- 142674** 142674-B21
18GB 10k
- 176497** 176497-B21
36GB 10k

ATA disk drives

- 230534** 230534-B21
ATA40GB 7.2k
- 278424** 278424-B21
ATA80GB 7.2k

- AIT 50G** 157766-B21
157766

- 227251-021** 227251-021
Lights out mgr
RILOE 11

- 158575-B21** 158575-B21
NC7131 Gigabit
64-bit/66MHz

- 129803-B21** 129803-B21
2-Ch Ultra3 SCSI
64-Bit/66MHz

- 225338-B21** 225338-B21
Smart Array 532

- 158939-B21** 158939-B21
Smart Array 5304/128
64-Bit/66MHz

For more detailed configuring, please consult the latest HP QuickSpecs.
Generated with fresh GOLDEN EGGS Software, Rev:14-Jan-2003

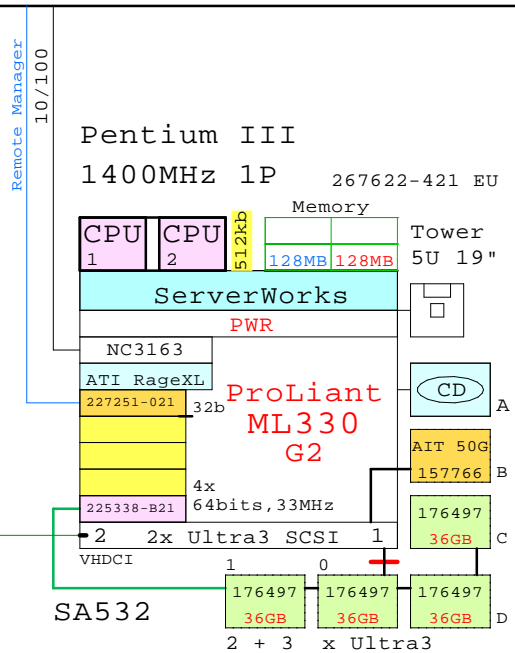

Cable kit for external storage.
159547-B22 Int/Ext SCSI cable kit

BOM of the 1400MHz-512k 128MB 1P SCSI system above

Part Number	Qty	Description
1	267622-421	1 ML330 G2 1400MHz 128MB SCSI Tower5U
1.1	128277-B21	1 128MB 133MHz ECC SDRAM 1x128MB
1.2	157766-B21	1 50GB AIT tape drive, Internal
1.3	176497-B21	4 36.4GB 10k Ultra3 SCSI disk 1" NonHP
1.4	225338-B21	1 Smart Array 532, RAID Ultra3 2-chan
1.5	227251-021	1 Remote Insight Lights-Out Edition II EU
1.6	231118-B21	1 Pentium III P1400-512kb processor kit

ATA System with one 40GB ATA-drive

Part Number	Qty	Description
1	267621-422	1 ML330 G2 1400MHz 128MB ATA40GB Tower5U

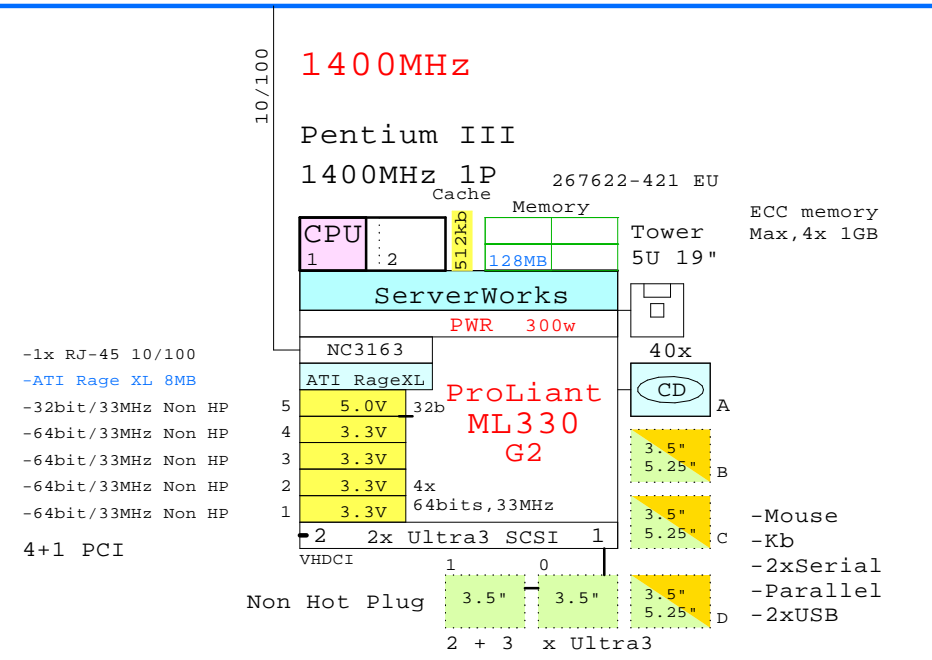

- 1x RJ-45 10/100
- ATI Rage XL 8MB
- 32bit/33MHz Non HP
- 64bit/33MHz Non HP
- 64bit/33MHz Non HP
- 64bit/33MHz Non HP
- 64bit/33MHz Non HP
- 4+1 PCI

- 40x
- Mouse
- Kb
- 2xSerial
- Parallel
- 2xUSB

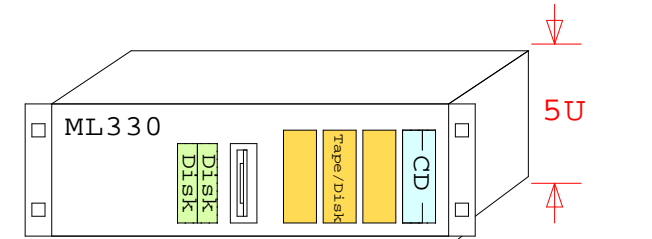

Tower to Rack kit
238547-B21 ML330 Rack kit

www.Compaq.com/golden-eggs

Since:Jan-2003

	16-Jan-2003	GEIML330G2b
	Matti.Patari@hp.com	

ProLiant ML330 G2 System 1400MHz
GOLDEN EGGS Visuals, Helsinki

ML330 2P

Internal Options:

- CPU** 283702-B21
2nd CPU
2200MHz
- 256MB 287495-B21
- 512MB 287496-B21
- 1GB 287497-B21
- 2GB 301044-B21
- 283655-021 2dn power
- 142673 142673-B22
18GB 10k
- 188122 188122-B22
18GB 15k
- 176496 176496-B22
36GB 10k
- 232432 232432-B22
72GB 10k
- AIT 50G 157766-B21
157766
- 227251-021 Lights out mgr
RILOE 11
- 244948-B21 244948-B21
NC7770 Gigabit
PCI-X
- 225338-B21 225338-B21
Smart Array 532
- 283551-B21 283551-B21
Smart Array
5304/256
- 245299-B21 245299-B21
FibreChannel HBA
2Gb/s FCA2101

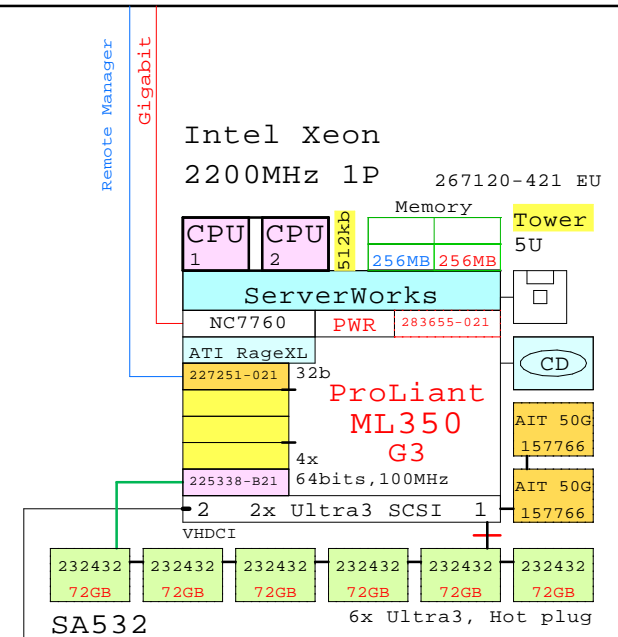

Cable kit for external storage.
159547-B22 Int/Ext SCSI cable kit

BOM of the 2200MHz-512k 256MB 1P tower system above

Part Number	Qty	Description
1	267120-421	1 ProLiant ML350 G3 2200MHz 256MB Tower 5U
1.1	157766-B21	2 50GB AIT tape drive, Internal
1.2	225338-B21	1 Smart Array 532, RAID Ultra3 2-chan
1.3	227251-021	1 Remote Insight Lights-Out Edition II EU
1.4	232432-B22	6 72.8GB 10000r Ultra3 SCSI disk 1"
1.5	283655-021	1 ML350 G3 second power supply, EU
1.6	283702-B21	1 Intel Xeon 2200-512kb processor kit
1.7	287495-B21	1 256MB ECC PC2100 DDR DIMM kit (1x256MB)

Part numbers for 2.000MHz options

Part Number	Qty	Description
1	267123-421	1 ProLiant ML350 G3 2000MHz 256MB Rack 5U
1.1	283701-B21	1 Intel Xeon 2000-512kb processor kit

For more detailed configuring, please consult the latest HP QuickSpecs.
Generated with fresh GOLDEN EGGS Software, Rev:10-Jan-2003

ML350 2P

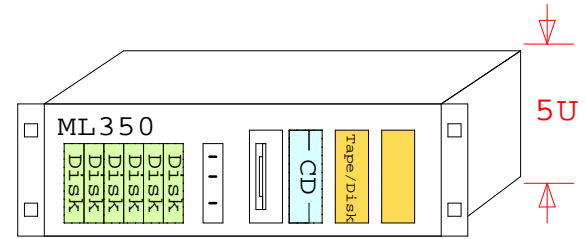
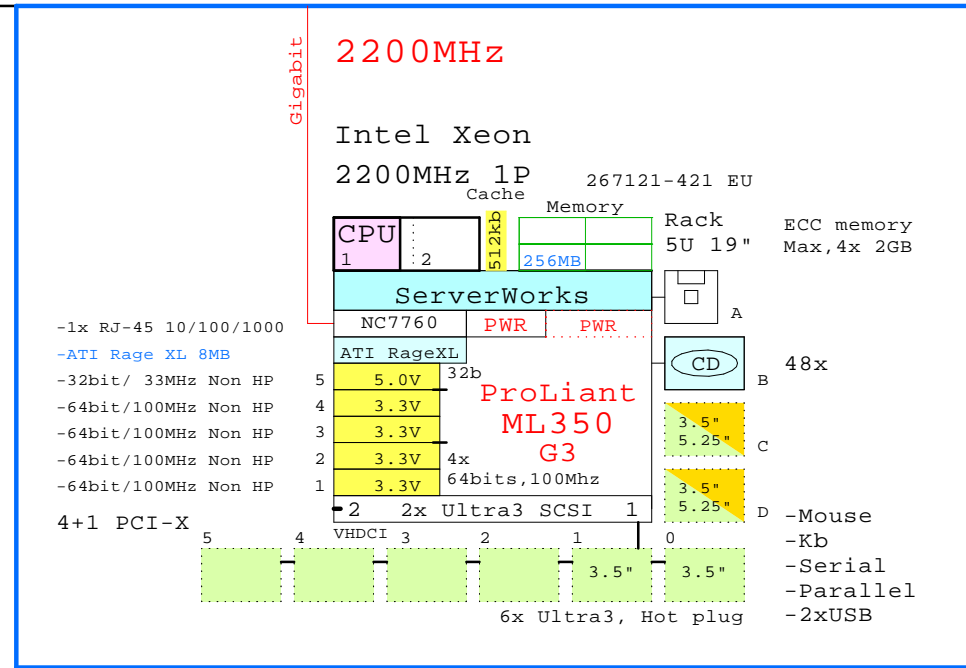

















www.Compaq.com/golden-eggs

Since: Sep-2002

	16-Jan-2003	GEIML350G3c
	Matti.Patari@hp.com	

ProLiant ML350 G3 System 2200MHz
GOLDEN EGGS Visuals, Helsinki

Internal Options:

-  257915-B21
2nd CPU
2800MHz
-  300678-B21
-  300679-B21
-  300680-B21
-  300682-B21
-  225075-021
2dn power supply
-  225073-B21
Fan kit
-  286775-B22
18GB
15k U320
-  286776-B22
36GB
15k U320
-  286778-B22
72GB
15k U320
-  286716-B22
146GB
10k U320
-  157766-B21
157766
-  244948-B21
NC7770 Gigabit
PCI-X
-  138603-B21
NC3134 FastE.
Dual Channel
-  283552-B21
Smart Array
5302/128
-  283551-B21
Smart Array
5304/256
-  245299-B21
FibreChannel HBA
2Gb/s FCA2101

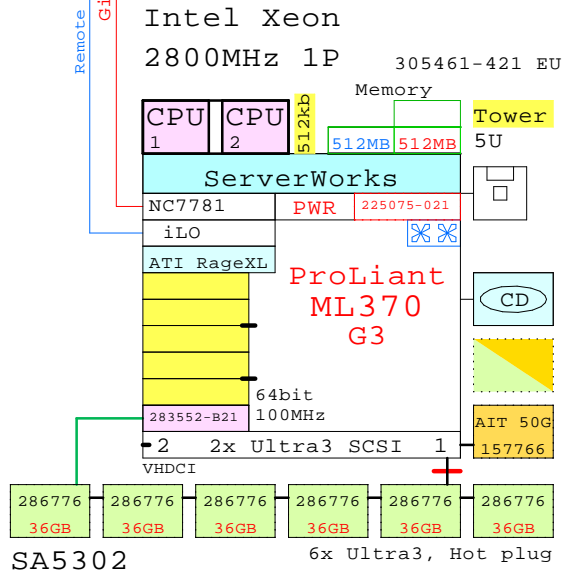

BOM of the 2800MHz-512k 512MB 1P tower system above

Part Number	Qty	Description
1	305461-421	1 ProLiant ML370 G3 2800MHz 512MB Tower 5U
1.1	157766-B21	1 50GB AIT tape drive, Internal
1.2	225073-B21	1 ML370 Hot plug blower kit, 2x fans
1.3	225075-021	1 ML370 G2 second power supply
1.4	257915-B21	1 Intel Xeon 2800-512kb processor kit
1.5	283552-B21	1 Smart Array 5302/128MB,Ultra3 2-chan
1.6	286776-B22	6 36GB 15000r U320 disk 1"
1.7	300678-B21	1 512MB ECC PC2100 DDR DIMM kit (2x256MB)

Part numbers for 2400MHz options

Part Number	Qty	Description
1	257919-421	1 ProLiant ML370 G3 2400MHz 512MB Tower 5U
1.1	257913-B21	1 Intel Xeon 2400-512kb processor kit

For more detailed configuring, please consult the latest HP QuickSpecs.
Generated with fresh GOLDEN EGGS Software, Rev:14-Jan-2003

ML370 2P

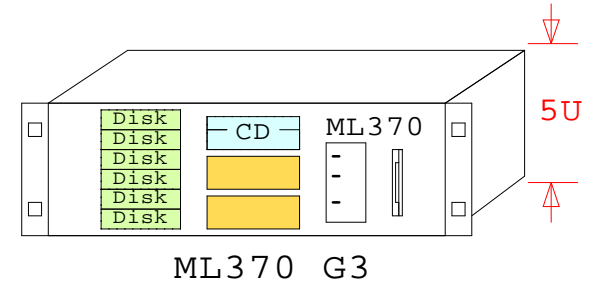
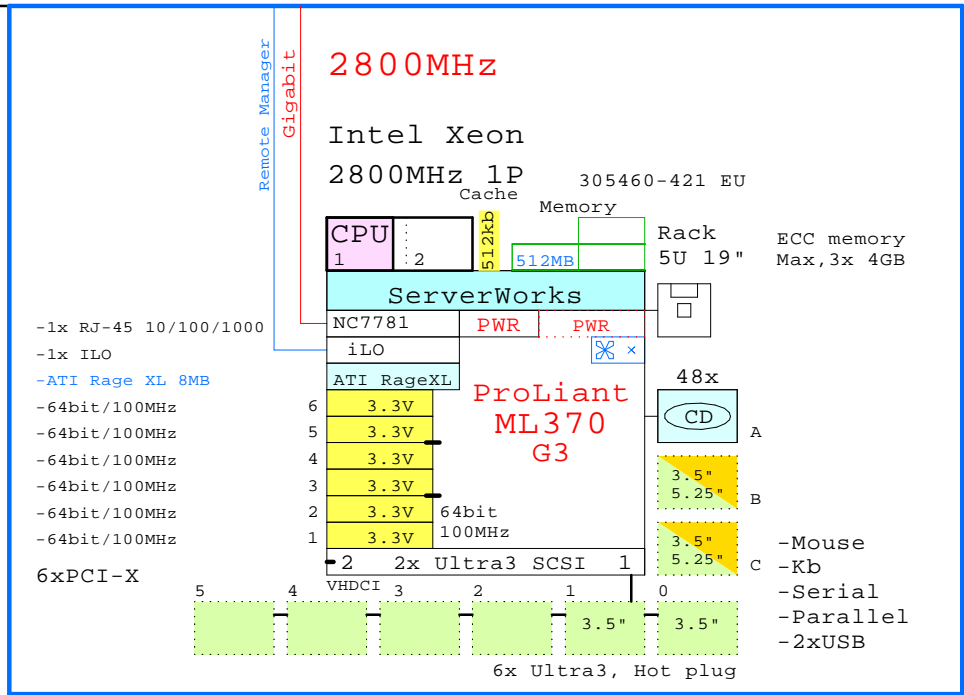

www.Compaq.com/golden-eggs

Since: Sep-2002

	16-Jan-2003	GEIML370G3a
	Matti.Patari@hp.com	
ProLiant ML370 G3 System 2800MHz GOLDEN EGGS Visuals, Helsinki		

Internal Options:

- CPU** 306504-B21
2nd CPU
2800MHz
- 187419-B21
1GB
- 187420-B21
2GB
- 187421-B21
4GB
- 128284-B21
2nd fan kit for 1p systems
- 236845-021
2nd power supply for 1P systems
- 286775 286775-B22
18GB 15k U320
- 286776 286776-B22
36GB 15k U320
- 286778 286778-B22
72GB 15k U320
- 286716 286716-B22
146GB 10k U320
- AIT 50G 157766-B21
157766
- 227251-021
Lights out mgr RILOE 11
- 244948-B21
NC7770 Gigabit PCI-X
- 138603-B21
138603-B21
NC3134 Ethernet, Dual 64-bit/66MHz
- 283552-B21
283552-B21
Smart Array 5302/128
- 283551-B21
283551-B21
Smart Array 5304/256
- 245299-B21
245299-B21
FibreChannel HBA 2Gb/s FCA2101

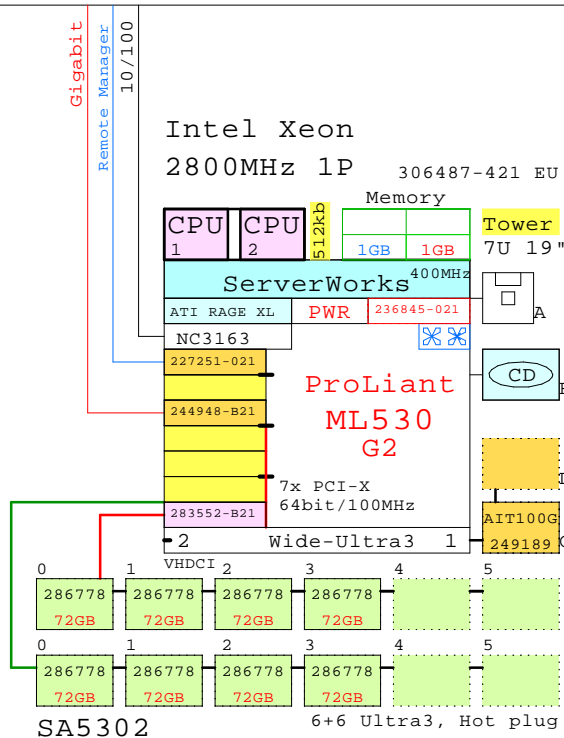

BOM of the 2800MHz-512k 1GB 1P tower system above

Part Number	Qty	Description
1	306487-421	1 ProLiant ML530 G2 1P 2800MHz 1GB Tower 7
1.1	128284-B21	1 ML530 G2 Hot plug blower kit
1.2	187419-B21	1 1GB PCI1600 ECC SDRAM (2x512MB)memory
1.3	227251-021	1 Remote Insight Lights-Out Edition II EU
1.4	236845-021	1 ML530 G2 second power supply
1.5	244948-B21	1 Compaq NC7770 PCI-X Gigabit Server Adapt
1.6	249189-B21	1 100GB AIT tape drive, Internal
1.7	283552-B21	1 Smart Array 5302/128MB,Ultra3 2-chan
1.8	286778-B22	8 72.8GB 15000r U320 disk 1"
1.9	306504-B21	1 Intel Xeon 2800 512KB processor kit

Part numbers for 2800MHz 2P systems

Part Number	Qty	Description
1	306489-421	1 ProLiant ML530 G2 2P 2800MHz 1GB Tower 7
2	306490-421	1 ProLiant ML530 G2 2P 2800MHz 1GB Rack 7U

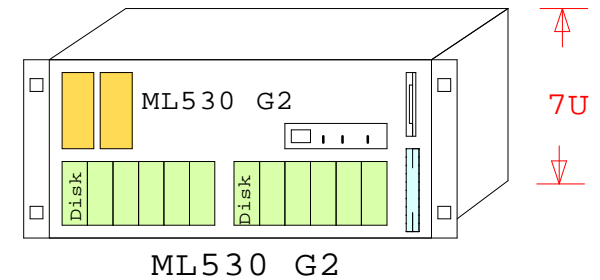
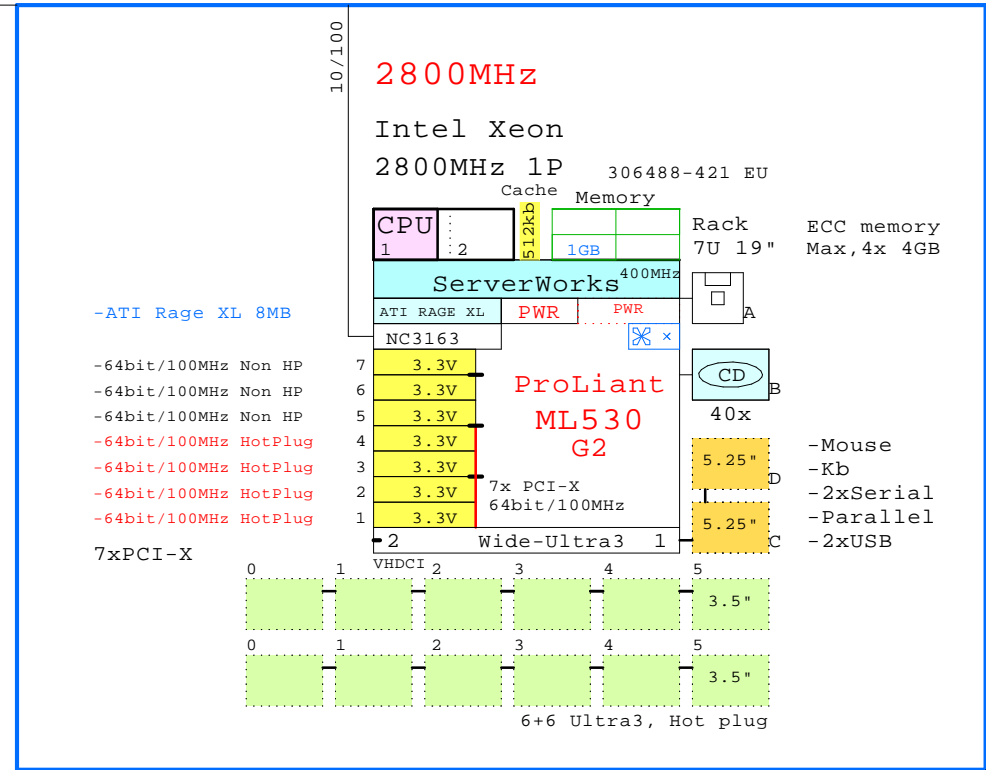



















www.Compaq.com/golden-eggs

Since: May-2002

	16-Jan-2003	GEIML530G2a
	Matti.Patari@hp.com	

ProLiant ML530 G2 system 2800MHz
GOLDEN EGGS Visuals, Helsinki

Internal Options:

-  307276-B21
CPU
2000MHz
-  187418-B21
-  187419-B21
-  187420-B21
-  187421-B21
- Expanded**  236844-B21
Memory expansion for four kits
-  128284-B21
2nd fan kit for 1P systems
-  236845-021
3rd power supply for 1P systems
-  286775-18GB 286775-B22
15k U320
-  286776-36GB 286776-B22
15k U320
-  286778-72GB 286778-B22
15k U320
-  286716-146GB 286716-B22
10k U320
-  157766-50G 157766-B21
157766
-  227251-021
Lights out mgr RLOE 11
-  244948-B21
NC7770 Gigabit PCI-X
-  138603-B21
NC3134 Ethernet, Dual 64-bit/66MHz
-  283552-B21
Smart Array 5302/128
-  283551-B21
Smart Array 5304/256
-  245299-B21
FibreChannel HBA 2Gb/s FCA2101

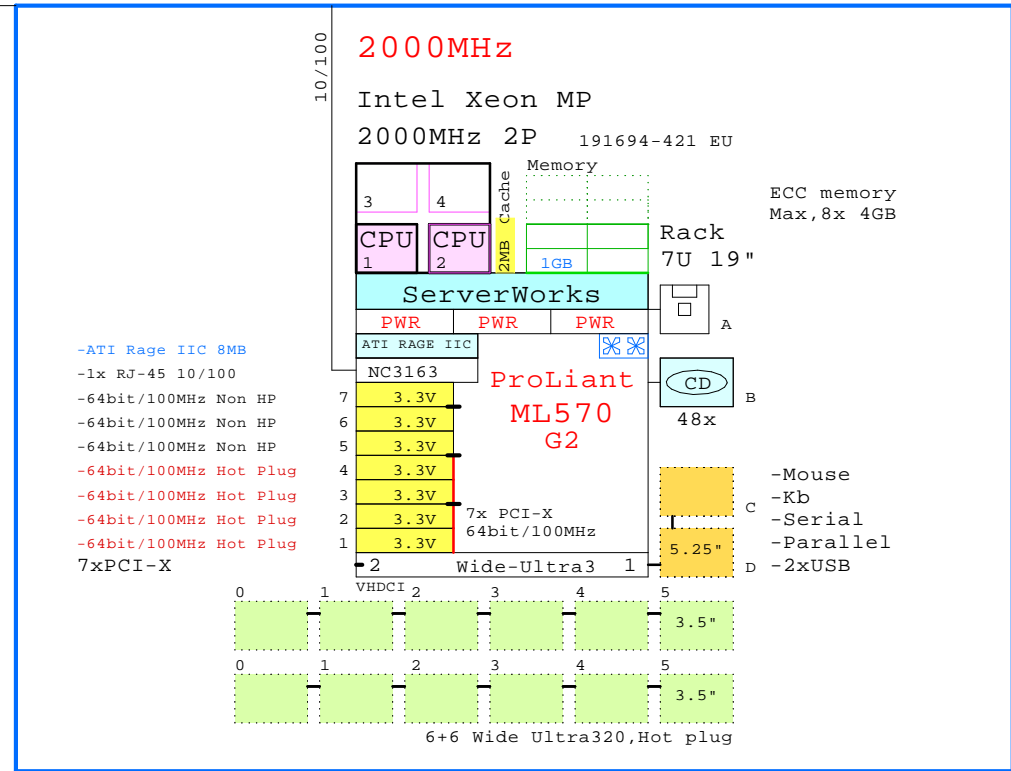
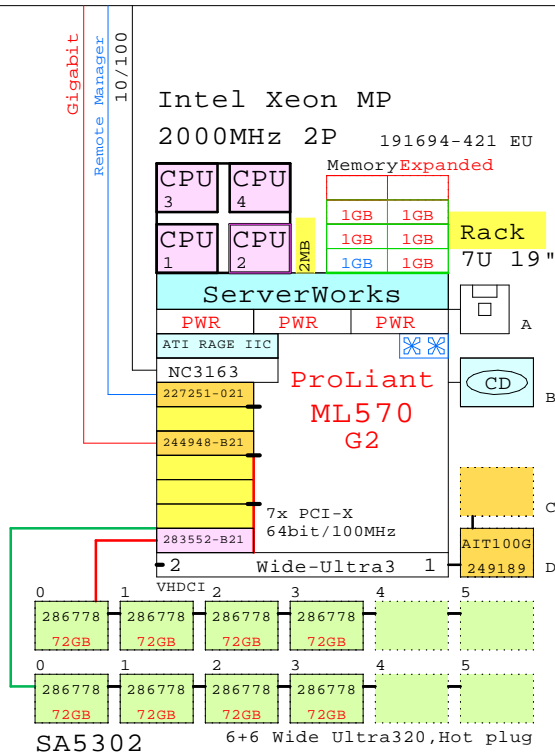

BOM of the 2000MHz-2MB 1GB 2P rack system above

Part Number	Qty	Description
1	191694-421	1 ProLiant ML570 G2 2P 2000MHz 2MB 1GB rac
1.1	187419-B21	3 1GB PCI1600 ECC SDRAM (2x512MB)memory
1.2	227251-021	1 Remote Insight Lights-Out Edition II EU
1.3	236844-B21	1 ML570 Hot Plug Memory Expansion Board
1.3.1	187419-B21	2 1GB PCI1600 ECC SDRAM (2x512MB)memory
1.4	244948-B21	1 Compaq NC7770 PCI-X Gigabit Server Adapt
1.5	249189-B21	1 100GB AIT tape drive, Internal
1.6	283552-B21	1 Smart Array 5302/128MB,Ultra3 2-chan
1.7	286778-B22	8 72.8GB 15000r U320 disk 1"
1.8	307276-B21	2 Intel Xeon MP 2000-2MB processor kit

Other Rack and Tower systems and CPU options

Part Number	Qty	Description
1	307164-421	1 ProLiant ML570 G2 2P 1500MHz 1MB 1GB rac
2	311056-421	1 ProLiant ML570 G2 2P 1900MHz 1MB 1GB rac
3	307163-421	1 ProLiant ML570 G2 1P 1500MHz 1MB 512MB t
4	311055-421	1 ProLiant ML570 G2 1P 1900MHz 1MB 512MB t
5	180320-421	1 ProLiant ML570 G2 1P 1400MHz 512k 512MB
6	180322-421	1 ProLiant ML570 G2 1P 2000MHz 2MB 512MB t
7	191693-421	1 ProLiant ML570 G2 2P 1400MHz 512k 1GB ra
8	191220-B21	1 Intel Xeon MP 1500-1MB processor kit
9	307276-B21	1 Intel Xeon MP 2000-2MB processor kit
10	311228-B21	1 Intel Xeon MP 1900-1MB processor kit
11	226775-B21	1 Intel Xeon MP 1400-512KB processor kit

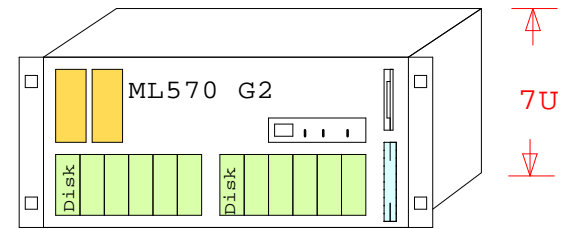

ML570 G2

For more detailed configuring, please consult the latest HP QuickSpecs.
Generated with fresh GOLDEN EGGS Software, Rev:16-Jan-2003

ML570 4P

www.Compaq.com/golden-eggs
Since:Dec-2001

	16-Jan-2003	GEIML570G2a
	Matti.Patari@hp.com	

ProLiant ML570 G2 system 2000MHz
GOLDEN EGGS Visuals, Helsinki

Compaq ProLiant ML570 2P/1P

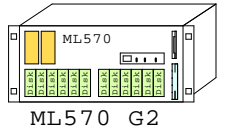
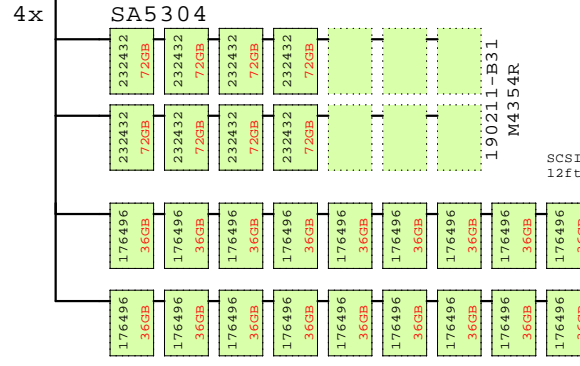
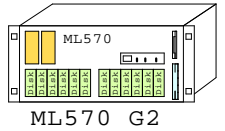
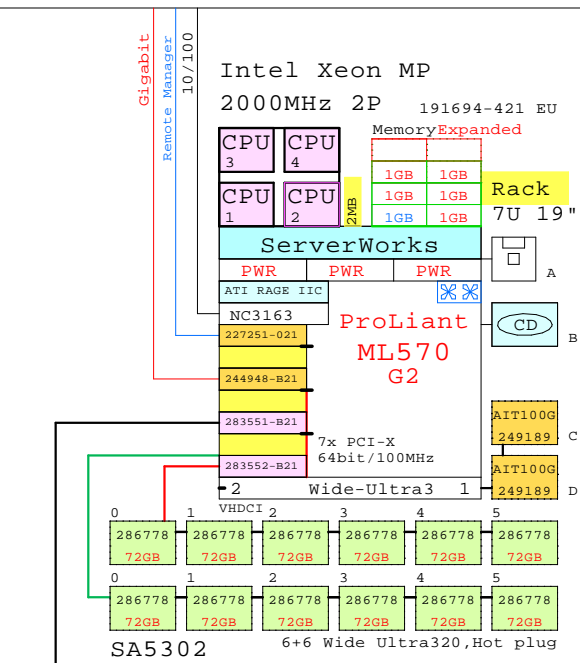

Bill of material

Part Number	Qty	Description
1	1	191694-421 1 ProLiant ML570 G2 2P 2000MHz 2MB 1GB rac
1.1	3	187419-B21 1GB PCI1600 ECC SDRAM (2x512MB)memory
1.2	1	227251-021 1 Remote Insight Lights-Out Edition II EU
1.3	1	236844-B21 1 ML570 Hot Plug Memory Expansion Board
1.3.1	2	187419-B21 1GB PCI1600 ECC SDRAM (2x512MB)memory
1.4	1	244948-B21 1 Compaq NC7770 PCI-X Gigabit Server Adapt
1.5	2	249189-B21 100GB AIT tape drive, Internal
1.6	1	283551-B21 1 Smart Array 5304/256MB,Ultra3 4-chan
1.7	1	283552-B21 1 Smart Array 5302/128MB,Ultra3 2-chan
1.8	12	286778-B22 72.8GB 15000r U320 disk 1"
1.9	2	307276-B21 Intel Xeon MP 2000-2MB processor kit
2	1	190209-B31 1 Modula M4314R single buss,14x 1.0"
2.1	10	176496-B22 36GB 10000r Ultra3 SCSI disk 1"
3	1	190209-B31 1 Modula M4314R single buss,14x 1.0"
3.1	14	176496-B22 36GB 10000r Ultra3 SCSI disk 1"
4	1	190211-B31 1 Modula M4354R dual buss, 7+7, 1.0"
4.1	8	232432-B22 72.8GB 10000r Ultra3 SCSI disk 1"
5	2	119826-B21 2 Modula M42/314R 2nd power supply

Generated with fresh GOLDEN EGGS Software, Rev:17-Jan-2003

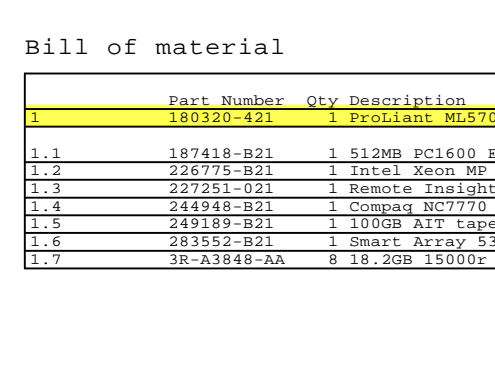
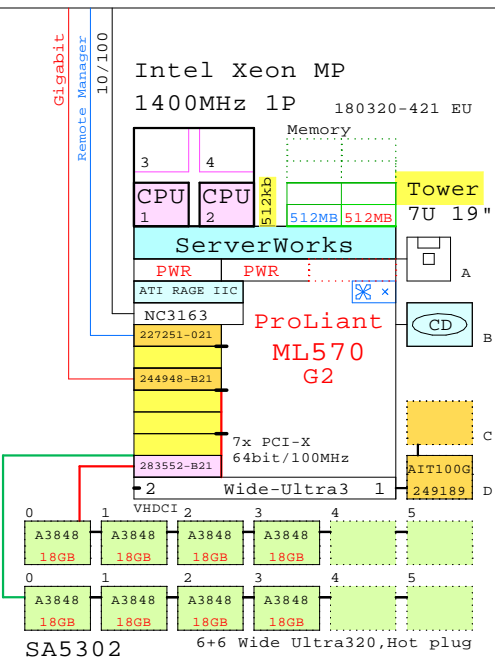

Bill of material

Part Number	Qty	Description
1	1	180320-421 1 ProLiant ML570 G2 1P 1400MHz 512k 512MB
1.1	1	187418-B21 512MB PCI1600 ECC SDRAM (2x256MB)memory
1.2	1	226775-B21 1 Intel Xeon MP 1400-512KB processor kit
1.3	1	227251-021 1 Remote Insight Lights-Out Edition II EU
1.4	1	244948-B21 1 Compaq NC7770 PCI-X Gigabit Server Adapt
1.5	1	249189-B21 1 100GB AIT tape drive, Internal
1.6	1	283552-B21 1 Smart Array 5302/128MB,Ultra3 2-chan
1.7	8	3R-A3848-AA 18.2GB 15000r U320 SCSI disk 1"

www.Compaq.com/golden-eggs

Since:Dec-2001

	17-Jan-2003	GTIML570G2a
	Matti.Patari@hp.com	

ML570 4P

ProLiant ML570 G2 entry systems
GOLDEN EGGS Visuals, Helsinki